

# Operating Instructions

## REFRIGERATOR/FREEZER COMBINATION

GB

GB

English

FF187E

FF200E

### Contents

#### Installation, 2-3

Positioning and connection  
Reversible doors

#### Description of the appliance, 4-5

Control panel  
Overall view

#### Start-up and use, 6-7

Starting the appliance  
No Frost cooling system  
Using the refrigerator to its full potential  
Using the freezer to its full potential

#### Maintenance and care, 8

Switching the appliance off  
Cleaning the appliance  
Avoiding mould and unpleasant odours  
Holiday Function  
Replacing the light bulb

#### Precautions and tips, 9

General safety  
Disposal  
Respecting and conserving the environment

#### Troubleshooting, 10

#### Guarantee, 11

#### After Sales Service, 12

 **Hotpoint**

# Installation

GB

! Before operating your new appliance, please read these operating instructions carefully. They contain important information for safe use, installation and care of the appliance.

! Please keep these operating instructions for future reference. Pass them on to possible new owners of the appliance.

## Positioning and connection

### Positioning

1. Place the appliance in a well-ventilated humidity-free room.
2. Do not obstruct the airflow under and behind the appliance. The compressor and condenser give off heat and require good ventilation to operate correctly and save energy.
3. Ensure the appliance is far away from any sources of heat (direct sunlight, electric stove, etc.).

### Electrical connections

After transportation of the appliance, carefully place it vertically and wait at least 3 hours before connecting it to the electricity mains. Before inserting the plug into the electrical socket ensure the following:

- The appliance is earthed and the plug is compliant with the law.
- The socket can withstand the maximum power of the appliance, which is indicated on the data plate located on the bottom left side of the fridge (e.g. 150 W).
- The voltage must be in the range between the values indicated on the data plate located on the bottom left side (e.g. 220-240V, 50Hz).
- The socket is compatible with the plug of the appliance.

If the socket is incompatible with the plug, ask an authorised technician to replace it (*see After Sales Service*). Do not use extension cords or multiple sockets.

! Once the appliance has been installed, the power supply cable and the electrical socket must be easily accessible.

! The cable must not be bent or compressed.

! The cable must be checked regularly and replaced by authorised technicians only (*see After Sales Service*).

**! The manufacturer declines any liability should these safety measures not be observed.**

Your appliance is supplied with a 13amp fused plug that can be plugged into a 13amp socket for immediate use. Before using the appliance please read the instructions below.

**WARNING:**  
**THIS APPLIANCE MUST BE EARTHED.**

### Replacing fuse covers:

When replacing a faulty fuse, a 13amp ASTA approved fuse to BS 1362 should always be used and the fuse cover re-fitted.

If the fuse cover is lost, the plug must not be used until a replacement is obtained.

### Replacement fuse covers:

If a replacement fuse cover is fitted, it must be of the correct colour as indicated by the coloured marking or the colour that is embossed in words on the base of the plug.

### Changing the plug:

#### Removing the plug

If your appliance has a non-rewireable moulded plug and you should wish to remove it to add a longer cable or to re-route the mains cable through partitions, units etc. please ensure that either:

- The plug is replaced by a fused 13amp re-wireable plug bearing the BSI mark of approval.

or

- The mains cable is wired directly into a 13amp cable outlet, controlled by a switch (in compliance with BS 5733) which is accessible without moving the appliance.

#### Disposing of the plug

Cut off and dispose of the supplied plug if it does not fit your socket. The cable should be cut as close as possible to the moulded plug.

Remove the fuse.

WARNING:

**To avoid a shock hazard do not insert the discarded plug into a socket anywhere else.**

### Fitting a new plug

**IMPORTANT:**

WIRES IN THE MAINS LEAD ARE COLOURED IN ACCORDANCE WITH THE FOLLOWING CODE...

- Green and Yellow - Earth
- Blue - Neutral
- Brown - Live

As the colours of the wires in the mains lead may not correspond with the coloured markings identifying the terminals in your plug, proceed as follows:

- Connect Green and Yellow wire to terminal marked 'E' or or coloured Green and Yellow.
- Connect Brown wire to terminal marked 'L' or coloured red or brown.
- Connect Blue wire to terminal marked 'N' or coloured Black or Blue.

If a 13amp plug (BS 1363) is used it must be fitted with a 13amp fuse. A 15amp plug must be protected by a 15amp fuse, either in the plug or adaptor or at the distribution board.

**If you are in any doubt about the electrical supply to your machine, consult a qualified electrician before use.**

**CE Marking certifies that this appliance conforms to the following EEC directives :**  
**Low Voltage Equipment - 73/23/EEC & 93/68 EEC**  
**Electromagnetic Compatibility 89/336/EEC, 92/31/EEC & 93/68/EEC**

### Reversible doors

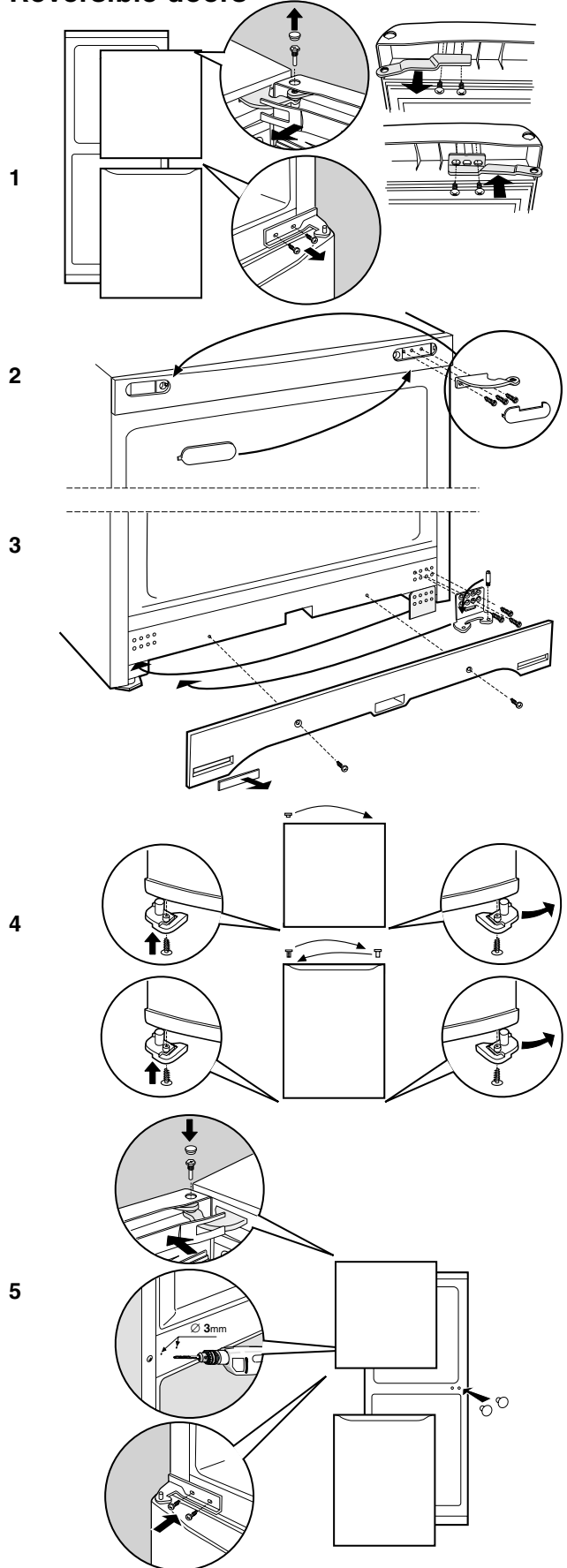

# Description of the appliance

GB

## Control panel

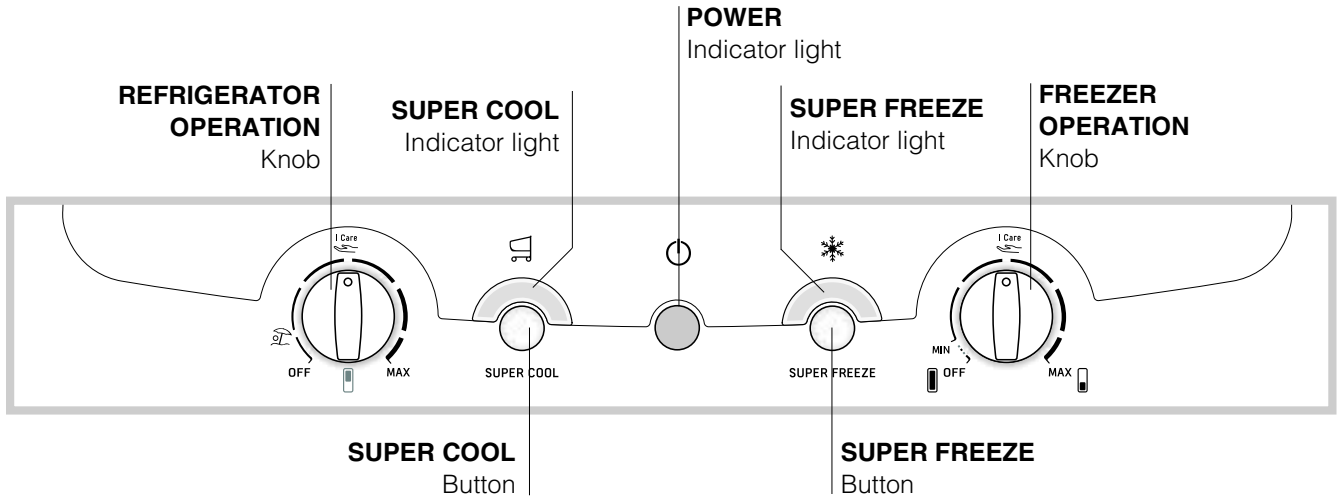

- **REFRIGERATOR OPERATION Knob** to regulate the temperature of the refrigerator compartment.  
**I Care** is the optimal temperature for energy saving levels.  
 is the holiday function (see *Maintenance and care*).  
**OFF** switches the refrigerator off.
- **SUPER COOL** (quick cool) to lower the temperature of the refrigerator compartment rapidly. When it is pressed, the **SUPER COOL** indicator light illuminates (see *Start-up and use*).
- **SUPER COOL** Yellow indicator light (rapid cooling) illuminates when the **SUPER COOL** button is pressed.
- **POWER** Indicator light illuminates when the appliance is connected to the electricity network.

- **SUPER FREEZE** button (rapid freezing) to freeze fresh food. When it is pressed, the **SUPER FREEZE** indicator light illuminates (see *Start-up and use*).
- **SUPER FREEZE** Yellow indicator light (rapid freezing) illuminates when the **SUPER FREEZE** button is pressed.
- **FREEZER OPERATION Knob** to regulate the temperature of the freezer compartment.  
**I Care** is the optimal temperature for energy saving levels.  
**OFF** switches the appliance off, including the refrigerator.

! The indicator lights are also used to indicate an unusual temperature increase in the freezer compartment (see *Troubleshooting*).

## Overall view

The instructions contained in this manual are applicable to different model refrigerators. The diagrams may not directly represent the appliance purchased. For more complex features, consult the following pages.

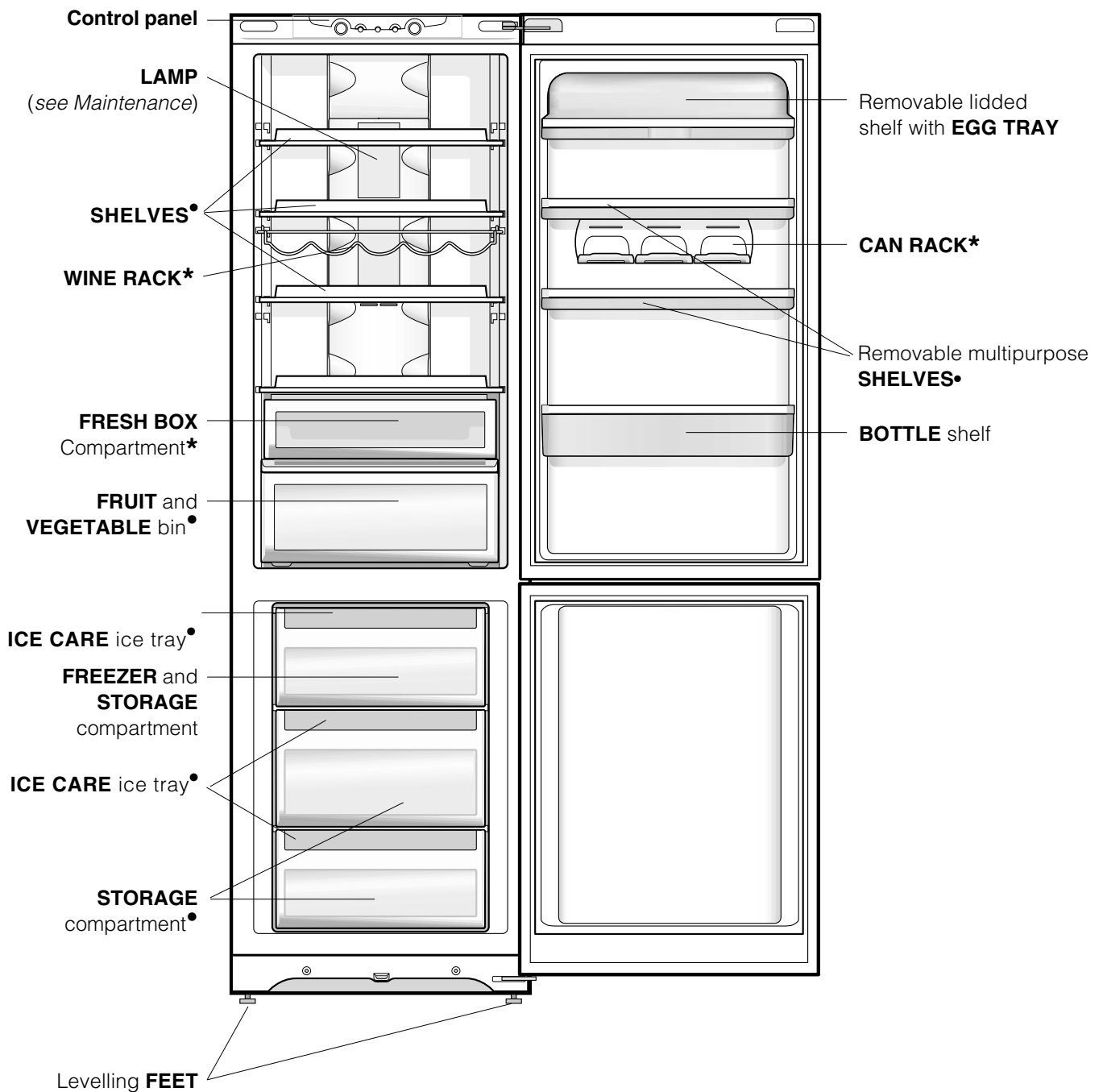

• Varies by number and/or position.

\* Available only on certain models.

# Start-up and use

GB

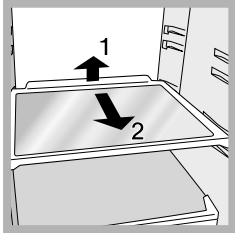

**SHELVES:** with or without grill. Due to the special guides the shelves are removable and the height is adjustable (see *diagram*), allowing easy storage of large containers and food. Height can be adjusted without complete removal of the shelf.

**FRESH BOX\*:** for fresh meat and fish. Due to the compartment's low temperature (the coldest in the refrigerator) food can be stored for up to one week. It can also be used to store chilled ready meals (always read the instructions on the food packaging).

**WINE RACK:** Use to store bottles of wine. The air circulates freely between the bottles guaranteeing rapid cooling.

## Starting the appliance

**! Before starting the appliance, follow the installation instructions (see *Installation*).**

**! Before connecting the appliance, clean the compartments and accessories well with lukewarm water and bicarbonate.**

**!! The appliance is fitted with an electronic motor control system. The compressor motor will start approximately 8 minutes after the appliance is first switched on, or after any power interruptions. (e.g. power failures)**

1. Set the FREEZER OPERATION knob on **OFF**.
2. Insert the plug into the socket and ensure that the green POWER indicator light illuminates.
3. Turn the REFRIGERATOR OPERATION knob to a mid position. After a few hours you will be able to put food in the refrigerator.
4. Turn the FREEZER OPERATION knob to a mid position and press the SUPER FREEZE button (rapid freezing): the SUPER FREEZE indicator light will illuminate. Once the refrigerator has reached the optimal temperature, the indicator light goes out and you can begin food storage.

## No Frost cooling system

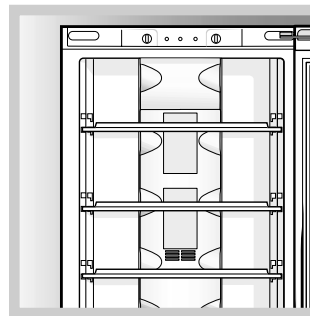

This is recognisable by air ducts located on the back walls of each compartment. The No Frost system circulates cold air continuously to collect humidity and prevent ice and frost formation. The system maintains an optimal humidity level in the compartment,

preserving the original quality of the food, preventing the food from sticking together and making defrosting a thing of the past. Do not block the air circulation by placing food or containers in direct contact with the rear ducts.

## Using the refrigerator to its full potential

- The general refrigerator temperature should be 5°C or colder although some sections, such as fruit and vegetable bin, will be warmer. The mid position (i-care) is usually suitable but the exact position will depend on the appliance location, food loading and number of door openings. If necessary, use the REFRIGERATOR OPERATION knob.
- Use the REFRIGERATOR OPERATION knob to adjust the temperature (see *Description*).
- Press the SUPER COOL button (rapid cooling) to lower the temperature quickly. For example, when you place a large number of new food items inside a fridge the internal temperature will rise slightly. The function quickly cools the groceries by temporarily reducing the temperature until it reaches the ideal level.
- Place only cold or lukewarm foods in the compartment, not hot foods (see *Precautions and tips*).
- Remember that cooked foods do not last longer than raw foods.
- Do not store liquids in open containers. They will increase humidity in the refrigerator and cause condensation to form.

## Using the freezer to its full potential

- The freezer internal temperature should be -18°C or colder. The mid position (i-care) is usually suitable but the exact position will depend on appliance location, food loading and number of door openings. If necessary, use the FREEZER OPERATION knob (see *Description*) to adjust the temperature.
- Do not re-freeze food that is defrosting or that has already been defrosted. These foods must be cooked and eaten (within 24 hours).
- Fresh food that needs to be frozen must not come into contact with food that has already been frozen. Fresh food must be stored in the top FREEZER and STORAGE compartment where the temperature drops below -18°C and guarantees rapid freezing.  
**!** to avoid blocking the air circulation inside the freezer compartment, it is advisable not to obstruct the ventilation holes with food or containers.
- Do not place glass bottles which contain liquids, and which are corked or hermetically sealed in the freezer because they could break.
- The maximum quantity of food that may be frozen daily is indicated on the data plate located inside one of the compartments. For example kg/24h: 4
- To freeze (if the freezer is already operating): press the rapid freezing SUPER FREEZE button (corresponding yellow indicator light illuminates), insert the food and close the door. The function is disabled

automatically after 24 hours or when optimal temperatures have been reached (indicator light goes out);

**!** Do not open the door during freezing.

**!** If there is a power cut or malfunction, do not open the freezer door. This will help maintain the temperature inside the freezer, ensuring that foods are conserved for at least 9-14 hours.

### ICE CARE tray

The fact that they are situated on the top part of the freezer drawers ensures greater cleanliness: the ice no longer comes into contact with the food placed inside the freezer compartment; furthermore, the dripping of the water during filling is avoided (a lid to cover up the hole after filling with water is also provided).

1. Pull out the tray by pushing it up.  
Check that the tray is completely empty and fill it with water through the opening provided.
2. Take care not to exceed the level indicated (MAX WATER LEVEL). Excess water prevents the ice cubes from dispensing (if this happens, wait for the ice to melt and empty the tray).
3. Turn the tray 90°: due to the connected compartments each mould fills with water (see *diagram*).
4. Close the opening with the lid provided and put the tray back, placing the top part in the corresponding housing and allowing it to drop in again.
5. When the ice has formed (minimum time approximately 8 hours) knock the tray against a hard surface and warm (with water) the outside so that the ice cubes come loose. Take them out through the opening.

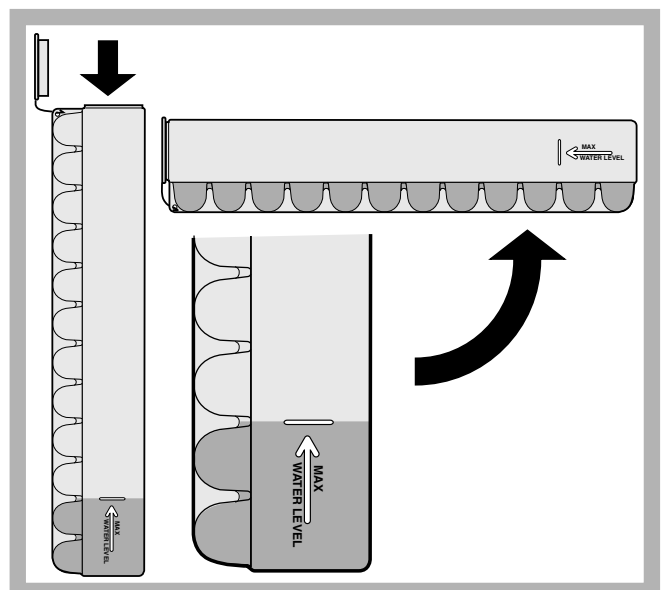

# Maintenance and care

GB

## Switching the appliance off

During cleaning and maintenance it is necessary to disconnect the appliance from the electricity supply:

1. set the FREEZER OPERATION knob on  OFF
2. pull the plug out of the socket

! If this procedure is not followed, the alarm may sound. This alarm does not indicate a malfunction. To restore normal operation, it is sufficient to set the FREEZER OPERATION knob on the desired value. To disconnect the appliance, follow point 1 and 2.

## Cleaning the appliance

- The external and internal parts, as well as the rubber seals may be cleaned using a sponge that has been soaked in lukewarm water and bicarbonate of soda or neutral soap. Do not use solvents, abrasive products, bleach or ammonia.
- The removable accessories may be soaked in warm water and soap or dishwashing liquid. Rinse and dry them carefully.
- The back of the appliance may collect dust which can be removed by delicately using the hose of a vacuum cleaner set on medium power. The appliance must be switched off and the plug must be pulled out before cleaning the appliance.

## Avoiding mould and unpleasant odours

- The appliance is manufactured with hygienic materials which are odour free. In order to maintain an odour free refrigerator and to prevent the formation of stains, food must always be covered or sealed properly.
- If you want to switch the appliance off for an extended period of time, clean the inside and leave the doors open.

## Holiday function

To minimise energy usage when on holiday, it is not necessary to switch the appliance off. The appliance has a function which allows it to maintain the temperature of the refrigerator compartment at approximately 15°C (which can also be used to conserve make-up and beauty products). The freezer temperature must be set to the minimum value in order to preserve the food.

To enable the function: set the REFRIGERATOR OPERATION knob on .

A double acoustic signal informs you when it has been enabled. A single acoustic signal informs you when it has been disabled.

## Replacing the light bulb

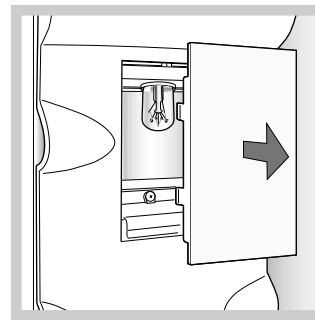

To replace the light bulb in the refrigerator compartment, pull out the plug from the electrical socket. Follow the instructions below. Access the light bulb by removing the cover as indicated in the diagram. Replace it with a similar light bulb within the

power range indicated on the cover (10 W).

! The buzzer will sound and the interior light will flash if the refrigerator door is left open for more than 2 minutes.



! The appliance was designed and manufactured in compliance with international safety standards. The following warnings are provided for safety reasons and must be read carefully.



This appliance complies with the following Community Directives:

- 73/23/EEC of 19/02/73 (Low Voltage) and subsequent amendments;



- 89/336/EEC of 03.05.89 (Electromagnetic Compatibility) and subsequent amendments;  
- 2002/96/CE..

## General safety

- The appliance was designed for domestic use inside the home and is not intended for commercial or industrial use.
- The appliance must be used to store and freeze food products by adults only and according to the instructions in this manual.
- The appliance must not be installed outdoors, even in covered areas. It is extremely dangerous to leave the appliance exposed to rain and storms.
- Do not touch the appliance with bare feet or with wet or moist hands and feet.
- Do not touch the internal cooling elements: this could cause skin abrasions or frost/freezer burns.
- When unplugging the appliance always pull the plug from the mains socket, do not pull on the cable.
- Before cleaning and maintenance, always switch off the appliance and disconnect it from the electrical supply. It is not sufficient to set the temperature adjustment knobs on OFF (appliance off) to eliminate all electrical contact.
- In the case of a malfunction, under no circumstances should you attempt to repair the appliance yourself. Repairs carried out by inexperienced persons may cause injury or further malfunctioning of the appliance.
- **WARNING:** Do not use electrical or mechanical devices or tools other than the special scraper provided inside the compartments.
- Do not put ice cubes taken directly from the freezer into your mouth.
- Do not allow children to tamper with the controls or play with the appliance. Under no circumstance should they be allowed to sit on the bins or to hang from the door.
- Keep packaging material out of the reach of children! It can become a choking or suffocation hazard.

## Disposal

- Observe local environmental standards when disposing packaging material for recycling purposes.
- The European Directive 2002/96/EC on Waste Electrical and Electronic Equipment (WEEE), requires that old household electrical appliances must not be disposed of in the normal unsorted municipal waste stream. Old appliances must be collected separately in order to optimise the recovery and recycling of the materials they contain and reduce the impact on human health and the environment. The crossed out “wheeled bin” symbol on the product reminds you of your obligation, that when you dispose of the appliance it must be separately collected. Consumers should contact their local authority or retailer for information concerning the correct disposal of their old appliance.

## Respecting and conserving the environment

- Install the appliance in a fresh and well-ventilated room. Ensure that it is protected from direct sunlight and do not place it near heat sources.
- Try to avoid keeping the door open for long periods or opening the door too frequently in order to conserve energy.
- Do not fill the appliance with too much food: cold air must circulate freely for food to be preserved properly. If circulation is impeded, the compressor will work continuously.
- Do not place hot food directly into the refrigerator. The internal temperature will increase and force the compressor to work harder and will consume more energy.
- Regularly check the door seals and wipe clean to ensure they are free of debris and to prevent cold air from escaping (*see Maintenance*).

# Troubleshooting

GB

## Malfunctions:

**The green POWER indicator light does not illuminate.**

**The motor does not start.**

**a) The alarm sounds.**

**b) The alarm sounds and the two yellow indicator lights flash.**

**c) The alarm sounds and the two yellow indicator lights as well as the green one flash.**

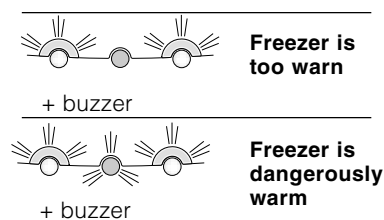

**The green POWER indicator light flashes.**

**The refrigerator and the freezer are not cold enough.**

**The food inside the refrigerator is beginning to freeze.**

**The motor runs continuously.**

**The appliance makes a lot of noise.**

## Possible causes / Solutions:

- The plug has not been inserted into the electrical socket, or not far enough to make contact, or the fuse has blown, or there is no power in the house.

- The appliance comes with a motor protection control (*see Start-up and use*).

**a)** The refrigerator door has remained open for more than two minutes (the buzzer will stop sounding when you shut the door) or the correct switching-off procedure was not followed (*see Maintenance*).

**b)** The temperature in the freezer is too high. Check the quality of the food products and dispose if necessary.

**c)** The temperature in the freezer has reached a dangerous level. The food must be disposed immediately.

**b/c)** In both these cases the freezer will try to maintain a temperature of about 0°C so that the food does not re-freeze.

To turn off the acoustic signal open and close the refrigerator door.

To restore normal operation bring the FREEZER OPERATION knob setting to  OFF (off) and turn the appliance on again.

- The appliance is not operating correctly. Contact the Technical Assistance Centre.

- The doors do not close properly or the seals are damaged.
- The doors are opened too frequently.
- The OPERATION knobs are not on the correct setting (*see Description*).
- The refrigerator or the freezer have been over-filled.

- The REFRIGERATOR OPERATION knob is not on the correct setting (*see Description*).
- The food is in contact with the back inside wall of the refrigerator.

- The SUPER FREEZE button has been pressed (rapid freezing): the yellow SUPER FREEZE light is on or flashing (*see Description*).
- The door is not closed properly or is continuously opened.
- The outside ambient temperature is very high.

- The appliance has not been installed on a level surface (*see Installation*).
- The appliance has been installed between cabinets that vibrate and make noise.
- The internal refrigerant makes a slight noise even when the compressor is off. This is not a defect, it is normal.
- Some noise from the air circulating fan is normal

---

## Guarantee

### 12 Months Parts and Labour Guarantee

Your appliance has the benefit of our manufacturer's guarantee, which covers the cost of breakdown repairs for twelve months from the date of purchase.

This gives you the reassurance that if, within that time, your appliance is proven to be defective because of either workmanship or materials, we will, at our discretion, either repair or replace the appliance at no cost to you.

#### **This guarantee is subject to the following conditions:**

- The appliance has been installed and operated correctly and in accordance with our operating and maintenance instructions.
- The appliance is used only on the electricity or gas supply printed on the rating plate.
- The appliance has been used for normal domestic purposes only.
- The appliance has not been altered, serviced, maintained, dismantled, or otherwise interfered with by any person not authorised by us.
- Any repair work must be undertaken by us or our appointed agent.
- Any parts removed during repair work or any appliance that is replaced become our property.
- The appliance is used in the United Kingdom or Republic of Ireland.

#### **The guarantee does not cover:**

- Damage resulting from transportation, improper use, neglect or interference or as a result of improper installation.
- Replacement of any consumable item or accessory . These include but are not limited to: plugs, cables, batteries, light bulbs, fluorescent tubes and starters, covers and filters.
- Replacement of any removable parts made of glass or plastic.

**THIS GUARANTEE WILL NOT APPLY IF THE APPLIANCE HAS BEEN USED IN COMMERCIAL OR NON-DOMESTIC PREMISES.**

### **5 Year Parts Guarantee**

Hotpoint also offers you a free 5 year parts guarantee. This additional guarantee is conditional on you registering your appliance with us and the parts being fitted by one of our authorised engineers. There will be a charge for our engineer's time. To activate the extra parts warranty on your appliance, simply call our registration line on 0870 6092094 (ROI 01 230 0800).

### **Extended Guarantees**

We offer a selection of repair protection plans that enable you to fully cover yourself against the expense of repair bills for the life of your policy. To find the ideal plan for you please call our advice line on 08709 088 088 (ROI 01 230 0233).

### **Free Helpdesk Service**

We have a dedicated team who can provide free advice and assistance with your appliance if you experience any technical difficulties within the first 90 days of ownership. Simply call our Hotpoint Service Hotline on 08709 066 066 (ROI 0818 313 413) for telephone assistance, or, where necessary, to arrange for an engineer to call. If we cannot resolve the technical problem we will replace your machine or, if you prefer, give you your money back.

## After Sales Service

No one is better placed to care for your Hotpoint appliance during the course of its working life than us - the manufacturer.

### Essential Contact Information

#### Hotpoint Service

We are the largest service team in Europe offering you access to 400 skilled telephone advisors and 1100 fully qualified engineers on call to ensure you receive fast, reliable, local service.

**UK: 08709 066 066**

**Republic of Ireland: 0818 313 413**

**[www.hotpointservice.co.uk](http://www.hotpointservice.co.uk)**

Please note: Our advisors will require the following information:

Model number:

Serial number:

#### Parts and Accessories

We supply a full range of genuine replacement parts as well as accessory products that protect and hygienically clean your appliance to keep it looking good and functioning efficiently throughout its life.

**UK: 08709 077 077**

**Republic of Ireland: 0818 313 413**

**[www.hotpointservice.co.uk](http://www.hotpointservice.co.uk)**

#### Appliance Registration

We want to give you additional benefits of Hotpoint ownership. To activate your free 5 year parts guarantee you must register your appliance with us.

**UK: 0870 6092094**

**Republic of Ireland: 01 230 0800**

**[www.hotpointservice.co.uk](http://www.hotpointservice.co.uk)**

**Indesit Company UK Ltd. Morley Way, Peterborough, PE2 9JB**

Indesit Company Unit 49 Airways Industrial Estate, Dublin 17

## Recycling & Disposal Information

As part of Hotpoint's continued commitment to helping the environment, Hotpoint reserves the right to use quality, recycled components to keep down customer costs and minimise material wastage.

Please dispose of packaging and old appliances carefully. Please see section "Precautions and tips" for details about disposal legislation. To minimise the risk of injury to children, remove the door, plug and cut the mains cable off flush with the appliance. Dispose of these parts separately to ensure that the appliance can no longer be plugged into a mains socket, and the door cannot be locked shut.

## Free Manuals Download Website

<http://myh66.com>

<http://usermanuals.us>

<http://www.somanuals.com>

<http://www.4manuals.cc>

<http://www.manual-lib.com>

<http://www.404manual.com>

<http://www.luxmanual.com>

<http://aubethermostatmanual.com>

Golf course search by state

<http://golfingnear.com>

Email search by domain

<http://emailbydomain.com>

Auto manuals search

<http://auto.somanuals.com>

TV manuals search

<http://tv.somanuals.com>