



User Instructions for Model FFU00

Electrical Supply

WARNING: This appliance must be earthed.

Fuses

Your appliance comes fitted with a plug and a 13A fuse. If you need to replace the fuse, only those rated at 13A and ASTA approved to BS1362 should be used.

WARNING: Do not use the plug unless the fuse cover is fitted.



Changing the plug

Cut off and dispose of the supplied plug if it does not fit your socket.

WARNING: To avoid a shock hazard do not insert the discarded plug into a socket anywhere else.

IMPORTANT: WIRES IN THE MAINS LEAD ARE COLOURED IN ACCORDANCE WITH THE FOLLOWING CODE:

Green / Yellow	-	Earth
Blue	-	Neutral
Brown	-	Live

If you change the plug, the colour of the wires in the mains lead may not correspond with the colour of the markings identifying terminals in the plug. You should therefore wire it as shown.

Green and yellow (Earth) wire to terminal marked 'E', symbol , or coloured green and yellow.

Blue (Neutral) wire to terminal marked 'N' or coloured black.

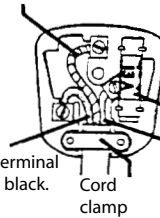

13A ASTA approved fuse to BS1362.

Brown (Live) wire to terminal marked 'L' or coloured red.

Changing the Mains Lead

A special lead can be ordered from your Service Department:

UK: 08709 066 066 or

Republic of Ireland: 1850 302 200

If you have damaged the existing lead or require a longer one a charge will be made. It is strongly advised that this work is carried out by a qualified electrician.

CE CE marking certifies that this appliance conforms to the following EEC directives:-
Low Voltage Equipment - 72/23/EEC & 93/68 EEC
Electromagnetic Compatibility - 89/336/EEC, 92/31/EEC & 93/68/EEC

Retention of the instruction Book

This instruction Book must be kept handy for reference as it contains important details on the safe and proper use of the appliance. If you sell or pass the appliance to someone else, or move house and leave it behind, make sure this Book is also provided so the new owner can become familiar with the appliance and safety warnings.

Contents

	Page
Electrical requirement	2
Safety advice	4
Installation	5-10
Get to know your Appliance	11-13
The controls	14-16
Storing food	17-18
Care & Cleaning	19
Troubleshooting	20-24
Guarantee	26
Recycling & Disposal information	26
After sales service	27
Key contacts	back cover

Safety advice

- * **Please take time to read this booklet before installing and switching on this appliance. The manufacturer assumes no responsibility for incorrect installation and usage.**
- * If this appliance is to replace an old refrigerator with a lock, break or remove the lock as a safety measure to avoid the danger of children playing with the refrigerator and locking them inside.
- * Old refrigerators and freezers contain insulation gases and refrigerant that must be disposed of properly. Please ensure that none of the tubing at the back of the appliance gets damaged.
- * Do not twist and bend the mains lead and keep it away from hot surfaces.
- * Do not let children play with the appliance.
- * Do not sit or stand on the appliance.
- * Do not use sharp metal objects for removing any ice build up in the freezer compartment, as this could cause damage to the refrigeration system.
- * Do not put the plug into the power supply with wet hands.
- * Do not store poisonous, flammable or dangerous substances in your freezer.
- * Do not store carbonated (fizzy) drinks or medicines in the freezer compartment.
- * Do not eat iced lollipops or other such things direct from the freezer compartment as this could cause low temperature skin burns, always leave for a few minutes before eating.
- * Do not touch the surfaces inside the freezer compartment with wet hands as this could cause low temperature skin burns.
- * Do not use aerosol sprays for defrosting or cleaning your appliance.

Installation

WARNING: THE APPLIANCE SHOULD ONLY BE INSTALLED BY A QUALIFIED PERSONNEL IN COMPLIANCE WITH THESE INSTRUCTIONS, CURRENT STANDARDS AND REGULATIONS.

Before Fitting:

Please read through this section before starting any work.

Choosing a Location:

Do not install your appliance in a room where the temperature goes below 5°C, this will affect the appliances performance.

The power socket should be in a readily accessible position, adjacent to the appliance. DO NOT connect to the electricity supply until all installation is complete.

Place the appliance in a dry and regularly ventilated room.

Never place the appliance near heat emitting devices (eg. cooker, radiator, water heater or similar devices) and do not expose it to direct sunlight. In such a position your appliance will have to work harder and will cost more to run and could be damaged by the heat.

Ensure that you provide adequate air circulation around the appliance, to prevent condensation.

Leave at least 300mm free space above and 50mm or more from the wall.

Also, the appliance should be elevated 25mm from the floor, especially if it is carpeted.

Providing you follow the recommended ventilation requirements you will:

- * Prolong the life of your appliance.
- * Minimise the risk of condensation on the outside of the appliance.
- * Minimise the running costs.
- * Minimise operating sounds caused by vibration.

Door Removal:

If your access door is too narrow for the appliance to pass through, you will need to remove both doors - pass the appliance through the access door, in its upright position - then refit the doors on the other side (see Door Removal instructions - pages 6 & 7).

Water Supply:

Your appliance has an ice maker and cool water dispenser function and therefore needs to be connected to a cold water supply before use (see Feed Water Tube / Plumbing Installation instructions - page 8 and 9).

Levelling

Level both doors by adjusting the left and right hand height adjusting screws. With the doors aligned they will close correctly and this helps the appliance to run efficiently (see Height Adjustment instructions - page 10)

Installation

WARNING: ENSURE THE APPLIANCE IS NOT CONNECTED TO THE ELECTRICITY SUPPLY BEFORE INSTALLING.

You may need to remove both doors for the appliance to fit through access doors - follow the instructions below:

WARNING: YOU MAY NEED ASSISTANCE TO DO THIS - THE DOORS ARE HEAVY AND SHOULD BE SUPPORTED AT ALL TIMES TO AVOID DAMAGE AND INJURY.

Feed Water Tube:

- * Remove the lower cover by lifting upwards.
- * Pull out the feed water tube, while pressing area (1) indicated in Fig.1

NOTE: Cut away any tube end which is misshapen or worn

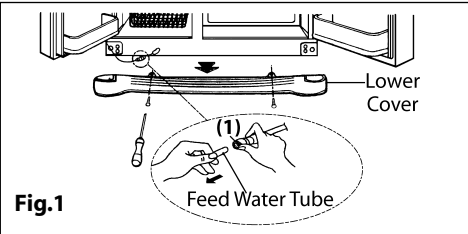

Fig.1

Remove the Freezer Compartment Door:

- * Loosen the screws in the upper hinge cover and remove. Separate all connection wires, except for the earth line (Fig.2).

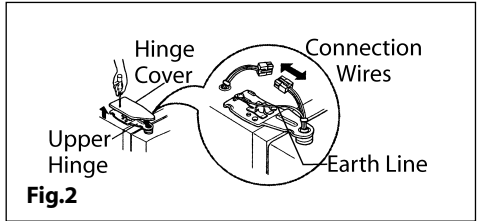

Fig.2

- * Remove the retainer by rotating it anti-clockwise (a - Fig.3), then remove the upper hinge by lifting up.

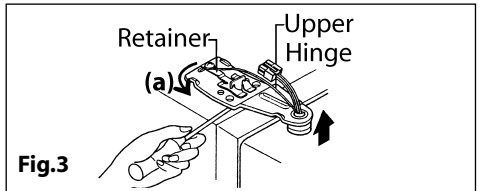

Fig.3

NOTE: Support the door when removing the upper hinge.

- * Remove the freezer compartment door by lifting it up off the lower hinge. Lift enough so that the feed water tube is completely pulled out (Fig.4)

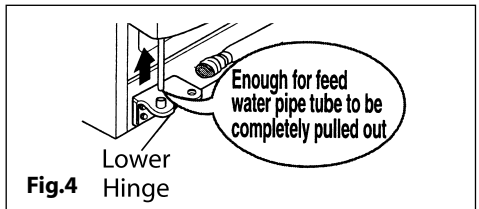

Fig.4

NOTE: Carry the freezer compartment door through the access door and lay it down on suitable material eg. the original packaging. Take care not to bend or damage the feed water tube.

Installation

Remove the Fridge Compartment Door:

- * Loosen the upper hinge cover screws and remove the cover (Fig.5).

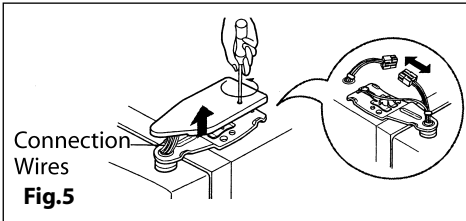

- * Remove the retainer by rotating it clockwise (**b** - Fig.6), then remove the upper hinge by lifting up.

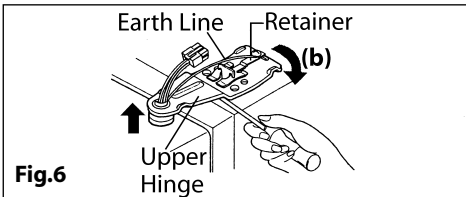

NOTE: Support the door when removing the upper hinge.

- * Remove the fridge compartment door by lifting it up, off the lower hinge (Fig.7).

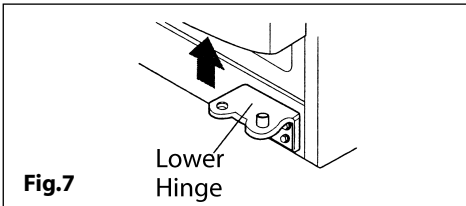

NOTE: Carry the fridge compartment door through the access door and lay it down on suitable material eg. the original packaging.

Pass the appliance through the access door, in its upright position (Fig.8)

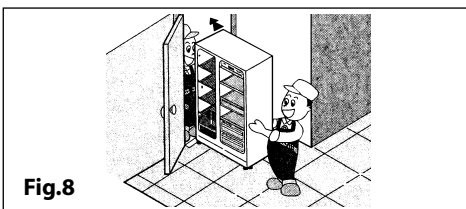

Door Replacement:

- * Replace both doors by following the removal instruction in reverse order.

Installation

- **FIRST CHECK YOU HAVE THE CORRECT ITEMS:**

- **Pipe / Filter Kit comprises:**
 - * 1 x Water Filter
 - * 2 x Self-Adhesive Fixing Plates
 - * 2 x Cable Ties
 - * 1 x 10m Water Pipe
- **Adaptor Kit comprises:**
 - * Plastic Pipe Connector
 - * Rubber Washer
 - * Threaded Tap Connector

- **NEXT, HAVE A LOOK AT THE DIAGRAM BELOW TO VISUALISE HOW THE APPLIANCE SHOULD BE CONNECTED:**

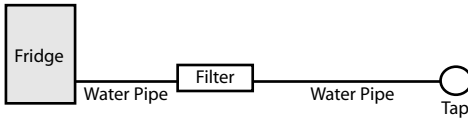

- **Connection to the Appliance:**

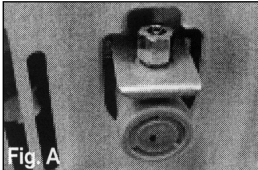

- Fig. A
- * At the back of the appliance you will see the water inlet valve (Fig.A)

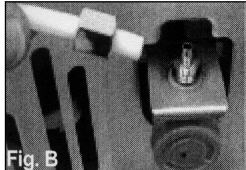

- Fig. B
- * Unscrew the metal threaded collar and place it over one end of the water pipe (Fig.B)

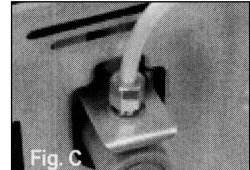

- Fig. C
- * Push the water pipe onto the water inlet valve firmly, tighten up the metal collar (Fig.C)

- * You now need to cut the water pipe to the right length for the connection of the water filter. It is suggested that **approximately 1.5m of pipe is used** - this should allow the filter to be located in an easily accessible position (as the water filter should be replaced approximately every 6 months, according to use and conditions) and also allow some slack in the pipe behind the appliance, so that it can be pulled out for cleaning or servicing purposes. **You must also ensure that the cut is square and not at any sort of angle as this could cause a leak.**

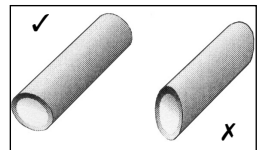

Installation

● Connection of Water Filter:

- * Now you have to cut the pipe to the length it needs to be to run from the back of the appliance and attach to the water filter.
NOTE: The water filter is marked with an arrow to show the direction of water flow (ie. from supply tap to appliance).
Remember however, that the connection process is being done FROM the appliance TO the tap (ie. in reverse of the water flow when in use).

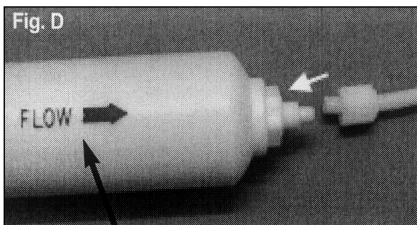

Note the direction markings on the filter

- * Unscrew the threaded connector and place it over the end of the cut section of pipe coming away from the appliance. Push the pipe over the end of the water filter that the arrow points to and tighten the threaded connector (Fig.D)

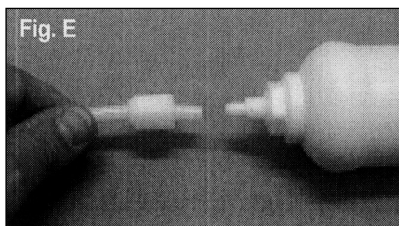

- * Repeat on the other end of the water filter, using the remainder of water pipe (Fig.E)
- * Run this section of water pipe from the water filter to the water supply tap, making sure it is not trapped or kinked at all.

● Connection to the Water Tap:

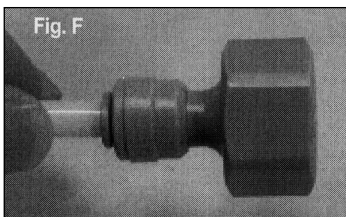

- * Cut the pipe that is connected to the water filter to the correct length. Again, make sure that the cut is nice and square to avoid leaks.
- * Push the pipe into the smaller hole of the connector supplied in the adaptor kit. The pipe should be held firm (Fig.F)

- * Place the threaded tap connector over the long part of the brass flange. Firmly push the flange into the other end of the water connector (Fig.G)
- * Place the rubber washer inside the threaded tap connector and screw onto the water tap.

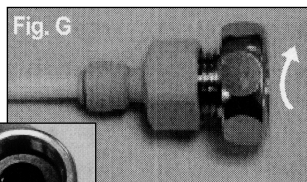

- **FINALLY: Plug in and switch on the electricity supply. Turn on the water supply tap. Check for any leaks. Ensure selection is set to 'water' (see page 15) push a cup under the dispenser to verify that water is flowing. When all working OK, move the appliance into its final location - your appliance is heavy and care should be taken when moving it, also do not trap or kink hoses at the back of the appliance. Replace the lower cover. Mount the water filter in an accessible position using the self-adhesive fixing plates and cable ties supplied.**

Installation

Height Adjustment:

Levelling both doors using the height adjustment screws. With the doors level they will close smoothly.

If the doors do not close correctly it will affect the performance of your appliance.

- * If the **freezer** compartment door is **lower** than the fridge compartment door, adjust the **left hand** adjustment screw (Fig.10). Level the door by inserting a flat (- type) driver into the groove of the left hand adjustment screw and rotate it clockwise.

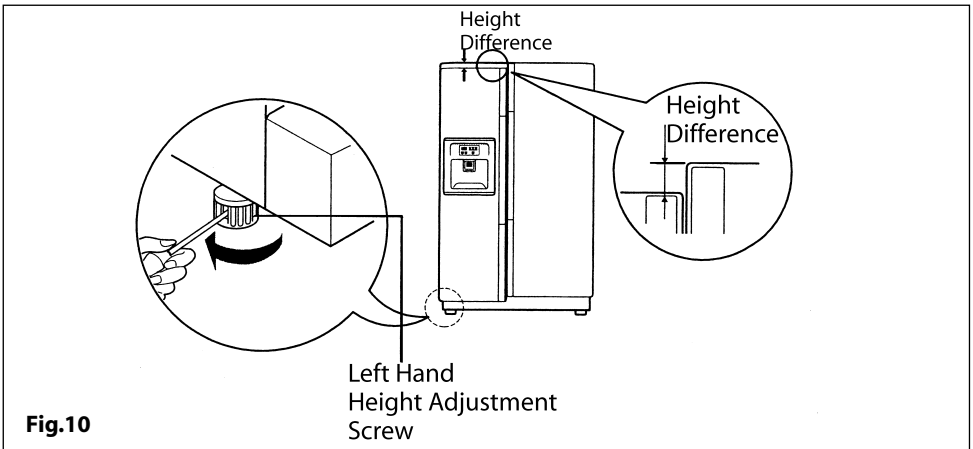

- * If the **freezer** compartment door is **higher** than the fridge compartment door, adjust the **right hand** adjustment screw (Fig.11). Level the door by inserting a flat (- type) driver into the groove of the right hand adjustment screw and rotate it clockwise.

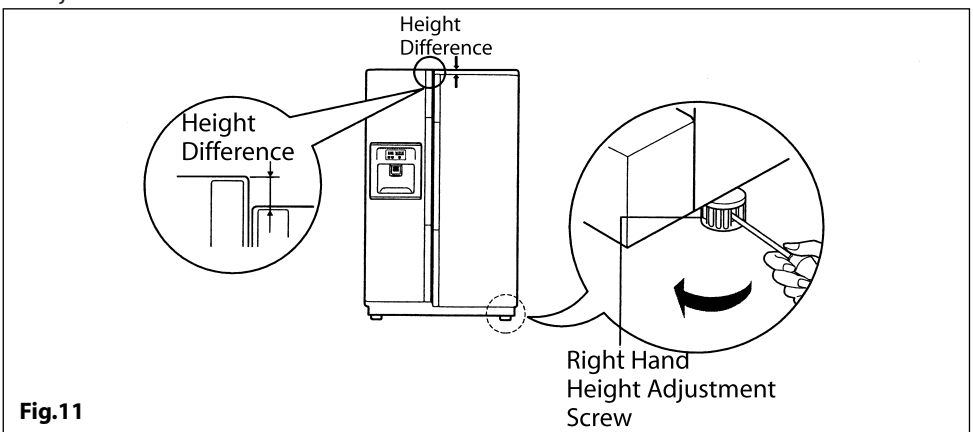

Get to know your Appliance.

Before using your appliance for the first time, wipe off any dust and clean thoroughly (see Cleaning instructions - Page 17).
Unpack and install accessories in their proper

places - they are packed together to prevent possible damage during transit.
See features picture below (Fig.12) to familiarise yourself with your appliance:

Fig.12

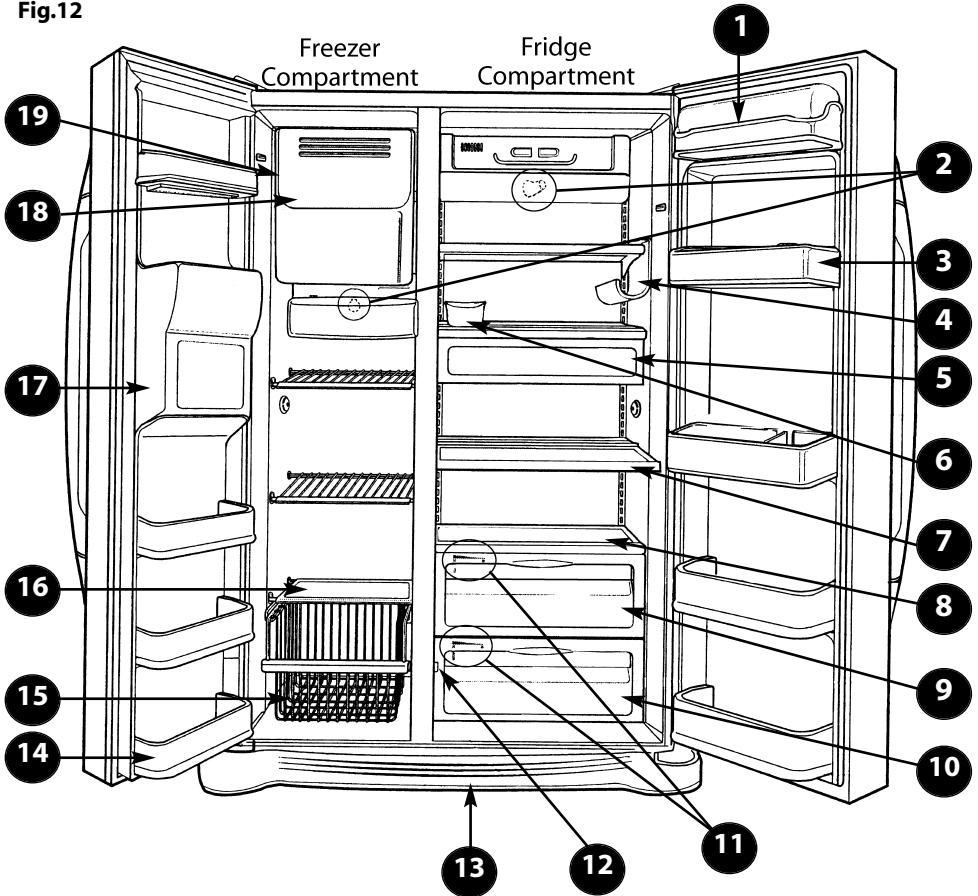

- | | |
|---|--|
| 1. Covered Dairy Rack | 11. Humidity Switch |
| 2. Lamps | 12. Vegetable / Meat Conversion Switch |
| 3. Refrigerator Commodity Rack | 13. Lower Cover |
| 4. Wine Bottle Holder | 14. Freezer Commodity Rack |
| 5. Snack Drawer | 15. Freezer Drawer |
| 6. Egg Holder | 16. Freezer shelf |
| 7. Refrigerator Shelf | 17. Water / Ice Dispenser Unit |
| 8. Vegetable compartment cover | 18. Automatic Ice Maker |
| 9. Vegetable compartment / Salad Bin | 19. Ice Maker On / Off Switch |
| 10. Vegetable compartment / Meat Drawer | |

Get to know your Appliance.

- Make the most of interior storage space by repositioning shelves to suit the various items you wish to store.

Refrigerator Shelf:

To separate a shelf:

- Lift shelf up in direction shown 1 in Fig.13.
- Separate by lifting, direction 2 in Fig.13.

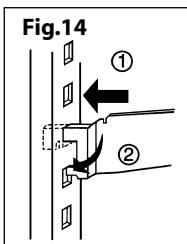
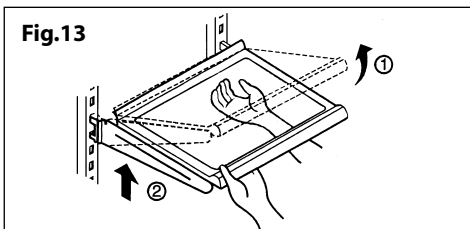

To install a shelf:

- Hold shelf at an angle, place at required position and push into the grooves, 1 in Fig.14.
- Then lower the front end and again push into the grooves, 2 in Fig.14.

NOTE:

- Ensure both sides are fitted at the same height.

Freezer Shelf:

To remove:

Hold at both ends, push the shelf in to the left, at the same time lift up at the right and take out.

To install:

Hold both ends, at an angle so that the left hand side is in position. Push in to the left and pull down until the right hand side locates into position.

Vegetable compartment / cover:

The vegetable drawer can be removed by sliding it out from position.

To remove the cover:

Pull out the vegetable drawer a bit, lift the cover at the front and pull out.

Wine Holder:

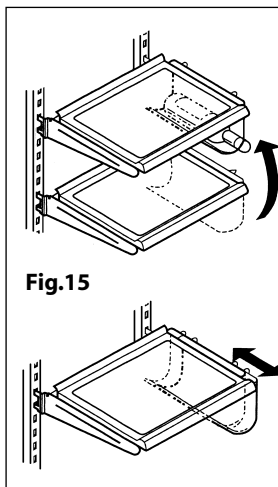

- Bottles are stored laterally in the wine holder.
- The wine holder can be attached to any shelf in the refrigerator compartment.
- Place the wine holder at the side of the shelf and push it in along the shelf edge.
- Remove it by pulling it gently forward and out.

Commodity Rack:

- Commodity racks provide storage in the doors. The covered commodity rack is recommended for the storage of dairy items such as butter, margarine and cheese.

To remove:

Lift the commodity rack, holding both sides and pull out.

Egg Box:

- Store eggs in the egg box in the refrigerator compartment - DO NOT store in the freezer compartment.

NOTE:

- Wipe, don't wash eggs.

Get to know your Appliance.

Humidity Control Switch (Fig.16):

The humidity in the salad / vegetable compartments can be controlled by adjusting the switches on the top left of the drawers.

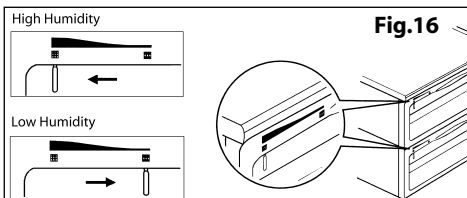

Convert into a Vegetable or Meat Compartment (Fig.17):

- The bottom drawer in the refrigerator can be converted into a vegetable OR meat compartment.
- The meat compartment maintains a lower temperature than the rest of the refrigerator, so that meat and fish can be stored fresh for longer.

NOTE:

- Remember to check setting of conversion switch before loading food items - vegetables and fruit will freeze if placed in drawer set to 'Meats'!

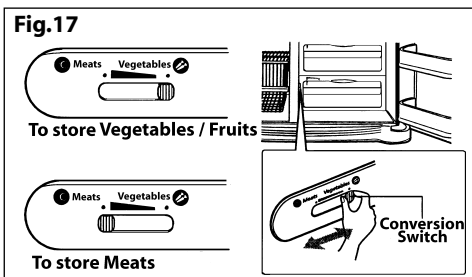

The controls

Starting:

- When your appliance is first installed leave it to stand in its final location for 2-3 hours, to allow the refrigerant to settle, before loading it with fresh or frozen foods.
- If operation is interrupted, wait 5 minutes before restarting.

Function Display Board

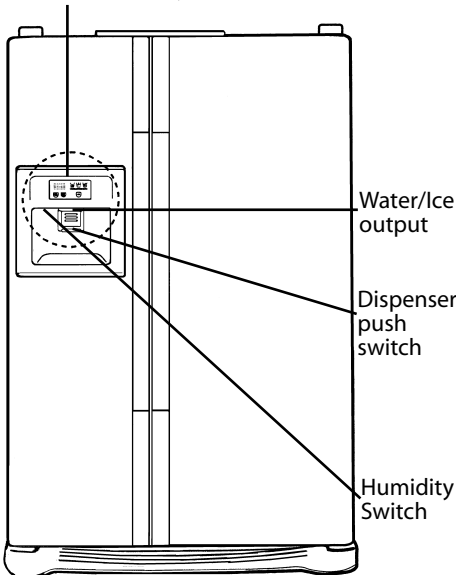

Function Display Board:

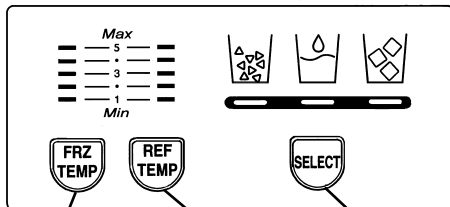

Temperature adjustment button for freezer compartment.

Temperature adjustment button for refrigerator compartment.

Dispenser selection button.

How to Adjust the Temperature of the Freezer Compartment:

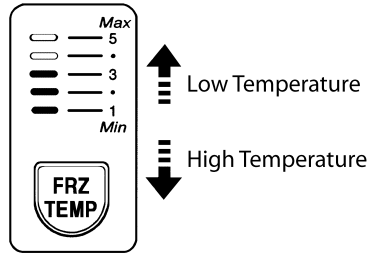

- When the appliance is first switched on and also after a power cut, the temperature control will be lit at setting 3 (Normal - Mid setting).
- Pressing the **FRZ TEMP** button will change the temperature setting:
Higher number - **Colder**
Lower number - **Warmer**
- Setting 3 (Normal) is usually suitable - but the appropriate setting will depend on the appliance location, room temperature, how often the door is opened and amount of stored food.

How to Adjust the Temperature of the Refrigerator Compartment:

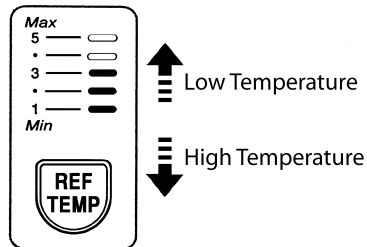

- When the appliance is first switched on and also after a power cut, the temperature control will be lit at setting 3 (Normal - Mid setting).
- Pressing the **REF TEMP** button will change the temperature setting:
Higher number - **Colder**
Lower number - **Warmer**
- Setting 3 (Normal) is usually suitable - but the appropriate setting will depend on the appliance location, room temperature, how often the door is opened and amount of stored food.

The controls

Dispenser Selection Button:

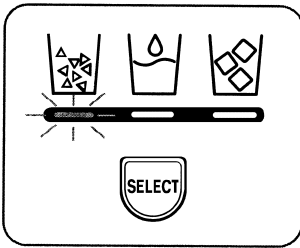

- When the appliance is first switched on and also after a power cut, the crushed ice function will be lit.
- Pressing the **SELECT** button will allow you to choose the different dispenser functions: Crushed Ice, Water or Cubed Ice.

Automatic Ice Maker and Dispenser:

Water is cooled while stored in the water tank in the refrigerator compartment and then sent to the dispenser.

NOTE: It is normal that the water is not very cold at first.

The Ice Maker On/Off Switch controls water going into the ice maker. Make sure when ice is required that this switch is in the 'ON' position.

Ice is made in the automatic ice maker and sent to the dispenser divided into crushed or cubed ice.

- **It takes about 12 hours for a newly installed appliance to make ice!**

How to Use the Dispenser:

Select your required dispenser function. Then gently press in the dispenser push switch with a glass or similar container.

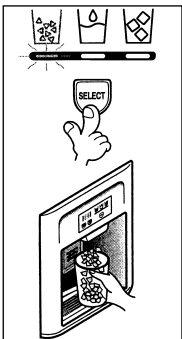

Crushed Ice:

Press the selection button until crushed ice function light illuminates.

- Crushed ice will be dispensed by pressing the dispenser push switch with a glass.
- Hold your glass under the dispenser outlet after releasing the dispenser push switch to allow any left over ice to be dispensed.

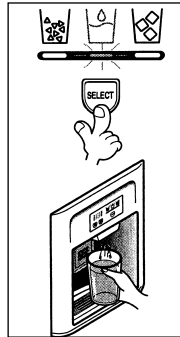

Water:

Press the selection button until water function light illuminates.

- Water will be dispensed by pressing the dispenser push switch with a glass.
- Hold your glass under the dispenser outlet after releasing the dispenser push switch to allow any left over water to be dispensed.

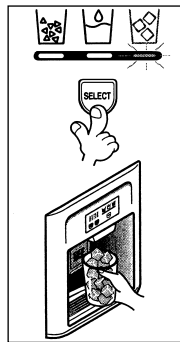

Cubed Ice:

Press the selection button until cubed ice function light illuminates.

- Crushed ice will be dispensed by pressing the dispenser push switch with a glass.
- Hold your glass under the dispenser outlet after releasing the dispenser push switch to allow any left over ice to be dispensed.

Humidity Switch:

In low room temperatures, turning 'ON' the Humidity Switch reduces condensation on the dispenser panel.

NOTE:

- **Remove the water collector cover and wipe away any spill water.**
- **If cubed ice is selected after crushed ice, there may still be some crushed ice left to dispense.**
- **A 'click' sound will be heard a few seconds after the ice is fully dispensed - This sound is made when the ice outlet is closed.**
- **Ensure the glass is a suitable size and held clear of the ice outlet - a glass placed too close could block the release of the ice.**

WARNING:

- **Children should not be allowed to play with the appliance or tamper with the controls.**

The controls

Automatic Ice Maker:

- 8 pieces of ice can be made at a time, 80 pieces a day. But these quantities may vary according to various conditions, such as the location of the appliance and how many times the door is opened and closed.
- Ice making stops when the ice storage bin is full.

WARNING:

- **The initial amount of ice and water dispensed may contain particles from the feed water tube. Therefore we recommend you discard approximately, the first 20 pieces of ice and the first 7 glasses of water dispensed straight after installation and again if the appliance has not been used for a long time.**

NOTE:

- It is normal to hear a noise when ice is dropped into the ice storage bin.
- Never store drink cans or other foods in the ice storage bin for the purpose of rapid cooling - this could damage the appliance.
- Never use thin crystal glass or crockery to collect ice.
- Never touch the ice outlet by hand or using a tool of any kind - this could cause damage or injury.
- Never remove the ice maker cover.
- Level the surface of the ice in the ice storage bin to ensure ice production continues to its full capacity.
- Ensure food packages do not block the ice passage, from the Automatic Ice Maker to the Dispenser Unit

- If ice is not used regularly, it may lump together. When this happens, remove the lumps of ice from the ice storage bin - break them into small pieces and return the smaller pieces to the ice storage bin.
- If the ice maker frequently has lumped together ice or it produces too small cubes - the amount of water supplied to the ice maker may need to be adjusted. Contact Hotpoint service, see back cover.

WARNING:

- **If discoloured ice is dispensed, stop using and contact Hotpoint service, see back cover.**

Ice Storage Bin Removal:

NOTE:

- **It is recommended NOT to dismantle the ice storage bin unless it is necessary.**

- Hold the ice storage bin as shown, pull it out (2) while slightly lifting at the front (1).
- Be sure to use both hands when removing the ice storage bin, so as not to drop it!
- If the ice storage bin does not fit well, rotate the 'rotating device' slightly.

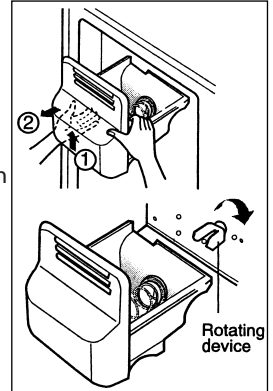

Door Open Alarm:

- An alarm will sound 3 times when either the freezer or the refrigerator door is left open for more than 1 minute.
- This alarm will be rung at intervals of 30 seconds until the door/s are closed.
- If the door alarm does not stop when the door/s are closed contact Hotpoint service, see back cover.

Self-diagnosis (fault detection) function:

- The self-diagnosis function operated when a problem occurs.
- When an error does occur DO NOT turn the power off and contact Hotpoint service immediately, see back cover. (If the power is turned OFF, it will take the engineer longer to trace the fault).

NOTE:

- **When a fault occurs, pressing any function buttons will not alter the temperature settings.**

Storing food

Making the best use of your Appliance

To ensure that your appliance operates as efficiently as possible:

- * Follow packaging "best by/use by" instructions or your suppliers advice on a suitable maximum storage time.
- * Keep foods covered to retain moisture and prevent flavour/odour transference. Plastic bags, aluminium foil, plastic stretch wrap and containers with lids are ideal.
- * Select chilled and frozen food last when shopping, transport in a 'coolbag' and place in appliance as soon as possible after arriving home.
- * Avoid opening the doors unnecessarily or for longer than needed.
- * Allow hot or warm food to cool down in covered containers before placing in appliance, as placing hot food in the appliance reduces efficiency.
- * Prepare fresh foods for freezing in small quantities to ensure that the food freezes quickly, therefore retaining its quality.
- * Ensure all packets / containers of food are dry before freezing, otherwise they may freeze together.

Warning: Do not use to store poisonous, flammable or dangerous substances, your appliance has been designed for the storage of edible foodstuffs only.

Storing food in a freezer

- * Freeze and store either fresh food or long term commercially frozen foods.
- * Generally speaking long term storage means up to 3 months but this can vary, so always follow your supplier's recommendations.
- * Place frozen food in the freezer compartment as soon as possible after buying it.
- * When storing frozen food such as ice cream for a long period, store it on the shelves, not in the commodity rack
- * Liquid-filled bottles or sealed fizzy drinks must not be stored in freezer, as they may burst.
- * Lollipops and water ices should not be given to children directly from the freezer. The low temperature may cause 'freezer burns'.
- * Store ice cream towards the top front of the freezer and remove from freezer 15-30 minutes before serving.
- * Ensure food is labelled and dated before placing in freezer.
- * Once thawed, food should be cooked and eaten within 24 hours or cooked and refrozen.

Storing Food in a Fridge

- * Pack and store cooked and fresh food separately.
- * Wrap raw or defrosting meat and poultry in polythene or foil and store below cooked foods and dairy products to avoid contamination of dripping food juices.
- * Wrap cheese in greaseproof paper and place in an airtight polythene bag. Bring to room temperature before consuming.
- * Empty left over canned food into a covered storage containers before placing in fridge.
- * Position food to allow cold air to circulate freely, ensuring nothing comes into contact with the cooling plate at the back of the appliance.
- * Avoid placing moist food on the top refrigerator shelves, it could freeze from direct contact with chilled air.

Storing food

Location of Foods:

Wine bottle holder	Store wine
Snack drawer	Store items such as bread, snacks etc.
Freezer compartment shelf	Store various frozen foods such as meat, fish, ice cream, frozen snacks etc.,
Freezer commodity rack	Store small packed frozen food. Temperature is likely to increase as the door is opened, so do not store long term frozen food, such as ice cream etc.
Freezer drawer	Store meat, fish, chicken etc. (after wrapping them).
Covered dairy rack	Store products such as butter, cheese etc.
Egg Holder	Store eggs only - place this box in its proper location.
Refrigerator commodity rack	Store small packed food or beverages such as milk, juice, beer etc.
Refrigerator shelf	Position food to allow cold air to circulate freely.
Vegetable drawer	Store vegetables or fruit.
Vegetable / Meat conversion drawer	Store vegetables, fruit meat to thaw, raw fish etc. Setting the conversion switch as necessary. Be sure to check the conversion switch setting before storing foods.

Care & Cleaning

WARNING:

- **Switch off the electricity supply and pull out mains plug before cleaning.**

Interior

- * Remove salad bins, racks, shelves and baskets - wash in warm water and washing up liquid using a soft cloth, dry thoroughly. **Do not put in a dishwasher.**
- * Wipe the interior and fittings with a clean cloth wrung out in a solution of either one teaspoon of bicarbonate of soda to one pint of water or Milton™ sterilising fluid, diluted according to the manufacturer's instructions.
- * Dry the interior thoroughly with a clean cloth before replacing fittings and food.

Note : It is important to ensure that cleaned shelves, racks, bins and baskets are thoroughly dried before refitting to the compartments.

Exterior

- * Use a clean soft cloth wrung out in warm water and washing up liquid to wipe the exterior surface, dry thoroughly.
- * Use a soft brush or vacuum cleaner to remove dust from underneath the appliance and from the compressor and condenser situated at the back of the appliance. **DO NOT** damage the pipework.

Do not use abrasive powder, household cleaner, bleach or wax polish to clean your appliance, they leave a smell in the compartments and can damage the exterior.

Door Seals

- * Use warm water and a clean soft cloth to wipe along and in between the creases of the door seals, dry thoroughly. Take care not to damage the seals and avoid using sharp objects.

Do not use detergent, it will damage the seals.

When the cleaning operations have finished, reconnect the plug with **dry hands**.

After the dispenser is used:

The water collector has no self drainage function. So it should be cleaned regularly.

- * Remove the cover by pressing the top left where marked.
- * Wipe with a damp soft cloth, dry thoroughly

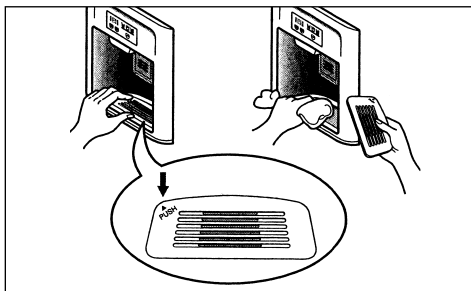

Replacing the light bulb

1. Unplug the appliance from the power supply.
2. Gently lift the lamp cover and pull the lamp out. Turn it anti-clockwise to remove.
3. Replace the bulb with Max. 240V 40W bulb for refrigerators and can purchased from Hotpoint Genuine Parts & Accessories (see back cover).

Replacing the dispenser lamp:

1. Unplug the appliance from the power supply.
2. Separate the lamp by pulling it out and then remove.
3. Replace the bulb with Max. 240V 15W bulb for refrigerators and can purchased from Hotpoint Genuine Parts & Accessories (see back cover).

If the appliance is not going to be used for a long time:

During average length holidays, you will probably find it best to leave the appliance operating as usual.

If the appliance is not going to be used for some time:

Remove all food, switch off at electricity supply and unplug and then clean the appliance interior.

Leave the doors open to prevent the formation of mildew and build up of odours.

Troubleshooting.

If your appliance is not working properly, it may be a minor problem, therefore check the following:

PROBLEM	Possible Cause	Solution
Running of Refrigerator		
Refrigerator compressor does not run.	Refrigerator control is off.	Set refrigerator control. See 'Controls'.
	Refrigerator is in defrost cycle.	This is normal for a fully automatic defrosting appliance. The defrost cycle occurs periodically.
	Is it plugged in and switched on.	Make sure the plug is pushed in fully and is switched on.
	There been a power cut.	Try to minimise the number of times you open the doors, if at all. If the power cut lasts longer than the maximum conservation time, food should be cooked and eaten within 24 hours or cooked and refrozen.
Refrigerator runs too much or too long.	Refrigerator is larger than the previous one you owned.	This is normal - larger, more efficient units run longer in these conditions.
	Room or outside weather is hot.	It is normal for the refrigerator to work longer under these conditions.
	Refrigerator has recently been disconnected for a period of time.	It takes some hours for the refrigerator to cool down completely.
	Large amounts of warm or hot food may have been stored recently.	Warm food will cause the refrigerator to run longer until the desired temperature is reached.
	Doors are opened too frequently or for too long.	Warm air entering the refrigerator causes it to run longer. Try to minimise the number of times you open the doors.
	Doors left slightly open.	Make sure that the appliance is level. Ensure stored items do not stop the doors closing properly. See Problem section: 'Opening/Closing of Doors'.
	Door seals are dirty, worn, cracked or poorly fitted.	Clean the door seal, see 'Care & Cleaning' section. You need to replace damaged seals to ensure door closes properly.
	Thermostat is keeping the refrigerator at a constant temperature.	This is normal to keep the temperature constant

Troubleshooting.

PROBLEM	Possible Cause	Solution
Temperatures are too cold:		
Temperature in the freezer is too cold BUT the refrigerator temperature is satisfactory.	Freezer control is set too cold.	Set Freezer control to a lower number (warmer setting) See 'Controls'.
Temperature in the refrigerator is too cold BUT the freezer temperature is satisfactory.	Refrigerator control is set too cold.	Set Refrigerator control to a lower number (warmer setting) See 'Controls'.
Food stored in drawers freezes	Refrigerator control is set too cold.	Set Refrigerator control to a lower number (warmer setting) See 'Controls'.
Meat stored in fresh meat drawer freezes	Meat should be stored at a temperature just below the freezing point of water (32°F, 0°C) for maximum fresh storage time.	It is normal for ice crystals to sometimes form due to the moisture content of meat.
Temperatures are too warm:		
Temperatures in the refrigerator or freezer are too warm	Freezer control is set too warm.	Set Freezer control to a higher number (colder setting) See 'Controls'.
	Refrigerator control is set too warm. Refrigerator control has some effect on freezer temperature.	Set Refrigerator control to a higher number (colder setting) See 'Controls'.
	Doors are opened too frequently or for too long.	Warm air enters the compartments whenever the door/s is/are opened. Open door/s less often.
	Door is slightly open.	Ensure doors are shut properly.
	Large amounts of warm or hot food may have been loaded recently.	Wait until the refrigerator or freezer has reached its selected temperature.
	Appliance has recently been disconnected for a period of time.	The appliance will need some time to reach its selected settings.
Temperatures in the refrigerator is too warm BUT the freezer temperature is satisfactory.	Refrigerator control is set too warm.	Set Refrigerator control to a higher number (colder setting) See 'Controls'.

Troubleshooting.

PROBLEM	Possible Cause	Solution
Sound and noise:		
Louder sound levels when refrigerator is on.	Today's refrigeration appliances have larger storage capacity and work to maintain more even temperatures.	It is normal for some sound to be heard.
Louder sound levels when the compressor comes on.	The appliance will work harder to reach selected temperatures when first switched 'ON'!	This is normal, the sound will level off when selected temperature have been reached.
Vibrating or rattling noise.	Floor is uneven. Appliance rocks when touched.	Ensure the floor is level and solid. Check 'Installation' section for Height Adjustment information.
	Items placed on top off refrigerator are vibrating.	Remove items.
	Dishes are vibrating on the shelves in the refrigerator.	Ensure appliance is level. Move dishes slightly and ensure nothing touches the interior back wall.
	Appliance is touching wall or cabinets.	Appliance needs to be relocated so that it stands clear.
Sound of ice dropping.	Appliance is touching wall or cabinets.	This is normally made when ice is made and dropped into the ice storage bin.
Water/moisture/ice inside refrigerator:		
Moisture collects on the inside walls of the refrigerator.	The weather is hot and humid which increases the rate of frost build up and internal moisture.	This is normal.
	Door is slightly open.	See problem section: 'Opening/Closing of Doors'.
	Door is opened too often and for too long.	Open the door less often
Moisture forms on the outside of the refrigerator or between the doors.	Weather is humid.	This is normal in humid weather.
	Door slightly open.	Ensure door/s are closed properly.
Odours in refrigerator:		
	Interior needs to be cleaned.	Clean the interior, see 'Care & Cleaning' section.
	Food with strong odour is stored in the refrigerator.	Ensure stored items are covered completely.
	Some containers and wrapping materials contain odours.	Use a different container or brand of wrapping material.

Troubleshooting.

PROBLEM	Possible Cause	Solution
<i>Opening/Closing of doors:</i>		
Door/s will not close.	Food package keeping the door open.	Ensure stored items are kept clear of the door so it can close properly.
	Door seal/s dirty or damaged.	Clean the seal/s, see 'Care & Cleaning' section. Replace damaged seal/s.
	Door closed too hard, causing the other door to open slightly.	Close doors gently.
	Appliance is not level. It rocks slightly when touched.	Adjust the height, see 'Installation' section.
	Floor is uneven. Appliance rocks when touched.	Ensure floor is level and can adequately support the appliance.
	Appliance is touching wall or cabinets.	Appliance needs to be relocated so that it stands clear.
Drawers are difficult to move.	Food is touching shelf on top of the drawer.	Do Not load too much food.
	The drawer runner is dirty.	Clean the drawer and the runner.
<i>Dispenser:</i>		
Dispenser will not dispense ice.	Ice storage bin is empty.	When the first supply of ice is released into the ice storage bin, the dispenser should operate.
	Freezer temperature is set too warm.	Turn the Freezer control to a higher number (colder setting), so that ice cubes will be made. When the first supply of ice is made the dispenser should work.
	Household water supply tap is not open.	Open the water supply tap and allow sufficient time for ice to be made (a newly installed appliance takes up to 12 hours to make the first supply of ice). When ice is made the dispenser should work.
	Refrigerator or freezer door is not closed.	Ensure both doors are closed properly.
	Ice has melted and frozen, due to infrequent use, irregular temperatures and/or power cuts, causing a blockage.	Remove the ice storage bin, as shown on page 14, and thaw the contents. Wash bin in warm water and washing up liquid and dry thoroughly before relocating in correct position. When new ice is made the dispenser will work.

Troubleshooting.

PROBLEM	Possible Cause	Solution
Dispenser:		
Ice dispenser is jammed.	Ice cubes are jammed between ice maker arm and back of the bin.	Remove the ice cubes.
	ice cubes that have been purchased or made in another way have been used in the dispenser.	Only the ice cubes made by the appliance ice maker should be used with the dispenser.
	Ice cubes are frozen together in the ice storage bin.	Irregular use sometimes causes the ice cubes to lump together. Take ice out, break up and put back into the ice storage bin.
Dispenser will not dispense water.	Household water supply tap is not open.	Ensure the household water supply tap is open. The dispenser should then work.
	Refrigerator or freezer door is not closed.	Ensure both doors are closed properly.
Water has an odd taste and/or odour.	Water has been in the tank too long.	You will need to dispense and discard 7 glasses of water to freshen the supply. and Dispense and discard an additional 7 glasses of water to completely rinse out the tank.
	Unit not properly connected to the cold water supply.	Check connection - reconnect if necessary.

If there is still a problem, contact Hotpoint Service (see KEY CONTACTS back cover for details).

Notes:



Hotpoint guarantee

“Satisfaction guaranteed or your money back”

We give you a unique ‘satisfaction guaranteed’ promise - **valid for 90 days** - after you have purchased your Hotpoint appliance. If there is a technical problem simply call Hotpoint Repair service or visit our web-site at www.theservicecentre.co.uk and where necessary, we will arrange for an engineer to call. If the technical problem is not resolved under this guarantee, **we will replace your machine or, if you prefer, give you your money back.**

All Hotpoint appliances carry a fully inclusive 12 month parts and labour guarantee as well as free replacement parts for the first 5 years (except microwaves, selected integrated appliances and cooker hoods, which have a one year guarantee) provided that they are fitted by a Hotpoint engineer.

Guarantee terms and conditions

Your guarantee is only applicable in the United Kingdom or Republic of Ireland and is subject to the following provisions that your appliance:

- Has been installed and used correctly in accordance with this instruction booklet.
- Has been used solely for domestic purposes and is located on domestic premises (ie. not for commercial or trade use).
- Has been properly connected to a suitable electrical supply voltage as stated on the appliance rating plate.
- Has not been subject to misuse, accident, modified or repaired by anyone other than a Hotpoint service engineer.



For pre purchase information on any other Hotpoint product call: 08701 50 60 70
or visit: www.hotpoint.co.uk



Recycling & Disposal Information

As part of Hotpoint’s continued commitment to helping the environment, Hotpoint reserves the right to use quality recycled components to keep down customer costs and minimise material wastage.

Please dispose of packaging and old appliances carefully. Old refrigerant and oil must be disposed of in a safe and environmentally friendly manner, using suitably qualified personnel.

To minimise risk of injury to children, remove the door, plug and cut mains cable off flush with the appliance. Dispose of these parts separately to ensure that the appliance can no longer be plugged into a mains socket, and the door cannot be locked shut.



After Sales Service

“No company is better positioned to offer an after sales service on a Hotpoint appliance than us - the manufacturer.”

As part of our commitment to you, all Hotpoint appliances have the added benefit of a fully inclusive parts and labour guarantee for the first 12 months. In addition to this you also have the advantage of **free replacement parts for the first 5 years** when fitted by a Hotpoint engineer. When the 12 months parts and labour guarantee expires we offer the following after sales service options:

Repair Service and Information Help Desk

UK: 08709 066 066

www.theservicecentre.co.uk

Republic of Ireland: 1850 302 200

Note: Our operators will require the Model number and Serial number of your appliance.

Available 364 days a year with a fast, effective and value for money service. We have the largest white goods repair service in the UK with over 1200 of our own fully trained engineers. All repairs include a parts and labour guarantee for 12 months from the date of repair. If you require any information or have any questions about your appliance, our operators are on hand with help and advice.

All this ensures that you will receive the best available after sales service possible.

Extended Warranties

UK: 08709 088 088

www.theservicecentre.co.uk

Republic of Ireland: 1850 502 200

Whether you have just one or a number of Hotpoint appliances in your kitchen, we offer two service cover plans to give you total peace of mind.

- Repair Protection Plan - FREE service repairs for a single Hotpoint appliance during the period of cover.
- Kitchen Cover - FREE service repairs for all your Hotpoint appliances less than 8 years old.

Genuine Parts and Accessories

UK: 08709 077 077

www.theservicecentre.co.uk

Republic of Ireland: (01) 842 6836

A wide range of genuine parts and accessories are available from our hotline or through our web site.

Genuine parts and accessories, extended warranties and service repairs are all available on our web site at:



www.theservicecentre.co.uk



Key Contacts

After Sales Service

Over 1200 trained specialists, directly employed by us, ensure that you can have complete confidence in both the appliances and services we offer.



Repair Service and Information Desk

UK: 08709 066 066

(Open 8 to 8 Mon - Fri, 8 to 6 Sat, 10 to 4 Sun & Bank Holidays)

www.theservicecentre.co.uk

Republic of Ireland: 1850 302 200

Note: Our operators will require the following information:

Model number:

Serial number:

Extended Warranties

UK: 08709 088 088

(Open 8 to 8 Mon - Sun)

www.theservicecentre.co.uk

Republic of Ireland: 1850 502 200

Genuine Parts and Accessories

UK: 08709 077 077

(Open 8.30 to 5.30 Mon - Fri & 9 to 12 Sat)

www.theservicecentre.co.uk

Republic of Ireland: (01) 842 6836

General Domestic Appliances Limited, Morley Way, Peterborough, PE2 9JB

Part No. FP110-01

Download from Www.Somanuals.com. All Manuals Search And Download.

Free Manuals Download Website

<http://myh66.com>

<http://usermanuals.us>

<http://www.somanuals.com>

<http://www.4manuals.cc>

<http://www.manual-lib.com>

<http://www.404manual.com>

<http://www.luxmanual.com>

<http://aubethermostatmanual.com>

Golf course search by state

<http://golfingnear.com>

Email search by domain

<http://emailbydomain.com>

Auto manuals search

<http://auto.somanuals.com>

TV manuals search

<http://tv.somanuals.com>