



kitchen think

## Instructions for Installation and Use

Fridge / Freezer  
Model HM450

**To the Installer**

**Before installation fill in the product details on the back cover of this book.  
The information can be found on the rating plate.**

**To the User**

**You must read the instructions prior to installing and using the appliance and  
then retain them for future reference.**

# CONTENTS

Product Safety	3
Installation	3
Electrical Connection	4
Get to Know your Appliance	5
Getting your Appliance ready for use	6
How to use the Refrigerator Compartment	6-7
Storage Guide	7
How to use the Freezer Compartment	8
Energy Saving Tips	8
Food Storage	9-10
Caring for your Appliance	11
Troubleshooting	12
Notes	13
After Sales Service	14
Hotpoint Guarantee	15
Key Contacts	Back Cover

## Retention of this Instruction Book

This Instruction Book must be kept handy for reference as it contains important details on the safe and proper use of the appliance.

If you sell or pass the appliance to someone else, or move house and leave it behind, make sure this Book is also provided so the new owner can become familiar with the appliance and safety warnings.

If the Book is lost or damaged a copy may be obtained from:  
GDA LTD., Morley Way, Peterborough, PE2 9JB



# PRODUCT SAFETY

## ATTENTION

Read your manual carefully since it contains instructions which will ensure safe installation, use and maintenance of your appliance.

Your Refrigerator is built to International safety standards (EN60) and has been awarded the European approval mark (IMQ) for compliance with UK electrical safety requirements. It also meets the EC standards on the prevention and elimination of radio interference (EC directive 87/308 - 02.06.89).

1. This appliance must not be installed outdoors - not even in an area protected by a roof. It is extremely dangerous to leave it exposed to rain or storms.
2. It must only be used by adults and exclusively to refrigerate and freeze foodstuffs, following the instructions for use contained in this manual.
3. Do not ever touch or handle the appliance with bare feet or with wet hands or feet.
4. It is highly recommended that you do not use extension cords or multiple socket adapters. If the refrigerator is installed between cabinets, make sure that the cord is not bent or dangerously pinched or compressed.
5. Never pull on the cord or the refrigerator to remove the plug from the wall socket - this is very dangerous.
6. Never touch the cooling components within the appliance, especially with wet hands because this could result in injury.

7. Never put ice cubes just removed from the freezer into your mouth because they could stick to your mouth and cause burns.

8. Never clean the appliance or perform maintenance without first disconnecting it from the electrical mains. Turning the thermostat knob to the ● setting does not suffice to break all electrical contact with the mains.

9. Before having your old refrigerator picked up for disposal, remove or make inoperable any locking devices to prevent children who might play in or around the appliance from being locked inside.

10. Before calling for service/assistance in the case of malfunction, consult the chapter entitled "TROUBLESHOOTING" to determine whether it is possible to eliminate the problem. Do not try to repair the problem by trying to access the internal components of the appliance.

11. If damaged, the power supply cord on this appliance must necessarily be replaced by our service centre because special tools are required for replacement.

12. Do not use electric appliances inside the compartment for food storage, if these are not those recommended by the manufacturer.

13. At the end of the functional life of your appliance – containing cyclopentane gas in the insulation foam and perhaps gas R600a (isobutane) in the refrigeration circuit – the latter should be made safe before being sent to the dump. For this operation, please contact your dealer or the Local Organisation in charge of waste disposal.

# INSTALLATION

To ensure that the appliance operates properly and to reduce energy consumption, it is important that the appliance is installed correctly.

## Ventilation

The compressor and condenser generate heat and, therefore, need to be ventilated properly. Avoid placing the appliance in direct sunlight, or next to an electric stove or similar appliance. Areas not adequately ventilated are not suitable for this appliance. Therefore it should be installed in a room with an opening (eg. window) that provides the appropriate amount of air re-circulation. It is also important that the room is not too humid.

During installation, make sure not to cover or obstruct the grates that allow for proper ventilation of the appliance.

For proper ventilation, you must leave:

- at least 10cm between the top of any cabinets above it.
- at least 5cm between the sides of the appliance to any adjacent cabinet/walls.

## Away from Heat

Avoid positioning the appliance in a place where it is directly exposed to sunlight or near an oven, hob or the like.

## Level

The appliance must be level. If the floor is not level, use the front adjustable feet to level the appliance.

## Electrical Connection and Earthing

Before proceeding with the electrical connection, make sure that the voltage indicated on the rating plate, located within the freezer, corresponds to the mains voltage in your home and that the socket is fitted with a standard earthing wire in accordance with safety standards for 46/90 systems. If the socket is not fitted with an earthing wire, the manufacturer will not be held liable for any damages and/or injuries arising out of the use of the appliance. Do not use multiple sockets or adapters.

**Position the appliance in such a way that you can access the socket where it is plugged in.**

## Insufficient power?

The electrical socket must be able to handle the maximum power load of the appliance, which is indicated on the rating plate located within the freezer.

## Before making the electrical connection ...

After the appliance has been delivered, place it in the vertical upright position and wait at least 3 hours before inserting the plug into the socket in order to ensure that it functions properly.

# ELECTRICAL CONNECTION

Your appliance is supplied with a 13amp fused plug that can be plugged into a 13amp socket for immediate use. Before using the appliance please read the instructions below.

## WARNING:

**THIS APPLIANCE MUST BE EARTHED.**

### Replacing fuse covers:

When replacing a faulty fuse, a 13amp ASTA approved fuse to BS 1362 should always be used and the fuse cover re-fitted.

If the fuse cover is lost, the plug must not be used until a replacement is obtained.

### Replacement fuse covers:

If a replacement fuse cover is fitted, it must be of the correct colour as indicated by the coloured marking or the colour that is embossed in words on the base of the plug.

### Changing the plug:

#### Removing the plug

If your appliance has a non-rewireable moulded plug and you should wish to remove it to add a longer cable or to re-route the mains cable through partitions, units etc. please ensure that either:

- The plug is replaced by a fused 13amp re-wireable plug bearing the BSI mark of approval.

or

- The mains cable is wired directly into a 13amp cable outlet, controlled by a switch (in compliance with BS 5733) which is accessible without moving the appliance.

#### Disposing of the plug

Cut off and dispose of the supplied plug if it does not fit your socket. The cable should be cut as close as possible to the moulded plug.

Remove the fuse.

## WARNING:

**To avoid a shock hazard do not insert the discarded plug into a socket anywhere else.**

### Fitting a new plug

#### IMPORTANT:

WIRES IN THE MAINS LEAD ARE COLOURED IN ACCORDANCE WITH THE FOLLOWING CODE...

Green and Yellow	-	Earth
Blue	-	Neutral
Brown	-	Live

As the colours of the wires in the mains lead may not correspond with the coloured markings identifying the terminals in your plug, proceed as follows:

- Connect Green and Yellow wire to terminal marked 'E' or  $\frac{1}{\text{E}}$  or coloured Green and Yellow.
- Connect Brown wire to terminal marked 'L' or coloured red or brown.
- Connect Blue wire to terminal marked 'N' or coloured Black or Blue.

If a 13amp plug (BS 1363) is used it must be fitted with a 13amp fuse. A 15amp plug must be protected by a 15amp fuse, either in the plug or adaptor or at the distribution board.

**If you are in any doubt about the electrical supply to your machine, consult a qualified electrician before use.**

**CE Marking certifies that this appliance conforms to the following EEC directives :**

**Low Voltage Equipment - 73/23/EEC & 93/68 EEC**

**Electromagnetic Compatibility 89/336/EEC, 92/31/EEC & 93/68/EEC**

# GET TO KNOW YOUR APPLIANCE

## **A** Temperature control

This knob is used to regulate the temperature in the two compartments with the following settings:

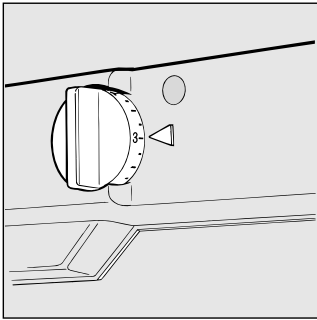

- The refrigerator is off;
- 1 = minimum cold temperature
- 5 = maximum cold temperature

## **I** Adjustable feet

## **J** Fruit and vegetable crispers

## **K** Meat/Cheese container

## **L** Drain for Defrost Water

## **M** Removable height adjustable shelves

## **N** "A.I.R. System"

(Advanced Integrated Refrigeration)

## **O** Compartment for storing frozen foods, freezing fresh foods and making ice

## **B** Aroma saving storage box

## **C** Removable door shelf with egg tray

## **D** Tiltable door shelves

## **E** Removable door shelves for small food products and bottles

## **F** Removable door shelf for small food products

## **G** Sliding divider for bottles

## **H** Compartment for bottles



# GETTING YOUR APPLIANCE READY FOR USE

## NOTICE

After the appliance has been delivered, stand it in the upright position and wait approximately 3 hours before connecting it to the electrical outlet to guarantee that it operates properly.

Before placing foodstuffs in the refrigerator or freezer, clean the interior well with warm water and baking soda.

After plugging in and switching on at the socket, make sure the light is on inside the refrigerator compartment.

Then turn the temperature control (A) to the 3 setting.

After a few hours, you can place fresh food inside the refrigerator and frozen food inside the freezer.

## How to use the refrigerator compartment

The temperature control automatically regulates the temperature inside the appliance

1 = minimum cold temperature

5 = maximum cold temperature

It is recommended that a medium setting be used.

To increase the amount of space, optimize arrangement and improve appearance, this appliance has a "cooling area" located within the back panel of the refrigerator compartment. When the appliance is operating, this panel may be covered with frost or droplets of water depending on whether the compressor is operating or not.

Do not be concerned about this! The refrigerator is operating normally.

If the temperature control is positioned on higher settings while the refrigerator is heavily filled and the ambient temperature high, the appliance may run continuously, resulting in the formation of frost on the back cooling area. This will lead to an increase in energy consumption.

**To avoid this situation, just turn the temperature control to a lower setting so that the appliance defrosts automatically.**

The refrigerator compartment of your appliance is equipped with "A.I.R. System" (Advanced Integrated Refrigeration) which makes it possible to achieve optimal food storage while simplifying the use of the refrigerator, thanks to the following features:

- Fast temperature reset, after the doors have been opened, the internal temperatures return to optimal levels faster, improving food storage.
- More uniform temperature distribution, this makes it possible to place any type of food on any shelf.
- Higher humidity level, this allows you to store food longer.
- Please follow our instructions carefully on maximum storage time, any food, even the freshest will not remain edible for any extended amount of time.
- Contrary to popular belief, cooked foods do not store any longer than raw food.
- Do not place fluids in containers without covering them, this will lead to an increase in the level of moisture within the refrigerator, causing the formation of frost.
- Be careful not to place containers (plastic or glass), food or other items in direct contact with the cooling area of the interior back wall of the refrigerator. This could harm the food, increase energy consumption and facilitate the formation of condensate (on food, containers, etc.).

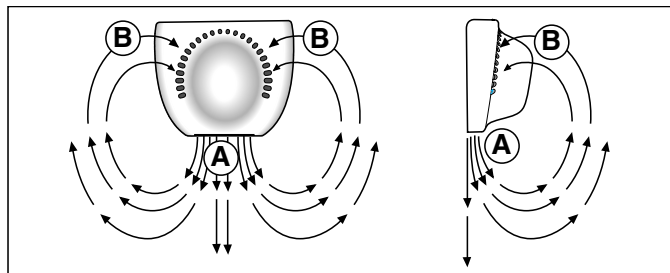

Hotter air is drawn in (B above). This air is cooled when it comes into contact with the refrigeration panel (A above).

The refrigerator compartment is equipped with practical slide-out shelves (Fig. 1) which can be adjusted for height using the appropriate guides. This feature allows you to store large containers and food products.

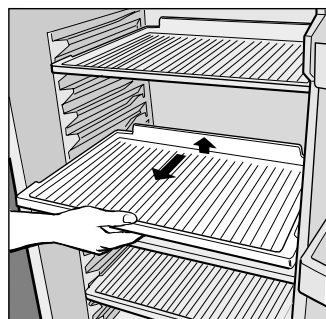
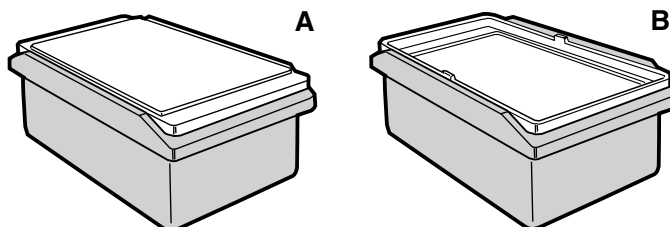

Fig. 1

To preserve meat, place the cover as indicated in Fig. A. To preserve cheese, overturn the cover and place it as indicated in Fig. B. This box is not supplied with some models.



## Storing Food in the Refrigerator Compartment

Food	Storage Time	Location in the Refrigerator
Wrapped meat and cleaned fish (use cling film or pack in plastic bags)	2 or 3 days	On the shelf above the vegetable crisper (which is the coldest area).
Fresh cheese	3 or 4 days	On the shelf above the vegetable crisper (which is the coldest area).
Eggs	1 month	In special egg rack on door.
Butter, margarine		On any shelf.
Cooked or precooked food (packed in air-tight containers and when cool store in refrigerator)	3 or 4 days	On any shelf.
Sausages, salami, sandwich meats in general, fresh pasta, custards, puddings, chocolates, cream pastries, bread, dry pastries, red tomatoes	3 or 4 days	On any shelf.
Bottled products, milk, drinks, yoghurt		On special door shelves.
Fruits and vegetables		In vegetable crisper.

## What Not to Store in the Refrigerator

Garlic (transmits odour), onions and leeks.  
 Bananas (they will turn black).  
 Citrus fruits.  
 Potatoes and root vegetables (store in dark, dry places).

## How to use the freezer compartment...

**For the preparation of food to be frozen, please consult a specialized manual.**

- Food that has been thawed, even partially, must not be re-frozen: you must cook it in order to consume it (within 24 hours) or to freeze it once again.
- When freezing fresh foods, remember that they should not touch other previously frozen or deep frozen foods. Place the food that you wish to freeze in the top compartment, where the temperature will fall below  $-18^{\circ}\text{C}$ , which is ideal for freezing food properly. Remember that proper conservation depends on the speed of freezing.
- The maximum amount of food you can freeze per day is indicated on the rating plate situated inside the refrigerator compartment.
- When using the appliance for the first time, or after it has been turned off, you can place food into it only after it has been running for 6-8 hours. Then put the fresh food into the appropriate compartments and turn the temperature control **(A)** to setting **3**. Freezing will be complete after approximately 24 hours.
- During the freezing process, avoid opening the door of the freezer.

- In order to freeze and then thaw foods optimally, it is recommended that you divide food into small portions so that they freeze quickly and uniformly. The packages should be clearly marked with the content and the date they were frozen.
- Do not open the freezer door in the event of a power failure or malfunction. This precaution will slow the rise in temperature within the compartment. If the door is not opened, frozen and fast-frozen foods will remain in their current state for approximately 9-14 hours.
- Do not place full bottles in the freezer: they could easily burst because all liquids increase in volume when they freeze.
- Fill ice trays so that they are no more than  $3/4$  full.
- If the room temperature remains below  $14^{\circ}\text{C}$  for a long period of time the freezer will not reach the temperatures required for storage and storage life will be shorter. In this case frozen food should be used within a relatively short period of time.

## ENERGY SAVING TIPS

### - Install the Appliance Correctly

This means that the appliance should be installed away from heat sources or direct sunlight in a well ventilated room.

### - Correct temperature settings

Set the refrigerator temperature to one of the middle settings. Very cold temperature settings will not only consume a great deal of energy but will neither improve nor lengthen the storage life of the food. Excessively cold temperatures may ruin vegetables and cheese.

### - Do not Overfill

Remember that proper storage of food requires good air circulation. Overfilling your appliance will hamper proper air circulation and overwork the compressor.

### - Keep the Door Closed

Open your doors only when necessary, remember that every time you open the door most of the cold air will be lost. To bring the temperature back to the proper level, the motor must run for a considerable amount of time, consuming a substantial amount of energy.

### - Check the Door Seals

Keep the seals clean and make sure that they fit tightly against the door. This alone will ensure that no cold air escapes.

### - No Hot Foods

A container of hot food in the refrigerator will increase the temperature significantly, allow food to cool to room temperature before storing.

### - Check your appliance for build up of ice

Check the thickness of the frost on the walls of the freezer and immediately defrost it if the layer becomes too thick. (see CARING FOR YOUR APPLIANCE).



# FOOD STORAGE

## Meat and Fish

Food	Wrapping	Tenderising (days)	Storage (months)	Thawing Time
Beef Roast	Tinfoil	2 / 3	9 / 10	Not required.
Lamb	Tinfoil	1 / 2	6	Not required.
Pork Roast	Tinfoil	1	6	Not required.
Veal Roast	Tinfoil	1	8	Not required.
Veal/Pork Chops	Each piece wrapped in cling film and then in tinfoil (4 to 6 slices)		6	Not required.
Veal/Lamb Cutlets	Each piece wrapped in cling film and then in tinfoil (4 to 6 slices)		6	Not required.
Mincing Meat	In aluminium containers covered with cling Film	Freshly minced	2	Slowly in refrigerator.
Heart and Liver	Plastic bags		3	Not required.
Sausages	Cling Film or Tinfoil		2	As necessary.
Chicken and Turkey	Tinfoil	1 / 3	9	Very slowly in refrigerator.
Duck and Goose	Tinfoil	1 / 4	6	Very slowly in refrigerator.
Pheasant, Partridge and Wild Duck	Tinfoil	1 / 3	9	Very slowly in refrigerator.

Film

Film

Plastic bags

Plastic bags

Film

Plastic bags

# FOOD STORAGE

## Fruits and Vegetables

Food	Preparation	Blanching Time	Wrapping	Storage (months)	Thawing Time
Apples and Pears	Peel and cut into slices.	2'	In Containers (cover with syrup)	12	In refrigerator very slowly.
Apricots, Peaches, Cherries and Plums	Peel and pit.	1' / 2'	In Containers (cover with syrup)	12	In refrigerator very slowly.
Strawberries Blackberries and Raspberries	Rinse and dry		In Containers (cover with sugar)	10 / 12	In refrigerator very slowly.
Cooked Fruit	Cut, cook and strain.		In Containers (add 10% sugar)	12	In refrigerator very slowly.
Fruit Juice	Wash, cut and crush.		In Containers (sugar to taste)	10 / 12	In refrigerator very slowly.
Cauliflower	Remove leaves, cut head into small pieces and blanch in water and a little lemon juice.	2'	Plastic bags	12	Not required.
Cabbage and Brussel Sprouts	Wash and cut into small pieces.	1' / 2'	Plastic bags	10 / 12	At room temperature.
Peas	Shell and wash.	2'	Plastic bags	12	Not required.
French Beans	Wash and slice if required.	2	Plastic bags	10 / 12	Not required.
Carrots, Peppers and Turnips	Peel, wash and slice if necessary.	3' / 4'	Plastic bags	12	Not required.
Mushrooms and Asparagus	Wash, peel and cut up.	3' / 4'	Plastic bags or Containers	6	At room temperature.
Spinach	Wash and mince.	2'	Plastic bags	12	At room temperature.
Vegetable for Soups	Wash and cut up in small pieces.	3'	Plastic bags or Containers	6 / 7	Not required.

Plastic bags

Plastic bags

# CARING FOR YOUR APPLIANCE

Before doing any cleaning, disconnect the appliance from the electricity (by pulling out the plug or turning off the general switch in your home).

## Defrosting

**WARNING: do not damage the refrigeration circuit. Do not use mechanical devices or instruments other than those recommended by the manufacturer to speed up the defrosting process.**

### How to Defrost the Refrigerator

This appliance defrosts automatically and the water is channelled to the back toward the drain installed for this purpose (fig. 2). Here, the heat produced by the compressor will make it evaporate. The only thing you must do is to periodically check and clean the hole of the drain, which is located behind the fruit and vegetable crisper, keeping it clear so that the water drains properly.

### How to Defrost the Freezer

- Remember to regularly remove the frost with the scraper provided (do not use knives or metal objects).
- If the frost is more than 15 mm thick, the freezer must be defrosted.

Proceed as follows:

- Turn the temperature control (A) to the ● setting.
- Then wrap all the frozen and fast-frozen food in news paper, placing it either in the refrigerator or in a cool place.
- Leave the freezer door open so that the frost thaws completely.
- You can speed this process by placing containers of warm water in the compartment.

Dry the compartment thoroughly.

To start up the appliance again, move the temperature control to the original operating position.

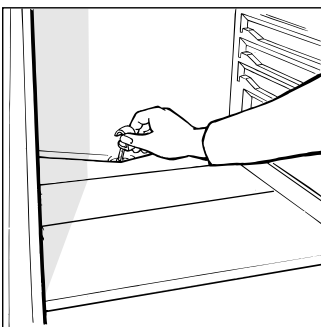

Fig. 2

## Cleaning and Special Maintenance

Before cleaning the appliance, first switch off and remove the plug from the socket.

- Your appliance is manufactured with hygienic, odourless materials. To preserve these characteristics, always use sealed containers to store foods, in order to prevent spills which could stain and cause unpleasant, difficult to remove odours.

- Use a water and bicarbonate solution to clean the appliance. Clean the interior and exterior with a sponge soaked in warm water and a sodium bicarbonate solution, which is, among other things, a good disinfectant. If you do not have any in the house, you can use a neutral soap.

- DO NOT use abrasive detergents, bleach or detergents containing ammonia. NEVER use solvent based products.

- All removable parts should be taken out and soaked in warm soapy water or detergent. Rinse and dry them thoroughly before putting them back in the appliance.

- When the appliance is not used for a long time, remember to clean the interior and dry thoroughly, leave the doors open to prevent the formation of mould and unpleasant odors.

- Replacing the light bulb. The bulb for lighting the interior of the refrigerator is located at the back of the thermostat box. When replacing the lamp, unplug the appliance from the electrical socket, unscrew the burned out lamp and replace it with another with a wattage no higher than 15W (fig. 3).

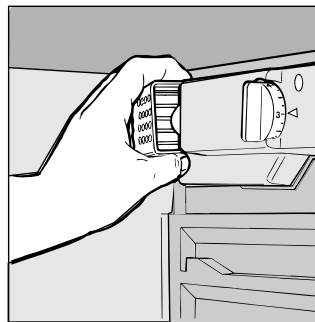

Fig. 3

# TROUBLESHOOTING

## Nothing works

*Check that:*

- The mains switch in your home is on.
- There has not been a power cut.
- The plug is properly inserted in the socket and is switched on.
- The socket is working; try another appliance in the socket to check.
- The fuse in the plug is ok - if not replace it, (see ELECTRICAL CONNECTION).

## The refrigerator and the freezer do not cool properly.

*Check that:*

- The doors close well and that the seals are not damaged
- The doors have not left open too long.
- The thermostat knob is on the correct setting.
- The refrigerator or freezer is not overfilled.

## The food inside the refrigerator is too cold

*Check that:*

- the temperature setting is too low (or not the best).
- The food is not in contact with the back wall - which is the coldest part.

## The motor runs constantly

*Check that:*

- the temperature control is on the correct setting.
- the doors have been open continuously.
- The room temperature is not too high.

## The appliance makes too much noise.

The gas refrigerant produces a slight noise even when the compressor is not running (this is not a defect).

*Check that:*

- The refrigerator is level.
- The appliance was installed between cabinets or objects that vibrate and make noise.

## There is water on the bottom of the refrigerator.

*Check that:*

- The hole for draining the water from the frost is clogged (see fig. 2).

If after all the checks, the appliance still does not operate or the problem persists, call Hotpoint Service (see KEY CONTACTS, back page) and inform them of: the type of problem, the abbreviation of the model name (Mod.) and the relative numbers (S/N) written on the rating plate located at the bottom left next to the vegetable crisper.

***Never call on unauthorized technicians and always refuse spare parts which are not originals.***

# NOTES



## After Sales Service

**"No company is better positioned to offer an after sales service on a Hotpoint appliance than us - the manufacturer"**

As part of our commitment to you, all Hotpoint appliances have the added benefit of a fully inclusive parts and labour guarantee for the first 12 months. In addition to this you also have the advantage of **free replacement parts for the first 5 years** when fitted by a Hotpoint engineer. When the 12 months parts and labour guarantee expires we offer the following after sales service options:

### Repair Service and Information Help Desk

UK: 08709 066066

[www.theservicecentre.co.uk](http://www.theservicecentre.co.uk)

Republic of Ireland: 1850 302 200

Note: Our operators will require the Model number and the Serial number of your appliance

Available 364 days a year with a fast, effective and value for money service. We have the largest white goods repair service in the UK with over 1200 of our own fully trained engineers. All repairs include a parts and labour guarantee for 12 months from the date of the repair.

If you require any information or have any questions about your appliance, our operators are on hand with help and advice.

All this ensures that you will receive the best available after sales service possible.

### Extended Warranties

UK: 08709 088 088

[www.theservicecentre.co.uk](http://www.theservicecentre.co.uk)

Republic of Ireland: 1850 502 200

Whether you have just one or a number of Hotpoint appliances in your kitchen, we offer two service cover plans to give you total peace of mind.

- Repair Protection Plan - FREE service repairs for a single Hotpoint appliance during the period of cover.
- Kitchen Cover - FREE service repairs for all your Hotpoint appliances less than 8 years old.

**Genuine Parts and Accessories** UK: 08709 077 077

[www.theservicecentre.co.uk](http://www.theservicecentre.co.uk)

Republic of Ireland: (01) 842 6836

A wide range of genuine parts and accessories are available from our hotline or through our web site.

**Genuine parts and accessories, extended warranties and service repairs are all available on our web-site at:**



[www.theservicecentre.co.uk](http://www.theservicecentre.co.uk)





## Guarantee

### "Satisfaction guaranteed or your money back"

We give you a unique 'satisfaction guaranteed' promise - **valid for 90 days** - after you have purchased your Hotpoint appliance. If there is a technical problem simply call Hotpoint Repair service or visit our web-site at [www.theservicecentre.co.uk](http://www.theservicecentre.co.uk) and where necessary, we will arrange for an engineer to call. If the technical problem is not resolved under this guarantee, **we will replace your machine or, if you prefer, give you your money back.**

All Hotpoint appliances carry a fully inclusive 12 month parts and labour guarantee as well as free replacement parts for the first 5 years (except microwaves, selected integrated appliances and cooker hoods, which have a one year guarantee) provided that they are fitted by a Hotpoint engineer.

#### Guarantee terms and conditions

Your guarantee is only applicable in the United Kingdom or Republic of Ireland and is subject to the following provisions that your appliance:

- Has been installed and used correctly in accordance with this instruction booklet.
- Has been used solely for domestic purposes and is located on domestic premises (ie. not for commercial or trade use).
- Has been properly connected to a suitable electrical supply voltage as stated on the appliance rating plate.
- Has not been subject to misuse, accident, modified or repaired by anyone other than one of our own service engineers.

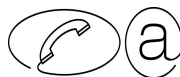

For pre purchase information on any other Hotpoint product call: 08701 50 60 70  
or visit: [www.hotpoint.co.uk](http://www.hotpoint.co.uk)



## Recycling & Disposal Information

As part of Hotpoint's continued commitment to helping the environment, Hotpoint reserves the right to use quality recycled components to keep down customer costs and minimise material wastage.

Please dispose of packaging and old appliances carefully.

To minimise risk of injury to children, remove the door, plug and cut mains cable off flush with the appliance. Dispose of these parts separately to ensure that the appliance can no longer be plugged into a mains socket, and the door cannot be locked shut.



## Key Contacts

### After Sales Service

Over 1200 trained specialists, directly employed by us, ensure that you can have complete confidence in both the appliances and services we offer.



### Repair Service and Information Desk

UK: 08709 066 066

(Open 8 to 8 Mon - Fri, 8 to 6 Sat, 10 to 4 Sun & Bank Holidays)

[www.theservicecentre.co.uk](http://www.theservicecentre.co.uk)

Republic of Ireland: 1850 302 200

Note: Our operators will require the following information:

Model number:

Serial number:

### Extended Warranties

UK: 08709 088 088

(Open 8 to 8 Mon - Sun)

[www.theservicecentre.co.uk](http://www.theservicecentre.co.uk)

Republic of Ireland: 1850 502 200

### Genuine Parts and Accessories

UK: 08709 077 077

(Open 8-30 to 5-30 Mon - Fri & 9 to 12 Sat)

[www.theservicecentre.co.uk](http://www.theservicecentre.co.uk)

Republic of Ireland: (01) 842 6836



## Free Manuals Download Website

<http://myh66.com>

<http://usermanuals.us>

<http://www.somanuals.com>

<http://www.4manuals.cc>

<http://www.manual-lib.com>

<http://www.404manual.com>

<http://www.luxmanual.com>

<http://aubethermostatmanual.com>

Golf course search by state

<http://golfingnear.com>

Email search by domain

<http://emailbydomain.com>

Auto manuals search

<http://auto.somanuals.com>

TV manuals search

<http://tv.somanuals.com>