



**User Instructions
for Models
RLB20, RSB20, RZB20**

Electrical Supply

WARNING: This appliance must be earthed.

Fuses

Your appliance comes fitted with a plug and a 13A fuse. If you need to replace the fuse, only those rated at 13A and ASTA approved to BS1362 should be used.

WARNING: Do not use the plug unless the fuse cover is fitted.



Changing the plug

Cut off and dispose of the supplied plug if it does not fit your socket.

WARNING: To avoid a shock hazard do not insert the discarded plug into a socket anywhere else.

IMPORTANT: WIRES IN THE MAINS LEAD ARE COLOURED IN ACCORDANCE WITH THE FOLLOWING CODE:

Green / Yellow - Earth
Blue - Neutral
Brown - Live

If you change the plug, the colour of the wires in the mains lead may not correspond with the colour of the markings identifying terminals in the plug. You should therefore wire it as shown.

Green and yellow (Earth) wire to terminal marked 'E', symbol , or coloured green and yellow.

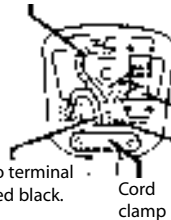

Blue (Neutral) wire to terminal marked 'N' or coloured black.

13A ASTA approved fuse to BS1362.

Brown (Live) wire to terminal marked 'L' or coloured red.

Changing the Mains Lead

A special lead can be ordered from your Service Department:

UK: 08709 066 066 or

Republic of Ireland: 1850 302 200

If you have damaged the existing lead or require a longer one a charge will be made. It is strongly advised that this work is carried out by a qualified electrician.



CE marking certifies that this appliance conforms to the following EEC directives:-

Low Voltage Equipment - 72/23/EEC & 93/68 EEC

Electromagnetic Compatibility - 89/336/EEC, 92/31/EEC & 93/68/EEC

Retention of the instruction Book

This instruction Book must be kept handy for reference as it contains important details on the safe and proper use of the appliance.

If you sell or pass the appliance to someone else, or move house and leave it behind, make sure this Book is also provided so the new owner can become familiar with the appliance and safety warnings.

Contents

	Page
Electrical requirement	2
Safety advice	4
Installation	5
Get to know your Appliance	6-7
The controls	8
Storing food	9
Other functions	10
Care & Cleaning	10-12
Door reversal	13
Troubleshooting	14
After sales service	15
Guarantee	16
Disposal of your old product	17
Key contacts	rear cover

Safety advice

- * **Please take time to read this booklet before installing and switching on this appliance. The manufacturer assumes no responsibility for incorrect installation and usage.**
- * If this appliance is to replace an old refrigerator with a lock, break or remove the lock as a safety measure to avoid the danger of children playing with the refrigerator and locking them inside.
- * Old refrigerators and freezers contain insulation gases and refrigerant that must be disposed of properly. Please ensure that none of the tubing at the back of the appliance gets damaged.
- * Do not twist and bend the mains lead and keep it away from hot surfaces.
- * Do not let children play with the appliance.
- * Do not sit or stand on the appliance.
- * Do not use sharp metal objects for removing any ice build up in the freezer compartment, as this could cause damage to the refrigeration system.
- * Do not put the plug into the power supply with wet hands.
- * Do not store carbonated (fizzy) drinks or medicines in the freezer compartment.
- * Do not eat iced lollipops or other such things direct from the freezer compartment as this could cause low temperature skin burns, always leave for a few minutes before eating.
- * Do not touch the surfaces inside the freezer compartment with wet hands as this could cause low temperature skin burns.

Installation.

WARNING: THE APPLIANCE SHOULD ONLY BE INSTALLED BY A QUALIFIED ELECTRICIAN IN COMPLIANCE WITH THESE INSTRUCTIONS, CURRENT STANDARDS AND REGULATIONS.

Before Fitting:

Before connecting to the electricity supply leave the appliance to stand for 1 hour to allow the cooling system to settle.

Please read through this section before starting any work.

Choosing a location:

The power socket should be in a readily accessible position, adjacent to the appliance. Place the appliance in a dry and regularly ventilated room.

Never place the appliance near heat emitting devices (eg. cooker, radiator, water heater or similar devices) and do not expose it to direct sunlight. In such a position your appliance will have to work harder and will cost more to run and could be damaged by the heat. Ensure that you provide adequate air circulation around the appliance. Behind, there should be at least 200cm².

Allow a minimum 30mm between the top of the appliance and the underside of the work top, 25mm either side and 25mm from the base of appliance to the floor.

Placing the appliance:

Place it on a solid base.

Use the adjustable feet to level the appliance. Check using a spirit level and adjust the feet accordingly.



Fitting the wall spacer

1. Fit the supplied wall spacer to the top middle of the condenser at the back of the appliance
2. Push appliance back, until spacer is against the wall.



Get to know your Appliance.

Model RSB20

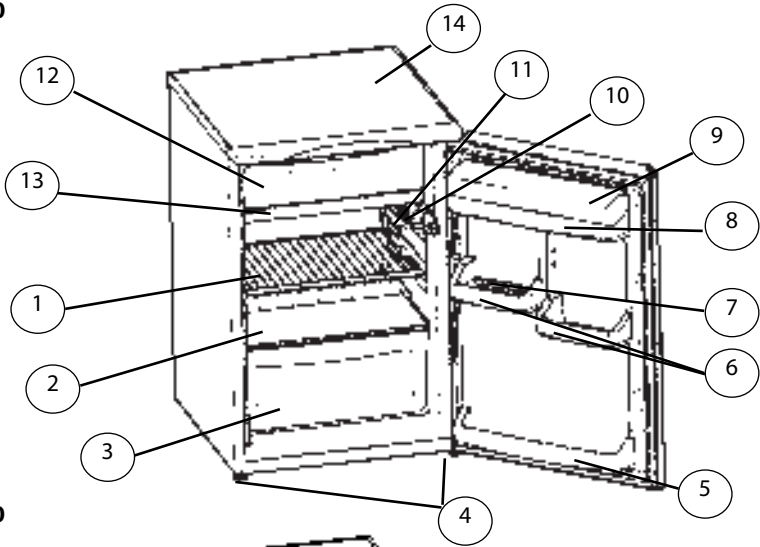

Model RLB20

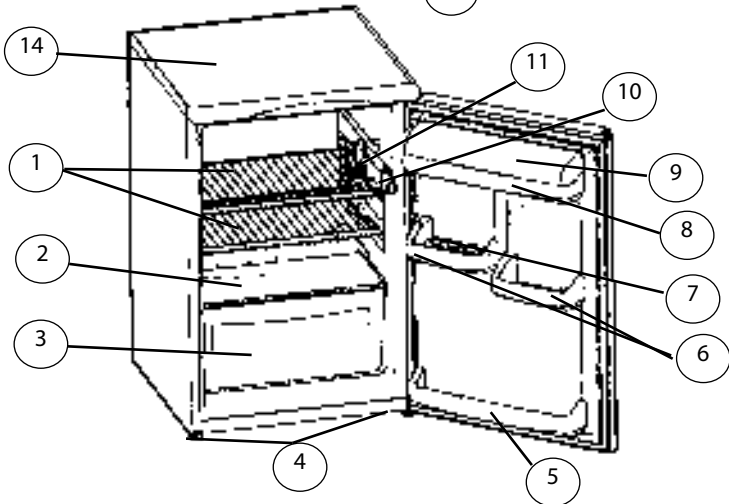

1. Refrigerator shelf
2. Safety glass
3. Salad bin
4. Levelling feet
5. Bottle rack
6. Commodity racks
7. Egg holder
8. Dairy rack

9. Dairy rack cover
10. Lamp switch
11. Thermostat box
12. Freezer compartment (*)
13. Water tray (*)
14. Table top

(*) Only in model RSB20

Get to know your Appliance.

Normal setting; 2



Model RZB20

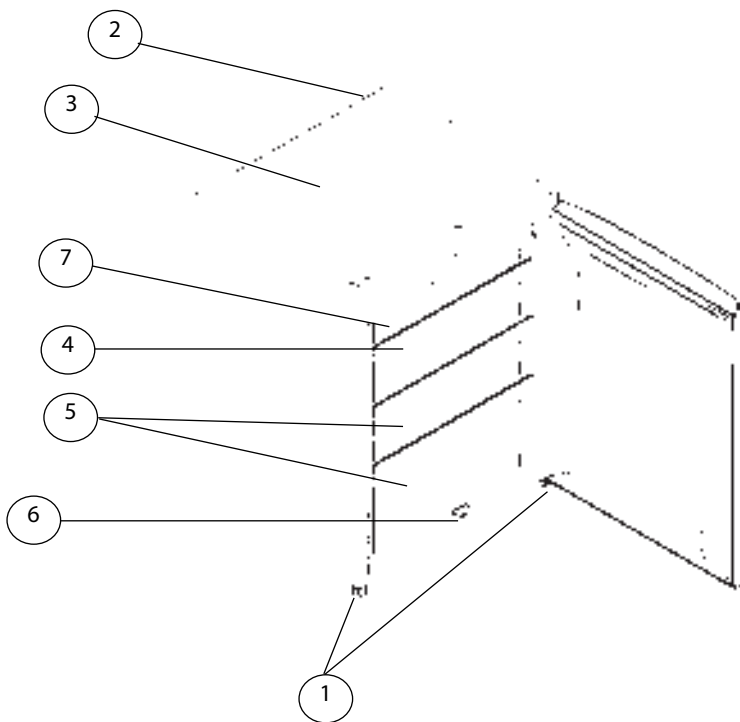

- | | |
|-------------------|--------------------------------|
| 1. Levelling feet | 4. Fast freeze compartment |
| 2. Controls | 5. Frozen food storage baskets |
| 3. Table top | 6. Defrost channel |
| | 7. Ice compartment shelf |

The controls

Before switching on your appliance make sure that the mains cable is not trapped underneath or behind the appliance.

Thermostat setting

The thermostat setting will depend on the location of the appliance, room temperature and how often the door is opened. When starting the appliance for the first time turn the thermostat to the **5** setting for the first 24hrs then adjust accordingly.

- * The thermostat automatically regulates the inside temperature of the refrigerator and freezer compartment. By turning the knob from **1.** to **5.**, colder temperatures can be obtained.
- * The "OFF" position shows that the thermostat is closed and no cooling is available.
- * For short term storage of food in the freezer compartment, you can set the knob to the **3** setting.
- * For long term storage of food in the freezer compartment, you can set the knob between the **3 and 5** position.
- * **Note: The ambient temperature, temperature of the freshly stored food and how often the door is opened, affects the temperature in the refrigerator and freezer compartments. If required, change the temperature setting.**
- * *Ideally, when you first switch on the appliance, you should try to run it without any food in for 24 hours and not open the door. If you do need to use it straight away try not to put to much food inside.*

Running in the compressor

Your appliance is operated by a compressor, which maintains the appliance internal temperature. For the first few months the compressor has to work a little harder and may result in more noise than usual.

- * *If the appliance is switched off or unplugged, you must allow 5 minutes before restarting in order not to damage the compressor.*

Refrigerator RSB20

- * The freezer of the refrigerator can cool up to -12°C .

RLB20 and RSB20 thermostat box

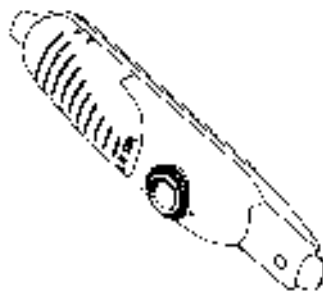

Freezers RZB20

Thermostat setting

The freezer thermostat automatically regulates the inside temperature of the compartments. By turning the knob from position 1 to 3, colder temperatures can be obtained. The position "O" (off position) shows that the thermostat is closed and no cooling will be available.

Freezer thermostat setting

The temperature in your freezer should be maintained at -18°C or colder. The ambient temperature of the freshly stored food and how often the door is opened, affects the temperature in the freezer. If required, change the temperature control setting at the rear of the freezer (setting 3 is the coldest.).

Storing food

Making the best use of your Appliance

To ensure that your appliance operates as efficiently as possible:

- * Follow packaging "best by/use by" instructions or your suppliers advice on a suitable maximum storage time.
- * Keep foods covered to retain moisture and prevent flavour/odour transference. Plastic bags, aluminium foil, plastic stretch wrap and containers with lids are ideal.
- * Select chilled and frozen food last when shopping, transport in a 'coolbag' and place in appliance as soon as possible after arriving home.
- * Avoid opening the doors unnecessarily or for longer than needed.
- * Allow hot or warm food to cool down in covered containers before placing in appliance, as placing hot food in the appliance reduces efficiency.

Warning: Do not use to store poisonous, flammable or dangerous substances, your appliance has been designed for the storage of edible foodstuffs only.

Storing food in a freezer (RZB20)

- * Freeze and store either fresh food or long term commercially frozen foods.
- * Generally speaking long term storage means up to 3 months but this can vary, so always follow your supplier's recommendations otherwise refer to the pictorial guide on the door liner (see below).



- * Place frozen food in the freezer compartment as soon as possible after buying it.
- * Liquid-filled bottles or sealed fizzy drinks must not be stored in freezer, as they may burst.
- * Lollipops and water ices should not be given to children directly from the freezer. The low temperature may cause 'freezer burns' on their lips.
- * Store ice cream towards the top front of the freezer and remove from freezer 15-30 minutes before serving.
- * Ensure food is labelled and dated before placing in freezer.
- * Once thawed, food should be cooked and eaten within 24 hours or cooked and refrozen.
- * Fully defrost your freezer when the ice is between 3-5mm thick.

Note: A thick layer of ice will increase the running costs of your appliance.

Storing Food in a Fridge (RSB20 and RLB20)

- * Pack and store cooked and fresh food separately.
- * Wrap raw or defrosting meat and poultry in polythene or foil and store below cooked foods and dairy products to avoid contamination of dripping food juices.
- * Wrap cheese in greaseproof paper and place in an airtight polythene bag. Bring to room temperature before consuming.
- * Empty left over canned food into a covered storage containers before placing in fridge.
- * Position food to allow cold air to circulate freely, ensuring nothing comes into contact with the cooling plate at the back of the appliance.

Other functions

Fridge compartment chiller tray cold air control (model no. RSB20)

The slide at the rear of the chiller tray controls the amount of cold air that flows into the fridge compartment. The chiller tray must be pulled out of the fridge in order to adjust the slide.

Fridge compartment too warm:

Open the slide at the rear of the chiller tray (indicator pointer visible). If the fridge compartment is still too warm, turn the thermostat control to a colder setting (higher number).

Fridge compartment too cold:

Close the slide at the rear of the chiller tray (indicator pointer covered). If the fridge compartment is still too cold, turn the thermostat control to a warmer setting (lower number).

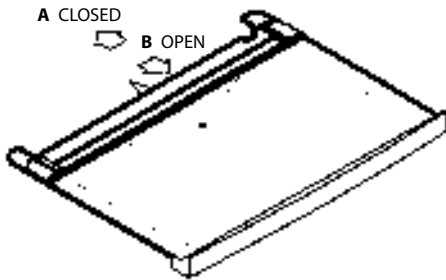

Warmer fridge setting:
Indicator pointer covered **A** = closed.

Colder fridge setting:
Indicator pointer visible **B** = open.

Care & Cleaning

- * **Disconnect the appliance from the power supply.**
- * Do not pour water over the appliance.
- * The internal compartments should be cleaned periodically using a solution of bicarbonate of soda and warm water.
- * Clean the accessories separately with soapy water. **Do not put in a dishwasher.**
- * Do not use abrasive products, detergents or soaps. After washing, rinse with clean water and dry carefully. When the cleaning operations have finished, reconnect the plug with **dry hands**.
- * You should clean the condenser at least twice a year in order to save energy and increase productivity.



Replacing the light bulb

When replacing a bulb;

1. unplug the appliance from the power supply.
2. Press the hooks on the sides of the light cover top and remove the light cover.
3. Replace the bulb with a new one of not more than 15W.
4. Replace the light cover and after waiting 5 minutes restart the appliance.



Care & Cleaning

For model no. RSB20 Refrigerator

Defrosting the Frozen Food compartment:

WARNING: Never use sharp metal tools for this operation as they can damage your fridge beyond repair.

Defrosting should be carried out regularly - either, every two or three weeks or when the ice is between 3 - 5mm thick. This will ensure that your appliance operates efficiently. A build up of ice could cause damage to the freezer door flaps or create incorrect temperatures inside the fridge compartment.

- * The day before you plan to defrost, set the thermostat dial to the **5.** position to completely freeze the contents.
- * During defrosting, frozen foods should be wrapped in several layers of paper and kept in a cool place. The inevitable rise in temperature will shorten their storage life. Remember to use these foods within a relatively short period of time.
- * Before defrosting pull out the water tray (2) and place a bowl (3) underneath the tray hole to collect the water. Ensure you use a bowl large enough to contain the water.
- * To defrost the fridge turn the thermostat control knob to the **O (OFF)** position or you may switch off the appliance at the mains socket and pull the plug out.

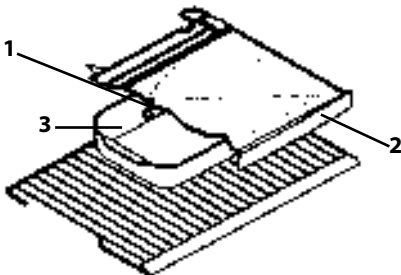

- * To accelerate the process, leave the door open and one or more basins of warm water can be placed in the freezer compartment.
- * Dry the inside of the unit and water tray, refit the tray plug and set the thermostat knob to the **5.** position.

Defrosting

For model no. RLB20 Larders (coolers)

- * The fridge compartment will defrost automatically. During defrost periods water droplets form on the cooling plate and refreeze afterwards.

Note: If your kitchen becomes exceptionally warm, the cooling plate may not defrost regularly.

WARNING: Ensure the gutter is kept clear and that stored food does not come into contact with the cooling plate.

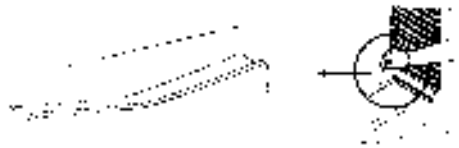

Care & Cleaning

Defrosting the Freezer RZB20

Do not use sharp metal objects for this operation. They could puncture the refrigerator circuit and cause irreparable damage to the unit.

Before defrosting, place the frozen food in a cool place after wrapping it in sheets of newspaper.

Use the drainage system as follows;

1. To defrost the freezer turn the thermostat control knob to the **O (OFF)** position or you may switch off the appliance at the mains socket and pull the plug out.
2. Pull out the bottom drawer of the freezer and open the water drain cover (A) which is at the back of the drawer. (FIGURE 1)
3. Pull out the drain plug (B) placed under the freezer compartment (FIGURE2)
4. Place the water drain cover (A) beneath the drain plug (B) (FIGURE 3).
5. Take out the water collected in the drawer.

- * To accelerate the defrosting process place one or more basins of warm water in the freezer compartment.
- * Dry the inside of the compartment with a sponge or a clean cloth.
- * Once the unit has been defrosted, place the food into the freezer .

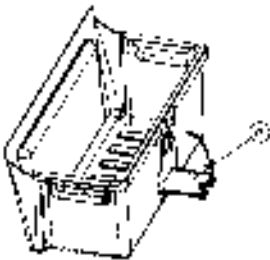

FIGURE -1-

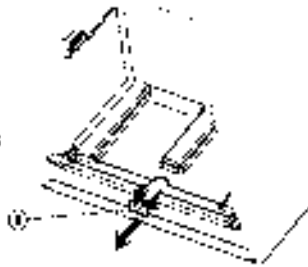

FIGURE -2-

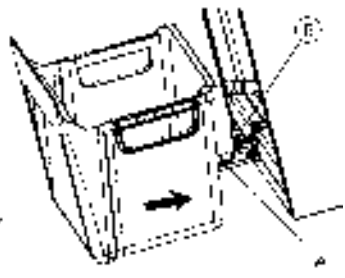

FIGURE -3-

Door reversal

Warning: Before attempting to remove the door, switch off the electrical supply and pull out the mains plug.

It is recommended that you remove any loose items/fittings from inside the appliance and place food into insulated containers whilst carrying out this operation.

You may require assistance to carefully lay the appliance onto its back onto suitable protective materials (i.e. original packaging).

Remove the door

1. Lay down the appliance on its back.

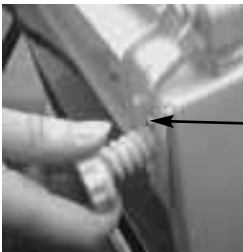

2. Unscrew, remove and retain both front feet.
3. Unscrew and remove the right hand bottom hinge plate and (spacing washers if fitted).

Reposition the hinge pin into the other hole on the metal bracket.

4. Slightly open the door, slide downwards, remove and carefully place to one side.
5. Unscrew the hinge pin from the top right hand hinge plate and refit on the opposite side.

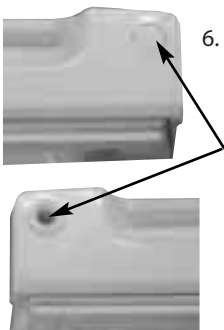

6. Use a thin blunt instrument to remove the top and bottom hinge bushes and blanking plug from the door (take care not to mark the door handle). Reposition on the opposite side.

Replace the door

1. Slide the door upwards and locate the top hinge pin into the door bush.
2. Fit the bottom hinge with the (spacing washers if fitted) into the bottom hinge bush, making sure that the door is aligned to the cabinet.
3. Use the fixing screws to secure the bottom hinge to the cabinet.
4. Replace the adjustable feet, allowing 25mm from the bottom of the cabinet to the base of the foot.
5. Carefully stand the appliance upright in its required location and make sure it is sitting level on the floor. Open and close the door checking that the gasket makes a good seal without any gaps when the door is closed.

Note: Replace loose items/fittings back into the appliance and leave for at least 15 minutes before switching back on.

Troubleshooting.

If your appliance is not working properly, it may be a minor problem, therefore check the following.

The appliance won't work.	Check the plug is firmly positioned in the wall socket and the power supply is switched on. Check that the thermostat setting is not in the OFF position. Check the power supply with another appliance. Check the fuse.
There has been a power failure.	DO NOT OPEN THE DOOR. If power does not return within 14 hours, food should be removed from the low temperature compartment and either cooked and eaten within 24 hours or cooked and refrozen.
The appliance is making a lot of noise.	Check the appliance is stabilised. Ensure the appliance is not touching the wall or kitchen units. It is normal for it to make a bubbling or gurgling sound.
Continuous Operation of the Compressor	Has the door been opened frequently or left open for a long period of time? The door is not closed properly/does not seal properly (clean the gasket if it is contaminated or replace it if it is damaged). Check there is adequate air circulation.
Water is leaking from the refrigerator.	Check that the defrost water outlet is not blocked. Check that stored food or packaging is not in contact with the cooling plate on the interior rear wall of the refrigerator. (NB. It is normal for droplets to run down the cooling plate). Is there ice formation on the interior rear wall? (see 'Defrosting of the Frozen Food compartment').
Refrigerator interior light does not work.	SWITCH OFF AT THE SOCKET AND PULL OUT THE MAIN PLUG, check the bulb is in correctly. If it still doesn't work see 'Changing the Light Bulb'.

If the appliance is not going to be used for a long time (during holidays) set the thermostat to the OFF position. Defrost, then clean the appliance and leave the door open to prevent the formation of mildew and build up of odours.

Hotpoint After Sales Service

Satisfaction Guaranteed or Your Money Back

Hotpoint gives you a unique 'Satisfaction Guaranteed' promise – valid for ninety days after you have purchased your Hotpoint product. If there is a technical problem with your Hotpoint appliance, call Hotpoint Service. If necessary we will arrange for an engineer to call. If the technical problem is not resolved under this Guarantee, Hotpoint will replace your appliance or, if you prefer, give you your money back.

Hotpoint appliances carry for the first 12 months a fully inclusive parts and labour guarantee plus FREE replacement parts for the first 5 years provided that they are fitted by our own Service Engineer. When the 12 months parts and labour guarantee expires we offer two after sale service options:

Repair Service

UK: 08709 066 066 or

Republic of Ireland: 1850 302 200

Call our National Service Line and benefit from our additional 5 years FREE parts.

Although the engineers time and labour is chargeable, all repairs carry a fully inclusive parts and labour guarantee for 12 months from the date of the repair. **Note:**

Chargeable service is offered on the basis of payment on completion to our service engineer, who will issue a receipt.

Extended Warranties

To join: UK 08709 088 088 or

Republic of Ireland: 1850 502 200

Whether you have just one or a number of Hotpoint appliances in your kitchen, Hotpoint offer two Service Cover Plans to give you complete peace of mind. They enable you to extend your first 12 months labour guarantee by either 1 or 4 years, so that you can have FREE repairs during the membership period.

Service Cover

FREE service repairs for a single Hotpoint appliance during the period of cover. At an additional cost Service Cover with Maintenance includes an Annual Electrical & Safety Check along with replacement of any parts necessary.

Kitchen Cover

An annual payment covers repairs for all your Hotpoint appliances which are less than ten years old. Additional Hotpoint appliances purchased after you have joined Hotpoint Kitchen Cover are automatically included during the annual period of cover without further charge.

Easy Payment Methods

We offer a number of payment methods; cheque, credit card, switch, cash or by taking advantage of one of our Service Cover Plans you can spread the cost by direct debit.

For further details telephone:

08709 088 088.

Appliance Registration

To benefit from the above options, complete and return the Appliance Registration Questionnaire supplied with this appliance. Full details and costs of our Service/Kitchen Cover options together with an application form, will then be sent to you towards the end of the 12 month guarantee period.

Hotpoint Genuine Parts & Accessories

A wide range of parts and accessories are available from Hotpoint Genuine Parts & Accessories Mail Order Hotline

UK: 08709 077 077 or

Republic Of Ireland: 01 842 6836

Hotpoint Guarantee

From the moment your appliance is delivered, Hotpoint guarantees it for five years.

- Hotpoint appliances carry a fully inclusive 12 months parts and labour guarantee plus FREE replacement parts for the first five years provided that they are fitted by our own Service Engineer (evidence will be required of date and place of purchase).
- All Hotpoint servicing is carried out by our own Service Organisation located throughout the United Kingdom and Republic of Ireland. We will be happy to deal with any problems which you may have.

Our Engineers ensure every effort to avoid damage to floor coverings and adjacent units when carrying out repairs/service work, but in locations where the Engineer advises you that it will be impossible to move appliances without risk of damage, they will only proceed with your approval that no liability is accepted.

Guarantee Terms & Conditions

Your Guarantee is only applicable in the United Kingdom or Republic of Ireland and is subject to provision(s) that your appliance:

- Has been used solely for domestic purposes and is on domestic premises ie. not for commercial or trade use.
- Has been used solely in accordance with this instruction book.
- Has been properly connected to a suitable electrical supply voltage as stated on the appliance rating plate.
- Has not been subject to misuse, accident, modified or repaired by anyone other than our own Service Engineers.

Disposal of your old product

When replacing your old appliance with a new one, please comply with the following: Old appliances are not worthless rubbish. Valuable raw materials can be reclaimed by recycling old appliances.

Render your old appliances unusable:

1. Pull out the mains plug.
2. Cut off the power cord and discard with mains plug.
3. To prevent children from locking themselves in the appliance and suffocating.

- REMOVE THE LOCK.

Professional disposal is required for refrigerants in refrigeration appliances and gasses contained in the insulation. Ensure that refrigeration tubing and coils are not damaged or punctured prior to their proper disposal.

WARNING: AVOID ACCIDENTS TO CHILDREN. WHEN DISCARDING AN OLD FRIDGE OR FREEZER BE CERTAIN TO MAKE THE LOCK UNUSABLE. IF POSSIBLE, REMOVE THE DOOR AND DISCARD SEPARATELY. DO NOT ATTEMPT TO SIT ON TOP OF YOUR APPLIANCE. IT IS NOT DESIGNED FOR SUCH USE AND YOU COULD INJURE YOURSELF OR DAMAGE THE APPLIANCE BY SUCH ABUSE.

Key Contacts

Service

Hotpoint has the largest appliance manufacturer's service team in Europe, trained specialists directly employed by us to ensure your complete confidence.

Repair Service

UK: 08709 066 066

Republic of Ireland: 1850 302 200

You will be asked for the following information:-

Name, address and postcode.

Telephone number

Model / Serial number of the appliance

Clear and concise details of the query or fault

Place and Date of purchase

(Please keep the receipt as evidence will be required when the engineer calls).

Extended Warranty

To join: UK 08709 088 088

Republic of Ireland: 1850 502 200

Genuine Parts & Accessories Mail Order Hotline

UK: 08709 077 077

Republic of Ireland: (01) 842 6836

For further product information 08701 50 60 70

All Hotpoint Services are offered as an extra benefit and do not affect your statutory rights.



General Domestic Appliances Limited, Morley Way, Peterborough, PE2 9JB

Free Manuals Download Website

<http://myh66.com>

<http://usermanuals.us>

<http://www.somanuals.com>

<http://www.4manuals.cc>

<http://www.manual-lib.com>

<http://www.404manual.com>

<http://www.luxmanual.com>

<http://aubethermostatmanual.com>

Golf course search by state

<http://golfingnear.com>

Email search by domain

<http://emailbydomain.com>

Auto manuals search

<http://auto.somanuals.com>

TV manuals search

<http://tv.somanuals.com>