



kitchen think

# **Instructions for Installation and Use**

**Electric Hood  
Model HX901X**

**To the Installer**

**Before installation fill in the product details on the back cover of this book.  
The information can be found on the rating plate.**

**To the User**

**You must read the instructions prior to installing and using the appliance and  
then retain them for future reference.**

# CONTENTS

---

RECOMMENDATIONS AND SUGGESTIONS	3
INSTALLATION	4 - 7
GETTING TO KNOW YOUR COOKER HOOD	8
CARE AND CLEANING	9-11
AFTER SALES SERVICE	14
GUARANTEE	15
KEY CONTACTS	Back Cover



CE marking certifies that this appliance conforms to the following EEC directives:-

- Low Voltage Equipment 72/23/EEC
- Electromagnetic Compatibility 89/336/EEC

## Retention of this Instruction Book

This Instruction Book must be kept handy for reference as it contains important details on the safe and proper use of the appliance.

If you sell or pass the appliance to someone else, or move house and leave it behind, make sure this Book is also provided so the new owner can become familiar with the appliance and safety warnings.

If the Book is lost or damaged a copy may be obtained from:  
GDA LTD., Morley Way, Peterborough, PE2 9JB

# RECOMMENDATIONS AND SUGGESTIONS

Using your new Cooker Hood is very simple. Nevertheless, to get the best results it is important that you read this manual thoroughly before installing and using your appliance for the first time.

## INSTALLATION

- All installation and repairs should be carried out by a qualified technician in accordance to regulations in force.
- The manufacturer will not be held liable for any damage resulting from incorrect or improper installation.
- After having removed the packaging, check the condition of the appliance, if in any doubt, do not use and contact Hotpoint Service (see Key Contacts, back page).
- The minimum safety distance between the hob and the extractor hood is 700 mm.
- Check that the mains voltage corresponds to that indicated on the rating plate fixed to the inside of the hood.
- Connect the extractor to the exhaust flue through a pipe of minimum diameter 120 mm. The route of the flue must be as short as possible.
- Do not connect the extractor hood to exhaust ducts carrying combustion fumes (boilers, fireplaces, etc.).
- If the extractor is used in conjunction with non-electrical appliances (e.g. gas burning appliances), a sufficient degree of ventilation must be guaranteed in the room in order to prevent the backflow of exhaust gas. The kitchen must have a suitable vent to the outside of the building, so that clear fresh air can circulate through the kitchen.

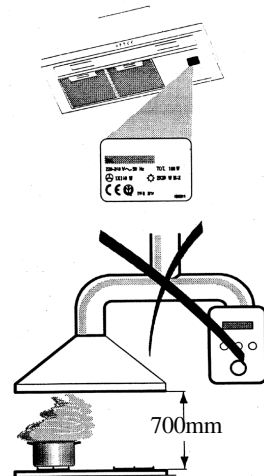

## USE

- The extractor hood has been designed exclusively for domestic use to eliminate kitchen smells.
- Never use the hood for purposes other than for which it has been designed.
- Never leave high naked flames under the hood when it is in operation.
- Adjust the flame intensity to direct it onto the bottom of the pan only, making sure that it does not engulf the sides.
- Deep fat fryers must be continuously monitored during use: overheated oil can burst into flames.
- When frying, never leave the pan unattended.
- The hood should not be used by children or persons not instructed in its correct use.

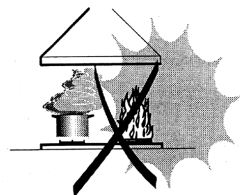

## MAINTENANCE

- Switch off and unplug the appliance from the mains supply before carrying out any cleaning or maintenance work.
- Clean regularly (see Care and Cleaning section), build up of dirt and grease could cause a fire hazard.

# INSTALLATION

## Assembly Instructions

The accessories required for the installation of the hood can be found inside the packaging. The hood is convertible and can therefore be installed for use in either the **OUTDOOR VENTING** mode or the **AIR RECIRCULATION** mode. If the hood is used in the **OUTDOOR VENTING** mode, connect opening 'N' (Fig.1) to an exhaust duct connected directly to the outside and which is 150cm<sup>2</sup> minimum in cross-section. The lowest part of the hood should be at least 70cm from the hob.

- IN NO CASE WHATSOEVER SHOULD THE HOOD BE CONNECTED TO EXHAUST DUCTS FROM OTHER APPLIANCES THAT RUN ON ENERGY SOURCES OTHER THAN ELECTRICITY (water heaters, boilers, stoves etc.). The hood must not be placed above stoves with a top radiant hob.
- There are 3 main types of supports for anchoring a hood onto a wall. As a rule each hood has two main anchoring points, one at either side on the back of the hood.

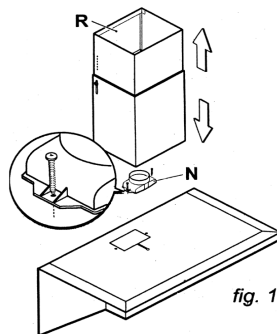
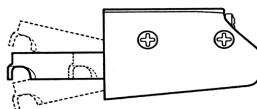

fig. 1



1st TYPE OF SUPPORT

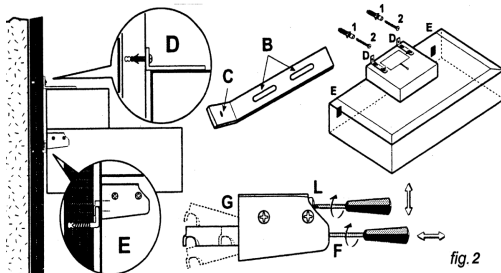

fig. 2

1ST TYPE OF SUPPORT

- This support is assembled onto the hood and allows for the adjustment of the hood both vertically (screw L, Fig.2) and horizontally (screw F, Fig.2). For the installation, L-shaped hooks must be fastened to the wall (see E, Fig.2).

2ND TYPE OF SUPPORT

This support is already assembled on the cooker hood and only allows vertical adjustment, by turning the screw situated on the high part of the hood (see Side b). L-shaped hooks must be fastened to the wall for installation.

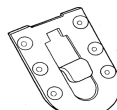

2nd TYPE OF SUPPORT Side a

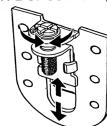

2nd TYPE OF SUPPORT Side b

# INSTALLATION

## Assembly Instructions

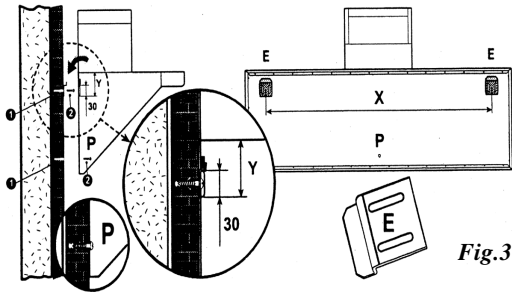

Fig.3

### 3RD TYPE OF SUPPORT

- This support (see E above) is supplied with the cooker hood (generally in two pieces) and should be fastened to the wall by means of two wall plugs.
- In this case, some slots have been made on the back of the hood onto which these supports should be hooked (see above).

To adjust the position of the hood, the support fixing screws should be loosened and the height of the hood should be adjusted. The aforementioned 3 types of support are not sufficient to guarantee that the hood is firmly anchored... you will also need to install one of the following:

**ANTI-TIPPING BRACKET** - (refer to Fig.2) This type of accessory (two pieces generally provided) should be assembled onto the top part of the cooker hood and then fastened to the wall (D). Slots (B) on the bracket allow for partial adjustment of the inclination of the hood.

**ANTI-TIPPING SCREW** - (refer to Fig.3) This anti-tipping device foresees that the hood is fastened directly to the wall by means of one or more screws provided, using the holes on the back panel of the hood (P).

### ASSEMBLY OPERATIONS

- Locate the position of the holes to drill on the wall for fastening screws and hooks.
- Remove the metal grease filters.
- Place the hood in its desired position, mark the exact points on the wall where holes must be drilled.
- Move the hood and follow above instructions to anchor it to the wall according to the type of support.
- Hook the hood on.
- Now proceed with the anti-tipping connections, using the special bracket or screws (see above).

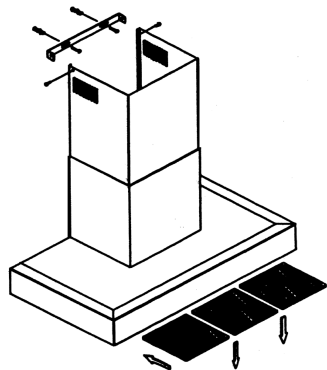

# INSTALLATION

## MOTOR CONNECTION

- There are two types of motor connections where the main difference is the diameter of the steam and odour outlet:
  - 120mm diameter
  - 150mm diameter
- If the motor connection (N, Fig.1) does not come already fitted, it should be fastened to the top of the hood using screws provided. Then connect it to the steam and odour exhaust duct by means of a pipe of a suitable diameter.

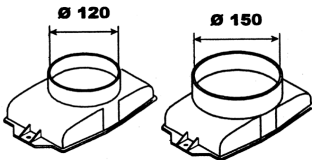

## CHIMNEY DUCT ASSEMBLY

- Take the two chimney ducts A and B (Fig.5) and rest the lower part of duct A on top of the hood.
- Fasten duct A to the hood using screws K (Fig.3), provided.
- Raise the mobile part B until it reaches the ceiling, making sure it is perpendicular with the hood.
- Fasten it with the screws M (Fig.5), provided.

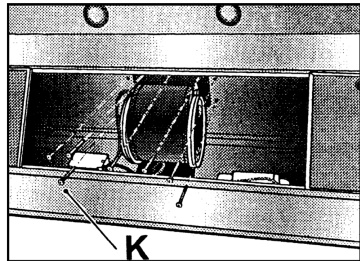

Fig.4

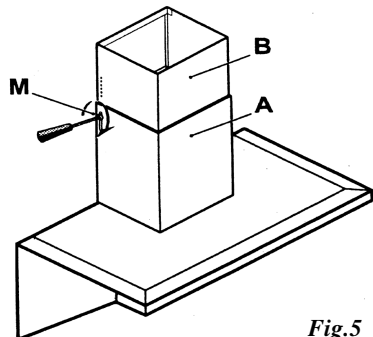

Fig.5

# INSTALLATION

---

## Electrical Connection

---

- The hood is intended for a fixed permanent installation. For the mains voltage and frequency information, consult the rating plate situated inside the hood. The power supply cable (type H05VV-F 3x0.75mm<sup>2</sup>) connected to the hoods terminals marked 'L' (mains), 'N' (neutral) and fastened by means of the cable clamp. It must be connected to a suitable and accessible fixed power point by qualified personnel following all laws in force, providing for an omnipolar switch above the electrical connection with a minimum contact opening of 3mm.
- The manufacturer declines all responsibility for injury or damage resulting from incorrect installation and use.

# GETTING TO KNOW YOUR COOKER HOOD

---

## The Controls

---

**WARNING:** Children should not be allowed to play with the appliance or tamper with the controls.

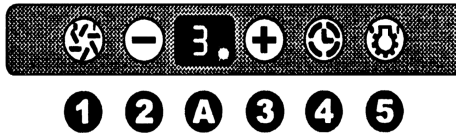

<b>Key 1</b>	Switches the extractor motor on/off.
<b>Key 2</b>	Reduces the operating speed.
<b>Key 3</b>	Increases the operating speed.
<b>Key 4</b>	Will turn the motor off automatically after 12 minutes - When this function is enabled a ✱ appears in the display A (bottom, right hand side).
<b>Key 5</b>	Switches the light on and off.
<b>Key A</b>	Display.



# CARE AND CLEANING

---

Before cleaning your cooker hood or carry out any maintenance, switch the omnipolar switch to OFF to disconnect the hood from the electricity supply.

## CLEANING METAL GREASE FILTERS

The filters must be cleaned every 2 months of operation, or more frequently with heavy usage, and can be washed in a dishwasher.

- Remove the filters one at a time by pushing them towards the back and pulling down at the same time.
- Wash the filters, taking care not to bend them. Allow them to dry thoroughly before refitting.
- When refitting the filters, make sure that the handle is visible on the outside.

**NOTE:** After every 30 hours of use, the microprocessor which is the heart of the system, indicates with a flashing letter 'A' on the display that the metal grease filters should be cleaned. Cleaning the filters reduces the fire risk and improves the performance and efficiency of your cooker hood.

Clean the metal grease filters, following instructions in the 'Care and Cleaning' section.

After cleaning cancel the warning message as follows:

- Switch off the hood.
- Press and hold Key 2 for more than 5 seconds. When the key is pressed the letter 'A' will appear on the display, after the 5 seconds the letter disappears and the microprocessor starts a new 30 hour count down to the next warning message.

# CARE AND CLEANING

## REPLACING THE ACTIVATED CARBON FILTER (RECIRCULATION VERSION)

The filter is not washable and must be replaced (see **NOTE** below).

- Remove the metal grease filters.
- Remove the saturated activated carbon filters 'O' Fig. 15, by turning them clockwise and then removing them from the guide pegs on the outdoor venting assembly.
- Dispose of the carbon filters.
- Fit the new filters making sure that the holes fit well around the guide pegs of the outdoor venting assembly. Turn them anti-clockwise until you hear them click into position.
- Replace the metal grease filters.

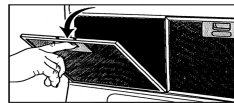

fig. 14

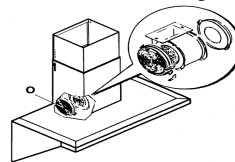

fig. 15

**NOTE:** If the hood is used in the recirculation version with carbon filters to purify exhaust fumes, the microprocessor which is the heart of the system, must first be 'informed' that it is managing a cooker hood in recirculation mode. To do this:

- Switch off the hood.
- Press and hold Key 4 for more than 5 seconds. When the key is pressed '-' will appear on the display (indicating that the hood is not using the carbon filter). After the 5 seconds this becomes a 'C' on the display (indicating that the hood is using the carbon filter).

When set to using carbon filters, every 120 hours, the microprocessor will indicate with a flashing 'C' on the display that the carbon filters need to be replaced.

After replacing the carbon filters, cancel the warning message as follows:

- Switch off the hood.
- Press and hold Key 3 for more than 5 seconds. When the key is pressed the letter 'C' will appear on the display, after the 5 seconds the letter disappears and the microprocessor starts a new 120 hour count down to the next warning message.

# CARE AND CLEANING

## LIGHT REPLACEMENT

The hood can be provided with different types of lamps: incandescent, halogen and neon lamps.

- **Incandescent lamps (Fig.6):** lamps with E14 cap, 40W power and 230V voltage, generally olive shaped.

To replace them, remove the grease filters, unscrew the faulty lamp and screw in the new one, replace the grease filters. If using an electronic bulb, use only those with an E14 coupling, max. 11W.

- **Halogen lamps (Figs.7 & 8):** Fig.7 illustrates the type of lamps with E14 cap, 50W power and 230V voltage. To replace them, follow instructions given above for incandescent lamps. Fig.8 illustrates the type of lamps with G4 cap, 20W power and 12V voltage.

To replace them, use a screwdriver to remove the glass support ring A (Fig.9), then remove the protection glass B. Pull out the used bulb and replace it with the new one. Replace the protection glass B fastening it in place with support ring A. If using a 12V dichroic halogen (Fig.8a) lamp, use only those with a GU5.3 coupling max. 20W.

- **Neon lamps (Fig.10):** neon lamps can come with a 'mignon' G5 cap (8W or 13W power and 288mm or 516mm long) or a normal G13 cap, (15W or 23W power and 437mm or 970mm long). To replace them, remove the metal grease filters, detach the neon, rotating it 90 degrees and pull it out of its housing. Fit the new neon light then replace the metal grease filters.

- **Starter Replacement:** for all types of neon lamps, use a 220-240V / 4-80W Starter (Fig.11).



fig. 6

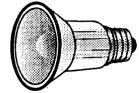

fig. 7



fig. 8



fig. 8a

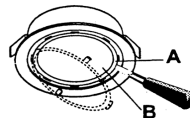

fig. 9

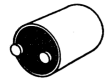

fig. 11

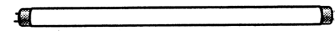

fig. 10

## CLEANING

- Clean with a sponge soaked in warm water and a sodium bicarbonate solution, which is among other things a good disinfectant. If you do not have any, you can use a neutral soap.
- Clean steel parts by rubbing in the direction of the surface finish.
- DO NOT use abrasive detergents, bleach or detergents using ammonia.
- NEVER use solvent based products.

Failure to carry out the basic standards of cleaning and replacement of the filters could cause a fire risk. Therefore you must observe these instructions.

# NOTES

---

# NOTES

---



## After Sales Service

**"No company is better positioned to offer an after sales service on a Hotpoint appliance than us - the manufacturer"**

As part of our commitment to you, all Hotpoint appliances have the added benefit of a fully inclusive parts and labour guarantee for the first 12 months. In addition to this you also have the advantage of **free replacement parts for the first 5 years** when fitted by a Hotpoint engineer. When the 12 months parts and labour guarantee expires we offer the following after sales service options:

### Repair Service and Information Help Desk

UK: 08709 066066

[www.theservicecentre.co.uk](http://www.theservicecentre.co.uk)

Republic of Ireland: 1850 302 200

Note: Our operators will require the Model number and the Serial number of your appliance

Available 364 days a year with a fast, effective and value for money service. We have the largest white goods repair service in the UK with over 1200 of our own fully trained engineers.

All repairs include a parts and labour guarantee for 12 months from the date of the repair. If you require any information or have any questions about your appliance, our operators are on hand with help and advice.

All this ensures that you will receive the best available after sales service possible.

### Extended Warranties

UK: 08709 088 088

[www.theservicecentre.co.uk](http://www.theservicecentre.co.uk)

Republic of Ireland: 1850 502 200

Whether you have just one or a number of Hotpoint appliances in your kitchen, we offer two service cover plans to give you total peace of mind.

- Repair Protection Plan - FREE service repairs for a single Hotpoint appliance during the period of cover.
- Kitchen Cover - FREE service repairs for all your Hotpoint appliances less than 8 years old.

### Genuine Parts and Accessories

UK: 08709 077 077

[www.theservicecentre.co.uk](http://www.theservicecentre.co.uk)

Republic of Ireland: (01) 842 6836

A wide range of genuine parts and accessories are available from our hotline or through our website.

**Genuine parts and accessories, extended warranties and service repairs are all available on our web-site at:**



[www.theservicecentre.co.uk](http://www.theservicecentre.co.uk)



## Guarantee

### "Satisfaction guaranteed or your money back"

We give you a unique 'satisfaction guaranteed' promise - **valid for 90 days** - after you have purchased your Hotpoint appliance. If there is a technical problem simply call Hotpoint Repair service or visit our web-site at [www.theservicecentre.co.uk](http://www.theservicecentre.co.uk) and where necessary, we will arrange for an engineer to call. If the technical problem is not resolved under this guarantee, **we will replace your machine or, if you prefer, give you your money back.**

All Hotpoint appliances carry a fully inclusive 12 month parts and labour guarantee as well as free replacement parts for the first 5 years (except microwaves, selected integrated appliances and cooker hoods, which have a one year guarantee) provided that they are fitted by a Hotpoint engineer.

#### Guarantee terms and conditions

Your guarantee is only applicable in the United Kingdom or Republic of Ireland and is subject to the following provisions that your appliance:

- Has been installed and used correctly in accordance with this instruction booklet.
- Has been used solely for domestic purposes and is located on domestic premises (ie. not for commercial or trade use).
- Has been properly connected to a suitable electrical supply voltage as stated on the appliance rating plate.
- Has not been subject to misuse, accident, modified or repaired by anyone other than one of our own service engineers.



For pre purchase information on any other Hotpoint product call: 08701 50 60 70  
or visit: [www.hotpoint.co.uk](http://www.hotpoint.co.uk)



#### Recycling & Disposal Information

As part of Hotpoint's continued commitment to helping the environment, Hotpoint reserves the right to use quality recycled components to keep down customer costs and minimise material wastage.

Please dispose of packaging and old appliances carefully.

To minimise risk of injury to children, remove the plug and cut mains cable off flush with the appliance. Dispose of these parts separately to ensure that the appliance can no longer be plugged into a mains socket.



## Key Contacts

### After Sales Service

Over 1200 trained specialists, directly employed by us, ensure that you can have complete confidence in both the appliances and services we offer.



### Repair Service and Information Desk

UK: 08709 066 066

(Open 8 to 8 Mon - Fri, 8 to 6 Sat, 10 to 4 Sun & Bank Holidays)

[www.theservicecentre.co.uk](http://www.theservicecentre.co.uk)

Republic of Ireland: 1850 302 200

Note: Our operators will require the following information:

Model number:

Serial number:

### Extended Warranties

UK: 08709 088 088

(Open 8 to 8 Mon - Sun)

[www.theservicecentre.co.uk](http://www.theservicecentre.co.uk)

Republic of Ireland: 1850 502 200

### Genuine Parts and Accessories

UK: 08709 077 077

(Open 8-30 to 5-30 Mon - Fri & 9 to 12 Sat)

[www.theservicecentre.co.uk](http://www.theservicecentre.co.uk)

Republic of Ireland: (01) 842 6836



## Free Manuals Download Website

<http://myh66.com>

<http://usermanuals.us>

<http://www.somanuals.com>

<http://www.4manuals.cc>

<http://www.manual-lib.com>

<http://www.404manual.com>

<http://www.luxmanual.com>

<http://aubethermostatmanual.com>

Golf course search by state

<http://golfingnear.com>

Email search by domain

<http://emailbydomain.com>

Auto manuals search

<http://auto.somanuals.com>

TV manuals search

<http://tv.somanuals.com>