

Hotpoint Service and Spares

FOR SERVICE: If you have a problem with your appliance ring your local Service Office.
 FOR SPARES and ACCESSORIES: To purchase spares and accessories send your Accessories Order Form to your Spares Centre. If the accessory or spare part you want is not on the form, contact your Spares Centre for prices and availability.
 Please address all correspondence to Hotpoint Spares Centre or Hotpoint Service Office as applicable.

Service Offices and Spares Centres are open between 8.00am-5.00pm Monday to Friday, except on Public Holidays. 8.30am-12.30pm on Saturdays.

- EAST**
- **ESSEX:** Industrial Buildings, Beehive Lane, Chelmsford, CM2 9TE. Post Codes RM & IG. Tel: (0245) 492433. Remainder of Essex. Tel: (0245) 269331.
 - **LUTON:** 5 Crowley Road, LU1 1HK. Tel: (0582) 462211
 - **PETERBOROUGH:** Celta Road, PE2 9JB. Tel: (0733) 556520. Spares Administration Dept. Tel: (0733) 556520
- LONDON**
- **WEMBLEY:** 68 East Lane, HA9 7PP. Tel: 081-904 4399. S. Herts and Middlesex. Tel: 081-908 4722. Post Codes N, NW, E, EC. Tel: 081-908 2511. Tel: 081-904 0201
- MIDLANDS**
- **BIRMINGHAM:** Westgate, Aldridge, W Midlands, WS9 8UX. Post Codes B. Tel: (0922) 743374. All other Post Codes Tel: (0922) 743376. Tel: (0922) 743377
 - **NOTTINGHAM:** Ashling Street, NG2 3JB. For Spares Tel: (0602) 860387. Tel: (0602) 862431/864322. For Spares Tel: (0782) 774511
 - **STOKE:** West Ave, Nelson Estate, Talke, ST7 1TN. Tel: (0782) 774511
- NORTH EAST**
- **HULL:** Custom House Building, Whittiergate, HU1 2EU. Tel: (0482) 224777
 - **WASHINGTON:** 8 Bede House, Tower Road, Glover Est., District 11, NE37 2SH. Tel: 091-417 3500/419 3535
 - **WETHERBY:** Sandbeck Lane, LS22 4TW. For Spares Tel: (0937) 581221
- NORTH WEST**
- **KENDAL:** Mumford House, 26 Highgate, LA9 4SX. Tel: (0539) 724483
 - **MANCHESTER:** 44/46 Slaton Road, Heaton Mersey, Stockport, SK4 3QT. Manchester North Tel: 061-432 0513. Manchester South Tel: 061-442 8677. Tel: 061-432 0255
 - **NEFTON:** 7 Bricle Way, Merseyside. Tel: 051-525 2342/524 2339
 - **PRESTON:** 24/25 Cannon Street, PR1 3NR. Tel: (0772) 824311
- SCOTLAND**
- **ABERDEEN:** Holbeck House, 68 Carden Place, AB1 1UL. Tel: (0224) 642283
 - **EDINBURGH:** 35 West Bowling Green Street, Leith, EH6 5WV. Tel: 031-554 1431
 - **RENFREW:** West Lodge Road, Blythswood Estate, PA4 9EN. Tel: 041-886 6241. For Spares Tel: 041-886 5611
- SOUTH**
- **KENT:** Larkfield Trading Est, New Hythe Lane, Larkfield, ME20 6SW. CT, DA, ME & TN Kent Post Codes Tel: (0622) 716571
 - **PLYMOUTH:** CR, KT, RH, SM Surrey & BN Kent Post Codes (0622) 790707. GU Post Codes in Surrey Tel: Southampton (0706) 967374. Tel: (0622) 716631
 - **SOUTHAMPTON:** Unit R, S Hampshire Ind Park, Salisbury Rd, Totton, SO4 3SA. Tel: (0703) 861981/867374. For Spares Tel: (0703) 867933
 - **SUSSEX:** 1 Kingswood, North St, Hailsham, BN27 1DU. Tel: (0323) 842733
 - **WALES:** 69 Mully Plain, PL4 6JH. Tel: (0752) 262631
 - **NORTH:** Conwy Rd, Llanidloedd Junction, LL31 9RE. Tel: (0482) 582626
 - **SOUTH:** 18 Western Ave, Bridgend Ind. Estate, Bridgend, CF31 3SL. Post Codes CF, SA & SY 25 Tel: (0656) 664121. Post Codes BS, GL, (not 55), HR, SY15-18, LD1-8, NP. Tel: (0656) 655554. Tel: (0656) 766111

In accordance with its policy of progressive product design, the Company reserves the right to alter specifications.

Hotpoint Ltd, Peterborough, PE2 9JB, England

Printed in England A94

USER HANDBOOK – MODEL 9518

Contents

Before you operate your washing machine	2	page
Know your machine	3	
How to do a wash	4	
Sorting your laundry	6-7	
Load your machine	8	
Washing detergent	9	
Fabric conditioner	10	
Selecting your programme	10-11	
Additional wash features	12	
The machine at work	13	
Caring for your machine	14	
If you think you have a problem . . .	15-17	
If it still won't work	18	
Hotpoint Service Cover	19	
Hotpoint Service Offices and Spares Centres	back page	

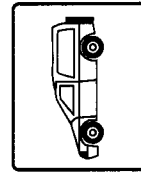
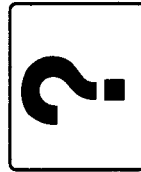
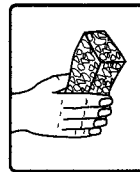
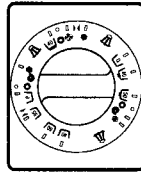
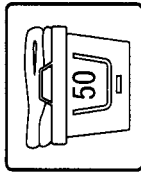
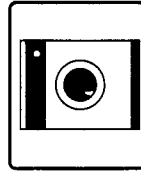

Hotpoint®



Before you operate your Washing Machine

1. Make sure that your machine is correctly installed. Follow the Installation Instructions supplied with the machine. If the Installation Instructions are missing, please contact your nearest Hotpoint Spares Centre (see back page).
2. REMOVE THE TRANSIT BRACKET. YOU MUST NOT OPERATE THE MACHINE WITH THIS BRACKET IN PLACE.

Disconnect the machine from the electricity supply then follow the procedure as shown on the label on the back of the machine.

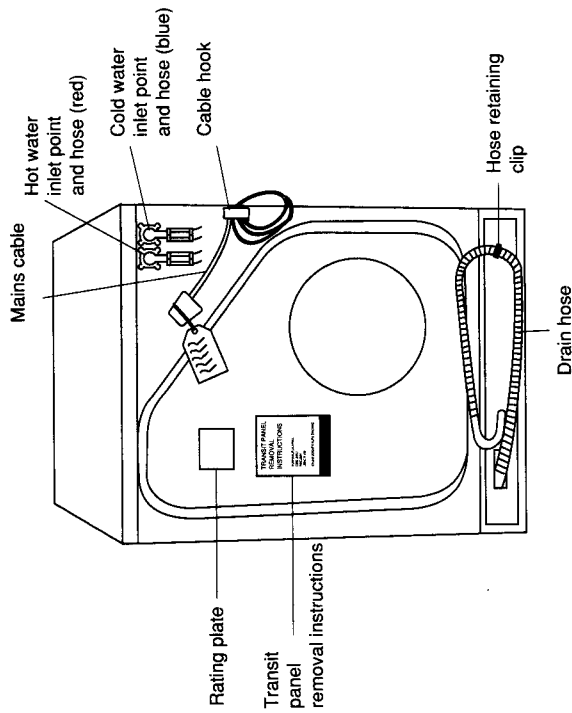

3. After the transit bracket has been removed it is normal for the door seal to appear creased. This will not impair the function of the machine.
3. Read these Instructions **before** using your machine.

NOTE: Do not sit or stand on top of your washing machine; you could injure yourself or damage the machine by such abuse.

WARNING: CHILDREN SHOULD NOT BE ALLOWED TO PLAY WITH THE APPLIANCE OR TAMPER WITH THE CONTROLS.

Hotpoint Service Cover

Satisfaction Guaranteed or Your Money Back

Hotpoint gives you a unique 'Satisfaction Guaranteed' promise – valid for ninety days after you have purchased your Hotpoint product. If there is a problem with your Hotpoint appliance just call your Hotpoint Service Office. If necessary we will arrange for an engineer to call. If the problem is not resolved by us under this Guarantee, Hotpoint will replace your appliance or, if you prefer, give you your money back. This Guarantee is additional and subject to the terms of Hotpoint's Five Year Parts Guarantee.

Hotpoint's Free Five Year Guarantee
From the moment your appliance is delivered, Hotpoint guarantees it for **FIVE YEARS**.

- In the Five Years all replacement parts are **FREE** provided they are fitted by our own Service Engineer. During the first year our Engineer's time and labour is also free.
- After the first year we will charge for our Engineer's time and labour. We do, however, operate a range of Service Plans (see opposite) which for an annual payment enables you to cover any repair costs which may be necessary.
- All of our service repairs are guaranteed for twelve months in respect of our labour and any parts fitted.
- The appliance must be used in the United Kingdom and must not be tampered with or taken apart by anyone other than our own Service Engineer.
- You may, however, buy parts which can be safely fitted without specialist knowledge or equipment. The correct fitting of such parts, provided they are genuine Hotpoint spares, will not affect your Guarantee. Parts are available from our main Hotpoint Spares Centres.
- Our Guarantee does not cover the cost of any repair which is needed because of power cuts, accidents or misuse. Nor does it cover the cost of any visit to advise you on the use of the appliance except for our Free Installation Check for Automatic Washing Machines and Dishwashers. Please read the instruction book thoroughly.
- If at any time during the Guarantee period we are unable to repair your appliance, we will refund any repair costs paid to us in the previous twelve months. We will also offer you a new appliance at a reduced charge instead of a repair.
- Our Guarantee is in addition to and does not affect your legal rights.
- Should you need independent advice on your consumer rights, help is available from your Consumer Advice Centre, Law Centre, Trading Standards Department and Citizens Advice Bureau.
- All Hotpoint servicing is done by our own Service Organisation located throughout the United Kingdom and Southern Ireland. It will be happy to deal with any problems.



Hotpoint's Installation Check

If you ask at your local Service Office (see back page), Hotpoint will send one of its trained Engineers to make sure that the appliance has been properly unpacked and correctly connected to existing water and electrical supplies. If you wish, the Engineer will be happy to explain how to use your new appliance.

Hotpoint's Service Care

Whether you have just one or a number of Hotpoint appliances in your kitchen, Hotpoint has a range of Service Schemes to give you complete peace of mind.

Service Cover

A single payment covers you for all repairs during the period of cover, which can be from 1 to 4 years. There is also an option of Service Cover with Maintenance at an additional cost. This includes an annual Electrical and Safety check and replacement of any parts as necessary. For 1 year contracts this takes place towards the end of the contract period.

Kitchen Cover

An annual payment covers you for all repairs for all your Hotpoint appliances which are less than 10 years old. It also covers the cost of loss of food up to £250 in our refrigeration and freezer products. There is also the option of Kitchen Cover with Maintenance at an additional cost. Any additional Hotpoint appliances purchased after you have joined Hotpoint Kitchen Cover will automatically be included during the annual period of cover without further charge.

Appliance Registration

To ensure that you have the opportunity to benefit from any of the above Service Schemes you should complete and return immediately the Appliance Registration Form supplied with your appliance. Full details and costs of our Service Schemes together with an application form will be sent to you at the end of the first year of the guarantee.

Annual Safety/Maintenance Checks

Hotpoint strongly recommends that all its appliances are regularly checked for electrical and mechanical safety whether or not they are covered by a Service Plan.

Proof of Purchase

For future reference please attach your purchase receipt to this booklet and keep it in a safe place.

Spares and Accessories

Spares and accessories can be ordered from your local Hotpoint Spares Centre (listed on the back page), using the order form enclosed.

NOTE: Our Engineer will use every effort to avoid damage to floor coverings and adjacent units when carrying out repairs/service work but in locations where the Engineer advises you that it will be impossible to move the appliance without risk of damage, he will only proceed with your approval that no liability is accepted.



If it still won't work . . .

Contact your local Service Office

If something is still wrong with your machine after you've been through the check-lists:

1. Switch off and unplug machine from the mains.
2. Turn off hot and cold taps.
3. Call your nearest Hotpoint Service Office or local importer (outside the UK). The telephone number is on the back page. Note down the number here for convenience:

.....
When you contact us we will want to know the following:

1. Your name, address and post code.
2. Your telephone number.
3. Clear and concise details of the fault.
4. The model number of your machine (9518 for this machine), the serial number (found on the inside of the door) and the colour.
5. The date of purchase. Enter the date here:

6. If you have taken out a Hotpoint Service Cover Plan.

Please make sure you have all these details ready when you call.

Retention of this Instruction Book

This Instruction Book must be kept handy for reference as it contains important details on the safe and proper use of the appliance.

If you sell or pass the appliance to someone else, or move house and leave it behind, make sure this Book is also provided so the new owner can become familiar with the appliance and safety warnings.

If the Book is lost or damaged a copy may be obtained from Hotpoint Ltd, Celta Road, Peterborough, PE2 9JB.

Emergency door opening
If the machine is full of water with your clothes inside, you can open the door by following these instructions. You will need a bucket. First you have to empty some of the water, so that the safety latch will release the door.

1. Turn off the hot and cold taps, switch off the electricity and unplug the machine. Do not use machine again until the Service Engineer has called.
2. Pull out the machine so that you can get at the back of it.
3. Place the end of the Hose in a bucket to drain the water. Draw off about two bucketfuls.

WARNING: BE CAREFUL, THE WATER MAY BE VERY HOT.

4. When sufficient water has been removed you will be able to open the door.

Know your Machine

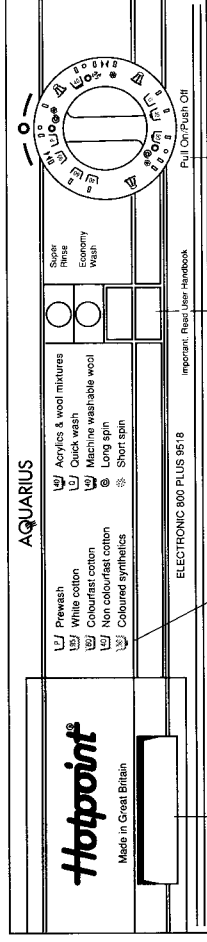

3 Compartment Detergent Dispenser

Programme Description

Wash Feature Buttons

Programme Selector

How to Open the Door

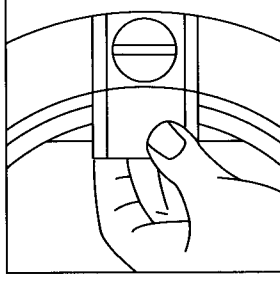

Open the door by pulling the door catch and handle outwards.

Programme Selector

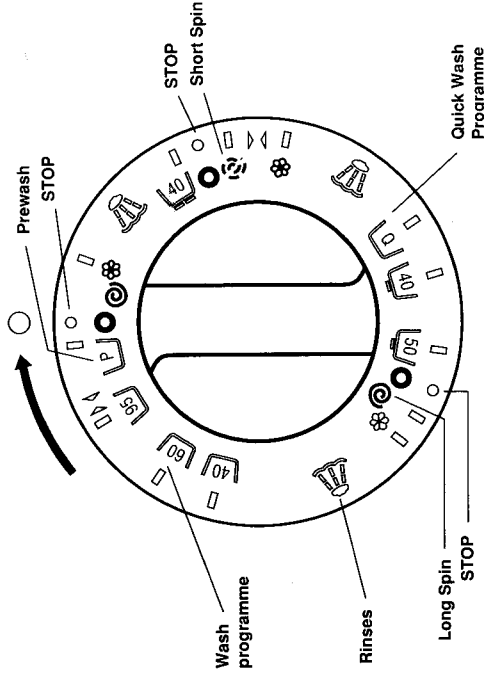



How to do a wash

BEFORE THE WASH

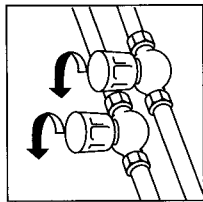

1. Turn on hot and cold water

Hot water should ideally be at 60°C (140°F) and must not be above 70°C (160°F).

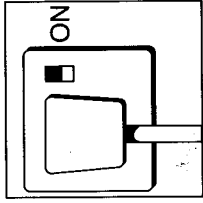

2. Plug in, switch on electricity

WARNING: ENSURE HANDS ARE DRY.

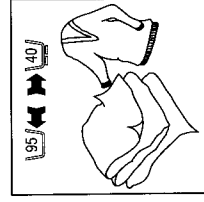

3. Sort your laundry See page 6

Make up a load of similar fabrics

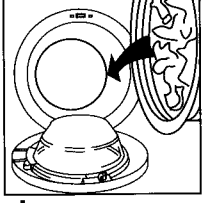

4. Load the machine See page 8

Don't overload the machine

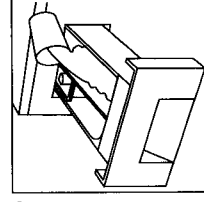

5. Detergent and fabric conditioner See pages 9 and 10

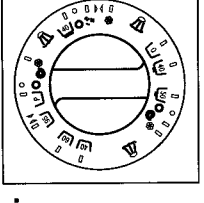

6. Select a programme to suit your laundry See page 10

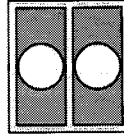

7. Select additional wash features See page 12

Super Rinse Economy Wash

Increases water level for deeper rinsing, use with heavy soiled clothes or if people have sensitive skins
'No heat' wash for light soiling only



The door won't open

Is the door locked?

Has the programme finished?

Is there water still in the machine? Check your drain outlet and waste pipe connections. If your waste installation is wrong, water could be running back into the machine causing the door to lock! Spin out and try again. Emergency door opening procedure is explained on page 18.

The clothes are not dry enough

Did you select the right programme for the type of fabric?
Did the water pump out?
(Check waste plumbing arrangements.)

Machine takes a long time

Have you selected a hot wash? See page 13. Hot programmes can take a long time, especially if the water has to be heated up from cold. Other things that can lengthen the programme are:
- Prewash
- Low water pressure
- Modifying your machine to cold fill only

The clothes are not clean

Did you select the correct programme?
(Try a prewash next time and the correct wash programme.)

Did you use the correct quantity of detergent?

(See page 9.)

Did you select the correct wash options?

Was the machine overloaded? Good wash results are only obtainable with the recommended wash load.

IF YOU INSTALL YOUR MACHINE CORRECTLY AND FOLLOW THE USER INSTRUCTIONS SUPPLIED, YOU ARE UNLIKELY TO EXPERIENCE DIFFICULTIES.



It's stopped in mid programme

After the initial fill, the machine may sometimes pause while the heater comes into operation. It should continue after the selected temperature is reached.

Steam is coming out of the detergent dispenser drawer

During HOT washes the machine is designed to vent steam from the dispenser drawer and this is quite normal.

Water flowing into the machine and out of the drain hose at the same time

Is the drain standpipe at least 500mm (20in) above floor level? See Installation Instructions booklet.
Has the drain hose been pushed down the standpipe more than 50mm (2in)?
If so, then raise it.

Suds are coming out from the detergent dispenser

Did you use the right quantity of **LOW SUDS AUTOMATIC DETERGENT**?
Select a rinse programme and flush the machine through.

It makes a noise or vibrates during spin

Your Automatic will make some noises, especially while spinning. **If vibration is excessive, check that you have removed the transit packing. See Installation Instructions.**
Small loads of heavy or bulky items (towels, bath mats, jeans, etc) can cause out of balance conditions but the machine will usually sort itself out.
Check also that your machine is resting firmly on the floor. See Installation Instructions regarding levelling of the machine.
Note: Rattling and scraping noises are not normal and may need attention!

It won't pump out

Has the drain hose been installed correctly? (See the Installation Instructions.) Is the hose kinked? If you have connected to a sink waste spigot, is the spigot blocked?



8. CLOSE THE DOOR

SAFETY LOCK

It is recommended that the door is locked if children are nearby. Turn the slot 90° in a clockwise or anti-clockwise direction
– bar horizontal = locked
– bar vertical = unlocked.
For safety reasons the door cannot be opened whilst the drum is rotating or contains water.

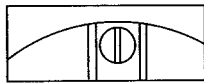

9.

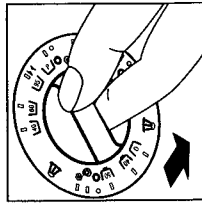

Start the machine
See page 10

Pull out the Programme Selector. The machine will automatically carry out the programme selected.

AFTER THE WASH

10.

Switch off machine

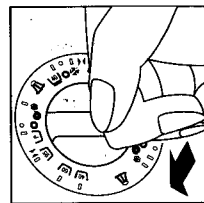

Push in the Programme Selector when programme has finished

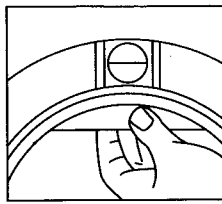

To unlock the safety lock turn the slot 90° in an anti-clockwise direction.

Take out laundry

11.

Switch off electricity

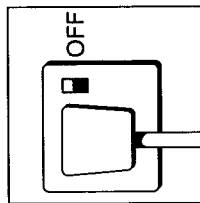

Turn off water

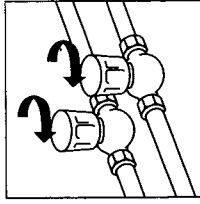

WARNING: WHEN SWITCHING ELECTRICITY OR MACHINE ON OR OFF, PLEASE ENSURE THAT YOUR HANDS ARE DRY.

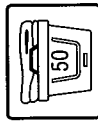

Sorting your laundry

Wash codes appear on the labels on most washable items. You may have some items with the old wash code printed on the garment label. For easy reference, the new and old wash codes are shown below. The new codes are shown on your Programme Selector.

Label codes New	Label codes Old	Fabric	Temp °C	Max Full load
		White cotton and linen without special finishes	85	5kg 11lb
		Colourfast cotton, linen or viscose without special finishes	60	5kg 11lb
		Coloured nylon polyester acrylic/cotton mixtures, cotton or viscose with special finishes (eg. drip dry), coloured polyester/cotton mixtures	50	3kg 6.5lb
		Non-colourfast cotton, linen and viscose	40	5kg 11lb
		Acrylics, acetates and tri-acetates, blends of these fabrics with wool, polyester/wool blends	40	3kg 6.5lb
		Woolen blankets, wool mixtures with cotton or rayon, silk	40	2.7kg 6lb
		Shrink resistant machine-washable and Superwash Woolmark garments	40	1.4kg 3lb
		Lightly soiled items only Not wool items – machine washable; wool mixtures	Cool No Heat	0.9kg 2lb

It is advisable to separate light and dark colours. There are often other symbols on the garment label also. These are explained on the opposite page.



If you think you have a problem . . .

Look at this list, then check the adjacent suggestions. They may give you the answer to your problem, without having to telephone your Hotpoint Service Office.

If you cannot solve the problem, follow the advice given on page 18.

Problem	Check these things first
<i>Powder dispenser drawer won't close properly</i>	<p>Ensure flap is fitted correctly. See page 14.</p> <p>Make sure the flap is fitted correctly. Is the drawer jammed with detergent?</p>
<i>It won't start</i>	<p>Have you selected the programme and pulled out the selector knob?</p> <p>Is the loading door closed firmly?</p> <p>Is it plugged in and switched on at the mains?</p> <p>Is the socket OK? (Try another appliance in it.)</p> <p>Has the fuse blown? (Try a new fuse of the correct rating.)</p>
<i>It won't fill or take in the detergent</i>	<p>Are the taps turned on fully?</p> <p>Are the fill hoses kinked behind the machine?</p> <p>Have you got the hoses connected correctly. See page 2.</p> <p>Have you selected the programme correctly and pulled out the selector knob to start the machine?</p> <p>If you have a liquid detergent dispenser – did you put powder in the liquid detergent dispenser by mistake?</p>
<i>The programme sticks at the end of the wash or during the rinses</i>	<p>Has the drain hose been installed correctly? If not, syphoning could occur and this will halt the programme.</p> <p>Check the installation instructions. It is important that you do not remove hooked end support and push the hose too far down the waste standpipe.</p>
<i>It's leaking</i>	<p>Are the fill hoses tightened correctly? – Perhaps the washers are not sealed properly.</p> <p>Is your standpipe blocked?</p> <p>Is your household drainage system blocked?</p> <p>If you cannot clear the blockage yourself, you will need a plumber.</p> <p>Removal of the hooked end support may cause a leakage.</p>



Caring for your machine

When programme has finished:

- press in the Programme Selector
- cancel any feature buttons.

After each wash:

- open door, remove clothes and rotate drum to check for small items left behind.
- remove dispenser drawer for cleaning:

To clean dispenser:

- Pull out the drawer until it reaches its stop, then lift slightly and give it a sharp tug to remove it completely (see diagram).

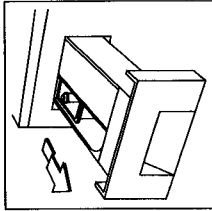

- Remove fabric conditioner compartment.
- Pull off syphon tube and clean conditioner compartment.
- Push syphon tube **firmly** back into place in the conditioner compartment.
- Clean the dispenser drawer and dry thoroughly.
- Replace the conditioner compartment in the dispenser drawer, with the syphon tube towards the back.
- Check that the flap at the back is in place and pivots correctly.

To locate drawer into the machine, hold the top of the flap away from you until it locates under the top of the dispenser opening, then push the drawer back in firmly.

As necessary

Clean exterior surfaces with a damp cloth or silicon polish only.

Do not use abrasive cleaners, scouring agents, acids, chlorine bleach or metal polish to clean any part of the machine. This could damage it.

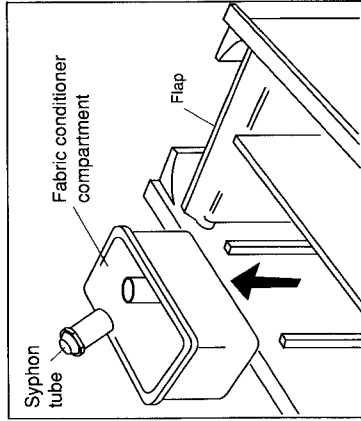

Yearly. We recommend you take out a Hotpoint Service Cover Plan with annual safety/maintenance check which ensures the machine is professionally serviced every year. Details are given at the end of this book.

Hotpoint strongly recommends that its machines are regularly checked for electrical and mechanical safety whether or not they are covered by a Hotpoint Service Cover Plan. This is to avoid such things as worn door gaskets or hoses which may cause a leak on a machine which could become dangerous if neglected.

NOTE: The hole in the door gasket is designed to help water drain into the drum.

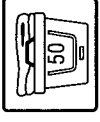

Do not machine wash woollens which don't have a Washcare label or any label stating they are machine washable.

NOTE: Some 'woollens' are not made of wool at all but acrylic, which should be washed on programme 40/1. Check the label to make sure.

Pre-treating dirt and stains

Brush a little washing detergent dissolved in water onto stains like collars and cuffs to help shift the dirt.

Treat stains immediately

Plunge the stained area into **cold** water, or sponge it down. This prevents the stain from setting. Wash as soon as possible afterwards.

Nappies: Scrape off any excess baby cream, such as Vaseline® from the nappies before washing. Use a Prewash programme (page 11) to prevent the cream being transferred to other items in the wash.

Pockets and Zips

DO MAKE SURE ALL YOUR POCKETS ARE EMPTY.

Tissues can disintegrate and cover all your washing.

Sharp objects like coins and keys can damage clothes and the machine.

Close all zips and tie belts and strings to prevent tangling.

WASHING:

Articles labelled 30/1 should be hand washed.

Hand wash only.

Do not machine or hand wash

Dry Cleaning:

All of these are dry cleaning symbols. The letters are to instruct the cleaner what type of solvent should be used.

Garments bearing these symbols should not be washed in your machine, unless the label says otherwise.

Do not dry clean.

Bleaching:

Bleach may be used. In this case the letters 'CL' show that a chlorine household bleach such as 'Domestos' can be used. NB This applies to hand washing only. **Do not use bleach in your machine.**

Do not bleach.

NOTE: Do not wash non-colourfast items, woollens or really dirty clothes in a mixed load.

Woollens

Machine-washable woollens may be washed on programme 40/1, but remember:

- Limit the load to 1.4kg (3lb).
- Do not use a Prewash (soaking may harm woollens).
- Do not tumble dry.

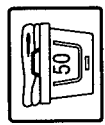

Load your machine

Don't overload your machine. Clothes won't wash properly and damage may be caused to your machine and garments. See page 6 for maximum wash loads.

Typical Weights

To help you wash the correct quantity of clothes, the chart below lists typical clothes weights.

Clothes	Weight
Blouse	Cotton 150g
	Other 100g
Dress	Cotton 500g
	Other 350g
Jeans	700g
10 Nappies	1000g
Shirt	Cotton 300g
	Other 200g
T-Shirt	125g
Household items	
Duvet Cover (Double)	Cotton 1500g
	Other 1000g
Large Tablecloth	700g
Small Tablecloth	250g
Tea Towel	100g
Bath Towel	700g
Hand Towel	350g
Double Sheet	500g
Single Sheet	350g



Additional tips:

- Blankets, double bedspreads and other bulky articles should be washed one at a time.
- To load a blanket, hold it by the centre and allow the corners to drop down. Feed it into the machine centre first.
- Highly absorbent loads such as towels and nappies should be limited to 3kg (7lb) per load to ensure adequate rinsing.
- Place small items in a washbag.
- Check the wash symbol on items such as T-Shirts. They may require a cool wash eg. .
- **Whenever possible wash a full load of clothes to obtain maximum cost and time efficiency.**

The machine at work

What's it doing?

During use you will be aware that your machine will be making some noise and will stop at various intervals during the programme. This is normal. During the wash the machine will:

- 1. Fill** with water, tumbling to mix the detergent.
- 2. Heat** to temperature, with the occasional tumble. This may take some time, so don't be worried if it appears to have stopped working.
- 3. Wash** the clothes, by tumbling, stopping and reverse tumbling.
- 4. Cool rinse.** On programmes  and , the first rinse has a stepped 'cool down' feature by which cold water is added to the hot wash water to gradually reduce its temperature and prevent shock creasing of the washing.
- 5. Dispense fabric conditioner.** If added this is dispensed on the final rinse.
- 6. Spin.** Follows each rinse at one of two different speeds.













WARNING: IT IS POSSIBLE FOR CHILDREN AND ANIMALS TO CLIMB INTO WASHING MACHINES AND INJURE THEMSELVES.

How long can programmes take?

It depends on many things for example:

1. Water flow rate.
2. Temperature of incoming water.
3. Time taken for machine to heat up the water.
4. Features selected.
5. Type and weight of clothes load.

The approximate programme times are:

Programme	Approximate time
	 115-120 mins
	 75-80 mins
	 50-55 mins
	 60-65 mins
	 40-45 mins
	 35-40 mins
	30-35 mins

Prewash  adds 20-30 minutes.
Economy Wash saves up to 15 minutes.

WARNING: DO NOT TOUCH THE GLASS DOOR WHEN THE MACHINE IS IN OPERATION AS THIS AREA CAN BECOME HOT.

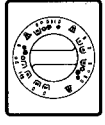

Additional Wash Features

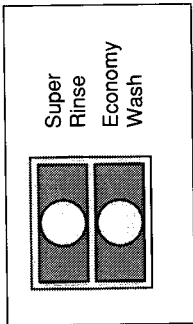

You can modify the main wash programmes to suit your own special needs by selecting one or more of the optional wash feature buttons before you pull out the Programme selector

You select a feature by pressing in the button. You can cancel it at any time by pressing the button once more, so that it is flush with the fascia.

DON'T FORGET TO CANCEL BUTTONS AFTER USE.



Super Rinse

By pressing this button the water level for each rinse on all programmes (except woollen⁽⁴⁰⁾) will increase.



Economy Wash

For lightly soiled washing, saves electricity and time.

Economy Wash switches off the machine's own water heater so your clothes are washed at the temperature of the water coming in from your hot and cold water tanks. This saves you electricity, but can mean a cooler wash, so you should only use Economy Wash for lightly soiled clothes, not for really dirty clothes.

PULL OUT PROGRAMME SELECTOR TO START THE MACHINE.

Additional Features

Safety Lock

If children are nearby whilst the machine is in operation, it is recommended that the door is locked. To lock, turn the slot 90° in a clockwise direction to horizontal position. To unlock turn 90° in an anti-clockwise direction to vertical position.

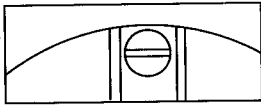

DON'T FORGET TO CANCEL BUTTONS AT THE END OF THE PROGRAMME.

Washing Detergent

Which one to use?

Use any low suds automatic powder. Non-automatic powders reduce wash performance and can cause overfoaming.

Your machine has been specially developed to take advantage of biological powders. Hotpoint recommends Biological Persil Automatic.

How much to use

It is important to use the correct quantity in soft or hard water areas; too little won't get the clothes clean, and too much is a waste.

Quantities indicated below apply to Persil Original Automatic Powder.

For other detergents refer to the packet.

Detergent	Cottons Hard water/ Soft water*	Synthetics Hard water/ Soft water*	Woolliers Hard water/ Soft water*
Prewash	75/50 grams	75/50 grams	-
Full load	200/150 grams	125/90 grams	125/90 grams
Reduced load	125/90 grams	90/70 grams	90/70 grams

These doses are for normally soiled loads
1 cup = 265ml = approximately 160g.

*If you are unsure, check with your local water company.

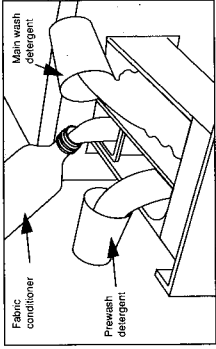
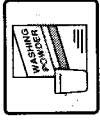

Where to put it

Pull-out drawer on the left of the machine. Powders or liquids which cannot be dispensed through the drawer should be used in detergent dispensers as recommended by the detergent manufacturer, whose instructions on use and quantity of detergents should be followed.

Concentrated detergents

Are now becoming more widely available. Follow the detergent manufacturer's guide regarding quantities to use.

Liquid detergent

To dispense all liquid detergents (which do not require their own dispenser) we recommend using the Hotpoint Liquid Detergent Dispenser (Part No. 9003) which is obtainable from your nearest Hotpoint Spares Centre (see back page) using the order form enclosed. Place the Liquid Detergent Dispenser in the right hand section of the dispenser drawer.

Remove any water remaining from the previous wash before adding liquid detergent and ensure that the syphon tube is firmly in position.

When using liquid detergents in their own dispensers, follow manufacturer's instructions.

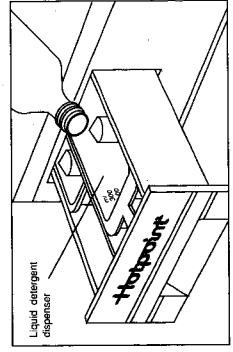



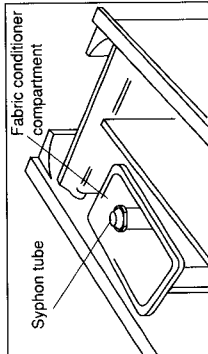

Fabric Conditioner

Hotpoint recommends Comfort. It will soften your washing, eliminate static clinging from synthetics and make ironing easier. Add conditioner when adding your detergent. Use the quantity recommended on the bottle. Remove the fabric conditioner compartment and tip out any water remaining in it before adding conditioner. Replace it as shown with the syphon tube towards the back.

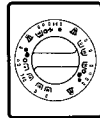

Selecting Your Programme



Turn the Programme Selector clockwise to the wash programme according to the clothes label code (see page 6) or one of the alternative programmes on page 11. The symbol selected should be at the top, eg. 

Do not turn the Programme Selector anti-clockwise and do not turn it when it is pulled out. Push it in to select another programme.

Select any additional features. Pull Programme Selector OUT.

A Lockable Dispenser Drawer

(Part No. 9002) is available, to prevent young children from opening the drawer whilst the machine is running, or from hiding objects in the drawer. This can be ordered from your local Hotpoint Spares Centre (see back page), using the order form enclosed.

WARNING: DO NOT PULL OUT THE DISPENSER DRAWER WHILE THE MACHINE IS OPERATING AS THERE MAY BE HOT WATER PASSING THROUGH IT.

Selecting your Programme

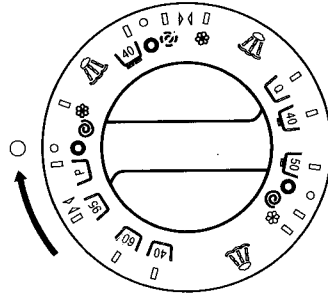

Programme Selector

Do not attempt to open the door once the programme has started

Selecting your Programme

The following additional programmes may be selected.

Prewash

Turn Selector to:

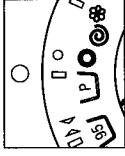

Select Prewash for really dirty clothes, like football kit and nappies. Select Prewash before any programme except .

When finished Programme Selector will stop at the symbol . Push Programme Selector in and turn to select the main wash you want. For a cold Prewash, press the Economy Wash button as well.

Quick Wash

Turn Selector to:

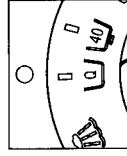

A quick cool wash to freshen up lightly soiled items in just over 30 minutes. Max load 0.9kg (2lb). Not recommended for woollen or machine washable wool.

Spin Only

Turn Selector to:

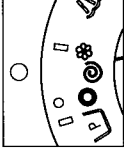

Long Fast Spin
Natural fabrics—
wash codes 

Turn Selector to:

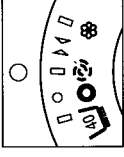



Short Slow Spin
Synthetic fabrics—
wash codes 

NB: Do not fill more than half full with wet clothes (natural fabrics) or one-third full of synthetics. Short Slow Spin has a burst at high speed at the end of its cycle.

Rinse and Spin

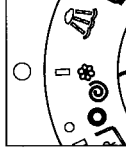
Turn Selector to:



Choose the rinse symbol on the Selector just before the type of spin you want – Long Fast () or Short Slow () to suit the fabric.

Rinse

When the Selector reaches:

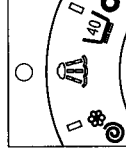

The machine has reached the beginning of its rinse programme.

NB: Woollens and other Hand-Wash only items should only be spin dried, but it is advisable to rinse and spin all other washable fabrics.

End of Programme

When the Selector reaches:

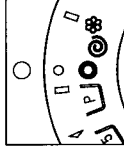

The programme has finished. To switch off, pushing the Programme Selector, open the door and remove the clothes.

Free Manuals Download Website

<http://myh66.com>

<http://usermanuals.us>

<http://www.somanuals.com>

<http://www.4manuals.cc>

<http://www.manual-lib.com>

<http://www.404manual.com>

<http://www.luxmanual.com>

<http://aubethermostatmanual.com>

Golf course search by state

<http://golfingnear.com>

Email search by domain

<http://emailbydomain.com>

Auto manuals search

<http://auto.somanuals.com>

TV manuals search

<http://tv.somanuals.com>