

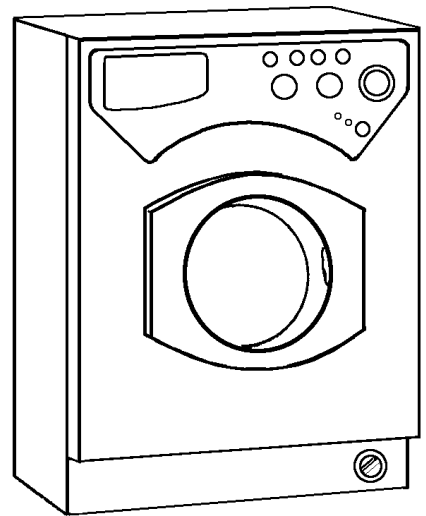

Congratulations on the purchase of your new built-in appliance.

IMPORTANT INFORMATION

Please read this Instruction Manual thoroughly before installing and using your appliance for the first time.



Instructions for Installation and Use

For Integrated Washer and Washer Dryer

Models BWM12 & BWD12

IMPORTANT INFORMATION:

- Do not plug in and switch appliance on at the mains until installation is complete.
- You may be charged for a service call if a problem with your appliance is caused by incorrect installation or misuse.

Electricity Supply

WARNING: This appliance must be earthed.

Fuses

Your appliance comes fitted with a plug and a 13A fuse. If you need to replace the fuse, only those rated at 13A and ASTA approved to BS1362 should be used. To change the fuse in a moulded plug, lift holder to vertical position and lift fuse out. To replace, insert fuse and push fuse holder down into locked position. Correct replacement is identified by colour coding or the marking on base of plug.



WARNING: Do not use plug unless fuse holder is in locked position and fuse cover fitted.

Changing the Plug

Cut off and dispose of the supplied plug if it does not fit your socket.

WARNING: To avoid a shock hazard do not insert the discarded plug into a socket anywhere else.

IMPORTANT: WIRES IN THE MAINS LEAD ARE COLOURED IN ACCORDANCE WITH THE FOLLOWING CODE:

Green/Yellow	-	Earth
Blue	-	Neutral
Brown	-	Live

If you change the plug, the colour of wires in the mains lead may not correspond with the colour of the markings identifying terminals in the plug. You should therefore wire it as shown.

Green and yellow (Earth) wire to terminal marked 'E', symbol \oplus , or coloured green and yellow.

Blue (Neutral) wire to terminal marked 'N' or coloured black.

13A ASTA approved fuse to BS1362.

Brown (Live) wire to terminal marked 'L' or coloured red.

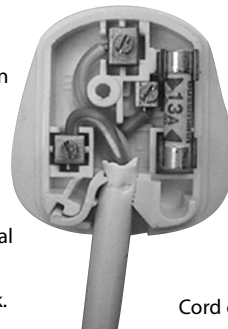

Cord clamp

Recommendations for the Electrical Installation of your Appliance

- Do not use extension leads, adaptors or multiple plugs.
- Never remove the earth connection.
- You should plug your appliance into a socket that is easily accessible but out of reach of children.

If in doubt, get in touch with your installer.

Changing the Mains Lead

A special lead can be ordered from Service UK: 08709 066 066 or Republic of Ireland: 1850 302 200

If you have damaged the existing lead or require a longer one a charge will be made. It is strongly advised that this work is carried out by a qualified electrician.

CE marking certifies that this appliance conforms to the following EEC directives:-
Low Voltage Equipment - 73/23/EEC
Electromagnetic compatibility - 89/336/EEC (including the modification directive 92/31/EEC)



Contents

Electricity Supply	2	<i>The Dispenser Drawer</i>	16
Recycling & Disposal Information	3		
<i>Installation Instructions</i>	3	<i>Using your Appliance</i>	17
i. Remove Transit Bolts	4		
ii. Choose a Location... ..	4	<i>Washcare Tips</i>	19
iii. Connect to the Water Supply.....	5		
iv. Connect to a Drainage System.....	6	<i>Cleaning</i>	20
v. Fitting the Door Panels and Plinth.....	7		
vi. Fitting your appliance into your kitchen..	9	<i>Troubleshooting</i>	
vii. Levelling.....	10	<i>General Maintenance</i>	21
<i>The Controls</i>	11	<i>After Sales</i>	
<i>Getting to know your Appliance:</i>		<i>Service</i>	22
Washing Machine BWM12.....	12	Guarantee	
Washer Dryer BWD12.....	13	Guarantee Terms & Conditions	23
<i>Choosing a Programme:</i>		<i>Key Contacts</i>	Back Page
Washing Machine BWM12.....	14		
Washer Dryer BWD12.....	15		

Installation Instructions

IMPORTANT INFORMATION:

- Do not plug in and switch appliance on at the mains until installation is complete.
- You may be charged for a service call if a problem with your appliance is caused by incorrect installation or misuse.

Follow these 7 steps for a trouble free installation:

- i. Remove the Transit Bolts...*
- ii. Choose a Location...*
- iii. Connect to the Water Supply...*
- iv. Connect to a Drainage System...*
- v. Fitting the door panels and plinth...*
- vi. Fitting your appliance into your kitchen...*
- vii. Levelling...*

Retention of this Instruction Manual

Keep this instruction manual in a handy place for reference. It contains important details on the safe and proper use of your appliance. If you sell the appliance, pass it on to someone else, move house and leave it behind, make sure that you provide this manual so that the new owner can become familiar with the appliance and safety warnings.

WARNING:

- **The appliance must not be plugged into the mains supply until all installation instructions have been completed.**
- **Retain the transit screws, spacers and washers. Should you move house then these should be replaced to support the inside of the appliance to prevent damage when in transit.**

i. Remove Transit Screws...

BEFORE ATTEMPTING TO USE THE MACHINE, YOU MUST FOLLOW THE PROCEDURE DESCRIBED BELOW. The inside of the appliance is supported, for transportation, by four screws on the back panel. Before using the appliance these MUST be removed. NOTE: You may need a second person to help you.

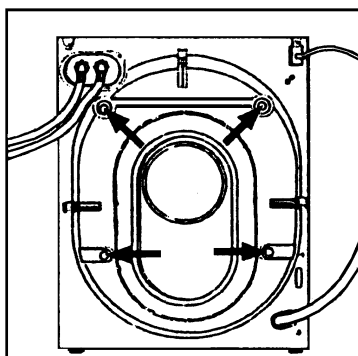

1. Remove the screws, along with the spacers together with the washers intact.
2. You must now cover the holes with the four plastic covers provided.

Important: Use the cap supplied to close the 3 holes which housed the plug, situated in the right hand part of the lower back of the appliance.

ii. Choose a Location...

The choice of location for your appliance will influence its performance.

- Position where possible on a solid floor. Vibration may occur with a wooden floor.
- Take care with vinyl floor coverings. The weight of the appliance may cause indentations in some vinyl floor coverings.
- You should not install your appliance on a carpeted floor, but if this is unavoidable, ensure that air can circulate around its base.
- If locating next to another appliance or an item of furniture, leave space between them to allow air to circulate.
- For your safety and to comply with IEE regulations, you should not install your appliance in a bath or shower room. Seek professional advice if you wish to do so.
- Ensure sufficient space is allowed for the appliance.
- Ensure the electrical socket and water taps are easily accessible and that the water supply can be isolated if necessary.
- Risk of freezing: Do not position the appliance in rooms exposed to frost. Frozen pipes may burst under pressure.

iii. Connect to the Water Supply...

- Water taps and standpipe should be situated away from the rear of appliance but in easy access for turning on and off.
- For your machine to operate correctly it requires water pressures in the range of 6-150 psi (100 - 1000KPa). Most water supplies will be in this range.
- Connect the hoses to the water supply pipes at the rear of the appliance and onto the water supply taps (Red end fitting to the hot water supply and adjacent to 'H' on the rear of the appliance and White end fitting to the cold water supply and adjacent to 'C' on the rear of the appliance). Remember to insert a sealing washer (A) to ensure each connection is watertight.

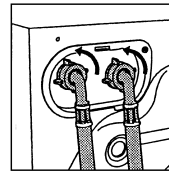

Fit securely and turn on the water supply to check for leaks.

If there is a leak, turn off the water supply, remove the connector and check that the sealing washer is in place. Refit the connector and tighten it. Turn on the water supply.

Note: Do not over tighten the water supply pipe connection. Hand tight should be sufficient.

We recommend you use the new hoses provided with your appliance to ensure correct connections and prevent leaks.

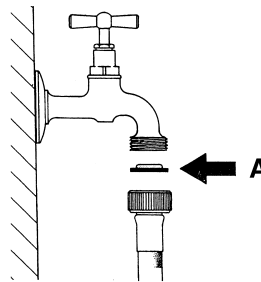

WARNING

- **Do not connect appliance to a single outlet instantaneous water heater.**

If the fill hoses are too short:

Longer fill hoses are available from our Genuine Parts and Accessories Mail Order Hotline
UK on 08709 077 077

(or in the Republic of Ireland on (01) 842 6836).

Remove the existing fill hoses from the inlet valves on the back of the machine and fit the new longer fill hoses as shown with the angled ends of the hoses connected to the machine.

If you have no hot water supply or your hot water pressure is low:

A cold fill adaptor and fitting instructions are available from your local Hotpoint authorised Service Centre or by calling the Genuine Parts and Accessories Mail Order Hotline
UK on 08709 077 077

(or in the Republic of Ireland on (01) 842 6836).

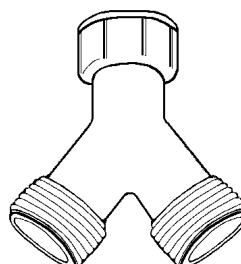

A cold fill adaptor

Remember you may be charged for a service call if a problem with your appliance is caused by incorrect installation or misuse.

iv. Connect to a Drainage System...

- Connect up the drain hose, after fitting the hooked end support supplied in the machine.
- Ensure the drainage hose is not obstructed, trapped or kinked.
- Any extension of the drainage pipe must be no longer than 1 metre, it must have the same inner diameter and must have no constrictions of any nature.
- Do not position standpipe near an electrical outlet.

We recommend one of the following drainage methods:-

Standpipe

Note: Ensure the standpipe has a minimum diameter of 38mm.

- The standpipe should be installed away from the rear of the appliance.
1. Ensure hooked end of drain hose is positioned between 100 and 60cm above the bottom of the machine.
 2. Untie the end of the GREY drainage hose from the rear of the appliance and place approximately 100mm into the standpipe or sink trap spigot.

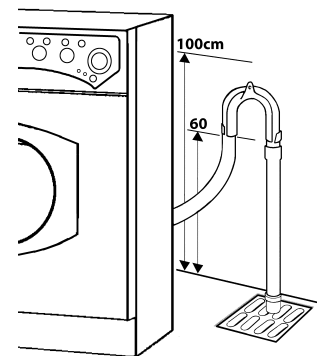

- **Ensure the drain hose is firmly in position, to prevent it coming away while the machine is in use and causing a flood.**

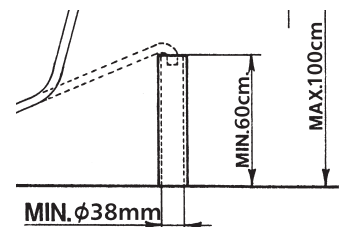

Sink Waste System

Note: Ensure the sink outlet pipe has a minimum diameter of 32 mm.

1. Untie the end of the GREY drainage hose from the rear of the appliance.
2. Reposition 'hooked end' support as required along the GREY drainage hose.
3. If fitting an under sink waste disposal unit cut out the membrane, bung or blanking plug.
4. Attach the GREY drainage hose to the under sink waste disposal unit securely, using a suitable hose clip.
5. Raise the hose to a minimum height of between 90 and 65cm to avoid syphoning.

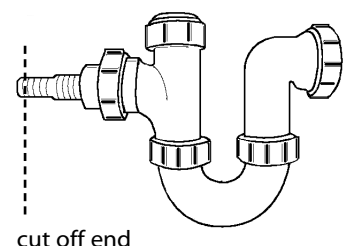

- **Ensure the drain hose is securely attached, to prevent it coming away while the machine is in use and causing a flood.**

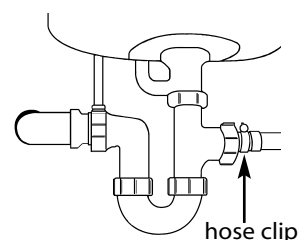

If the GREY drainage hose is too short:

A longer drainage hose is available from our Genuine Parts & Accessories Mail Order Hotline UK on 08709 077 077 (or in the Republic of Ireland on (01) 842 6836).

v. Fitting the Door Panel...

The packaging is designed to make it possible to mount the wooden panel onto the appliance without removing it completely.

- The wooden panel that covers the face of the machine must not be less than 18mm in thickness and can be hinged on either side.

For practical reasons, it is advisable to maintain the same opening direction as the appliance door itself (hinges applied to the left hand side).

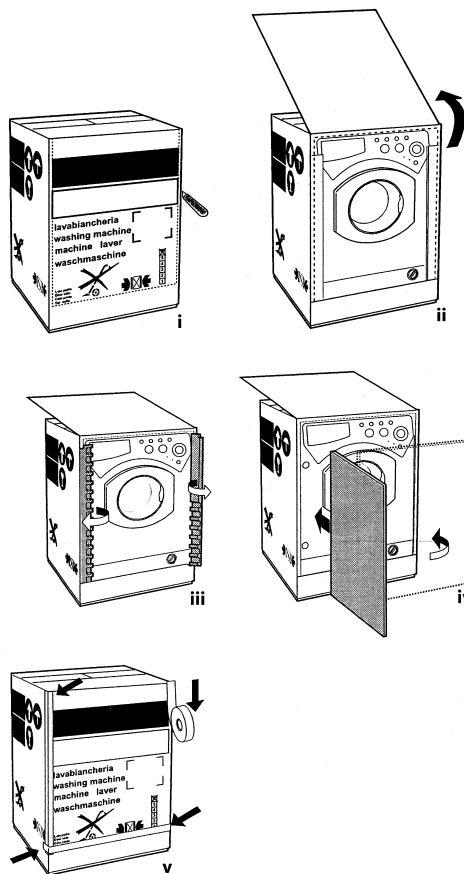

DOOR MOUNTING ACCESSORIES:

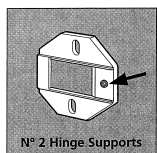

Fig. 1

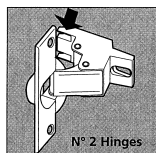

Fig. 2

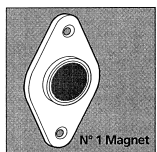

Fig. 3

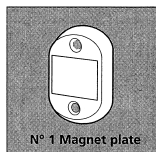

Fig. 4

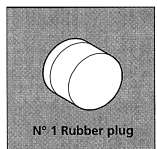

Fig. 5

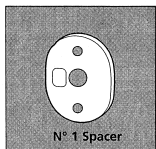

Fig. 4/B

6 x type A self threading screws 1=13mm

2 x type B metric countersunk screws 1=25mm, for fastening the magnet plate to the cabinet

4 x type C metric screws 1=15mm, for mounting the hinge supports to the cabinet

4 x type D metric screws 1=7mm, for mounting the hinges on the supports

Fitting the Door Panel and Plinth...

Mounting parts onto the face of the appliance:

- Mount the hinge supports onto the face of the machine, positioning the hole indicated by the arrow, in Fig.1, towards the inside of the face and using the type C screws.
- Mount the magnetic plate on the opposite side, at the top, using the two type B screws.
- Place the spacer illustrated in Fig 4/B between the machine front and the magnet receiver.

Using the drilling template:-

Proceed as follows when applying the panel to the appliance:

- To trace the positions of the holes on the left hand side of the panel, align the drilling template to the top left side of the panel, using the lines traced on the extremities as a reference.
- To trace the positions of the holes on the right hand side of the panel, align the drilling template to the top right side of the panel.
- Use an appropriately sized router to mill the holes for the two hinges, the rubber plug and the magnet.

Mounting the parts onto the wooden door panel:-

- Insert the hinges into the holes (NB. the movable part of the hinge must be positioned facing away from the panel) and fasten them with the 4 type A screws.
- Insert the magnet into the top hole on the opposite side of the hinges and fasten it with the 2 type B screws.
- Insert the rubber plug into the bottom hole.
- The panel is now ready to be mounted onto the machine.

Mounting the panel onto the machine:-

- Insert the nib of the hinge (indicated by the arrow in Fig.2) into the hole for the hinge and push the panel towards the front of the machine. Fasten the two hinges with the type D screws.

Fastening the plinth guide:-

If the machine is installed at the end of a set of modular cabinets, mount either one or both of the guides for the base moulding (as shown, Fig.6).

Adjust them for depth, based on the position of the base moulding and if necessary fasten the base to the guides (Fig.7).

This is how to assemble the plinth guide (Fig.6).

- Fasten angle **P** using screw **R**, insert plinth guide **Q** into the special slot and once it is in the desired position, lock it in place using angle **P** and screw **R**.

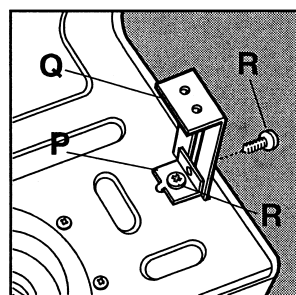

Fig.6

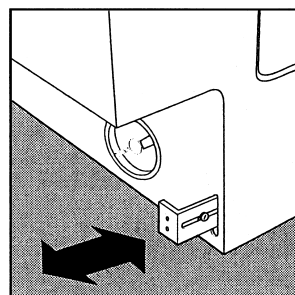

Fig.7

vi. Fitting your appliance into your kitchen...

Inserting the machine into the cabinet:-

- Push the machine into the opening, aligning it with the cabinets (Fig.8).
- Regulate the adjustable feet to raise the machine to the appropriate height.
- To adjust the position of the wooden panel in both the vertical and horizontal directions, use the **C** and **D** screws, as shown in Fig.9.

Important: Close the lower part of the appliance front by ensuring that the plinth rests against the floor.

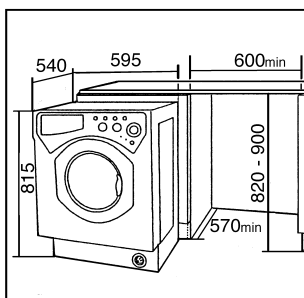

Fig. 8

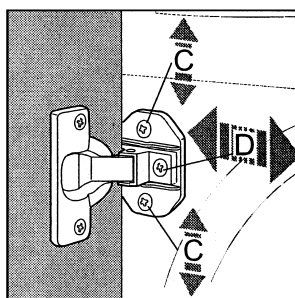

Fig. 9

Move the appliance into position, care must be taken that the Water Supply pipes and the Drainage hose are not kinked or trapped.

Direct the mains cable towards the electrical socket to be used but **DO NOT** plug in at this stage.

There must be at least 2mm clearance at the sides and top of the appliance. The back of the appliance must also remain some distance away from the back wall. If the recessing cavity is higher than 820mm, the opening between the floor and sides of the appliance (when installed at the end of a line of furniture) must be completely closed in.

Remember you may be charged for a service call if a problem with your appliance is caused by incorrect installation or misuse.

vii. Levelling...

Adjust the feet until all four feet are in firm contact with the floor ensuring the appliance stands level in every direction. You can check this using a spirit level.

We recommend you level the appliance to prevent vibration being transmitted to the surrounding furniture, check that the sides and the top of the appliance are unable to touch the furniture.

Accessories provided for height adjustment

The following can be found inside the polystyrene lid (Fig.10):

- 2 x crossbars (**G**)
- 1 x strip (**M**)

The following can be found inside the appliance drum:

- 4 x adjustable feet (**H**)
- 4 x screws (**I**)
- 4 x screws (**R**)
- 4 x nuts (**L**)
- 2 x plinth guides (**Q**)

Adjusting the appliance height

The height can be adjusted (from 815mm to 835mm), by turning the 4 feet. Should you require the appliance be placed higher than the above height you need the following accessories to raise it up to 870mm:

- the 2 x crossbars (**G**)
- the 4 x adjustable feet (**H**)
- the 4 x screws (**I**)
- the 4 x nuts (**L**)

Then carry out the following steps (Fig.11):

Remove the 4 original feet, place a crossbar **G** at the front of the machine, fasten it in place using screws **I** (screwing them in where the original feet were) then insert the new feet **H**.

Repeat at the back of the appliance.

Now adjust the feet **H** to raise or lower the appliance from 835mm to 870mm. Once you have reached the desired height lock the nuts **L** onto the crossbar **G**. To adjust the appliance to a height between 870mm and 900mm you need to mount strip **M**, adjusting feet **H** to the required height.

Insert strip **M** as follows: Loosen the three screws **N** situated at the front of the top cover of the appliance, insert strip **M** as shown in Fig.12, then fasten screws **N**.

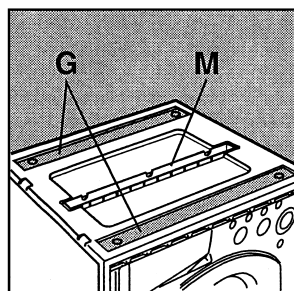

Fig. 10

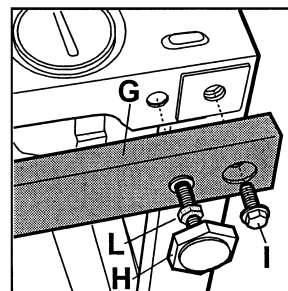

Fig. 11

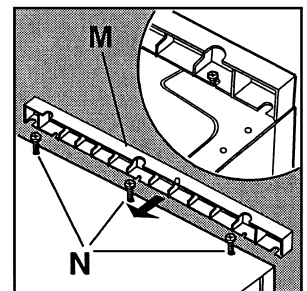
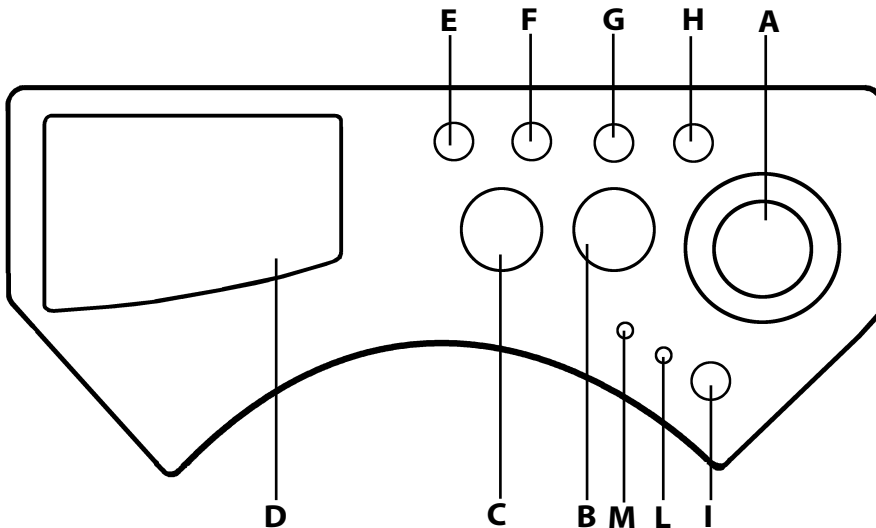

Fig. 12

The Controls

Understanding the Control Panel:



The Controls

	Washing Machine:	Washer Dryer:
A.	Programme Selection Knob and Programme Start	Programme Selection Knob and Programme Start
B.	Temperature Control Knob	Temperature Control Knob
C.	Spin Selection Knob	Drying Cycle Knob
D.	Detergent Dispenser	Detergent Dispenser
E.	Rinse Hold	Rinse Hold
F.	Quick Wash	Reduced Spin
G.	Intensive Wash	Quick Wash
H.	PreWash	Intensive Wash
I.	On / Off button	On / Off button
L.	Mains On / Off Indicator Light	Mains On / Off Indicator Light and Door Locked Indicator
M.	Door Locked Indicator	Drying Cycle Indicator

WARNINGS

- Do not allow children to play with the appliance or tamper with the controls.

Getting to Know Your Appliance

Functions - Washing Machine

WARNINGS

- **Do not overload appliance! It may damage laundry and reduce the quality of the wash.**

- A. Programme Selection knob...**
Turn the knob, clockwise only, until the symbol/letter of the required programme (refer to *Choosing a Wash Programme*) is in line with the pointer on the control panel. After the wash programme has been set and accepted by the washing machine, turning the Programme Selection knob will have no effect (except for when turned to position ● Stop/Reset).
- B. Temperature control knob...**
For each programme it is always necessary to select a temperature.
Used to set the required wash programme temperature (refer to the *Choosing a Wash Programme*).
It also allows you to reduce the recommended temperature for the selected programme and even to set a cold wash cycle.
- C. Spin selection knob...**
This is used to exclude the spin cycle (by selecting No Spin) or to reduce the spin speed of the selected programme. Maximum spin speeds for the four types of fabric are:
- | Fabric | Spin Speed |
|------------|------------|
| Cotton | 1200rpm |
| Synthetics | 800rpm |
| Wool | 600rpm |
| Silk | n/a |
- Note: distribution phase will be carried out at a low speed.
- D. Detergent Dispenser...**
The dispenser is divided into three compartments.
1. Pre-wash detergent compartment
 2. Main wash detergent compartment
 3. Fabric Conditioner compartment
- E. Rinse Hold...**
This function allows you to interrupt a programme (on symbol ♦♦) holding the laundry in the water before the final spin cycle. Before opening the door, finish the wash cycle as follows:
- | | |
|--------------------|--|
| Silk and curtains: | Press button E and the machine will drain the water. |
| Synthetics: | If you want a spin cycle - Press button E |
- OR**
Turn knob A to programme L if you want to drain the water.
- With 'Delicate Acrylics, Programme H' or 'Machine Wash Wool, Programme J' this function is not performed.*
- F. Quick Wash...**
Pressing this button reduces the length of the selected wash programme by about 30%. It cannot be used with special programmes or those for wool and silk.
- G. Intensive Wash...**
With this button you can carry out a more intensive wash that optimises the effectiveness of the detergents, thus allowing more resistant stains to be removed. If you use this function, you cannot activate the pre-wash cycle (Button H).
- H. Pre-Wash...**
With this button you can pre-wash on all programmes, except the wool programme and the special programmes (see *Choosing a Wash Programme*). If you use this function, you cannot use the Intensive Wash button.
- I. On / Off button...**
When pressed the appliance is switched on. When it is not the appliance is switched off.
Switching the appliance off does not cancel the selected programme.
- L. Mains On-Off Indicator Light...**
This light flashes when the appliance is switched on and awaiting a programme to be set. A steady light means that the appliance has accepted the selected programme.
- M. Door Locked Indicator Light...**
The door locked indicator light shows that the machine door is locked to prevent it from being opened accidentally. To avoid any damage to the mechanism you must wait until this light goes out before attempting to open the door.

Note: We recommend on completion of your programme that you switch off the appliance by pressing the 'ON/OFF'.

As a safety measure, switch off both the mains electricity and water supply to the appliance.

Getting to Know Your Appliance

Functions - Washer Dryer

- A. Programme Selection knob...**
Turn the knob, clockwise only, until the symbol/letter of the required programme (refer to *Choosing a Wash Programme*) is in line with the pointer on the control panel. After the wash programme has been set and accepted by the washing machine, turning the Programme Selection knob will have no effect (except for when turned to position ● Stop/Reset).
- B. Temperature control knob...**
For each programme it is always necessary to select a temperature.
Used to set the required wash programme temperature (refer to the *Choosing a Wash Programme*).
It also allows you to reduce the recommended temperature for the selected programme and even to set a cold wash cycle.
- C. Drying cycle knob...**
Use this to select the desired drying cycle. Two options are available:
A Based on time: from 40 minutes to 150 minutes
B Based on dry level required: Iron Dry: slightly damp clothes, easy to iron.
Hanger Dry: dry clothes to put away.
Extra Dry: very dry clothes, recommended for towelling and bathrobes.
- NB.** Each drying cycle ends with a Cooling Phase.
- D. Detergent Dispenser...**
The dispenser is divided into three compartments.
1. Pre-wash detergent compartment
2. Main wash detergent compartment
3. Fabric Conditioner compartment
- E. Rinse Hold...**
This function allows you to interrupt a programme (on symbol ◆◆) holding the laundry in the water before the final spin cycle. Before opening the door, finish the wash cycle as follows:
Silk and curtains: Press button E and the machine will drain the water.
Synthetics: If you want a spin cycle - Press button E
OR
Turn knob A to programme M if you want to drain the water.
With 'Delicate Acrylics, Programme J' or 'Machine Wash Wool, Programme K' this function is not performed.
- F. Reduced Spin...**
Use this button to reduce the spin speed from 1200 to 600rpm for the Cotton programmes and from 850 to 600rpm for the Synthetic fabric programmes.
- G. Quick Wash...**
This button reduces the length of the selected wash programme by about 30%. It cannot be used with special programmes or those for wool and silk.
- H. Intensive Wash...**
With this button you can select a more intensive wash that optimises the effectiveness of the detergents, thus allowing more resistant stains to be removed.
- I. On / Off button...**
When pressed the appliance is switched on. When it is not the appliance is switched off.
Switching the appliance off does not cancel the selected programme.
- L. Mains On-Off Indicator Light / Door Locked Indicator Light...**
This light flashes when the appliance is switched on and awaiting instructions at the end of a cycle, indicating that the door can be opened.
It flashes quickly when the door should not be opened.
A steady light means the appliance has accepted the selected programme.
- M. Drying Cycle Indicator Light...**
When this light is on it shows that knob C has been set on a drying cycle. At the end of the wash cycle the appliance will run the selected tumble drying cycle.

WARNINGS

- **Do not overload appliance! It may damage laundry and reduce the quality of the wash.**

Note: We recommend on completion of your programme that you switch off the appliance by pressing the 'ON/OFF'.

As a safety measure, switch off both the mains electricity and water supply to the appliance.

Choosing a Programme

Washing Machine: BWM12

IMPORTANT INFORMATION: Always observe the laundry items wash care label.

We recommend the Persil range of detergent products

Sort the laundry according to the wash care labels and the degree of soiling.

Close all zips and remove items from pockets.

Place the laundry in the drum loosely for best results, if possible combine large and small items. An overloaded drum will give unsatisfactory wash results.

TEMPERATURE CONTROL:

NOTE:

For each program it is always necessary to select a temperature.

IMPORTANT:

To cancel the wash programme you have just set, select one of the ● symbols (Stop/Reset) and wait for at least 5 seconds.

*Duration can depend on the temperature of the incoming water supply.

Type of fabric, dirt degree - Always observe the treatment advice of the fabric manufacturer						
	Programme Selection knob 'A'	Temperature Control knob 'B'	Detergent washing	Fabric Conditioner	Description of washing cycle	*Duration Minutes
COTTONS						
Exceptionally soiled whites	A	90°	✓	✓	Main wash 90°, rinse cycles, intermediate and final spin cycles	145
Heavily soiled whites	B	60°	✓	✓	Main wash 60°, rinse cycles, intermediate and final spin cycles	130
Heavily soiled whites and colourfast	C	40°	✓	✓	Main wash 40°, rinse cycles, intermediate and final spin cycles	150
Slightly soiled whites and delicate colours	D	40°	✓	✓	Main wash 40°, rinse cycles, intermediate and final spin cycles	95
Rinse cycles				✓	Rinse cycles, intermediate and final spin cycles	
Spin cycle					Draining and final spin cycle	
Stop / Reset	●				Interrupts / Cancels the selected programme	
SYNTHETICS						
Heavily soiled colourfast synthetics	E	60°	✓	✓	Main wash 60°, rinse cycles, anti-crease or delicate spin cycle	100
Heavily soiled non-colourfast synthetics	F	50°	✓	✓	Main wash 50°, rinse cycles, anti-crease or delicate spin cycle	95
Acrylics	G	40°	✓	✓	Main wash 40°, rinse cycles, anti-crease or delicate spin cycle	70
Delicate Acrylics	H	30°	✓	✓	Main wash 30°, rinse cycles, anti-crease or delicate spin cycle	30
Rinse cycles				✓	Rinse cycles, anti-crease or delicate spin cycle	
Fabric conditioner				✓	Rinse cycles with automatic introduction of softener, anti-crease or delicate spin cycle	
Spin cycle					Draining and delicate spin cycle	
Stop / Reset	●				Interrupts / Cancels the selected programme	
WOOL						
Machine wash wool	J	40°	✓	✓	Main wash 40°, rinse cycles and delicate spin cycle	45
Rinse cycles				✓	Rinse cycles and delicate spin cycle	
Spin cycle					Draining and delicate spin cycle	
Stop / Reset	●				Interrupts / Cancels the selected programme	
SILK						
Silks	K	30°	✓	✓	Main wash 30°, rinse cycles, anti-crease or draining	50
Rinse cycles				✓	Rinse cycle, anti-crease or draining	
Pump out	L				Pump out	
Stop / Reset	●				Interrupts / Cancels the selected programme	
PROGRAMMED START						
12 - 9 - 3 - 1 hour delay					Start is delayed by 12, 9, 3 or 1 hours	
Stop / Reset	●				Interrupts / Cancels the selected programme	

SPECIAL PROGRAMMES: 'A' Wash Performance - This machine has a special programme which allows you to obtain optimum results even at low temperatures. By setting programme 4 at a temperature of 40°C, you will get the same results as you would normally obtain at 60°C, thanks to the machine's action and the length of the wash cycle.

Choosing a Programme

IMPORTANT INFORMATION: Always observe the laundry items wash care label.

Washer
Dryer:
BWD12

We recommend the Persil range of detergent products

Sort the laundry according to the wash care labels and the degree of soiling.

Close all zips and remove items from pockets.

Place the laundry in the drum loosely for best results, if possible combine large and small items. An overloaded drum will give unsatisfactory wash results.

TEMPERATURE CONTROL:

NOTE:

For each program it is always necessary to select a temperature.

IMPORTANT:

To cancel the wash programme you have just set, select one of the ● symbols (Stop/Reset) and wait for at least 5 seconds.

*Duration can depend on the temperature of the incoming water supply.

Type of fabric, dirt degree - Always observe the treatment advice of the fabric manufacturer						
	Programme Selection knob 'A'	Temperature Control knob 'B'	Detergent washing	Fabric Conditioner	Description of washing cycle	*Duration Minutes
COTTONS						
Exceptionally soiled whites	A	90°	✓	✓	Prewash, Main wash 90°, rinse cycles, intermediate and final spin cycles	165
Exceptionally soiled whites	B	90°	✓	✓	Main wash 90°, rinse cycles, intermediate and final spin cycles	145
Heavily soiled whites and colourfast	C	60°	✓	✓	Main wash 60°, rinse cycles, intermediate and final spin cycles	130
Heavily soiled whites and colourfast	D	40°	✓	✓	Main wash 40°, rinse cycles, intermediate and final spin cycles	150
Slightly soiled whites and delicate colours	E	40°	✓	✓	Main wash 40°, rinse cycles, intermediate and final spin cycles	95
Rinse cycles				✓	Rinse cycles, intermediate and final spin cycles	
Spin cycle					Draining and final spin cycle	
Drying cycle for cotton fabrics					Full Heat	
Stop / Reset	●				Interrupts / Cancels the selected programme	
SYNTHETICS						
Heavily soiled colourfast synthetics	F	60°	✓	✓	Main wash 60°, rinse cycles, anti-crease or delicate spin cycle	100
Heavily soiled non-colourfast synthetics	G	50°	✓	✓	Main wash 50°, rinse cycles, anti-crease or delicate spin cycle	95
Acrylics	H	40°	✓	✓	Main wash 40°, rinse cycles, anti-crease or delicate spin cycle	70
Delicate Acrylics	J	30°	✓	✓	Main wash 30°, rinse cycles, anti-crease or delicate spin cycle	30
Rinse cycles				✓	Rinse cycles, anti-crease or delicate spin cycle	
Fabric conditioner				✓	Rinse cycles with automatic introduction of softener, anti-crease or delicate spin cycle	
Spin cycle					Draining and delicate spin cycle	
Drying cycle for synthetic fabrics					Half Heat	
Stop / Reset	●				Interrupts / Cancels the selected programme	
WOOL						
Machine wash wool	K	40°	✓	✓	Main wash 40°, rinse cycles and delicate spin cycle	45
Rinse cycles				✓	Rinse cycles and delicate spin cycle	
Spin cycle					Draining and delicate spin cycle	
Drying cycle for wool						
Stop / Reset	●				Interrupts / Cancels the selected programme	
SILK						
Silks	L	30°	✓	✓	Main wash 30°, rinse cycles, anti-crease or draining	50
Rinse cycles				✓	Rinse cycle, anti-crease or draining	
Pump out	M				Pump out	
Stop / Reset	●				Interrupts / Cancels the selected programme	
PROGRAMMED START						
12 - 9 - 3 hour delay					Start is delayed by 12, 9 or 3 hours	
Stop / Reset	●				Interrupts / Cancels the selected programme	

SPECIAL PROGRAMMES: 'A' Wash Performance - This machine has a special programme which allows you to obtain optimum results even at low temperatures. By setting programme 4 at a temperature of 40°C, you will get the same results as you would normally obtain at 60°C, thanks to the machine's action and the length of the wash cycle.

The Dispenser Drawer

IMPORTANT:

- Do not exceed the maximum levels.

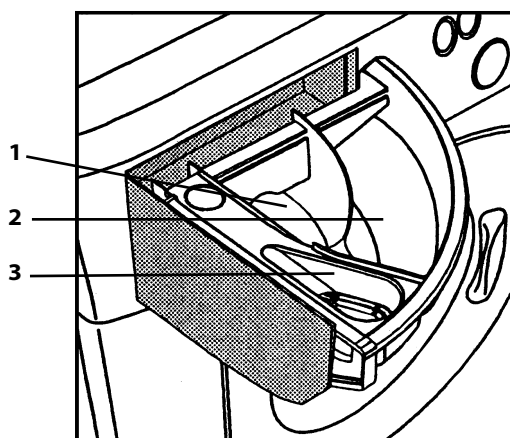

Index

1. Pre-wash detergent compartment
2. Main wash detergent compartment
3.  Fabric conditioner compartment

NB. Choose 'low suds' automatic powder, liquid or tablets, designed specifically for automatic washing machines / washer dryers. DO NOT use handwash detergent as excessive suds occur.

The dispenser drawer is opened by rotating outwards.

Adding Detergent

● (1) Pre-wash tray (powder) and (2) Main wash detergent tray (powder or liquid)

To obtain the desired wash results and optimum detergent consumption, determine the amount of detergent in relation to the water hardness in your area, the type and quantity of laundry and its degree of soiling. Detergent packages indicate the amount, according to four levels of hardness and for normal soiled loads from 4 - 5 kg. Contact your local water board for information concerning the degree of water hardness in your area.

Follow all detergent manufacturers dosage recommendations.

For normal soiling, choose a programme without pre-washing, add detergent to compartment 2. For heavily soiled loads choose a programme with pre-washing, add detergent to compartments 1 and 2.

If there is no indication of recommended dosage for a delicate wash, use $\frac{1}{2}$ to $\frac{2}{3}$ of the recommended dosage indicated for wash resistant cotton fabrics.

For a wool programme we recommend that you only use neutral detergents for wool and follow the detergent manufacturers recommended dosage.

● (3) Fabric conditioner

The conditioner is designed to make your clothes soft and pleasant smelling. Do not exceed the maximum level indicated.

Overdosing the amount of detergent does not improve the quality of the wash and could cause excessive suds potentially leading to an overflow.

The dispenser can be removed and cleaned (see Cleaning section, page 20).

NB. When washing with cold water, always reduce the amount of detergent you use - it dissolves less easily in cold water than in hot water, so some would be wasted.

Using your appliance

Setting a Wash Programme / Starting the appliance

Load the laundry into the appliance and close the door. Load the detergent. Set the required programme. Turn the Temperature knob to that of the selected programme.

Press on the 'On/Off' button.

The On/off Indicator light (L) will start to flash. After a short time the selected programme will be accepted and the light will stop flashing and the wash cycle will begin.

After washing and/or drying

Press the 'On/Off' button to switch off the appliance. The Operating Indicator light will go out. Wait until the Door Locked indicator light goes out before opening the door, to allow the safety device to disconnect. Unload the laundry.

Cancelling or changing the programme

Should you wish to interrupt the programme in progress or set a new one, turn the Programme Selection knob to select one of the symbols ● (Stop/Reset). After a short time the cancellation will be accepted, the On/Off Indicator light will flash - you can then either turn the appliance off or select another programme.

Delayed start

Use the Programme Selection knob to delay the start of the selected wash programme:

Select one of the delay time positions (12, 9, 3 or 1 hours with Washing Machine Model BWM12 and 12, 9 and 3 hours with Washer Dryer Model BWD12), press the On/Off button wait a short time until the On/Off indicator light stops flashing to show the setting has been accepted.

You can now select the programme required.

The On/Off indicator light has a particular flashing motion (2 seconds on and 4 seconds off) to indicate that a delayed start has been set.

During the 'delay' you can open the door and change the wash load, should you wish to do so.

IMPORTANT:

- Do not open the door to stop the appliance.
- Do not try to open the door while the Door Locked Indicator light is lit.

Using your appliance *cont...*

IMPORTANT:

- If you use in-drum dosing for your washing programme please ensure the plastic container is removed before a drying programme

How to dry (Washer Dryer only).

A Combined Washing and drying programme

See table below and follow instructions provided for MAX load to have an automatic washing and drying cycle.

- Select the wash programme.
- Select the programme wash temperature.
- Set the Drying Cycle knob C to the type of drying cycle required. Drying times vary in accordance to spin speed, the higher the spin speed the shorter the drying time and therefore the lower consumption of electricity. The highest possible spin speed for your type of laundry is recommended.

NB. If a spin speed has not been selected the appliance will not carry out the automatic drying cycle:

- Press the On/Off button, I, to start the washing and drying programme.

Fabric Type	Load Type	Maximum Load	Approximate Drying Time (minutes)		
			Extra Dry	Hanger Dry	Iron
Cotton, Linen	Clothing of different sizes	4kg	155	140	130
Cotton	Terry Towels	4kg	155	140	130
Terital, Cotton	Sheets, Shirts	2.5kg	110	100	90
Acrylics	Pyjamas, socks etc.	1kg	65	60	60
Nylon	Slips, Tights, Stockings etc.	1kg	65	60	60

If the laundry load to be washed and dried exceeds the maximum listed in the table, then follow instructions for Wash only. When the Wash Programme has finished, divide up the wash load and set a drying only programme. Repeat for the remaining wash load.

IMPORTANT:

- Make sure the water supply taps are turned on during the drying cycles.

Drying only

Once you have loaded the washing to be dried (refer to table for Max. load).

- Ensure that the door is shut correctly, both the mains electricity and water supply is turned on.
- Ensure the On/Off button, I, is depressed to the ON position.
- Set the Programme Selection knob, A, to the appropriate drying setting ☀ (depending on fabric type).
- Set the Drying Cycle knob, C, and press the On/Off button, I, to ON.
- Wait for the On/Off Indicator / Door Locked Indicator light, L, to flash slowly, then press the On/Off button, I, OFF.
- Now you can open the door and remove the laundry.

Wool drying cycle

The drying cycle for woollen garments should only, and exclusively, be run together with the selection of a specific cycle time (150 - 100 - 60 - 40 minutes).

We recommend a **60 minute drying cycle for a 1kg load.**

If one of the three levels (Extra Dry ☐, Hanger Dry ☐, Iron ☐) is selected by mistake, the appliance will run a drying cycle lasting the Max. time foreseen (150 minutes).

Important

A spin cycle is carried out during the drying if you have set a cotton programme and a level of dryness (Extra Dry ☐, Hanger Dry ☐, Iron ☐).

Washcare tips

Cutting costs effectively:-

- **Maximise the load size** Achieve the best use of energy, water, detergent and time by using the recommended maximum load size. Save up to 50% energy by washing a full load instead of 2 half loads.
- **Do you need a pre-wash?** For heavily soiled laundry only! Save detergent, time, water and between 5 to 15% energy consumption by NOT selecting pre-wash for slight to normal soiled laundry.
- **Is a hot wash required?** Pretreat stains with stain remover or soak dried in stains in water before washing to reduce the necessity of a hot wash programme. Save up to 50% energy by using a 60°C wash programme.
- **Before using a drying programme** Save energy and time by selecting a high spin speed to reduce the water content before using a drying programme (Washer Dryer only).

Washing

Before washing laundry:-

- Pre-treat stains.
- Close zips, fasten belts, tie strings etc... and press studs to prevent tangling.
- Remove all items from pockets.
- Limit size of absorbent loads to give good washing/rinsing results.
- Place small items in a wash bag.
- Check wash labels as some items may require a cool programme.
- Wash non-colour fast items, woollens or really dirty clothes separately as they may affect other items.
- Laundry will not wash properly if you over load your appliance.
- Laundry without a wash label should not be machine washed.

Drying (Washer Dryer only)

To carry out a drying only programme the laundry must previously have been washed and spun.

- When drying bedspreads, single blankets etc... we recommend that you remove, shake and reload during the cycle to ensure faster and more even drying.
- Starched articles should be dried together to avoid distribution of starch onto non-starched items.
- Be careful not to over dry.
- After you have dried a particularly 'fluffy' load or you have used the machine as a dryer only, you MUST, after the load has been removed, set your machine to rinse and spin.

Items Not Suitable For Tumble Drying

- Garments with the ITCL code -DO NOT TUMBLE DRY
- Woollens - except on special dry programme (see page 15).
- Large bulky items eg. quilts, bedspreads pillows etc... expand when dry, preventing air flow through the appliance.
- Items containing plastic film, foam rubber or rubber like materials eg. pillows, cushions, PVC rainwear or inflammable articles which contain inflammable substances eg. towels contaminated with hair lacquer.
- Fibreglass (eg. some types of curtains).
- Items which have been dry cleaned.

Cleaning

WARNING

- **Disconnect from the electricity supply before cleaning.**
- **Do not clean any part of your appliance with abrasive cleaners, scouring agents, acids, chlorine based bleach or metal polish as they may cause damage.**

Removing and Cleaning the Dispenser Drawer...

Note: It is advisable to clean the detergent compartment regularly. To do this:

- 1 Open the drawer out as far as it will go. Lift it up (1) and pull (2), this should release it from its housing.

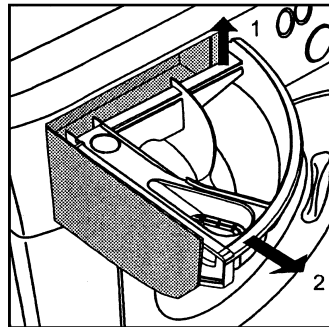

- 2 Rinse all parts under the tap (take care to remove any excess water remaining inside the compartment)

Cleaning the Exterior...

Use only soap and warm water to clean the exterior surfaces of the appliance.

Use a soft cloth moistened with water when cleaning the plastic parts (control panels, plinth etc.)
Dry using a clean soft cloth.

Cleaning the Door...

Use a soft cloth with soap and warm water to wipe over the door bowl and along the rubber seal.
Dry using a clean soft cloth.

Troubleshooting...

Incidents may occasionally occur when you are using your appliance, if so, check the following points:

My appliance does not work

Check:

- water and power supplies and the fuse.
- if the door is closed properly.
- have you selected a delayed start?

It will not load water

Check:

- it is plugged in and switched on.
- if the door is closed properly.
- the water supply taps are turned on.
- the fill hoses are connected correctly and are not kinked.

After having checked the points listed above, turn off the appliance, re-select the program and then switch the appliance on.

It loads and discharges continually

Check:

- the drainage hose is positioned correctly ie. not too low creating a syphoning effect.

It vibrates when spinning

Check:

- it has been properly unpacked, have the transit bolts been removed?
- machine is level.
- if it is knocking against the unit.

There is water on the floor

Check:

- the water supply pipe connectors are tight).
- the end of the drainage pipe has not moved out of position.

It does not empty

Check:

- the drainage pipe is not kinked or trapped.

Poor wash

Check:

- that you selected the correct wash temperature.

The Programme Selection knob keeps turning

- wait a few minutes for the drum to empty - switch off, select one of the ● symbols (Stop/Reset), then switch back on.

It will not drain water or spin

Check:

- if the selected programme includes draining, some require manual draining selection.
- is Rinse Hold selected, this function will hold laundry in the water until spin / draining is set manually.
- is the drainage hose bent / squashed.

No spin

Check:

- if the Spin Selection knob has been set to No Spin (Washing Machine only).
- You have an unbalanced load, the laundry is not evenly distributed inside the drum. Open the door, rearrange the wash load by hand and run a spin only programme.

Too many suds form in the drum and it comes out of the drawer

Check:

- you are using detergent suitable for automatic washing and not washing by hand.
- you have not exceeded the detergent manufacturers recommended dosage.

Fabric Conditioner remains in the dispenser or there is too much water left there

Check:

- the syphons are not clogged up, clean the dispenser drawer if necessary.

The laundry will not dry

(Washer Dryer only)

Check:

- the cold water tap is open.
- the load of laundry is not too large.
- the selected drying time is sufficient.
- have you selected a delayed start?

If there is still a problem contact Hotpoint Service (see KEY CONTACTS back cover).

General Maintenance...

● **Maintenance of internal parts:**

In the interest of hygiene (eg. to prevent mould):
- every month or so, clean the plastic and rubber parts around the tub access using a slightly chlorinated product.
Rinse thoroughly.
- do a wash cycle at 90° at least once a month.

● **Periodic Checks:**

You should check the condition of the water inlet and the drain hoses. If you find any splits, however minor, do not hesitate to replace them, call our Genuine Parts & Accessories Hotline, see back cover for details.

Remember you may be charged for a service call if a problem with your appliance is caused by incorrect installation or misuse.



After Sales Service

“No company is better positioned to offer an after sales service on a Hotpoint appliance than us - the manufacturer”

As part of our commitment to you, all Hotpoint appliances have the added benefit of a fully inclusive parts and labour guarantee for the first 12 months. In addition to this you also have the advantage of **free replacement parts for the first 5 years** when fitted by a Hotpoint engineer. When the 12 months parts and labour guarantee expires we offer the following after sales service options:

Repair Service and Information Help Desk

UK: 08709 066066

www.theservicecentre.co.uk

Republic of Ireland: 1850 302 200

Note: Our operators will require the Model number and the Serial number of your appliance (see USEFUL ADVICE SECTION for rating plate position).

Available 364 days a year with a fast, effective and value for money service. We have the largest white goods repair service in the UK with over 1200 of our own fully trained engineers. All repairs include a parts and labour guarantee for 12 months from the date of the repair.

If you require any information or have any questions about your appliance, our operators are on hand with help and advice.

All this ensures that you will receive the best available after sales service possible.

Extended Warranties

UK: 08709 088 088

www.theservicecentre.co.uk

Republic of Ireland: 1850 502 200

Whether you have just one or a number of Hotpoint appliances in your kitchen, we offer two service cover plans to give you total peace of mind.

- Repair Protection Plan - FREE service repairs for a single Hotpoint appliance during the period of cover.
- Kitchen Cover - FREE service repairs for all your Hotpoint appliances less than 8 years old.

Genuine Parts and Accessories

UK: 08709 077 077

www.theservicecentre.co.uk

Republic of Ireland: (01) 842 6836

A wide range of genuine parts and accessories are available from our hotline or through our web site.

Genuine parts and accessories, extended warranties and service repairs are all available on our web-site at:



www.theservicecentre.co.uk



Guarantee

“Satisfaction guaranteed or your money back”

We give you a unique ‘satisfaction guaranteed’ promise - **valid for 90 days** - after you have purchased your Hotpoint appliance. If there is a technical problem simply call Hotpoint Repair service or visit our web-site at www.theservicecentre.co.uk and where necessary, we will arrange for an engineer to call. If the technical problem is not resolved under this guarantee, **we will replace your machine or, if you prefer, give you your money back.**

All Hotpoint appliances carry a fully inclusive 12 month parts and labour guarantee as well as free replacement parts for the first 5 years (except microwaves, selected integrated appliances and cooker hoods, which have a one year guarantee) provided that they are fitted by a Hotpoint engineer.

Guarantee terms and conditions

Your guarantee is only applicable in the United Kingdom or Republic of Ireland and is subject to the following provisions that your appliance:

- Has been installed and used correctly in accordance with this instruction booklet.
- Has been used solely for domestic purposes and is located on domestic premises (ie. not for commercial or trade use).
- Has been properly connected to a suitable electrical supply voltage as stated on the appliance rating plate.
- Has not been subject to misuse, accident, modified or repaired by anyone other than one of our own service engineers.



For pre purchase information on any other Hotpoint product call: 08701 50 60 70
or visit: www.hotpoint.co.uk



Recycling & Disposal Information

As part of Hotpoint’s continued commitment to helping the environment, Hotpoint reserves the right to use quality recycled components to keep down customer costs and minimise material wastage.

Please dispose of packaging and old appliances carefully.

To minimise risk of injury to children, remove the door, plug and cut mains cable off flush with the appliance. Dispose of these parts separately to ensure that the appliance can no longer be plugged into a mains socket, and the door cannot be locked shut.



Key Contacts

After Sales Service

Over 1200 trained specialists, directly employed by us, ensure that you can have complete confidence in both the appliances and services we offer.



Repair Service and Information Desk

UK: 08709 066 066

(Open 8 to 8 Mon - Fri, 8 to 6 Sat, 10 to 4 Sun & Bank Holidays)

www.theservicecentre.co.uk

Republic of Ireland: 1850 302 200

Note: Our operators will require the following information:

Model number:

Serial number:

Extended Warranties

UK: 08709 088 088

(Open 8 to 8 Mon - Sun)

www.theservicecentre.co.uk

Republic of Ireland: 1850 502 200

Genuine Parts and Accessories

UK: 08709 077 077

(Open 8-30 to 5-30 Mon - Fri & 9 to 12 Sat)

www.theservicecentre.co.uk

Republic of Ireland: (01) 842 6836

General Domestic Appliances Limited, Morley Way, Peterborough, PE2 9JB.

Free Manuals Download Website

<http://myh66.com>

<http://usermanuals.us>

<http://www.somanuals.com>

<http://www.4manuals.cc>

<http://www.manual-lib.com>

<http://www.404manual.com>

<http://www.luxmanual.com>

<http://aubethermostatmanual.com>

Golf course search by state

<http://golfingnear.com>

Email search by domain

<http://emailbydomain.com>

Auto manuals search

<http://auto.somanuals.com>

TV manuals search

<http://tv.somanuals.com>