



ELECTRICAL



A1



B1

REPRODUCTION AUTOLITE BATTERIES

Autolite batteries are an excellent reproduction for your '65-'72 Mustang. Case is original type with proper lettering. Case also includes original "tabs" for proper mounting on early batteries. Batteries include state-of-the-art "guts" for easy starting. Group 24 only currently available. Shipped dry (you will need to find a local source for Electrolite). L10.75" W/Tab x W6.75" x H9".

- 65-72 .. AUT-B101 500 Cold cranking amps ... 99.00
- 65-72 .. AUT-B102 650 Cold cranking amps . 129.95

AUTOLITE BATTERY COVER **NEW!**

Give your car the original look, with the use of any 24F60 flat top maintenance free battery with the correct post location. Easy to install, just follow the instructions.

- A1 65-72 .. AUT-C101 Cover & Tag 44.95

OPTIMA BATTERY

Optima is a sealed, zero-maintenance battery that last longer, recharges faster, more dependable than any battery on the market. It can't even leak, so it can be shipped UPS ready to go! L9.94" x W6.75" x H7.81"



- B1 65-73 .. 800S 800 Cold cranking amps . 139.95

BATTERY CABLE BRACKETS & GROMMETS

- C1 65-66 .. C5ZZ-14302KR Bracket with Grommets ... pr.9.95
- 65-66 .. STARTER GROMMET Grommet only 1.99

MOTORCRAFT BATTERY CABLES

These cables give you the 60's look with 90's Performance.

- 65-68 .. 64-GRW Engine to firewall 6.95
- 65-73 .. 7164 Solenoid to Starter 14.95
- 65-73 .. 7304 Ground Cable 16.95
- 65-73 .. 7364 Battery to Solenoid 14.95

DIAMONDBACK SHIELDED BATTERY CABLES

Braided alloy shielding gives you the great "Braided" look and resists heat and abrasion. Heavy duty 4 gauge cable with Solid brass terminals - 3 times more conductive than lead.



- 65-73 .. 20142 Solenoid to Starter 13.95
- 65-73 .. 20038 Ground Cable 15.99
- E1 65-73 .. 20012 Battery to Solenoid 11.99

YOUR MUSTANG'S ELECTRICAL SYSTEM

Like most cars, your Mustang's electrical system consists of a "primary" and "secondary" system. The "primary" system is everything related to the engine's starting and ignition system. The "secondary" system consists of all wiring for headlights, taillights, and interior lights. Refer to the wiring diagram books that we sell. Also, pick up a (Repro) Shop Manual . After studying the schematics for some time, you'll easily understand how everything works. We have grouped this section by specific areas (starting, charging, interior, headlights, taillights and wiring looms), to help you find what you may need.

Note: 12 volt negative ground means that your Mustang's frame and metal body is the negative side of the electrical system. The wiring in your car carries the positive side to lights, etc.



D1



E1



C1

CONCOURS BATTERY CABLE SETS

Sets of Three Concours Quality, Style and Markings.

- 65-66 .. 64-BC-6 I6 49.95
- D1 65-66 .. 64-BC-8 V8 49.95
- 67-69 .. 67-BC-6 I6 49.95
- 67-69 .. 67-BC-8 V8 49.95
- 70-71 .. 70-BC-6 I6 49.95
- 70-71 .. 70-BC-8 V8 49.95
- 72-73 .. 72-BC-6 I6 49.95
- 72-73 .. 72-BC-8 V8 49.95

BATTERY POST TO FENDER SHIELD

- 66 C6ZZ-10760AR Can be used on '65 2.95



BATTERY HINTS

When replacing the battery, wear safety goggles, and make sure the ignition is in the "off" position. Keep flame and sparks away. When picking up the battery, avoid pressing on sides, as it may force gas and/or acid from the top. Replace clean cable ends, before installing your new battery. Be sure cables are properly oriented

positive (+) and negative (-). On '64-'73 Mustangs, the positive cable is mounted between the positive battery terminal and solenoid, and is usually shorter. The negative cable goes from the battery (neg) to the engine block (ground).

Note: Most "dead" batteries that fail to start on a cold morning, many times is actually because of dirty battery terminals and cable ends.

ELECTRICAL



BATTERY TRAY

G1	65-73 .. BM-1000	Mat, kills acid on contact	4.95
	65-70 .. HDWR-244	Hardware Kit	3.75
H1	65-66 .. C5ZZ-10732CR	All	14.95
H1	67-70 .. C7ZZ-10732CR	All	24.95
H1	71-73 .. D00Z-10732CR	All	16.95
H1	71-73 .. D00Z-10732B	All	25.00

65-66 BATTERY TRAY HOLD DOWN UPGRADE KIT

A must for 65-66 owners that are not using the original style (27F) battery. This allows you to securely bolt down a group 24 battery due to the missing tabs that are on the side of the battery. Use (H2) 67-70 Bracket & Bolt kit to complete the installation.

J1	C5ZZ-10732BR	Conversion bar	14.95
----	--------------------	----------------------	-------

BATTERY TRAY HOLD DOWN

H3	65-66 .. C5DZ-10718AR	4.95	
	65-66 .. HDWR-232	Nut & Bolt	1.00
H2/4	67-70 .. C5AZ-10718AR	Bracket & Bolts	12.95
H4	67-70 .. D0AZ-10756AR	J-Bolts	pr. 6.95
	71-73 .. D30Z-10718B	10.00	



1965-66 Battery Conversion. "U" Shape bracket. Single bolt installation.

TRUNK MOUNT BATTERY KIT

Provides better weight distribution and traction. All necessary hardware included.

K1	64-73 .. TMB-101	All	69.95
----	------------------------	-----------	-------

IGNITION SWITCH

L2	65-66 ... C3AZ-11584A	Bezel	15.00	
L1	65-66 ... SW-583	Switch	15.95	
	65-66 .. C4DZ-10A885AR	Spacer	8.95	
L4	67-68 ... C60Z-11584A	Bezel	12.00	
L3	67	SW-417	Switch	17.95
	68-69	SW-1054	Switch	18.95
	69	BP1895	Bulb, Switch lamp	pr.1.39
	70	SW-882	Switch	31.95
	71-72	SW-992A	Switch	27.95
	73	SW-1038	Switch	23.95



IGNITION RESISTOR WIRE

Used between Ignition and Coil to prevent point burn.

	65-69 ... DY-37	Wire	9.95	
	70-72 ... DY-84A	Wire	29.95	
	73	DY-85	Wire	16.95

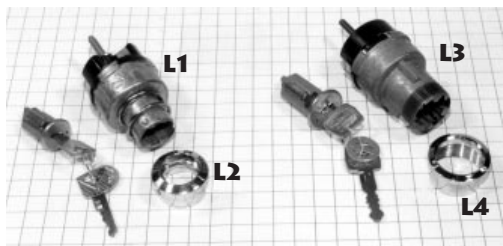

REMANUFACTURED STARTERS

Remanufactured, ask for current details on core.

65	76060	260, 289, AT	59.95
65-66 ..	76062	260, 289, MT	59.95
65-70 ..	76061	16, AT	59.95
67-70 ..	76069	200, MT	69.95
67-70 ..	76061	BB	59.95
68-72 ..	76062	302, MT	59.95
68-73 ..	76060	250, AT	59.95
69-70 ..	76062	351, MT	59.95
69-73 ..	76060	351, AT	59.95
69-71 ..	76063	429	59.95



HOW DO I KNOW MY IGNITION SWITCH IS BAD?

If your ignition switch fails to engage the starter, it may be bad. After hundreds of starts, this switch can wear down by dirty or worn contacts. A bad switch can also cause the solenoid and starter to "stick on", and also fail to engage the accessories contact.



ELECTRICAL

STARTER SOLENOID

	65-73 .. HDWR-266	Mounting screws	1.00	
M1	64-73 .. SW-3	ALL	21.00	
Solenoids with the concours markings and color.				
	64-65 .. C5AZ-11450AR	All	34.95	
	66	C6AZ-11450AR	All	34.95
	67-71 .. C7AZ-11450AR	All	34.95	
	72-73 .. D2AF-11450AR	All	34.95	

CONCOURS VOLTAGE REGULATOR

	65-73 .. HDWR-266	Mounting screws	1.00	
	65-66 .. HDWR-436	Mounting screw protectors ..	1.00	
N1	64	C2AF-10505BR	Gen	49.95
N1	64	C4TF-10316DR	Gen W/ AC	44.95
N2	65-67 .. C5AF-10316BR	Black	44.95	
N3	68-70 .. C8TF-10316AR	Blue	44.95	

ELECTRONIC VOLTAGE REGULATOR

For state-of-the-art voltage for your early Mustang, this regulator will do the job. Bolt in replacement. A must w/ 120 amp alternators.

	65-73 .. HDWR-266	Mounting screws	1.00
N4	65-73 .. GR-540-A	All	44.95

REMANUFACTURED GENERATOR

Remanufactured, ask for current details on core.

P1	64	5855	I6	89.95
P1	64	5838	V8	59.95

GENERATOR WIRE HARNESS

64	64-GEN-6	I6	59.95
64	64-GEN-8	8Cyl	59.95

REMANUFACTURED ALTERNATOR

Remanufactured, ask for current details on core.

Q1	65-69 .. 66189	I6, 60 Amp	69.95
Q1	65-68 .. 66190	SB, FE, 60 Amp	59.95
Q1	72-73 .. 66197	250, 100 Amp	149.95
Q1	72-73 .. 66198	302, 100 Amp	149.95
Q1	72-73 .. 66198	351, 100 Amp	149.95
Q1	65-73 .. ALT-101	Terminal Covers	4.95

ALTERNATOR - HI-PO PULLEY

Bolt-on HP! Factory on all 65'-68' Shelby High rpm pulley

65-70 .. C5ZZ-10344AR	Steel	29.95
-----------------------------	-------------	-------

ALTERNATOR - WIRING HARNESS (E5)

Alternator to Regulator. (1 of 3 under hood looms) Attaches to the back of alternator, plugs into main headlight harness and ground.

65	65-ALT-101	I6 W/ Lamps	21.95
65	65-ALT-102	V8 W/ Lamps	21.95
65	65-ALT-103	I6 W/ Gauges	21.95
65	65-ALT-104	V8 W/ Gauges	21.95
66	66-ALT-105	I6 All	19.95
66	66-ALT-106	V8 All	19.95
67-68 ..	67-ALT-107	I6 W/O Tach	21.95
67-68 ..	67-ALT-108	V8 W/O Tach	29.95
67-68 ..	67-ALT-110	BB W/ Tach	29.95
69	69-ALT-111	All W/O Tach	24.95
69	69-ALT-112	All W/ Tach	49.95
70	70-ALT-113	All W/O Tach	29.95
70	70-ALT-114	All W/ Tach	49.95
71	71-ALT-115	All W/O Instrument	39.95
71	71-ALT-116	All W/ Instrument	39.95
72	72-ALT-117	All W/O Instrument	39.95
72	72-ALT-118	All W/ Instrument	39.95

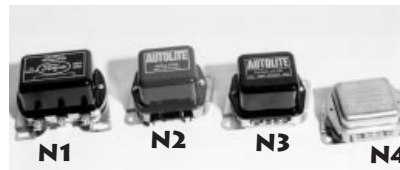

ALTERNATOR TROUBLESHOOTING

The alternator is the one part that tells you when it's going bad. When the light on the dash (ALT) comes on, or flickers, it usually means that one (or both) of the two diodes in the alternator has failed, and it's time for a new or rebuilt one. If you're unsure, a local shop can run an electrical test on the alternator, voltage regulator and battery. Sometimes a low engine idle, and/or loose belt can make the "ALT" light flicker. When an alternator fails it usually takes the voltage regulator along with it. So it's highly advisable to replace both. If you drive your Mustang a lot, we recommend a state-of-art Motorcraft Voltage Regulator No. GR-540-A ('65-'73). For '67-'70 Shelybs and '68 California Specials, a higher amp alternator is recommended for those Cougar/T-Bird taillights. Use higher amp versions for air conditioning, too. Concours Restorers should rebuild their alternators with our kit instead of a rebuilt/exchange.



MUSTANG WIRING LOOMS AND HARNESSSES

Rewiring your Mustang, using reproduced looms and harnessses should not seem as difficult as at first impression.

Your Mustang is basically made up of an under-dash harness with two attached "looms." These looms include the firewall to headlamp and dash to taillight. From the firewall to headlamp loom is attached the alternator to voltage regulator loom. Courtesy lights (roof) come off the taillight loom. The under-dash harness includes many plugs for the headlight, turn signal and wiper switches. The cigar lighter, radio, courtesy lights, dash lights, tach, etc., also go through the under-dash harness. If you're thoroughly confused by now, get a copy of the Wiring Diagrams Book.

If you are unsure about wiring your car, an auto electric shop can install your looms for you. Don't attempt wiring, splicing, etc., unless you know what you're doing, as an electrical fire can result from a "mistake."

ELECTRICAL

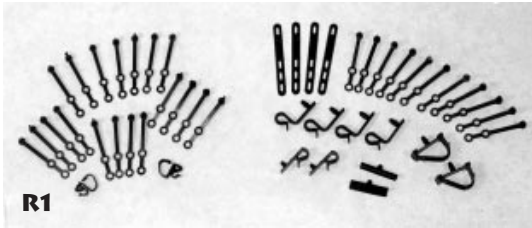

T1

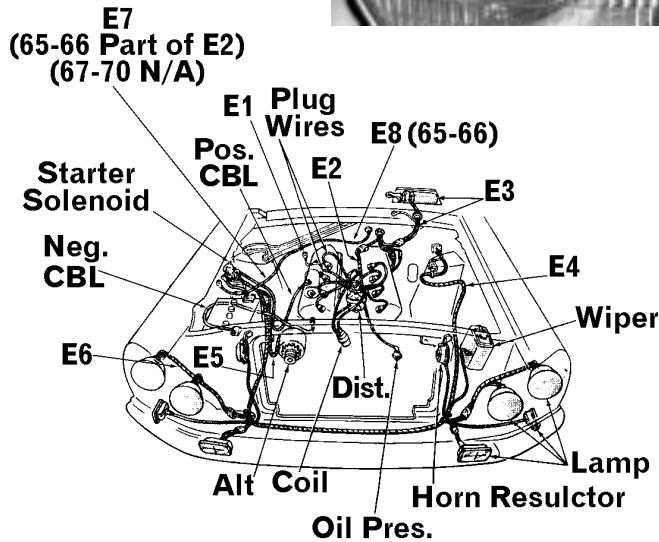

- E1 - Heater Motor, '65-66 Part of E2
- E2 - Engine Gauge Feed
- E3 - Hood turn signal wiring
- E4 - Headlamp loom wiring harness
- E5 - Alternator wiring loom
- E6 - Headlamp wiring extension '67-70
- E7 - Firewall to solenoid N/A '67-70



HOW DO I KNOW IF MY HEADLIGHT SWITCH IS BAD?

If your headlights dim or flicker, or if your dash and/or taillights flicker, then the switch is bad. Circuit breakers are in the switch, and after much use, can fail. Remember to depress button on side of switch to remove switch handle (pulls out).

ALTERNATOR - BRACKETS

65-73 ... GY-934	Adjusting Bracket	43.00
65-73 ... GY-1014	Mounting Bracket	30.00
65-73 ... YS-30	Mounting Spacer	7.00
65-69 .. M-10313-A302	Chrome Motorsport	pr.24.95

WIRE LOOM MOUNTING KIT

Includes all straps, anchors and clips need to install loom.

R1 64-66 .. C5ZZ-14000KR	21 piece kit	14.95	
67	C7ZZ-14000KR	25 piece kit	19.95
68	C8ZZ-14000KR	24 piece kit	19.95
69	C9ZZ-14000KR	25 piece kit	24.95

NEW!

ENGINE GAUGE FEED (E2)

From firewall to engine components. On 64-66 it also plugs into heater blower motor. (1 of 3 under hood wire looms)

65-73 .. O/P EXT	Oil sending unit extension ...	9.95	
65-73 .. HDWR-116	"J" wire clip for O/P EXT	3.00	
64	64-GF-101	I6	34.95
64	64-GF-102	V8	34.95
65	65-GF-103	I6, w/lamps	29.95
65	65-GF-104	V8, w/lamps, 2 spd. heater	29.95
65	65-GF-104A	V8, w/lamps, 3 spd. heater	34.95
65	65-GF-105	I6, w/gauges	34.95
65	65-GF-106	V8, w/gauges	34.95
66	66-GF-107	I6	34.95
66	66-GF-108	V8	34.95
67-68 ..	67-GF-109	I6	21.95
67-68 ..	67-GF-110	SB, w/o tech	21.95
67-68 ..	67-GF-111	SB, W/tech	21.95
67-68 ..	67-GF-112	BB	21.95
68	68-GF-113	SB, w/AC	27.95
69-70 ..	69-GF-114	I6	31.95
69-70 ..	69-GF-115	SB	24.95
69-70 ..	69-GF-116	BB	21.95
69	69-GF-119	Boss 302	34.95
71-73 ..	71-GF-117	SB	21.95
71-73 ..	71-GF-118	BB	21.95

FUSE - PARTS

65-68 .. FS-CL	Fuse Clips (10)	10.95
65-73 .. 66421	Fuse Kit w/o Instrument ... kit1.49	
65-73 .. BP/SFE-4	Instrument Fuse (5)	1.49

HEADLAMP

Incandescents are an OE replacement, Halogens give you 50% brighter light with 25% longer range for better safety.

65-66 .. HDWR-223	Adjusting kit (one lamp)	4.00	
67-68 .. HDWR-412	"	4.00	
69	HDWR-413	5.50	
70	HDWR-414	4.00	
71-73 .. HDWR-416	"	3.50	
65-73 .. 6014	Incandescent, (Exc. 69)	4.95	
T1 65-73 ... 6014 SCRIPT	Incandescent w/"FoMoCo" ..	14.95	
65-73 .. H6024	Halogen, (Exc. 69)	12.95	
69	4000	Incandescent, Low	4.95
T1 69	4000 SCRIPT	Incandescent, w/"FoMoCo" ...	14.95
69	H5006	Halogen, Low	5.95
69	5001	Incandescent, High	4.95
T1 69	5001 SCRIPT	Incandescent, w/"FoMoCo" ..	14.95
69	H5001	Halogen, High	5.99

HEADLIGHT - DIMMER SWITCH AND CAP

S2 65-73 .. SW-263	Switch	10.95
S1 65-73 .. C5ZZ-13533AR	Dimmer Cap	5.95
S1 65-73 ... C5ZZ-13533A	Dimmer Cap	9.00



ELECTRICAL

HEADLIGHT - SWITCH

U2	65-68 .. SW-441	All	31.00	
U1	69	SW-817	All	24.00
	70	SW-928	All	25.00
	71-73 ..	SW-1226	All	29.00

HEADLIGHT - SWITCH BEZEL

65-66 ..	C4DZ-10852BR	All	11.95
67-68 ..	C7ZZ-10852AR	All	12.95

HEADLIGHT - KNOB & SHAFT

U3	65-66 ..	C5ZZ-11661BR	All	11.95
	67-68 ..	C7ZZ-11661BR	All	16.95

HEADLIGHT LOOM WIRING HARNESS (E4)

Firewall to Headlamp/Regulator loom. (1 of 3 under hood looms)
 All 1969-'70 Must reuse old firewall connector. See prior page for loom kits.

65-66 ..	HDWR-280	Fender apron grommet	1.00
64	64-HL-101	W/ Lamps	64.95
65	65-HL-102	W/ Lamps	94.95
65	65-HL-103	W/ Gauges	109.95
66	66-HL-104	W/ Gauges	94.95
67	67-HL-105	W/O Tach W/O GT	149.95
67	67-HL-106	W/O Tach W/ GT	159.95
67	67-HL-107	W/ Tach W/O GT	174.95
67	67-HL-108	W/ Tach W/ GT	184.95
68	68-HL-109	W/O Tach W/O GT	164.95
68	68-HL-110	W/O Tach W/ GT	184.95
68	68-HL-111	W/ Tach W/O GT	189.95
68	68-HL-112	W/ Tach W/ GT	209.95
69	69-HL-113	W/O Tach	209.95
69	69-HL-114	W/ Tach	219.95
70	70-HL-115	W/O Sport Lamp	219.95
70	70-HL-116	W/ Sport Lamp	239.95

HEADLIGHT WIRING EXTENSION (E6)

67-68 ..	67-HL-117	11.95
69	69-HL-118	17.95
70	70-HL-119	11.95

PARKING LAMP - HOUSING W/PIG TAIL

W1	65-66 ..	C5ZZ-13206BR	RH	27.95
W1	65-66 ..	C5ZZ-13206B	RH	50.00
W1	65-66 ..	C5ZZ-13207BR	LH	27.95
W1	65-66 ..	C5ZZ-13207B	LH	50.00

PARKING LAMP - ASSEMBLY W/ LENS & PIG TAIL

X1	67-68 ..	C8ZZ-13200BR	RH or LH	39.95
X1	67-68 ..	C8ZZ-13200B	RH or LH	79.00

PARKING LAMP - LENS

W4	64	C5ZZ-13208BR	Clear	pr.7.95
W3	65-66 ..	C5ZZ-13208AR	Amber	6.95
W3	65-66 ..	C5ZZ-13208C	Amber	10.00
X2	67-68 ..	C7ZZ-13208AR	Clear	3.95
	69	D0ZZ-13208A	Clear	25.00
	69	D0ZZ-13209A	Clear	25.00

PARKING LAMP - LENS GASKETS

W5	65-66 ..	C5ZZ-13211AR	95
X3	67-68 ..	C7ZZ-13211AR	pr.1.95
	69	C9ZZ-13211AR	pr.2.95
	71-73 ..	D1ZZ-13211AR	pr.2.95

DASH BEZEL AND KNOB KIT

Includes: Headlight switch knob and bezel, wiper knob and bezel, ignition bezel, and a cigarette lighter element and knob assembly.

65-66	C5ZZ-11661KR	53.95
-------------	--------------------	-------

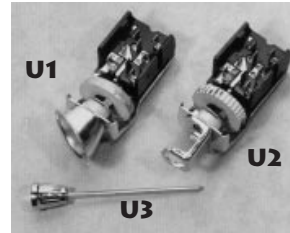

PARKING LAMP INSTALLATION KIT

Includes: Mounting pads, lenses, gaskets, bulbs and mounting hardware.

65-66	C5ZZ-13211K	16.95
-------------	-------------------	-------



PARKING LAMP DELUXE KIT

Includes: Pair of parking lamp housings, mounting pads, lenses, gaskets, bulbs and mounting hardware.

65-66	C5ZZ-1307/8K	73.95
-------------	--------------------	-------

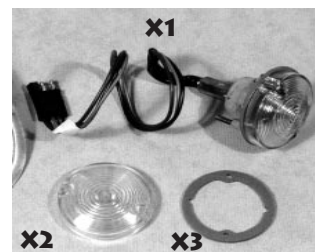

**PARKING LAMP - BULB**

65-68 .. BP1157	Bulb	pr.1.89
69-73 .. BP1157NA	Bulb, Amber	pr.3.79

PARKING LAMP - HOUSING GASKET

65-66 .. HDWR-451	Nuts (4)	1.20
65-66 .. C5ZZ-13217C/DR ...	LH & RH	6.95

HOOD TURN SIGNAL PARTS

67-68 ... C7ZZ-16B870A	Grill, insert only	ea.20.00
67-68 .. C7ZZ-16720/1AR ...	Grill assembly	set.109.95
67-68 .. HDWR-449	Nuts, for Grill (8)	3.00
67-68 .. C7ZZ-13368AR	Gaskets, for lens	pr.2.95
69-70 .. 69H-101	Wiring	34.95

SIDE MARKER - ASSEMBLY

68	C8ZZ-15A200PR	Front	pr.139.95
70	D0ZZ-15A201A	Front, RH	75.00
70	D0ZZ-15A201B	Front, LH	83.00

SIDE MARKER - LENS

68	C8ZZ-15A215PR	Front	pr.34.95	
Y2	E68	C8ZZ-13380A	Rear, to be used w/bezel 26.00	
	L68	C8GY-13380A	Rear, 1pc w/chrome trim Call	
Z2	69	C9ZZ-15A215C	Front, Clear	12.00
Z3	69	C9ZZ-15A201C	Rear, Red	14.00

SIDE MARKER - LENS GASKETS

69	C9AZ-15447R	FT & RR Lens to body (4) set.2.95	
70	D0ZZ-15209R	Rear, Lens	pr.1.95
70	D0ZZ-15447AR	Rear, Lamp to body	pr.2.95

SIDE MARKER - BULBS

68	1178A	Front, Amber	ea.2.69
69	BP194A	Front, Amber	pr.2.69
69-73 ..	BP194	Rear, Clear	pr.1.34
70	BP97A	Front, Amber	pr.3.69
71-72 ..	BP194	Front, Clear	pr.1.34

SIDE MARKER - BEZEL

Y1	E68	C8ZZ-13381A	Rear	40.00
Z1	69	C9AZ-15A440A	Front or Rear	17.00

TAIL LAMP BEZEL KIT

Includes: Bezels, lenses, gaskets and mounting hardware.

65-66
 TK1-SP | 44.95 |

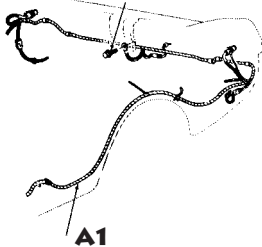
**Ground Screw****WHY WON'T MY TAILLIGHTS WORK?**

Few things are as frustrating as taillights that won't work. After years of use, old Mustang taillights can "go dark." Several things can hinder taillights, brake and signal lights. Two circuits go to every tail lights: brake/signal, and headlight/taillight. Both of these circuits go into one bulb (LH, RH each) with two filaments (No. 1157). A common ground wire or contact completes these circuits. The ground contact, usually the bulb socket against the reflector housing, (which is grounded to the car) can become corroded over the years and should be cleaned up or replaced.

A bad headlight switch can prevent the taillight circuit to work. If only one side works (taillight or signal or brake), then the turn signal switch is usually at fault. Check the brake light switch is well.

Taillights that work, but are dim, are usually due to a bad ground and/or taillight lenses that have darkened with age. Remember to do a complete restoration of the entire system to obtain optimum results. A voltmeter to measure amperage can be handy, too.

TAIL LIGHT - WIRE LOOM (A1)

Plugs into main under dash harness and turn signal harness and runs to tail lights, license plate light, back up lights, gas tank sending unit, and panel lamps on FB.

64-66 ..	64-TL-101	Cp, Cvt	79.95
65-66 ..	65-TL-102	FB	89.95
67	67-TL-103	All	119.95
68	68-TL-104	Cp, Cvt	119.95
68	68-TL-105	FB	124.95
69	69-TL-106	All	164.95

TAIL LIGHT - HOUSING

B1	65-66 ..	C5ZZ-13434AR	with pig tail	25.95
	65-66 ..	C4OZ-13A408AR	Pig tail	16.95
	65-66 ..	C4OZ-13A408AL	Pig tail	16.95

TAIL LIGHT - HOUSING TO BODY GASKET

65-66 ..	C5ZZ-13420AR	2.92
67-68 ..	C7ZZ-13420AR	set16.95
69	C9ZZ-13420AR	pr.4.95



ELECTRICAL

TAIL LIGHT - TAIL LIGHT TO HOUSING GASKET

- 67-68 .. C7ZZ-13520AR Thick rubber set34.95
- 69 C9ZZ-13520AR Thick rubber pr.39.95

TAIL LIGHT - DOOR

- 65-66 .. C5ZZ-13489AR ea.17.95
- 65-66 .. HDWR-369 SS Screws (8) 4.00
- 67 C7ZZ-13489AR ea.13.95
- 68 C8ZZ-13489AR ea.14.95
- 68 C5SZ-13489A GT/CS ea.84.00

TAIL LIGHT - LENS

- 65-66 .. C5ZZ-13450BR 6.95
- 65-66 .. C5ZZ-13450AR w/ 'FoMoCo' logo 9.95
- 67-68... C7ZZ-13450A 45.00
- 69 C9ZZ-13450A 68.00

TAIL LIGHT - LENS GASKET

- 65-66 .. C5ZZ-13461BR 2.95
- 67-68 .. C5ZZ-13461AR set4.95
- 67 C7WY-13461AR Shelby pr.9.95
- 69 C9ZZ-13461AR 4.95

TAIL LIGHT - BULB

- 65-73 .. BP1157 Bulb pr.1.98

BRAKE LIGHT SWITCH

- SW-24 Mounts on Master Cylinder - Others mount at Brake Pedal
- 64 SW-24 With Generator 9.00
 - A2 65-66 ... SW-863 With Alternator 12.00
 - A2 67-70... SW-863 With out Power Brakes 12.00
 - A2 67-68 ... SW-862 With Power Disc Brakes 11.00
 - A2 67-70... SW-864 With Power Drum 11.00
 - A2 71-73 ... SW-990 With Power Brakes 12.00

BRAKE SWITCH HARDWARE

- 64 64-PB Switch extension wire 9.95
- A1 65-68 ... C5DZ-2B129A Washer / Spacer (Req.2) 1.00
- A3 65-73 ... C0AZ-7526B Retainer Clip 2.00
- A4 65-68 ... C5DZ-2474B Bushing 4.00
- A4 69-73 ... C9AZ-2474A Bushing 5.00

BRAKE WARNING LIGHT SWITCH

- 67-69 ... C8AZ-2B264A 13.00
- 70-73 ... D0AZ-2B264A 11.00

BACK UP LIGHT - HOUSING W/PIG TAIL

- 65-66 .. C5ZZ-15511AR RH 29.95
- 65-66 ... C5ZZ-15511A RH 71.00
- 65-66 .. C5ZZ-15512AR LH 29.95
- 65-66... C5ZZ-15512A LH 61.00
- 67-68 .. C7ZZ-15511BR RH 39.95
- 67-68... C7ZZ-15511B RH 72.00
- 67-68 .. C7ZZ-15512BR LH 39.95
- 67-68... C7ZZ-15512B LH 86.00
- 69-70... C9ZZ-15500E RH, Flat style 89.00
- 69-70... C9ZZ-15500F LH, Flat style 89.00

BACK UP LIGHT - HOUSING GASKET

- 65-66 .. C5ZZ-15533A/BR pr.4.95
- 67-70 .. C7ZZ-15533A pr.4.95

BACK UP - LENS

- 65-70 .. HDWR-451 Nuts (4) 1.20
- 65-68 .. C5ZZ-15514AR 4.95
- 69-70... C9ZZ-15514B 10.00

TAIL LAMP BEZEL KIT

Includes: Six bezels, pads and mounting hardware.

- 67 TK1-67 69.95
- 68 TK1-68 69.95

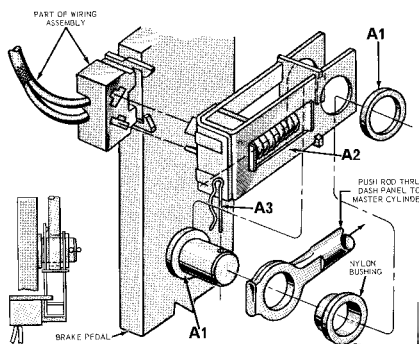

HOW DO I KNOW MY BRAKE (STOP) LIGHT SWITCH IS BAD?

If it isn't a bad turn signal switch, the brake light switch, mounted on the brake pedal (except '64-1/2), can either produce a dim, delayed or no brake signal, when bad. A good switch will produce brake lights at the slightest touch of the brakes. Replacement is relatively easy, if you're good at lying on your back under the dash!

BACK UP INSTALLATION KIT

Includes: Mounting pads, lenses, gaskets, bulbs and mounting hardware.

- 64-66 C5ZZ-15510K 19.95



BACK UP LAMP DELUXE KIT

Includes: Back up housing, pads, lenses, gaskets, bulbs, and installation hardware.

- 64-66 C5ZZ-15511/2K 69.95





BACK UP - LIGHT LENS GASKET

65-70 .. C5ZZ-15510AR pr.1.95

BACK UP - LIGHT BULB

65 BP1141 Bulb, 1 contact pr.2.09
 66-73 .. 1142 Bulb, 2 contact ea.1.65
 71-73 .. BP1156 Bulb, 1 contact pr.1.49

BACK UP - LIGHT SWITCH

65-66 ... C5ZZ-15520C 3 Spd 49.00
 B1 65-66 ... C5ZZ-15520A 4 Spd 57.00
 67-68 ... SW-561 4 Spd 54.00
 70 SW-1160 3 Spd 52.00
 70-73 ... SW-943 4 Spd 57.00
 73 SW-1052A Borg 20.00

LICENSE PLATE LAMP PARTS

C1 65-70 .. C5ZZ-13550AR Complete Assembly 44.95
 65-73 ... C4AZ-13564A Lamp Lens 7.00
 65-73 .. C7AZ-13568AR Lens Gasket99
 65-67 .. BP1157 Bulb pr.1.89
 68-73 .. BP97 Bulb pr.1.59

TURN SIGNAL - LEVER

D1 65-66 .. C5ZZ-13305AR 9.95
 D1 67-73 .. C7ZZ-13305AR 9.95
 D1 71-73 ... D3TZ-13305B 13.00

TURN SIGNAL - CAM REPAIR KIT

Instead of replacing your whole turn signal switch for a broken or faulty cam, use this kit. (Repo. & Not for tilt wheel.)

E1 64 642227 10.95
 E1 65-66 .. 652232 10.95
 E1 67-71 .. 672214 10.95

TURN SIGNAL - FLASHER

65-70 .. SF-224 7.00
 71-73 .. SF-323 7.00

TURN SIGNAL - SWITCH

64 C30Z-13341B Gen 52.00
 F1 65-66 .. C50Z-13341BR Alt 34.95
 65-66 ... C50Z-13341B Alt 50.00
 67 C7ZZ-13341F W/ Fixed 75.00
 68 C8ZZ-13341A W/ Fixed 80.00
 68-69 ... C8SZ-13341B W/ Tilt 100.00
 69 C9AZ-13341B W/ Fixed 77.00
 70-72 ... D2AZ-13341C W/ Fixed 75.00
 73 D6AZ-13341A W/ Tilt 95.00
 73 D6AZ-13341B W/ Fixed 77.00

EMERGENCY - SIGNAL FLASHER

65-73 ... SF-552-B 6.95

EMERGENCY - SIGNAL FLASHER SWITCH

G2 65-66 ... C6AZ-13A350D Switch w/mounting tab 25.00
 G1 65-66 ... C6AZ-13A350A Switch w/ tab & harness 30.00
 67 C70Z-17513AR Knob 11.95

KEY TO LINE LISTING:
Bold Print = Reproduction / OEM-Style Replacement Parts
 Standard Print = Current Original Ford Replacement Parts

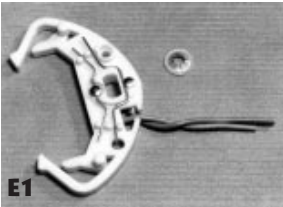
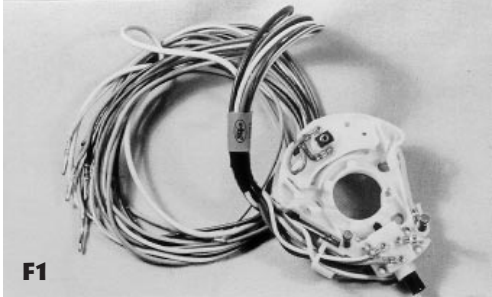

**WE INSTALL
 WHAT WE SELL.**

Tech Tip HOW DO I KNOW MY TURN SIGNAL SWITCH IS BAD?
 If you've eliminated the possibility of turn signal & brake light bulb, pig tail, battery, or alternator etc., failure, then it probably is a bad switch. All four turn signals, the brake lights, license plate light, horn, as well as the emergency flasher (after '67), go through this switch. Four separate signals go through this switch, two front, two rear. You will need to pull the steering wheel to replace this switch, and rewire the connector to the under dash harness. (See Shop Manual). Do not over torque steering wheel after replacement, as it can break the plastic cam.



ELECTRICAL

NEUTRAL (SAFETY) & BACK-UP SWITCH

H1	65-67 ... SW368	W/ C-4	29.95	
	67	SW549	W/ C-6	47.95
	67-69	SW877	W/ C-4 & C-6	31.95
	69-72	SW368	W/ C-4	29.95
	69-73	SW903B	W/ FMX	229.95
	70-73	SW1615	W/ C-4	65.95
	72-73	SW1148	W/ C-6	54.95



NEUTRAL SAFETY SWITCH WIRE LOOM

65-66	C5-7A248	19.95
-------	----------	-------

UNDER DASH WIRING HARNESS

Main under dash harness. All new parts with fuse block and clips, lamp sockets and all molded plugs. '67's tach loom sold separately.

65	1440165WG3SG	W/ Gauge	399.99
65	1440165WL2SM	W/ 2 Spd Heat, Lamps	399.99
65	1440165WL3SN	W/ 3 Spd Heat, Lamps	399.99
66	1440166	All	399.99
67	14401STD	W/Tach	499.95
67	14401GTT	GT W/Tach	499.95

DASH INSTRUMENT REGULATOR

65-66	GR-508	21.95
67-68	GR-510	21.95
69-73	GR-512	21.95

DOOR JAMB SWITCH

K3	65-66	C3AZ-13713AR	Non-Tilt Steering Wheel	6.95
K3	67-68	C60Z-13713AR	Black, Non-Tilt	6.95
K3	69-73	C80Z-13713AR	White, Non-Tilt	6.95
K3	70-73	SW-1055	W/Automatic seat latch	10.00

DOOR COURTESY LAMP & SPEAKER LOOM (DOOR)

64-65	65-DP-101	w/o speakers	21.95	
66-70	66-CR-105	Speaker Cross Over Loom	24.95	
K4	66	66-DP-102	w/ speakers w/ 8-track	31.95
	67-68	67-DP-103	w/speaker	31.95
	69-70	69-DP-104	w/speakers	49.95

DOOR COURTESY LAMP (DOOR)

K1	65-66	C5ZZ-13789KR	Pony Door light assy.	34.95
K2	65-66	C5ZZ-13790AR	Pony Door light gasket	1.00
	67-68	C90Z-13790AR	DLX Door light gasket	2.00

DOME LIGHT - BEZEL

L2	67-70	C0AF-13788AR	CP	6.95
L2	67-70	C0AF-13788A	CP	15.00
	71	D0AZ-13788A		13.00
	73	D6UZ-13788A	W/ bulb	13.00

DOME LIGHT - LENS & BULB

65-69	BP1003	Bulb, Step, Dome, Qtr	pr.2.09
L1	67-70	C0AF-13783CR	4.95
L1	67-70	C0AF-13783C	6.00
72-73	BP561	Bulbs	pr.2.69
71	C60Z-13783A		12.00
73	D1AZ-13783B		4.00

QUARTER TRIM LAMP

65-70	BP1003	Bulbs	pr.2.09	
M1	65-70	C4SZ-13776BR	FB, Complete Assembly	49.95
	65-70	C4SZ-13776B	FB, Complete Assembly	57.00
	65-70	C1SZ-13783BR	FB, Lens (round & white)	4.95
	65-70	C1SZ-13783B	FB, Lens	8.00



HOW DO I KNOW THE NEUTRAL SAFETY SWITCH IS OUT?

This switch, mounted on the side of the automatic transmission, is intended to prevent your starting in drive or reverse. If you turn the key and nothing happens - no starter movement - then with the brake on, shift into neutral and try. If it starts, the switch is out of adjustment, if not, chances are it's this switch (if the battery and starter and solenoid are o.k.). This switch can be replaced without removing the transmission.



RALLY-PAC

To add the "Grand Turismo" look, Ford added two gauges to the steering column, Tachometer and a Clock. Our reproduction includes an electronic Tach. and quartz clock. Authentic wrinkle finish. (1966 Type only, similar to '65 GT & Pony interior cars.

C6ZZ-10B960BR	6000 RPM I6	469.95
C6ZZ-10B960AR	6000 RPM V8	479.95
C6ZZ-10B960CR	8000 RPM	499.95

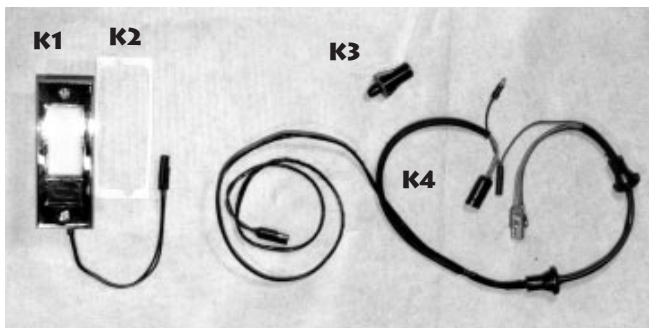

ELECTRICAL



KEY TO LINE LISTING:

Bold Print = Reproduction / OEM-Style Replacement Parts
 Standard Print = Current Original Ford Replacement Parts

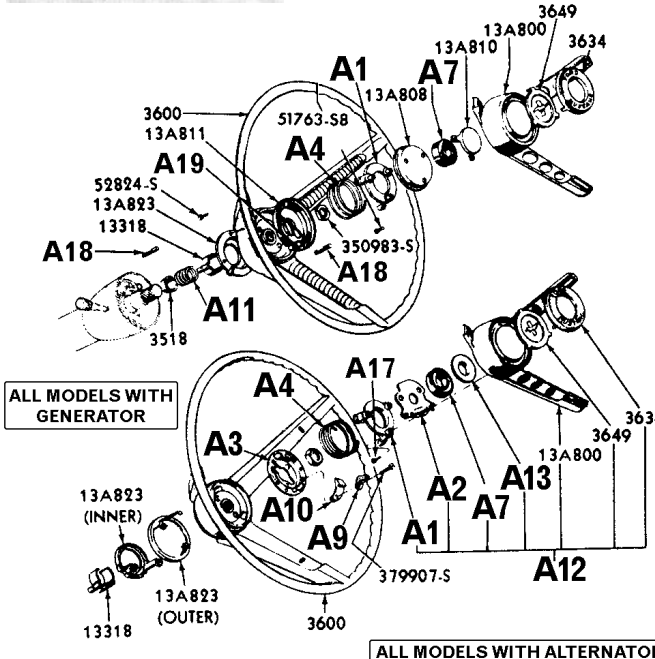
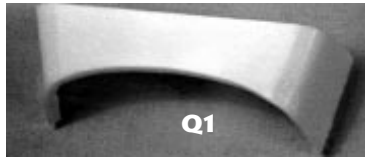

1965-66 STANDARD STEERING WHEEL

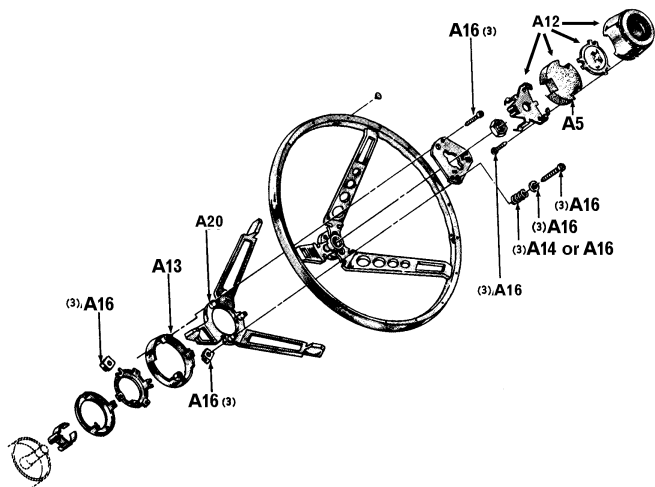

1965-67 WOODGRAIN STEERING WHEEL

CONSOLE - PARTS & LAMP

- 64 BP1445 Bulb, Floor shift indicator .pr.1.49
- Assembly includes: Die cast lamp, lens and pigtail.
- P1 65-66 .. PR-642233 Console Lamp Assembly ... 49.95
- 65-66 .. F29Z-13B712AR Dash to Console Wire Loom 21.95
- 65-66 .. 64-CON-101 Internal Console, W/o AC .. 14.95
- 65-66 .. 64-CON-102 Internal Console, W/ AC 11.95
- 65-66 .. C5ZZ-13734AR Lens on console, rear 3.95
- 65-70 .. BP1895 Bulb, Console glove box ... pr.1.39
- 65-73 .. BP1893 Bulb, Floor shift indicator .pr.1.79
- Q1 67-68 .. C7ZZ-13783AR Lens on console, rear 7.95

GLOVE COMPARTMENT LAMP

- R1 65-70 .. D1AZ-14413AR Switch w/bulb and pigtail .. 16.95
- 65-73 .. BP1895 Bulb pr.1.39

CIGAR LIGHTER PARTS

- S1 65-66 .. C5ZZ-15052KR Complete unit 14.95
- S2 65-70 .. C4AZ-15055BR Socket & Retainer 6.95
- S2 65-66 .. EOYV-15055A Socket & Retainer 8.00
- S3 65-69 .. C5ZZ-15052AR Knob 7.95
- 67-73 .. 1895BP Bulb pr.1.39

HORN RING / CAP

- A12 64 C5ZZ-13A805CR W/ Gen, w/ cap, std 79.95
- A12 65-66 .. C5ZZ-13A805BR W/ Alt, w/ cap, std 89.95
- A20 65-67 ... C70Z-13A805E W/ woodgrain wheel 60.00
- A12 65-66 .. C5ZZ-13A800AR Cap only w/ woodgrain 79.95
- A13 65-66 ... C5ZZ-13A806CR Collar for woodgrain cap 44.95
- 68-69 ... C9AZ-13A805B Ring only, 2 spoke wheel ... 65.00

HORN RING SPRING

- A4 65-69 ... C0DZ-13A807B Std, w/o woodgrain wheel ... 6.00
- A14 65-67 ... C5ZZ-13A807B w/ woodgrain wheel 5.00

STEERING WHEEL TENSION SPRING

- A11 65-66 ... C3DZ-3520A Spring 2.00

HORN RING INDEX RETAINER

- A1 64 C2DZ-13A809AR W/ Gen 4.95
- A1 65-66 .. D2TZ-13A809BR W/ Alt 4.95
- A1 67 C7ZZ-13A809BR W/ Pins 4.95

HORN RING CONTACT KIT

- Includes: Contact plate, spring plate, horn ring retainer pressure pad, and screws. (A1, A2, A7, A13, A17)
- 65-66 .. C5ZZ-13A809KR Kit 12.95

Deluxe steering wheel. Includes: Plastic insulators and screws.

- A16 65-67 .. C5ZZ-16A890/1MK .Kit 26.95

HORN BLOWING CONTACT AND SPRING ASSY.

- A9 65-66 ... C5ZZ-13864B W/ Gen 5.00
- A9 67-69 ... C5ZZ-13864A W/o Woodgrain Wheels 5.00
- A10 65-69 ... C5AZ-13867A Lower shim, w/o woodgrain .. 4.00

HORN BRUSH & PAD

- A18 64 C20Z-13A821A Brush, W/ Gen 5.00
- A19 64 13A822 Pad, W/ Gen 7.00

DELUXE WHEEL FOAM INSULATOR

- A5 65-67 .. C5ZZ-13A816AR Foam 1.95

HORN RING CONTACT PLATE

- A2 65-66 ... D1TZ-13A808A W/ Alt, std wheel 11.00

HORN CAM / RING PLATE

- A3 65-66 ... C5AZ-13A811A W/ Alt 4.00

HORN RING PRESSURE PAD (PIN W/SPRING)

- A7 64-66 ... C0DZ-13A813A W/ Std wheel 4.00

HORN ASSEMBLY

- 65-68 .. HDWR-268 Bolts and Nuts 2.00
- 69-70 .. HDWR-198 Wire retainer 2.00
- Original replacement, not original looking horns.

- 65-73 ... E3AZ-13832A Low Pitch 32.00

- 65-73 ... E3AZ-13833A High Pitch 32.00

HORN BLOWING SWITCH ASSEMBLY

- 69 C9AZ-13A875C 3 Spoke Wheel 44.00
- 70-73 ... D1AZ-13A875A 3 Spoke Wheel 36.00
- 70-73 ... D2AZ-13A875A 2 Spoke Wheel, Std 36.00



ELECTRICAL

"DEALER OPTION" GT FOG LAMP INSTALLATION KIT 1965-1967

Although included with the GT option, fog lamps were originally available from the dealer separately. Our kits include: Fog lamp housing, bars, wiring harness kit, switch, bulbs, instructions, under dash wiring, wires to solenoid, ground wires, firewall grommets, 10 amp breaker and wiring diagram. *1966 requires GT Horse and Corral. 1965-67 Grill brackets are recommended.



- 65 C5ZZ-15199AR 299.95
- *66 C6ZZ-15199AR 299.95
- 67 C7ZZ-15199AR 299.95

FOG LIGHT - HOUSING

- G5 65-67 .. C5RZ-15200AR ea.39.95
- G5 68 C8ZZ-15200AR ea.39.95

FOG LIGHT - BULB

- G6 65-68 .. C5ZZ-15220BR AmberCall
- G6 65-68 .. C5ZZ-15220CR Clear 15.95

FOG LIGHT - BARS

- G4 65 C5ZZ-8390AR pr.89.95
- G4 66 C6ZZ-8390AR pr.89.95
- G4 67 C7ZZ-8390AR pr.129.95

FOG LIGHT - BAR GRILL MOUNTING BRACKETS

- G3 66 C6ZZ-8391AR pr.19.95
- G3 67 C7ZZ-8391AR pr.19.95
- G3 68 C8ZZ-8391AR pr.24.95

FOG LIGHT - SWITCH

- G20 65-67 ... B6TZ-9A389A Bezel 15.00
- G1 65 C5ZZ-15A214AR Factory GT only 39.95
- G1 65-66 .. C6ZZ-15A214AR 39.95
- G1 67 C7ZZ-15A214AR 39.95
- G1 68 C8ZZ-15A214AR 49.95

FOG LIGHT - WIRING HARNESS UNDER DASH

- G2 65 65-FG-UD 24.95
- G2 66 66-FG-UD 24.95
- G2 67 67-FG-UD 19.95
- G2 68 68-FG-UD 19.95

FOG LIGHT TO FIREWALL FEED

- G7 66 66-FG-FW 12.95
- G7 67 67-FG-FW 19.95
- G7 68 68-FG-FW 19.95
- G7 67-68 .. C7ZZ-13461AR 4.95

FOG LIGHT - GROUND WIRE

- E8 66 66-FG-GR pr.6.95

FOG LIGHT - CIRCUIT BREAKER

- E9 65-68 .. 65-FG-CB 9.95

FOG LIGHT - PIGTAIL

- G8 65-67 .. 65-FG-PT 14.95
- G8 68 68-FG-PT 14.95

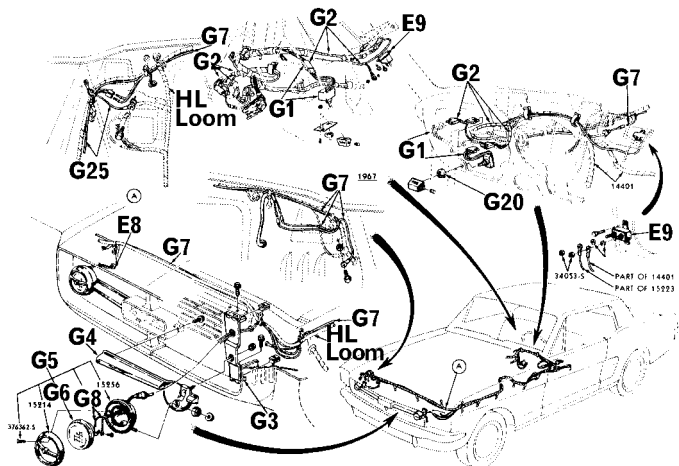
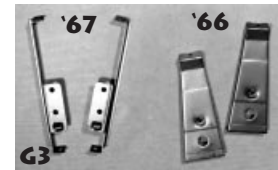

Free Manuals Download Website

<http://myh66.com>

<http://usermanuals.us>

<http://www.somanuals.com>

<http://www.4manuals.cc>

<http://www.manual-lib.com>

<http://www.404manual.com>

<http://www.luxmanual.com>

<http://aubethermostatmanual.com>

Golf course search by state

<http://golfingnear.com>

Email search by domain

<http://emailbydomain.com>

Auto manuals search

<http://auto.somanuals.com>

TV manuals search

<http://tv.somanuals.com>