

HP 20b Business Consultant Financial Calculator Manual

For free training, visit www.hp.com/go/calctraining

HP part number: F2219-90201

First edition: August 2008



Legal Notices

This manual and any examples contained herein are provided "as is" and are subject to change without notice. Hewlett-Packard Company makes no warranty of any kind with regard to this manual, including, but not limited to, the implied warranties of merchantability, non-infringement and fitness for a particular purpose.

Hewlett-Packard Company shall not be liable for any errors or for incidental or consequential damages in connection with the furnishing, performance, or use of this manual or the examples contained herein.

Copyright © 2008 Hewlett-Packard Development Company, L.P.

Reproduction, adaptation, or translation of this manual is prohibited without prior written permission of Hewlett-Packard Company, except as allowed under the copyright laws.

Hewlett-Packard Company
16399 West Bernardo Drive
MS 8-600
San Diego, CA 92127-1899
USA

Revision History

Revision History

Revision	Date
Edition 1, v. 12	August 7, 2008

Contents







Legal Notices

Revision History	2
------------------------	---



HP 20b Business Consultant Keyboard

Keyboard Map Legend	6
---------------------------	---

1 Basic Features

Welcome to the HP 20b Financial Calculator	7
Turning the Calculator On and Off	7
Selecting a Language	7
Adjusting the Display Contrast	7
Cursor	7
Two Line Display	8
The Mode Menu: Setting Preferences	8
Changing the Calculation Mode	10
Key Presses and the Secondary Function  Key	11
Annunciators	11
The  Key	12
The  Key	12
Using the  and  Keys	12
Editing and Clearing Entries	13
The On/CE  Key	13
The Reset  Menu	13
Notes about Special Menus	13
Memory and the Memory Menu	13
Accessing Menus and Menu Maps	14

2 Mathematical Calculations

Mathematical Functions	16
Number Entry and Display	16
Chain Mode	17
Algebraic Mode	17
Reverse Polish Notation (RPN) Mode	18
The RPN Stack	18
Last Number	19
One-Number Functions and the Math Menu	22
The Math   Menu	23
The Probability Sub-menu	25

Two-Number Functions	26
Storing and Recalling Numbers	27
Recall Arithmetic	28
Storing and Recalling with Time Value of Money (TVM) Keys	28
Recalling a Menu Item Value in a Menu	28
Rounding Numbers	28
Percentages	28
3 Time Value of Money	
Time Value of Money (TVM) Keys	30
Calculating Payments on a Loan	32
Amortization	33
Creating an Amortization Schedule	34
Interest Conversion Menu	35
Using the Interest Conversion Menu	35
Canadian Mortgages: TVM Canada	36
Canadian Mortgage Example	38
4 Cash Flows	
Cash Flow Example	40
Analyzing Cash Flows	42
Editing Cash Flows	44
Sample Cash Flow Diagrams	45
5 Bonds	
The Bond Menu	46
Bond Calculation Example	47
6 Date Calculation	
The Date Calculation Menu	49
Date Calculation Example	49
7 Break-even	
The Break-even Menu	51
Break-even Example	51
8 Business Problems	
The Percent Calculation Menu	53
Percent Calculation Examples	54
9 Depreciation	
The Depreciation Menu	56
Depreciation Example	58
10 Statistical Operations	
The Data and Stats Menus	61

Statistics Example.....	63
11 Errors	
Error Messages and Calculator Status.....	65
12 Warranty, Regulatory, and Contact Information	
Replacing the Batteries.....	67
HP Limited Hardware Warranty and Customer Care.....	67
Customer Care	68
Product Regulatory & Environment Information	71
Index	

HP 20b Business Consultant Keyboard



Keyboard Map Legend

No.	Feature	Chapter(s)	No.	Feature	Chapter(s)
1	Time Value of Money keys	3	16	Annunciator display area	1
2	Cash Flows, IRR, and NPV menus	4	15	Amortization and Depreciation menus	3,8
3	Data and Statistics menus	9	14	% key and Percent Calculation menu	2,6
4	Input key	1	13	Store and Recall	2
5	Memory menu	1	12	Break-even menu	6
6	Up/Insert and Down/Delete keys	1	11	Backspace key and Reset menu	1
7	Secondary function key	1	10	Math Menu	2
8	On/Off and clear entry key	1	9	Mathematical function keys	2

1 Basic Features

Welcome to the HP 20b Financial Calculator

This manual is designed to familiarize you with the many features of your new 20b Financial Calculator. It includes menu maps, example problems and solutions with key presses, screen shots, and examples of cash flow diagrams. There are also sections which list the error messages and explain how RPN works. Refer to the section titled, *Contents* for quick access to various topics. If you need more information about your calculator, or about calculator operation and features, please refer to the training materials available at: www.hp.com/go/calctraining.





Turning the Calculator On and Off

To turn on your calculator, press . To turn it off, press  .

Turning the calculator off does not erase any data. The calculator automatically turns itself off after approximately five minutes to conserve energy. If you see the low battery symbol () in the display, replace the batteries. See Chapter 12, *Warranty, Regulatory, and Contact Information* for instructions on replacing the batteries.





Selecting a Language

English is the default language for messages displayed on the screen. To select a language other than English:

1. Press   to access the Mode menu. *FIX* displays on the top line of the screen.
2. Press  repeatedly until *English* displays on the screen.
3. Press  until the desired language is displayed. The displayed language is the active setting.
4. Press  to return to the default calculator screen.

For more information on accessing menus and changing calculator settings, refer to the sections below titled, *The Mode Menu: Setting Preferences*, and *Accessing Menus and Menu Maps*.

Adjusting the Display Contrast

To adjust the contrast of the display, press and hold  while pressing the  or  keys. Each press of the  or  keys slightly increases or decreases the contrast of the display.

Cursor

When you enter a number, the cursor () blinks in the display and indicates you are in *number entry* mode.

Two Line Display

There are two lines in the display screen as shown in Figure 1.



Figure 1 Display Screen

The top line of the screen displays operation status, operator symbols, annunciators, and abbreviations of the registers, variables, and menu names. Throughout this manual, this line is referred to as the *top line*. In Figure 1, *SIN* is on the top line.

The bottom line displays numbers you have entered, or results. Throughout this manual, this line is referred to as the *bottom line*.

When no operations have been entered and no operations are pending, the bottom line of the screen displays *0.00*. This state of the calculator is referred to as the *default calculator screen*.

The Mode Menu: Setting Preferences







The Mode menu allows you to customize the calculator. To access the Mode menu, press  . Press  or  repeatedly to scroll through the menu starting with *FIX=2* (the number of digits displayed to the right of the decimal point). Once an item is displayed, press  to cycle through the other options for that setting. To exit the Mode menu, press . Table 1-1 lists the items in the Mode menu.

Table 1-1 Mode Menu Settings

















Setting (top line)	Description
FIX= 2	<p>Display precision (number of digits displayed to the right of the decimal point). Default is 2.</p> <p>Key in the number of digits you want and press , or press  until the number of digits you want is displayed.</p> <p>The display precision can be any number from 0-11. If you specify -1, the calculator displays numbers with the most appropriate number of digits after the decimal point.</p> <p>If you find you need to change the <i>FIX</i> setting often, use the following shortcut:</p> <ol style="list-style-type: none"> 1 Press  and release it. Check that the secondary function indicator is displayed. 2 Press  again, and, without releasing it, press a key,  through  that corresponds to the desired <i>FIX</i> setting. <i>FIX</i> settings for 10 and 11 are not available using this shortcut. If you press  instead of a numbered key, <i>FIX</i>=-1 is selected.
Degree or Radian	<p>Angular mode in degrees or radians for trigonometric functions. Default is <i>Degree</i>.</p> <p>Pressing  toggles between these options.</p>
Date: mm.ddyyyy or dd.mmyyyy	<p>Format for dates. December 3, 2010 is entered as <i>12.032010</i> in <i>mm.ddyyyy</i> format, or <i>3.122010</i> in <i>dd.mmyyyy</i> format. Note the (.) in both formats separating the first and second groups. Default is <i>mm.ddyyyy</i> format.</p> <p>Pressing  toggles between these options.</p> <p>Note that when a date is displayed, a number between 1 and 7 also displays at the right of the screen. This number indicates the day of the week corresponding to that date. Monday is 1, and Sunday is 7.</p> <p>Note: in 360-day calendar mode (Cal.360), days of the week are displayed only if the date is valid.</p>
1.23 or 1,23	<p>Selects point or comma as decimal separator. Default is decimal point, <i>1.23</i></p> <p>Pressing  toggles between these options.</p>
1000.00, 1,000.00, 1000,00 or 1.000,00	<p>Selects thousands separator. Default is none, <i>1000.00</i></p> <p>Pressing  toggles between these options.</p> <p>Note: the 1000.00 and 1,000.00 options are only available if the decimal separator is set for point (.); 1000,00 and 1.000,00 are available only if the decimal separator is set for comma (,).</p>
Chain, Algebraic, or RPN	<p>Calculation mode. For more information, refer to Chapter 2, <i>Mathematical Calculations</i>. Pressing  cycles through these options.</p>



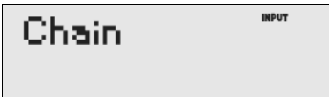



Table 1-1 Mode Menu Settings

Setting (top line)	Description
English, Français, Deutch, or Español	Language setting for the messages displayed on the screen. Default is <i>English</i> . Pressing  cycles through these options.
Actual or Cal.360	Calendar options for bonds and date calculations. Default is <i>Actual</i> . Pressing  toggles between these options.
Annual or Semiannual	Bond type. Default is <i>Annual</i> . Pressing  toggles between these options.
TVM Standard or TVM Canada	Activate or deactivate the compounding per year (C/YR) option in time value of money (TVM) calculations. This option is primarily used for Canadian mortgage calculations. For more information, refer to the section titled, <i>Canadian Mortgages: TVM Canada</i> in Chapter 3. Pressing  toggles between these options.

Changing the Calculation Mode

After viewing the default settings, suppose you want to change the calculation mode from Chain to RPN. See Table 1-2.

Table 1-2 Changing the Calculation Mode

Keys	Display	Description
		Opens the Mode menu, starting with first setting option, <i>FIX</i> , the number of digits displayed to the right of the decimal point.
 (Press five times)		Scrolls to the current setting for the calculation mode, <i>Chain</i> .
 (Press two times)		Selects <i>RPN</i> as the active setting. Note the small <i>RPN</i> annunciator to the right.
		Exits the Mode menu and returns you to the default calculator screen.

Key Presses and the Secondary Function Key

To execute the function associated with a key, press and release the desired key. Most of the 20b's keys have two functions: the primary function and the secondary function. The primary function is printed on the top of the key. The secondary function is printed on the bevel of the key. See Figure 2.

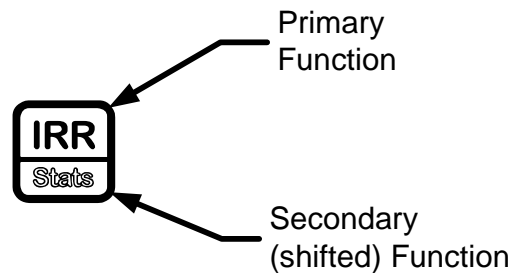









Figure 2 Primary and Secondary Key Functions

To activate the secondary function of a key, press and release  followed by the key with the desired secondary function printed on the bevel. Unlike the shift key on a typewriter or computer keyboard, it is not necessary to press and hold  while pressing another key.

When  is active, the down arrow annunciator appears on screen, indicating that the next key pressed will execute the secondary function of the key. To cancel an accidental press of , simply press  a second time.

In this manual, commands using the secondary key functions are represented by the secondary function key symbol, , followed by the key with the secondary function. For example, to execute sine, press  . Note how the *SIN* portion of the key is highlighted, while the 7 is grayed out. This highlighting focuses on the function of the key that will be activated in a given command, and it is used throughout the manual to make the examples easier to follow. Key commands for example problems are provided throughout the text and in tables. Key symbols are placed in the order they are to be pressed, from left to right.

Annunciators

Annunciators are symbols that appear in the display as messages, or after certain keys or key combinations have been pressed. Annunciators are special symbols indicating a specific status in the calculator. Figure 3 illustrates the annunciator symbols in the display.

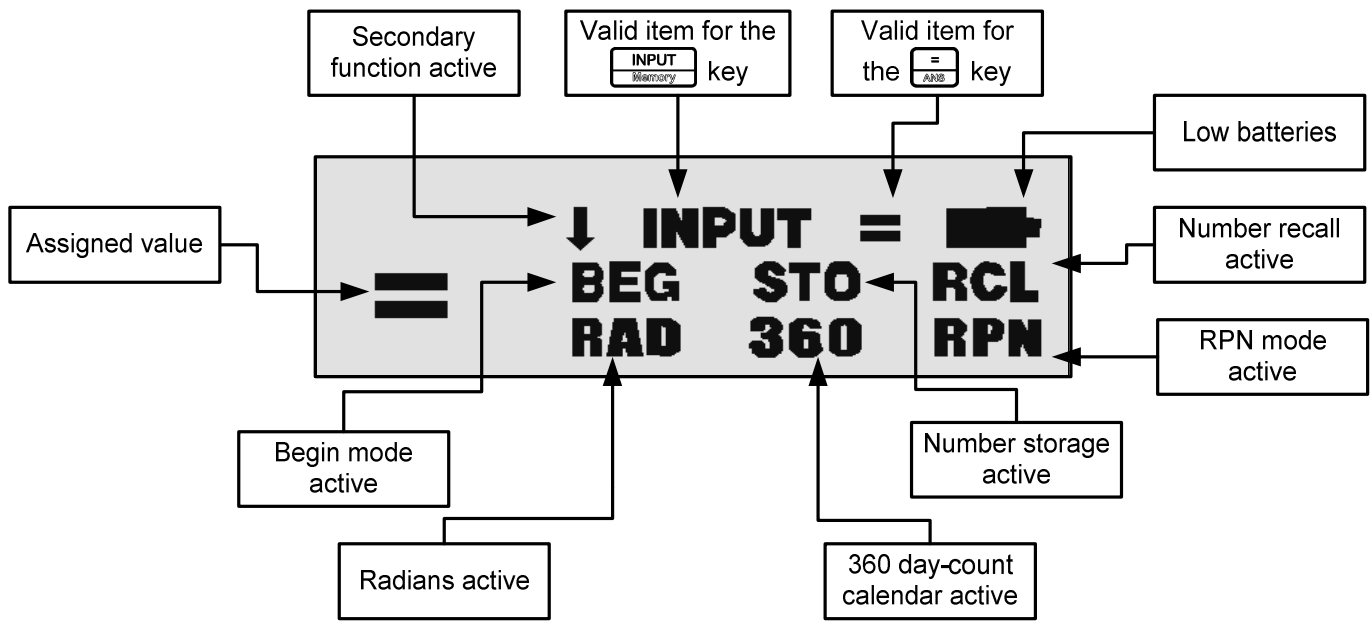









Figure 3 Annunciator Symbols in the Screen Display

The Key

The  key is used to input values for variables and execute menu items.







The  key is also used in Reverse Polish Notation (RPN) mode to enter a number on the stack or duplicate it.

The Key

The  key is used at the end of a mathematical operation to calculate the final result. For example,     returns a final result of 3.

The  key, when pressed outside of a mathematical operation, also allows you to request a calculation for the value of an item. This request only applies to items that can be calculated.

Using the and Keys

Suppose you wanted to calculate the effective interest rate for a 12% nominal interest rate with 12 payments per year in the Interest Conversion (IConv) menu. To open the IConv menu, press . *Nom %=* displays on the top line, and the current value assigned to the nominal interest rate is displayed on the bottom line. With this screen displayed, press    to input a new value for the nominal interest rate. Press  followed by  to calculate the value for the effective rate. See Figure 4.

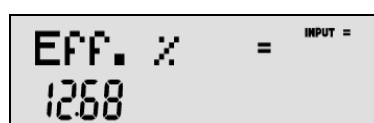





Figure 4

When an item for which the  key is valid displays, the small annunciator (=) is displayed on the top line at the right of the screen. Do not confuse this small annunciator (=) with the larger annunciator (=) found to the right of a variable.

When an item for which the  key is valid displays, the **INPUT** annunciator is displayed on the top line at the right of the screen.

Editing and Clearing Entries







The On/CE Key



Pressing  one time cancels current number entries, mathematical operations, or a menu selection, in that order.

Pressing  repeatedly when performing multiple operations cancels one operation at a time, from the latest to the earliest.

The Reset Menu

The Reset menu allows you to reset some, or all, of the menu items, variables, and registers to their default values.





To open the Reset menu, press . *TVM* displays on the top line. Press  or  repeatedly to scroll to a specific item. To validate a choice and reset the selected items, press . Press  to cancel. If you select the command to reset the cash flow (*Cash Flow*), statistics (*Stats*), or all values (*All*) items, you will be prompted to confirm your choice. At the *Del. All?*, *Del. Data?*, and *Del. CF?* prompts, press  again to confirm the reset, or  to cancel.

While working within a specific menu, pressing  takes you directly to the item of the Reset menu that allows you to reset that specific menu. For example, if you are working in the Bond menu and you wish to reset all your entries in the Bond menu, with any item of the Bond menu displayed, press . *Bond* displays on screen. At this prompt, pressing  resets the Bond menu and returns you to the last item you were working with in the Bond menu.

Notes about Special Menus

The Mode, Memory, Math and Reset menus are special menus; if you were working in a menu prior to entering one of these special menus, pressing  to exit them returns you to your previous menu. This feature allows you to work in two or more menus simultaneously without having to exit a menu.



Memory and the Memory Menu

The Memory menu contains the following items: memories 1-9 (*Mem 1-9*) and 0 (*Mem 0*), *Cash Flow*, Statistics (*Stats*), and *Memory*. To enter the menu, press . Press . Press  or  repeatedly to scroll through the items starting with memory 1 (*Mem 1*).

When a memory item is displayed, you can enter a new number and modify the value of the memory by pressing .





For more information about storing and recalling numbers, refer to the section titled, *Storing and Recalling Numbers* in Chapter 2.

The Cash Flow and Statistics menus share the same memory and are limited to a combined total of 50 memory slots. The number displayed with *Memory* refers to the number of remaining memory slots. When the cash flow or statistics items are displayed, a number also appears on the bottom line. This number indicates the number of memory slots used by the menu.

Pressing  with this number displayed resets the memory of the displayed menu item and erases all entered data. Since entering data in these menus can represent a significant amount of work, you will be asked to confirm your choice. At the *Del.Data?* or *Del.CF?* prompts, press  to confirm, or  to cancel.

Accessing Menus and Menu Maps

Many of the calculator's functions are located within menus. To access a menu, press the key, or secondary-function-key-combination, for the menu in which you wish to work. To exit a menu, press .

For example, to access the Break-even menu, press . Once opened, you can scroll through the items in the menu by pressing  or  repeatedly. When you arrive at the last item in a menu, pressing  returns you to the first item. Similarly, pressing  one time on the first menu item scrolls to the last item in the menu.

Most items consist of two parts: a name and an associated number. For example, the *Fixed* item in the Break-even menu (Figure 7) displays as shown in Figure 5.



Figure 5





The large (=) annunciator shows that the value assigned to *Fixed* is *120,000*. If you perform a calculation with this item displayed by pressing     for example, *Fixed* is still selected as the current item, but the large (=) annunciator is now turned off, indicating the *3* is not the value assigned to *Fixed* (see Figure 6).



Figure 6

At this point, to return to the display of the *Fixed* menu item shown in Figure 5, press .

Some menus have sub-menus. If an item represents a sub-menu, pressing  with that menu item displayed opens the sub-menu.

In this manual, diagrams called *Menu Maps* are included at the beginning of each section to assist you with navigating through the menus used for that section. For an example of a menu map, see Figure 7.

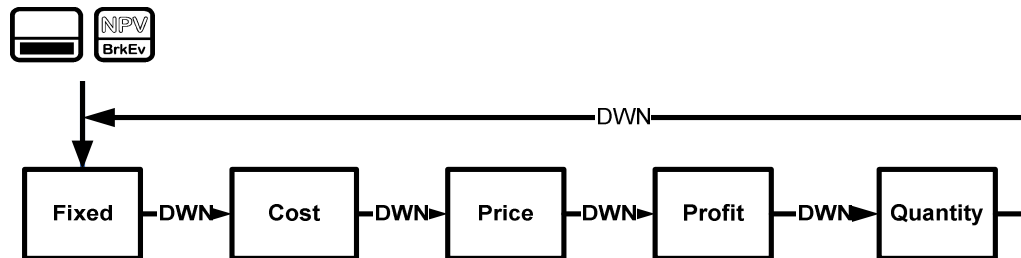







Figure 7 The Menu Map for the Break-even Menu









There are four types of menu items:

1. **Read/write.** Read/write menu items, such as *Fixed* in the Break-even menu shown above, are easily recognizable, because when they are selected, both the *INPUT* and small (=) annunciators are lit. When lit, these annunciators indicate that entering a number and pressing  will store the entered number in the displayed menu item. Pressing  (outside of a mathematical operation) calculates the value for that item based on available data.
2. **Read-only.** Read-only items such as Internal Rate of Return (*IRR%*) in the IRR menu are display-only; they are calculated values computed internally by the calculator.
3. **Write-only.** Write-only items, such as investment interest rate (*Inv. I%*) in the Net Present Value (NPV) menu, are similar to read/write items in that the *INPUT* annunciator is lit when these items are selected, indicating that entering a number and pressing  stores that number in that menu item. However, the  key does not calculate a value for that item.
4. **Special items.** Special items, such as the *Degree/Radian* option in the Mode menu, the items of the Reset menu, and the items of the Percent Calculation (%calc) menu perform an action when  is pressed. Depending on the menu, this action can be the selection of a sub-menu (%calc menu), changing a mode or setting (Mode menu), or erasing data (Reset menu).

2 Mathematical Calculations







Mathematical Functions



Mathematical functions are located:

- On keys, such as,    , etc.
- On shifted, or secondary functions, such as,  
- In the Math menu,  

Number Entry and Display

Numbers are entered by pressing:

- Numbered keys,  - 
- The decimal point 
- The  key
- The   keys

To correct a number entry, press the backspace key, . Each press of  erases the last digit or symbol you entered.

To enter a number in the display, press the number digits successively. A number can have up to 12 digits.

To change the sign of a number from positive to negative, press .



Use scientific notation to enter very large and very small numbers. For example, to enter the number 1.23×10^{127} in scientific notation, first enter the mantissa (1.23) and then press   and enter the number (127) representing the exponent. The exponent must have a value between -499 and +499.



Figure 1 Scientific Notation in FIX=2 Mode

Chain Mode

Calculations in Chain mode are interpreted in the order in which they are entered. For example, entering the following numbers and operations as written from left to right $\frac{1}{\text{RAND}}$ $\frac{+}{\text{RND}}$ $\frac{2}{|}$ $\frac{x}{\sqrt{}}$ $\frac{3}{y^2}$ $\frac{=}{\text{ANS}}$ returns 9. See Figure 2.

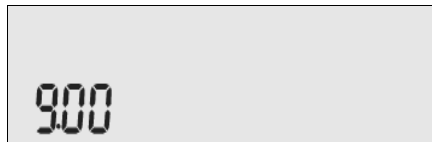

Figure 2 Calculation in Chain Mode

Note: if you press an operator key, $\frac{+}{\text{RND}}$ $\frac{-}{1/x}$ $\frac{x}{\sqrt{}}$ $\frac{\div}{\text{Math}}$, after $\frac{=}{\text{ANS}}$, the calculation is continued using the currently displayed value.

In Chain mode, if you wish to override the left to right order of entry, use parentheses $\frac{(}{\text{Mode}}$ $\frac{)}{x}$ to prioritize operations. For example, to calculate $1 + (2 \times 3)$, you may enter the problem as written from left to right, with parentheses to prioritize the multiplication operation. See Table 2-1 below.

Table 2-1 Simple Arithmetic Calculations in Chain Mode

Keys	Display	Description
$\frac{1}{\text{RAND}}$ $\frac{+}{\text{RND}}$ $\frac{(}{\text{Mode}}$ $\frac{2}{ }$ $\frac{x}{\sqrt{}}$ $\frac{3}{y^2}$ $\frac{)}{x}$		Sets operational priority, inputs numbers, and multiplies 2 and 3.
$\frac{=}{\text{ANS}}$		Adds 1 to 6 and returns 7.00 on the bottom line as the final result.

Algebraic Mode

To set the calculator in Algebraic mode, refer to the section titled, *The Mode Menu: Setting Preferences* in Chapter 1.

In Algebraic mode, multiplication and division have a higher priority than addition and subtraction. For example, in Algebraic mode, pressing $\frac{1}{\text{RAND}}$ $\frac{+}{\text{RND}}$ $\frac{2}{|}$ $\frac{x}{\sqrt{}}$ $\frac{3}{y^2}$ $\frac{=}{\text{ANS}}$ returns a result of 7.00. In Chain mode, the same key presses return a result of 9.00.

In Algebraic mode, operations between two numbers have the following priority:

- Highest priority: the power function (y^x)
- Second priority: combinations and permutations
- Third priority: multiplication and division
- Lowest priority: addition and subtraction

For example, key in $1 + 2 \times 5 \text{ nPr} 2^2$ in Algebraic mode by pressing:



Note: the calculator is limited to 12 pending operations. An operation is *pending* when it is waiting for the input of a number or the result of an operation of higher priority.

Reverse Polish Notation (RPN) Mode

To set the calculator in RPN mode, refer to the section titled, *The Mode Menu: Setting Preferences* in Chapter 1. In RPN mode, numbers are entered first, separated by pressing or , followed by an operation key.

Note: pressing or is optional after entering a number, if the next key pressed is an operation.

Each time you press an operation or function key in RPN, the answer is calculated immediately and displayed. For example, suppose you wanted to add two numbers in RPN, 1 and 2. Press , , , . The result, 3.00, is calculated and displayed immediately on the bottom line along with the (+) symbol on the top line.

Note: in RPN mode, when you are in a menu for which or are valid, pressing these keys enters the number, but it also performs the action associated with the key for the menu item, which is generally saving the number in the variable or calculating the item's value.

The RPN Stack

RPN works by placing numbers in storage registers called the *stack*. The RPN stack has four levels numbered 1-4. The levels are stacked on top of one another. See Figure 3.

Stack Level 4	-15
Stack Level 3	12
Stack Level 2	41
Stack Level 1	23

Figure 3 The RPN Stack

In Figure 3, the stack contains four numbers, 23, 41, 12, and -15. Each level (1-4) contains one number. When a number is typed and entered into the stack by pressing , this new number is "pushed" into level one of the stack, and each number already in the stack moves up one level. The number in Level 4, -15, is pushed out and is lost.

When an operation is performed on the stack, addition ($\boxed{\frac{+}{RND}}$) for instance, the calculator "pops" or moves the two numbers from the bottom levels (Levels 1 and 2) out of the stack, performs the operation, and "pushes" the results back into the stack.

With the numbers entered into the stack as shown in Figure 3, pressing $\boxed{\frac{+}{RND}}$ changes the stack as shown in Figure 4. Note that when the numbers are "popped" out to add 23 and 41, Level 4 of the stack remains unchanged.

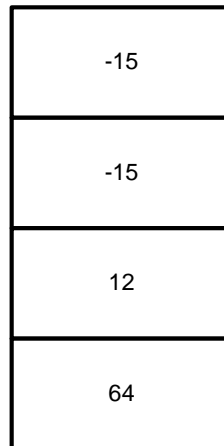

Figure 4 The RPN Stack of Figure 3 after the Addition Operation

Last Number

Each time you perform a mathematical operation, the content of Level 1 of the stack is saved. Pressing $\boxed{\frac{\text{ANS}}{\text{ANS}}}$ recalls that number. This functionality can be used to undo an erroneous key press, or if you want to reuse a number, such as 56.123 in the expression:

$$\frac{(1.23 + 56.123)}{(56.123)}$$

See Table 2-2 for an example using the *last number* function.

Table 2-2 Last Number

Keys	Display	Description
$\boxed{\frac{\text{ANS}}{\text{ANS}}}$ $\boxed{\text{Mode}}$ $\boxed{3}$ $\boxed{\frac{\text{INPUT}}{\text{Memory}}}$		Sets <i>FIX</i> = to 3.000
$\boxed{\text{DEL}}$ $\boxed{\text{DEL}}$ $\boxed{\text{DEL}}$ $\boxed{\text{DEL}}$ $\boxed{\text{DEL}}$ $\boxed{\frac{\text{INPUT}}{\text{Memory}}}$ $\boxed{\frac{\text{INPUT}}{\text{Memory}}}$		Selects <i>RPN</i> as the operating mode.
$\boxed{\text{ON/C}}$ $\boxed{1}$ $\boxed{-}$ $\boxed{2}$ $\boxed{3}$ $\boxed{\frac{\text{INPUT}}{\text{Memory}}}$ $\boxed{5}$ $\boxed{6}$ $\boxed{-}$ $\boxed{1}$ $\boxed{2}$ $\boxed{3}$		Inputs 1.23 and 56.123

Table 2-2 Last Number

Keys	Display	Description
		Adds 1.23 and 56.123, then divides the sum by the last number, 56.123. Returns results in the selected display format.

For more complex problems requiring two or more operations, you do not need to enter parentheses to set operational priority. Key in numbers and operations inside the parentheses first, followed by those outside of the parentheses. If a problem has more than one set of parentheses, start by working with the operations and numbers in the innermost parentheses and work out. For example, calculate:



$$(3 + 4) \times (5 + 6)$$





One way to calculate this problem is to key in the numbers and operations within the parentheses first, followed by the operation outside of the parentheses. See Table 2-3.

Table 2-3 Simple Arithmetic Calculations in RPN Mode

Keys	Display	Description	RPN Stack				
		Inputs the numbers and the operation in the first set of parentheses. Intermediate results are displayed. Note the (+) and (RPN) annunciators.	<table border="1"> <tr><td>Previous Value</td></tr> <tr><td>Previous Value</td></tr> <tr><td>Previous Value</td></tr> <tr><td>7</td></tr> </table>	Previous Value	Previous Value	Previous Value	7
Previous Value							
Previous Value							
Previous Value							
7							
		Inputs the numbers and the operation in the second set of parentheses. Intermediate results are displayed. Note the (+) annunciator.	<table border="1"> <tr><td>Previous Value</td></tr> <tr><td>Previous Value</td></tr> <tr><td>7</td></tr> <tr><td>11</td></tr> </table>	Previous Value	Previous Value	7	11
Previous Value							
Previous Value							
7							
11							

Table 2-3 Simple Arithmetic Calculations in RPN Mode

Keys	Display	Description	RPN Stack				
		Finishes the operation and displays the results.	<table border="1" style="width: 100%; text-align: center;"> <tr><td>Previous Value</td></tr> <tr><td>Previous Value</td></tr> <tr><td>Previous Value</td></tr> <tr><td>77</td></tr> </table>	Previous Value	Previous Value	Previous Value	77
Previous Value							
Previous Value							
Previous Value							
77							

Pressing  or  when you are not entering a number duplicates the number on Level 1. That is, the number on Level 1 is pushed on the stack, making Levels 1 and 2 equal. In the example above, pressing  after  duplicates 77 on the stack, making Levels 1 and 2 equal. See Figure 5.

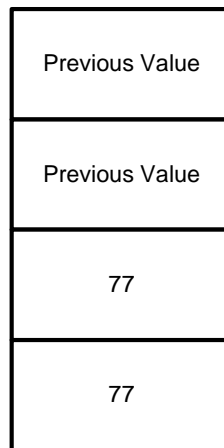







Figure 5 Duplicating a Number on the Stack

In RPN, the parentheses keys   manipulate the stack. Pressing  performs a *roll down* of the stack. A roll down causes the stack to *roll* towards the bottom of the stack, during which the number in Level 2 moves down to Level 1, the number in Level 3 moves down to Level 2, the number in Level 4 moves down to Level 3, and the number in Level 1 moves up to Level 4. The  key has a small down arrow on it as a reminder of the roll down feature. With the numbers entered into the stack shown in the left column in Figure 6, pressing  performs the roll down of the stack shown in the right column.

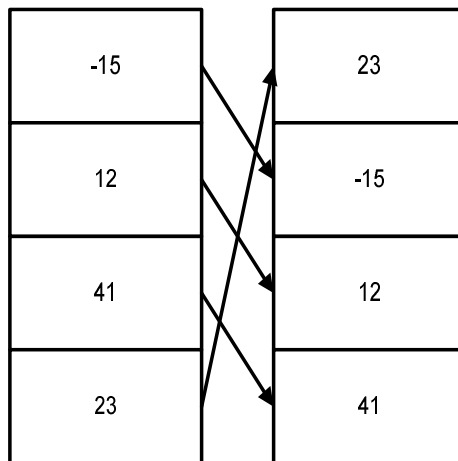

Figure 6 The RPN Stack and the Roll Down Operation

Pressing $\boxed{\text{)}\times}$ performs a *swap*. A swap operation exchanges the numbers on Levels 1 and 2 of the stack. The $\boxed{\text{)}\times}$ key has a small symbol on it as a reminder of the swap feature. With the numbers entered into the stack shown in the left column in Figure 7, pressing $\boxed{\text{)}\times}$ performs a swap to the stack as shown in the right column.

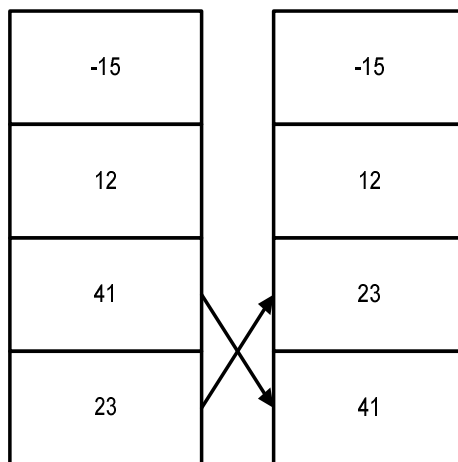



Figure 7 The RPN Stack and the Swap Operation

Note: when no menu is selected, the $\boxed{\text{DEL}}$ key performs the same function as the $\boxed{\text{Mode}}$ key. The $\boxed{\text{INS}}$ key performs the inverse operation called, *roll up*.

One-Number Functions and the Math Menu



























The key presses for the one-number mathematical functions listed in Table 2-4 below apply to all modes, Chain, Algebraic, and RPN. To execute one-number functions, with a number displayed, press the key or key combination corresponding to the operation you wish to execute. The result is displayed on the bottom line.

For example, to calculate $\sqrt{6}$, press  . The result of 2.45 is calculated immediately and displayed on the bottom line. The square root symbol ($\sqrt{\quad}$) appears on the top line.



Note: before doing any trigonometric calculations in the Math menu, check whether the angle mode is set for degrees (*Degrees*) or radians (*Radians*). You will need to change the setting if the active mode is not what your problem requires. For more information on the Mode menu and calculator settings, refer to the section titled, *The Mode Menu: Setting Preferences* in Chapter 1.

Table 2-4 lists one-number functions along with their corresponding keys.

Table 2-4 Shifted Function Mathematical Operations

Keys	Description
  SIN	Calculates sine.
  COS	Calculates cosine.
  TAN	Calculates tangent.
  LN	Calculates natural log.
  e^x	Calculates natural exponent to the power of x .
  x^2	Calculates square of x .
 	Calculates square root.
  RAND	Executes the <i>Random</i> function. Returns a random number in the range $0 < x < 1$.
  !	Calculates factorial of x (where $-253 < x \leq 253$). The Gamma function is used to calculate $x!$ for non-integers or negative numbers.
  y^x	Calculates y to the x power.
  $1/x$	Calculates the reciprocal.
  ANS	In Chain or Algebraic mode, recalls the result of the last operation. In RPN mode, returns the content of the <i>Last Number</i> variable.
  RND	Rounds x internally to the number specified by the display format.

The Math Menu

There are additional functions available in the Math menu. To open the Math menu, press  . See Figure 8 for the menu map of the Math menu.

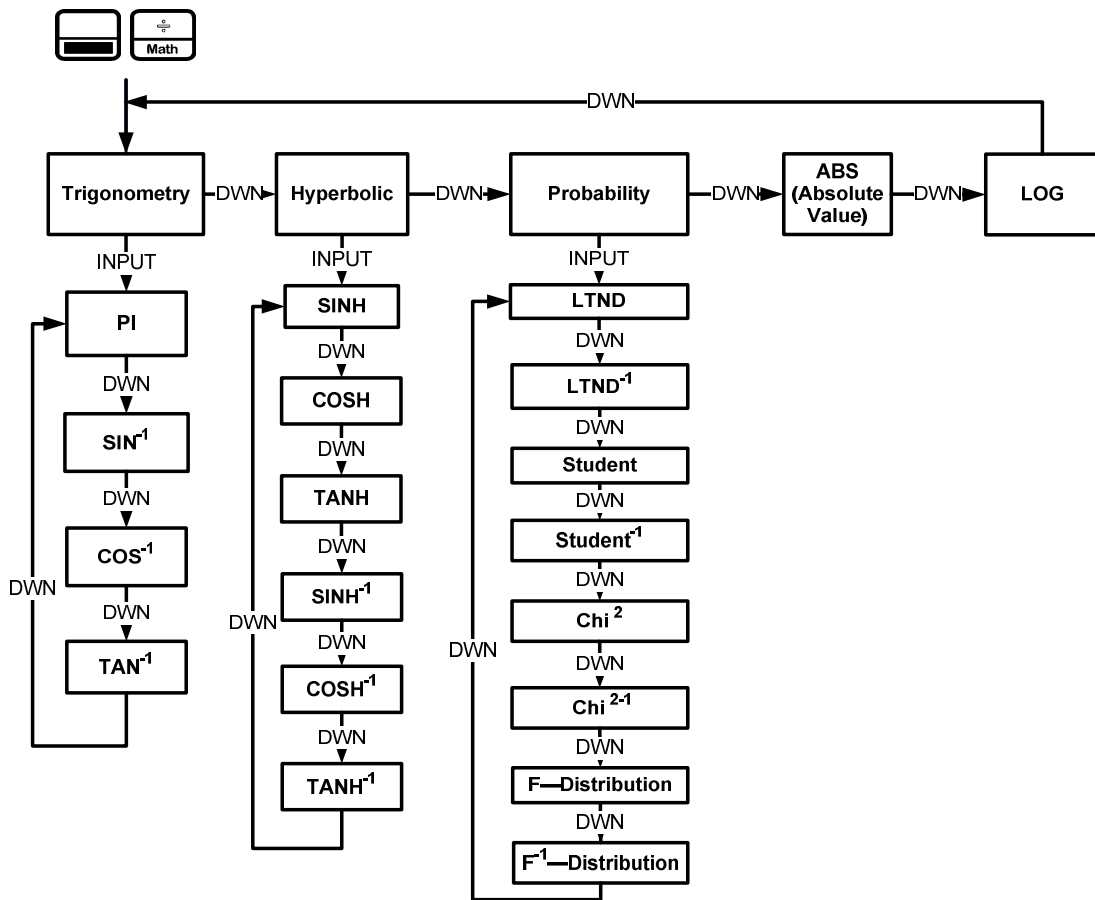







Figure 8 The Menu Map for the Math Menu

Press  to scroll through the menu items, starting with *Trigonometry*. The *Trigonometry*, *Hyperbolic*, and *Probability* items have sub-menus. Press  with these items displayed to access the functions within the sub menus.

Press  to cancel the Math menu and return to current work. Press   to return to the top of the Math menu.

For an example using the math menu to calculate $\text{Sin}^{-1}(0.5)$, see Table 2-5.

Table 2-5 Math Menu Example

Keys	Display	Description
		Enters 0.5 and opens the Math menu starting with <i>Trigonometry</i> .
		Selects the <i>Trigonometry</i> sub-menu and scrolls to Sin^{-1} . Note the value for Sin^{-1} is calculated immediately and displayed.
		Validates the result.

In the Math menu, *PI* does not *perform* calculations; it enters *PI* for calculations. You may start an operation, use the Math menu to execute a function, and continue calculating with your original operation without losing your work.

The Probability Sub-menu

Lower Tail Normal Distribution (LTND) calculates the probability for a normally distributed, random variable to be less than the input.

Inverse Lower Tail Normal Distribution (LTND^{-1}) is the inverse function for LTND; it calculates the value (*V*) for which the probability of a normally distributed, random variable to be less than *V* is the given input. Student, Inverse Student, Chi^2 , Inverse Chi^2 , F-Distribution and Inverse F-Distribution perform similar operations for Student, Chi^2 , and F-Distributions.

Student, Chi^2 , and F-Distribution and their inverse operations are special cases, as they require more than one number as input. Student and Chi^2 require (*N*), the number of degrees of freedom, and F-Distribution requires (*N1*) and (*N2*), two degrees of freedom.

To perform Student and Chi^2 operations or their inverse:

1. Enter the number of degree(s) of freedom by typing the number and pressing or .
2. Type the number for which you want to calculate the probability, or, for the inverse, the probability for which you want the number.
3. Navigate to the appropriate function in the Probability sub-menu of the Math menu.

To perform F-Distribution operations or their inverse:

1. Enter the two degrees of freedom by typing each number followed by or .

2. Type the number for which you want to calculate the probability, or, for the inverse, the probability for which you want the number.
3. Navigate to the appropriate function in the Probability sub-menu of the Math menu.

Table 2-6 Probability Example









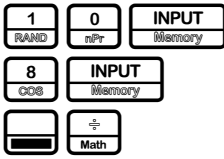

Keys	Display	Description
		Enters 10 degrees of freedom and the number for which probability is to be calculated. Opens the Math menu.
		Selects the <i>Probability</i> menu item and scrolls to Chi ² .
		Validates the result.

Table 2-7 Inverse Probability Example

Keys	Display	Description
		Enters 10 degrees of freedom and the probability. Opens the Math menu.
		Selects the <i>Probability</i> menu item. Scrolls to Chi ²⁻¹ .
		Validates the result.

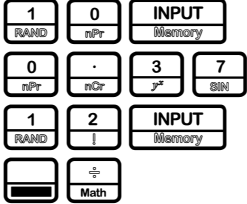
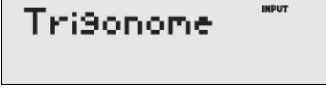
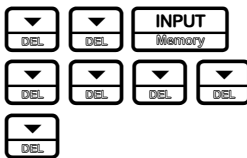
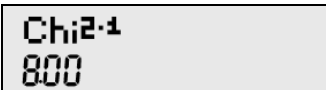
Two-Number Functions

Apart from , the three additional two-number functions accessible on the keyboard are:

- Y^X

- nCr
- nPr

Y^X is the power function, nCr stands for the number of combinations of n items taken r at a time, and nPr stands for the number of permutations of n items taken r at a time.

$$\text{Combination} = \frac{n!}{r!(n-r)!}$$

$$\text{Permutation} = \frac{n!}{(n-r)!}$$

Perform calculations with these functions in the same way you would perform calculations with $\frac{+}{\text{RND}}$, $\frac{-}{1/x}$, $\frac{\div}{\text{Memory}}$ and $\frac{\times}{\sqrt{}}$, but press $\frac{\square}{\square}$ to access the secondary function key. For example, to calculate 15^3 :

1. Press $\frac{1}{\text{RND}}$ $\frac{5}{e^x}$.
2. Press $\frac{\square}{\square}$ $\frac{3}{y^x}$.
3. Press $\frac{3}{y^x}$ $\frac{=}{\text{ANS}}$. The results are shown Figure 9.

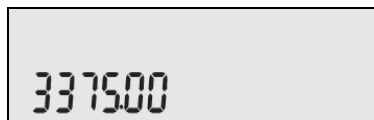

Figure 9

In RPN mode, key in the numbers first, followed by $\frac{\text{INPUT}}{\text{Memory}}$, then press the function key. For example, for the power function example above, in RPN press: $\frac{1}{\text{RND}}$ $\frac{5}{e^x}$ $\frac{\text{INPUT}}{\text{Memory}}$ $\frac{3}{y^x}$ $\frac{\square}{\square}$ $\frac{3}{y^x}$.

Storing and Recalling Numbers

The calculator has ten memories available for use during calculations. These memories are numbered from 1-9 and 0. To store a number in a memory, press $\frac{\square}{\square}$ $\frac{\text{RCL}}{\text{STO}}$, followed by the key representing the memory number. To recall a number stored in a memory, press $\frac{\text{RCL}}{\text{STO}}$ followed by the key representing the memory number. You can use the store and recall functions for these memories any time a number is displayed, or when you wish to enter a number.

For example, to store 15 in memory 1, press $\frac{1}{\text{RND}}$ $\frac{5}{e^x}$ $\frac{\square}{\square}$ $\frac{\text{RCL}}{\text{STO}}$ $\frac{1}{\text{RND}}$.

To recall the number in memory 1, press $\frac{\text{RCL}}{\text{STO}}$ $\frac{1}{\text{RND}}$.

You can also perform operations to numbers stored in memories. For example, press $\frac{5}{e^x}$ $\frac{\square}{\square}$ $\frac{\text{RCL}}{\text{STO}}$ $\frac{2}{|}$ to store 5 in memory 2. To add 12 to the value of memory 2, press $\frac{1}{\text{RND}}$ $\frac{2}{|}$ $\frac{\square}{\square}$ $\frac{\text{RCL}}{\text{STO}}$ $\frac{+}{\text{RND}}$ $\frac{2}{|}$. Later on, during a calculation, you can

press $\boxed{\text{RCL}} \boxed{2}$ to recall memory 2. Note how the new current value stored in memory 2 is 17, (5 + 12). $\boxed{+}$, $\boxed{-}$, $\boxed{\times}$ and $\boxed{\div}$ are valid mathematical operations for memories.

To view the stored values in memories 1-9 and 0, press $\boxed{\text{INPUT}} \boxed{\text{Memory}}$, followed by $\boxed{\text{DEL}}$ or $\boxed{\text{INS}}$ repeatedly to scroll through each memory starting with memory 1 (*Mem 1*). Note that in the Memory menu, you can change the value of any memory by selecting the memory and typing a number followed by the $\boxed{\text{INPUT}} \boxed{\text{Memory}}$ key.

Recall Arithmetic

In RPN, typing $\boxed{1} \boxed{2} \boxed{\text{RCL}} \boxed{+} \boxed{2}$ adds the value of memory 2 to the first level of the stack, but it will not modify the stored value of memory 2. This is useful, as it "saves" one stack level. You can also use $\boxed{-}$, $\boxed{\times}$ and $\boxed{\div}$ after $\boxed{\text{RCL}}$.

To perform the same operation in Algebraic and Chain modes, press $\boxed{1} \boxed{2} \boxed{+} \boxed{\text{RCL}} \boxed{2} \boxed{=}$.

Storing and Recalling with Time Value of Money (TVM) Keys

To store the current number in the Time Value of Money (TVM) variables, press $\boxed{\text{RCL}} \boxed{\text{STO}}$ followed by the desired TVM key.

To recall the stored value of a TVM variable, press $\boxed{\text{RCL}}$ followed by the key of the desired TVM variable. Note: pressing $\boxed{\text{RCL}}$ does not calculate the variable; it recalls the current value.

Recalling a Menu Item Value in a Menu

In a menu, you can recall the current value of a menu item. For example, open the Interest Conversion menu (IConv) by pressing $\boxed{\text{IConv}}$. With *Nom. %* displayed, pressing $\boxed{2} \boxed{\times} \boxed{\text{RCL}} \boxed{=}$ recalls the nominal rate. This feature is useful when you need to insert the contents of a menu item into an algebraic operation.

Rounding Numbers

All calculations are performed internally with 15-digit precision and are rounded to 12 digits when returning the results. In certain instances, calculations are performed internally with greater than 15-digit precision.

When displayed, a number is further rounded to the number of digits after the decimal point set by the *FIX* item in the Mode menu. The default setting is two digits to the right of the decimal point. For more information, refer to the section titled, *The Mode Menu: Setting Preferences* in Chapter 1.

Note: the *FIX* setting only affects the display; it does not affect the actual numbers.

Percentages

In Algebraic or Chain modes, pressing $\boxed{\%}$ divides a number by 100. For example, pressing $\boxed{2} \boxed{5} \boxed{\%}$ returns 0.25.

Mathematical Calculations

To find a percentage of a given number, enter the number and multiply it by the desired percentage, followed by $\boxed{=}$. For example, to find 25% of 200, press $\boxed{200} \boxed{\times} \boxed{.25} \boxed{=}$ to return a result of 50.

To add or subtract a percentage of a number, enter the first number, followed by $\boxed{+}$ or $\boxed{-}$ and the percentage followed by $\boxed{\%}$. Finish your calculation with $\boxed{=}$. For example, to add 10% to 50, press $\boxed{50} \boxed{+} \boxed{10} \boxed{\%} \boxed{=}$ to return a result of 55.

In RPN mode, the $\boxed{\%}$ key calculates $x\%$ of the number on Level 2 of the stack, when x is the number on Level 1 of the stack. It does not modify the number on Level 2 of the stack, and thus allows you to perform addition or subtraction after pressing $\boxed{\%}$ to add or subtract $x\%$ from the number.

For example, $\boxed{200} \boxed{\%} \boxed{25}$ returns 50, but 200 is still on Level 2 of the stack, and pressing $\boxed{-}$ returns 150, or 200-25%.

3 Time Value of Money

The examples in the following sections are calculated with the Mode menu preferences in their default settings, unless otherwise noted. For more information about basic features and setting preferences, see Chapter 1, *Basic Features*.

Time Value of Money (TVM) Keys

Cash flow diagrams are useful tools for analyzing financial situations, as they help you identify the TVM functions needed to resolve your problem.

A cash flow diagram is a drawing with a set of vertical arrows arranged on a horizontal line. The horizontal line represents the period of time from the beginning of the financing to the end. The vertical arrows represent the money or cash flows at certain times throughout the period. The arrows' length is proportional to the cash flow amount each arrow represents; a longer arrow indicates a larger amount, a shorter arrow, a smaller amount. Each arrow's position on the line represents the time at which the cash flow occurs. The orientation of the arrow, up or down, represents the "direction" of the cash flow: up for money received, down for money paid out. See Figure 1.

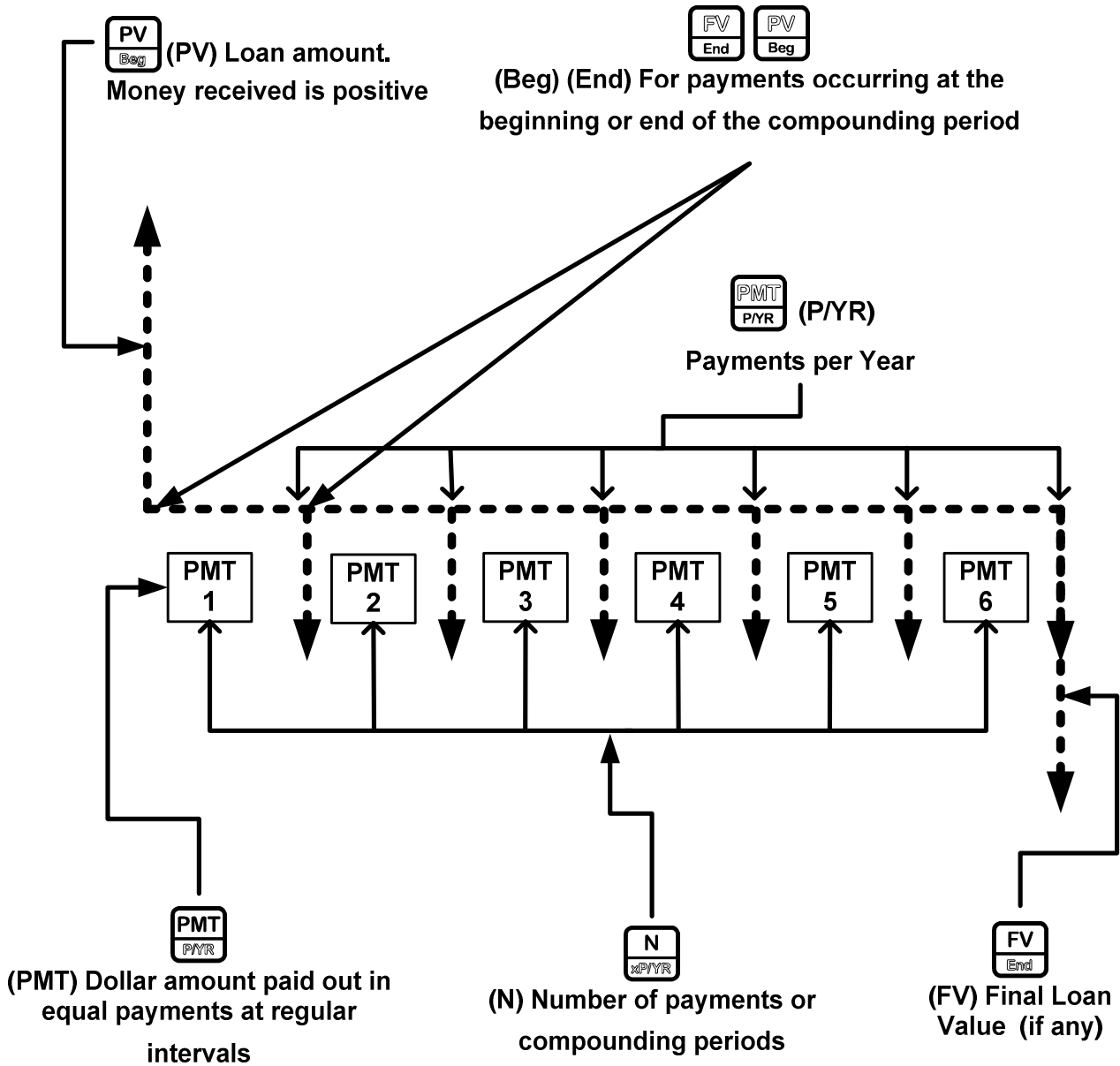

Figure 1 Cash Flow Diagram Example with Corresponding TVM Keys

The TVM functions of the calculator can solve problems with at least one cash flow, and problems in which all the cash flows, except the first and last, are of the same value. To solve other types of cash flows, refer to the section below titled, *Canadian Mortgages: TVM Canada*, or Chapter 4, *Cash Flows*.

Figure 1 illustrates a cash flow diagram and how the data in the diagram corresponds to the TVM keys. For a complete list of keys used for TVM problems, along with their descriptions, see Table 3-1.

To save values for the TVM variables, enter the desired number, followed by the corresponding TVM key. To calculate an unknown value, enter all known values and press the key of the item you want solved.

Table 3-1 TVM Keys

Keys	Description
	Stores or calculates the number of payments or compounding periods.
	Multiplies a value by the number of payments per year and stores as N.
	Stores or calculates the nominal, annual interest rate.
	Stores or calculates the present value (PV). To a lender or borrower, PV is the amount of a loan; to an investor, PV is the initial investment. PV always occurs at the beginning of the first period.
	Stores or calculates the amount of each periodic payment.
	Stores the number of payments or compounding periods per year.
	Stores or calculates the future value (FV), a final cash flow. FV always occurs at the end of the last compounding period.
	Sets Begin mode (Beg). Payments occur at the beginning of each compounding period.
	Sets End mode (End). Payments occur at the end of each compounding period.

Calculating Payments on a Loan

You borrow 140,000.00 for 30 years (360 months) at 6.5% annual interest, compounded monthly. What is your monthly payment to the lender? Note: at the end of the 30 years, you expect to have a zero balance ($FV=0$).

Table 3-2 TVM Example

Keys	Display	Description
		Inputs 12 as the number of payments per year, or compounding periods per year.
		Inputs 360 as the number of payments over 30 years.
		Inputs 6.5% as the nominal interest rate percentage per year.
		Inputs the present value of the loan at the time of the first payment. This value is positive (+); it is money you receive.
		Inputs 0 as the future value of the loan (the remaining balance).

Table 3-2 TVM Example

Keys	Display	Description
		Returns the monthly payment. This result is negative (-); it is money you pay out.

To reset the TVM variables to their default values, with any TVM variable displayed press . Press or repeatedly until *TVM* displays. Press to reset the TVM values, or press to cancel.

Amortization

Refer to Figure 2 for a menu map of the Amortization menu (Amort). Table 3-3 lists the keys and variables of the Amortization menu. To open the menu, press . The Amortization menu calculations are based on values stored in the following TVM registers: , , , and .

To enter values for the TVM variables, enter a number followed by the corresponding key.

For an amortization example, see Table 3-4.

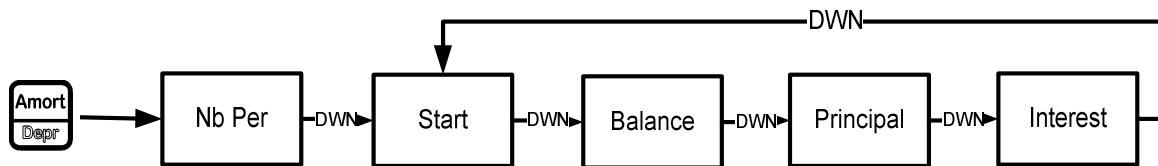





Figure 2 The Menu Map for the Amortization Menu

Table 3-3 Amortization Menu Items















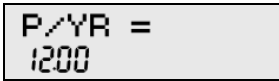



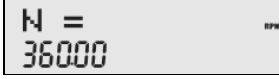



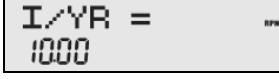









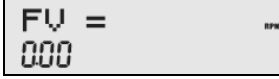

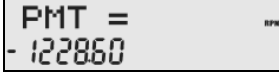

Menu Item/Key	Description
	Opens the Amortization menu.
Nb Period	Number of periods to group together in the amortization calculation. The default value is the number of payments per year defined by the key.
Start	Period on which to start amortization. Default is 1. If you want to amortize for the second year with 12 payments per year, enter 13 (the second year starts at the 13 th payment with 12 payments per year).
Balance	The loan balance at the end of the assigned amortized period.
Principal	Amount of the loan payment applied to the principal at the end of the amortized period.
Interest	Amount of the loan payment applied to the interest at the end of the amortized period.

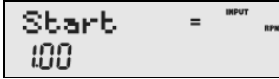

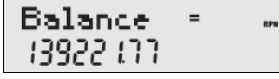

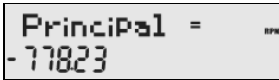
Enter the values for the TVM keys for the example below. Press  followed by  or  to view the amortization schedule.

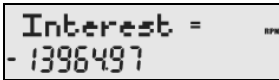
Creating an Amortization Schedule

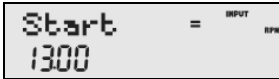
You borrow 140,000.00 for 360 months at 10% interest. Create an amortization schedule for the loan. How much interest did you pay for the first year? What is the balance of your loan after the first year? See Table 3-4. The example below is shown with RPN as the active operating mode.

Table 3-4 Amortization Example

Keys	Display	Description
   		Inputs 12 as the number of payments per year.
   		Inputs 360 (30 times 12 payments per year) as the number of payments for the 30-year loan.
  		Inputs 10 as the interest rate percentage per year.
      		Inputs the value of the loan at the time of the first payment.
 		Inputs 0 as the future value of the loan (zero balance).
		Calculates the monthly payment.
		Displays the number of periods to group together in the amortization schedule. Default is the current value of P/YR.
		Displays the first period of the group of periods to amortize.
		Displays the current balance remaining after the first year.
		Displays the current amount of the principal applied towards the loan for the first year.
		Displays the amount of interest paid on the loan for the first year. The amount of your payments applied towards interest for the first year is about 14,000.00.
		Displays the first payment in the next period to amortize (the second year). Note that the calculator automatically updates Start to the next group of periods to amortize.

To reset the menu items to their default values, with any item of the Amortization menu displayed press  . With *TVM* displayed, press . At the *TVM Reset* prompt, press  to reset, or  to cancel.

Interest Conversion Menu

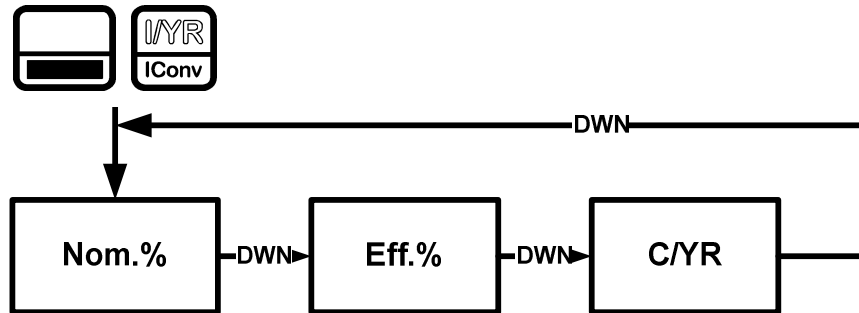

Figure 3 The Menu Map for the Interest Conversion Menu



To open the Interest Conversion menu (IConv) press  .

Table 3-5 Interest Conversion Menu Items

Item	Description
Nom.%	Nominal interest rate: the stated annual interest rate compounded as represented by <i>P/YR</i> , such as 18% compounded monthly (<i>P/YR</i> =12).
Eff.%	Effective annual interest rate taking compounding into account.
C/YR	Compounding periods per year. Default is 12.

Using the Interest Conversion Menu

Find the effective rate of a 36.5% nominal rate compounded daily. See Table 3-6. See Figure 3 for help with navigating through the menu.

Table 3-6 Interest Rate Conversion Example









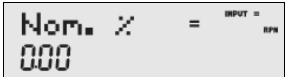

Keys	Display	Description
 		Opens the IConv menu, starting with the current value of the nominal percentage rate.
    		Inputs 36.5 as the nominal percentage rate.
		Scrolls to compounding periods per year, <i>C/YR</i> . Default value is 12.

Table 3-6 Interest Rate Conversion Example

Keys	Display	Description
		Inputs 365 as the value for the number of compounding periods per year.
		Scrolls to the variable for the effective rate and calculates it. A 36.5% nominal rate compounded daily equals an effective rate of 44.03%.

Note: C/YR is the same number as P/YR in TVM calculations, since most interest calculations are based on the same number of payments and compounding periods per year, and interest rate conversions are commonly linked to a subsequent TVM calculation. This feature is provided for your convenience, but this means modifying one number also modifies the other. If your TVM problem requires different values for P/YR and C/YR, refer to the section below titled, *Canadian Mortgages: TVM Canada*.

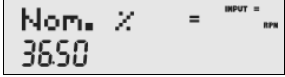
The IConv menu permits you to solve for C/YR, but the result is not always a positive integer. TVM calculations, however, require C/YR to be an integer larger than zero. If you attempt to perform a TVM calculation without a valid value for C/YR or P/YR, an invalid P/YR error (ER: Invalid P/YR) will occur.

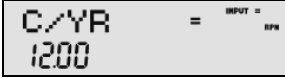
If you set C/YR to 0, the resulting interest conversions are calculated assuming a continuous compounding. As stated above, 0 is not a valid value for P/YR or C/YR when used in TVM calculations, and you will have to reset it to a valid value before performing TVM calculations.

To reset the menu items to their default values, with any item of the Interest Conversion menu displayed press . With IConv displayed, press to reset, or to cancel. To exit the menu, press once again.

Canadian Mortgages: TVM Canada

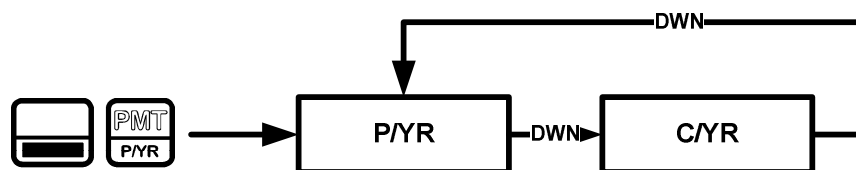





Figure 4 The Menu Map for the P/YR Menu

In Canada, interest rates for mortgages are, by law, given as a nominal interest rate, compounded twice yearly. This means that the compounding period for the per-period interest rate calculation differs from the compounding period used to calculate the nominal rate.

By default, the HP 20b performs calculations assuming that the number of compounding periods always equals the number of payments per year. You can, however, enable the *TVM Canada* option in the Mode menu, which enables you to select the number of compounding periods per year. For more information, refer to Chapter 1, *Basic Features*.

With *TVM Canada* enabled in the Mode menu, the following TVM features change:

1. The P/YR key, , now opens a menu with two items, P/YR and C/YR, in which you can specify the number of payments and compounding periods per year. Press  or  to scroll through the menu. See Figure 4.
2. To change the value of an item, with the item displayed, enter the number desired followed by .
3. In the Interest Conversion menu, the C/YR item has the same value as the C/YR item in the P/YR menu, and C/YR and no longer affects P/YR.
4. Note, however, if you now change the value of P/YR, the calculator automatically sets C/YR so it equals your new value assigned to P/YR. This means that if you modify P/YR, you also need to modify C/YR, if P/YR and C/YR are different values in your TVM problem.

Canadian Mortgage Example

Calculate the monthly payment for a 25-year (N=300) Canadian mortgage valued at 350,000.00, if the nominal interest rate is 6.0%, compounded twice yearly (C/YR=2) with 12 payments per year (P/YR).

Table 3-7 Canadian Mortgage Example

Keys	Display	Description
	FIX = INPUT = 200	Opens the Mode menu, starting with the current <i>FIX</i> value (number of digits to the right of the decimal point).
	TVM Cana INPUT	Scrolls to TVM mode and sets mode to <i>TVM Canada</i> .
	000	Returns to default calculator screen.
	C/YR = INPUT = 200	Opens P/YR menu. Inputs 12 for P/YR and 2 for C/YR.
	PV = 350000.00	Exits menu and inputs values for N, I/YR, and PV.
	PMT = -2239.32	Calculates the monthly payment as required by the example.

To reset the menu, press . With *TVM* displayed, press . At the *TVM Reset* prompt, press to reset, or to cancel. To exit the menu, press once again. With the menu set to its default settings, P/YR and C/YR are both set to 12 payments/compounding periods per year.

4 Cash Flows

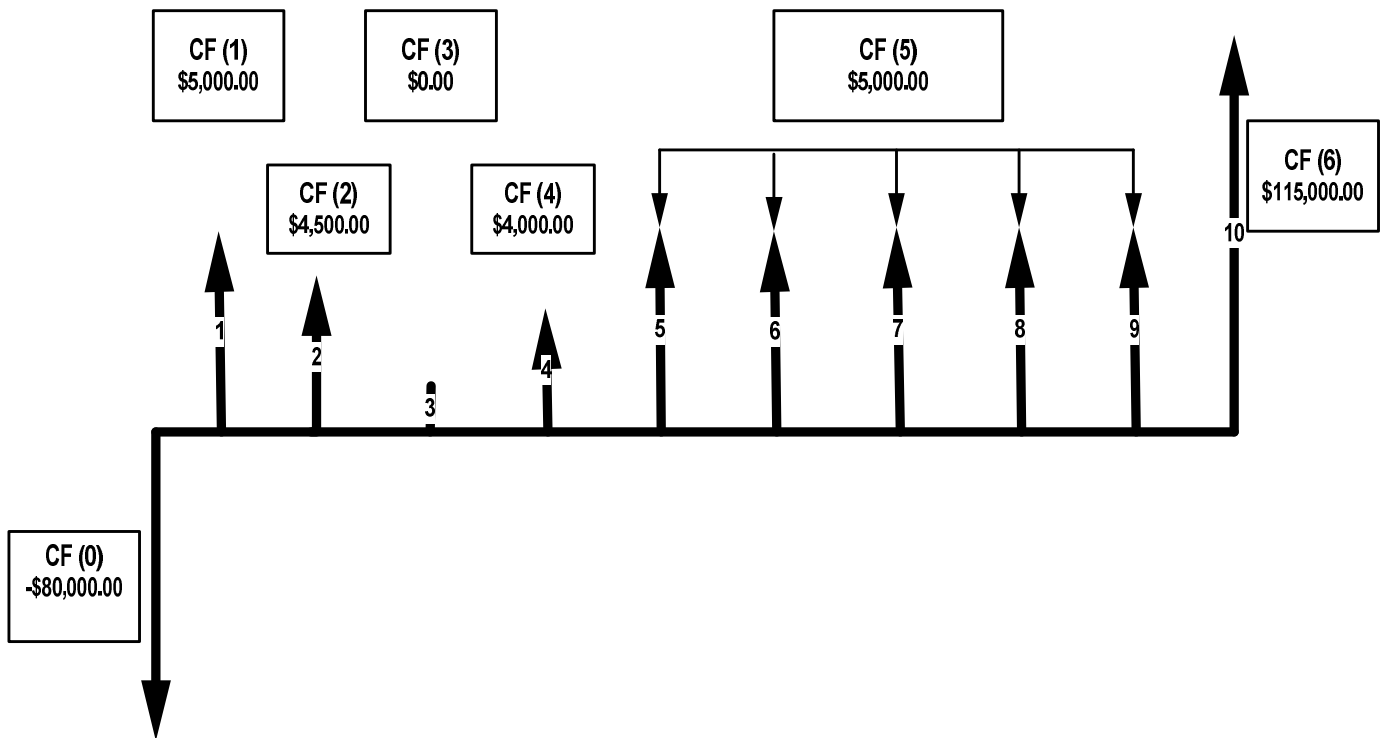

Figure 1 Cash Flow Diagram

In the calculator, a cash flow list is a set of numbered pairs, $CF(n)$ and $\#CF(n)$, where n is the index of the cash flow list. Each pair represents one or more cash flows in a cash flow diagram. As with TVM problems, it helps to sketch a cash flow diagram as a first step in solving cash flow problems. For some examples of cash flow diagrams, see Figure 3 at the end of this chapter.

$CF(n)$ represents the monetary value of the cash flow; $\#CF(n)$ represents the number of consecutive occurrences of that cash flow. By default, $\#CF(n)$ is equal to 1, as most cash flows occur only once. However, in cases where a cash flow is repeated multiple times, using $\#CF(n)$ instead of entering the cash flow value multiple times saves calculation time and memory space in the calculator.

To enter a cash flow list, press to open the cash flow menu.

For each cash flow item, first enter the monetary value followed by , then enter the number of occurrences followed by .

If a cash flow occurs once, you do not need to type . Simply press or as 1 is the default.













To erase a cash flow list, with any cash flow displayed press  . The number of cash flows in the list is displayed on the bottom line, along with *Cash Flow=*. At this prompt, press . You will be asked to confirm your choice. Either press  to confirm the reset, or  to cancel.

Table 4-1 lists the keys used for cash flow problems. For a cash flow example, see Table 4-2.

Table 4-1 Cash Flow Keys

Key	Description
	Opens the cash flow list.
	Inputs new values for variables in the cash flow list, the Net Present Value (NPV) menu, and the Internal Rate of Return (IRR) menu.
	Scrolls up and down.
	Inserts cash flows into a cash flow list.
	Removes cash flows from a cash flow list.
 	Opens the Internal Rate of Return (IRR) and Net Present Value (NPV) menus.

Cash Flow Example

After an initial investment of 80,000.00, *cash flow (0)*, you expect returns over the next five years as follows:

Cash Flow Number	Cash Flow Amount	Occurrences
1	5,000.00	1
2	4,500.00	1
3	0.00	1
4	4,000.00	1
5	5,000.00	5
6	115,000.00	1

Given this information, calculate the total of the cash flows and the internal rate of return (IRR) of the investment. Calculate net present value (NPV) and net future value (NFV), assuming an annual investment interest rate of 10.5%. See Figure 1 for the cash flow diagram and Table 4-2 for how to enter the cash flows. The example is shown with RPN as the active operating mode.





Table 4-2 Cash Flow Example

Keys	Display	Description
		Opens the cash flow list.
		Inputs -80000 as the monetary value of the initial cash flow. Note: the sign of the cash outflow is negative.
		Accepts 1 as the number of occurrences for CF(0). Displays the current monetary value of CF(1).
		Inputs 5000 as the monetary value of CF(1). Displays the current value, 1, for the number of times CF(1) occurs.
		Accepts 1 as the number of occurrences for CF(1). Displays the current monetary value of CF(2).
		Inputs 4500 as the monetary value of CF(2). Displays the current value, 1, for the number of times CF(2) occurs.
		Accepts 1 as the number of occurrences for CF(2). Displays the current monetary value of CF(3).
		Accepts 0 as the monetary value of CF(3). Displays the current value, 1, for the number of times CF(3) occurs.
		Accepts 1 as the number of occurrences for CF(3). Displays the current monetary value of CF(4).
		Inputs 4000 as the monetary value of CF(4). Displays the current value, 1, for the number of times CF(4) occurs.
		Accepts 1 as the number of occurrences for CF(4). Displays the current monetary value of CF(5).
		Inputs 5000 as the monetary value of CF(5). Displays the current value, 1, for the number of times CF(5) occurs.
		Inputs 5 for the number of occurrences for CF(5). Displays the current monetary value of CF(6).

Table 4-2 Cash Flow Example

Keys	Display	Description
<div style="display: flex; justify-content: space-around; align-items: center;"> <div style="border: 1px solid black; padding: 2px; margin: 2px;">1 RAND</div> <div style="border: 1px solid black; padding: 2px; margin: 2px;">1 RAND</div> <div style="border: 1px solid black; padding: 2px; margin: 2px;">5 e^x</div> <div style="border: 1px solid black; padding: 2px; margin: 2px;">0 nPr</div> <div style="border: 1px solid black; padding: 2px; margin: 2px;">0 nPr</div> <div style="border: 1px solid black; padding: 2px; margin: 2px;">0 nPr</div> </div> <div style="border: 1px solid black; padding: 2px; margin-top: 5px; width: fit-content;">INPUT Memory</div>	<div style="border: 1px solid black; padding: 5px; text-align: center;"> #CF(6) = INPUT nPr 100 </div>	Inputs 115000 as the monetary value of CF(6). Displays the current value, 1, for the number of times CF(6) occurs.
<div style="border: 1px solid black; padding: 2px; margin-top: 5px; width: fit-content;">INPUT Memory</div>	<div style="border: 1px solid black; padding: 5px; text-align: center;"> CF(7) = INPUT nPr 000 </div>	Accepts 1 as the number of occurrences for CF(6).

Analyzing Cash Flows

The various functions used to analyze cash flows are located in the NPV  and IRR  menus. If you press  or  before entering cash flows, you will be redirected to the cash flow menu to enter values into the cash flow list. The menu maps for the IRR and NPV menus are shown in Figure 2. Table 4-3 describes the items within these menus.

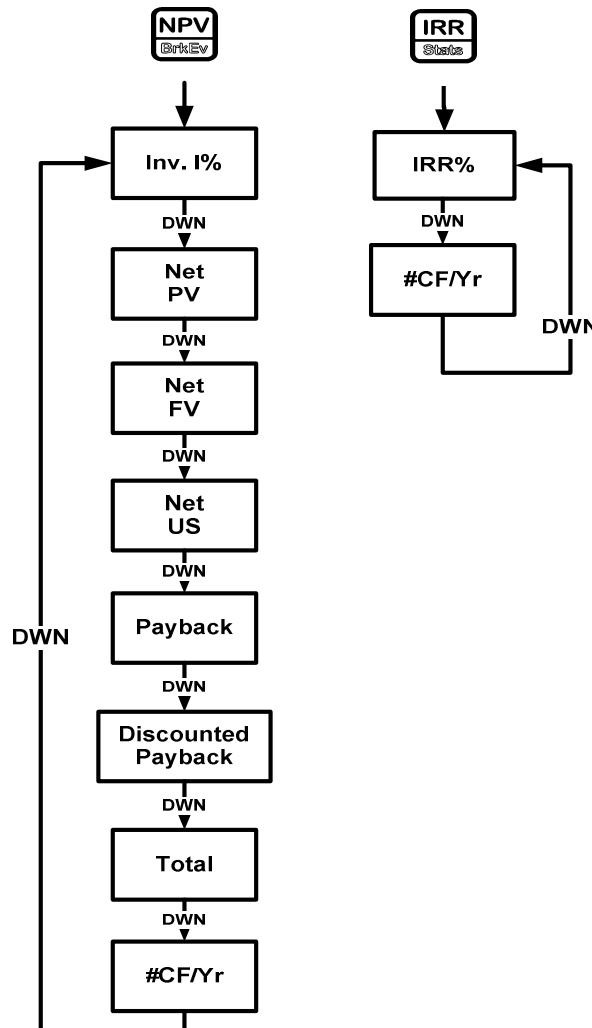



Figure 2 The Menu Map for the NPV and IRR Menus

Table 4-3 NPV and IRR Menu Items

Item	Description
Inv. I%	Investment or discount rate. Enter the investment rate or discount rate for the cash flow followed by  .
Net PV	Net present value. Shows the value of the cash flows at the time of the initial cash flow, discounting the future cash flows by the value set for <i>Inv. I%</i> .
Net FV	Net future value. Shows the value of the cash flows at the time of the last cash flow, discounting the earlier cash flows by the value set for <i>Inv. I%</i> .
Net US	Net uniform series. Shows the per-period payment of a regular, periodic cash flow of equivalent present value to the cash flow list.
Payback	Payback. Shows the number of periods for the investment to return value.
Discounted Payback	Discounted Payback. Shows the number of periods required for the investment to return value if the cash flows are discounted using the value set in <i>Inv. I%</i> .
Total	The sum of all the cash flows, equivalent to NPV if <i>Inv. I%</i> is 0.
#CF/Yr	The number of cash flows per year. The default is 1.
IRR%	Internal rate of return. This is the discount rate for the cash flow that returns a Net Present Value of 0.

See Table 4-4 for an example of the NPV and IRR functions using the cash flow example in Table 4-2.

Table 4-4 NPV and IRR Example











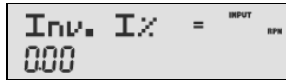





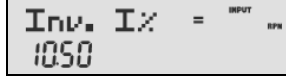

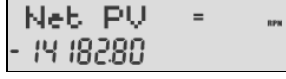

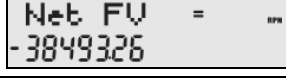

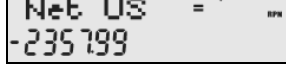

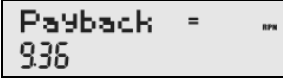

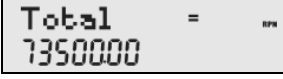

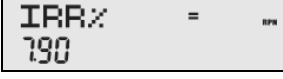

Keys	Display	Description
		Opens the NPV menu.
    		Inputs 10.5 for investment rate.
		Displays the NPV of the cash flow with the given <i>Inv. I%</i> .
		Displays the NFV of the cash flow with the given <i>Inv. I%</i> .
		Displays the Net US of the cash flow with the given interest rate.

Table 4-4 NPV and IRR Example

Keys	Display	Description
		Displays the number of periods required for the cash flow to repay the investment.
 		Scrolls to the total value of the cash flow.
		Displays the IRR for the cash flow.

Editing Cash Flows

In the cash flow list, you can view and modify the current monetary value of a specific cash flow, or cash flows. Press  or  repeatedly to scroll through the list. To modify the displayed entry, type a new number and press . For example, to change the current monetary value of the cash flow three, $CF(3)$, in the example in Table 4-2 from 0 to 200, with $CF(3)=$ displayed, press    followed by .

You can also modify the number of occurrences of a cash flow in the same manner with $\#CF(n)$ displayed. Pressing   with a cash flow displayed erases the displayed cash flow. Pressing   inserts a cash flow into the list before the displayed cash flow.

Sample Cash Flow Diagrams

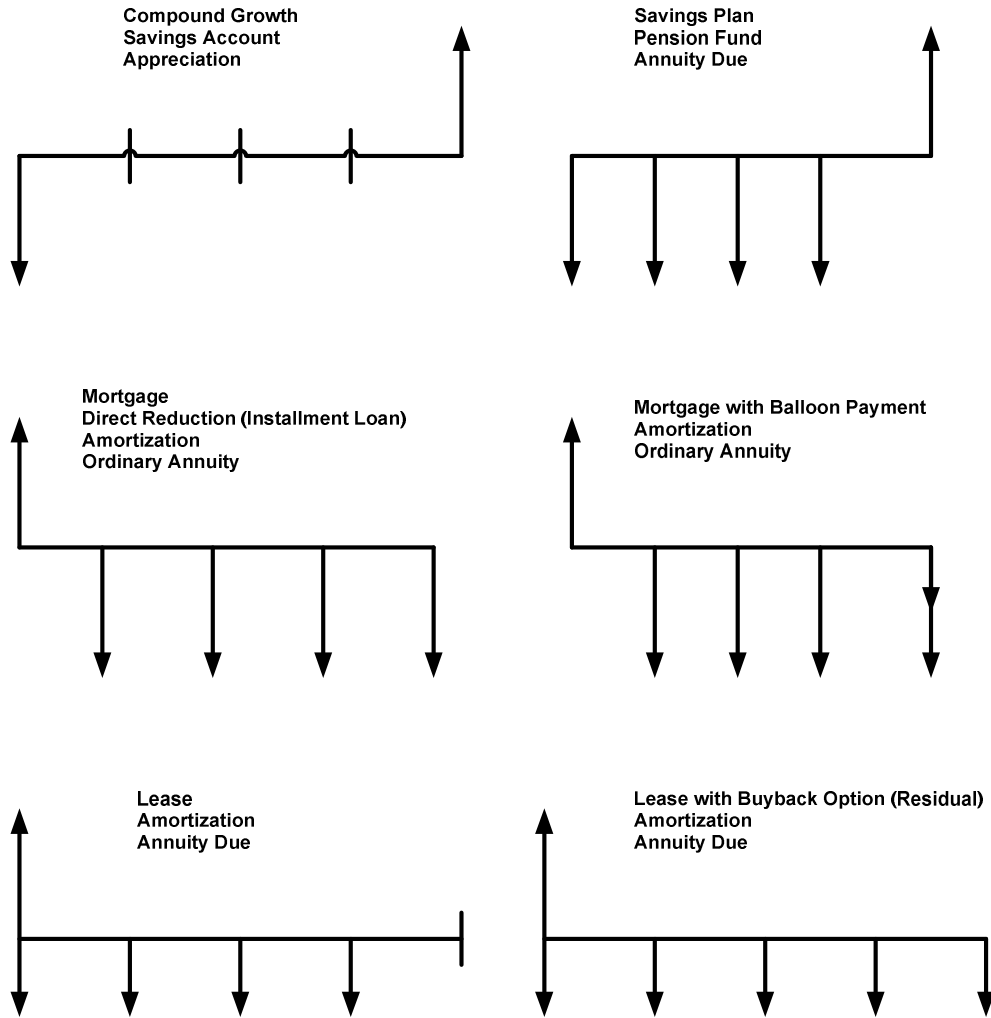

Figure 3 Sample Cash Flow Diagrams

5 Bonds

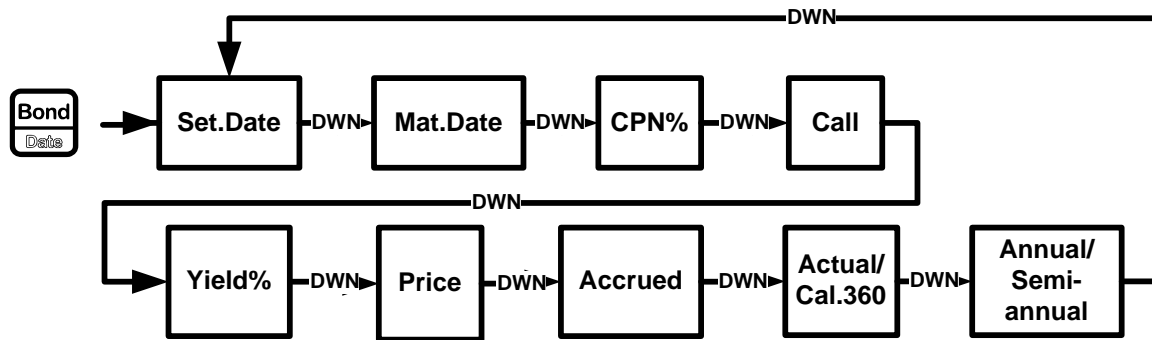





Figure 1 The Menu Map for the Bond Menu

The Bond Menu

Before you enter the Bond menu, be sure to verify the date format is set appropriately for your problem. The default setting is *mm.ddyyyy*, but it can be set for *dd.mmyyyy*. Bond day counts (360/365) and annual or semiannual coupon payment schedules may be set from either the Mode menu or the Bond menu. For more information on setting the preferences in the Mode menu, see the section titled, *The Mode Menu: Setting Preferences* in Chapter 1.

To open the Bond menu, press .

Press  or  repeatedly to scroll through the items shown in Figure 1.







To change the value of the displayed item, key in a number or a date and press . Once you have entered all known data, press  or  repeatedly to scroll to an unknown item, and press  to calculate it.

Table 5-1 lists the items in the Bond menu.

Table 5-1 Bond Menu Items

Variable	Description
Settlement Date	Settlement date. Displays the current settlement date. Note: input only.
Maturity Date	Maturity date or call date. The call date must coincide with a coupon date. Displays the current maturity. Note: input only.
CPN%	Coupon rate stored as an annual %. Note: input only.

Table 5-1 Bond Menu Items

Variable	Description
Call	Call value. Default is set for a call price per 100.00 face value. A bond at maturity has a call value of 100% of its face value. Note: input only.
Yield%	Yield% to maturity or yield% to call date for given price. Note: input/output.
Price	Price per 100.00 face value for a given yield. Note: input/output.
Accrued	Interest accrued from the last coupon or payment date until the settlement date for a given yield. Note: this item is Read-only.
Actual/Cal.360	Actual (365-day calendar) or Cal.360 (30-day month/360-day year calendar). Press  to toggle between these options.
Annual/Semiannual	Bond coupon (payment) frequency. Press  to toggle between these options.

Bond Calculation Example

What price should you pay on April 28, 2010 for a 6.75% U.S. Treasury bond maturing on June 4, 2020, if you want a yield of 4.75%? Assume the bond is calculated on a semiannual coupon payment on an actual/actual basis. See Table 5-2. The example below is shown with RPN as the active operating mode.

Table 5-2 Bond Calculation Example













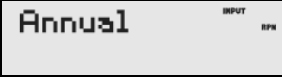

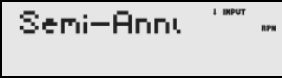
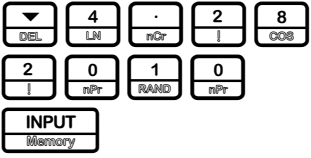
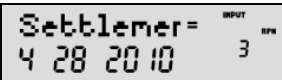
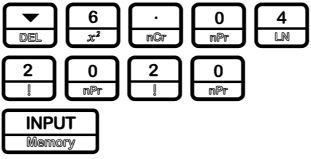
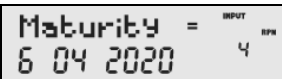
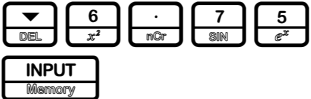
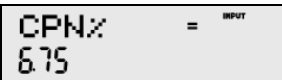









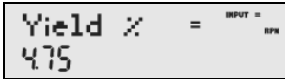





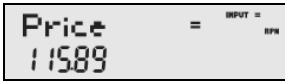

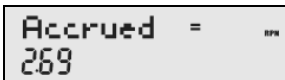
Key	Display	Description
		Opens the Bond menu.
		Scrolls to bond coupon (payment) frequency.
		Selects semiannual coupon payment, as required by the example.
		Inputs April 28, 2010 for the settlement date (<i>mm.dyyyy</i> format).
		Inputs June 4, 2020 for the maturity date.
		Inputs 6.75% for the value for <i>CPN%</i> .

Table 5-2 Bond Calculation Example

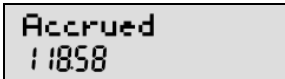
Key	Display	Description
		Displays current call value. Default is 100. Note: if <i>Call</i> requires another value, key in the number followed by  .
     		Inputs 4.75% for <i>Yield%</i> .
 		Calculates the current value for <i>Price</i> .
 		Stores 115.89 in memory 1.
		Displays the current value for accrued interest.
   		Returns the result for total price (value of price + value of accrued interest). The net price you should pay for the bond is 118.58.

To reset the menu items to their default values, with any item of the Bond menu displayed press  . With *Bond* displayed, press  to reset the menu, or  to cancel. Press  again to exit the menu.

6 Date Calculation

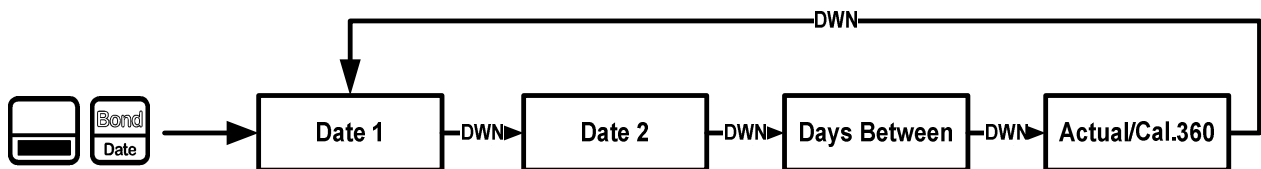

Figure 1 The Menu Map for the Date Calculation Menu

The Date Calculation Menu

The Date Calculation menu is used to calculate the number of days between two dates, or a second date given a number of days from an initial, or final date. To open the Date Calculation menu, press . Press or repeatedly to scroll through the items shown in Figure 1. Before you enter dates, verify the date is set in the format required for your problem. Date and calendar formats may be set in the Mode menu. For more information on setting the preferences in the Mode Menu, see the section titled, *The Mode Menu: Setting Preferences* in Chapter 1.

To change the value of a displayed item, key in a number or a date and press . Once you have entered all known data, press or repeatedly to scroll to the unknown item and press to calculate it.













Date Calculation Example



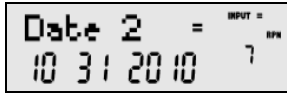

How many days remain in the 2010 fiscal year if today's date is June 4, 2010? Assume the fiscal year ends on October 31st, and you wish to calculate the actual number of days (Actual).

Table 6-1 Date Calculation Example

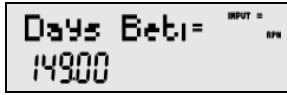
Key	Display	Description
		Opens the Date Calculation menu. Note: 2 in the right of the display represents the day of the week. 2 represents Tuesday.
 		Inputs the starting date in the selected format.

Table 6-1 Date Calculation Example

Key	Display	Description
          		Inputs the ending date in the selected format.
 		Calculates the number of actual days between the starting and ending dates.

To reset the menu items to their default values, with any item of the Date menu displayed press  . With *Date* displayed, press  to reset the menu, or  to cancel. Press  again to exit the menu.

7 Break-even

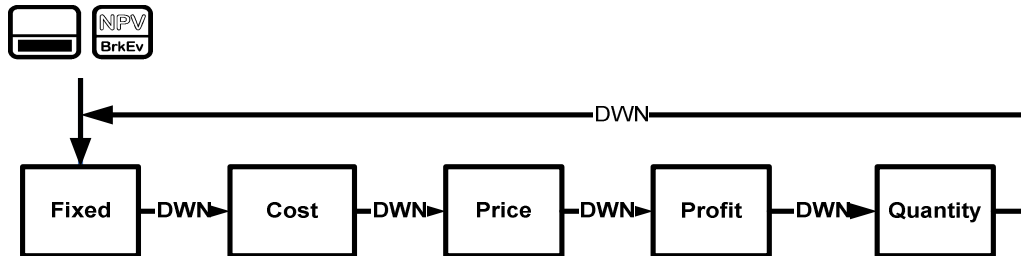

Figure 1 The Menu Map for the Break-even Menu

The Break-even Menu

To open the Break-even menu, press . To change the value of the displayed item, key in a number and press . Once you have entered all known data, press or repeatedly to scroll to the unknown item and press to calculate it.

The break-even function allows you to study problems involving a profit, when a quantity of items, with a cost to manufacture and a fixed price to develop and market, is sold at a given price. See Figure 1.



Break-even Example





The sale price of an item is 300.00, the cost is 250.00, and the fixed cost is 150,000.00. How many units would have to be sold to make a profit of 10,000.00?

Table 7-1 Break-even Example

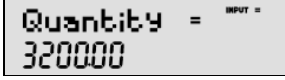
Keys	Display	Description
		Opens the Break-even menu starting with the current value for fixed costs.
 		Inputs 150,000.00 for fixed cost.
 		Inputs 250.00 for variable cost per unit.
 		Inputs 300.00 for price.
 		Inputs 10,000.00 for profit.

Table 7-1 Break-even Example

Keys	Display	Description
 		Calculates the current value for the unknown item. 3200 units would have to be sold to return a profit of 10,000.00.

To reset the menu items to their default values, with any item of the Break-even menu displayed press  . With *BrkEven* displayed, press  to reset the menu, or  to cancel. Press  again to exit the menu.

8 Business Problems

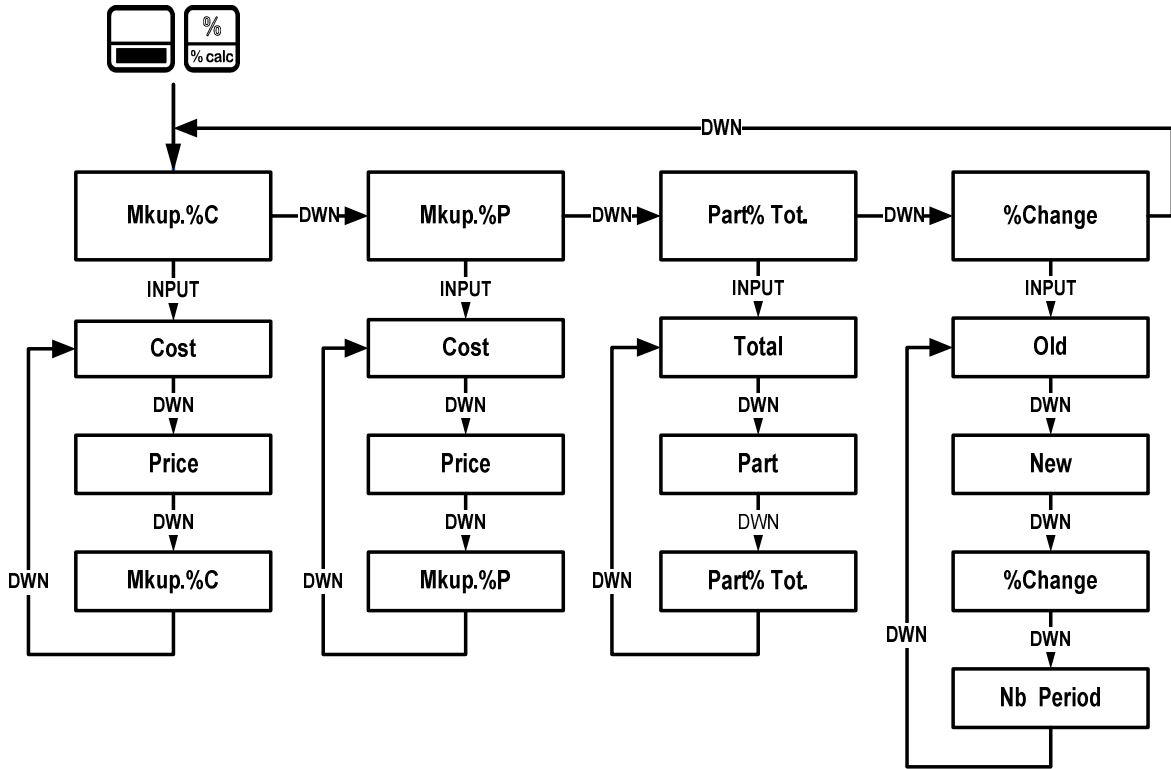













Figure 1 The Menu Map for the Percent Calculation (%calc) Menu

The Percent Calculation Menu

Press   to open the menu. There are four items in this menu: markup as a percentage of cost (*Mkup. %C*), markup as a percentage of price (*Mkup. %P*), part as a percentage of total (*Part% Tot.*), and percent change (*%Change*). These items allow you to access sub-menus. Press  or  repeatedly to scroll to the desired sub-menu, then press  to open it. See Figure 1.

To change the value of a displayed item, key in a number and press . Once you have entered all known data, press  or  repeatedly to scroll to the unknown item and press  to calculate it.

To return to the percent calculation menu, from anywhere within the menu or sub-menus, press  .

To exit the menu, press .















Note: for business problems, margin is based on price; markup is based on cost. The examples below are shown with RPN as the active operating mode.

Percent Calculation Examples

See Tables 8-1 through 8-4 for examples of calculations in the %calc menu.



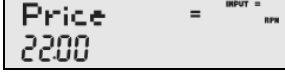

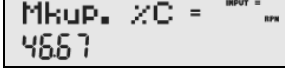







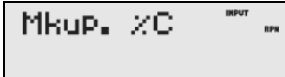







1. Find the markup on an item if the cost price is \$15.00 and the selling price is \$22.00. See Table 8-1.

Table 8-1 Markup Example

Keys	Display	Description
 		Opens the %calc menu.
		Opens the <i>Mkup.%C</i> sub-menu.
  		Inputs 15 for <i>Cost</i> .
   		Inputs 22 for <i>Price</i> .
 		Calculates the value of <i>Mkup.%C</i> for the given data.

2. Find the percent change between 20 and 35 with no compounding.

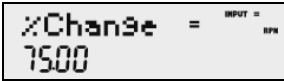





Table 8-2 Percent Change Example

Keys	Display	Description
 		Opens the %calc menu.
  		Scrolls to <i>%Change</i> .
		Opens the <i>%Change</i> sub-menu.
  		Inputs 20 for <i>Old</i> .
   		Inputs 35 for <i>New</i> .
 		Calculates the current value of <i>%Change</i> for the given data.

Note: although the example in Table 8-2 calls for no compounding, you may specify the number of compounding periods used in calculations with the *Nb Period* item in the %Change sub-menu. *Nb Period* is the number of compounding periods used in calculations between the old value and new value. The default is 1, but to change the setting, key in a number with *Nb Period* displayed, followed by .





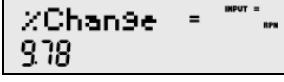







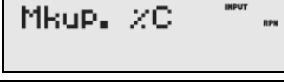

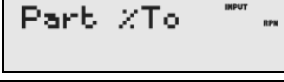

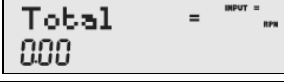

After calculating the example above with no compounding, say, for example, you wish to calculate the percent change over six compounding periods:

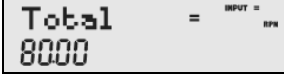



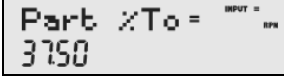

Table 8-3 Percent Change Example with Compounding

Keys	Display	Description
		The current value of %Change for the given data.
  		Inputs 6 for the number of compounding periods.
 		Calculates the percent change between the old value and the new value over six compounding periods.

3. What is 30% of 80?

Table 8-4 Part % of Total Example

Keys	Display	Description
 		Opens the %calc menu.
 		Scrolls to the <i>Part %Total</i> menu item.
		Opens the <i>Part as %Total</i> sub-menu.
  		Inputs 80 for <i>Total</i> .
   		Inputs 30 for <i>Part</i> .
 		Calculates the value of <i>Part%Total</i> for the given data.

To reset the menu items to their default values, with any item of the %calc menu displayed press  . Press  or  to scroll until %Calc displays and press  to reset the menu, or  to cancel. Press  to exit the menu.

9 Depreciation

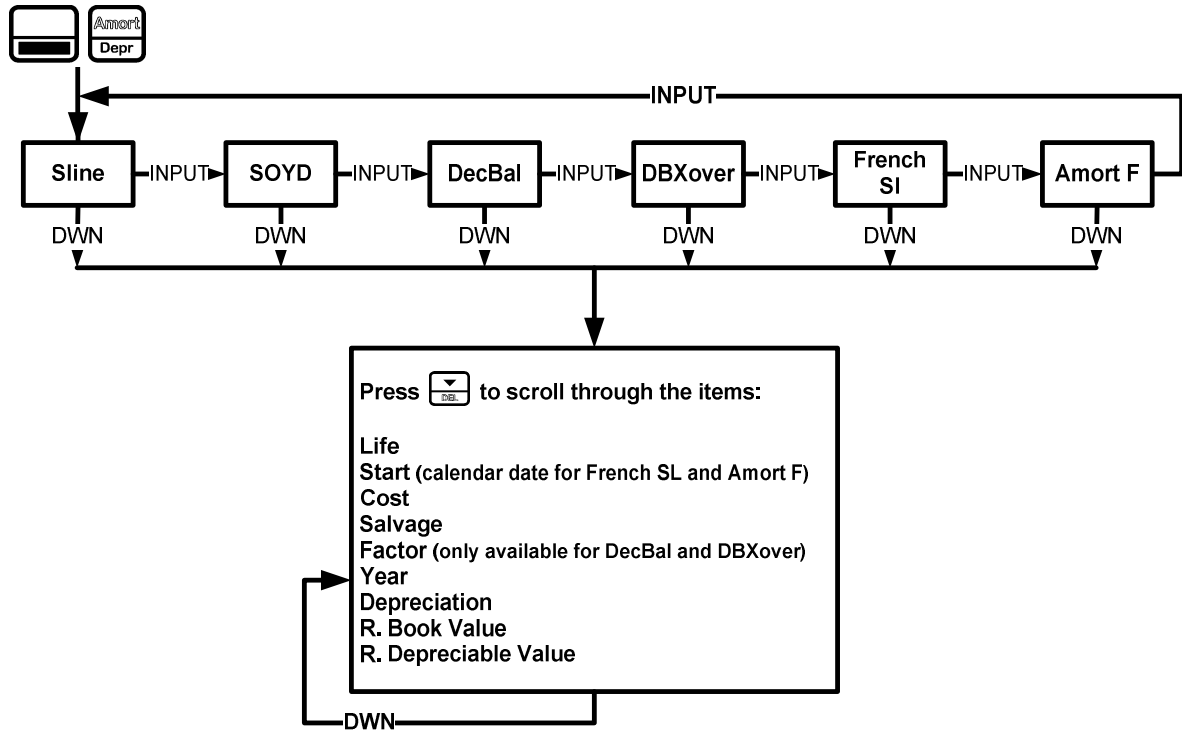



Figure 1 The Menu Map for the Depreciation Menu

The Depreciation Menu

Press to open the Depreciation menu. To select a depreciation method, press repeatedly. See Figure 1. Input the values required for the calculation:

- Asset life
- Starting date or month of the depreciation
- Cost and salvage values
- Declining balance factor (DecBal and DBXover only)
- The first year for which you want to view the depreciation schedule

Scroll through the items of the sub-menu for the selected depreciation method by pressing or repeatedly. To change the value of the displayed item, key in a number and press . For the *Start* item, enter either a number or an actual date, depending on the type of depreciation selected. Press repeatedly to view the depreciation schedule.

Note: pressing  on the last item of a sub-menu returns you to the *Year* item, not to the top of the sub-menu (see Figure 1). By scrolling through all the items of a sub-menu, you incrementally advance the *Year* item. This allows you to see the depreciation schedule for the next year without additional entries.

Brief descriptions of the methods used to calculate depreciation are provided in Table 9-1. Table 9-2 describes the items found in the depreciation sub-menus. For an example calculating depreciation using the straight-line method, see Table 9-3.

Table 9-1 Depreciation Methods

Depreciation Method	Description
Sline	Straight line is a method of calculating depreciation presuming an asset loses a certain percentage of its value annually at an amount evenly distributed throughout its useful life.
SOYD	Sum-of-the-years' digits is an accelerated depreciation method. In SOYD, the depreciation in year <i>Y</i> is $(\text{Life}-Y+1)/\text{SOY}/100\%$ of the asset, where <i>SOY</i> is the sum-of-the-years for the asset, or, for an asset with a 5-year life, $5+4+3+2+1=15$.
DecBal	Declining balance is an accelerated depreciation method that presumes an asset will lose the majority of its value during the first few years of its useful life.
DBXover	Declining balance crossover is an accelerated depreciation method that presumes an asset will lose the majority of its value in the first few years of its useful life, but that it will revert to a consistent depreciation during the latter part of its life, which is then calculated using the straight line method.
French SL	Straight line French. This method of depreciation is similar to the Straight line method, except an actual calendar date in the selected format is entered in for <i>Start</i> to indicate when the asset was first placed into service.
Amort F	French amortization. This method is an accelerated depreciation method with a crossover to the French Straight Line method.

Table 9-2 Depreciation Menu Items

Item	Description
Life	The expected useful life of the asset in years.
Start	<i>Start</i> refers to the date or month in which the asset is first placed into service. Depending on the type of depreciation, this can be the month (1-12), or, in the case of French Straight-line and Amort F, the actual date in the selected format. Note: for non-French depreciations, if the asset were placed into service in the middle of March, for example, you would enter 3.5 for <i>Start</i> .
Cost	The depreciable cost of the asset at acquisition.

Table 9-2 Depreciation Menu Items

Item	Description
Salvage	The salvage value of the asset at the end of its useful life.
Factor	The declining balance factor as a percentage. This is used for declining balance and declining balance crossover methods only.
Year	Year for which you want to calculate the depreciation.
Depreciation	Depreciation in the given year.
R.Book Value	Remaining book value at the end of the given year.
R.Depreciable Value	Remaining depreciable value at the end of the given year.

Depreciation Example

A metalworking machine, purchased for 10,000.00, is to be depreciated over five years. Its salvage value is estimated at 500.00. Using the straight-line method, find the depreciation and remaining depreciable value for each of the first two years of the machine's life. See Table 9-3.

Table 9-3 Straight Line Depreciation Example













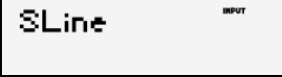



























Key	Display	Description
 		Opens the Depreciation menu starting with the straight line method.
  		Inputs 5 for the useful life.
		Displays the current value of <i>Start</i> . 1 (January) is the default value. For this example, this value remains unchanged, since the depreciation of the machine starts January 1 st (1.00).
      		Inputs 10,000.00 for the cost of the item.
    		Inputs 500.00 for the salvage value of the item.
		Year for which to calculate the depreciation. Year 1 is the default value. To calculate for a year other than 1, type a number and press  .
		Depreciation of the asset in year one.

Table 9-3 Straight Line Depreciation Example

Key	Display	Description
	R.Book V ₂ = 8 10000	Remaining book value after year one.
	R.DePreci: = 760000	Remaining depreciable value after year one.
	Year = ^{INPUT} 200	The next year for which to calculate the depreciation. To calculate for a year other than 2, type a number and press  .
	DePreciat = 190000	Depreciation of the asset in year two.
	R.Book V ₂ = 620000	Remaining book value after year two.
	R.DePreci: = 570000	Remaining depreciable value after year two.

To reset the menu items to their default values, with any item of the Depreciation menu displayed press  . With *Depreciation* displayed, press  to reset the menu, or  to cancel. Press  to exit the menu.

10 Statistical Operations

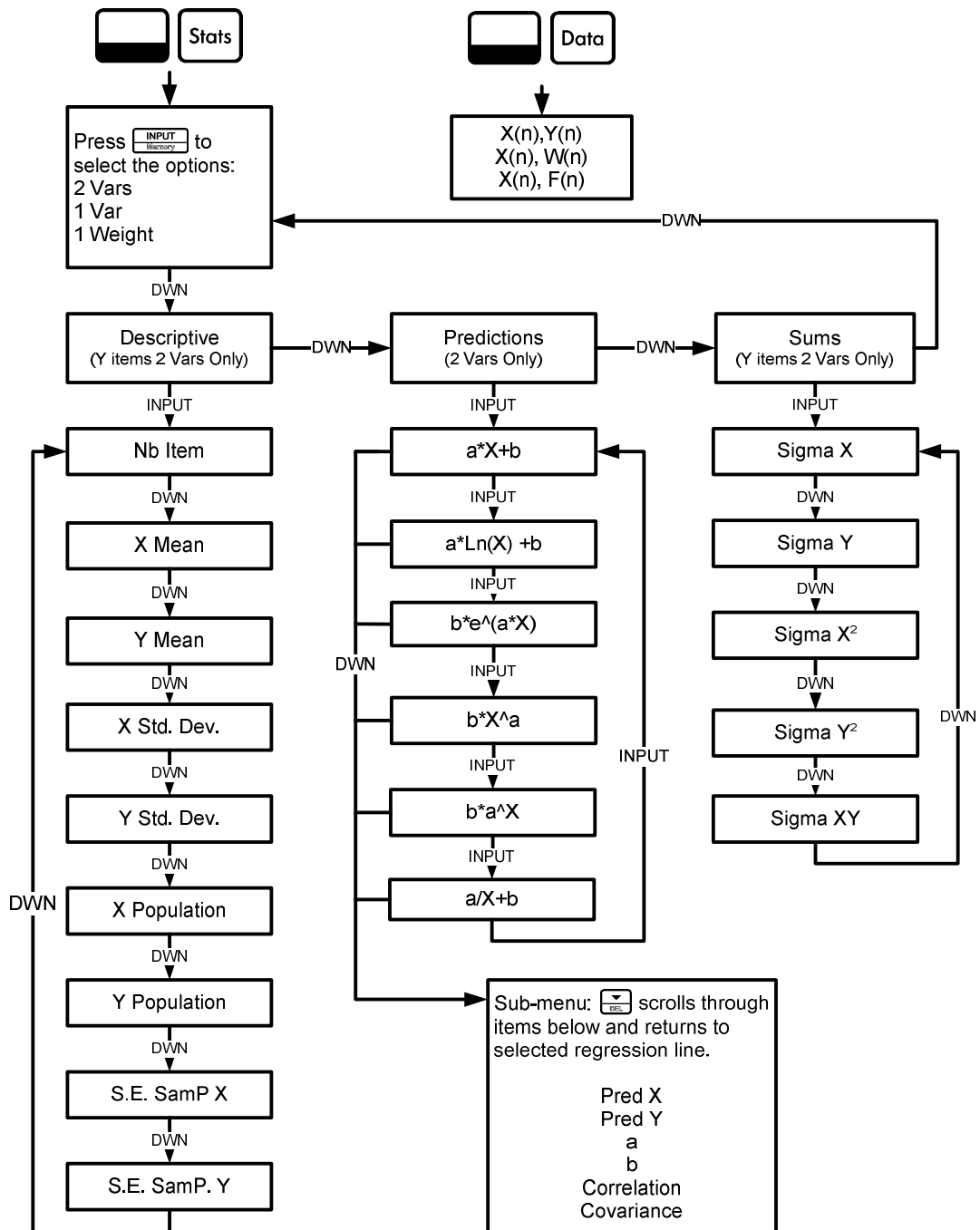

















Figure 1 The Menu Maps for the Data and Statistics Menus

The Data and Stats Menus



Statistics analysis functions are located in the Data and Statistics menus accessible with the   and   keys. See Figure 1 for assistance with navigating through the menus.

Press   to open the Data menu. In this menu, enter a list of x values for one-variable statistics, a list of pairs, (x, F) for weighted, one-variable statistics, a list of numbers x for one-variable statistics, or a list of pairs, (x, y) for two-variable statistics. To enter data, key in a number and press .

Press   to analyze the data. If you attempt to open the Statistics (Stats) menu before entering data, you will be redirected to the Data menu. When opened, the Stats menu displays *2 Vars* for two-variable statistics. Press  repeatedly to select the type of statistical operations desired, two-variable, (*2 Vars*), one-variable, (*1 Var*), or one-variable weighted (*1 Weight*).

After selecting the type of statistical operation you want, select a sub-menu by pressing  or , and press  to open it. Once in a sub-menu, press  or  repeatedly to view the results. To return from the sub-menu to the Statistics menu, press .

Note: in one-variable modes, there are no items for y and the *Predictions* sub-menu is not available.

Pressing  with the *Predictions* sub-menu displayed opens a sub-menu, in which you can choose among six different types of regression lines. See Figure 1. To select a specific type of regression line in the *Predictions* sub-menu, press  to cycle through the options. Note: if you press , the calculator automatically selects the curve that is the best fit for your data.

Once you select a regression line, press  to see the regression line parameters and perform predictions.

Table 10-1 The Statistics Menu Items

Menu Item	Description
Nb Item	Number of items.
\bar{X} Mean	Average of X values.
\bar{Y} Mean	Average of Y values.
X Std. Dev	Standard deviation for X: a measure of how dispersed the x data values are about the mean.
Y Std. Dev	Standard deviation for Y: a measure of how dispersed the y data values are about the mean.
X Population Dev	Population Standard deviation for X: a measure of how dispersed the X data values are about the mean, assuming the data constitutes a complete set of data.
Y Population Dev	Population Standard deviation for Y: a measure of how dispersed the y data values are about the mean, assuming the data constitutes a complete set of data.
S.E.SamP.X	Sample error for X: a measure of how dispersed the X data values are about the mean sample standard deviation, assuming the data is a sampling of a larger, more complete data set.
S.E.SamP.Y	Sample error for Y: a measure of how dispersed the Y data values are about the mean sample standard deviation, assuming the data is a sampling of a larger, more complete data set.
Pred X	Predicts X for a given hypothetical value of Y, based upon the model calculated to fit the data.
Pred Y	Predicts Y for a given hypothetical value of X, based upon the model calculated to fit the data.
a	The <i>a</i> coefficient for the chosen regression model, which is the slope for a linear model.
b	The <i>b</i> coefficient for the chosen regression model, which is the y-intercept for a linear model.
Correlation	The correlation coefficient for the given (x, y) data. The correlation coefficient is a number in the range -1 through 1 that measures how closely the calculated line fits the data.
Covariance	A measure of how much two variables change in relation to one another.
Sigma X	The sum of the x values.

Table 10-1 The Statistics Menu Items

Menu Item	Description
Sigma Y	The sum of the y values.
Sigma X ²	The sum of the squares of the x values.
Sigma Y ²	The sum of the squares for the y values.
Sigma XY	The sum of the products of the x and y values.

Statistics Example

Sales for the last five months are represented by the pairs of values shown below, with the month number as x, and the sales values as y. Enter these into the Data menu. Using the Statistics menu for *Predictions*, predict sales for month seven. What is the linear regression line? What is the sum of all the y values? See Tables 10-2 and 10-3.

Table 10-2 Months and Sales

Month	Sales Values
1	150
2	165
3	160
4	175
5	170

Table 10-3 Statistics Example









Keys	Display	Description
		Opens Data menu.
		Inputs values for X(1) and Y(1).
		Inputs values for X(2) and Y(2).
		Inputs values for X(3) and Y(3).
		Inputs values for X(4) and Y(4).

Table 10-3 Statistics Example

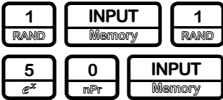
Keys	Display	Description
		Inputs values for X(5) and Y(5).
		Opens Stats menu.
		Opens Descriptive sub-menu.
		Displays average \bar{y} .
		Opens Predictions sub-menu. Note: this example performs calculations based on a linear ($a \cdot X + b$) regression line.
		Inputs 7 as the <i>Prediction X</i> value (month 7).
		Calculates <i>Prediction Y</i> value (sales at month 7).
		Displays value for a : the slope of the regression line.
		Displays current value for b : the y -intercept of the regression line.
		Displays value for <i>Correlation</i> .
		Opens <i>Sums</i> sub-menu. Displays the sum of all y values (Sigma Y).

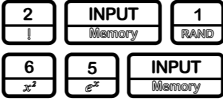
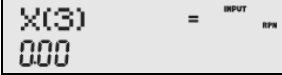
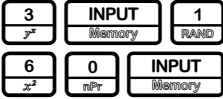
To reset the menu items to their default values, with any item of the Data or Statistics menus displayed press . At the prompt, *Stats*, press . Confirm your choice by pressing .

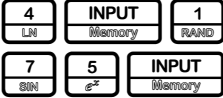
11 Errors

Error Messages and Calculator Status

Table 11-1 Error Messages

Error Message	Status
ER: Underflow	The calculation generated an underflow (result of 0).
ER: $x/0$	Division by zero.
ER: $0/0$	Zero divided by zero.
ER: $\infty * 0$	Infinite multiplied by zero.
ER: ∞ / ∞	Infinite divided by infinite.
ER: $\sqrt{} (x < 0)$	Square root of a negative number.
ER: LN (0)	LN of 0.
ER: LN ($x < 0$)	LN of a negative number.
ER: ATrig($ x > 1$)	ASIN or ACOS of a number for which the absolute value is > 1 .
ER: 1^{∞}	Attempted calculation of $1^{+/-\text{Infinite}}$.
ER: $(x < 0)^{\infty}$	Attempted calculation of the infinite power of a negative number.
ER: ∞^0	Attempted calculation of $+/-\infty^0$.
ER: ∞^{Frac}	Attempted calculation of $+/-\infty^{\text{(non-integer y)}}$.
ER: $(x < 0)^{\text{Frac}}$	Attempted calculation of $(-x)^{\text{(non-integer y)}}$.
ER: Out of Bounds	Input out of bounds.
ER: Invalid P/YR	Returned by TVM functions if payments per year are invalid (< 0 or non-integer).
ER: Invalid Input	Returned if arguments are invalid for any reason.
ER: Invalid I%	Returned by finance functions if I is $\leq 100\%$.
ER: No Solution	Returned when there is no solution to the problem.
ER: Many or No Solutions	Returned if there is no solution, or more than one solution to the problem.

Table 11-1 Error Messages

Error Message	Status
ER: Many Solutions	Returned when there are many solutions to the problem.
ER: Invalid N	Returned by TVM/Amort if N is invalid.
ER: User Abort	Returned by long functions if user stops the calculation prior to completion.
ER: ∞ Result	Returned if the result is infinite.
ER: Insufficient Data	Returned by statistics functions if there is insufficient data for analysis.
ER: No Payback	Returned by payback function if there is no payback on this problem.
ER: Unique solution to IRR Not Found	Returned if IRR tries to calculate a solution but cannot find it. User should supply a new guess...
ER: Stack	Stack overflow when performing calculations with more than 12 pending operations.
ER: Parenthesis:	An error linked to use of parentheses: unmatched, too many, etc.
ER: Insufficient Memory	Insufficient memory to complete the operation.
ER: No Solution Found	No solution found.

12 Warranty, Regulatory, and Contact Information

Replacing the Batteries

Use only fresh batteries. Do not use rechargeable batteries. The calculator takes two, 3-volt CR2032 lithium batteries. To install a new battery:

1. With the calculator turned off, slide the back cover off.
2. Remove one of the old batteries and replace it with a new battery with the positive polarity symbol facing outward.
3. Remove the second battery and replace it with a new battery with the positive polarity symbol facing outward.
4. Replace the back cover.

Warning! There is danger of explosion if the battery is incorrectly replaced. Replace only with the same or equivalent type recommended by the manufacturer. Dispose of used batteries according to the manufacturer's instructions. Do not mutilate, puncture, or dispose of batteries in fire. The batteries can burst or explode, releasing hazardous chemicals.

HP Limited Hardware Warranty and Customer Care

This HP Limited Warranty gives you, the end-user customer, express limited warranty rights from HP, the manufacturer. Please refer to HP's Web site for an extensive description of your limited warranty entitlements. In addition, you may also have other legal rights under applicable local law or special written agreement with HP.

Limited Hardware Warranty Period

Duration: 12 months total (may vary by region, please visit www.hp.com/support for latest information)

General Terms

HP warrants to you, the end-user customer, that HP hardware, accessories and supplies will be free from defects in materials and workmanship after the date of purchase, for the period specified above. If HP receives notice of such defects during the warranty period, HP will, at its option, either repair or replace products which prove to be defective. Replacement products may be either new or like-new.

HP warrants to you that HP software will not fail to execute its programming instructions after the date of purchase, for the period specified above, due to defects in material and workmanship when properly installed and used. If HP receives notice of such defects during the warranty period, HP will replace software media which does not execute its programming instructions due to such defects.

HP does not warrant that the operation of HP products will be uninterrupted or error free. If HP is unable, within a reasonable time, to repair or replace any product to a condition as warranted, you will be entitled to a refund of the purchase price upon prompt return of the product with proof of purchase.

HP products may contain remanufactured parts equivalent to new in performance or may have been subject to incidental use.

Warranty does not apply to defects resulting from (a) improper or inadequate maintenance or calibration, (b) software, interfacing, parts or supplies not supplied by HP, (c) unauthorized modification or misuse, (d) operation outside of the published environmental specifications for the product, or (e) improper site preparation or maintenance.

HP MAKES NO OTHER EXPRESS WARRANTY OR CONDITION WHETHER WRITTEN OR ORAL. TO THE EXTENT ALLOWED BY LOCAL LAW, ANY IMPLIED WARRANTY OR CONDITION OF MERCHANTABILITY, SATISFACTORY QUALITY, OR FITNESS FOR A PARTICULAR PURPOSE IS LIMITED TO THE DURATION OF THE EXPRESS WARRANTY SET FORTH ABOVE. Some countries, states or provinces do not allow limitations on the duration of an implied warranty, so the above limitation or exclusion might not apply to you. This warranty gives you specific legal rights and you might also have other rights that vary from country to country, state to state, or province to province.

TO THE EXTENT ALLOWED BY LOCAL LAW, THE REMEDIES IN THIS WARRANTY STATEMENT ARE YOUR SOLE AND EXCLUSIVE REMEDIES. EXCEPT AS INDICATED ABOVE, IN NO EVENT WILL HP OR ITS SUPPLIERS BE LIABLE FOR LOSS OF DATA OR FOR DIRECT, SPECIAL, INCIDENTAL, CONSEQUENTIAL (INCLUDING LOST PROFIT OR DATA), OR OTHER DAMAGE, WHETHER BASED IN CONTRACT, TORT, OR OTHERWISE. Some countries, States or provinces do not allow the exclusion or limitation of incidental or consequential damages, so the above limitation or exclusion may not apply to you.

The only warranties for HP products and services are set forth in the express warranty statements accompanying such products and services. HP shall not be liable for technical or editorial errors or omissions contained herein.

FOR CONSUMER TRANSACTIONS IN AUSTRALIA AND NEW ZEALAND: THE WARRANTY TERMS CONTAINED IN THIS STATEMENT, EXCEPT TO THE EXTENT LAWFULLY PERMITTED, DO NOT EXCLUDE, RESTRICT OR MODIFY AND ARE IN ADDITION TO THE MANDATORY STATUTORY RIGHTS APPLICABLE TO THE SALE OF THIS PRODUCT TO YOU.

Customer Care

In addition to the one year hardware warranty your HP calculator also comes with one year of technical support. If you need assistance, HP customer care can be reached by either email or telephone. Before calling please locate the call center nearest you from the list below. Have your proof of purchase and calculator serial number ready when you call.

Telephone numbers are subject to change, and local and national telephone rates may apply. For more support information, please visit the web at: www.hp.com/support.

Contact Information

Table 12-1 Contact Information

Country/Region	Contact
Africa (English)	www.hp.com/support
Afrique (français)	www.hp.com/support
Argentina	0-800-555-5000
Australia	1300-551-664
Belgique (français)	02 620 00 85
Belgium (English)	02 620 00 86
Bolivia	800-100-193
Brasil	0-800-709-7751
Canada	800-HP-INVENT
Caribbean	1-800-711-2884
Česká republikaik	296 335 612
Chile	800-360-999
China 中国	010-68002397
Colombia	01-8000-51-4746-8368
Costa Rica	0-800-011-0524
Denmark	82 33 28 44
Deutschland	069 9530 7103
Ecuador	800-711-2884
El Salvador	800-6160
España	913753382
France	01 4993 9006

Table 12-1 Contact Information

Country/Region	Contact
Greece Ελλάδα	210 969 6421
Guatemala	1-800-999-5105
Honduras	800-711-2884
Hong Kong 香港特別行政區	852 2833-1111
India	www.hp.com/support/india
Indonesia	+65 6100 6682
Ireland	01 605 0356
Italia	02 754 19 782
Japan 日本	81-3-6666-9925
Korea 한국	www.hp.com/support/korea
Magyarország	www.hp.com/support
Malaysia	+65 6100 6682
México	01-800-474-68368
Middle East International	www.hp.com/support
Netherland	020 654 5301
New Zealand	0800-551-664
Nicaragua	1-800-711-2884
Norwegen	23500027
Österreich	01 360 277 1203
Panamá	001-800-711-2884
Paraguay	(009) 800-541-0006
Perú	0-800-10111
Philippines	+65 6100 6682
Polska	www.hp.com/support
Portugal	021 318 0093

Table 12-1 Contact Information

Country/Region	Contact
Puerto Rico	1-877 232 0589
Russia Россия	495 228 3050
Schweiz (Deutsch)	01 439 5358
Singapore	6100 6682
South Africa	0800980410
South Korea 한국	2-561-2700
Suisse (français)	022 827 8780
Suomi	09 8171 0281
Sverige	08 5199 2065
Svizzera (italiano)	022 567 5308
Türkiye	www.hp.com/support
Taiwan 臺灣	+852 28052563
Thailand ไทย	+65 6100 6682
United Kingdom	0207 458 0161
United States	800-HP INVENT
Uruguay	0004-054-177
Venezuela	0-800-474-68368
Việt Nam	+65 6100 6682

Product Regulatory & Environment Information

Federal Communications Commission Notice

This equipment has been tested and found to comply with the limits for a Class B digital device, pursuant to Part 15 of the FCC Rules. These limits are designed to provide reasonable protection against harmful interference in a residential installation. This equipment generates, uses, and can radiate radio frequency energy and, if not installed and used in accordance with the instructions, may cause harmful interference to radio communications. However, there is no guarantee that interference will not occur in a particular installation. If this equipment does cause harmful interference to radio or television reception, which can be determined by turning the equipment off and on, the user is encouraged to try to correct the interference by one or more of the following measures:

- Reorient or relocate the receiving antenna.
- Increase the separation between the equipment and the receiver.
- Connect the equipment into an outlet on a circuit different from that to which the receiver is connected.
- Consult the dealer or an experienced radio or television technician for help.

Modifications

The FCC requires the user to be notified that any changes or modifications made to this device that are not expressly approved by Hewlett-Packard Company may void the user's authority to operate the equipment.

Declaration of Conformity for products Marked with FCC Logo, United States Only

This device complies with Part 15 of the FCC Rules. Operation is subject to the following two conditions: (1) this device may not cause harmful interference, and (2) this device must accept any interference received, including interference that may cause undesired operation.

If you have questions about the product that are not related to this declaration, write to

Hewlett-Packard Company
P.O. Box 692000, Mail Stop 530113
Houston, TX 77269-2000

For questions regarding this FCC declaration, write to

Hewlett-Packard Company
P.O. Box 692000, Mail Stop 510101
Houston, TX 77269-2000
or call HP at 281-514-3333

To identify your product, refer to the part, series, or model number located on the product.

Canadian Notice

This Class B digital apparatus meets all requirements of the Canadian Interference-Causing Equipment Regulations.

Avis Canadien

Cet appareil numérique de la classe B respecte toutes les exigences du Règlement sur le matériel brouilleur du Canada.



European Union Regulatory Notice

This product complies with the following EU Directives:

- Low Voltage Directive 2006/95/EC
- EMC Directive 2004/108/EC

Compliance with these directives implies conformity to applicable harmonized European standards (European Norms) which are listed on the EU Declaration of Conformity issued by Hewlett-Packard for this product or product family.

This compliance is indicated by the following conformity marking placed on the product:

 <p>This marking is valid for non-Telecom products and EU harmonized Telecom products (e.g. Bluetooth).</p>	 <p>This marking is valid for EU non-harmonized Telecom products . *Notified body number (used only if applicable - refer to the product label)</p>
--	---

Hewlett-Packard GmbH, HQ-TRE, Herrenberger Strasse 140, 71034 Boeblingen, Germany

Japanese Notice

この装置は、情報処理装置等電波障害自主規制協議会（VCCI）の基準に基づくクラス B 情報技術装置です。この装置は、家庭環境で使用することを目的としていますが、この装置がラジオやテレビジョン受信機に近接して使用されると、受信障害を引き起こすことがあります。

取扱説明書に従って正しい取り扱いをして下さい。

Perchlorate Material - special handling may apply

This calculator's Memory Backup battery may contain perchlorate and may require special handling when recycled or disposed in California.

Disposal of Waste Equipment by Users in Private Household in the European Union



This symbol on the product or on its packaging indicates that this product just not be disposed of with your other household waste. Instead, it is your responsibility to dispose of your waste equipment by handing it over to a designated collection point for the recycling of waste electrical and electronic equipment. The separate collection and recycling of your waste equipment at the time of disposal will help to conserve natural resources and ensure that it is recycled in a manner that protects human health and the environment. For more information about where you can drop off your waste equipment for recycling, please contact your local city office, your household waste disposal service or the shop where you purchased the product.

Chemical Substances

HP is committed to providing our customers with information about the chemical substances in our products as needed to comply with legal requirements such as REACH (*Regulation EC No 1907/2006 of the European Parliament and the Council*). A chemical information report for this product can be found at: <http://www.hp.com/go/reach>

产品中有毒有害物质或元素的名称及含量
根据中国《电子信息产品污染控制管理办法》

部件名称	有毒有害物质或元素					
	铅 (Pb)	汞 (Hg)	镉 (Cd)	六价铬 (Cr(VI))	多溴联苯 (PBB)	多溴二苯醚 (PBDE)
PCA	X	○	○	○	○	○
外觀殼子/字鍵	○	○	○	○	○	○

○：表示该有毒有害物质在该部件所有均质材料中的含量均在SJ/T11363-2006 标准规定的限量要求以下。

X：表示该有毒有害物质至少在该部件的某一均质材料中的含量超出SJ/T11363-2006 标准规定的限量要求。

表中标有“X”的所有部件都符合欧盟RoHS法规

“欧洲议会和欧盟理事会2003年1月27日关于电子电器设备中限制使用某些有害物质的2002/95/EC号指令”

注：环保使用期限的参考标识取决于产品正常工作的温度和湿度等条件

Index

!

!: key, 23

%

% change, 53

% yield, 47

=

=: key, 12

A

a: slope, 62

absolute value. See Math menu

Algebraic mode, 17

amortization: Amort key, 33; example, 34; menu items, 33

annual: bond, 47

annunciators, 11

ANS. See last number

B

b: y-intercept, 62

backspace key, 16

balance: amortization, 33

begin mode: Beg key, 32

bond: *annual*, *semiannual*, 10; example, 47; key, 46; menu items, 46

bonds, 46

bottom line: *display*, 8

break-even: BrkEv key, 51; example, 51

business problems, 53; percent calculation examples, 54

C

calculation mode: *Chain*, *Algebraic*, and *RPN*, 10

calendar: *Actual*, *Cal.360*, 10

call value, 47

Canada TVM example, 38

Canadian TVM, 36

cash flow: example, 40; keys, 40; sample diagrams, 45

cash flows, 39; analyzing, 42; editing, 44; number per year, 43

Chain mode, 17

Chi, 25

clearing. See: *Reset menu*

compounding periods: N key, 32

compounding periods per year: P/YR key, 32

Compounding, per year, 35

contents, 3

contrast, 7

correlation, 61, 62

cosine: COS key, 23

cost: depreciation, 58; fixed. See break-even; variable per unit. See break-even

coupon rate, 46

covariance, 61, 62

CshFl key. See cash flow

cursor, 7

D

Data key. See Statistics

data menu, 61

date: actual, 47; maturity, 46; settlement, 46

Date 1. See Date calculation

Date 2. See Date calculation

date calculation: Date key, 49; example, 49

date format, 9

days between. See Date calculation

decimal point, 9

decimal separator: *point or comma*, 9

default calculator screen, 8

degrees, 9

delete: DEL key, 44

delete key, 44

deleting. See *Reset menu*

depreciation, 56; Depr key, 56; example, 58; methods, 56

descriptive: sub menu. See Statistics menu

discounted payback, 43

display, 7; *two lines*, 8

down arrow key. See scroll

E

EEX key. See scientific notation

end mode: End key, 32

error messages, 65

F

factor: declining balance. See depreciation

factorial: ! key, 23

F-distribution, 25

Fix: display precision. See Mode menu

function: one-number, 22

functions: two-number, 26

future value: FV key, 32

I

IConv key. See interest conversion

INPUT: key, 12

insert: INS key, 44

interest: accrued. See bonds; towards loan payment. See amortization

interest conversion: example, 35

interest rate: effective, 35; nominal, 35; nominal, I/YR key, 32

inverse tail normal distribution, 25

IRR: key, 42

K

key: highlighting, 11; presses, 11; primary function, 11; secondary function, 11

keyboard map, 6

L

language: selection, 7

last number, 19; ANS key, 19

life. See depreciation

line: regression, 61

log: LN key. See Math menu

logarithmic functions, 23

lower tail normal distribution, 25

M

markup: as cost, 53; as price, 53

math: Math key, 23

math functions, 16

Math menu: Absolute value, 24; Hyperbolic, 24; Log, 24; Probability, 24; Trigonometry, 24

mean, 61

memory, 13; key, 13

menu: Amortization, 33; Bond, 46; Break-even, 51; Cash Flow, 39; Date Calculation, 49; Depreciation, 56; Interest Conversion, 35; IRR, 42; Math, 22; Memory, 13; Mode, 8; NPV, 42; Payment per year, 36; Percent Calculation, 53; Reset, 13; Statistics, 60; TVM, 30; TVM Canada, 36

menu item value: recalling, 28

menus: items, types of, 15; maps, 14; special, 13; sub-menus, opening, 14

mode menu: key, 7

N

N key, 32
 natural exponent: e to the power of x key, 23
 nCr, 27
 negative numbers, 16
 net future value, 43
 net present value, 43
 net uniform series, 43
 nPr, 27
 NPV: key, 42
 NPV, IRR: menu items, 43
 number entry, 16
 number period: compounding, 55
 number periods: amortization, 33
 numbers: rounding, 28; storing and recalling, 27

O

off: *calculator off*, 7
 Off: key, 7
 on: *calculator on*, 7
 On: key, 7

P

P/YR: key, 32
 parentheses: use in Chain mode, 17
 parentheses (swap and roll down): keys in RPN, 21
 payback, 43
 percent calculation: % calc key, 53
 percentage: % key, 28
 percentage of total, 53
 percentages: simple, 28
 periodic payment: PMT key, 32
 PI. See Math Menu
 population, 61
 power functions, 23
 Predictions: sub-menu. See Statistics
 present value: PV key, 32

price: break-even, 51; face value. See bonds; percent calculation, 54
 principal, 33
 probability, 25
 product: x and y values, 63
 profit, 51

Q

quantity: break-even, 52

R

radians, 9
 random function: RAND key, 23
 recall arithmetic, 28
 recalling numbers: RCL key, 27
 reciprocal: 1/x key, 23
 regression line, 61
 remaining book value, 58
 remaining depreciable value, 58
 Reset: key, 13
 roll down. See RPN
 rounding numbers: RND key, 23
 RPN: Reverse Polish Notation, 18
 RPN stack, 18

S

S.E. SamP.X and Y, 61
 salvage: depreciation, 58
 scientific notation: EEX key, 16
 scroll: up and down arrow keys, 8
 semiannual: bond, 47
 Sigma X,Y, 61
 sign: positive, negative key, 16
 sine: SIN key, 23
 slope, 61
 square of x: key, 23
 square root key, 23
 standard deviation, 61
 start: amortization period, 33
 start date: depreciation, 58

statistics: menu items, 62; one-variable, 61; one-variable weighted, 61; Stats key, 61; two-variable, 61
 statistics example, 63
 stats menu, 61
 storing numbers: STO key, 27
 student, 25
 sums: sub-menu. See Statistics
 swap. See RPN
 symbol: *battery*, 7

T

tangent: TAN key, 23
 thousands separator, 9
 time value of money: keys, 32
 top line: *display*, 8
 total: cash flows, 43
 TVM: example, 32; storing and recalling numbers, 28

U

up arrow key. See scroll

X

x: Sigma, 62; square of Sigma x, 63; times payment per year, xP/YR key, 32
 x mean, 62
 x mean sample, 62
 x population Std. Dev., 62
 x prediction, 62
 x standard deviation, 62

Y

y: Sigma, 63; square of Sigma y, 63
 y mean, 62
 y mean sample, 62
 y population Std. Dev., 62
 y prediction, 62
 y standard deviation, 62
 y to the x power, 23
 y-intercept, 61

Free Manuals Download Website

<http://myh66.com>

<http://usermanuals.us>

<http://www.somanuals.com>

<http://www.4manuals.cc>

<http://www.manual-lib.com>

<http://www.404manual.com>

<http://www.luxmanual.com>

<http://aubethermostatmanual.com>

Golf course search by state

<http://golfingnear.com>

Email search by domain

<http://emailbydomain.com>

Auto manuals search

<http://auto.somanuals.com>

TV manuals search

<http://tv.somanuals.com>