

Overview

Hewlett Packard's MSA P2000 Family of storage arrays features P2000 G3 arrays with the latest 8 Gb Fibre Channel, 6 Gb SAS, 10GbE iSCSI connected models, and an iSCSI model with four 1 Gb iSCSI ports per controller. The arrays are designed for entry-level customers and feature the latest in functionality and host-connect technology while offering excellent price/performance. They are ideal for companies with small budgets or limited IT expertise, and also larger companies with departmental or remote requirements. Each solution is designed to be easy to deploy, to be secure, along with low management costs, while driving rapid return on investment through efficient storage consolidation.

The MSA P2000 G3 arrays are 2U storage area network (SAN) or direct connect solutions (OS and protocol dependent) offering a choice of five controllers - two FC, one SAS, one 10GbE iSCSI and the newest model features a four port 1 Gb iSCSI. The first Fibre Channel controller is a high-performance, 8 Gb dual port model. The second offering is a unique dual-purpose Combo controller with two 8 Gb Fibre Channel ports with the addition of two 1GbE iSCSI ports. The third controller choice is 6Gb SAS with four ports per controller. There is also the addition of a two port 10 Gb iSCSI, while the latest controller introduction features four 1 Gb iSCSI ports per controller. Whatever the situation calls for, the P2000 G3 line-up has the right solution.

The dual-protocol MSA P2000 G3 MSA FC/iSCSI Combo Controller gives exceptional flexibility. The 8 Gb FC ports support a full FC SAN while the two 1GbE iSCSI ports can serve two purposes. With this combination you can economically share the array storage resource with a smaller department accessing it over iSCSI or enable the new optional Remote Snap functionality over iSCSI protocol (also available over FC).

The MSA P2000 G3 SAS is the follow-on product to the MSA2000sa G2, adding the latest 6 Gb SAS technology to the four host ports per controller. The P2000 G3 SAS array is designed for directly attaching up to four dual-path or eight single path rack servers. SAS array support for BladeSystems utilizes the HP 6 Gb SAS BL Switch.

The MSA P2000 G3 10GbE iSCSI brings the very latest in high-performance host connection with technology generally found only in higher priced arrays. The bandwidth it provides in conjunction with server consolidation is highly advantageous in shared storage configurations. Array connection to 10GbE switches that are in turn connected to 1GbE NICs is commonplace. Directly attached server support requires the server units to have 10GbE NICs.

Rounding out the controller choices is the MSA P2000 G3 iSCSI controller featuring four 1Gb iSCSI Ethernet ports, double the number of the G2 model. This allows an array that keeps the price of the components, particularly the interconnects, low while markedly increasing the performance capabilities.

All MSA P2000 G3 models can be equipped with single or dual controllers, feature the same scalability, and offer 6 Gb SAS back-end transmission speed to drives and JBODs. Significant data protection advances are delivered by the all P2000 G3 arrays. All G3 units come STANDARD with sixty-four snapshot capability at no extra cost and there is an option for the G3 series of five hundred and twelve snapshots. Volume Copy (clone) also comes standard. In a further move to protect the user's data, optional Remote Snap (replication) capability is offered on the FC, FC/iSCSI, and both iSCSI versions.

All MSA P2000 G3 models support hot plug replacement of redundant controllers, fans, power supplies, and I/O modules. Hot add of expansion enclosures is also supported.

The controller-less MSA P2000 chassis is offered in two models - one comes standard with twelve Large Form Factor (LFF) 3.5-inch drive bays, the other can accommodate twenty-four Small Form Factor (SFF) 2.5-inch drives. Both are able to simultaneously support enterprise-class SAS drives, SAS Midline, and archival-class SATA Midline drives. Either chassis can have one or two matching P2000 G3 controllers (same protocol) and are available with AC or DC power Supplies.

The HP modular approach to entry level SAN solutions enables incremental customer purchases, allowing the array to grow as needs grow, thus allowing a maximum return on investment. Choose a single controller unit for low initial cost with the ability to upgrade later; or decide on a model with dual controllers for the most demanding entry-level situations. There are no unexpected additional charges, licenses or fees as you add enclosures or hosts and users.

Overview

Capacity can easily be added as the need develops by attaching additional drive enclosures. Maximum capacity ranges with LFF drives up to 57.6 TB SAS, 384 TB SAS Midline or 192 TB SATA Midline with the addition of the maximum number of drive enclosures. Configurations utilizing the SFF drive chassis and the maximum number of drive enclosures can grow to 178 TB of SAS, 149 TB of SAS Midline or 74.5 TB SATA Midline with a total of 96 LFF or 149 SFF drives. The P2000 G3 Arrays do not support SSDs.

What's New in the P2000 G3 array family

- Introducing support for the HP MSA 1.2TB 6G SAS 10K ENT HDD

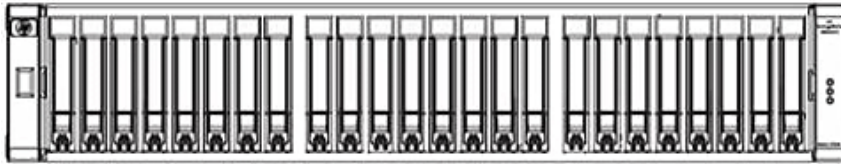

HP P2000 G3 SFF Modular Smart Array

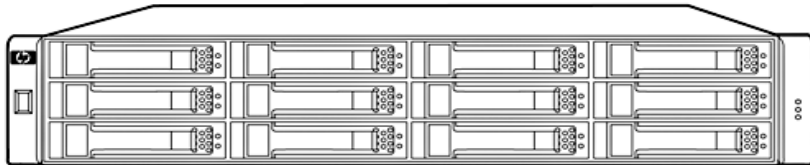

HP P2000 G3 LFF Modular Smart Array

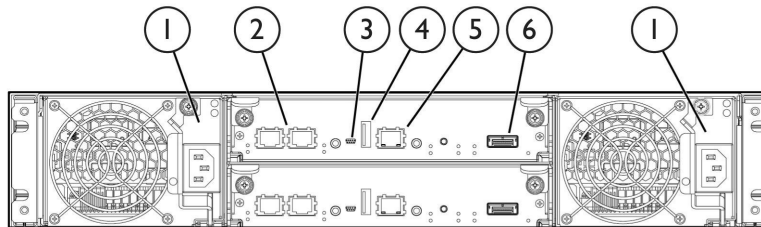

P2000 G3 FC Controllers, 2 installed

- | | |
|-----------------------------|-----------------------------|
| 1. Power supplies | 4. Reserved for future use |
| 2. 8 Gb Fibre Channel ports | 5. Management Ethernet port |
| 3. CLI port (mini-USB) | 6. Expansion port |

Overview

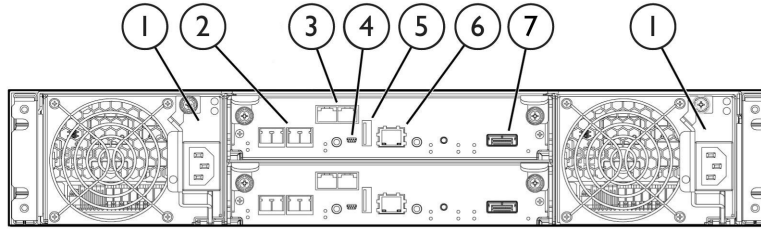

P2000 G3 FC/iSCSI Combo Controllers, 2 installed

- | | |
|-----------------------------|-----------------------------|
| 1. Power supplies | 5. Reserved for future use |
| 2. 8 Gb Fibre Channel ports | 6. Management Ethernet port |
| 3. 1GbE iSCSI ports | 7. Expansion port |
| 4. CLI port (mini-USB) | |

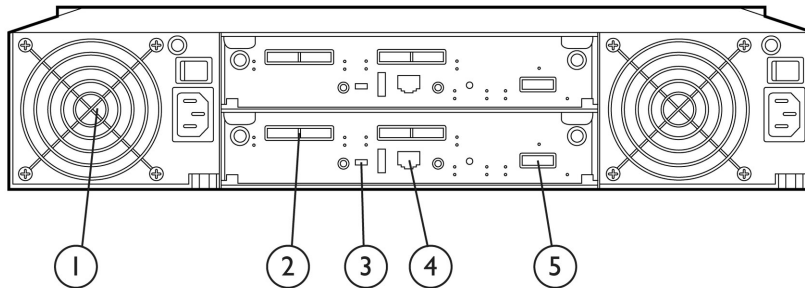

P2000 G3 SAS controllers, 2 installed

- | | |
|--|-----------------------------|
| 1. Power supplies | 4. Management Ethernet port |
| 2. 6Gb SAS ports (four per controller) | 5. Expansion port |
| 3. CLI port (mini-USB) | |

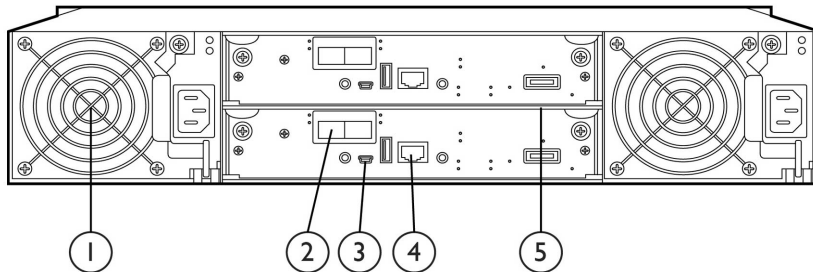

P2000 G3 10GbE iSCSI controllers, 2 installed

- | | |
|------------------------|-----------------------------|
| 1. Power supplies | 4. Management Ethernet port |
| 2. 10GbE iSCSI ports | 5. Expansion port |
| 3. CLI port (mini-USB) | |

Overview

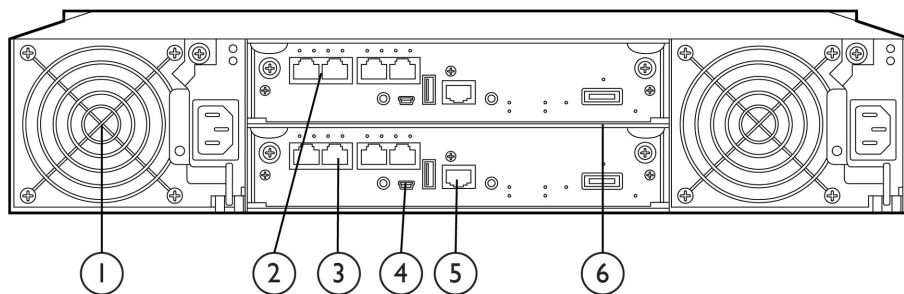

P2000 G3 iSCSI dual controller

- | | |
|--------------------------|-----------------------------|
| 1. Power supplies | 4. CLI port (mini-USB) |
| 2. 1 GbE iSCSI ports (4) | 5. Management Ethernet port |
| 3. 1 GbE iSCSI ports (4) | 6. Expansion port |

Models

P2000 G3 Modular Smart Array

P2000 G3 Controllers

P2000 G3 Fibre Channel Controllers

HP P2000 G3 MSA Fibre Channel Controller AP836B

NOTE: two 8Gb FC ports per controller

HP P2000 G3 MSA FC/iSCSI Combo Modular Smart Array Controller AP837B

NOTE: two 8Gb FC ports and two 1GbE iSCSI ports per controller

P2000 G3 SAS Controller

HP P2000 G3 SAS MSA Array System Controller AW592B

NOTE: four 6Gb SAS ports per controller

P2000 G3 10GbE iSCSI controller

HP P2000 G3 10GbE iSCSI MSA Array System Controller AW595B

NOTE: two 10GbE iSCSI ports per controller

P2000 G3 iSCSI controller (1Gb Ethernet)

HP P2000 G3 iSCSI MSA Array System Controller BK829B

NOTE: four 1Gb iSCSI ports per controller

P2000 Chassis

P2000 Controller-less Chassis (AC-powered)

HP P2000 LFF Modular Smart Array Chassis AP838B

NOTE: Will accept one or two controllers or Disk Enclosure I/O modules

HP P2000 SFF Modular Smart Array Chassis AP839B

NOTE: Will accept one or two controllers, not I/O modules

P2000 G3 Configured Array Systems

Configured Units, 8 Gb Fibre Channel Systems

HP P2000 G3 MSA FC Dual Controller LFF Modular Smart Array System AP845B

HP P2000 G3 MSA FC Dual Controller SFF Modular Smart Array System AP846B

HP P2000 G3 MSA FC/iSCSI Dual Combo Controller LFF Array AW567B

HP P2000 G3 MSA FC/iSCSI Dual Combo Controller SFF Array AW568B

Configured Units, 6 Gb SAS Systems

HP P2000 G3 SAS MSA Dual Controller LFF Array System AW593B

HP P2000 G3 SAS MSA Dual Controller SFF Array System AW594B

Configured Units, 10GbE iSCSI Systems

HP P2000 G3 10GbE iSCSI MSA Dual Controller LFF Array System AW596B

HP P2000 G3 10GbE iSCSI MSA Dual Controller SFF Array System AW597B

Configured Units, 1Gb iSCSI Systems

HP P2000 G3 iSCSI MSA Dual Controller LFF Array System BK830B

HP P2000 G3 iSCSI MSA Dual Controller SFF Array System BK831B

P2000 G3 FC SAN Starter Kits

HP P2000 G3 FC MSA Dual Controller Small Business SAN Starter Kit AP847B

Models

includes (1) HP P2000G3 MSA FC Dual Controller LFF Array (AP845B) , (2) HP SN6000 12port Single Power FC Switch (BK780B) , (4) HP 81Q PCI-e FC Single Port HBA (AK344A), (12) 8Gb Short Wave FC SFPs (AJ718A) , and (8) HP 5M OM3 FC Cables (AJ836A) .

HP P2000 G3 FC MSA Dual Controller Virtualization SAN Starter Kit AP848B

(includes (1) HP P2000G3 MSA FC Dual Controller SFF Array (AP846B) , (2) HP 8/24 Base 16 Ports Enabled SAN Switch (AM868B) , (6) HP 81B PCI-e 8Gb FC Single Port HBA (AP769A), (16) 8Gb Short Wave B Series FC SFPs (AJ716B) , and (10) HP 5M OM3 FC Cables (AJ836A)

Disk Enclosures

HP P2000 Dual I/O LFF Drive Enclosure AP843B

HP P2000 LFF Drive Enclosure I/O Module AP844B

HP D2700 Disk Enclosure AJ941A

Controller-less Chassis (DC-powered)

HP P2000 DC-power LFF Chassis AP840B

(can add one or two P2000 G3 controllers or P2000 JBOD I/O modules)

HP P2000 DC-power SFF Chassis AP841B

Smart Buys

HP P2000 G3 FC/iSCSI DC LFF Array/Smart-Buy- Americas BK748SB

Includes: (1) HP P2000 G3 MSA FC/iSCSI DC LFF Array
(6) HP P2000 450GB 6G SAS 15K 3.5in DP HDD

HP P2000 G3 FC/iSCSI DC SFF Array/Smart-Buy- Americas BK749SB

Includes: (1) HP P2000 G3 MSA FC/iSCSI DC SFF Array
(6) HP 300GB 6G SAS 10K 2.5 inch DP ENT HDD

HP P2000 G3 FC DC LFF Array/S-Buy- Americas BK746SB

Includes: (1) HP P2000 G3 MSA FC Dual Controller LFF Array
(6) HP P2000 450GB 6G SAS 15K 3.5in DP HDD

HP P2000 G3 FC DC SFF Array/S-Buy- Americas BK747SB

Includes: (1) HP P2000 G3 MSA FC Dual Controller SFF Array
(6) HP 300GB 6G SAS 10K 2.5 inch DP ENT HDD

HP P2000fc w/24 300GB 6GSAS-7.2TB Bundle- Americas BK816A

Includes: (1) HP P2000 G3 FC/iSCSI Dual Controller SFF MSA Array
(24) HP 300GB 6G SAS 10K 2.5in DP ENT HDD

P2000 G3 Array Bundles

In some areas HP is offering P2000 G3 Array bundles with SFF SAS drives. These bundles can simplify the process of ordering. HP offers these bundles with different type of P2000 G3 Array controllers for different storage capacity needs.

NOTE: These bundles are not offered worldwide so please check the availability for your region

Protocol	Raw Capacity	Regions Availability	Bundle Description	SKUs
Fully Populated Bundles:				
FC Bundles	3.5 TB	AMS APJ	HP P2000 G3 FC DC w/24 146GB SAS 15K SFF HDD 3.5TB Bundle	BV901B

Models

	7.2 TB	AMS APJ	HP P2000 G3 FC DC w/24 300GB SAS 10K SFF HDD 7.2TB Bundle	BV902B
	14.4 TB	AMS APJ	HP P2000 G3 FC DC w/24 600GB SAS 10K SFF HDD 14.4TB Bundle	BV903B
	21.6 TB	AMS APJ	HP P2000 G3 FC 24x900GB SAS SFF Bundle	QR517B
	24 TB	AMS APJ	HP P2000 G3 FC 24x1TB SAS SFF Bundle	QR521B
	7.2 TB AMS	AMS APJ	HP P2000 G3 FC DC w/24 300GB SAS 15K SFF HDD 7.2TB Bundle	QW945B
FC/iSCSI Combo Bundles	21.6 TB	AMS APJ	HP P2000 G3 FC/iSCSI MSA DC w/24 900GB SAS 10K SFF HDD 21.6TB Bundle	QR518B
	24 TB	AMS APJ	HP P2000 G3 FC/iSCSI MSA DC w/24 1TB SAS 7.2K SFF MDL HDD 24TB Bundle	QR522B
SAS Bundles	7.2 TB	AMS APJ	HP P2000 SAS DC w/24 300GB SAS 10K SFF HDD 7.2TB Bundle	BV908B
	14.4 TB	AMS APJ	HP P2000 SAS DC w/24 600GB SAS 10K SFF HDD 14.4TB Bundle	BV909B
	21.6 TB	AMS APJ	HP P2000 G3 SAS MSA DC w/24 900GB SAS 10K SFF HDD 21.6TB Bundle	QR519B
	24 TB	AMS APJ	HP P2000 G3 SAS MSA DC w/24 1TB SAS 7.2K SFF MDL HDD 24TB Bundle	QR523A
1G iSCSI Bundles	7.2 TB	AMS APJ	HP P2000 G3 iSCSI DC w/24 300GB SAS 10K SFF HDD 7.2TB Bundle	BV911B
	21.6 TB	AMS APJ	HP P2000 G3 iSCSI MSA DC w/24 900GB SAS 10K SFF HDD 21.6TB Bundle	QR520B
	24 TB	AMS APJ	HP P2000 G3 iSCSI MSA DC w/24 1TB SAS 7.2K SFF MDL HDD 24TB Bundle	QR524B
Half Populated Bundles:				
FC Bundles	3.6 TB	AMS APJ	HP P2000 G3 FC DC w/12 300GB SAS 10K SFF HDD 3.6TB Bundle	BV913B
	7.2 TB	AMS APJ EMEA	HP P2000 G3 FC DC w/12 600GB SAS 10K SFF HDD 7.2TB Bundle	BV914B
	10.8 TB	AMS APJ	HP P2000 G3 FC MSA DC w/12 900GB SAS 10K SFF HDD 10.8TB Bundle	QR525B
	12 TB	AMS APJ	HP P2000 G3 FC MSA DC w/12 1TB SAS 7.2K SFF MDL HDD 12TB Bundle	QR529B

Models

	3.6 TB	AMS APJ	HP P2000 G3 FC DC w/12 300GB SAS 15K SFF HDD 3.6TB Bundle	QW949B
FC/iSCSI Combo Bundles	10.8 TB	AMS APJ	HP P2000 G3 FC/iSCSI MSA DC w/12 900GB SAS 10K SFF HDD 10.8TB Bundle	QR526B
	12 TB	AMS APJ	HP P2000 G3 FC/iSCSI MSA DC w/12 1TB SAS 7.2K SFF MDL HDD 12TB Bundle	QR530B
SAS Bundles	3.6 TB	AMS APJ	HP P2000 G3 SAS DC w/12 300GB SAS 10K SFF HDD 3.6TB Bundle	BV917B
	7.2 TB	AMS APJ	HP P2000 G3 SAS DC w/12 600GB SAS 10K SFF HDD 7.2TB Bundle	BV918B
	10.8 TB	AMS APJ	HP P2000 G3 SAS MSA DC w/12 900GB SAS 10K SFF HDD 10.8TB Bundle	QR527B
	12 TB	AMS APJ	HP P2000 G3 SAS MSA DC w/12 1TB SAS 7.2K SFF MDL HDD 12TB Bundle	QR531B
	3.6 TB	AMS APJ	HP P2000 G3 SAS DC w/12 300GB SAS 15K SFF HDD 3.6TB Bundle	QW951B
1G iSCSI G3 Bundles	3.6 TB	AMS APJ	HP P2000 G3 iSCSI DC w/12 300GB SAS 10K SFF HDD 3.6TB Bundle	BV919B
	7.2 TB	AMS APJ	HP P2000 G3 iSCSI DC w/12 600GB SAS 10K SFF HDD 7.2TB Bundle	BV920B
	10.8 TB	AMS APJ	HP P2000 G3 iSCSI MSA DC w/12 900GB SAS 10K SFF HDD 10.8TB Bundle	QR528B
	12 TB	AMS APJ	HP P2000 G3 iSCSI MSA DC w/12 1TB SAS 7.2K SFF MDL HDD 12TB Bundle	QR532B
	3.6 TB	AMS APJ EMEA	HP P2000 G3 iSCSI DC w/12 300GB SAS 15K SFF HDD 3.6TB Bundle	QW952B

Features

Key Features

The HP P2000 G3 Modular Smart Array family encompasses five controllers, each featuring different protocols or combination of protocols to match the exact needs of the user.

- P2000 G3 FC/iSCSI Combo MSA controller: this unique controller offers both 8 Gb Fibre Channel and 1 GbE iSCSI functionalities built into a single array controller. This allows customers to enable storage needing high performance thru the FC ports while leveraging their SAN investment by sharing the array resources with smaller departments through low-cost iSCSI. It also enables optional Remote Snap (replication) for data protection.
- P2000 G3 FC MSA controller: Dual 8 Gb Fibre Channel host ports per controller give high performance with a mature topology and is compatible with the largest installed base of SAN users.
- P2000 G3 10GbE iSCSI MSA controller: HP was the first of the major modular array manufacturers that brought a high performance dual-ported 10GbE iSCSI solution to the entry level segment. Ideal for those who want to utilize cost-effective Ethernet as their infrastructure without sacrificing access time to their data. Now supports Remote Snap (replication).
- P2000 G3 SAS MSA controller: the P2000 G3 SAS model gives fast 6 Gb transmission rates with low cost SAS connections. Four host ports per controller support a highly efficient direct connect configuration.
- P2000 G3 iSCSI MSA controller offers four 1 Gb iSCSI ports utilizes the popular Ethernet infrastructure with its low cost and ease of management, while the additional ports assure increased performance over the previous generation. Now supports Remote Snap (replication).

All P2000 G3 models offer a common set of valuable features:

- Ease of management featuring browser-based out-of-band access. This allows a department or small company to effectively handle growing storage requirements, with the aid of an intuitive GUI to administer the unit with a minimum of complexity. Ideal for local or remote installations.
- All G3 models come standard with 64 controller-based snapshots and clone capability. The G3 arrays also support an optional 512 snaps.
- Choose either a low-cost single controller array or start with a configured dual controller array model to fit the budget, high availability, and performance needs.
- All models feature a wide variety of drives: enterprise-class SAS, SAS Midline, and archival-class SATA Midline in either P2000 LFF 3.5-inch or HP Storage SFF 2.5-inch drives.
- P2000 G3 models can have a maximum number of P2000 LFF drive enclosures (7), a maximum number of D2700 SFF enclosures (5), or mix both sizes. The array can grow incrementally from a few drives to 178 TB SAS, 384 TB of SAS MDL or 192 TB SATA MDL.
- 2 GB transportable read/write cache per controller. Battery-free cache backup with super capacitors and compact flash
- Vdisks can be spanned across multiple enclosures
RAID levels 0, 1, 3, 5, 6, 10, 50
- Maximums vary by RAID levels: 2 drive max for RAID level 1; max of 16 drives for RAID levels 0, 3, 5, 6, and 10; max of 32 drives for RAID level 50
- 512 LUNs with LUN sizes greater than 40TB depending on the RAID configuration chosen. The maximum LUN size is 64TB
- Non-disruptive on-line controller code upgrade (requires dual controllers w/ multi-pathing software)
- Upgradable by design. Owners of an original MSA2000 G1 or G2 array are able to do data-in-place controller upgrades to the P2000 G3 FC, Combo FC/iSCSI, 1 Gb or 10GbE iSCSI, or P2000 G3 SAS. Cross protocol upgrades are also supported between the protocols. This unique ability protects the earlier investments in chassis, drives, and JBODs

Follow us on twitter and be a part of the conversation, and get the latest P2000 G3/MSA related news and information at:

<http://www.twitter.com/MSAstorage>

HP P2000 G3 FC MSA SAN Starter Kits



Features

The new P2000 G3 FC MSA SAN Starter kits are offered to simplify ordering and implementation of your SAN. HP includes all the necessary hardware components to build your own SAN solution in one package, just add the drives of your choice. These kits are offered at very affordable prices which reflect a savings over purchasing each SAN component separately.

Virtualization SAN Starter Kit HP P2000 G3 FC MSA Dual Controller Virtualization SAN Starter Kit AP848B

The HP P2000 G3 FC MSA Dual Controller Virtualization SAN Starter Kit addresses the growing need for server and storage administrators to deliver end-to-end storage, virtualization, and management capabilities across their network infrastructure. The hardware bundle consists of six Host Bus Adapters (HBAs), two FC switches, a P2000 G3 FC MSA Dual Controller Array (SFF Chassis), sixteen 8Gb FC SFPs, ten HP 5M FC cables as well as two licenses per switch enabling Server Application Optimization (SAO) and Adaptive Networking (AN). SAO is an adapter technology that offers Quality of Service (QoS) capabilities that can be used in conjunction with fabric wide QoS and to enable a high performing, virtualized infrastructure. With SAO deployed, administrators can protect a VM and its application by assigning its IO flow to a specific priority level. The QoS priorities are enforced at the hardware level, thereby providing adequate bandwidth during periods of high congestion. Applications such as email and databases achieve better performance when deployed in specific SAO and MSA configurations.

Small Business SAN Starter Kit HP P2000 G3 FC MSA Dual Controller Small Business SAN Starter Kit AP847B

The HP P2000 G3 FC MSA Dual Controller Small Business SAN Starter Kit is a unique end-to-end 8 Gbps SAN Solution, just add disks and power. This kit includes one 8 Gbps P2000 G3 FC MSA Dual Controller Array (LFF Chassis), four 8 Gbps FC HBAs, two HP SN6000 Stackable 8 Gbps 8-port FC switches, twelve 8Gb FC SFPs, eight HP 5M FC cables and HP unique Simple SAN Connection Manager (SSCM) SAN management software, cables, rails and optics. SSCM is the only SAN management software that can manage the FC switch, HBA and provision HP storage from a single pane of glass.

Application Solutions

The HP P2000 SAN is the ideal solution for customers running Oracle, Microsoft, SAP environments and those customers who are deploying virtual server technologies like VMware, Hyper-V, and Oracle Virtual Machine. The HP P2000 SAN delivers enterprise functionality that enhances virtual environments, simplifies management, and reduces costs. Easy to deploy, scale and maintain, HP P2000 SANs ensure that crucial business data remains available.

HP has developed best-in-class expertise in Oracle, Microsoft, SAP, and Virtualization Hypervisor technology through extensive testing with the HP P2000 SAN, HP servers, and management software; high availability and disaster recovery solutions; and backup and recovery on the Oracle, Microsoft, and SAP application platforms. As a result, our customers can expect a wide range of operational and business benefits where they can:

- Deploy IT assets across multiple locations.
- Incrementally grow storage without interruption.
- Enable high availability and disaster recovery capabilities for critical applications.
- Deploy a remote disaster recovery site.

Learn more

To learn more about specific HP Storage Solutions that are built with Oracle, Microsoft, SAP and Virtualization environments in mind, visit the solution sites supporting each of these applications.

HP Storage for Oracle hyperlink to: <http://www.hp.com/storage/oracle>

HP Storage for Microsoft hyperlink to: <http://www.hp.com/storage/microsoft>

HP Storage for SAP hyperlink to: <http://www.hp.com/storage/sap>

HP Storage for VMware hyperlink to: <http://www.hp.com/go/vmware/storage>

Family Information

	P2000 G3 FC	P2000 G3 SAS	P2000 G3 10GbE iSCSI	P2000 G3 iSCSI (1GbE)
Capacity Minimum / with maximum additional drive enclosures	LFF: 7.2 TB SAS or 48 TB SAS MDL or 24 TB SATA MDL w/ 7 LFF enclosures: 57.6 TB SAS, 384 TB SAS MDL or 192 TB SATA SFF: 28 TB SAS or 24 TB SAS MDL or 12 TB SATA MDL w/ 5 D2700 JBODs: 178 TB SAS or 149 TB SAS MDL or 74.5 TB SATA MDL	LFF: 7.2 TB SAS or 48 TB SAS MDL or 24 TB SATA MDL w/ 7 LFF enclosures: 57.6 TB SAS, 384 TB SAS MDL or 192 TB SATA SFF: 28 TB SAS or 24 TB SAS MDL or 12 TB SATA MDL w/ 5 D2700 JBODs: 178 TB SAS or 149 TB SAS MDL or 74.5 TB SATA MDL	LFF: 7.2 TB SAS or 48 TB SAS MDL or 24 TB SATA MDL w/ 7 LFF enclosures: 57.6 TB SAS, 384 TB SAS MDL or 192 TB SATA SFF: 28 TB SAS or 24 TB SAS MDL or 12 TB SATA MDL w/ 5 D2700 JBODs: 178 TB SAS or 149 TB SAS MDL or 74.5 TB SATA MDL	LFF: 7.2 TB SAS or 48 TB SAS MDL or 24 TB SATA MDL w/ 7 LFF enclosures: 57.6 TB SAS, 384 TB SAS MDL or 192 TB SATA SFF: 28 TB SAS or 24 TB SAS MDL or 12 TB SATA MDL w/ 5 D2700 JBODs: 178 TB SAS or 149 TB SAS MDL or 74.5 TB SATA MDL
Controller Cache	2 GB per controller	2 GB per controller	2 GB per controller	2 GB per controller
Total LUNs LUN sizes greater than 40TB depending on the RAID configuration chosen	512 maximum LUN size: 64TB	512 maximum LUN size: 64TB	512 maximum LUN size: 64TB	512 maximum LUN size: 64TB
Host connect P2000 & MSA2000 have 1 or 2 controllers, EVA has 2 controllers standard	Two 8 Gb Fibre Channel ports or Two 8Gb FC and two 1GbE iSCSI ports per controller	Four 6 Gb (x4) SAS ports per controller	Two 10 GbE iSCSI ports per controller	Four 1 Gb iSCSI ports per controller
Maximum Drives w/ expansion	96 LFF/149 SFF	96 LFF/149 SFF	96 LFF/149 SFF	96 LFF/149 SFF
Maximum host supported (dual controller)	64	64 w/ SAS switch: 32 single blade servers (2x c7000), or 16 dual density blade servers	64	64
Optional software: Snapshot, clone, Remote Snap	Snapshot, 64 standard (max 512) Clone (standard) Remote Snap (optional)	Snapshot, 64 standard (max 512) Clone (standard)	Snapshot, 64 standard (max 512) Clone (standard) Remote Snap (optional)	Snapshot, 64 standard (max 512) Clone (standard) Remote Snap (optional)
Use for Storage	Primary Storage with SAS drives. Secondary with SATA	Primary Storage with SAS drives. Secondary with SATA	Primary Storage with SAS drives. Secondary with SATA	Primary Storage with SAS drives. Secondary with SATA

NOTE: maximum available storage capacity depends on the RAID level being implemented

Product Technology



Family Information

8Gb Fibre Channel controller Two host ports per FC controller shipped with SFPs. The P2000 G3 FC controller can run in either point-to-point or FCAL (loop). The default is FCAL which is used in Direct Connect, particularly with two controllers. The PtP (fabric) mode is used with almost all switches.

Combo controller with FC and iSCSI ports This ingenious dual-protocol "combo" controller supports a full FC SAN through the 8Gb FC ports, while designating the two 1 GbE iSCSI ports to enable remote replication over iSCSI protocol and perform as an iSCSI target. This allows economical sharing of the storage resource (the P2000 G3 array) with one department needing the performance afforded by the 8 Gb FC ports while simultaneously supporting another department with lesser performance needs and a budget only allowing a 1GbE iSCSI network.

6Gb SAS controller Four 4x host ports per 6Gb SAS controller.

10GbE iSCSI controller Two 10GbE ports per G3 10GbE iSCSI controller. Ports are ready for the choice of SFP (none included) Supports the ProCurve and ISS versions of the following 10GbE parts for use in the controllers:

HP 10Gb Cables

- HP SFP+ 10GbE Copper Cable
- HP ProCurve 10-GbE SFP+-SFP+ Direct Attach Cable

HP SFP+ Transceivers

- HP BladeSystem 10Gb SR SFP+ and HP BladeSystem 10Gb LRM SFP+
- HP ProCurve 10-GbE SFP+ SR Transceiver and HP ProCurve 10-GbE SFP+ LRM Transceiver
- No SFP+ LR Transceiver support

1 Gb iSCSI controller Four 1 Gb Ethernet iSCSI ports per G3 iSCSI controller

Modular Chassis 2U rack height. 12 Large Form Factor or 24 Small Form Factor drive bays, accommodating SAS and SATA. Comes with space for one or two controllers, or P2000 3.5-inch disk Enclosure I/O modules (LFF chassis only)

Drives available The P2000 G3 controllers support both the P2000 3.5-inch Large Form Factor (LFF) drives, and the HP Storage 2.5-inch Small Form Factor (SFF) drives.

- Serial Attached SCSI (SAS) enterprise-class drives are designed for high demand, 24x7 usage.
- SAS Midline and SATA Midline are usually reserved for archival of data as they are both relatively inexpensive and are available in very large capacities.

The HP entry-level family of arrays can accommodate both SAS and SATA drives within the same enclosure making it ideal to have both business-critical, high activity files on SAS drives while using Snapshot, clone, or Remote Snap capability to keep back-up or archival data on the less expensive drives.

For investment protection, the controllers will support single and dual port SAS & SATA drives in a legacy single - or dual - domain MSA70. This support allows current owners of MSA70s to migrate their single port drives (in their MSA70 only, not into the array head) to be attached to a P2000 G3 FC or SAS. They can only cascade to another single I/O MSA70. This is not a data-in-place transition, and overall performance could be impacted.

SAS drive performance can be approximately 30% greater than SATA performance on sequential host I/O. SAS performance excels in sequential lower latency response time and random I/O per second transaction performance due to higher rpm disk speeds yielding lower seek times. SAS drive random performance is generally twice that of SATA drives.

NOTE: P2000 and MSA2 3.5-inch Large Form Factor (LFF) drives are for use only in the P2000 G3 or

Family Information

MSA2000 models. The 2.5-inch Small Form Factor (SFF) drives are supported only with the P2000 G3 or the MSA2300 G2 controllers and are Storage hot-plug 2.5-inch drives.

Optional Disk enclosures Just as the user has a choice of chassis for the array head (LFF and SFF drive bays, AC or DC powered), so also do they have a choice of expansion disk enclosures accommodating either drive size. Both the P2000 and the D2700 disk enclosures can be hot-added to an operating array.

(NOTE: these are not supported as part of a NEBS-certified configuration with the MSA Carrier Grade Chassis. There is a certified JBOD listed in the Carrier-grade section)

P2000 3.5-inch drive enclosure. This 2U storage enclosure (AJ941A) is designed to support twenty five Storage 2.5-inch Universal form factor (SFF) 6Gb SAS or SATA hard drives. It ships standard with dual I/O modules installed.

- This 3.5-inch drive enclosure can be attached to either the P2000 G3 FC or SAS LFF or SFF array head.
- Each configured model ships standard with two .5m mini-SAS to mini-SAS cables for cascading to other P2000 drive enclosures
- Up to seven P2000 3.5-inch enclosures can be attached to a P2000 G3 FC, FC/iSCSI Combo, or SAS controller in the array head.

D2700 2.5-inch drive enclosure. This 2U storage enclosure (AJ941A) is designed to support twenty five ProLiant 2.5-inch Universal form factor (SFF) 6Gb SAS or SATA hard drives. It ships standard with dual I/O modules installed.

- This 2.5-inch drive enclosure can be attached to a P2000 G3 controller (SFF or LFF) array head
- The D2700 enclosure ships with a two .5m miniSAS to miniSAS cable.
- Up to five D2700 may be attached to the P2000 G3 array head, given total support for 149 SFF drives.

Scalability

The P2000 G3 FC, Combo FC/iSCSI, SAS, 1 Gb or 10GbE iSCSI controllers are designed to allow an installation to begin with smaller capacity and be able to grow gradually as needed. The flexibility of SAS or SATA drive technology, form factors, sizes, speeds, and costs per GB allows a system to easily fit in almost any budget.

- Large Form Factor configurations can scale up to 7.2 TB SAS, 36TB SAS MDL or 24 TB SATA, expandable to 57.6 TB SAS, 384 TB SAS MDL or 192 TB SATA with the addition of a maximum of seven P2000 3.5-inch Drive Enclosures.
- Small Form Factor configurations can scale from 21.6 TB SAS, 24 TB SAS MDL or 12 TB SATA MDL. With the addition of five D2700 JBODs, the P2000 G3 can support 134 TB SAS, 149 TB SAS MDL or 74.5 TB SATA MDL.
- Users may configure a 24-drive P2000 G3 SFF array head with 12-drive LFF P2000 3.5-inch disk enclosures. This is an excellent method for a configuration that supports fast SFF enterprise-class SAS drives in the array head, combined with economical LFF drives staged for archival purposes, all in the same array.
- Qualification of larger capacity drives is ongoing.

Vdisks

Vdisks can span across multiple enclosures, where drives used in the Vdisk can be contained in different enclosures. The maximum number of drives that can be used in RAID 1 Vdisk is 2; RAID 0, 3, 5, 6, and 10 is 16; and for RAID 50 Vdisk is 32.

LUNs

The HP 2000 family of arrays supports 512 LUNs (total volumes in a dual controller system) and LUN sizes up to 64 TB depending on the RAID configuration chosen. The array supports expansion and deletion of any LUN.

RAID 0, 1, 3, 5, 6, 10, 50

In addition to the usual RAID levels, the P2000 G3 features several important additional levels. RAID 6 is the highest level of RAID protection. It allocates two sets of parity data across drives and allows simultaneous write operations. It can withstand two simultaneous drive failures without downtime or data loss. RAID 10 is mirroring and striping without parity. It is the most popular of the multiple RAID levels, allowing large arrays with high performance in most cases and superior fault tolerance. RAID 50 combines the block striping and parity of RAID 5 with the straight block striping of RAID 0, yielding higher performance than RAID 5 through

Family Information

Performance

the addition of RAID 0, particularly during writes.

Performance numbers are a guideline as established by tests using RAW I/O in an Operating System Agnostic test lab environment. 144 GB 15K SAS drives were used in a dual controller configuration of 12 vdisks consisting of twelve disks per vdisk, 1.6 TB volumes, and 3 volumes per host. 4 hosts directly attached to the P2000 G3 array were used in this test configuration (results cannot be expected with a single host). Results were achieved in Sequential Writes with 256K blocks; all random tests were based on 8K block sizes.

NOTE: Number and type of applications, drive type and number of drives, operating system used, and the number of hosts will affect overall performance. This table is provided strictly as a test-lab comparison. Note: These numbers reflect a full array configuration with the maximum number of front-end ports, disks, and controllers. The test results shown for the P2000 G3 are designed to give a conservative reference point for comparisons.

2000 Array Performance	P2000 G3 FC	P2000 G3 SAS	P2000 G3 10GbE iSCSI	P2000 G3 1GbE iSCSI
Protocol (host connect)	8 Gb Fibre Channel	6 Gb SAS	10Gb Ethernet	1 Gb Ethernet
2000 RAID 10 Performance Results				
Sequential Reads MB/s	1,650	1,650	1,600	550
Sequential Writes MB/s	850	850	800	525
Random Mix IOPs 60/40 read/write	20,500	23,500	18,500	17,200
2000 RAID 5 Performance Results				
Sequential Reads MB/s	1,650	1,650	1,600	550
Sequential Writes MB/s	1,300	1,350	1,000	525
Random Mix IOPs 60/40 read/write	14,000	16,000	12,500	9,400
2000 RAID 6 Performance Results				
Sequential Reads MB/s	1,650	1,650	1,600	550
Sequential Writes MB/s	1,300	1,100	1,000	525
Random Mix IOPs 60/40 read/write	8,300	9,800	7,500	5,600
Refer to the paper titled "Upgrading the HP MSA2000 (G1 or G2) to the P2000 G3 MSA ", available in the Resource Library at: www.hp.com/go/p2000 .				

DC-power chassis

HP is making the two models of controller-less chassis available with direct current (DC) power supplies. They each have the two empty bays where users can insert one or two P2000 G3 controller(s). In addition, the P2000 chassis with LFF drive bay can have P2000 3.5-inch I/O modules inserted to create a LFF DC-power JBOD.

The 500 watt power supply is designed to operate over the input range of -40VDC to -75VDC.

HP P2000 DC-power LFF twelve 3.5-in Drive Bays

SKU
AP840B

Family Information

(supports up to 2 controllers or I/O modules)

HP P2000 DC-power SFF Chassis

AP841B

Configuration and Management Tools

HP Storage Management Utility (SMU). Management access, out-of-band: WEB GUI, CLI. Interface Types: USB, 10/100 Ethernet. Protocols Supported SNMP, SMI-S, SSL, SSH, SMTP, FTP, HTTP, Telnet

P2000 Software and Documents Support CD

- All product documentation (CD can be used on ALL supported server Operating Systems.)
- MSA Device Discovery Tool (Win and Linux) - reports P2000/MSA HW devices, and supported storage software
- Host Software Bundles (Win and Linux for both ProLiant x86, ProLiant x64 and Integrity IA64 servers)
- CD updated quarterly on HP.com with sustaining firmware updates
- The P2000 G3 contains an embedded SMI-S provider for use by SMI-S client applications. The embedded provider is designed to support P2000 configurations with up to 24 hard drives, and up to 250 mapping paths. A mapping path is defined as a P2000 volume presented through a P2000 target port to a Host initiator.

Hot Plug Expansion and Replacement Support

All P2000 G3 models support hot plug expansion and replacement of redundant controllers, enclosures, fans, power supplies, and I/O modules for simple, fast installation and maintenance. Hot add expansion of disk enclosures is also supported.

Snapshot and Clone

All G3 arrays come standard with 64 snaps, 512 snaps available. Controller based functionality. Offers higher levels of data protection, enabling an almost instant recovery from data failure or corruption. Offers alternative development testing of 'offline' production data and the ability to backup snapped/cloned data.

Overview	<p>The P2000 G3 arrays come integrated with web browser and CLI based software for storage and RAID management, setup, configuration, and troubleshooting. This reduces the cost of ownership by reducing the training and technical expertise necessary to install and maintain your HP storage solution.</p> <p>The SPOCK database provides interoperability information for thousands of components and millions of component combinations. It is available to all users at http://www.hp.com/storage/spock.</p>
Server Compatibility NOTE: depends on protocol	<p>Supports most HP ProLiant, BladeSystems and Integrity servers including</p> <ul style="list-style-type: none"> • HP ProLiant DL, ML • HP c-Class Blade Servers • Integrity servers, IA64 (FC and FC/iSCSI support only) • Compatibility must be confirmed at: http://www.hp.com/storage/spock
Industry Standard servers support	<ul style="list-style-type: none"> • Supports most multi-vendor industry standard 32-bit Intel and AMD based (x86) servers. HP requires the Third-Party Server to be logo'd and listed on the Microsoft Windows Server Catalog. • Refer to the Microsoft website: http://www.microsoft.com/windows/catalog/server/ • HP Division recommends that the Third-Party Server Vendor is an active member of TSANet. Refer to the TSANet website for details: www.tsanet.com • Non-HP servers will generally be supported if the HP storage stack is used. This includes supported HP branded HBAs and drivers, and supported FC switches.
OS Support Fibre Channel ports	<p>Refer to the HP support statements for complete current OS version support: http://www.hp.com/storage/spock</p> <ul style="list-style-type: none"> • Microsoft Windows Server 2012 • Microsoft Windows Server 2008 IA32, x64, IA64 (Standard, Enterprise, Datacenter) • Microsoft Windows Server 2008 R2 x64 • Microsoft Windows 2003 SP1, SP2, and R2 and 2003 R2 IA32, x64 • HP-UX • Red Hat Linux (32/64) • SuSE SLES (32/64)

Family Information

	<ul style="list-style-type: none"> ● Microsoft Windows Server 2008 x64 Hyper-V ● VMware ● OpenVMS ● Apple Mac OS X (requires ATTO Celerity 8Gb FC HBA) ● Solaris 10 (x86)
OS Support Fibre Channel Ports (Integrity)	<ul style="list-style-type: none"> ● HP-UX ● Windows ● OpenVMS ● Linux
OS Support 1GbE iSCSI ports on the G3 Combo FC/iSCSI Controller	<ul style="list-style-type: none"> ● Microsoft Windows Server 2012 ● Microsoft Windows Server 2008 and 2008 R2 (x64, IA64) ● Microsoft Windows Server 2008 x64 Hyper-V ● Microsoft Windows 2003 (SP1, SP2, and R2) and 2003 R2 (IA32, x64) ● Red Hat Enterprise Linux (32/64) ● SuSE Linux IA32, x64 ● VMware ESX
OS Support G3 SAS Controller	<p>Refer to the HP support statements for complete current OS version support: http://www.hp.com/storage/spock</p> <ul style="list-style-type: none"> ● Microsoft Windows Server 2012 ● Microsoft Windows Server 2008 IA32, x64 ● Microsoft Windows Server 2008 R2 ● Microsoft Windows 2003 and 2003 R2 IA32, x64 ● Red Hat Linux (32/64) ● SuSE SLES (32/64) ● Microsoft Windows Server 2008 x64 Hyper-V ● VMware ● Solaris 10 (x86)
OS Support G3 1Gb iSCSI Controller	<ul style="list-style-type: none"> ● Microsoft Windows Server 2012 ● Microsoft Windows Server 2008 SP1, SP2, R2 ● Microsoft Hyper-V (x64 only) ● Microsoft Windows Server 2003 and 2003 R2, SP2 ● VMware ● Red Hat Linux (32/64) ● SuSE SLES (32/64)
OS Support G3 10GbE iSCSI Controller	<ul style="list-style-type: none"> ● Microsoft Windows Server 2012 ● Microsoft Windows Server 2008 SP1, SP2, R2 ● Microsoft Hyper-V (x64 only) ● Microsoft Windows Server 2003 and 2003 R2, SP2 ● Red Hat Linux (32/64) ● SuSE SLES (32/64) ● VMware <p>NOTE: the G3 10GbE array must connect to a 10GbE switch; direct connect to the G3 10GbE array must be to a 10GbE NIC and supported by the OS.</p>

Family Information

Web Browser support	<ul style="list-style-type: none">• The P2000 G3 and the older MSA2000 support target based management, and include a Web interface and a telnet interface, and require a web browser for management.• The P2000 G3 FC requires Microsoft Internet Explorer V7.x or V8.x• The original MSA2000 and the MSA2000 G2 arrays require Microsoft Internet Explorer V6.X and V7.X (strongly encouraged)• Mozilla Firefox 1.0.7 or later is supported
----------------------------	--

Hardware

VMware Site Recovery Manager (SRM)

VMware Site Recovery Manager (SRM)

VMware vCenter Site Recovery Manager (SRM) is an extension to VMware vCenter that delivers business-continuity and disaster-recovery solution that helps you plan, test, and execute the recovery of vCenter virtual machines. SRM can discover and manage replicated datastores, and automate migration of inventory from one vCenter to another. Site Recovery Manager integrates with the underlying replication product through a Storage Replication Adapter (SRA).

HP P2000 Site Recovery Adapter (SRA)

The HP P2000 SRA, a free-to-use plugin, is the program that integrates the VMware vCenter SRM with HP P2000 G3 arrays. It enables full-featured use of the VMware SRM. It is a host-software component installed on a Microsoft Windows Server that enables disaster recovery management (DRM) software on the host to communicate and control certain aspects of the replication feature in storage systems connected to the server. It allows the VMware SRM software to automatically coordinate virtual machine failover and failback between a protected data center and a disaster recovery site by employing a disaster recovery solution called Remote Snap. A perfect combination of the Remote Snap replication and VMware SRM provides an unfailing automated solution for implementing and testing the disaster recovery between sites located across geographies. It enables communication between the HP P2000 Remote Snap replication functionality that is embedded in HP P2000 Fibre Channel, iSCSI, and Combo Fibre Channel systems. Users are required to acquire Remote Snap license for their local and remote HP P2000 G3 arrays to use the HP P2000 SRA.

Site Recovery Manager Requirements/Dependencies:

- Requires vSphere 5.0/SRM 5.0
 - Not compatible with SRM 4.x
- Requires HP's P2000 SRA 2.0 Plug-in (downloadable from Hp.com)
- SRM works with Remote Snap functionality
 - Requires purchase of P2000 G3 Remote Snap licenses (one for each site)
- Customers must upgrade to T240 or the latest firmware
- SRM works with FC, iSCSI or Combo controllers only

HP Insight Control Storage Module for vCenter

HP Insight Control Storage Module for vCenter

HP Insight Control Storage Module for vCenter is a component within the HP Insight Control plug-in for vCenter. It provides VMware administrators that are using VMware's vSphere management console (vCenter) with the ability to see how virtual machines are mapped to datastores and individual P2000 volumes. By providing these clear relationships between VM's, datastores and storage, the VMware administrator's productivity increases, as does the ability to ensure quality of service. Roles for administrators can be defined on an individual basis, providing the ability to apply specific permissions for both view and control functions.

The HP Insight Control Storage Module for vCenter supports mixed array environments including EVA, P4000, P2000 (MSA), and the XP array series including the P9500.

When deployed with the P2000 array, provides the following:

- Active Management functionality for the P2000 array:
 - Create/Expand/Delete a Datastore

Hardware

- Create a Virtual Machine from a template
- Monitors the health and status of the P2000
- Displays LUN / volume connections from VMs and ESX servers to the arrays and provides the location and attributes of the P2000 within the SAN
- Identifies what storage features are available to allow administrators to match the features available on the P2000 to their requirements
- Provide a cluster-level view of the storage

HP Insight Control Storage Module for vCenter is downloadable from Software Depot:

<https://h20392.www2.hp.com/portal/swdepot/displayProductInfo.do?productNumber=HPVPR>

For more information on HP Insight Control Storage Module for vCenter visit: www.hp.com/go/vmware

vStorage API for Array Integration (VAAI)

The vStorage API for Array Integration (VAAI) is one of the storage application programming interface (API) sets in vSphere 4.1. VAAI is an API storage partners can leverage to enhance performance of virtual machine (VM) management operations by delegating these operations to the storage array. With hardware offload, ESX/ESXi hosts perform certain operations faster and consume less server CPU and memory resources, and also storage port and storage fabric bandwidth. VAAI includes high performance and scalable VM data path primitives. HP introduced VAAI support for HP MSA P2000 Storage array products starting with the T230 firmware release.

Storage Hardware Primitives for VAAI

In the VMware vSphere 4.1 release, the HP StorageWorks P2000 G3 MSA Array Systems offload capabilities support the following three primitives:

- Full Copy or Hardware Assisted Move
- Block Zeroing or Hardware Assisted Zeroing
- Hardware Assisted Locking or Atomic Test and Set (ATS)

HP Storage Management Pack for Microsoft System Center

The HP Management Pack for Systems Center Operations Manager provides seamless integration with Microsoft Systems Center Operations Manager and now System Center Essentials by integrating predefined discovery and state monitoring policies, event processing rules and tasks, and diagram and topology views for the storage system.

For more information:

http://h18000.www1.hp.com/products/quickspecs/14249_na/14249_na.html

HP Storage Management Pack can be downloaded free from the following website:

<https://h20392.www2.hp.com/portal/swdepot/displayProductInfo.do?productNumber=SCOM>

Snapshot and Volume Copy Software for the P2000 G3

Product Features Data Protection

- Snapshots create up to 512 point-in-time pictures of data (512 snaps are exclusive to the P2000 G3)
- Volume Copies create up to 128 point-in-time copies of data
- Recovery is instant - revert data from any previous Snapshot or Volume Copy
- Backup 'snapped' data to disk, virtual tape, or physical tape without a backup window
- A 64 snapshot license and Volume Copy are included with all P2000 G3 models.

Hardware

- Support and updates are desired for bundled software functionalities (such as 64 LTU Snap and/or Volume Copy etc in the P2000 G3 products) a combination HW + SW support care pack must be purchased.
- HP does not provide warranty assistance for software products included with our base hardware products. This would either be SupportPlus or SupportPlus24. The hardware warranty component of these services is accounted for in the pricing of the SP and SP24 care packs.

Data Testing

- Snap or clone data to test the performance of a software application on 'offline' production data
- Snap or clone data to test how a software patch or enhancement will function on 'offline; production dat0061

P2000 G3 Snapshot and Clone:

G3 controllers/models come STANDARD with 64 snapshots and Volume Copy software
512 Snapshot option is ONLY available and supported with the G3, not the prior generation MSA2000 models

HP P2000 Array System Snapshot 512 Software LTU

TA806A

HP P2000 Array System Snapshot 512 Software E-LTU

TA806AAE

MSA2000 and MSA2000 G2 Snapshot and Volume Copy (clone) software:

Snapshot and Volume Copy software is optional on models other than the P2000 G3.

The following skus are designated for use by the MSA2000 G2 models. They are neither necessary nor available for the P2000 G3 FC.

HP 2000 Modular Smart Array Volume Copy Software LTU

T5514A

HP MSA Recovery Manager Software

Overview	<p>MSA Recovery Manager (RM) intelligently creates and manages application specific snapshots that can be used to quickly restore application instances or databases. This optional software delivers a standalone solution to augment your existing backup software strategy. It provides seamless integration with HP P2000 G3 storage hardware.</p> <p>Recovery Manager currently supports Microsoft Exchange and Microsoft SQL. Integrated with HP and 3rd party back up applications, RM provides reliable data recovery. Recovery Manager is integrated with Microsoft Volume Shadow Copy Service (VSS) to make non-disruptive point-in-time copies of Microsoft Exchange and Microsoft SQL databases for constant data protection. RM eases costs and administration by providing rapid, affordable online recovery of Microsoft® SQL Server databases from multiple, highly granular point-in-time snapshots. Quickly recover a database to a known point in time, speeding up a variety of operations including rapid recovery of the production SQL server.</p> <p>For more information please visit www.hp.com/go/recoverymanager</p>	
What's New	<ul style="list-style-type: none"> • Support for Microsoft Exchange and Microsoft SQL. • Integration with HP and 3rd party backup tool allowing backup to tape and/or disk. • Instant Recovery designed to respond to your needs for 24x7 application availability. • Support on multiple Windows platforms. 	
Models	HP MSA Recovery Manager Software LTU	TC399A
Licensing	<ul style="list-style-type: none"> • HP Recovery Manager Software is licensed per single array. One license is required for each array that contains data, specific to applications being 	TC399AAE

Hardware

	<p>supported by RM, intended for backup and recovery scenarios.</p> <ul style="list-style-type: none"> • The above license is applicable for all the applications currently supported. • License bought for a specific array may not work on another similar array. <p>NOTE: Electronic software is available in all countries except China and Japan. For China and Japan should order the physical equivalent</p>	
<p>Product Highlights</p>	<p>Features</p> <ul style="list-style-type: none"> • Creates VSS based Point-In-Time snapshots. • Supports mount, deletion of snapshots. • Schedules snapshot creation. • Single GUI & CLI for managing SQL and Exchange and for performing all management. • Auto-discovers applications - SQL and Exchange. • Group level (Instance/Storage group) or single database level snapshot creation. • Recovery of database based on point-in-time snapshots or media backup. • Exchange Database Integrity check using Microsoft utilities. • Integrates with HP Data Protector & Symantec Netbackup for Media Backup & recovery. • Supports 2 types of recovery: <ul style="list-style-type: none"> • Volume Recovery • File Copy Recovery • Supports recovery from tape backup. • Supports snapshot policy management (snapshot rotation). • Supports Microsoft Cluster Server (MSCS), Cluster Continuous Replication (CCR) and Data Availability Group (DAG) environments. <p>Applications and Platform</p> <ul style="list-style-type: none"> • Supports SQL 2005, 2008 & R2, Exchange 2007, 2010. • Supports Windows platforms as supported by the above applications. • Supports P2000 G3 (FC/iSCSI/SA). 	

HP P2000 Remote Snap Software (G3 FC and FC/iSCSI, 1GbE and 10GbE iSCSI controllers only)

- HP P2000 Remote Snap Software is array based software that provides remote replication on the HP P2000 G3 MSA Array products (except SAS model). HP Remote Snap is a form of asynchronous replication which consists of replication of block-level data from a volume on a local system to a volume that may be on the same system or on a second independent system. This second system may be collocated with the first system or may be located at a remote site. It requires T230Rxx controller firmware or higher.
- HP Remote Snap functionality is based on existing Snapshot technology offered by HP P2000 SAN Array products. Snapshots are used to track the data to be replicated as well as to determine the differences in data updated on the master volume, minimizing the amount of data to be transferred.
- HP Remote Snap replication technology provides the ability to accomplish key data management and protection capabilities. First, because Remote Snap uses snapshots as the underlying technology it creates multiple local recovery points which can be used for such tasks as to complement daily backups; second, replication provides the ability to access data in a remote site which could be used for dispersed operations; and third but definitely not least important replication allows for business continuance in the event of a failure on the primary site.
- In order to perform a replication, a snapshot of the volume to be replicated is taken, creating a point-in-time image of the data. This point-in-time image is then replicated to the destination volume by

Hardware

copying the data represented by the snapshot via a transport medium such as TCP/IP (iSCSI) or Fibre Channel. The amount of data transferred is minimized through the use of snapshots whenever possible.

HP P2000 Array System Remote Snap Software LTU

TA808A

HP P2000 Array System Remote Snap Software E-LTU

TA808AAE

(NOTE: One license per array is required for replication. For example, if you have two P2000 arrays performing replication (from Primary system to Remote System), you will need 2 licenses).

Product Features

- Storage based asynchronous snapshot replication
- Initial copy of data can be performed locally, reducing burden on wide area networks
- Support of both Ethernet and Fiber Channel interconnects provides flexible options to the application environments.
- Snapshot based replication technology means only changed data will be replicated to alternate site
- Many to 1 replication (up to 4 nodes) - primary use case is to replicate from "many" branch offices to the home office for the purpose of backing up data from the branches
- Single controller to single controller replication
- Mixed controller replication - replication between P2000 G3 Fibre Channel and P2000 G3 FC/iSCSI Combo arrays
- Advanced scheduler provides several options to IT administrators for business continuance
- Flexible architecture allows remote replication between P2000 G3 Fibre Channel and/or P2000 G3 FC/iSCSI Combo arrays. You can also join dissimilar controllers; for instance a Combo controller can snap remotely to a 1 or 10 GbE iSCSI array. Protects existing investments and enhances business continuity planning objectives.
- Replication Wizard simplifies the task of setting up and establishing replication pairs from one unified, easy to use GUI.
- Snapshot based replication enables both local and remote recovery depending on the need. Snapshot replication isolates problems to a specific point in time which can be selected by the administrator. Additionally snapshot replication supports longer distance replication.
- Multiple relationships provide greater storage flexibility and utilization.
- Bundled 64 Snapshots and Volume Copy integration provides better efficiencies by combining the management and array technologies to create local copies.
- Fast application recovery with minimal or no transaction loss
- Creation of disaster tolerant copies of your critical business data
- No-single-point-of-failure solution to increase the availability of your customers data

Hardware

Use Case - Scenario 1B "Peer" sites with failover

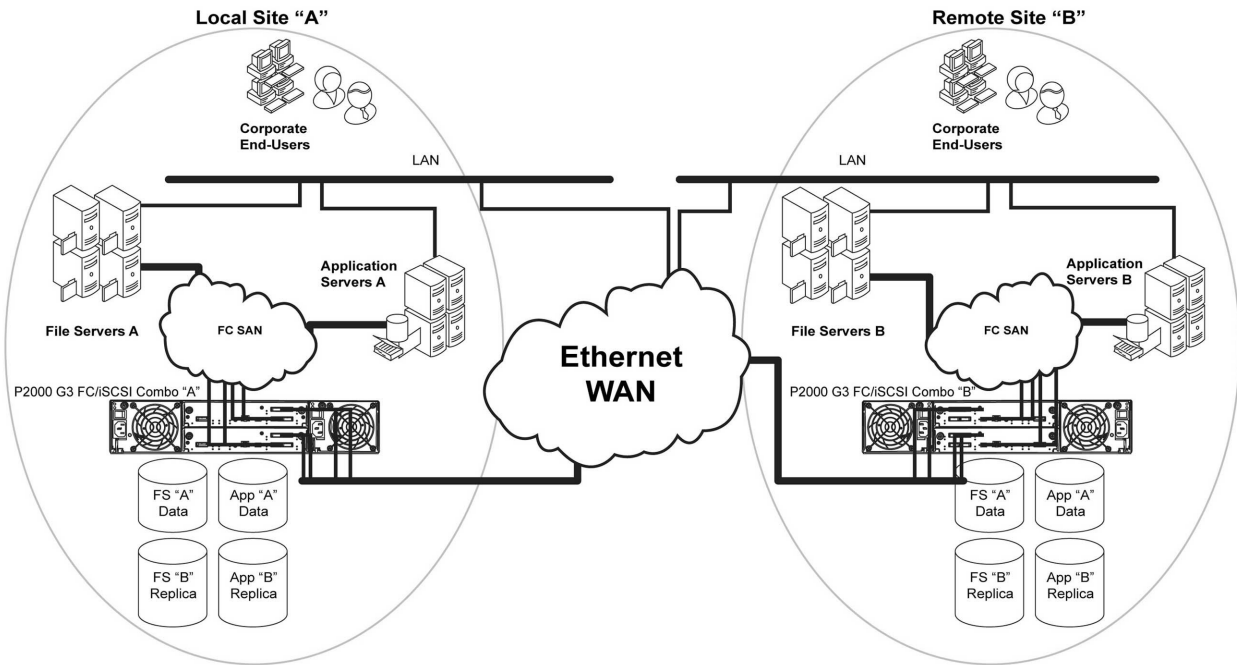

Customer Benefits

Disaster Recovery

Replication technology has typically been used to address disaster recovery issues. Disaster recovery is still the driving business case behind replication. Remote replication can be implemented from the production site to one or more remote sites across a campus, across town, across a state or across the country. When a disaster strikes the primary location, the applications can be brought up at the remote site and continue processing against the replicated copies. When the primary site is back online, the replication can be reversed and when the data is resynchronized, processing can be switched back to the primary site and business can continue. In the past, if an e-mail system experienced a disaster it was an "oh well" moment. The loss of a day or more of e-mail was not considered important. Today, e-mail is a critical component of many companies' business plans and recovering e-mail after a disaster quickly and completely is required.

Maintenance

HP Remote Snap software can also be used to solve other business needs. For instance, E-mail servers may need periodic maintenance that can take hours to complete. With remote replication in place, the downtime can be minimal (as long as it takes to bring the remote peer of the primary e-mail server online). The primary server can be worked on (patches, hardware upgrades, etc.) and then brought back online and into production. A whole datacenter can be failed over to a remote site on purpose to perform maintenance on generators, air conditioning, etc. Replication can also be used to perform a datacenter move with minimal downtime (fail everything to the DR site, move the production datacenter to its new location then fail the DR site back to the new datacenter).

Storage Based

Data replication is performed at the storage subsystem controller level and is totally transparent to the host, alleviating unnecessary host cycles to perform the data mirroring functions. Unlike a fabric based or host based solution, the storage based solution dedicates its resources to managing the replication process between arrays, with minimal impact to applications, other data or devices on the SAN.

Hardware

Bi-Directional

The bidirectional HP P2000 Array solution addresses the growing need among businesses to ensure continuous availability of applications that are critical to daily business operations. HP P2000 enables two sites in a remote replication connection to use each other as a destination to maintain replicated copies of online data. This maximizes resource utilization while enabling business continuance, even in the event of disaster.

Disaster Tolerance

The P2000 G3 FC products utilize snapshot data online and in real time to a remote P2000 G3 through a local or extended storage area network (SAN). Additionally, data replication can be bidirectional, meaning that a storage array can be both a source and a destination. A particular LUN can be replicated in only one direction between the two storage arrays. Write I/O data sent to the source is replicated by HP P2000 Array to the destination. A pair of properly configured HP P2000 G3 FC arrays is a replication solution that guarantees data integrity in the event of a storage system or site failure.

Normalization (first initial copy)

When a DR site is initially created a normalization or initial copy of the data from the source volume to the target volume must occur. The P2000 G3 array allows this first copy to take place locally. After completion the disks can be manually moved to the remote location. Subsequent changes will only remotely copy the changed blocks.

SAN Extensions

HP P2000 G3 Array provides the capability to replicate data over direct Fibre Channel. The distances supported over dark fiber are determined by the speed of the dark fiber connection and the technology used to communicate over the dark fiber.

Path failover (MPIO)

MPIO for Windows provides a single multi-path solution for HP P2000 G3 Modular Smart Array on HP servers. Support for Windows 2003 and Windows 2003 R2 operating systems is provided by HP MPIO Full Featured DSM. For the P2000 G3 this version is 2.6.1.7 or greater.

Support for Microsoft Windows 2008 is bundled within the operating system

Support for Linux distributions is with Device Mapper 4.4.0 or greater.

Support for HP-UX is native multipathing in HP-UX v3 and PV-Links in HP-UX v2.

HP StoreEasy 3000 Gateway Storage

Add more value to your P2000 array

HP MSA P2000 combined with HP StoreEasy 3830 Gateway Storage or StoreEasy 3830 Gateway Storage Blade enables you to consolidate block and file storage onto a single, high-performance system - giving your business the flexibility to meet changing business needs on-demand.

HP StoreEasy 3830 Storage delivers efficient, secure, and highly available file services that help address your changing file-serving needs. It reduces your cost of ownership by simplifying management, increasing resource utilization, centralizing growth, and protecting data. HP StoreEasy 3830 Storage leverages the Server Manager capabilities in Microsoft Windows Storage Server 2012 to provide a simple and consistent experience for managing block and file storage for multiple workloads centrally.

HP StoreEasy 3830 Gateway Storage - B7E00A

HP StoreEasy 3830 Gateway Storage Blade - B7E01A

NOTE: For more information visit: www.hp.com/go/StoreEasy

HP X3000 G2 Network Storage Gateways

Add more value to your P2000 array

Stretch your P2000 array investment by adding file services, iSCSI connectivity, print, and management hosting with an X3000 G2 Series Network Storage Gateway platform. X Series Network Storage Gateways are

Hardware

optimized NAS gateways, that are built on industry-standard HP ProLiant servers and Microsoft's Windows Storage Server 2008 R2 operating system pre-installed. Since they're Windows-based, network integration is easy, your Windows tools and data protection applications run right on the box, and management has a familiar look and feel. The X3000 G2 gateways support a wide range of file serving protocols including SMB, NFS, iSCSI, FTP, HTTP and WebDAV for heterogeneous IT environments.

HP X3400 G2 Network Storage Gateway BV870A

HP X3800 G2 Network Storage Gateway BV871A

NOTE: For more information visit: www.hp.com/go/X3000

HP P2000 G3 Carrier-Grade Components

The P2000 G3 is an 8 Gb Fibre Channel connected 2U storage area network (SAN) or direct connect solution designed for network equipment providers (NEPs) and communication service providers. Suited for those who need a robust telecom infrastructure--- they need storage devices to catch videos, photos, text, new services -- and need a place to have the data stored and cached.

The HP P2000 Carrier-Grade Chassis AP841B (RoHS Compliant SKU)) is a controller-less 6Gb chassis capable of supporting one or two P2000 G3 8Gb Fibre Channel controllers (AP836A (Retiring SKU) or AP836B (RoHS Compliant SKU)) and has twenty-four Small Form Factor (SFF) drive bays. It comes equipped with two DC-power power supplies.

The HP P2000 2.5-in Dual I/O JBOD is a special model disk enclosure designed only for use with the carrier-grade array heads. It has 24 drive bays (unlike the D2700 with 25 drive bays) and has dual DC-power supplies. It is only sold with a carrier grade array. Five of these JBODs may be cascaded from the array head.

When used in conjunction with specific Storage SFF SAS drives, the solution is NEBS certified. NEBS level-3 certification provides the assurance that the equipment is safe to operate and sturdy enough to withstand certain physical and environmental (for example, fire, earthquakes) conditions. For Seismic Zone 4 rating, the P2000 must be mounted in an HP Seismic Rack (AH335A)

P2000 DC-power Carrier-grade SFF Chassis

HP P2000 DC-power SFF Chassis

NOTE: NEBS certified

G3 Controller 8Gb FC

HP P2000 G3 MSA Fibre Channel Controller

NOTE: (1 or 2) With two 8Gb FC ports per controller. NEBS certified.

G3 Controller 10GbE iSCSI

HP P2000 G3 10GbE iSCSI MSA Array System Controller

NOTE: two 10GbE iSCSI ports per controller NEBS certified.

G3 Controller 6Gb SAS

HP P2000 G3 SAS MSA Array System Controller

NOTE: (1 or 2) with four 6Gb SAS ports per controller. NEBS certified.

HP Modular Smart Array SC08e 2-ports Ext PCIe x8 SAS Host Bus Adapter

SFF Carrier-grade (only) DC-power JBOD

RoHS Compliant SKU

AP841B

AP836B

AW595B

AW592B

614988-B21



Hardware

HP P2000 Dual I/O DC-power Carrier-Grade SFF Drive Enclosure BV921B

NOTE: NEBS certified.

24-drive SFF bays, NEBS certified, **NOTE:** only sold with carrier-grade arrays

HP MSA P2000 G3 Arrays support both the HP ProLiant Server SFF Hard Disk Drives and HP MSA SFF Hard Disk Drives

HP ProLiant Server Hard Disk Drives

HP 146GB 6G SAS 15K 2.5in Dual Port Enterprise 3yr Warranty Hard Disk Drive 512547-B21

HP 300GB 6G SAS 10K 2.5in Dual Port Enterprise 3yr Warranty Hard Disk Drive 507127-B21

HP 450GB 6G SAS 10K rpm SFF (2.5-inch) Dual Port Enterprise 3yr Warranty Hard Drive 581284-B21

HP 600GB 6G SAS 10K rpm SFF (2.5-inch) Dual Port Enterprise 3yr Warranty Hard Drive 581286-B21

HP 900GB 6G SAS 10K rpm SFF (2.5-inch) Dual Port Enterprise 3yr Warranty Hard Drive 619291-B21

HP 300GB 6G SAS 15K rpm SFF (2.5-inch) Hot Plug Enterprise 3yr Warranty Hard Drive 627117-B21

HP MSA Hard Disk Drives

Drives, carrier-grade (all NEBS certified)

HP MSA 146GB 6G SAS 15K SFF(2.5-inch) Dual Port Ent 3yr Warranty Hard Drive E2D54A

HP MSA 300GB 6G SAS 10K SFF(2.5-inch) Dual Port Ent 3yr Warranty Hard Drive E2D55A

HP MSA 450GB 6G SAS 10K SFF(2.5-inch) Dual Port Ent 3yr Warranty Hard Drive E2D56A

HP MSA 600GB 6G SAS 10K 2.5in Dual Port Enterprise 3yr Warranty Hard Disk Drive E2D57A

HP MSA 900GB 6G SAS 10K SFF(2.5-inch) Dual Port Ent 3yr Warranty Hard Drive C8S59A

HP MSA 300GB 6G SAS 15K SFF(2.5-inch) Dual Port Ent 3yr Warranty Hard Drive C8S61A

Carrier-grade HBA

HP FC2242SR 4Gb 2-port PCIe Fibre Channel Host Bus Adapter A8003B

HP 82E 8Gb 2-port PCIe Fibre Channel Host Bus Adapter AJ763B

NOTE: Emulex 82E

For more information on HP Carrier Grade Platforms go to

http://www.hp.com/products1/servers/carrier_grade/index.html?jumpid=reg_R1002_USEN

HP P2000 Remote Snap Software (G3 FC and FC/iSCSI, 1GbE and 10GbE iSCSI controllers only)

- HP P2000 Remote Snap Software is array based software that provides remote replication on the HP P2000 G3 MSA Array products (except SAS model). HP Remote Snap is a form of asynchronous replication which consists of replication of block-level data from a volume on a local system to a volume that may be on the same system or on a second independent system. This second system may be collocated with the first system or may be located at a remote site. It requires T230Rxx controller firmware or higher.
- HP Remote Snap functionality is based on existing Snapshot technology offered by HP P2000 SAN Array products. Snapshots are used to track the data to be replicated as well as to determine the differences in data updated on the master volume, minimizing the amount of data to be transferred.
- HP Remote Snap replication technology provides the ability to accomplish key data management and protection capabilities. First, because Remote Snap uses snapshots as the underlying technology it creates multiple local recovery points which can be used for such tasks as to complement daily backups; second, replication provides the ability to access data in a remote site which could be used for dispersed operations; and third but definitely not least important replication allows for business continuance in the event of a failure on the primary site.
- In order to perform a replication, a snapshot of the volume to be replicated is taken, creating a point-in-time image of the data. This point-in-time image is then replicated to the destination volume by copying the data represented by the snapshot via a transport medium such as TCP/IP

Hardware

(iSCSI) or Fibre Channel. The amount of data transferred is minimized through the use of snapshots whenever possible.

HP P2000 Array System Remote Snap Software LTU

TA808A

HP P2000 Array System Remote Snap Software E-LTU

TA808AAE

(NOTE: One license per array is required for replication. For example, if you have two P2000 arrays performing replication (from Primary system to Remote System), you will need 2 licenses).

Service and Support, HP Care Pack, and Warranty Information

Warranty

Three-year limited warranty, parts exchange Next Business day delivery

Enclosures, Hard drives, and Options for the P2000 G3 FC carry their own warranty. Refer to HP's Limited Warranty Statement for more information.

The P2000 G3 FC has been designed with customer self repairable parts to minimize repair time and provide greater flexibility in performing defective parts replacement. Please refer to HP's limited warranty Statement and parts replacement instructions for further details.

<http://h18006.www1.hp.com/products/storageworks/warranty.html>

Products included in various kits carry their own individual warranties.

NOTE: The warranty of the hard drive options purchased with the P2000 G3 FC, SAS, and 10GbE iSCSI products is different for SAS hard drives versus SAS MDL and SATA hard drives. SAS hard drive options have a three year warranty and SAS MDL and SATA hard drives options have a one year warranty.

Service and Support

Services to accelerate time to results

HP Storage Services bring you a rich portfolio of consulting and support services designed to add value to our core storage products and solutions. We have the know-how and experience to put storage technology to work for you. We work closely with you as your strategic partner, leveraging our full services portfolio to make sure that everything works to optimize your enterprise.

Choose from services aligned to our storage product offerings and lifecycle. From mission-critical onsite services to innovative web-based remote support, you choose the precise level of attention and support your business demands.

Discover, plan, and design Choose from a rich portfolio of services to make the most of P2000 G3 MSA Array Systems (Goose Island - PL Li), so you can efficiently and affordably consolidate, manage, and extract value from unstructured data.

HP Services can help you discover needs and create a plan for simplifying the environment, reducing risk, and maximizing your storage investments

HP Storage Efficiency Analysis - The HP Storage Efficiency Analysis provides customers with a view of their storage infrastructure and operating environment; highlighting recommendations for improvements. The report provides extensive insight about the existing storage environment, opportunities for efficiency gains, asset aging and replacement through interaction with key decision makers

<http://h20195.www2.hp.com/V2/GetPDF.aspx/4AA3-6727ENW.pdf>

HP Storage Impact Analysis (SIA) - The HP Storage Impact Analysis service provides a 2-4 week discovery engagement with executive summary presentation. The goal of this service is to help provide customers guidance on storage related issues and develop remediation plans.

<http://h20195.www2.hp.com/V2/GetPDF.aspx/4AA4-1174ENW.pdf>

HP Storage Cloud Design Service - Build a scalable, low-cost enterprise storage environment with inherent cloud benefits to meet big data needs.

Service and Support, HP Care Pack, and Warranty Information

HP Storage Modernization Service - The HP Storage Modernization service is a 4-6 week service that defines the customers envisioned target storage environment based on a proven solution design methodology. HP architects will quickly perform tool-assisted automatic discovery and facilitate a two-day strategy workshop with all key stakeholders involved in the storage infrastructure initiative <http://h20195.www2.hp.com/V2/GetPDF.aspx/4AA3-4620ENW.pdf>

Deploy and integrate

We can help you configure, set up, and efficiently use P2000 G3 MSA Array Systems (Goose Island - PL Li), as well as help migrate data, improve capacity utilization, and establish information management standards used across backup, replication, and archiving needs.

HP MSA/P2000 Family Disk Array Installation and Startup Service - Implement right from the start, as HP experts install, test, and configure your hardware and software onsite. We deliver a tailored storage deployment properly integrated into your environment.

HP Storage Data Migration Services - End-to-end data migration service providing seamless discovery, assessment, planning, and design, completely customizable to your organization's storage area network or network attached storage environment and using innovative software to help you migrate to HP storage quickly and efficiently. <http://h20195.www2.hp.com/V2/GetPDF.aspx/4AA3-0774ENW.pdf>

HP Storage and Data Residency Service - Strategic augmentation of your current environment with HP resources who become your trusted advisor to provide answers that are right for your storage and backup environment. <http://h20195.www2.hp.com/V2/GetPDF.aspx/4AA3-9481ENW.pdf>
HP Proactive Select - A flexible way to purchase services to fit your environment with an extensive menu of HP Proactive Select event and technical services, such as onsite firmware upgrades, health checks, assessments, and education. <http://h20195.www2.hp.com/V2/GetPDF.aspx/4AA2-3842ENW.pdf>

Operate and support

Choose the right support to maximize uptime, free up your resources, and achieve improved value-as you get the most out of the existing IT assets while accelerating time-to-revenue.

HP Proactive Care 24x7 - Hardware and software support services designed specifically for your technology with rapid access to Advanced Solution Center Specialists plus firmware and software management and best practice advice <http://h20195.www2.hp.com/v2/GetPDF.aspx/4AA3-8855ENW.pdf>

HP Proactive Care Personalized Support - An option-if you have HP Proactive Care- to bring increased personalization of the Proactive Care support experience through the assignment of an Account Service Manager (ASM) who provides IT best practice advice to help address IT issues and projects. <http://h20195.www2.hp.com/V2/GetPDF.aspx/4AA4-3446ENW.pdf>

HP Support Plus 24 - Support for environments where proactive help from HP is not required, with 24x7 hardware and software support onsite that includes third-party support with a maximum four-hour onsite response. <http://h20195.www2.hp.com/V2/GetPDF.aspx/5981-6638EN.pdf>

HP Education Services - Comprehensive training for new, as well as experienced, storage administrators designed to expand your skills and keep you up to speed with the latest storage and virtualization technology from HP Storage.

Service and Support, HP Care Pack, and Warranty Information

<http://education.hp.com/curr-storsan.htm>

Optimized Care - Delivers the highest levels of performance and stability through deployment and proactive management practices

Choose from three levels of operate and support care

HP Proactive Care 24x7-Plus, 20 credits per year

Additional options - HP Proactive Care Personalized Support (once per Proactive Care support new environment), an additional day of HP Personalized Support, and 10 additional HP Proactive Select credits per year

Standard Care - maintains high level of uptime, along with expert help to cut the cost and complexity of implementation and support

HP Proactive Care 24x7-Plus, 10 credits per year

Additional options - HP Proactive Care Personalized Support (once per Proactive Care support new environment), an additional day of HP Personalized Support, and 10 additional HP Proactive Select credits per year

Basic Care - Minimum recommended support

HP Support Plus 24; plus 10 HP Proactive Select credits per year, per array

Additional options - 10 Proactive Select Credits per Year

Remote Support Automation

HP Automation provides 24x7 coverage, proactive problem prevention, accurate problem diagnosis and faster problem resolution, as well as interactive support portals and tools. This is an integral, and cost-free, part of your HP support relationship and we are continually investing in additional cutting-edge capabilities to make it better.

For more information

www.hp.com/services/storage

To learn more on HP Storage Services, please contact your HP sales representative or HP Authorized Channel Partner

HP Care Pack Services are sold by HP and HP Authorized Service Partners:

- Services for customers purchasing from HP or an enterprise reseller are quoted using HP order configuration tools.
 - Customers purchasing from a commercial reseller can find HP Care Pack Services at www.hp.com/go/lookuptool
-

Configuration Information

Configure to Order Program Information

HP has a very successful Configure to Order program for the P2000 G3 family. The P2000 G3 models and options may or may not be factory installed in a rack with add-on controllers, switches, P2000 disk enclosures and hard drives. The P2000 G3 arrays may be integrated with ProLiant servers or as standalone storage.

Orders to be shipped through the CTO process must have a minimum of two drives of the same type (SAS, SAS MDL, or SATA) ordered per controller. SAN Starter Kits are not eligible for CTO.

Description	Product Number
P2000 G3 Controllers & Controller-less Chassis	
HP P2000 G3 FC Modular Smart Array Controller NOTE: two 8Gb FC ports	AP836B#0D1
HP P2000 G3 FC/iSCSI Combo Modular Smart Array Controller NOTE: two 8Gb FC ports and two 1GbE iSCSI ports	AP837B#0D1
HP P2000 G3 SAS Modular Smart Array Controller NOTE: four 6Gb 4x SAS ports	AW592B#0D1
HP P2000 G3 10GbE iSCSI Modular Smart Array Controller NOTE: two 10GbE iSCSI ports	AW595B#0D1
HP P2000 G3 iSCSI MSA Array System Controller NOTE: four 1Gb Ethernet iSCSI ports	BK829B#0D1
HP P2000 Modular Smart Array 3.5-in Drive Bay Chassis (LFF) NOTE: Will accept one or two controllers or Disk Enclosure I/O modules	AP838B#0D1
HP P2000 Modular Smart Array 2.5-in Drive Bay Chassis (SFF) NOTE: Will accept one or two controllers, not I/O modules	AP839B#0D1
Disk Enclosures	
HP P2000 Dual I/O LFF Drive Enclosure, NOTE: twelve 3.5" drive bays Used with single or dual controller LFF or SFF array head	AP843B#0D1
HP P2000 LFF Drive Enclosure I/O Module NOTE: no cable included. Designed for use with blank LFF chassis AP838A	AP844B#0D1
Configured Units	
HP P2000 G3 FC MSA Dual Controller LFF Modular Smart Array System	AP845B#0D1
HP P2000 G3 FC MSA Dual Controller SFF Modular Smart Array System	AP846B#0D1
HP P2000 G3 FC/iSCSI MSA Dual Combo Controller LFF Array	AW567B#0D1
HP P2000 G3 FC/iSCSI MSA Dual Combo Controller SFF Array	AW568B#0D1
HP P2000 G3 SAS MSA Dual Controller LFF Modular Smart Array System	AW593B#0D1
HP P2000 G3 SAS MSA Dual Controller SFF Modular Smart Array System	AW594B#0D1
HP P2000 G3 10GbE iSCSI MSA Dual Controller LFF Array System	AW596B#0D1
HP P2000 G3 10GbE iSCSI MSA Dual Controller SFF Array System	AW597B#0D1

Configuration Information

HP P2000 G3 iSCSI MSA Dual Controller LFF Array System

BK830B#0D1

HP P2000 G3 iSCSI MSA Dual Controller SFF Array System

BK831B#0D1

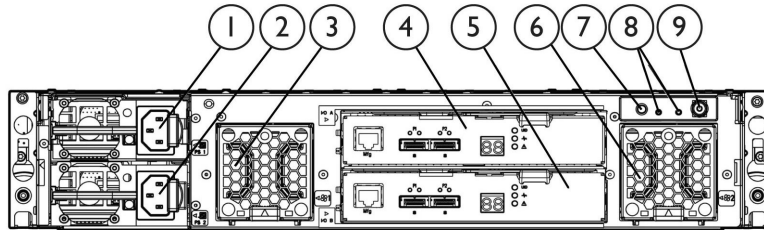

HP D2700 Disk Enclosure

Rear Panel components

- | | | |
|-------------------|-----------------|----------------------------|
| 1. Power Supply 1 | 4. I/O Module A | 7. Rear UID push button |
| 2. Power Supply 2 | 5. I/O Module B | 8. Enclosure LEDs |
| 3. Fan 1 | 6. Fan 2 | 9. Power on/standby button |

D2700 HP D2700 Disk Enclosure AJ941A#0D1

NOTE: 25 Small Form Factor (SFF) drive bays

HP MSA P2000 G3 Arrays support both the HP ProLiant Server SFF Hard Disk Drives and HP MSA SFF Hard Disk Drives

HP ProLiant Server SAS & SATA Drives (SFF 2.5-inch)	HP 300GB 6G SAS 10K rpm SFF (2.5-inch) Dual Port Enterprise 3yr Warranty Hard Drive	507127-B21
	HP 450GB 6G SAS 10K rpm SFF (2.5-inch) Dual Port Enterprise 3yr Warranty Hard Drive	581284-B21
	HP 600GB 6G SAS 10K rpm SFF (2.5-inch) Dual Port Enterprise 3yr Warranty Hard Drive	581286-B21
	HP 900GB 6G SAS 10K rpm SFF (2.5-inch) Dual Port Enterprise 3yr Warranty Hard Drive	619291-B21
	HP 1.2TB 6G SAS 10K rpm SFF (2.5-inch) Dual Port Enterprise 3yr Warranty Hard Drive	718160-B21
	HP 146GB 6G SAS 15K rpm SFF (2.5-inch) Dual Port Enterprise 3yr Warranty Hard Drive	512547-B21
	HP 300GB 6G SAS 15K rpm SFF (2.5-inch) Hot Plug Enterprise 3yr Warranty Hard Drive	627117-B21
	HP 1TB 6G SAS 7.2K rpm SFF (2.5-inch) Dual Port Midline 1yr Warranty Hard Drive	605835-B21
HP MSA SAS & SATA Drives (SFF 2.5-inch)	HP MSA 300GB 6G SAS 10K SFF(2.5-inch) Dual Port Ent 3yr Warranty Hard Drive	E2D55A
	HP MSA 450GB 6G SAS 10K SFF(2.5-inch) Dual Port Ent 3yr Warranty Hard Drive	E2D56A
	HP MSA 600GB 6G SAS 10K SFF(2.5-inch) Dual Port Ent 3yr Warranty Hard Drive	C8S58A
	HP MSA 900GB 6G SAS 10K SFF(2.5-inch) Dual Port Ent 3yr Warranty Hard Drive	C8S59A
	HP MSA 1.2TB 6G SAS 10K 2.5in Dual Port Enterprise 3yr Warranty Hard Disk Drive	E7W47A
	HP MSA 146GB 6G SAS 15K SFF(2.5-inch) Dual Port Ent 3yr Warranty Hard Drive	E2D54A
	HP MSA 300GB 6G SAS 15K SFF(2.5-inch) Dual Port Ent 3yr Warranty Hard Drive	C8S61A
	HP MSA 1TB 6G SAS 7.2K SFF (2.5-inch) Dual Port Midline 3yr Warranty Hard Drive	C8S62A

NOTE: Go to the [HP Hard Drive Compatibility table](http://www.hp.com/products/harddiskdrives) for complete drive compatibility information (<http://www.hp.com/products/harddiskdrives>). Using hard drives in unsupported configurations will result in voiding the warranty and could result in damage to the drive and/or loss of data.

Configuration Information

Step 1 - P2000 G3 - Base Configuration

Select one:

Model Name

SKU

HP P2000 Modular Smart Array 3.5-inch Drive Bay Chassis

AP838B

- Controller-less chassis with twelve Large Form Factor (LFF) drive bays. Space for two controllers.

HP P2000 Modular Smart Array 2.5-inch Drive Bay Chassis

AP839B

- Controller-less chassis with twenty-four Small Form Factor (SFF) Storage drives bays. Space for two controllers.

There are two array-head chassis - one with twelve 3.5-inch large form factor bays, the other with twenty-four 2.5-inch small form factor drive bays. For an additional twelve drive bays purchase a P2000 3.5-inch Disk Enclosure. You may attach a total of seven P2000 Drive Enclosures for a total of ninety-six LFF drive bays. For 25 additional SFF drive bays purchase D2700 JBOD. You may attach a total of five D2700 JBODs for a total of one hundred and forty nine SFF drive bays. Dual I/O modules JBODs support both single and dual controller arrays.

Step 2 - Options

Select each option with quantities specified.

Step 2a - Options

Quantity Description with Parts Shipped:

SKU

1 or 2 HP P2000 G3 MSA Fibre Channel Controller

AP836B

NOTE: for either the LFF or SFF P2000 or the two DC-powered chassis

1 or 2 HP P2000 G3 MSA FC/iSCSI Combo Modular Smart Array Controller

AP837B

NOTE: for either the LFF or SFF P2000 or the two DC-powered chassis

1 or 2 HP P2000 G3 SAS MSA Array System Controller

AW592B

NOTE: for either the LFF or SFF P2000 or the two DC-powered chassis

1 or 2 HP P2000 G3 10GbE iSCSI MSA Array System Controller

AW595B

NOTE: for either the LFF or SFF P2000 or the two DC-powered chassis

1 or 2 HP P2000 G3 iSCSI MSA Array System Controller

BK829B

NOTE: for either the LFF or SFF P2000 or the two DC-powered chassis

Configuration Information

Step 2b - SAS and SATA Drive Options

NOTE: SATA drives are designed for archival or reference data. They should not be used in a heavy or intense I/O environment. Those situations require the use of enterprise-class SAS drives. P2000 3.5-inch drives are for use only with P2000 products.

P2000 Large Form Factor (LFF) SAS drives for P2000 G3 FC and P2000 3.5-inch Disk Enclosure

HP P2000 300GB 6G SAS 15K rpm LFF Dual Port Enterprise Hard Drive	AP858A
HP P2000 450GB 6G SAS 15K rpm LFF Dual Port Enterprise Hard Drive	AP859A
HP P2000 600GB 6G SAS 15K rpm LFF Dual Port Enterprise Hard Drive	AP860A

P2000 Large Form Factor (LFF) SAS MDL DP drives for P2000 G3 FC and P2000 3.5-inch Disk Enclosure

HP P2000 1TB 6G SAS 7.2K rpm LFF (3.5-inch) Dual Port MDL Hard Drive	AP861A
HP P2000 2TB 6G SAS 7.2K rpm LFF (3.5-inch) Dual Port MDL Hard Drive	AW555A
HP P2000 3TB 6G SAS 7.2K SFF (3.5- inch) Dual Port MDL 1yr Warranty Hard Drive	QK703A
HP MSA 4TB 6G SAS 7.2K rpm LFF (3.5-inch) Midline 1yr Warranty Hard Drive	C8R26A

NOTE: Before installing >3TB HDDs in an P2000 G3 Array please update P2000 array controller firmware to version TS230Rxxx or later

MSA2 Large Form Factor (LFF) SATA drives for P2000 array head an P2000 disk enclosure

HP MSA2 1TB 7.2K rpm LFF (3.5 inch) Dual-port SATA Hard Disk Drive	AJ740B
HP P2000 2TB 3G SATA 7.2K rpm LFF MDL Hard Drive	AW556B

HP MSA P2000 G3 Arrays support both the HP ProLiant Server SFF Hard Disk Drives and HP MSA SFF Hard Disk Drives

HP ProLiant Server Small Form Factor (SFF) SAS drives for P2000 G3 Array (24 drive bay) and the D2700 JBOD (25 drive bay)

HP 300GB 6G SAS 10K 2.5in Dual Port Enterprise 3yr Warranty Hard Disk Drive e	507127-B21
HP 450GB 6G SAS 10K 2.5in Dual Port Enterprise 3yr Warranty Hard Disk Drive	581284-B21
HP 600GB 6G SAS 10K 2.5in Dual Port Enterprise 3yr Warranty Hard Disk Drive	581286-B21
HP 900GB 6G SAS 10K 2.5in Dual Port Enterprise 3yr Warranty Hard Disk Drive	619291-B21
HP 1.2TB 6G SAS 10K 2.5in Dual Port Enterprise 3yr Warranty Hard Disk Drive	718160-B21
HP 146GB 6G SAS 15K 2.5in Dual Port Enterprise 3yr Warranty Hard Disk Drive	512547-B21
HP 300GB 6G SAS 15K 2.5in Dual Port Enterprise 3yr Warranty Hard Disk Drive	627117-B21

Configuration Information

HP MSA Small Form Factor (SFF) SAS drives for P2000 G3 Array (24 drive bay) and the D2700 JBOD (25 drive bay)

HP MSA 300GB 6G SAS 10K 2.5in Dual Port Enterprise 3yr Warranty Hard Disk Drive e	E2D55A
HP MSA 450GB 6G SAS 10K 2.5in Dual Port Enterprise 3yr Warranty Hard Disk Drive	E2D56A
HP MSA 600GB 6G SAS 10K 2.5in Dual Port Enterprise 3yr Warranty Hard Disk Drive	C8S58A
HP MSA 900GB 6G SAS 10K 2.5in Dual Port Enterprise 3yr Warranty Hard Disk Drive	C8S59A
HP MSA 1.2TB 6G SAS 10K 2.5in Dual Port Enterprise 3yr Warranty Hard Disk Drive	E7W47A
HP MSA 146GB 6G SAS 15K 2.5in Dual Port Enterprise 3yr Warranty Hard Disk Drive	E2D54A
HP MSA 300GB 6G SAS 15K 2.5in Dual Port Enterprise 3yr Warranty Hard Disk Drive	C8S61A

HP ProLiant Server Small Form Factor (SFF) SAS MidLine drive for P2000 G3 Array (24 drive bay) and the D2700 JBOD (25 drive bay)

HP 1TB 6G SAS 7.2K 2.5in Dual Port Midline 1yr Warranty Hard Drive	605835-B21
--	------------

HP MSA Small Form Factor (SFF) SAS MidLine drive for P2000 G3 Array (24 drive bay) and the D2700 JBOD (25 drive bay)

HP 1TB 6G SAS 7.2K 2.5in Dual Port Midline 1yr Warranty Hard Drive	C8S62A
--	--------

HP ProLiant Server Small Form Factor (SFF) SATA MidLine drive for P2000 G3 Array (24 drive bay) and the D2700 JBOD (25 drive bay)

(NOTE: SFF SATA drives are single ported and therefore do not have a fail-over path intrinsic to their design)

HP 500GB 3G SATA 7.2K rpm SFF (2.5-inch) Midline 1yr Warranty Hard Drive	507750-B21
--	------------

Step 2c - Drive Enclosure Options

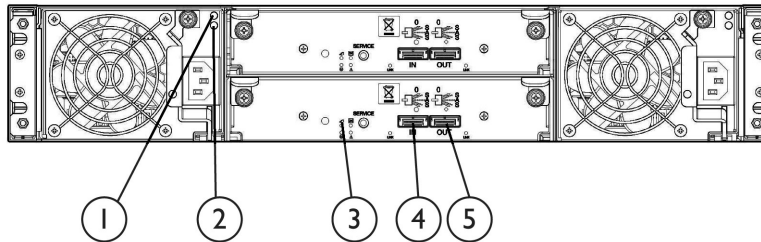

P2000 Dual I/O 3.5-inch 12 Drive Enclosure

Rear Panel components

- | | | |
|--------------------|-----------------|-----------------|
| 1. Power Indicator | 3. Unit Locator | 5. SAS Out Port |
| 2. Fault Indicator | 4. SAS In Port | |

Configuration Information

Use either disk enclosure with Large or Small Form Factor, single or dual controller array heads. Each ship with two .5m mini-SAS to mini-SAS cables.

HP P2000 Dual I/O LFF Drive Enclosure	AP843B
HP D2700 Disk Enclosure	AJ941A
HP P2000 LFF Drive Enclosure I/O Module	
NOTE: Only used in conjunction with the P2000 blank chassis (AP838A) if a single I/O disk enclosure is desired. No cable included)	AP844B

Step 2c - SAS Cable Options

miniSAS to miniSAS Cables:

Connecting P2000 G3 FC or SAS controller to a JBOD if a longer cable is desired. Also used for attaching the P2000 G3 SAS host ports to servers

HP External Mini SAS 2m Cable	407339-B21
-------------------------------	------------

Step 3 - Other P2000 G3 Options

Choose optional AC Power Cords (2 required)

NOTE: Two PDU cables: one 142263-008 (Black) and one 1422633-013 (Grey), ship standard with all AC-powered enclosures.

Power Cord, 220/240 VAC	227099-001
-------------------------	------------

Step 4a - Choose Supported Options For Fibre Channel Infrastructure

Fibre Channel	Model	Description	SKU
Host Bus Adapters - X86 servers	BladeSystem c-Class Fibre Channel Mezzanine HBAs		
		QLogic QMH2562 8Gb FC HBA for HP c-Class BladeSystem	451871-B21
		HP BLc Emulex LPe1205- 8Gb FC HBA for HP c-Class BladeSystem	456972-B21
		Lpe1105-HP 4Gb FC HBA for HP c-Class BladeSystem	403621-B21
		QMH2462 4Gb FC HBA for HP c-Class BladeSystem Windows and Linux	403619-B21
		Brocade 804 8Gb FC HBA for HP BladeSystem c-Class, Windows, VMware, Linux	590647-B21
	Fibre Channel HBAs		
	NOTE: Please visit www.hp.com/go/fchba for product details and www.hp.com/storage/spock for compatibility details.		
	Brocade Fibre Channel HBAs		
		HP 81B PCI-e FC HBA Single Port	AP769B
		HP 82B PCI-e FC HBA Dual Port	AP770B
		HP 41B 4Gb PCI-e FC HBA	AP767B
		HP 42B 4Gb Dual-Port PCI-e FC HBA	AP768B
	Emulex Fibre Channel HBAs		
		HP 81E PCI-e FC HBA Single Port	AJ762B
		HP 82E PCI-e FC HBA Dual Port	AJ763B

Configuration Information

HP FC2142 4Gb PCI-e HBA	A8002B
HP FC2242 Dual Channel 4Gb PCI-e HBA	A8003B
<u>QLogic Fibre Channel HBAs</u>	
HP 81Q PCI-e FC HBA Single Port	AK344A
HP 82Q PCI-e FC HBA Dual Port	AJ764A
HP FC1142 4Gb PCI-e HBA	AE311A
HP FC1242 Dual Channel 4Gb PCI-e HBA	AE312A

Fibre Channel Host Bus Adapters - Integrity servers

Integrity	HP 4Gb 1-port PCI-X 2.0 Fibre Channel Host Bus Adapter	AB378B
	HP 4Gb 2-port PCI-X 2.0 Fibre Channel Host Bus Adapter	AB379B
	HP 4Gb 2-port PCIe Fibre Channel Host Bus Adapter	AD300A
	HP 4Gb 1-port PCIe Fibre Channel Host Bus Adapter	AD299A
	HP 4Gb 2-port PCIe Fibre Channel Host Bus Adapter	AD355A
	HP PCIe 1-port 4Gb and 1-port 1000BT Adapter	AD221A
	HP PCIe 2-port 4Gb and 2-port 1000BT Adapter	AD222A
	HP PCIe 2-port 4Gb and 2-port 1000BSX Adapter	AD393A
	HP PCI-X 1-port 4Gb FC and 1-port 1000BT Adapter	AD193A
	HP PCI-X 2-port 4Gb FC and 2-port 1000BT Adapter	AD194A
	HP PCI Express 1-port 8Gb Fibre Channel SR (QLogic) Adapter	AH400A
	HP PCI Express 2-port 8Gb Fibre Channel SR (QLogic) Adapter	AH401A
	HP 8Gb 1-port PCIe Fibre Channel Host Bus Adapter	AH402A
	HP 8Gb 2-port PCIe Fibre Channel Host Bus Adapter	AH403A
Integrity server blades	Emulex LPe1105 4Gb Fibre Channel Host Bus Adapter for c-Class BladeSystem	403621-B21
	QLogic QMH2462 4Gb Fibre Channel Host Bus Adapter for c-Class BladeSystem	403619-B21
	QLogic QMH2562 8Gb Fibre Channel Host Bus Adapter for c-Class BladeSystem	451871-B21
	Emulex LPe1205 8Gb Fibre Channel Host Bus Adapter for c-Class BladeSystem	456972-B21

Fibre Channel Switches

HP 8/8 Base SAN Switch	AM866B
HP 8/8 SAN Switch	AM867B
HP 8/24 Base SAN Switch	AM868B
HP 8/40 Base SAN Switch	AM869B
HP 8/40 Power Pack+ SAN Switch	AM870B
HP 8/80 Power Pack+ SAN Switch	AM872B
HP 8/80 Base SAN Switch	AM871B
HP 1606 Power Pack+ Extension SAN Switch	AP864B
HP 1606 Full Extension SAN Switch	AP863B
HP 1606 Base Extension SAN Switch	AP862B
HP 2408 FCoE Base Converged Network Switch	AP801B

Configuration Information

HP 2408 FCoE Power Pack+ Converged Network Switch	AP802B
Brocade 8/12c SAN Switch for HP BladeSystem c-Class	AJ820B
Brocade 8/24c SAN Switch for HP BladeSystem c-Class	AJ821B
Brocade 8/24c SAN Switch for HP BladeSystem c-Class Power Pack+	AJ822B
Brocade 16Gb/16 SAN Switch for HP BladeSystem c-Class	C8S45A
Brocade 16Gb/28 SAN Switch for HP BladeSystem c-Class	C8S46A
Brocade 16Gb/28 SAN Switch Pwr Pk+ for HP BladeSystem c-Class	C8S47A

SKU

HP 8/20q Fibre Channel Switch NOTE: 8 device ports active, upgradeable to 20 device ports active	AQ233A
HP 8Gb Simple SAN Connection Kit NOTE: 8 device ports active, upgradeable to 20 device ports active	AK241A
HP 8/20q Fibre Channel Switch NOTE: 16 switch ports active	AK242A
HP SN6000 Stackable 8Gb 24-port single power supply FC Switch NOTE: 20 device ports active/4 stacking (ISL) ports active	AW575B
HP SN6000 Stackable 8Gb 24-port dual power supply FC Switch NOTE: 20 device ports active/4 stacking (ISL) ports active	AW576B
HP SN6000 Stackable 8 Gb 12-port Single Power Fibre Channel Switch NOTE: 8 device ports/4 stacking (ISL) ports active, upgradeable to 20 device ports active	BK780B
Cisco MDS 9124 8-ports Active Fabric Switch	AG646A
Cisco MDS 9124 16-ports Active Fabric Switch	AG647A
Cisco MDS 9124 24-ports Active Fabric Switch	AG648A
Cisco MDS 8Gb 12-port Fabric Switch for HP BladeSystem c-Class	AW563A
Cisco MDS 8Gb 24-port Fabric Switch for HP BladeSystem c-Class	AW564A
Cisco MDS 9124e 12-port Fabric Switch for HP c-Class BladeSystem	AG641A
Cisco MDS 9124e 24-port Fabric Switch for HP c-Class BladeSystem	AG642A
Cisco MDS 9134 24-ports Active Fabric Switch	AG874A
Cisco MDS 9134 32-ports Active Fabric Switch	AG875A
Cisco MDS 9222i Fabric Switch	AG851B
HP SN6000C 16-ports Active Fabric Switch	AW585A
HP SN6000C 32-ports Active Fabric Switch	AW586A
HP Nexus 5010 Converged Network Switch	AP775A
HP Nexus 5020 Converged Network Switch	AP776A
PremierFlexOM4+ type cable P2000 G2 1m HP PremierFlex OM4 LC/LC Multi-mode Optical Cable	QK732A
2m HP PremierFlex OM4 LC/LC Multi-mode Optical Cable	QK733A
5m HP PremierFlex OM4 LC/LC Multi-mode Optical Cable	QK734A
15m HP PremierFlex OM4 LC/LC Multi-mode Optical Cable	QK735A
30m HP PremierFlex OM4 LC/LC Multi-mode Optical Cable	QK736A
50m HP PremierFlex OM4 LC/LC Multi-mode Optical Cable	QK737A
OM3 FC LC-LC cables LC-LC Multi-Mode OM3 Fibre Channel Cable 0.5m	AJ833A

Configuration Information

options for the P2000 G3	LC-LC Multi-Mode OM3 Fibre Channel Cable 1m	AJ834A
	LC-LC Multi-Mode OM3 Fibre Channel Cable 2m	AJ835A
	LC-LC Multi-Mode OM3 Fibre Channel Cable 5m	AJ836A
	LC-LC Multi-Mode OM3 Fibre Channel Cable 15m	AJ837A
	LC-LC Multi-Mode OM3 Fibre Channel Cable 30m	AJ838A
	LC-LC Multi-Mode OM3 Fibre Channel Cable 50m	AJ839A

Step 4b - Choose Supported Options For 10GbE Infrastructure

- verify that the cable/transceiver is supported with the connecting device (i.e. switch or NIC/iSCSI HBA)

Copper Cable	HP 0.5m SFP+ 10GbE Copper Cable	487649-B21
	HP 1m SFP+ 10GbE Copper Cable	487652-B21
	HP 3m SFP+ 10GbE Copper Cable	487655-B21
	HP 5m SFP+ 10GbE Copper Cable	537963-B21
	HP 7m SFP+ 10GbE Copper Cable	487658-B21
SFP	HP BladeSystem 10Gb SR SFP+	455883-B21
	HP BladeSystem 10Gb LRM SFP+	455889-B21
	HP ProCurve 10-GbE SFP+ 1m Direct Attach Cable	J9281B
	HP ProCurve 10-GbE SFP+ 3m Direct Attach Cable	J9283B
	HP ProCurve 10-GbE SFP+ 7m Direct Attach Cable	J9285B
NIC	HP ProCurve 10-GbE SFP+ SR Transceiver	J9150A
	HP ProCurve 10-GbE SFP+ LRM Transceiver	J9152A
	HP NC522SFP Dual Port 10GbE Server Adapter	468332-B21
	HP NC524SFP Dual Port 10GbE Module	489892-B21
	HP NC550SFP Dual Port 10GbE Server Adapter	581201-B21
	HP NC522m Dual Port Flex -10 10GbE Multifunction BL-c Adapter	467801-B21
	HP NC532m 10GbE Dual Port Flex-10 10GbE Multifunction BL-c Adapter	467799-B21
	HP NC550m 10Gb 2-port PCIe x8 Flex-10 Ethernet Adapter	581204-B21
HP NC552SFP 10GbE 2P Svr Adapter	614203-B21	
iSCSI HBA - standup	Qlogic QLe4062c	Reference sell
iSCSI HBA - mezz	HP BLc QLogic iSCSI Dual Port Adapter with Virtual Connect Kit	488074-B22
NIC - mezz	HP NC522m Dual Port 10GbE Multifunction BL-c Adapter	467801-B21

Step 4c - Choose Supported Options For SAS connection

HP SC08e 6Gb SAS HBA for G6 and G7 rack servers	614988-B21
HP H221 Host Bus Adapter for Gen8 servers	650931-B21
HP Smart Array P712m Controller/256 for Server Blades	488348-B21
HP Smart Array P711m Controller/1 for Server Blades	513778-B21
HP 6Gb/s SAS BL Switch - Single Pack for BladeSystems	BK763A
HP 6Gb/s SAS BL Switch - Dual Pack for BladeSystems	BK764A
HP Ext Mini SAS 2M cable	407339-B21

Configuration Information

HP Ext Mini SAS 4m cable - (only be used when connecting a SAS HBA or 6Gb SAS switch to a SAS controller. Connecting it to disk enclosures is not supported.) 432238-B21

Step 5 - Choose Rack Options

Please refer to the HP Infrastructure products page for more information on HP racks and rack options or the HP 10000 G2 Series Rack QuickSpec.

<http://h18004.www1.hp.com/products/servers/platforms/rackandpower.html>

http://h18000.www1.hp.com/products/quickspecs/12402_na/12402_na.HTML

Technical Specifications

P2000 G3 FC P2000 G3 FC/iSCSI P2000 G3 SAS P2000 G3 10GbE iSCSI P2000 G3 iSCSI (1Gb)	POWER REQUIREMENTS	
	Input Power Requirements (typical-running I/O) SFF/LFF arrays	<ul style="list-style-type: none"> ● 8G FC (2 Port - 8G FC) 110VAC 3.32A, 344-390 W; 220VAC 1.61A,374-432W ● FC/iSCSI Combo (2 Port - 8G FC + 2 Port -1G iSCSI) 110VAC; 3.64A,357-418W, 220VAC 1.77 A, 365-424W ● 6G SAS (4 Port - 6G SAS) 110VAC 3.49A,344-390W, 220VAC 1.7A 374-432W ● 10GbE iSCSI (2 Port - 10 GbE iSCSI) 110VAC 3.67A, 395W, 220VAC,1.95A 388.2W ● 1G iSCSI (4 Port - 1GbE iSCSI) 110VAC 3.3A 363W, 220VAC, 1.63A 360W
	Max Input Power	100-240 VAC, 50/60 Hz., 4.5-1.9A; 48-60 VDC 10.4A/8.3A
	Heat Dissipation	1622 BTU/hr
	TEMPERATURE AND HUMIDITY RANGES	
	Operating Temperature	41°F to 104°F (5°C to 40°C)
	Shipping Temperature	-40°F to 158°F (-40°C to 70°C)
	Operating Humidity	10% to 90% RH @ 104°F (40°C) non-condensing
	Non-Operating Humidity	Up to 93% RH @ 104°F (40°C)
	DECLARED ACOUSTIC NOISE LEVELS	
	Sound Power	A weighted sound power LWAd=6,75 B
	Sound Pressure	A weighted sound pressure LpAm - 55dB
	SHOCK AND VIBRATION	
	Shock, Operational	10G's for 10 milliseconds
	Shock, Non-Operational	15G 11ms half sine
	Vibration, Operational	5-500Hz, 0.21Grms flat
	Vibration, Non-Operational	3-365-3Hz, 1.22 Grms,z-axis,0.85 Grms, X&Y axis shaped spectrum
	PHYSICAL	
	Height	3.5 in/ 8.9 cm
	Depth (excluding cables) (back of ear to back of controller handle)	P2000 G3 SFF 24-bay array: 20.28 in / 51.510 cm P2000 G3 LFF 12-bay array: 21.3 in. / 55.1 cm
	Width (body only)	17.6 in / 44.7 cm (w/ ears 19 in / 48.26 cm)
	Chassis Weight (no controllers)	P2000 LFF chassis: 34.1 lbs. (DC-pwr model: 37.9 lbs) P2000 SFF chassis: 32.3 lbs (DC-pwr model: 36.1 lbs)

Technical Specifications

P2000 G3 FC Controller	User Interface	Status and activity provided via management interfaces. Status Indicators on front of Controller
	FC/iSCSI Combo Controller	
P2000 G3 SAS Controller	RAID Support	0, 1, 3, 5, 6, 10, 50
	Cache Memory	2GB Read/Write. ECC protection with backup to Flash memory (indefinite backup)
P2000 G3 10GbE iSCSI Controller	Cache Backup	ECC protection with back up to flash memory (indefinite backup)
	Upgradeable Firmware	yes
P2000 G3 iSCSI Controller (1Gb)	Disk Drive and Enclosure Protocol Support	6 Gb SAS - Serial Attached SCSI
	Host Ports	FC: 2 x 8Gb Fibre Channel SFP+ SAS: 4 -4x lane 6 Gb SAS Host Connections 10GbE iSCSI: 2 x 10GbE SFP+ 1GbE iSCSI: 4 x 1GbE RJ45
	Expansion Port	SAS (SFF8088) 4x lane 6 Gb SAS
	Weight, controller	P2000 G3 Fibre Channel, FC/iSCSI, SAS, and 10GbE iSCSI MSA Controllers 4.5lbs. 1GbE iSCSI is 4.89 lbs

P2000 G3 Regulatory Info	Safety	UL 60950-1 (USA)
		CAN/CSA-C22.2 No.60950-1-03 (Canada)
		EN 60950-1 (European Union)
		GS mark (Germany)
		IEC 60950-1 (International)
		CCC Mark (power supply only, China PRC)
	Electromagnetic Compatibility	VCCI:2008-04 Class A (Japan)
		FCC 15:109(g) Class A (USA)
		ICES-003:2004 Class A (Canada)
		EN55022 : (European Union Class A); CISPR 22 (International Class A)
		EN61000-3-2 : (Harmonics) (European Union)
		EN61000-3-3 : (Flicker) (European Union)
		EN 55024 (European Union, Immunity, Class A);CISPR 24 (International Immunity, Class A)
		AS/NZS CISPR 22, Class A (Australia, New Zealand)
		CNS 13438 Taiwan, Class A (Taiwan)
KN22 Class A (Emissions Class A); KN24 (Immunity) (S Korea)		
RoHS and WEEE	RoHS-6/6 Compliance, China RoHS, WEEE	
Country Approvals	United States ,Australia/New Zealand, Canada, China (PRC), European Union, Germany (GS Mark), Japan, South Korea, Taiwan	

Technical Specifications

© Copyright 2013 Hewlett-Packard Development Company, L.P.

The information contained herein is subject to change without notice.

Microsoft and Windows NT are US registered trademarks of Microsoft Corporation. Intel is a US registered trademark of Intel Corporation. Unix is a registered trademark of The Open Group.

The only warranties for HP products and services are set forth in the express warranty statements accompanying such products and services. Nothing herein should be construed as constituting an additional warranty. HP shall not be liable for technical or editorial errors or omissions contained herein.

Free Manuals Download Website

<http://myh66.com>

<http://usermanuals.us>

<http://www.somanuals.com>

<http://www.4manuals.cc>

<http://www.manual-lib.com>

<http://www.404manual.com>

<http://www.luxmanual.com>

<http://aubethermostatmanual.com>

Golf course search by state

<http://golfingnear.com>

Email search by domain

<http://emailbydomain.com>

Auto manuals search

<http://auto.somanuals.com>

TV manuals search

<http://tv.somanuals.com>