

HP BladeSystem c3000 Enclosure technologies

technology brief



Abstract.....	2
Overview of HP BladeSystem c3000 Enclosure	2
HP Thermal Logic technologies	4
Active Cool fans	5
HP PARSEC architecture.....	6
Thermal Logic for the server blade and enclosure.....	7
Power supplies and enclosure power subsystem.....	8
HP BladeSystem Power Sizer	9
Pooled power	10
Dynamic Power Saver mode.....	11
Power Regulator.....	11
Power Capping for each server blade.....	11
Interconnect options and infrastructure.....	12
Fabric connectivity and port mapping.....	13
Virtual Connect.....	16
Enclosure-based DVD ROM.....	17
Onboard Administrator	17
Insight Display	19
Web GUI.....	20
Command-line interface	20
Onboard Administrator cabling	20
Enclosure link cabling.....	20
Recommendations.....	21
Summary	21
Appendix A. Acronyms in text.....	22
Appendix B. Fan, power supply, and device bay population guidelines.....	23
For more information.....	28
Call to action	28

Abstract

The HP BladeSystem c3000 Enclosure is the next generation in an evolution of the entire rack-mounted infrastructure. The c3000 Enclosure is designed for remote sites, small and medium-sized businesses, and data centers with special power and cooling constraints. This technology brief provides an overview of the HP BladeSystem c3000 Enclosure, including a comparison with the enterprise-class HP BladeSystem c7000 Enclosure, Thermal Logic power and cooling technologies, and interconnect options.

This technology brief assumes the reader is familiar with HP ProLiant server technology and has some knowledge of general BladeSystem architecture. For more information about the infrastructure components, see the HP website at www.hp.com/go/bladesystem/.

Overview of HP BladeSystem c3000 Enclosure

The HP BladeSystem c3000 Enclosure, announced in September 2007, is the newest enclosure implemented using the BladeSystem c-Class architecture. While the c7000 Enclosure is optimized for enterprise data center applications, the c3000 Enclosure is optimized for other computing environments, such as remote sites or small businesses. More information on c-Class architecture and the c7000 Enclosure is available on the HP technology website at www.hp.com/servers/technology.

The c3000 Enclosure fits into standard size HP and third-party racks, and accommodates c-Class form-factor server/storage blades and interconnect modules. It has the flexibility to scale from a single enclosure holding up to 8 server blades, to a rack containing 7 enclosures holding up to 56 server/storage blades total. It is optimized for data centers with special power and cooling constraints, such as DC powered racks, or data centers with low power and cooling capacities (under 4000 watts per rack). The c3000 Enclosure is designed for use with management devices such as local KVM switches for local administration.

The HP BladeSystem c3000 Enclosure has a fully redundant design with redundant signal paths between servers and interconnect modules. The enclosure is available with a single-phase power subsystem. It can be populated with the following components:

- Up to 4 full-height (FH) server blades or up to 8 half-height (HH) server and/or storage blades per enclosure
- Up to 4 interconnect modules simultaneously supporting a variety of network interconnect fabrics such as Ethernet, Fibre Channel (FC), InfiniBand (IB), Internet Small Computer System Interface (iSCSI), or Serial-attached SCSI (SAS)
- Active Cool fan kits for a maximum of 6 fans
- Up to 6 power supplies, accepting either low-line (100 to 120 volts alternating current [VAC]), or high-line (200 to 240 VAC) power input
- Onboard Administrator (OA) management module
- Optional DVD drive
- Optional KVM enclosure module for connecting the c3000 to a in-rack KVM switch

Both c-Class enclosures have common critical components such as servers, interconnects, mezzanine cards, storage blades, power supplies, and fans. Table 1 lists components supported by the c3000 and c7000 Enclosures.

Table 1. Comparison of components supported by HP BladeSystem c-Class Enclosures

Enclosure	c3000	c7000
Height	6U	10U
Blade orientation	Horizontal	Vertical
Blades supported	8 HH , 4 FH, 6HH/1FH	16 HH, 8 FH
Interconnect bays	4	8
Power supplies	6 at up to 1200 watts each	6 at 2250 watts each
Active Cool fans	6	10
Enclosure KVM support	Yes	No
CD/DVD support	Enclosure-based available	External
OA support	Single (now) Dual (future)	Single or dual
Midplane speed	Tested up to 10 Gbit on Midplane	Tested up to 10 Gbit on midplane
OA Serial/USB connections	In front	In rear

Figures 1 and 2 show the front and rear view of the HP BladeSystem c3000 Enclosure.

Figure 1. HP BladeSystem c3000 Enclosure – front view

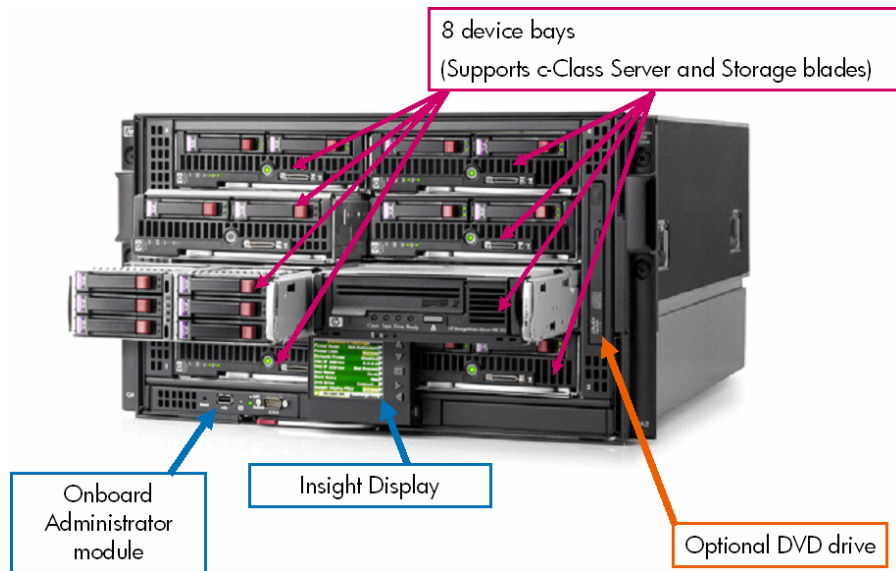
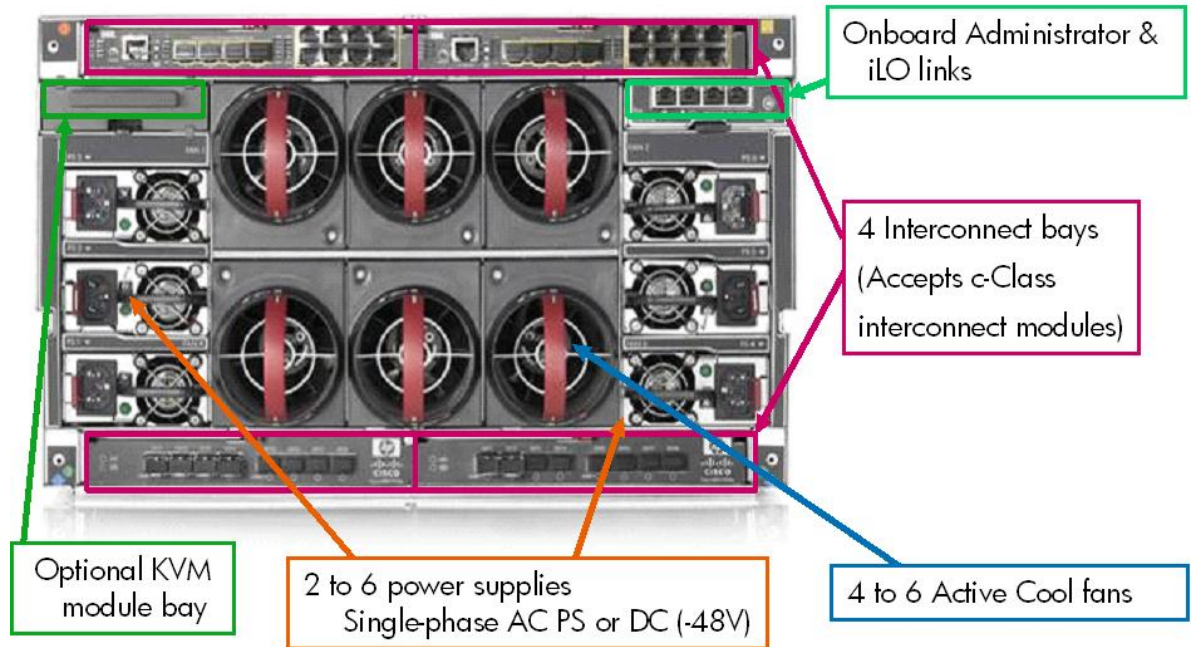

Figure 2. HP BladeSystem c3000 Enclosure – rear view



HP Thermal Logic technologies

HP BladeSystem c-Class products have been designed with a variety of HP Thermal Logic technologies—a set of technologies integrated across server blades, enclosures, and interconnect modules—all of which combined provide significant power and cooling benefits in comparison to traditional rack and tower based servers. HP BladeSystem products reduce overall demand for power and cooling by as much as 40 percent compared to standard rack and tower based servers. Thermal Logic is the term that HP uses to define the mechanical design features, built-in intelligence, and control capabilities throughout the BladeSystem c-Class. Thermal Logic technologies enable IT administrators to make the most of the power and thermal environments. They provide an instant view of power usage and temperature at the server, enclosure, or rack level. Thermal Logic technologies automatically adjust power and thermal controls to minimize power and cooling usage while maintaining adequate cooling for all devices and ensuring high availability.

HP Thermal Logic technologies include the following elements and capabilities:

- Active Cool fans
- Parallel Redundant Scalable Enclosure Cooling (PARSEC) design
- Instant power and thermal monitoring
- Pooled power for a variety of power redundancy modes
- Dynamic Power Saver mode
- Power Regulator
- Power workload balancing

Active Cool fans

Quite often, dense, full-featured, small form-factor servers use very small fans designed to provide localized cooling in the specific areas needed by the server blade. Because such fans generate fairly low airflow (in cubic feet per minute, or CFM) at medium backpressure, a single server often requires multiple fans to ensure adequate cooling. Therefore, installing many server blades together in an enclosure, with each server blade containing several fans, can result in significant cost and space overhead.

A second solution for cooling is to use larger, blower-style fans that can provide cooling across an entire enclosure. Such fans are good at generating CFM, but they typically require higher power input, take up more space, make more noise, and must be designed for the maximum load in an enclosure. As a result, designers may have to sacrifice server features to allow the large, high-power fans to fit in the enclosure. Even then, ensuring adequate airflow to all the servers without leakage, over provisioning, or bypass is a challenge.

To overcome these issues for the HP BladeSystem c-Class, HP engineers designed a new type of fan based on aircraft technology that delivers both high airflow and high pressure in a small form factor that can scale to meet future cooling needs. HP Active Cool fan technology optimizes airflow, reduces power draw, and improves acoustic performance for any server blade configuration.

With 20 patents pending involving Active Cool fan technology and its implementation, HP Active Cool fans are an innovative design that can cool eight server blades using as little as 100 watts of power. Active Cool fans use ducted fan technology (the fan is longer than it is wide) with a high performance motor and impeller (Figure 3) to deliver high CFM at a high pressure. The fan includes a bell mouth inlet with a specially-designed impeller, followed by a stator section that also provides cooling fins for the motor and acoustic treatments in the rear of the fan. This design provides cooling capacity to support blade products beyond current roadmaps. Its unique shape allows for high-pressure flow at even the slowest speeds with low noise levels and minimal power consumption.

Figure 3. Ducted fan cross-section and ducted fan blade compared to traditional server fan

Ducted fan cross-section

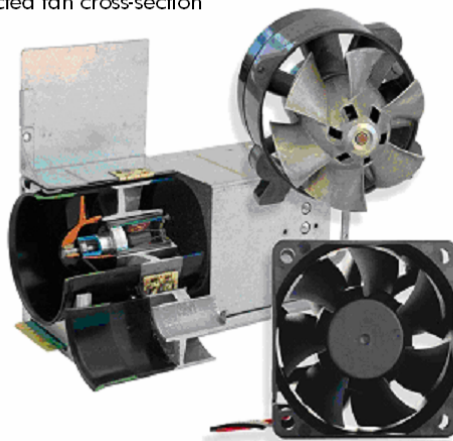

Ducted fan blade

Traditional server fan

Active Cool fans are controlled by the c-Class Onboard Administrator so that cooling capacity can be ramped up or down based on the needs of the entire system. Along with optimizing the airflow, this control algorithm allows the BladeSystem c-Class to optimize the acoustic levels and power consumption. As a result, the c3000 Enclosure requires less airflow (CFM) than traditional rack-mount servers to properly cool the server blades within the enclosure.

HP PARSEC architecture

HP Parallel Redundant Scalable Enclosure Cooling (PARSEC) architecture is a hybrid model for cooling that combines the best of local and centralized cooling in a single system to ensure optimum airflow and cooling for all servers. Density, once a barrier to cooling, is turned into an advantage with HP Thermal Logic technologies like HP PARSEC architecture and HP Active Cool fans. With these innovations, server blades get more cooling airflow where it is needed most and use less power than traditional rack servers.

To optimize thermal design, HP developed a relatively airtight center air plenum, or air chamber. For example, all device bays include a shutoff door that is normally closed to prevent air leakage through that device bay. When a server blade is inserted, it seals into the center air plenum docking collar, and the server shut-off door opens to allow airflow across that server blade. Similarly, the fan seals into the center air plenum docking collar. Each fan bay includes louvers that automatically open when a fan is installed. If a fan is not installed or is not functional, the pressure distribution around the fan changes. This pressure change causes the louvers to close, ensuring that cooling air is not diverted through the non-operating fan.

The enclosure and the components within it optimize the cooling capacity through unique mechanical designs. Airflow through the enclosure is managed to ensure that every device gets cool air, that no device sits in the hot exhaust air of another device, and that air only goes where it is needed for cooling. Fresh air is pulled into the interconnect bays through a slot in the front of the enclosure. Ducts move the air from the front to the rear of the enclosure, where it is then pulled into the interconnects and the central plenum. The air is then exhausted out the rear of the system (Figure 4).

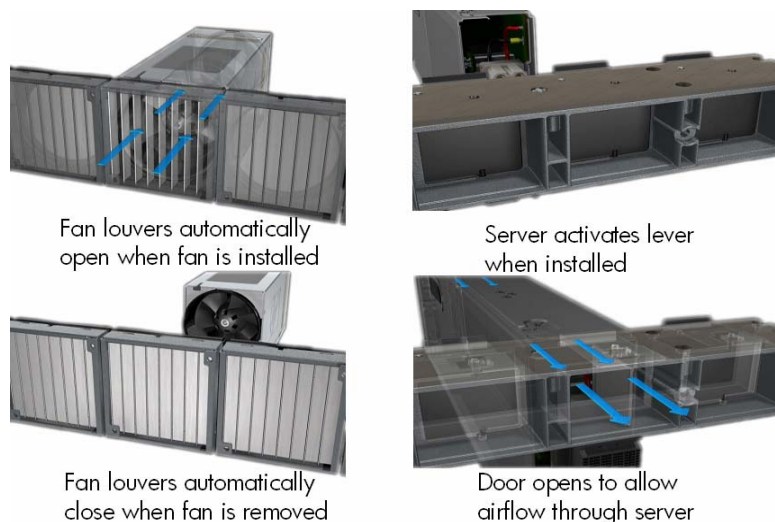
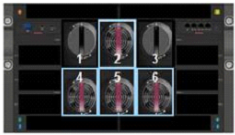

Figure 4. HP BladeSystem c3000 self-sealing enclosure



Base BladeSystem c3000 Enclosures ship with four installed fans that support up to four half-height devices in device bays 1, 2, 5, and 6, or two full-height server blades in device bays 1 and 2. Adding two additional fans to the enclosure allows population of eight half-height devices or four full-height server blades.

In a four-fan configuration, the Onboard Administrator prevents server and storage blades installed in device bays 3, 4, 7, and 8 from powering on until two additional fans are added into fan bays 1 and 3. To populate blade devices in all eight device bays, it is necessary to populate c3000 Enclosures with six Active Cool fans. Figure 5 shows enclosure fan bay and device bay population guidelines. See Appendix B for more detailed fan and device bay population guidelines.

Figure 5. The c3000 Enclosure fan bay and device bay population guidelines

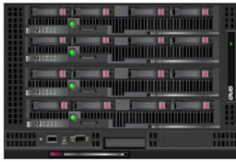
# of fans	Half-height blades	Full-height blades
<p>4 fans</p>  <p>Bays 2,4,5,6</p>	<p>4 half-height blades</p> <p>Bays 1,2,5,6</p> 	<p>2 full-height blades</p> <p>Bays 1,2</p> 
<p>6 fans</p>  <p>All bays</p>	<p>8 half-height blades</p> <p>All bays</p> 	<p>4 full-height blades</p> <p>All bays</p> 

Thermal Logic for the server blade and enclosure

The server blade design uses precise ducting throughout the server blade to manage airflow and temperature based on the unique thermal requirements of all the critical components. The airflow is tightly ducted to ensure that no air bypasses the server blade and to obtain the most thermal work from the least amount of air. This concept allows much more flexibility in heat sink design choice. The heat sink design closely matches the requirements of the server blade and processor architecture. For example, in the Intel® Xeon® based HP BladeSystem BL460c server blade, HP was able to use a smaller, high-power processor heat sink than in rack-mount servers. These heat sinks have vapor chamber bases, thinner fins, and tighter fin pitch than previous designs. This allows creating the largest heat transfer surface in the smallest possible package (Figure 6). The smaller heat sink allows more space for full-size DIMM sockets and hot plug hard drives on the server blades.

Ducting produces high pressure, so the server blade uses less airflow and that reduces fan power requirements. The lower airflow requirement has the added benefit of optimizing available data center cooling capacity, which is one of the main issues facing IT facilities today and in the future.

Each device (server blades, interconnect modules, and enclosure subsystems) includes temperature sensors that monitor heat. If high temperature levels occur, the Integrated Lights-Outs (iLO) and Onboard Administrator modules provide alerts to various management tools such as Insight Control and HP Insight Manager. In addition, built-in failsafes will shut down devices in the enclosure if temperature levels exceed specified parameters. This prevents permanent damage to any devices within the enclosure.

Figure 6. Processor heat sink using fully ducted design (left) and a traditional heat sink in a 1U rack-mount server (right)



Instant Thermal Monitoring provides a real-time view of heat, power, and cooling data. The Onboard Administrator retrieves thermal information from all server blades, storage blades, and interconnect modules in the enclosure to ensure an optimal balance between cooling, acoustic levels, and power consumption. The Thermal Logic feature of the Onboard Administrator keeps fan and system power at the lowest level possible. However, if the thermal load within the enclosure increases, the Thermal Logic feature instructs the fan controllers to increase fan speeds to accommodate the additional demand. Typically, a distributed element manager queries the thermal conditions of the hardware every few minutes in a polling cycle. Onboard Administrator, on the other hand, monitors the thermal conditions on the hardware in real-time, without a delay for a polling cycle.

HP's Thermal Logic includes sophisticated algorithms in each BladeSystem ROM, iLO, and Onboard Administrator. In combination, these algorithms minimize the power and cooling required to properly operate the HP BladeSystem environment.

Power supplies and enclosure power subsystem

Power is delivered through a pooled power backplane that ensures that the full capacity of the power supplies is available to all server blades. BladeSystem c3000 power supplies are single-phase power supplies, supporting both low-line and high-line environments. Wattage output per power supply depends on the rated alternating current (AC) input voltage. The BladeSystem c3000 Enclosure ships with two power supplies; however, up to six power supplies can be installed, depending on the AC redundancy level required and the number of devices installed in the enclosure. AC power supplies auto-switch between 100VAC and 240VAC, to provide deployment options.

The BladeSystem c3000 Enclosure houses the power supplies in the same enclosure as the server blades, storage blades, and interconnect modules (Figure 7). The power supply modules connect to a passive power backplane that distributes power to all the components in a shared manner. Moving the power supplies into the enclosure allowed HP to reduce the transmission distance for DC power distribution and to use an industry-standard 12V infrastructure for the BladeSystem c-Class. Using a 12V infrastructure allowed HP to eliminate several power-related components and improve power efficiency on the server blades and in the infrastructure. The control circuitry was stripped and put on the management board and fans.

Figure 7. HP BladeSystem c3000 Enclosure supports up to six power supplies

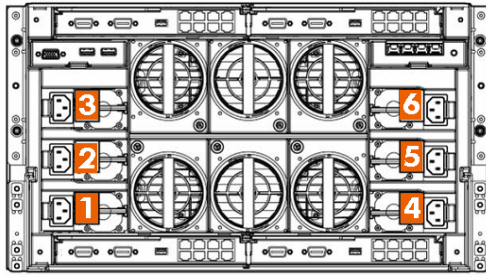

The new, high efficiency HP c3000 power supplies provide greater than 90 percent efficiency in AC to DC conversion. These power supplies use the ProLiant universal form factor so they can also be used in other ProLiant servers. Each AC power supply ships with a standard power distribution unit (PDU) power cord (C13 to C14). By purchasing proper wall outlet cords, users can connect the power supplies to standard wall outlets.

NOTE

Wall outlet power cords should only be used with low-line (100 to 120 VAC) power sources. If high-line (200 to 240 VAC) power outlets are required, safety regulations require the use of a PDU or a UPS between the c3000 Enclosure power supplies and wall outlets.

The enclosure can contain up to six 1200-watt self-cooled power supplies. A pair of PDUs is required for AC line redundancy. A variety of PDUs can be chosen, as indicated in the c3000 QuickSpecs available at this URL: http://h18004.www1.hp.com/products/quickspecs/12790_div/12790_div.html. The HP BladeSystem Power Sizer should be used to size the PDU appropriately for the c3000 storage and server configuration.

HP expects that in the markets targeted for the c3000 Enclosure (midmarket and remote sites), the c3000 will be connected to an uninterruptible power supply (UPS) for power backup instead of to a PDU. Use the HP BladeSystem Power Sizer to determine the UPS capacity requirement.

NOTE

The rack-mountable HP R5500 UPS (5000VA/4500 watts) supports four power supplies in the power supply redundant (N+1) power mode.

HP BladeSystem Power Sizer

The HP BladeSystem Power Sizer is a tool that assists facilities teams and IT staff in sizing their power and cooling infrastructure to meet the needs of an HP BladeSystem solution. The BladeSystem Power Sizer is based on actual component-level power measurements of a system stressed to maximum capability. The sizer allows a customer to select the type and number of components within each server blade and enclosure and to see the effect of changes on power consumption and heat loading.

Values obtained from the BladeSystem Power Sizer tool are based on worst case loads and are intended for facility planning purposes only. Actual power consumption will vary with application type, application utilization, and ambient temperature. The BladeSystem Power Sizer is available at the following URL: <http://www.hp.com/go/bladeSystem/powercalculator>.

Pooled power

All the power in the enclosure is provided as a single pool that any server blade can access. This provides maximum flexibility when configuring the power in the system so that customers can choose what level of redundancy is required. Because this power design has no zones, it facilitates both N+N and N+1 power modes, which future-proofs the enclosure for higher power requirements, if needed. Therefore, looking forward at least five years, HP believes there is sufficient power capacity to handle future power-hungry devices.

If needed, customers can constrain the maximum BTUs per enclosure and rack to enable the enclosure to fit in an existing rack power envelope.

The c3000 Enclosure has three configurable redundancy modes: power supply redundant, AC redundant, and no redundancy mode. The c3000 Onboard Administrator or the Insight Display can be used to select the power redundancy mode. The HP BladeSystem Onboard Administrator User Guide is available at this URL:

<http://h20000.www2.hp.com/bc/docs/support/SupportManual/c00705292/c00705292.pdf>.

Typical power configuration connecting to UPS

If N+1 power supply redundancy is configured (Figure 8), then total power is defined as total power available less one power supply (3+1 configuration = up to 3600W). Up to six power supplies can be installed, with one power supply always reserved to provide redundancy. Typically, four power supplies are used for an N+1 power supply connection to a high-line (200-240 VAC) UPS. A smaller UPS may be adequate, but the power calculator should be used to determine the VAC required for the UPS. In the event of a single power supply failure, the redundant power supply will take over the load of the failed power supply.



Figure 8. Redundant HP BladeSystem c3000 power supplies connected to an HP R5500 UPS



Connecting to PDUs with AC redundancy to each rack

If N+N AC redundancy is configured, then total power available is the amount from the A or B side containing fewer power supplies (3+3 configuration = up to 3600W). In this configuration, N power supplies are used to provide power and N are used to provide redundancy, where N can equal 1, 2, or 3. Any number of power supplies from 1 to N can fail without causing the enclosure to fail. When correctly wired with redundant AC line feeds, this will also ensure that an AC line feed failure will not cause the enclosure to power off.

Connecting with no power redundancy configured

If no power redundancy is configured, the total power available is defined as the power available from all power supplies installed (six power supplies installed = up to 7200W). Any power supply or AC line failure may cause the system to power off.

The Onboard Administrator manages power allocation rules of various components and can limit overall power capacity for the enclosure. More information on power management is available in the technology brief entitled "Managing the HP BladeSystem c-Class," which is available at this URL: www.hp.com/servers/technology.

Dynamic Power Saver mode

Dynamic Power Saver mode provides power load shifting for maximum efficiency and reliability. Dynamic Power Saver technology, first introduced with the BladeSystem p-Class 1U power enclosure, maximizes power supply efficiency to provide real customer power savings that result in capital savings. Power supply efficiency is simply a measure of AC watts input in versus DC watts out: At 50 percent efficiency, 2000W in would equal 1000W out. The difference is wasted energy, which generates unnecessary heat.

Dynamic Power Saver mode is active by default since it saves power in the majority of situations. When enabled, Dynamic Power Saver mode saves power by running the required power supplies at a higher rate of utilization and putting unneeded power supplies in a standby mode. Dynamic Power Saver uses the fact that most power supplies will operate less efficiently when lightly loaded and more efficiently when heavily loaded. A typical power supply running at 20 percent load could have an efficiency rating as low as 60 percent. However, at 50 percent load it could be up to 90 percent efficient, providing a significant savings in power consumption.

Dynamic Power Saver is enabled by the Onboard Administrator module. When this feature is enabled, the total enclosure power consumption is monitored in real-time and automatically adjusted with changes in demand.

NOTE

In redundant environments, a minimum of two power supplies are always active, and the maximum load that can be reached on any power supply is 50 percent. Once the 50 percent load is reached, another two power supplies are activated to ensure that redundancy is maintained at all times.

Power Regulator

HP's ProLiant Power Regulator provides iLO-controlled speed stepping for Intel x86 processors. The Power Regulator feature improves server energy efficiency by giving processors full power for applications when they need it and reducing power when they do not. This power management feature enables ProLiant servers with policy-based power management to control processor power states. Power Regulator can be configured for continuous, static low power mode or for Dynamic Power Savings mode in which power is automatically adjusted to match processor demand. Additional information on the HP Power Regulator is provided in the paper titled "Power Regulator for ProLiant servers," available at www.hp.com/servers/power-regulator.

Power Capping for each server blade

Using updated iLO 2 firmware (version 1.30) and updated System ROM/BIOS (dated May 1, 2007), HP BladeSystem c-Class server blades now have the ability to limit the amount of power consumed. Customers can set a limit in watts or BTUs per hour. The purpose of this limit is to constrain the amount of power consumed, which reduces the heat output into the data center. The iLO 2 firmware monitors

server power consumption, checks it against the power cap goal, and, if necessary, adjusts server performance to maintain an average power consumption that is less than or equal to the power cap goal. This functionality is available on all Intel-based ProLiant server blades.

Using the Insight Power Manager (IPM) v1.10 plug-in to Systems Insight Manager v5.1, customers can set power caps on groups of supported servers. The IPM software statically allocates the group power cap among the servers in the group. The group cap is allocated equitably among all servers in the group based on a calculation using the idle and maximum measured power consumption of each server. In addition, IPM can track and graph over time the actual power usage of groups of servers and enclosures. This provides data center facilities managers with measured power consumption for various time periods, reducing the need to install monitored PDUs to measure actual power usage in data centers.

Interconnect options and infrastructure

The BladeSystem enclosures easily enable connecting the ports of embedded devices to the interconnect bays. The c3000 Enclosure signal midplane (Figure 9) acts as a PCI Express (PCIe) bus connecting interconnect ports on blade devices to interconnect modules. It has eight device bay signal connectors (one for each half-height server blade and two for each full-height server blade) and four interconnect module connectors (one for each interconnect bay). The device connections are in groups of lanes. Each lane is a group of four pins (two sending traces and two receiving traces), resulting in full-duplex communication. This combination provides a 1x (500Mb/s) transfer rate with 2x = 2 lanes (1Gb/s).

Figure 9. Diagram of the HP BladeSystem c3000 signal midplane

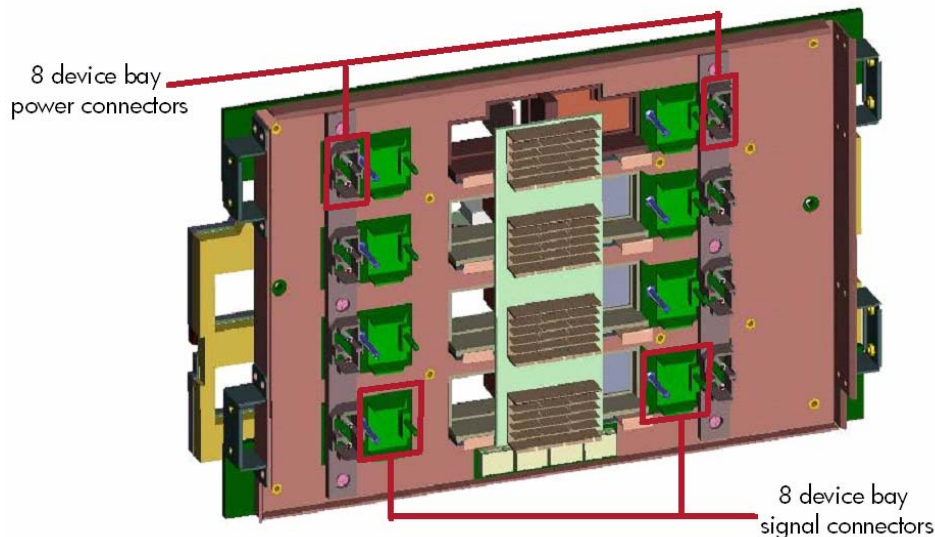

By taking advantage of the similar four-wire differential transmit and receive mechanism, the signal midplane can support either network-semantic protocols (for example, Ethernet, Fibre Channel, and InfiniBand) or memory-semantic protocols (PCIe), using the same signal traces. Figure 10 illustrates how the physical lanes can be logically "overlaid" onto sets of four traces. Interfaces such as Gigabit Ethernet (1000-base-KX) or Fibre Channel need only a 1x lane, or a single set of 4 traces. Higher bandwidth interfaces, such as InfiniBand DDR, will need to use up to four lanes.

Figure 10. Traces on the signal midplane can transmit many different types of signals, depending on which interconnect fabrics are used. The right-hand side of the diagram represents how the signals can be “overlaid” onto the same traces.

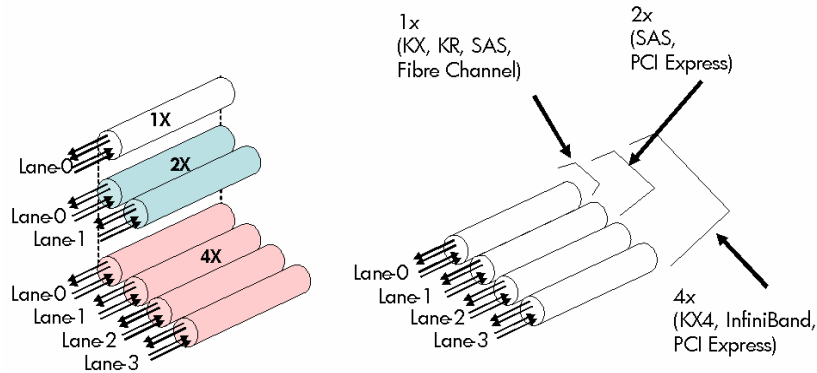

Each device bay signal connector has a 100-pin connector with 64 high-speed signal pins hard-wired from the device bay connector to the interconnect bays. This results in 16 lanes ($64 \div 4$) to each interconnect bay. This provides at least two lanes to each interconnect port for connectivity to LAN, storage area network (SAN), InfiniBand, or any other interconnect type. Full-height servers occupy two half-height device bays and therefore have up to 32 lanes available.

A single lane supports up to 10-Gb signals, depending on the protocol requirement. Each lane provides the flexibility of 1x, 2x, or 4x connections from the server blade mezzanine cards, which provide connectivity to the interconnect bays. The rear of the enclosure includes four interconnect bays that can accommodate four single or two redundant interconnect modules. All interconnect modules plug directly into these interconnect bays. Each HP BladeSystem c3000 Enclosure requires two interconnect switches or two pass-thru modules, side-by-side, for a fully redundant configuration.

Fabric connectivity and port mapping

Each enclosure requires interconnects to provide network access for data transfer. The interconnects reside in interconnect bays located on the rear of the enclosure (Figure 11). The server blades and enclosure support up to three independent interconnect fabrics, such as Ethernet, Fibre Channel, InfiniBand, and Virtual Connect modules.

Figure 11. HP BladeSystem c3000 interconnect bay numbering

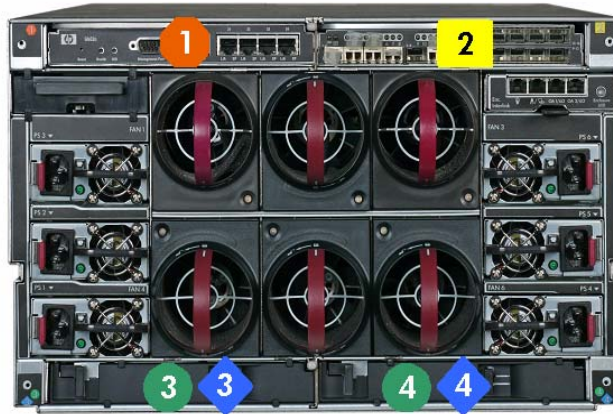

Server blade signal	Interconnect bay	Interconnect bay label
NIC 1, 2, 3, 4 (embedded)	1	● – Orange hexagon
Mezzanine 1	2	■ – Yellow square
Mezzanine 2	3 and 4	● – Green circle
Mezzanine 3	3 and 4	◆ – Blue diamond

For interconnect bay mapping purposes, it does not matter in which device bay a server blade is installed. The mezzanine connectors always connect to the same interconnect bays. Because the connections between the device bays and the interconnect bays are hard-wired through the signal midplane, the server mezzanine cards must be matched to the appropriate type of interconnect module. For example, a Fibre Channel mezzanine card must be placed in the mezzanine connector that connects to an interconnect bay holding a Fibre Channel switch.

Embedded NICs and adapters installed in Mezzanine 1 are supported by single-wide interconnects in interconnect bays 1 and 2 respectively. Mezzanine 2 and 3 can be supported by either single-wide or double-wide interconnects such as InfiniBand or 10 Gb Ethernet devices in interconnect bays 3 and 4. To simplify the installation of the various mezzanine cards and interconnect modules, the Onboard Administrator uses an electronic keying process to detect any mismatch between the mezzanine cards and the interconnect modules.

An internal connection on the midplane between interconnect bays 1 and 2 and an additional connection between interconnect bays 3 and 4 provide an internal link for use as a crosslink port between interconnect bays 1 and 2 or interconnect bays 3 and 4. NIC teaming can be configured between embedded NICs and Mezzanine 1 NICs using the internal crosslinks between the switches through this internal connection.

Several port types are referenced in Figures 12 and 13:

- Examples of 1x ports are 1-Gb Ethernet (1-GbE) pass-thru modules and Fibre Channel interconnect modules.
- An example of a 2x port is a SAS interconnect module.
- Examples of 4x ports are 10-GbE pass-thru modules and InfiniBand interconnect modules.

A full-height server blade plugs into two device bay connectors and has 32 lanes available to the 4 interconnect bays (16 lanes x 2x in Figure 12). Interconnect bay 1 is reserved for Ethernet interconnects. It connects embedded Ethernet NICs to the internal facing ports on the Ethernet























interconnect. Depending on the configuration requirements, additional mezzanine cards and interconnects can be populated in:

- Mezzanine 1 and Interconnect Bay 2
- Mezzanine 2 and Interconnect Bays 3 and 4
- Mezzanine 3 and Interconnect Bays 3 and 4

The full-height server blade has four embedded NICs and can accept up to three additional mezzanine cards. Each embedded NIC and optional mezzanine port is mapped through the signal midplane to specific ports on interconnect bays. A full-height server blade installed in device bay 1 would have NICs mapped in the following manner:

- NIC 1 (PXE default) — Interconnect bay 1 port 5
- NIC 2 — Interconnect bay 1 port 13
- NIC 3 — Interconnect bay 1 port 1
- NIC 4 — Interconnect bay 1 port 9













Figure 12. Port mapping for HP BladeSystem c3000 full-height server blades to interconnect bays

Full-height server bay = n (1-4)	Interconnect bay	Interconnect bay port (server facing port numbers)
x4 NIC 1  NIC 2  x4 NIC 3  NIC 4 	 Interconnect 1	Port = N+4
	 Interconnect 1	Port = N+12
	 Interconnect 1	Port = N
	 Interconnect 1	Port = N+8
Mezz 1 x4  Port 1 Port 2 Port 3 Port 4	 Interconnect 2	Port = N
	 Interconnect 2	Port = N+8
	 Interconnect 2	Port = N+4
	 Interconnect 2	Port = N+12
Mezz 2 x8  Port 1 Port 2 Port 3 Port 4	 Interconnect 3	Port = N
	 Interconnect 4	Port = N
	 Interconnect 3	Port = N+8
	 Interconnect 4	Port = N+8
Mezz 3 x8  Port 1 Port 2 Port 3 Port 4	 Interconnect 3	Port = N+12
	 Interconnect 4	Port = N+12
	 Interconnect 3	Port = N+4
	 Interconnect 4	Port = N+4

Half-height server blades connect to a single power and signal connector on the signal midplane. The remaining signal connector is allocated to the adjacent device bay (that is, device bays 1 and 5). As a result, half-height server blades do not support four-port mezzanine cards on connector 1, and they do not contain a Mezzanine 3 connector. The extra lanes on the signal midplane are allocated to the adjacent device bay. A four-port PCIe x8 mezzanine card installed in connector 2 PCIe x8 can send x2 signals to interconnect bays 3 and 4.

Figure 13 lists the available configurations for half-height devices installed in device bay N (1–8).

Figure 13. Port mapping for HP BladeSystem c3000 half-height server blades to interconnect bays

Half-height server bay = n (1-8)	Interconnect bay	Interconnect bay port (server facing parts)
x4 NIC 1  NIC 2 	 Interconnect 1	Port = N
	 Interconnect 1	Port = N+8
Mezz 1  x4 Port 1 Port 2	 Interconnect 2	Port = N
	 Interconnect 2	Port = N+8
Mezz 2  x8 Port 1 Port 2 Port 3 Port 4	 Interconnect 3	Port = N
	 Interconnect 4	Port = N
	 Interconnect 3	Port = N+8
	 Interconnect 4	Port = N+8

Port mapping differs slightly between full-height and half-height server blades due to the support for additional mezzanine cards on the full-height version. HP has simplified the process of mapping mezzanine ports to switch ports by providing intelligent management tools through the Onboard Administrator and HP Insight Manager software.

Virtual Connect

With the c-Class architecture, HP introduced a new type of interconnect technology: Virtual Connect. As it is implemented in c-Class architecture, Virtual Connect technology provides virtualized server connections to the Ethernet (LAN) or Fibre Channel (SAN) networks. Virtual Connect technology virtualizes the server-edge so that networks can communicate with pools of HP BladeSystem server blades instead of the conventional one-to-one relationship.

Virtual Connect consists of hardware (the Virtual Connect module) and a management agent that runs on the Virtual Connect module. Like Ethernet and Fibre Channel switches, the Virtual Connect modules slide into the interconnect bays of the c3000 Enclosure. The Ethernet module is necessary to install Fibre Channel because the Virtual Connect Manager software runs on a processor on the Ethernet module. The Ethernet module has sixteen 1-GbE downlinks to servers (connected across the signal midplane), eight 1-GbE uplinks to the network (RJ-45 copper Ethernet connectors), two 10-GbE connectors (for copper CX4 cables), and one 10-GbE internal inter-switch link (across the signal midplane) for a failover connection between Virtual Connect modules. The Fibre Channel module has sixteen 4-Gb Fibre Channel downlinks to servers and four 1/2/4-Gb auto-sensing Fibre Channel uplinks to the network.

Virtual connect Ethernet modules can be used in interconnect bays 1, 2, 3 and 4 when Ethernet mezzanine cards are used in the appropriate mezzanine slot on the server blade. Virtual Connect Fibre Channel modules can only be used in interconnect bays 3 and 4 and require a Fibre Channel mezzanine card in Mezzanine slot 2 or 3 in the server blade.

Full details about Virtual Connect technology are available in the technology brief entitled “HP Virtual Connect technology implementation for the HP BladeSystem c-Class” on the HP technology website at www.hp.com/servers/technology.

Enclosure-based DVD ROM

The HP BladeSystem c3000 Enclosure has an optional CD/DVD ROM drive that installs in the front of the enclosure. The Insight Display and Onboard Administrator allow system administrators to connect and disconnect the media device to one or multiple servers at a time. In addition, a browser-based console is available through the iLO functionality of each server blade. The console enables administrators to:

- Use HP SmartStart to install system software and operating systems
- Install additional software
- Perform critical OS updates and patches
- Update server platform ROMs

The enclosure-based CD/DVD offers local drive access to server blades by using the Onboard Administrator or Insight Display. When media is loaded in the enclosure-based DVD ROM, local administrators can use the Insight Display to attach the media device to one or multiple server blades simultaneously. When the DVD Connect Status screen is displayed on the Insight Display, choosing to connect the media device to a server or group of servers prompts the user to connect or to connect and reboot the server.

When it is connected and no read operations have occurred in the last 16 seconds, the media device can be disconnected from server blades.

Onboard Administrator

The Onboard Administrator is a management controller module that resides within the HP BladeSystem c3000 Enclosure. The Onboard Administrator works with the iLO 2 management processors on each server blade to form the core of the management architecture for HP BladeSystem c-Class.

Unique to the BladeSystem c-Class, the Onboard Administrator is the enclosure management processor, subsystem, and firmware base used to support the c7000 Enclosure, the c3000 Enclosure, and all the managed devices contained within these enclosures. It provides a secure single point of contact for users performing basic management tasks on server blades or switches within the enclosure. It is fully integrated into all HP system management applications.

The Onboard Administrator module offers web-based and command line interface (CLI) manageability. It drives all management features through two interfaces:

- Inter-Integrated Circuit (I2C) — Through an I2C master, the Onboard Administrator controls and monitors all data and interrupts with every subsystem in the infrastructure and in each server. All subsystems have electrically erasable programmable read-only memory (EEPROM) to store field-replaceable unit (FRU) data. The Onboard Administrator provides I2C to fans, power supply modules, and interconnect and device bays.
- Intelligent Chassis Management Bus (ICMB) — Through ICMB, the Onboard Administrator shares information (for example, power and rack location) with the other infrastructure management modules at the rack level.

The Onboard Administrator aggregates up to eight iLO 2 ports in a c3000 Enclosure, simplifying cable management and providing a graphical interface to launch individual server iLO management interfaces.

The rear of each module has an LED (blue unit identification) that can be enabled locally or remotely and can be used to identify the enclosure from the back of the rack.

The c3000 Enclosure currently supports one Onboard Administrator module. Enclosure devices continue to operate normally in the event of a hardware failure or removal; however, management capabilities of the enclosure are lost. Enclosure fans run at full speed to ensure adequate cooling when no Onboard Administrator is present.

Onboard Administrator collects system parameters related to thermal and power status, system configuration, and managed network configuration. It manages these variables cohesively and intelligently so that IT personnel can configure the HP BladeSystem c-Class and manage it in a fraction of the time that other solutions require.

Onboard Administrator retrieves thermal information from the components in the enclosure. If the enclosure's thermal load increases, the Onboard Administrator's thermal logic feature instructs the fan controllers to increase fan speeds to accommodate the additional demand. Individual fan speeds can be adjusted to reduce noise and power consumption, and to compensate for airflow differences within the enclosure. Performance of each subsystem is proactively monitored, and any failures or warnings can be reported to the system log and to broader infrastructure management tools such as HP Systems Insight Manager (when SNMP is enabled). The Onboard Administrator manages subsystem failure by taking appropriate action, including adjusting fan speed or reducing power consumption, to maintain the enclosure's ability to operate.

The Onboard Administrator uses sophisticated power measurement sensors to accurately monitor exactly how much power is being consumed and how much power is available. Because Onboard Administrator uses real-time measured power data instead of maximum power envelopes, customers can deploy as many servers and interconnect modules as possible for the available power.

Onboard Administrator includes logic to manage multiple enclosures in a rack. The Onboard Administrator allows single-point access for up to four enclosures. Thus, an IT administrator can use a single sign-on to log into a single Onboard Administrator and use the web GUI to graphically view and manage all the c-Class components within the linked enclosures. For example, an IT administrator could automatically propagate management commands—such as putting an upper limit on power levels for all server blades—throughout the linked enclosures.

A major advantage of the HP BladeSystem c-Class is its configuration flexibility. The configuration logic resides in the management controller module in the front of the enclosure. The Onboard Administrator module communicates with the iLO 2 management processor on each server blade to form the core of the management architecture for HP BladeSystem c-Class. The configuration logic powers up the interconnect modules first. Server blades are not powered up until the Onboard Administrator has verified that the configuration is correct. If there is a configuration issue, the Insight Display identifies the issue and possible remedies.

To assist IT administrators in the configuration and setup process, the Onboard Administrator verifies four attributes for each server blade and interconnect module as they are added to the enclosure:

- **Electronic keying**—The Onboard Administrator automatically queries all mezzanine cards and interconnect modules as they are deployed to check whether the interconnect fabric types match. If they do not, the Onboard Administrator issues a warning with suggested corrective action.
- **Power**—The Onboard Administrator ensures that sufficient power is available to power up a server blade or interconnect module.

- Cooling—The Onboard Administrator makes sure there is sufficient cooling capacity for the server blade or interconnect module by retrieving thermal information from all of the server blades, power supplies, Active Cool fans, and interconnect modules in the enclosure.
- Location—The Onboard Administrator checks the locations of server blades, Active Cool fans, and power supplies to determine if they are placed to receive proper cooling and to support the chosen power configuration.

If a configuration problem exists, the Onboard Administrator gives diagnostic help so that the IT technician can easily determine the problem by looking at the Insight Display.

The Onboard Administrator significantly enhances network infrastructure management by offering two methods to initially configure the IP addresses of the server blade iLO 2 ports and the interconnect module management ports through the management network: DHCP or Enclosure Bay Static IP Addressing. This configuration capability is managed through a single point, the Onboard Administrator, rather than managing each iLO or interconnect module individually.

There are three ways for IT technicians and administrators to access the Onboard Administrator:

- The Insight Display
- The web GUI
- A command-line interface (CLI)

More information about the Onboard Administrator is available in the technology brief entitled “Managing the HP BladeSystem c-Class” at this URL:

<http://h18004.www1.hp.com/products/servers/technology/whitepapers/proliant-servers.html>.

Insight Display

The Insight Display (Figure 14) is an ever-ready, rack-mounted information exchange device with access to all of the Onboard Administrator setup, management, and troubleshooting information. It simplifies initial enclosure configuration. It also provides information about the health and operation of the enclosure. The device is big enough to display ample information, yet can be tucked away inside the enclosure when not in use.

Figure 14. Insight Display Main Menu and Enclosure Settings menu



When the enclosure is powered up for the first time, the Insight Display launches an installation wizard to guide the user through the configuration process. To identify the enclosure being configured, the enclosure UID LED and the background of the Insight Display are illuminated blue when the enclosure is initially powered on. The Installation Wizard automatically turns on the enclosure UID at the beginning of the installation and turns it off when the installation is complete. After configuring the enclosure, the Insight Display verifies that there are no installation or configuration errors.

More information about the Insight Display is available in the technology brief entitled "Managing the HP BladeSystem c-Class" at this URL:

<http://h18004.www1.hp.com/products/servers/technology/whitepapers/proliant-servers.html>.

Web GUI

The web GUI uses event-driven, push technology. No screen refresh is necessary to view failures or events. If an event occurs, it is pushed to the web GUI and updated immediately. The GUI provides seamless integration with HP OpenView, Insight Control Data Center Edition, and Insight Control Linux® Edition.

Command-line interface

Administrators who commonly use scripting commands can access the Onboard Administrator this way.

Onboard Administrator cabling

The standard Onboard Administrator module is preinstalled in a front-loading tray that also houses the HP BladeSystem Insight Display. The Onboard Administrator module contains a serial connector for connection to a PC with a null-modem RS232 serial cable. A USB connector is also available for future USB connectivity. A separate rear-loading Onboard Administrator link module contains RJ-45 ports for enclosure link-up/link-down connectivity and Onboard Administrator network access (Figure 15).

Figure 15. HP BladeSystem c3000 Onboard Administrator module

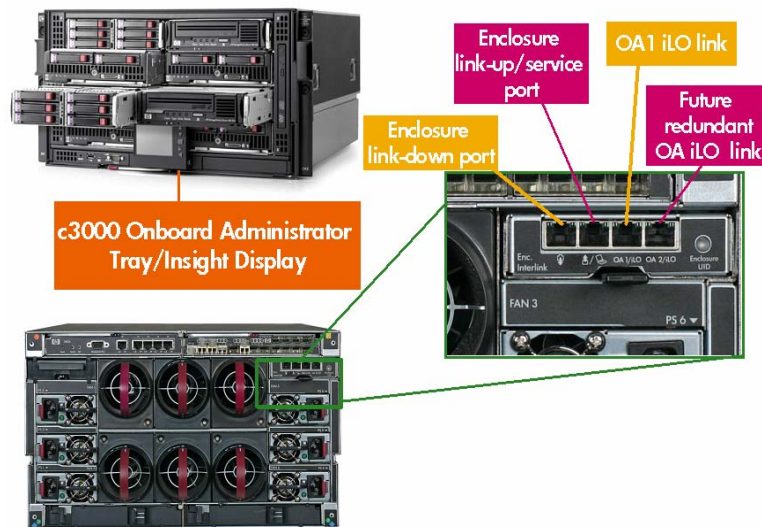

Enclosure link cabling

The Onboard Administrator link module contains two enclosure link ports to allow any active Onboard Administrator module to access linked enclosures. On a standalone enclosure or top enclosure in a series of linked enclosures, the top enclosure link-up port functions as a service port for temporary connection to a PC with a CAT5 patch cable. It provides quick access to any Onboard Administrator module, iLO 2, or interconnect module with Ethernet management ability.

The enclosure link-down port connects to the enclosure link-up port on the enclosure below it. The enclosure link-up port connects to the enclosure link-down port on the enclosure above it. Linking the enclosures enables the rack technician to access all the enclosures through the open link-up/service port. If more c-Class enclosures are added to the rack, they can be linked through the open enclosure link-up port on the top enclosure or the link-down port on the bottom enclosure.

NOTE

The enclosure link ports are designed only to support c-Class enclosures in the same rack. The enclosure link-down port on the top enclosure is the service port. The enclosure link-down port on the bottom linked enclosure is unused.

IMPORTANT

The HP BladeSystem c-Class enclosure link ports are not compatible with the HP BladeSystem p-Class enclosure link ports.

Recommendations

HP recommends the following for configuring BladeSystem c-Class enclosures:

- Use Virtual Connect or managed switches to reduce cabling and management overhead.
- Use the HP BladeSystem Power Sizer.
- For all server blades other than BL685c, the InfiniBand 4x DDR single-port mezzanine card will work in Mezzanine 1, but it will work better in Mezzanine 2 or Mezzanine 3. For BL685c, the InfiniBand 4x DDR single-port mezzanine card will work equally well in Mezzanine 1, Mezzanine 2, or Mezzanine 3 connectors.
- The *HP BladeSystem c-Class Solution Overview* might indicate to install the Onboard Administrator into the rear of the enclosure. This information applies to only the HP BladeSystem c7000 Enclosure. Install the Onboard Administrator module into the front of the HP BladeSystem c3000 Enclosure.

Summary

The HP BladeSystem c3000 Enclosure is the next generation of a new modular computing architecture that consolidates and simplifies infrastructure, reduces operational cost, and delivers IT services more effectively. The c3000 Enclosure is designed for remote sites, small and medium-sized businesses, and data centers with special power and cooling constraints. Thermal Logic technologies provide the mechanical design features, built-in intelligence, and control capabilities throughout the BladeSystem c-Class that enable IT administrators to make the most of the power and thermal environments. The shared, high-speed midplane and pooled-power backplane in the enclosure accommodate new bandwidths and new technologies. The Onboard Administrator supplies an intelligent infrastructure to provide essential power and cooling information and help automate the management of the infrastructure. The BladeSystem c3000 Enclosure provides all the power, cooling, and infrastructure to support c-Class modular servers, interconnects, and storage components, today and throughout the next several years.

Appendix A. Acronyms in text

The following acronyms are used in the text of this document.

Table A-1. Acronyms

Acronym	Acronym expansion
AC	Alternating current
BTU	British thermal unit
CFM	Cubic feet per minute
CLI	Command line interface
DC	Direct current
DDR	Double data rate
FC	Fibre Channel
IB	InfiniBand
iLO	Integrated Lights Out
iSCSI	Internet Small Computer System Interface
KVM	Keyboard, video, mouse
LAN	Local area network
LED	Light emitting diode
NIC	Network interface card
OA	Onboard Administrator
PARSEC	Parallel, redundant, scalable enclosure cooling
PCIe	PCI Express
PDU	Power distribution unit
PSU	Power supply unit
SAN	Storage area network
SAS	Serial attached SCSI
U	Unit of measurement for rack-mount equipment (1U is 1.75 inches or 4.44cm)
UID	Unit identification
UPS	Uninterruptible power supply
VA	Volt-ampere
W	Watt

Appendix B. Fan, power supply, and device bay population guidelines

Figure B-1. HP BladeSystem c3000 Enclosure – Fan population guidelines. For correct operation, fans and server blades must be installed in the correct fan bays. The Onboard Administrator will ensure that fans and server/storage blades are correctly placed before allowing systems to power on.

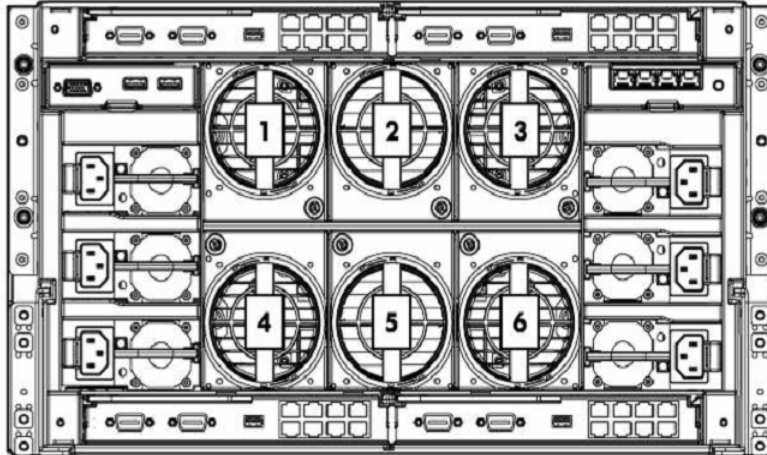

Base BladeSystem c3000 Enclosures ship with four fans installed, supporting up to four half-height devices or two full-height server blades. Adding two additional fans to the enclosure allows population with eight half-height devices or four full-height server blades.

- Four-fan configuration requires population of fan bays 2, 4, 5, and 6.
- Six-fan configuration enables population of all fan bays.

In a four-fan configuration the Onboard Administrator prevents blade devices in device bays 3, 4, 7, and 8 from powering on and identifies the fan subsystem as degraded. To populate blade devices in these device bays, populate c3000 Enclosures with six Active Cool fans.

Figure B-2. HP BladeSystem c3000 Enclosure – Power supply population guidelines

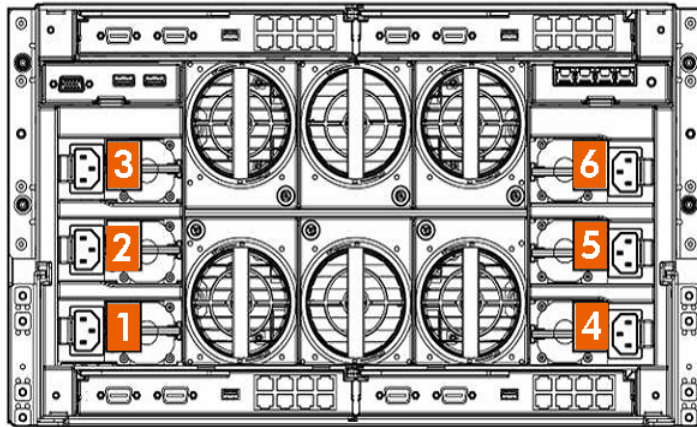

Table B-1. Power supply placement

Number of power supplies	Power supply bays used
2	1 and 4
4	1, 2, 4, and 5
6	All power supply bays filled

Table B-2. Power supply redundancy options

Number of power supplies	Power supply bays used
1+1	1 and 4
2+1	1, 4, and 2
3+1	1, 4, 2, and 5
4+1	1, 4, 2, 5, and 3
5+1	Populate all power supply bays

Table B-3. AC redundancy options

Number of power supplies	Power supply bays used
1+1	1 and 4
2+2	1, 2, 4, and 5
3+3	Populate all power supply bays

Figure B-3. HP BladeSystem c3000 Enclosure – Full-height server blade device bay numbering. Full-height servers should be populated from bottom to top when viewing from the front of the enclosure. With four fans, only the bottom two device bays can be used; with six fans, all device bays can be used.

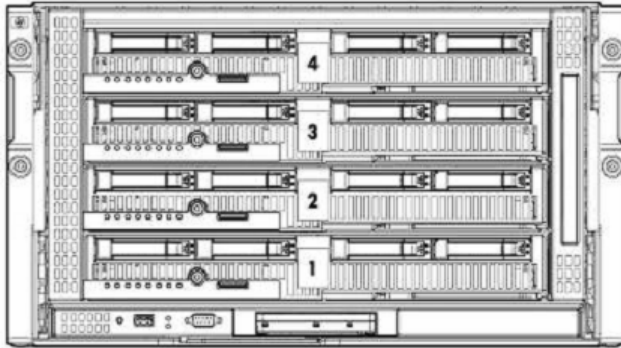
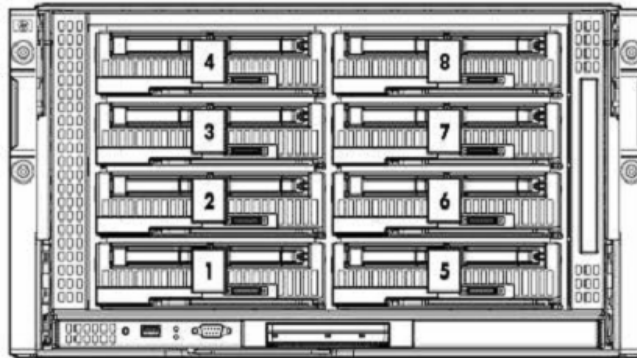

Figure B-4. HP BladeSystem c3000 Enclosure – Half-height server blade device bay numbering. Half-height servers should be populated from the bottom of the enclosure, in the following order: Device bays 1, 5, 2, 6, 3, 7, 4, 8.



IMPORTANT

When looking at the rear of the enclosure, device bay numbering is reversed.

CAUTION

To prevent improper cooling or thermal damage, do not operate the server blade or the enclosure unless all device bays are populated with either a component or a blank.

Figure B-5. The c3000 Enclosure is divided by sheet metal panels into 2 full-height zones. Each horizontal zone is divided vertically by a removable shelf to make a maximum of 8 half-height device bays. These zones reflect the PCIe bus mapping in the signal midplane and limit placement of the server blade/storage blade combination. The signal midplane has a direct PCIe link connecting adjacent paired device bays. Important: The server blade/storage blade relationship cannot extend horizontally beyond the vertical dividers between full height device bays, nor can it span the removable bay shelf dividing the zone into half-height device bays

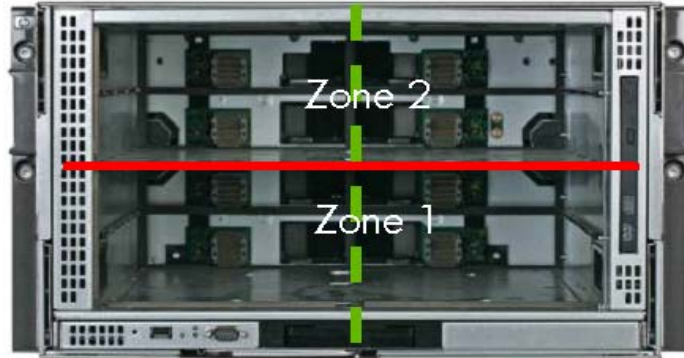

The enclosure comes preinstalled with removable full-height dividers between the top four device bays and the bottom four device bays. In addition, there is a half-height divider available for use between device bays 4 and 8 if the full-height divider is removed. Using these combinations of dividers, the following combinations of server blades can be installed:

- 8 half-height server blades with both full-height dividers installed
- 4 full-height server blades with both full-height dividers removed
- 4 half-height server blades in the bottom half of the enclosure with 1 full-height divider installed
- 2 full-height server blades in the bottom half of the enclosure with 1 full-height divider removed
- 4 half-height server blades in the top half with 1 full-height divider installed
- 2 full-height server blades in the top half with 1 full-height divider removed
- 1 full-height server blade and 2 half-height server blades in the top half with 1 full-height divider removed and the half-height divider installed

CAUTION

If a full-height server blade is installed in device bay 1/5 and half-height server blades are installed in device bays 2 or 6, removing the full-height server blade leaves server blades installed in device bays 2 and 6 unsupported. This might cause damage to the server blades and the enclosure connectors.

Removing the full-height divider in the bottom half of the enclosure allows only full-height server blades to be installed in the bottom half of the enclosure.

Removing the full-height divider in the top half of the enclosure requires either installing only full-height server blades in the top half of the enclosure or installing the half-height divider between device bays 4 and 8. Installing the half-height divider enables installation of two half-height devices (two server blades, one companion blade and one server blade, or one blade blank and one companion blade or server blade) in device bays 4 and 8 and 1 full-height server blade in device bay 3/7.

When installing a companion blade (HP StorageWorks SB40c Storage Blade, HP PCI Expansion Blade, or HP StorageWorks Ultrium 448c Tape Blade), the companion blade can be installed in either of the paired device bays (1/2, 3/4, 5/6, or 7/8) with a half-height server blade installed in the other paired device bay.

To install a companion blade with a full-height server blade, the companion blade must be installed in device bay 8 with the full-height server blade installed in device bay 3/7. The half-height divider must be installed between device bays 4 and 8, and either a blade blank or a half-height server blade can be installed in device bay 4.

For more information

For additional information, refer to the resources listed below.

Resource description	Web address
General HP BladeSystem information	http://www.hp.com/go/bladesystem/
HP BladeSystem c-Class documentation	http://h71028.www7.hp.com/enterprise/cache/316735-0-0-121.html
HP BladeSystem c3000 Enclosure Maintenance and Service Guide	http://h20000.www2.hp.com/bc/docs/support/SupportManual/c01126895/c01126895.pdf
HP BladeSystem c3000 Enclosure QuickSpecs	http://h18004.www1.hp.com/products/quickspecs/12790_div/12790_div.html
HP BladeSystem Onboard Administrator User Guide	http://h20000.www2.hp.com/bc/docs/support/SupportManual/c00705292/c00705292.pdf
HP BladeSystem c-Class interconnects	www.hp.com/go/bladesystem/interconnects
Technology briefs about HP BladeSystem	http://h18004.www1.hp.com/products/servers/technology/whitepapers/proliant-servers.html
HP BladeSystem Power Sizer	http://www.hp.com/go/bladesystem/powercalculator
HP BladeSystem c-Class firmware compatibility matrix	http://www.hp.com/go/bladesystemupdates

Call to action

Send comments about this paper to TechCom@HP.com.

© 2007 Hewlett-Packard Development Company, L.P. The information contained herein is subject to change without notice. The only warranties for HP products and services are set forth in the express warranty statements accompanying such products and services. Nothing herein should be construed as constituting an additional warranty. HP shall not be liable for technical or editorial errors or omissions contained herein.

Intel and Xeon are trademarks or registered trademarks of Intel Corporation in the U.S. and other countries and are used under license.

Linux is a U.S registered trademark of Linus Torvalds.

TC071001TB, October 2007



Free Manuals Download Website

<http://myh66.com>

<http://usermanuals.us>

<http://www.somanuals.com>

<http://www.4manuals.cc>

<http://www.manual-lib.com>

<http://www.404manual.com>

<http://www.luxmanual.com>

<http://aubethermostatmanual.com>

Golf course search by state

<http://golfingnear.com>

Email search by domain

<http://emailbydomain.com>

Auto manuals search

<http://auto.somanuals.com>

TV manuals search

<http://tv.somanuals.com>