



1910, 2010, 2210, 2310, 2510, and 2710 LCD Monitors

User Guide

© 2010 Hewlett-Packard Development
Company, L.P.

Microsoft, Windows, and Windows Vista are either trademarks or registered trademarks of Microsoft Corporation in the United States and/or other countries.

The only warranties for HP products and services are set forth in the express warranty statements accompanying such products and services. Nothing herein should be construed as constituting an additional warranty. HP shall not be liable for technical or editorial errors or omissions contained herein.

This document contains proprietary information that is protected by copyright. No part of this document may be photocopied, reproduced, or translated to another language without the prior written consent of Hewlett-Packard Company.

Second Edition (January 2010)

Document Part Number: 594300-002

About This Guide

This guide provides information on setting up the monitor, installing drivers, using the on-screen display menu, troubleshooting and technical specifications.

- ⚠ **WARNING!** Text set off in this manner indicates that failure to follow directions could result in bodily harm or loss of life.
- ⚠ **CAUTION:** Text set off in this manner indicates that failure to follow directions could result in damage to equipment or loss of information.
- 📝 **NOTE:** Text set off in this manner provides important supplemental information.

Table of contents

1 Product Features	1
HP LCD Monitors	1
2 Safety and Maintenance Guidelines	3
Important Safety Information	3
Safety Precautions	4
Maintenance Guidelines	5
Cleaning the Monitor	5
Shipping the Monitor	5
3 Setting Up the Monitor	7
Unpacking the Monitor	7
Installing the Monitor	7
Connecting Monitor Cables	11
High-Bandwidth Digital Content Protection (HDCP)	12
Connecting the Audio Cable	13
Connecting the Power Cable	14
Adjusting The Tilt	14
Adjusting the Swivel	15
Keyboard Parking	16
4 Operating the Monitor	17
CD Software and Utilities	17
Installing Drivers	17
Using the Auto Adjustment Function	18
Front-Panel Controls	19
Using the On-Screen Display (OSD)	20
Selecting Video Input Connectors	25
Identifying Monitor Conditions	25
Adjusting Screen Quality	26
Power-Saver Feature	27

Appendix A Troubleshooting	28
Solving Common Problems	28
Getting Support from hp.com	29
Preparing to Call Technical Support	29
Locating the Rating Label	30
Appendix B Technical Specifications	31
HP LCD Monitors	31
Preset Video Modes	35
LCD Monitor Quality and Pixel Policy	36
Appendix C Agency Regulatory Notices	38
Federal Communications Commission Notice	38
Modifications	38
Cables	38
Declaration of Conformity for Products Marked with the FCC Logo (United States Only)	38
Canadian Notice	39
Avis Canadien	39
European Union Regulatory Notice	39
German Ergonomics Notice	40
Japanese Notice	40
Korean Notice	40
Power Cord Set Requirements	40
Japanese Power Cord Requirements	41
Product Environmental Notices	41
Materials Disposal	41
Disposal of Waste Equipment by Users in Private Household in the European Union	41
Chemical Substances	41
HP Recycling Program	42
Restriction of Hazardous Substances (RoHS)	42
Turkey EEE Regulation	43

1 Product Features

HP LCD Monitors

The HP LCD (liquid crystal display) monitors have an active matrix, thin-film transistor (TFT) screen with the following features:

- Large diagonal display
- Maximum graphics resolution:
 - 1910m: 1366 x 768 @ 60Hz
 - 2010f: 1600 x 900 @ 60Hz
 - 2010i: 1600 x 900 @ 60Hz
 - 2010m 1600 x 900 @ 60Hz
 - 2210i: 1920 x 1080 @ 60Hz
 - 2210m: 1920 x 1080 @ 60Hz
 - 2310i: 1920 x 1080 @ 60Hz
 - 2310m: 1920 x 1080 @ 60Hz
 - 2510i: 1920 x 1080 @ 60Hz
 - 2710m: 1920 x 1080 @ 60Hz
 - Plus full-screen support for lower resolutions
- VGA analog signal
- DVI digital signal
- High-definition multimedia interface (HDMI) (select models)
- Fast response time, providing better experience for hardcore gaming and graphics
- Easy viewing from a sitting or standing position, or while moving from one side of the monitor to the other
- Dynamic Contrast Ratio to provide deeper blacks and brighter whites for brilliant shading effects while gaming or watching movies
- Tilt adjustment
- Swivel adjustment

- Removable base and Video Electronics Standards Association (VESA) standard mounting holes for flexible mounting solutions, including wall-mounting
- Security lock slot for a locking security cable (security cable sold separately)
- Plug and Play capability, if supported by your computer system
- On-screen display (OSD) adjustments for ease of setup and screen optimization (choose English, Simplified Chinese, Traditional Chinese, French, German, Italian, Spanish, Dutch, Japanese, or Brazilian Portuguese)
- Built-in stereo speakers, downward firing
- Keyboard parking
- Power Saver to reduce energy consumption
- Quick View settings display
- HDCP (High Bandwidth Digital Content Protection) on DVI and HDMI inputs (selected models)
- Software and utilities CD, containing the following:
 - Drivers
 - Auto adjustment software
 - Documents

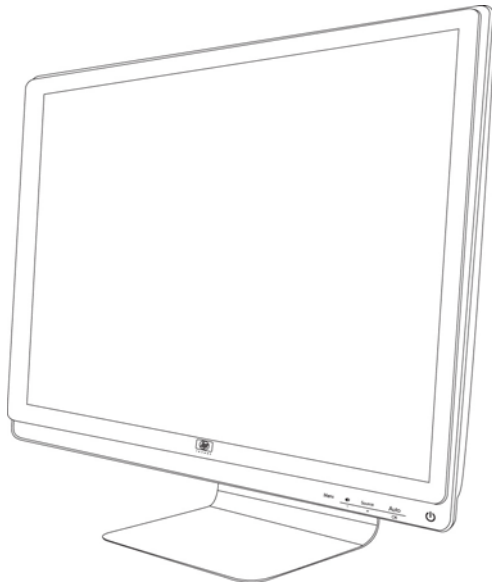

2 Safety and Maintenance Guidelines

Important Safety Information

A power cord is included with the monitor. If another cord is used, use only a power source and connection appropriate for this monitor. For information on the correct power cord set to use with the monitor, refer to the "Connecting the Power Cable" section in [Setting Up the Monitor on page 7](#).

⚠ **WARNING!** To reduce the risk of electric shock or damage to the equipment:

- Do not disable the power cord grounding feature. The grounding plug is an important safety feature.
- Plug the power cord in a grounded (earthed) outlet that is easily accessible at all times.
- Disconnect power from the product by unplugging the power cord from the electrical outlet.

For your safety, do not place anything on power cords or cables. Arrange them so that no one may accidentally step on or trip over them. Do not pull on a cord or cable. When unplugging from the electrical outlet, grasp the cord by the plug.

To reduce the risk of serious injury, read the *Safety and Comfort Guide*. It describes proper workstation, setup, posture, and health and work habits for computer users, and provides important electrical and mechanical safety information. This guide is located on the Web at <http://www.hp.com/ergo> and/or on the documentation CD, if one is included with the monitor.

⚠ **CAUTION:** For the protection of the monitor, as well as the computer, connect all power cords for the computer and its peripheral devices (such as a monitor, printer, scanner) to some form of surge protection device such as a power strip or Uninterruptible Power Supply (UPS). Not all power strips provide surge protection; the power strips must be specifically labeled as having this ability. Use a power strip whose manufacturer offers a Damage Replacement Policy so you can replace the equipment, if surge protection fails.

Use the appropriate and correctly sized furniture designed to properly support your HP LCD monitor.

⚠ **WARNING!** LCD monitors that are inappropriately situated on dressers, bookcases, shelves, desks, speakers, chests, or carts may fall over and cause personal injury.

Care should be taken to route all cords and cables connected to the LCD monitor so that they can not be pulled, grabbed, or tripped over.

Safety Precautions

- Use only a power source and connection compatible with this monitor, as indicated on the label/back plate of the monitor.
- Be sure the total ampere rating of the products connected to the outlet does not exceed the current rating of the electrical outlet, and the total ampere rating of the products connected to the power cord does not exceed the rating of the power cord. Look on the power label to determine the ampere rating (Amps or A) for each device.
- Install your monitor near a power outlet that you can easily reach. Disconnect the monitor by grasping the plug firmly and pulling it from the outlet. Never disconnect the monitor by pulling the cord.
- Do not allow anything to rest on the power cord. Do not walk on the cord.

Maintenance Guidelines

To enhance the performance and extend the life of the monitor:

- Do not open the monitor cabinet or attempt to service this product yourself. Adjust only those controls that are covered in the operating instructions. If the monitor is not operating properly or has been dropped or damaged, contact an authorized HP dealer, reseller, or service provider.
- Use only a power source and connection appropriate for this monitor, as indicated on the label/back plate of the monitor.
- Be sure the total ampere rating of the products connected to the outlet does not exceed the current rating of the electrical outlet, and the total ampere rating of the products connected to the cord does not exceed the rating of the cord. Look on the power label to determine the ampere rating (AMP or A) for each device.
- Install the monitor near an outlet that you can easily reach. Disconnect the monitor by grasping the plug firmly and pulling it from the outlet. Never disconnect the monitor by pulling the cord.
- Turn the monitor off when not in use. You can substantially increase the life expectancy of the monitor by using a screen saver program and turning off the monitor when not in use.
- Slots and openings in the cabinet are provided for ventilation. These openings must not be blocked or covered. Never push objects of any kind into cabinet slots or other openings.
- Do not drop the monitor or place it on an unstable surface.
- Do not allow anything to rest on the power cord. Do not walk on the cord.
- Keep the monitor in a well-ventilated area, away from excessive light, heat or moisture.
- When removing the monitor base, you must lay the monitor face down on a soft area to prevent it from getting scratched, defaced, or broken.

Cleaning the Monitor

1. Turn off the monitor and the computer.
2. Unplug the monitor from the wall outlet.
3. Clean the monitor plastics with a clean cloth dampened with water.
4. Clean the monitor screen with an antistatic screen cleaner.

△ **CAUTION:** Do not use benzene, thinner, ammonia, or any other volatile substances to clean the monitor or the screen. These chemicals may damage the cabinet finish as well as the screen.

Shipping the Monitor

Keep the original packing box in a storage area. You may need it later if you move or ship the monitor.

To prepare the monitor for shipping:

1. Disconnect the power, video, and audio cables from the monitor.
2. Set the monitor base on a soft, protected surface.

3. Hold the base with one hand, where it attaches to the rear of the monitor, and push the monitor forward, folding the monitor flat onto the soft, protected surface.
4. Place the monitor and base in the original packing box.

3 Setting Up the Monitor

Unpacking the Monitor

1. Unpack the monitor. Make sure all contents are included. Store the packing box.
2. Turn off the computer and other attached devices.
3. Determine whether the monitor will be desktop mounted or wall-mounted. See "Installing the Monitor" in this chapter.
4. Prepare a flat area to assemble the monitor. You may need a flat, soft, protected area for placing the monitor screen-down while preparing it for installation.
5. You need a Phillips screwdriver for preparing the monitor for wall-mounting. You may need a straight-slot screwdriver to secure some cables.

Installing the Monitor

You can install the monitor on a desktop or wall-mount it. Place the monitor in a convenient, well-ventilated location near your computer. Connect the monitor cables after you have installed the monitor.

 **NOTE:** For displays with glossy bezels the user should consider the placement of the display as the bezel may cause disturbing reflections from surrounding light and bright surfaces.

Preparing the monitor for desktop use

1. Set the monitor screen face down on a flat, soft, protected table or desk surface with the support column overhanging the edge.
- △ **CAUTION:** The screen is fragile. Avoid touching or applying pressure to the LCD screen; doing so can cause damage.

Figure 3-1 Unfolding the monitor

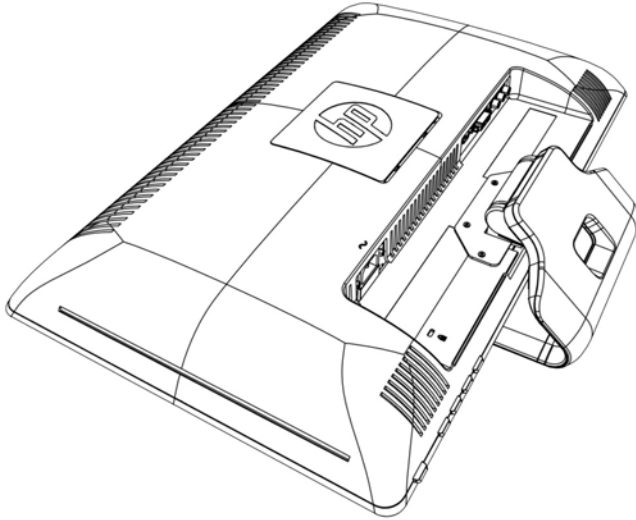

2. Grip the base near where it attaches to the monitor with one hand and lift the top part of the monitor until it is unfolded into the desired position.

Figure 3-2 Unfolding the monitor

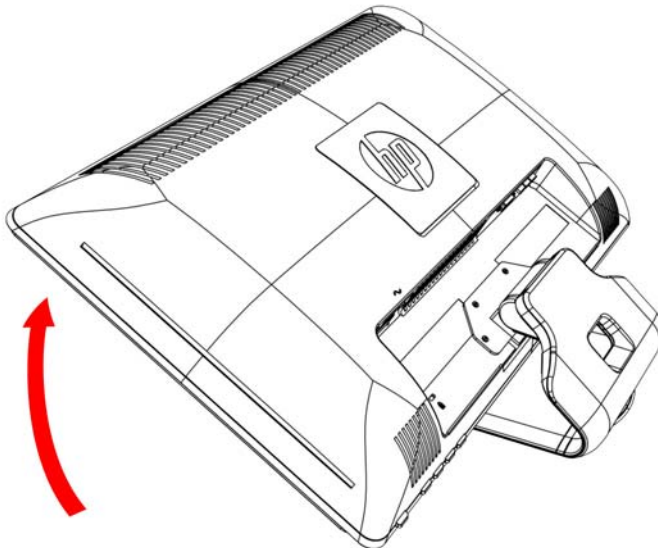

3. Lift the monitor to an upright position and place on a flat, stable surface.

Figure 3-3 Monitor in upright position

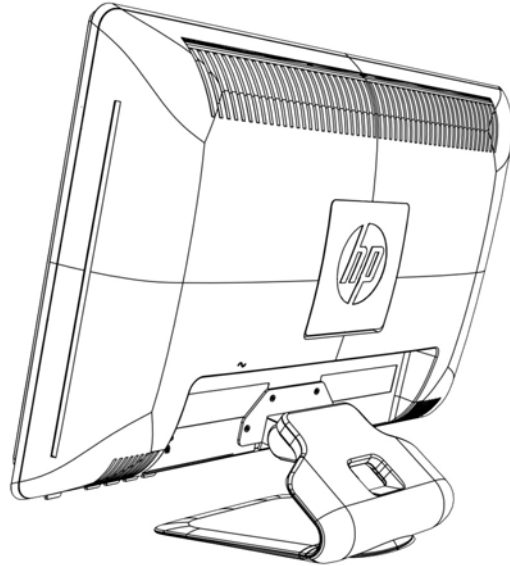

Preparing the monitor for wall-mounting

1. Check the stability of the wall-mounting fixture.

⚠ WARNING! To reduce the risk of personal injury or of damage to the equipment, check that the wall-mounting fixture is adequately installed and secured before attaching the monitor. Refer to the instructions supplied with the wall-mounting fixture and check that it is capable of supporting the monitor.

2. Disconnect the power cable and any other cables from the monitor.
3. Place the monitor face down on a flat, protected surface.
4. Remove the four screws that fasten the monitor base to the monitor.

Figure 3-4 Location of screws securing base to monitor

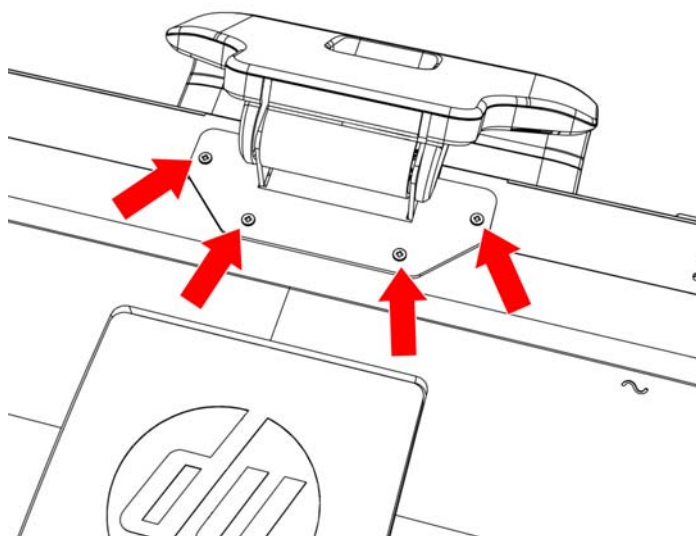

5. Slide the base away from the bottom of the monitor.

Figure 3-5 Sliding the base away from the monitor

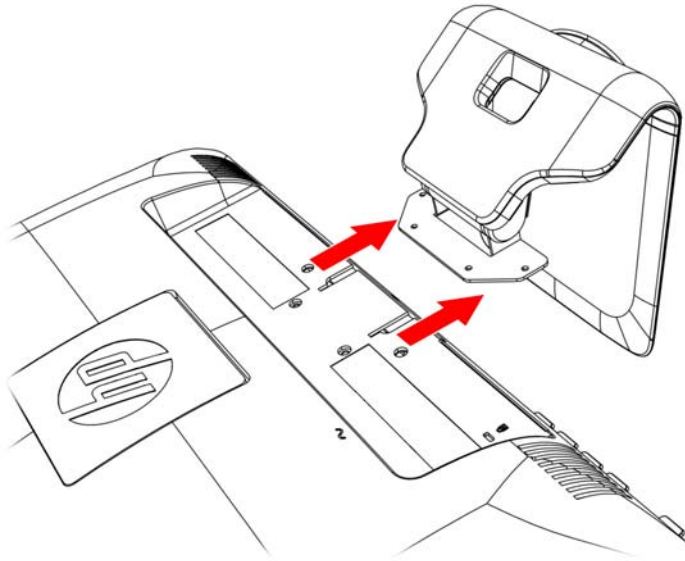

6. Remove the square plate on the back of monitor. Use a coin at the base of the plate to pry it loose.

Figure 3-6 Removing the plate from the back of the monitor

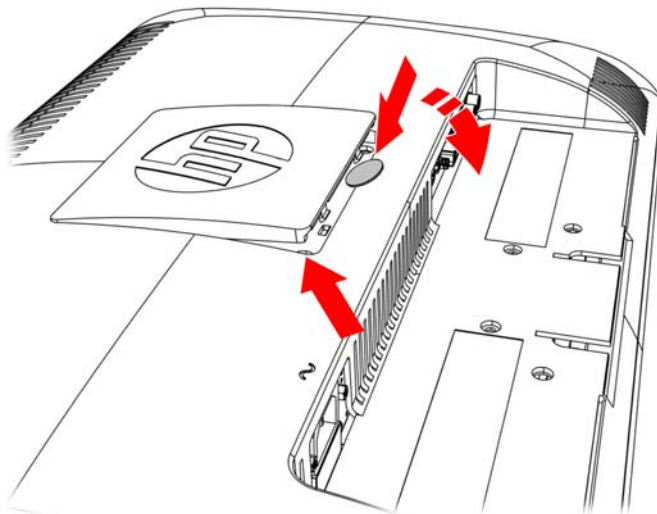

7. Four threaded holes are exposed. These holes are for screws to attach the swing arm or other mounting fixture to the back of the monitor.

Figure 3-7 Threaded holes for attaching wall mount

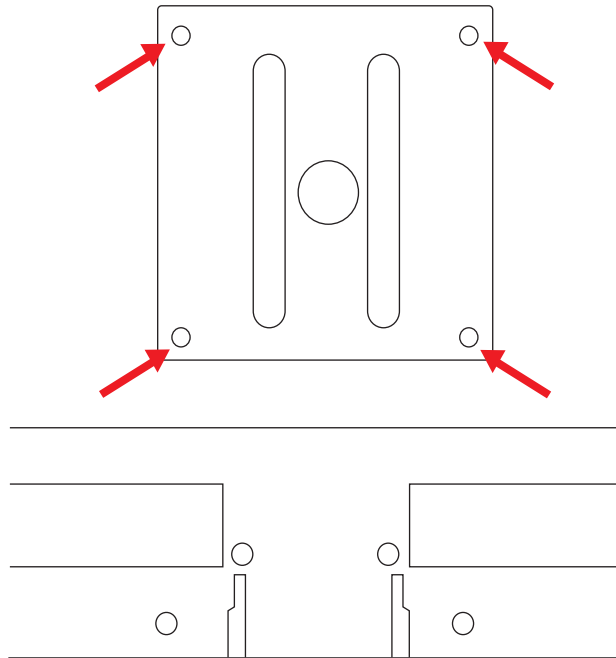

8. Follow the instructions included with the mounting fixture to ensure that the monitor is safely attached.

The four threaded holes that are on the back of the panel are compliant with the VESA standard for mounting flat-panel monitors.

9. Attach a swing arm or other mounting fixture.

Connecting Monitor Cables

Connecting the VGA (Analog) Cable or DVI-D (Digital) Cable or HDMI Cable

Use a VGA video cable, DVI-D cable or HDMI cable to connect your monitor to your computer. To use DVI, you must have a DVI-compliant graphic card. Connectors are located on the back of the monitor. Be sure the computer and monitor are turned off and unplugged.

1. **To connect the VGA cable (provided with select models)**

Connect one end of the VGA video cable to the back of the monitor and the other end to the VGA video connector on the computer.

2. To connect the DVI-D cable (provided with select models)

Connect one end of the DVI-D video cable to the back of the monitor and the other end to the DVI-D video connector on the computer. You can use this cable only if your computer has a DVI compliant graphics card that is either integrated or installed. The monitor DVI-D connector and cable are included.

Figure 3-8 Connecting the VGA or a DVI-D cable - connector locations may vary

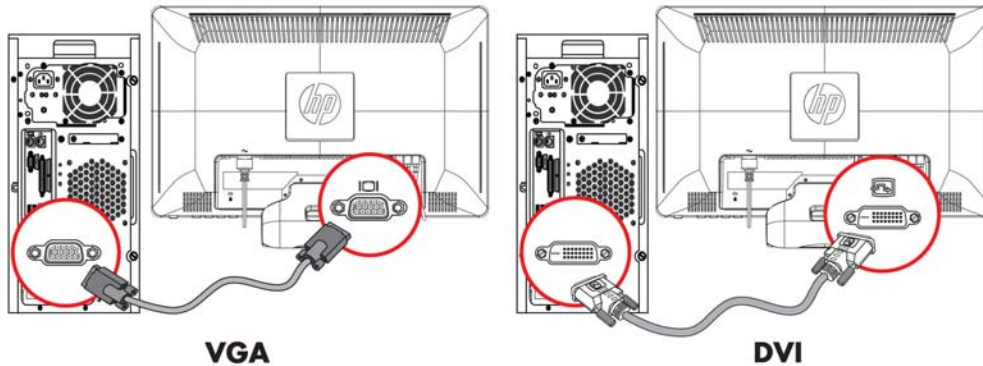

NOTE: When using a VGA or DVI signal, you must connect your audio separately because a VGA or DVI signal converts only video data, not audio data.

3. Connecting the HDMI Cable (provided with select models)

Connect one end of the HDMI cable (not provided) to the back of the monitor and the other end to a computer with an HDMI connector.

Figure 3-9 Connecting the HDMI cable

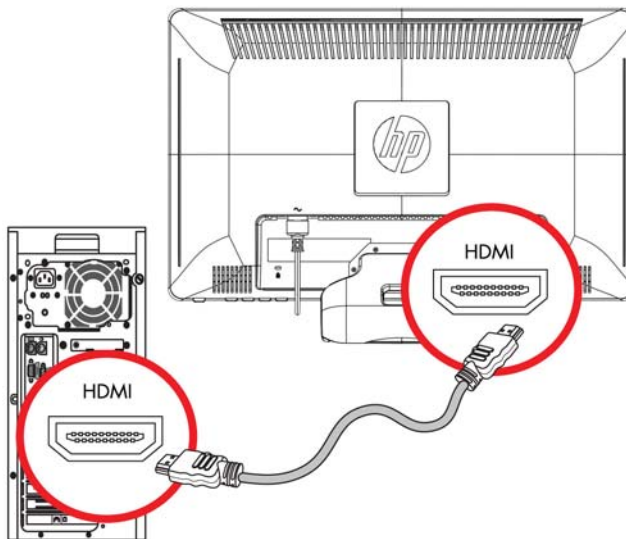

High-Bandwidth Digital Content Protection (HDCP)

Your monitor supports HDCP and can receive high-definition content. High-definition content is available in many sources, such as Blu-ray Disc devices or HDTV air or cable broadcasts. If you do not have an HDCP-enabled monitor, you will see a blank screen or a lower resolution picture when

playing high-definition protected content. Your computer graphics card and monitor must both support HDCP to display protected content.

Connecting the Audio Cable

Connect the built-in monitor speakers to the computer by using the audio cable, as shown in the following illustration:

Figure 3-10 Connecting the audio cables - connector locations may vary

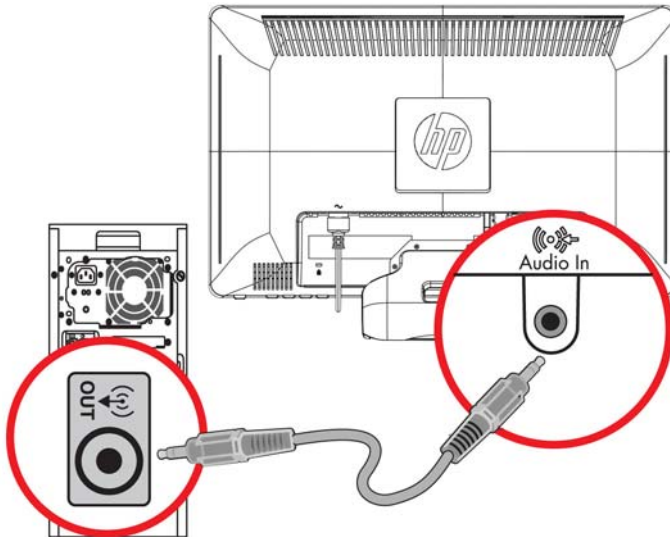

Connecting the Power Cable

1. Follow all electrical and power warnings:

⚠ **WARNING!** To reduce the risk of electric shock or damage to your equipment:

Do not disable the power cord grounding plug. The grounding plug is an important safety feature. Plug the power cord into a grounded (earthed) electrical outlet.

Be sure that the grounded power outlet you plug the power cord into is easily accessible to the operator and located as close to the equipment as possible. A power cord should be routed so that it is not likely to be walked on or pinched by items that are placed upon it or against it.

Do not place anything on power cords or cables. Arrange them so that no one may accidentally step on or trip over them. Do not pull on a cord or cable.

See [Technical Specifications on page 31](#) (Appendix B) for additional information.

Figure 3-11 Connecting the power cable

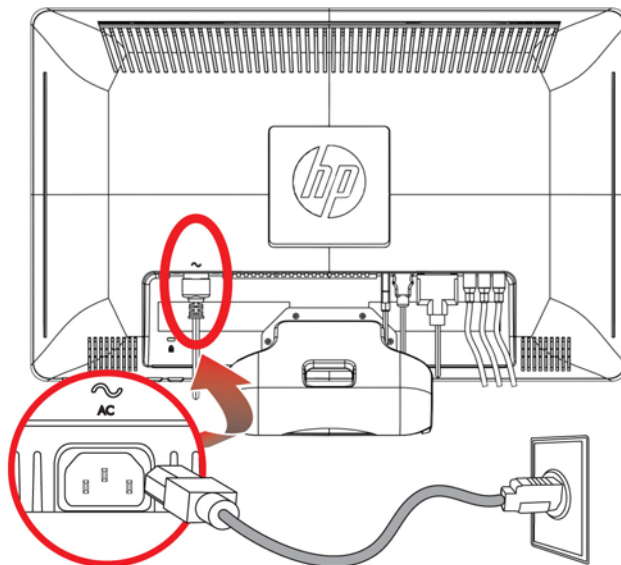

2. Connect one end of the power cable to the monitor and the other end to a grounded electrical outlet.

⚠ **WARNING!** To prevent injury from electrical shock, you should do one of the following if a properly grounded electrical outlet is not available: (1) You should use an electrical outlet adapter that provides proper grounding. (2) You should have a properly grounded electrical outlet installed.

Adjusting The Tilt

For optimal viewing, adjust the screen tilt to your own preference, as follows:

1. Face the front of the monitor and hold the base so that you do not topple the monitor while changing the tilt.

2. Adjust the tilt by moving the top edge of the monitor either toward or away from you, without touching the screen.

Figure 3-12 Tilt adjustment

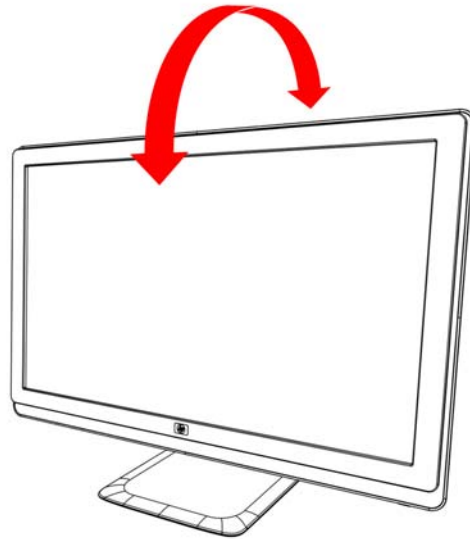

Adjusting the Swivel

The monitor allows a usable range of motion with the swivel feature.

Figure 3-13 Swivel adjustment

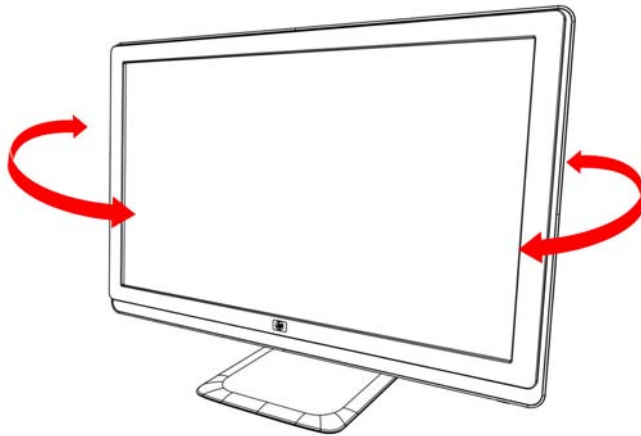

△ **CAUTION:** To avoid breakage or other damage, avoid applying pressure to the LCD screen while swiveling it or changing the tilt.

Keyboard Parking

If you need more space on your desktop, place the keyboard under the monitor when not in use.

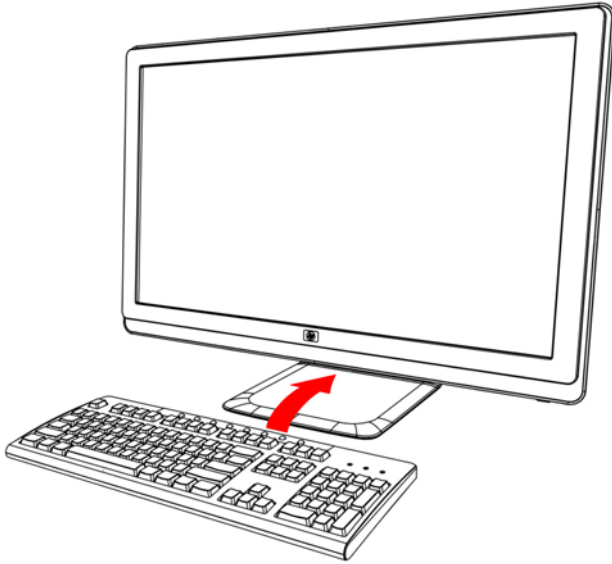

4 Operating the Monitor

CD Software and Utilities

The CD that is included with this monitor contains drivers and software that you can install on your computer.

Installing Drivers

If you determine that you need to update the drivers, you can install the monitor driver INF and ICM files from the CD, or download them from the Internet.

Installing the monitor driver software from the CD

To install the monitor driver software from the CD:

1. Insert the CD in your computer CD drive. The CD menu appears.
2. Select the language.
3. Click **Install Monitor Driver Software**.
4. Follow the on-screen instructions.
5. Ensure that the proper resolutions and refresh rates appear in the Display Control Panel settings. Refer to the Windows® operating system documentation for more information.

 **NOTE:** You might need to install the digitally signed monitor drivers (INF or ICM files) manually from the CD, in case of an installation error. Refer to the "Driver Software Readme" file on the CD for instructions (in English only).

Downloading updated drivers from the Internet

To download the latest version of drivers and software files from the HP Support site:

1. Refer to: **<http://www.hp.com/support>**.
2. Select your country/region.
3. Select **Download Drivers and Software**.
4. Enter the model number of your monitor. The software download pages for your monitor are displayed.
5. Download and install the driver and software files by following the instructions on the download pages.
6. Ensure that your system meets the requirements.

Using the Auto Adjustment Function

You can easily optimize the screen performance for the VGA input by using the Auto/OK button on the monitor and the auto adjustment pattern software on the CD provided.

Do not use this procedure if your monitor is using a DVI or HDMI input. If your monitor is using a VGA input, this procedure can correct the following image-quality conditions:

- Fuzzy or unclear focus
- Ghosting, streaking, or shadowing effects
- Faint vertical bars
- Thin, horizontal scrolling lines
- Off-center picture

△ **CAUTION:** Burn-in image damage may occur on monitors that display the same static image on-screen for a prolonged period of time (12 consecutive hours of non-use). To avoid burn-in image damage on your monitor screen, you should always activate a screen saver application or turn off the monitor when it is not in use for a prolonged period of time. Image retention is a condition that may occur on all LCD screens.

To use the auto adjustment feature:

1. Allow the monitor to warm up for 20 minutes before adjusting.
2. Press the Auto/OK button on the monitor front panel.
 - You can also press the Menu button, and then select **Image Control**, followed by **Auto Adjustment** from the OSD menu.
 - If the result is not satisfactory, continue with the procedure.
3. Insert the CD in your computer CD drive. The CD menu displays.
4. Select the language.
5. Select **Open Auto Adjustment Software**.
6. The setup test pattern displays.

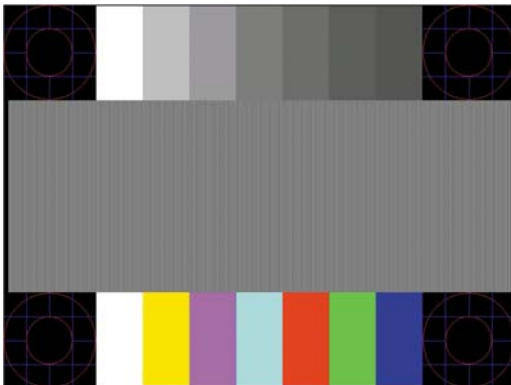

Figure 4-1 Auto adjustment setup test pattern



7. Press the **Auto/OK** button on the monitor panel to produce a stable, centered image.

Front-Panel Controls

Control buttons are located on the right front of the monitor:

No.	Icon	Description
1	Power 	Turns the monitor on or puts it in standby or sleep mode. The Power button is located on the top or front of the monitor depending on the model.
2	Menu	Opens, selects, or exits the OSD menu.
3		Adjusts the volume level.
4	Source	Chooses video input source from the computer
5	—	Navigates backward through the OSD menu and decreases adjustment levels.
6	+	Navigates forward through the OSD menu and increases adjustment levels.
7	Auto	Auto-adjusts the display to the ideal setting when the OSD is not active / Enters the selected option.
8	OK	Enters the selected option

Using the On-Screen Display (OSD)

An on-screen display is an image superimposed on a screen picture, commonly used by monitors, televisions, VCRs, and DVD players to display information such as volume, channel, and time.

1. If the monitor is not already on, press the Power button to turn on the monitor.
2. To access the OSD menu, press the Menu button. The OSD Main Menu displays.
3. To navigate through the Main or sub-menu, press the + (Plus) button on the monitor's side panel to scroll up, or the – (Minus) button to scroll in reverse. Then press the Auto/OK button to select the highlighted function.

 **NOTE:** The menu moves to the top if you scroll down at the bottom of the selections. The menu moves to the bottom if you scroll up at the top of the selections.



4. To adjust the scale of a selected item, press the + or – button.
5. Select **Save and Return**. If you don't want to save the setting, select **Cancel** from the sub-menu or **Exit** from the Main Menu.
6. Press the Menu button to exit the OSD.









 **NOTE:** When a menu is displayed, if the buttons are untouched for 30 seconds (factory default), adjustments and settings are saved and the menu closes.











OSD Menu Selections





The following table lists the on-screen display (OSD) menu selections and their functional descriptions. After changing an OSD menu item, and if the menu screen has these options, you may choose to:





- **Cancel** — to return to the previous menu level.
- **Save and Return** — to save all changes and return to the OSD Main Menu screen. This Save and Return option is active only if you change a menu item.
- **Reset** — to change back to the previous setting.

Icon	Main Menu Options	Sub-menu Options	Description
	Brightness		Adjusts the brightness level of the screen.
	Contrast		Adjusts the contrast level of the screen.
	Color		Selects the screen color. The factory default is 6500 K or Custom Color, depending on the model.
		9300 K	Changes to slightly blueish white.
		6500 K	Changes to slightly reddish white.
		sRGB	Sets your screen colors to adapt to the color standards used in the image technology industry.

Icon	Main Menu Options	Sub-menu Options	Description
		Quick View	Settings saved when user adjusts the Brightness, Contrast, or Color in one of the Quick View options. Movie Photo Gaming Text Custom
		Custom Color	Selects and adjusts your own color scales: R — Sets your own red color levels. G — Sets your own green color levels. B — Sets your own blue color levels.
	Image Control		Adjusts the screen image. Also enables or disables the ambient light sensor (select models).
		Auto Adjustment	Automatically adjusts the screen image (VGA input only).
		Clock	Minimizes any vertical bars or strips visible on the screen background. Adjusting the Clock will also change the horizontal screen image (VGA input only).
		Clock Phase	Adjusts the focus of the display. This adjustment allows you to remove any horizontal noise, and clear or sharpen the image of characters (VGA input only).
		Horizontal Position	Adjusts the horizontal position of the picture (VGA input only).
		Vertical Position	Adjusts the vertical position of the picture (VGA input only).
		Custom Scaling	Selects the method on how displayed information on the monitor will be formatted. Select: <ul style="list-style-type: none"> • Fill to Screen - image fills the entire screen and may look distorted or elongated because of non-proportional scaling of height and width. • Fill to Aspect Ratio - image is sized to fit the screen and maintains proportional image.
		Sharpness (VGA only)	Adjusts the screen image to look sharper or soft.

Icon	Main Menu Options	Sub-menu Options	Description
		Video OverDrive	Reduces motion blur in video and fast moving games. Sets the OverDrive feature on or off; the default setting is Off. (select models)
		Dynamic Contrast Ratio	Displays the status of the Dynamic Contrast Ratio (DCR) setting. DCR automatically adjusts the balance between white and black levels to provide you with an optimal image. Select: On Off The factory default is On or Off, depending on the model.
	OSD Control		Adjusts the position of the OSD menu on the screen.
		Horizontal OSD Position	Changes the viewing position of the OSD menu to the left or right area of the screen. The factory default range is 50.
		Vertical OSD Position	Changes the viewing position of the OSD menu to the top or bottom area of the screen. The factory default range is 50.
		OSD Transparency	Adjust to view the background information through the OSD.
		OSD Timeout	Sets the time in seconds that the OSD is visible after the last button is pressed. The factory default is 30 seconds.
		Rotate OSD	Selects the Landscape or Portrait position. The factory default is Landscape. (select models)
	Management		Selects the power-management features of the monitor.
		Power Saver	Enables the power saving feature (see "Power-Saver Feature" in this chapter). Select: On Off The factory default is On.
		Power-On Recall	Restores power to the monitor following an unexpected removal of power. Select: On Off The factory default is On.

Icon	Main Menu Options	Sub-menu Options	Description
		Mode Display	Displays the resolution, refresh rate, and frequency information on the screen each time the OSD Main Menu is accessed. Select: On Off The factory default is On or Off, depending on the model.
		Monitor Status	Displays the operating status of the monitor each time the monitor is powered on. Select the location at which to display the status: Top Middle Bottom Off The factory default is Top or Off, depending on the model.
		DDC/CI Support	Allows the computer to control some OSD menu features such as Brightness, Contrast, and Color Temperature. Select: On Off The factory default is On.
		Bezel Power LED	Turns the light (LED) in the Power button on and off. When set to off, the light will remain off at all times.
		Volume	Adjusts the volume level.
		Speaker Self-Test (HDMI only)	Provides a self-test for the speakers.

Icon	Main Menu Options	Sub-menu Options	Description
		Sleep Timer	<p>Provides the timer-adjustment menu options:</p> <p>Set Current Time — Sets the current time in hours and minutes.</p> <p>Set Sleep Time — Sets the time you want to place the monitor in sleep mode.</p> <p>Set On Time — Sets the time you want the monitor to wake up from sleep mode.</p> <p>Timer — Sets the Sleep Timer feature on or off; the default setting is Off.</p> <p>Sleep Now — Immediately sets the monitor to enter sleep mode.</p>
	Language		Selects the language in which the OSD menu is displayed. The factory default is English.
	Information		Selects and displays important information about the monitor.
		Current Settings	Provides the current input video mode.
		Recommended Settings	Provides the recommended resolution mode and refresh rate for the monitor.
		Serial Number	Reports the serial number of the monitor. The serial number is needed if contacting HP technical support.
		Version	Reports the firmware version of the monitor.
		Backlight Hours	Reports the total hours of backlight operation.
		Service Support	For service support, go to: http://www.hp.com/support
	Factory Reset		Returns settings to factory defaults.
	Source Control		Selects the video input signal. VGA is the factory default.
		DVI	Selects DVI as the video input signal.
		HDMI	Selects HDMI as the video input signal. (select models)
		VGA	Selects VGA as the video input signal.

Icon	Main Menu Options	Sub-menu Options	Description
		Default Source	Selects the default or primary video input signal when the monitor is connected to two active and valid video sources. The monitor will automatically determine the video format.
		Auto Switch Source	Turns the system's automatic video signal input to On or Off. The factory default is On.

Selecting Video Input Connectors

The input connectors are:

- VGA connector (analog)
- DVI-D connector (digital) (select models)
- HDMI connector (select models)

The monitor automatically determines which inputs have valid video signals, and displays the image. You can connect the VGA cable, the DVI-D cable, or both. If both cables are installed, the default input selection is DVI. The HDMI cable is in place of the DVI-D cable. The source of input can be switched using the **Source Control** option in the OSD menu. Switching from a VGA to an HDMI input source may take several seconds.

Identifying Monitor Conditions

Special messages appear on the monitor screen for the following monitor conditions:

- **Input Signal Out of Range** — Indicates the monitor does not support the video card's input signal because its resolution or refresh rate are set higher than the monitor supports.
Change your video card settings to a lower resolution or refresh rate. Restart your computer for the new settings to take effect.
- **Monitor Going to Sleep** — Indicates the screen display is entering a sleep mode. The speakers are turned off in sleep mode.
- **Power Button Lockout**— Indicates the power button is locked. If the power button is locked, the warning message **Power Button Lockout** displays.
 - If the power button is locked, press and hold the power button for 10 seconds to unlock the power button function.
 - If the power button is unlocked, press and hold the power button for 10 seconds to lock out the power button function.
- **Check Video Cable** — Indicates a video input cable is not properly connected to the computer or monitor.
- **OSD Lock-out** — The OSD can be enabled or disabled by pressing and holding the Menu button on the front panel for 10 seconds. If the OSD is locked, the warning message OSD Lock-out appears for 10 seconds.

If the OSD is locked, press and hold the Menu button for 10 seconds to unlock the OSD.

If the OSD is unlocked, press and hold the Menu button for 10 seconds to lock the OSD.

- **Dynamic Contrast Ratio ON** Indicates DCR is applied when Movie mode is selected from the Quick View options.
- **Dynamic Contrast Ratio OFF** Indicates DCR has been turned off when the monitor is changed to another viewing mode.
- **No Input Signal** — Indicates the monitor is not receiving a video signal from the computer on the monitor video input connector. Check to see if the computer or input signal source is off or in the power-saver mode.
- **Auto Adjustment in Progress** — Indicates the auto adjustment function is active. See "Adjusting Screen Quality" in this chapter.

Adjusting Screen Quality

The auto adjustment feature automatically fine-tunes the image quality for display size, position, clock, and phase each time a new video mode is displayed. For more precise adjustments of VGA input, run the Auto Adjustment software on the CD. See "Using the Auto Adjustment Function" in this chapter.

If you want additional image quality improvement, use the Clock and Clock Phase controls of the monitor to fine tune the image. See "Optimizing Analog Video" in this chapter.

Optimizing Analog Video

Some monitors contain advanced circuitry that allow the monitor to function as a standard analog monitor. Two controls in the OSD menu can be adjusted to improve analog image performance:

- **Clock** — Increase or decrease the value to minimize any vertical bars or stripes visible on the screen background.
- **Clock Phase** — Increase or decrease the value to minimize video distortion or video jitter.

Use these controls only when the auto adjustment function does not provide a satisfactory monitor image in analog mode. To obtain the best results:

1. Allow the monitor to warm up for 20 minutes before adjusting.
2. Display the adjustment-pattern application provided on the CD.
3. Access the OSD menu, then select **Image Control**.
4. Set the main Clock settings correctly first, because the Clock Phase settings depend on the main Clock settings.

When adjusting the Clock and Clock Phase values, if the monitor images become distorted, continue adjusting the values until the distortion disappears.

To restore the factory settings, access the OSD menu, select **Factory Reset**, and then select **Yes**.

Power-Saver Feature

When the monitor is in normal operating mode, the Power light is green and the monitor uses the normal watts of power. For power usage, refer to "Technical Specifications" (Appendix B).

The monitor also supports a power-saver mode that is controlled by the computer. When the monitor is in the reduced-power state, the monitor screen is blank, the backlight is off, and the Power light is amber. The monitor uses minimum power. When the monitor is "awakened," a brief warm-up period occurs before the monitor returns to normal operating mode. The energy-saving reduced power state activates if the monitor does not detect either the horizontal sync signal or the vertical sync signal. The power-saver feature must be activated on your computer for this feature to work.

Refer to your computer documentation for instructions on setting energy-saver features (sometimes called power-management features).

 **NOTE:** The energy-saver feature works only when the monitor is connected to computers that have energy-saver features.

A Troubleshooting

Solving Common Problems

The following table lists possible problems, the possible cause of each problem, and the recommended solutions:

Problem	Solution
Power LED is not on.	<p>Make sure the Power button is on, and the power cord is properly connected to a grounded power outlet and to the monitor.</p> <p>Select Management in the OSD menu, and then select Bezel Power LED. Check if the Bezel Power LED option is set to Off and, if so, set to On mode.</p>
Screen is blank.	<p>Connect the power cord. Turn on the power.</p> <p>Connect the video cable properly. See Setting Up the Monitor on page 7 for more information.</p> <p>Press a key on the keyboard or move the mouse to turn off the screen-blanking utility.</p>
Image appears blurred, indistinct, or too dark.	<p>Press the Auto/OK button on the monitor front panel. If this does not correct the image, press the Menu button to open the OSD menu, and adjust the brightness and contrast scales.</p>
Image is not centered.	<p>Press the Menu button to access the OSD menu. Select Image Control, and then select Horizontal Position or Vertical Position to adjust the position of the image.</p>
Check Video Cable appears on screen.	<p>Connect the monitor VGA or DVI-D signal cable to the VGA or DVI-D connector on the computer. Be sure that the computer power is off while connecting the video cable.</p>
Input Signal Out of Range appears on screen.	<p>Restart your computer and enter Safe Mode. Change your settings to a supported setting (see the table in "Preset Video Modes" in Technical Specifications on page 31). Restart your computer so that the new settings take effect.</p>
Picture is fuzzy and has ghosting, shadowing problem.	<p>Adjust the contrast and brightness controls.</p> <p>Make sure that you are not using an extension cable or switch box. We recommend plugging the monitor directly into the graphic card output connector on the back of your computer.</p> <p>The auto adjustment feature might fix this problem (VGA input only).</p>
Unable to set the monitor to the optimal resolution.	<p>Make sure the graphics card supports the optimal resolution.</p> <p>Make sure the latest supported driver is installed for the graphics card. For HP and Compaq systems, you can download the latest graphics driver for your system from: www.hp.com/support. For other systems, refer to the Web site for your graphics card.</p>
Screen is black or displaying at a lower resolution while displaying high-definition (HD) content.	<p>Check if your monitor and computer support HDCP. Refer to High-Content Digital Bandwidth Protection or http://www.hp.com/support.</p>

Problem	Solution
Unable to hear audio from built-in speakers.	<p>Do the following:</p> <ul style="list-style-type: none"> • Ensure the source signal is good by using headphones at the source. • Press the Menu button to access the OSD menu. Select Management, and then select Volume to adjust the volume. • Turn up the volume with the Volume button. • Ensure speaker volume is not muted or too low: Click the Windows start button[™], Control Panel, and Hardware and Sound. Under Audio Devices and Sound, click Adjust system volume. Under Main Volume, move the slider up. • If you are connected using HDMI, use the Speaker Self Test OSD Volume option to ensure that the speakers work, and thus isolate it to a potential issue with the source input.
No Plug and Play.	<p>In order for the Plug and Play feature of the monitor to work, you need a computer and graphic card that are compatible with Plug and Play. Check with your computer manufacturer.</p> <p>Check the monitor's video cable, and make sure that none of the pins are bent.</p> <p>Make sure that the monitor drivers are installed. Refer to "Installing Drivers" in the Operating the Monitor on page 17 chapter for more information. Monitor drivers are also available at: http://www.hp.com/support</p>
Picture bounces, flickers, or wave pattern is present in the picture.	<p>Move electrical devices that may cause electrical interference as far away from the monitor as possible.</p> <p>Use the maximum refresh rate that your monitor is capable of at the resolution that you are using.</p>
Using HDMI connection, unable to hear audio.	<p>Ensure HDMI audio is selected as the main audio output in the operating system. To do so, click the Windows Start Button, and then click Control Panel. Click Sound, and in the Playback tab, ensure the check mark is next to the HDMI output, and click OK.</p>
Monitor is always in sleep mode (amber LED).	<p>The computer power switch should be in the On position.</p> <p>The computer graphic card should be snugly seated in its slot.</p> <p>Check that the monitor video cable is properly connected to the computer.</p> <p>Inspect the monitor video cable, and make sure that none of the pins are bent.</p> <p>Check that your computer is operational: Press the Caps Lock key and observe the Caps Lock LED found on most keyboards. The LED should either turn on or off after hitting the Caps Lock key.</p>

Getting Support from hp.com

Before you contact customer service, refer to HP Technical Support at: <http://www.hp.com/support> Select your country/region, and then follow the links to the support page for your monitor.

Preparing to Call Technical Support

If you cannot solve a problem by using the troubleshooting tips in this section, you might have to call technical support. For technical support contact information, refer to the printed documentation included with the monitor.

Have the following information available when you call:

- Monitor model number (located on label on back of monitor)
- Monitor serial number (located on label on back of monitor or in the OSD display in the Information menu)
- Purchase date on invoice
- Conditions under which the problem occurred
- Error messages received
- Hardware configuration
- Name and version of hardware and software you are using

Locating the Rating Label

The rating label on the monitor provides the product number and serial number. You may need these numbers when contacting HP about your monitor model.

The rating label is on the back of the monitor.

B Technical Specifications

All specifications represent the typical specifications provided by HP's component manufacturers; actual performance may vary either higher or lower.

HP LCD Monitors

Face treatment: Glare polarizer with hard coating

Input terminal:

- VGA connector
- DVI-D 24-pin D-type connector (select models)
- HDMI connector (select models)

Table B-1 Model 1910m

Specifications:	
Display Type:	TFT LCD active matrix
Viewable Image Size:	47.0 cm (18.5 in.) diagonal
Tilt	-5° to +25°
Maximum Weight (unpacked):	4.05 kg (8.9 lb)
Dimensions (h x w x d):	355 x 470 x 184 mm (14.0 x 18.0 x 7.2 in.)
Maximum Graphics Resolution:	1366 x 768 @ 60 Hz analog mode
Optimum Graphics Resolution:	1366 x 768 @ 60 Hz analog mode
Text Mode:	720 x 400
Dot Pitch:	0.30 x 0.30 mm
Horizontal Frequency (analog mode):	24 to 83 kHz
Vertical Frequency (analog mode):	50 to 76 Hz
Environmental Requirements	
Temperature (independent of altitude)	
Operating Temperature:	5° to 35° C (41° to 95° F)
Non-Operating Humidity:	-20° to 60° C (-4° to 140° F)
Relative Humidity (non-condensing):	

Table B-1 Model 1910m (continued)

Specifications:	
Operating Humidity:	20% to 80%
Non-Operating Humidity:	5% to 95%
Power Source:	100–240 V AC (ca), 50/60 Hz
Power Consumption:	28.5 watts (W) maximum
Sleep Power Consumption:	<2 watts (W) typical

Table B-2 Models 2010f/i/m

Specifications:	
Display Type:	TFT LCD active matrix
Viewable Image Size:	50.8 cm (20 in.) diagonal
Tilt	–5° to +25°
Maximum Weight (unpacked):	5.36 kg (11.8 lb)
Dimensions (h x w x d):	502.6 x 371.8 x 183.1 mm (19.8 x 14.6 X 7.2 in.)
Maximum Graphics Resolution:	1600 x 900 @ 60 Hz analog mode
Optimum Graphics Resolution:	1600 x 900 @ 60 Hz analog mode
Text Mode:	720 x 400
Dot Pitch:	0.2768 x 0.2768 mm
Horizontal Frequency (analog mode):	24 to 83 kHz
Vertical Frequency (analog mode):	50 to 76 Hz
Environmental Requirements	
Temperature (independent of altitude)	
Operating Temperature:	5° to 35° C (41° to 95° F)
Non-Operating Humidity:	–20° to 60° C (–4° to 140° F)
Relative Humidity (non-condensing):	
Operating Humidity:	20% to 80%
Non-Operating Humidity:	5% to 95%
Power Source:	100–240 V AC (ca), 50/60 Hz
Power Consumption:	35 watts (W) maximum
Sleep Power Consumption:	<1 watts (W) typical

Table B-3 Models 2210i/m

Specifications:	
Display Type:	TFT LCD active matrix
Viewable Image Size:	55.68 cm (21.53 in.) diagonal

Table B-3 Models 2210i/m (continued)

Specifications:	
Tilt	-5° to +25°
Maximum Weight (unpacked):	5.52 kg (12.2 lb)
Dimensions (h x w x d):	392 x 536 x 200 mm (15.4 x 21.1 x 7.9 in.)
Maximum Graphics Resolution:	1920 x 1080 @ 60 Hz analog mode
Optimum Graphics Resolution:	1920 x 1080 @ 60 Hz analog mode
Text Mode:	720 x 400
Dot Pitch:	0.2480 x 0.2480 mm
Horizontal Frequency (analog mode):	24 to 94 kHz
Vertical Frequency (analog mode):	50 to 76 Hz
Environmental Requirements	
Temperature (independent of altitude)	
Operating Temperature:	5° to 35° C (41° to 95° F)
Non-Operating Humidity:	-20° to 60° C (-4° to 140° F)
Relative Humidity (non-condensing):	
Operating Humidity:	20% to 80%
Non-Operating Humidity:	5% to 95%
Power Source:	100–240 V AC (ca), 50/60 Hz
Power Consumption:	56 watts (W) maximum
Sleep Power Consumption:	<2 watts (W) typical

Table B-4 Models 2310i/m

Specifications:	
Display Type:	TFT LCD active matrix
Viewable Image Size:	23.0 in. (58.42 cm) diagonal
Tilt	-5° to +25°
Maximum Weight (unpacked):	21.6 lb (9.8 kg)
Dimensions (h x w x d):	16.2 x 22.6 x 7.9 in. (412 x 573 x 200 mm)
Maximum Graphics Resolution:	1920 x 1080 @ 60 Hz analog mode
Optimum Graphics Resolution:	1920 x 1080 @ 60 Hz analog mode
Text Mode:	720 x 400
Dot Pitch:	0.265 x 0.265 mm
Horizontal Frequency (analog mode):	24 to 94 kHz
Vertical Frequency (analog mode):	50 to 76 Hz
Environmental Requirements	

Table B-4 Models 2310i/m (continued)

Specifications:	
Temperature (independent of altitude)	
Operating Temperature:	5° to 35° C (41° to 95° F)
Non-Operating Humidity:	-20° to 60° C (-4° to 140° F)
Relative Humidity (non-condensing):	
Operating Humidity:	20% to 80%
Non-Operating Humidity:	5% to 95%
Power Source:	100–240 V AC (ca), 50/60 Hz
Power Consumption:	56 watts (W) maximum
Sleep Power Consumption:	<2 watts (W) typical

Table B-5 Model 2510i

Specifications:	
Display Type:	TFT LCD active matrix
Viewable Image Size:	63.5 cm (25 in.) diagonal
Tilt	-5° to +25°
Maximum Weight (unpacked):	8.1 Kg (17.9 lb)
Dimensions (h x w x d):	436 x 618 x 201 mm (17.2 x 24.3 x 7.9 in.)
Maximum Graphics Resolution:	1920 x 1080 @ 60 Hz analog mode
Optimum Graphics Resolution:	1920 x 1080 @ 60 Hz analog mode
Text Mode:	720 x 400
Dot Pitch:	0.288 x 0.288 mm
Horizontal Frequency (analog mode):	24 to 94kHz
Vertical Frequency (analog mode):	50 to 76 Hz
Environmental Requirements	
Temperature (independent of altitude)	
Operating Temperature:	5° to 35° C (41° to 95° F)
Non-Operating Humidity:	-20° to 60° C (-4° to 140° F)
Relative Humidity (non-condensing):	
Operating Humidity:	20% to 80%
Non-Operating Humidity:	5% to 95%
Power Source:	100–240 V AC (ca), 50/60 Hz
Power Consumption:	60 watts (W) maximum
Sleep Power Consumption:	<2 watts (W) typical

Table B-6 Model 2710m

Specifications:	
Display Type:	TFT LCD active matrix
Viewable Image Size:	68.58 cm (27 in.) diagonal
Tilt	-5° to +25°
Maximum Weight (unpacked):	9.6 Kg (21.2 lb)
Dimensions (h x w x d):	469 x 671 x 214 mm (18.5 x 26.4 x 8.4 in.)
Maximum Graphics Resolution:	1920 x 1080 @ 60 Hz analog mode
Optimum Graphics Resolution:	1920 x 1080 @ 60 Hz analog mode
Text Mode:	720 x 400
Dot Pitch:	0.265 x 0.265 mm
Horizontal Frequency (analog mode):	24 to 94 kHz
Vertical Frequency (analog mode):	48 to 76 Hz
Environmental Requirements	
Temperature (independent of altitude)	
Operating Temperature:	5° to 35° C (41° to 95° F)
Non-Operating Humidity:	-20° to 60° C (-4° to 140° F)
Relative Humidity (non-condensing):	
Operating Humidity:	20% to 80%
Non-Operating Humidity:	5% to 95%
Power Source:	100–240 V AC (ca), 50/60 Hz
Power Consumption:	120 watts (W) maximum
Sleep Power Consumption:	<2 watts (W) typical

Preset Video Modes

The monitor automatically recognizes many preset video input modes that will appear properly sized and centered on the screen.

Table B-7 Factory Preset Video Input Modes, 1910m

Preset	Resolution	Horizontal Frequency (kHz)	Vertical Frequency (Hz)
1	640 x 480	31.47	59.94
2	720 x 400	31.47	70.09
3	800 x 600	37.88	60.32
4	1280 x 720	45.00	60.00
5	1024 x 768	48.36	60.00
6	1280 x 960	60.00	60.00

Table B-7 Factory Preset Video Input Modes, 1910m (continued)

Preset	Resolution	Horizontal Frequency (kHz)	Vertical Frequency (Hz)
7	1280 x 1024	63.98	60.02
8	1366 x 768	47.71	59.79

Table B-8 Factory Preset Video Input Modes, 2010f/i/m

Preset	Resolution	Horizontal Frequency (kHz)	Vertical Frequency (Hz)
1	640 x 480	31.47	59.94
2	720 x 400	31.47	70.09
3	800 x 600	37.88	60.32
4	1024 x 768	48.36	60.00
5	1280 x 720	45.00	60.00
6	1280 x 1024	63.98	60.02
7	1440 x 900	55.93	59.88
8	1600 x 900	55.54	59.98

Table B-9 Factory Preset Video Input Modes, 2210i\m; 2310i\m; 2510i; 2710m

Preset	Resolution	Horizontal Frequency (kHz)	Vertical Frequency (Hz)
1	640 x 480	31.47	59.94
2	720 x 400	31.47	70.09
3	800 x 600	37.88	60.32
4	1024 x 768	48.36	60.00
5	1280 x 720	45.00	60.00
6	1280 x 960	60.00	60.00
7	1280 x 1024	63.98	60.02
8	1440 x 900	55.93	59.88
9	1600 x 1200	75.00	60.00
10	1680 x 1050	65.29	60.00
11	1920 x 1080	67.50	60.00

LCD Monitor Quality and Pixel Policy

Your LCD Monitor uses high-precision technology, manufactured according to high standards, to help guarantee trouble-free performance. Nevertheless, the display may have cosmetic imperfections that appear as small bright or dark spots. This is common to all LCD displays used in products supplied by all vendors and is not specific to your LCD Monitor. These imperfections are caused by one or more defective pixels or subpixels.

A pixel consists of one red, one green, and one blue subpixel. A defective whole pixel is always turned on (a bright spot on a dark background), or it is always off (a dark spot on a bright background). The first is the more visible of the two. A defective subpixel (dot defect) is less visible than a defective whole pixel, and is small and only visible on a specific background.

To locate defective pixels, the monitor should be viewed under normal operating conditions and in normal operating mode at a supported resolution and refresh rate, from a distance of approximately 50 cm (16 inches). We expect that, over time, the industry will continue to improve its ability to produce displays with fewer cosmetic imperfections, and we will adjust guidelines as improvements are made.

For more information about your LCD Monitor and pixel policy, refer to the HP Web site at: <http://www.hp.com/support>. To find pixel policy information on the HP Web site, type in "HP Pixel Policy" in the search box and press Enter.

C Agency Regulatory Notices

Federal Communications Commission Notice

This equipment has been tested and found to comply with the limits for a Class B digital device, pursuant to Part 15 of the FCC Rules. These limits are designed to provide reasonable protection against harmful interference in a residential installation. This equipment generates, uses, and can radiate radio frequency energy and, if not installed and used in accordance with the instructions, may cause harmful interference to radio communications. However, there is no guarantee that interference will not occur in a particular installation. If this equipment does cause harmful interference to radio or television reception, which can be determined by turning the equipment off and on, the user is encouraged to try to correct the interference by one or more of the following measures:

- Reorient or relocate the receiving antenna.
- Increase the separation between the equipment and the receiver.
- Connect the equipment into an outlet on a circuit different from that to which the receiver is connected.
- Consult the dealer or an experienced radio or television technician for help.

Modifications

The FCC requires the user to be notified that any changes or modifications made to this device that are not expressly approved by Hewlett Packard Company may void the user's authority to operate the equipment.

Cables

Connections to this device must be made with shielded cables with metallic RF/EMI connector hoods to maintain compliance with FCC Rules and Regulations.

Declaration of Conformity for Products Marked with the FCC Logo (United States Only)

This device complies with Part 15 of the FCC Rules. Operation is subject to the following two conditions:

1. This device may not cause harmful interference.
2. This device must accept any interference received, including interference that may cause undesired operation.

For questions regarding the product, contact:

Hewlett Packard Company
P. O. Box 692000, Mail Stop 530113
Houston, Texas 77269-2000
Or, call 1-800-HP-INVENT (1-800 474-6836)

For questions regarding this FCC declaration, contact:

Hewlett Packard Company
P. O. Box 692000, Mail Stop 510101
Houston, Texas 77269-2000
Or, call (281) 514-3333

To identify this product, refer to the Part, Series, or Model number found on the product.

Canadian Notice

This Class B digital apparatus meets all requirements of the Canadian Interference-Causing Equipment Regulations.

Avis Canadien

Cet appareil numérique de la classe B respecte toutes les exigences du Règlement sur le matériel brouilleur du Canada.

European Union Regulatory Notice

This product complies with the following EU Directives:

- Low Voltage Directive 2006/95/EC
- EMC Directive 2004/108/EC

Compliance with these directives implies conformity to applicable harmonized European standards (European Norms) which are listed on the EU Declaration of Conformity issued by Hewlett-Packard for this product or product family.

This compliance is indicated by the following conformity marking placed on the product:

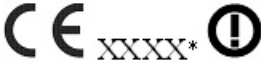
 <small>This marking is valid for non-Telecom products and EU harmonized Telecom products (e.g. Bluetooth).</small>	 <small>This marking is valid for EU non-harmonized Telecom products. *Notified body number (used only if applicable - refer to the product label).</small>
This marking is valid for non-Telecom products and EU harmonized Telecom products (e.g. Bluetooth)	This marking is valid for EU non-harmonized Telecom products. *Notified body number (used only if applicable — refer to the product label).

Hewlett-Packard GmbH, HQ-TRE, Herrenberger Strasse 140, 71034 Boeblingen, Germany

The official EU CE declaration of conformity for this device may be found at <http://www.hp.com/go/certificates>.

German Ergonomics Notice

HP products which bear the "GS" approval mark, when forming part of a system comprising HP brand computers, keyboards and monitors that bear the "GS" approval mark, meet the applicable ergonomic requirements. The installation guides included with the products provide configuration information.

Japanese Notice

この装置は、クラスB情報技術装置です。この装置は、家庭環境で使用することを目的としていますが、この装置がラジオやテレビジョン受信機に近接して使用されると、受信障害を引き起こすことがあります。取扱説明書に従って正しい取り扱いをして下さい。

VCCI-B

Korean Notice

B급 기기
(가정용 방송통신기기)

이 기기는 가정용(B급)으로 전자파적합등록을 한 기기로서 주로 가정에서 사용하는 것을 목적으로 하며, 모든 지역에서 사용할 수 있습니다.

Power Cord Set Requirements

The monitor power supply is provided with Automatic Line Switching (ALS). This feature allows the monitor to operate on input voltages between 100–120V or 200–240V.

The power cord set (flexible cord or wall plug) received with the monitor meets the requirements for use in the country where you purchased the equipment.

If you need to obtain a power cord for a different country, you should purchase a power cord that is approved for use in that country.

The power cord must be rated for the product and for the voltage and current marked on the product's electrical ratings label. The voltage and current rating of the cord should be greater than the voltage and current rating marked on the product. In addition, the cross-sectional area of the wire must be a minimum of 0.75 mm² or 18 AWG, and the length of the cord must be between 6 feet (1.8 m) and 12 feet (3.6 m). If you have questions about the type of power cord to use, contact an authorized HP service provider.

A power cord should be routed so that it is not likely to be walked on or pinched by items placed upon it or against it. Particular attention should be paid to the plug, electrical outlet, and the point where the cord exits from the product.

Japanese Power Cord Requirements

For use in Japan, use only the power cord received with this product.

△ **CAUTION:** Do not use the power cord received with this product on any other products.

Product Environmental Notices

Materials Disposal

This HP product contains mercury in the fluorescent lamp in the display LCD that might require special handling at end-of-life.

Disposal of this material can be regulated because of environmental considerations. For disposal or recycling information, contact the local authorities or the Electronic Industries Alliance (EIA) <http://www.eiae.org>.

Disposal of Waste Equipment by Users in Private Household in the European Union



This symbol on the product or on its packaging indicates that this product must not be disposed of with your household waste. Instead, it is your responsibility to dispose of your waste equipment by handing it over to a designated collection point for the recycling or waste electrical and electronic equipment. The separate collection and recycling of your waste equipment at the time of disposal will help to conserve natural resources and ensure that it is recycled in a manner that protects human health and the environment. For more information about where you can drop off your waste equipment for recycling, please contact the local city office, the household waste disposal service or the shop where you purchased the product.

Chemical Substances

HP is committed to providing our customers with information about the chemical substances in our products as needed to comply with legal requirements such as REACH (Regulation EC No 1907/2006 of the European Parliament and Council). A chemical information report for this product can be found at <http://www.hp.com/go/reach>.

HP Recycling Program

HP encourages customers to recycle used electronic hardware, HP original print cartridges, and rechargeable batteries. For more information about recycling programs, go to <http://www.hp.com/recycle>.

Restriction of Hazardous Substances (RoHS)

A Japanese regulatory requirement, defined by specification JIS C 0950, 2005, mandates that manufacturers provide Material Content Declarations for certain categories of electronic products offered for sale after July 1, 2006. To view the JIS C 0950 material declaration for this product, visit <http://www.hp.com/go/jisc0950>.

2008年、日本における製品含有表示方法、JISC0950が公示されました。製造事業者は、2006年7月1日以降に販売される電気・電子機器の特定化学物質の含有につきまして情報提供を義務付けられました。製品の部材表示につきましては、www.hp.com/go/jisc0950を参照してください。

有毒有害物质/元素的名称及含量表

根据中国 《电子信息产品污染控制管理办法》

液晶显示器

部件名称	有毒有害物质和元素					
	铅 (Pb)	汞 (Hg)	镉 (Cd)	六价铬 (Cr(VI))	多溴联苯 (PBB)	多溴二苯醚 (PBDE)
液晶显示器显示面板	X	X	○	○	○	○
机箱/其它	X	○	○	○	○	○

CRT 显示器

部件名称	有毒有害物质和元素					
	铅 (Pb)	汞 (Hg)	镉 (Cd)	六价铬 (Cr(VI))	多溴联苯 (PBB)	多溴二苯醚 (PBDE)
阴极射线管	X	○	○	○	○	○
机箱/其它	X	○	○	○	○	○

O: 表示该有毒或有害物质在该部件所有均质材料中的含量均在 SJ/T11363-2006 标准规定的限量要求以下。

X: 表示该有毒或有害物质至少在该部件所用的某一均质材料中的含量超出 SJ/T11363-2006 标准规定的限量要求。

表中标有“X”的所有部件都符合欧盟 RoHS 法规 — “欧洲议会和欧盟理事会 2003 年 1 月 27 日关于电子电器设备中限制使用某些有害物质的 2002/95/EC 号指令”。

注：环保使用期限的参考标识取决于产品正常工作的温度和湿度等条件。

Turkey EEE Regulation

In Conformity with the EEE Regulation

EEE Yönetmeliğine Uygundur

Free Manuals Download Website

<http://myh66.com>

<http://usermanuals.us>

<http://www.somanuals.com>

<http://www.4manuals.cc>

<http://www.manual-lib.com>

<http://www.404manual.com>

<http://www.luxmanual.com>

<http://aubethermostatmanual.com>

Golf course search by state

<http://golfingnear.com>

Email search by domain

<http://emailbydomain.com>

Auto manuals search

<http://auto.somanuals.com>

TV manuals search

<http://tv.somanuals.com>