

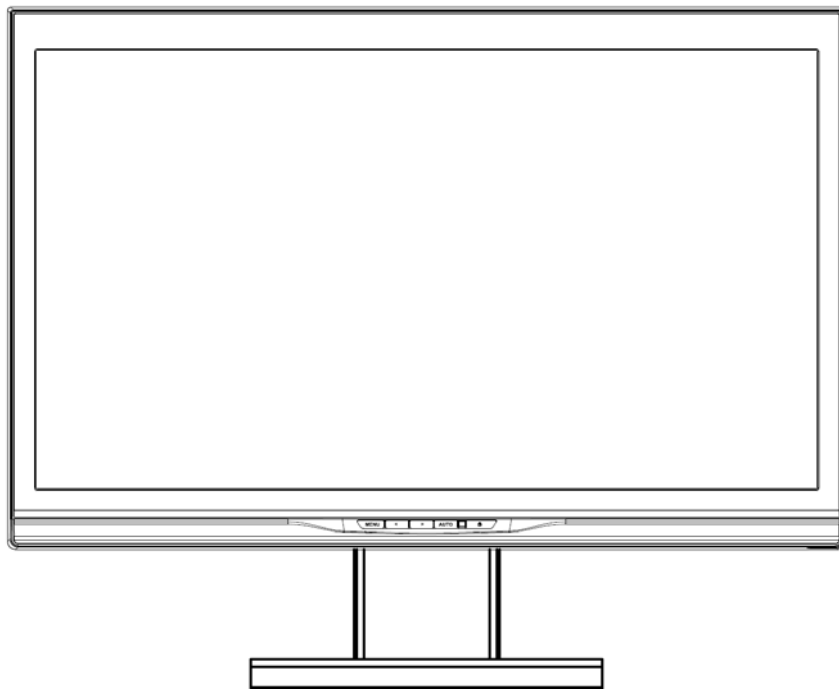

USER'S MANUAL

L2105tm / 2209t LCD Touch Monitors



Agency no.: HSTND-2791-Q

Copyright © 2009 HP. All Rights Reserved.

No part of this manual, including the products and software described in it, may be reproduced, transmitted, transcribed, stored in a retrieval system, or translated into any language in any form or by any means, except documentation kept by the purchaser for backup purposes, without the express written permission of HP.

Product warranty or service will not be extended if: (1) the product is repaired, modified or altered, unless such repair, modification or alteration is authorized in writing by HP; or (2) the serial number of the product is defaced or missing.

HP PROVIDES THIS MANUAL "AS IS" WITHOUT WARRANTY OF ANY KIND, EITHER EXPRESS OR IMPLIED, INCLUDING BUT NOT LIMITED TO THE IMPLIED WARRANTIES OR CONDITIONS OF MERCHANTABILITY OR FITNESS FOR A PARTICULAR PURPOSE. IN NO EVENT SHALL HP, ITS DIRECTORS, OFFICERS, EMPLOYEES OR AGENTS BE LIABLE FOR ANY INDIRECT, SPECIAL, INCIDENTAL, OR CONSEQUENTIAL DAMAGES (INCLUDING DAMAGES FOR LOSS OF PROFITS, LOSS OF BUSINESS, LOSS OF USE OR DATA, INTERRUPTION OF BUSINESS AND THE LIKE), EVEN IF HP HAS BEEN ADVISED OF THE POSSIBILITY OF SUCH DAMAGES ARISING FROM ANY DEFECT OR ERROR IN THIS MANUAL OR PRODUCT. SPECIFICATIONS AND INFORMATION CONTAINED IN THIS MANUAL ARE FURNISHED FOR INFORMATIONAL USE ONLY, AND ARE SUBJECT TO CHANGE AT ANY TIME WITHOUT NOTICE, AND SHOULD NOT BE CONSTRUED AS A COMMITMENT BY HP. HP ASSUMES NO RESPONSIBILITY OR LIABILITY FOR ANY ERRORS OR INACCURACIES THAT MAY APPEAR IN THIS MANUAL, INCLUDING THE PRODUCTS AND SOFTWARE DESCRIBED IN IT.

Products and corporate names appearing in this manual may or may not be registered trademarks or copyrights of their respective companies, and are used only for identification or explanation and to the owners' benefit, without intent to infringe.

First Edition (October 2009)

Document Part Number: 582769-001

Agency Regulatory Notices

Federal Communications Commission Notice

This equipment has been tested and found to comply with the limits for a Class B digital device, pursuant to Part 15 of the FCC Rules. These limits are designed to provide reasonable protection against harmful interference in a residential installation. This equipment generates, uses, and can radiate radiofrequency energy and, if not installed and used in accordance with the instructions, may cause harmful interference to radio communications. However, there is no guarantee that interference will not occur in a particular installation. If this equipment does cause harmful interference to radio or television reception, which can be determined by turning the equipment off and on, the user is encouraged to try to correct the interference by one or more of the following measures:

- Reorient or relocate the receiving antenna.
- Increase the separation between the equipment and the receiver.
- Connect the equipment into an outlet on a circuit different from that to which the receiver is connected.
- Consult the dealer or an experienced radio or television technician for help.

Modifications

The FCC requires the user to be notified that any changes or modifications made to this device that are not expressly approved by Hewlett Packard Company may void the user's authority to operate the equipment.

Cables

Connections to this device must be made with shielded cables with metallic RFI/EMI connector hoods to maintain compliance with FCC Rules and Regulations.

Declaration of Conformity for Products Marked with the FCC Logo (United States Only)

This device complies with Part 15 of the FCC Rules. Operation is subject to the following two conditions:

1. This device may not cause harmful interference.
2. This device must accept any interference received, including interference that may cause undesired operation.

For questions regarding the product, contact:

Hewlett Packard Company
P. O. Box 692000, Mail Stop 530113
Houston, Texas 77269-2000

Or, call 1-800-HP-INVENT (1-800 474-6836)

For questions regarding this FCC declaration, contact:

Hewlett Packard Company
P. O. Box 692000, Mail Stop 510101
Houston, Texas 77269-2000

Or, call (281) 514-3333

To identify this product, refer to the Part, Series, or Model number found on the product.

Canadian Notice

This Class B digital apparatus meets all requirements of the Canadian Interference-Causing Equipment Regulations.

Avis Canadien

Cet appareil numérique de la classe B respecte toutes les exigences du Règlement sur le matériel brouilleur du Canada.

Japanese Notice

この装置は、クラスB情報技術装置です。この装置は、家庭環境で使用することを目的としていますが、この装置がラジオやテレビジョン受信機に近接して使用されると、受信障害を引き起こすことがあります。取扱説明書に従って正しい取り扱いをして下さい。

VCCI-B

Korean Notice

B급 기기

(가정용 방송통신기기)

이 기기는 가정용(B급)으로 전자파적합등록을 한 기기로서 주로 가정에서 사용하는 것을 목적으로 하며, 모든 지역에서 사용할 수 있습니다.

Power Cord Set Requirements

The monitor power supply is provided with Automatic Line Switching (ALS). This feature allows the monitor to operate on input voltages between 100–120V or 200–240V. The power cord set (flexible cord or wall plug) received with the monitor meets the requirements for use in the country where you purchased the equipment. If you need to obtain a power cord for a different country, you should purchase a power cord that is approved for use in that country. The power cord must be rated for the product and for the voltage and current marked on the product's electrical ratings label. The voltage and current rating of the cord should be greater than the voltage and current rating marked on the product. In addition, the cross-sectional area of the wire must be a minimum of 0.75 mm² or 18 AWG, and the length of the cord must be between 6 feet (1.8 m) and 12 feet (3.6 m). If you have questions about the type of power cord to use, contact an authorized HP service provider. A power cord should be routed so that it is not likely to be walked on or pinched by items placed upon it or against it. Particular attention should be paid to the plug, electrical outlet, and the point where the cord exits from the product.

Japanese Power Cord Requirements

For use in Japan, use only the power cord received with this product.



CAUTION: Do not use the power cord received with this product on any other products.

Product Environmental Notices

Materials Disposal

This HP product contains mercury in the fluorescent lamp in the display LCD that might require special handling at end-of-life. Disposal of this material can be regulated because of environmental considerations. For disposal or recycling information, contact the local authorities or the Electronic Industries Alliance (EIA) <http://www.eiae.org>.

Disposal of Waste Equipment by Users in Private Household in the European Union



■ This symbol on the product or on its packaging indicates that this product must not be disposed of with your household waste. Instead, it is your responsibility to dispose of your waste equipment by handing it over to a designated collection point for the recycling or waste electrical and electronic equipment. The separate collection and recycling of your waste equipment at the time of disposal will help to conserve natural resources and ensure that it is recycled in a manner that protects human health and the environment. For more information about where you can drop off your waste equipment for recycling, please contact the local city office, the household waste disposal service or the shop where you purchased the product.

Chemical Substances

HP is committed to providing our customers with information about the chemical substances in our products as needed to comply with legal requirements such as REACH (Regulation EC No 1907/2006 of the European Parliament and Council). A chemical information report for this product can be found at <http://go/reach>.

Restriction of Hazardous Substances (RoHS)

A Japanese regulatory requirement, defined by specification JIS C 0950, 2005, mandates that manufacturers provide Material Content Declarations for certain categories of electronic products offered for sale after July 1, 2006. To view the JIS C 0950 material declaration for this product, visit <http://www.hp.com/go/jisc0950>.

2008年、日本における製品含有表示方法、JISC0950が公示されました。製造事業者は、2006年7月1日以降に販売される電気・電子機器の特定化学物質の含有につきまして情報提供を義務付けられました。製品の部材表示につきましては、www.hp.com/go/jisc0950を参照してください。

Monitor Placement Considerations

For displays with glossy bezels the user should consider the placement of the display as the bezel may cause disturbing reflections from surrounding light and bright surfaces.

Table of Contents

Safety Instructions	2
Recycling Information	3
System components and accessories	4
Connection instructions	5
Installing the display	5
Packaging procedures	5
Adjusting the viewing angle	5
Connection instructions	6
Using the display	7
Turning on the display	7
Function controls	7
Installing the Touch Driver (for Windows XP only)	8
Control of the Touch Function	10
OSD selection	11
OSD Menu	11
Troubleshooting	13
Production Specifications	14
Preset Modes	15
Appendix	16
Connector pin assignment	16

Safety Instructions



- Please keep the display away from any heat sources such as electric radiators or direct sunlight. Place the display in a stable and well-ventilated place.
- The holes or openings on the display are designed for ventilation. Do not cover or block the ventilation holes or openings with any objects.
- Remove protective film on the screen before you use the display
- As the display surface is vulnerable to scratches, avoid touching the surface with nail or pen point.
- Shut off the power supply before cleaning. Use a soft lint-free cloth instead of a tissue to wipe the screen.
- You may use a glass cleaner to clean the product as required. However, never spray the cleaner directly onto the display surface.
- Do not attempt to repair this product yourself! Improperly disassembly of the product may expose you to danger! If your problem cannot be solved according to the "Troubleshooting" guidelines, contact your regional HP authorized service provider, <http://www.hp.com/support>.

Recycling Information

HP encourages customers to recycle used electronic hardware, HP original print cartridges, and rechargeable batteries. For more information about recycling programs, go to <http://www.hp.com/recycle>.

System components and accessories

LCD display



Power cord

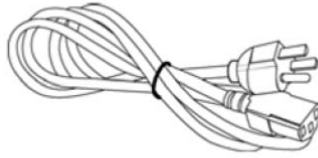

Audio cable



Signal cable (VGA)

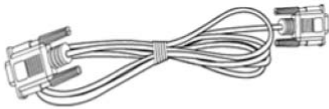

USB cable



DVI cable

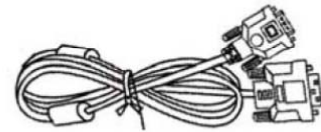

Quick Start Guide

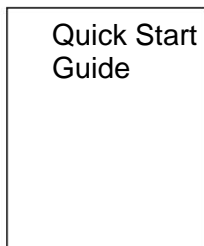

User's manual (CD)

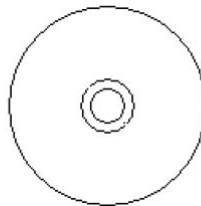

Stylus

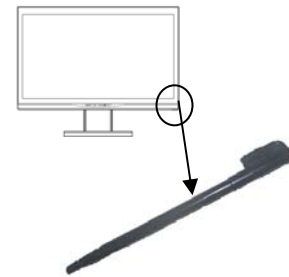

Use the provided stylus as a touch pointing device. However, the stylus is not required for optical touch applications; for example, finger and other pointing instruments may be used.

If any component is missing, please contact your local dealer for technical support or customer service.

Note: Please keep the original carton and packing materials for future transportation or shipment of the display.

Connection instructions

Installing the display

Install: Remove:

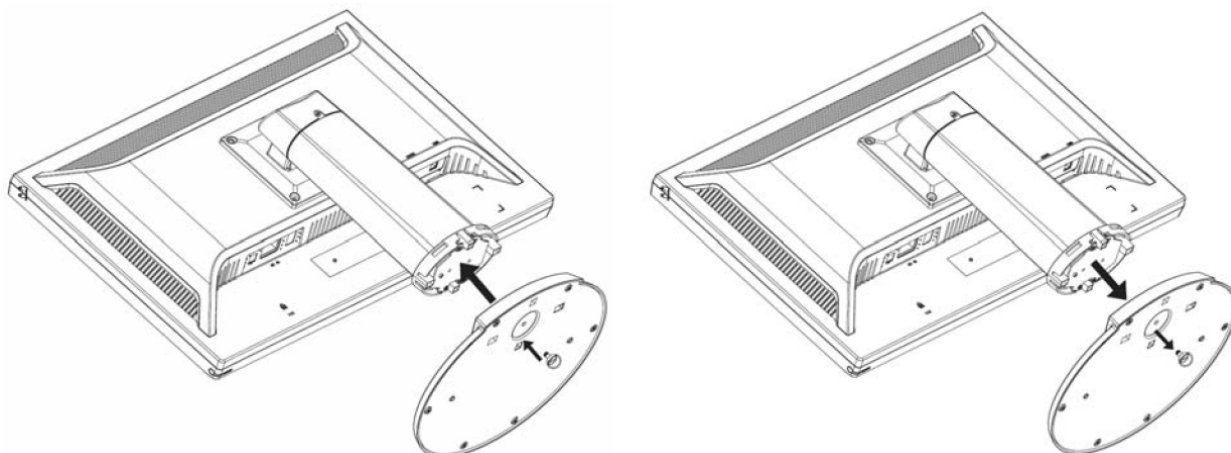

Place the display on the table (Figure 1)

Packaging procedures

If you need to package the display again, please keep the original carton and packing materials. The procedures for re-packaging the display are as follows:

1. Unplug the power cord from the display (make sure all attached peripherals are already turned off).
2. Put the display into the carton in the original packaging manner.



Important

Before you start, place a clean towel or cloth on a flat surface, on which you can place the removed display panel without being damaged.

Adjusting the viewing angle

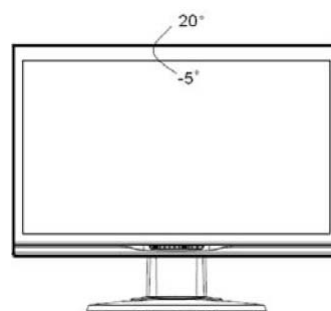

You may adjust the display's viewing angle from -5° ~ 20° . (Figure 2)

Note:

- When you adjust the viewing angle of the display, avoid touching the LCD display with your fingers, as this may damage or break the liquid crystal screen.
- When you adjust the angle of your display, pay attention to your adjustment action, as shown in the figure above.

Connection instructions

CAUTION: Before installation, please make sure to power off the display and the computer.

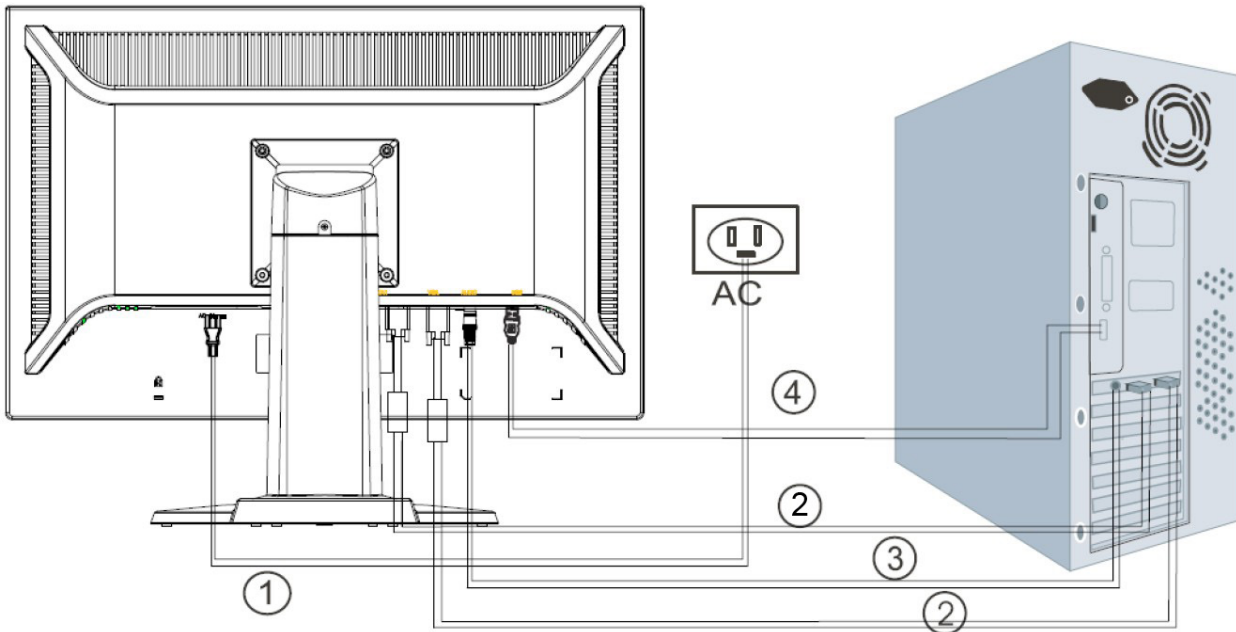

(Figure 3)

①	Power cord	Connect one end of the power cord into the AC power connector on the rear of the display, and the other end to an electrical wall outlet.
②	VGA cable	Connect the signal cable: <ul style="list-style-type: none"> - For analog operation use the VGA cable. Connect the VGA signal cable to the VGA connector on the rear of the PC. - For digital operation use the DVI-D cable. Connect the DVI-D signal cable to the DVI connector on the rear of the monitor and the other end to the DVI connector on the rear of the PC.
③	Audio cable	Connector one end of the audio cable to the audio-in connector on the rear of the display, and the other end of the cable to the audio-out jack on the PC.
④	USB cable	Connect one end of the USB cable to the USB connector on the display, and the other end of the USB cable to the PC.



Warning:

1. Please verify the video card you are using and use an appropriate signal cable.
2. Pay attention to the PIN assignments and connection directions. Do not force to avoid bending the pins.

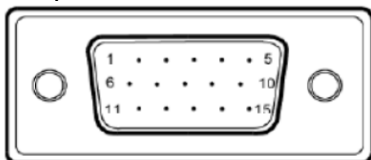

VGA (D-sub 15 pin)

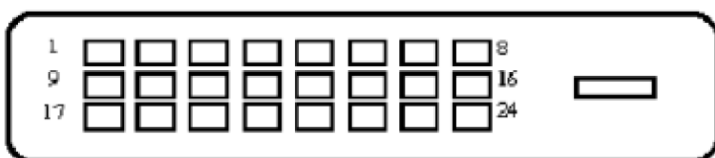

DVI

Using the display

Turning on the display

Turn on the display before turning on the computer. When the power is on, the LED on the power button lights blue and the screen image will appear after about 10 seconds. If the LED doesn't light blue or no image appears, please verify if the display is properly connected.

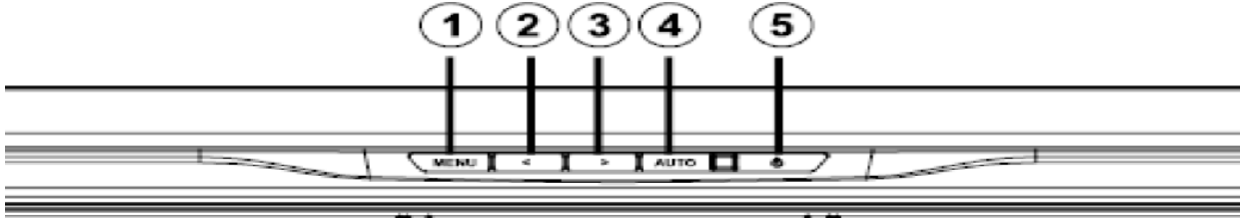

(Figure 4)

Function controls

1	MENU	OSD function menu	OSD off: Displays the OSD function menu OSD on: Confirm the OSD function option
2	<	Left/decrease button	OSD off: Press this button directly to serve as the shortcut for input OSD on: Press this button to select/decrease the adjustment
3	>	Right/increase button	OSD on: Press this button to select/increase the adjustment
4	AUTO	Auto adjustment button	OSD off: Perform the auto adjustment function OSD on: Exit the OSD function menu
5	POWER	Power Switch	Power ON/OFF Blue LED - Power ON mode Orange LED - Power saving mode

Installing the Touch Driver (for Windows XP only)

Insert the CD-ROM into the Computer CD-ROM drive. The CD menu is displayed (or open Windows Explorer and run the Touch_Driver_Setup.exe from the CD).

Step 1: Click “Install Touch Driver for Microsoft Windows XP” from the CD menu

NOTE: The monitor ships only with Windows XP touch drivers. Touch drivers are not required for systems running Microsoft Windows 7 and Vista operating systems.

Step 2: Click “Install”

On Welcome installation window, click **Install**.



After clicking **Install**, the setup wizard shows the installation process.

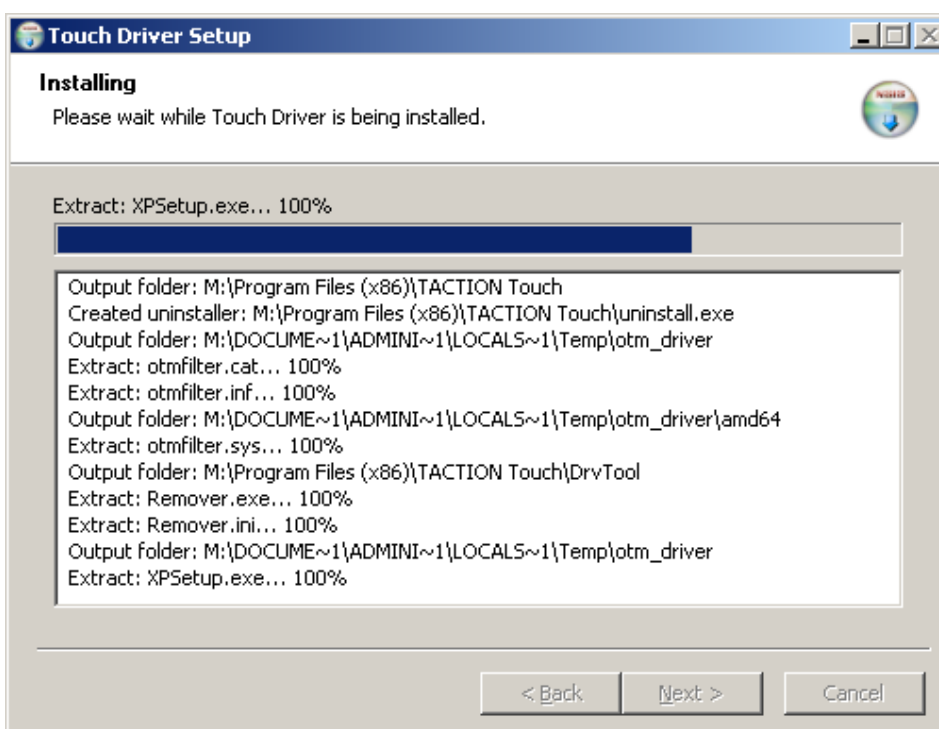

Step 3: Click “Finish”

The driver setup installation is complete.



Step 4: Click “Yes”

After clicking Finish, the setup wizard will prompt you to reboot the computer.

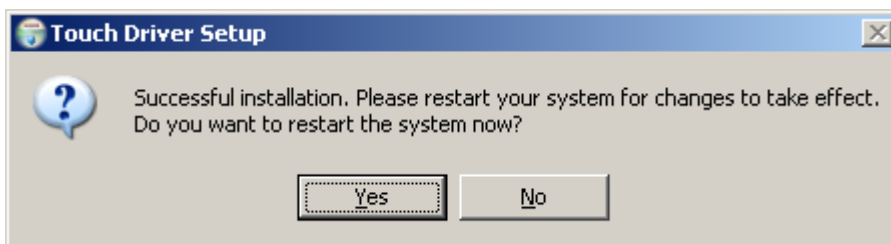

Once the system is restarted, the installation is complete.

Control of the Touch Function

- Note:**
1. Before using the touch function, make sure the USB cable is connected, the touch applications from the CD-ROM are installed if you are running Windows XP and the Windows operating system is started.
 2. When the touch function is active, make sure there is no foreign object in the areas encircled in the figure below.

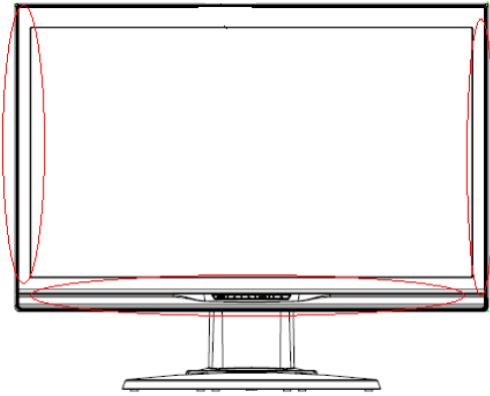

(Figure 5) Make sure there is no foreign object in the encircled areas.

The touch function may replace the mouse after you start the Windows operating system and introduce appropriate gesture judgement. Gesture judgement and related Windows software applications are listed below:

Finger Operation	Windows 7	Windows Vista	Windows XP Tablet	Windows XP
Drag	Y	Y	Y	Y
Click	Y	Y	Y	Y
Double-click	Y	Y	Y	Y
Single-touch digitizer	Y	Y	Y	N
Multi-touch gestures	Y	N	N	N

Use your finger or the provided stylus for touch applications.

Note:

- Keep the display away from any heat sources such as electric radiators, natural gas pipes or direct sunlight.
Also keep the display away from excessive dust, mechanical vibration or shock.
- Retain the original carton & packaging materials. They will be convenient for you, if you need to transport your display again.
- For best protection, pack the display in the original manner of package from the factory.
- To maintain a brand new appearance of the display, clean with soft cloth regularly. Please remove stubborn stains with soft cleaner rather than strong cleaners such as diluting agent, benzene or corrosive cleaner as they may damage the display. For the sake of safety, remove the power plug prior to cleaning.
- The touch function may need about 7 seconds to resume if the USB cable is re-plugged or the computer resumes from sleep mode (suspend mode).

OSD selection

Press the Menu button to activate the OSD function menu and continue pressing the Menu button to select an option from the 7 functions in the menu. Select the function you want to adjust on the OSD function menu and then press MENU to make adjustment. Please use <or> to adjust the screen to your desired status. After finishing the setting, press AUTO to exit the OSD screen.

OSD Menu

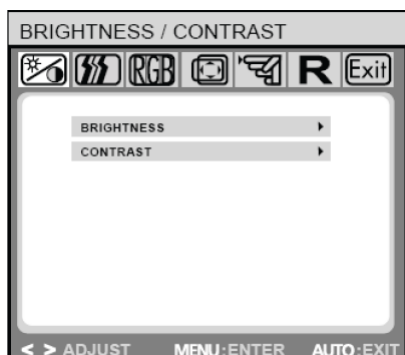

Brightness/Contrast

Brightness: Press < or > (② and ③ in Figure 4) to adjust the brightness.

Contrast: Press < or > (② and ③ in Figure 4) to adjust the contrast.

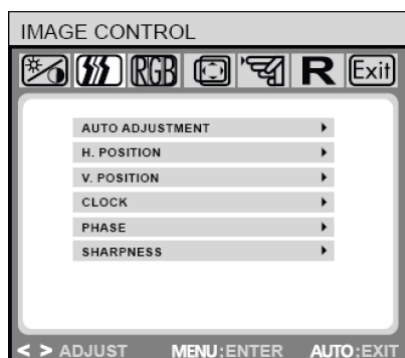

IMAGE CONTROL

Auto Adjustment: Automatically selects the optimal settings for image parameters.

H.POSITION: Controls the picture's horizontal position.

V.POSITION: Controls the picture's vertical position.

CLOCK: Sets up the internal clock. Larger values make the displayed image appear wider; smaller values make it appear compressed.

PHASE: Adjusts the internal clock's time lag in order to optimize the screen image.

SHARPNESS: Controls image sharpness.

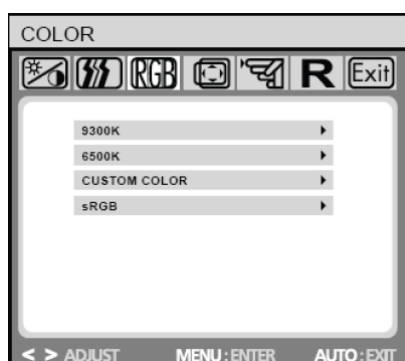

COLOR

This menu lets you select a preset color temperature (9300K, 6500K or sRGB) by pressing the OSD buttons < or >. Changes to the color temperature take immediate effect on screen. If you wish to set individual color values, select the Custom Color option.

Then press the MENU button to select the red, green and blue settings and set the desired value using the OSD buttons < or >.

The current settings are automatically saved when you return to the previous level or exit the OSD menu.

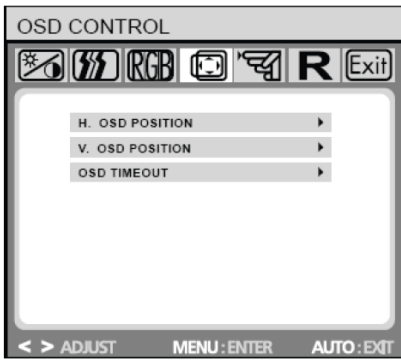

OSD CONTROL

H.OSD POSITION: Controls the OSD menu's horizontal position.

V.OSD POSITION: Controls the OSD menu's vertical position.

OSD TIMEOUT: Determines how long (in seconds) the OSD menu waits before closing automatically after no action has been performed.

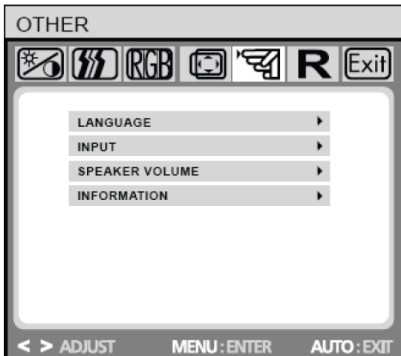

OTHER

LANGUAGE: OSD menu language selection:

ENGLISH, DEUTSCH, FRANCAIS, ESPANOL, ITALIANO, POLSKI, NEDERLANDS, PYCCKO.

INPUT: Selects Analog (D-sub) or Digital (DVI-D) input.

SPEAKER VOLUME: Adjusts the monitor loudspeaker output volume.

INFORMATION: There is an optional OSD window (on/off) that displays the newly adjusted screen resolution settings.

Note: Do not adjust the screen setting when animation is displayed; make sure to adjust the setting in full screen mode.

Troubleshooting

Problems	Possible solutions
Power LED doesn't light up.	<ul style="list-style-type: none">• Check if the power switch is in the ON position• Make sure the power cord is properly connected
No screen image	<ul style="list-style-type: none">• Check if the power switch is in the ON position• Make sure the power cord is properly connected• Make sure the signal cable is securely connected• When the display is in use, it will automatically turn off to enter the power saving mode. Please press any key to see if the image resumes.
Abnormal colors are present	<ul style="list-style-type: none">• Please refer to the "Color Temperature" section to adjust the RGB color or select a color temperature.
The image bounces or a wave pattern is present	<ul style="list-style-type: none">• Remove any electrical device that may be causing electrical interference.• Check the signal cable and make sure the pins are not bent.
The screen image is not centered or the size is incorrect	<ul style="list-style-type: none">• Press the Auto button to automatically optimize the display status.• Refer to the "Image Control section".

Note: Never disassemble or repair the product yourself. If your problem cannot be solved according to the troubleshooting guidelines, please contact your local dealer.

Production Specifications

LCD panel size	54.61 cm (21.5in)
DCR	3000:1 (typical)
Viewing angle	Horizontal 170°, vertical 160° (typical)
Response time	5 ms (typical)
Brightness	265 cd/m ² (typical)
Input signal	Analog signal (D-sub); digital signal (DVI)
Display color	16.7 M colors
Frequency	24 ~ 83 kHz Horizontal, 50 ~ 76 Hz Vertical
Optimum graphic resolution	1920 x 1080(60Hz)
Max Pixel clock	180 MHZ
Tilt	-5° ~ 20°
Audio output	1W X 2
Power supply	AC: 100-240V ~ 50-60Hz;
Power consumption	Display mode: Max 48W; LED color: Blue Sleeping mode: Less than 1W, LED color: Orange
Size	Width: 513 mm, Height: 393 mm, Depth: 228 mm Width: 20.2 in, Height: 15.5 in, Depth: 9 in
Weight	6.4 kg/14.1 lb (net)
Environmental conditions	Operating temperature/humidity: 5 ~ 35°C, relative humidity: 10-85% Storage temperature/humidity: 5 ~ 35°C, relative humidity: 10-85%

Preset Modes

Preset	Pixel	Horz Freq (kHz)	Horz Polarity	Vert Freq (Hz)	Vert Polarity	Pixel Clk (MHz)	Source
1	640 x 480	31.469	-	59.940	-	25.175	VGA
2	720 x 400	31.469	-	70.087	+	28.322	VGA
3	800 x 600	37.879	+	60.317	+	40.000	VESA
4	1024 x 768	48.363	-	60.004	-	65.000	VESA
5	1280 x 720	45.00	+	60.00	+	74.25	VESA/CEA-861D
6	1280 x 960	60.00	±	60.00	±	108.000	VESA
7	1280 x 1024	63.98	+	60.02	+	108.000	VESA
8	1440 x 900	55.94	-	59.89	+	106.500	CVT 1.30MA
9	1600 x 1200	75.00	+	60.00	+	162.000	VESA
10	1680 x 1050	65.29	-	60.0	+	146.25	CVT 1.76MA
11	1920 x 1080	67.5	+	60.00	+	148.5	VESA/CEA-861D

Appendix

Connector pin assignment

- **15 pin** color display signal cable:

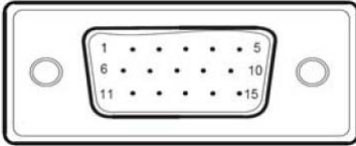

PIN No.	Description	PIN No.	Description
1.	Red	9.	+5V
2.	Green	10.	Logic ground
3.	Blue	11.	Monitor ground
4.	Monitor ground	12.	DDC-serial data
5.	DDC-return	13.	H-sync
6.	R-ground	14.	V-sync
7.	G-ground	15.	DDC-serial time sequence
8.	B-ground		

- **24 pin** DVD-D display signal cable:

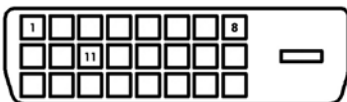

Pin No.	Description	Pin No.	Description
1	TMDS Data 2 -	13	TMDS Data 3 +
2	TMDS Data 2 +	14	+3.3/+5V Power (from PC)
3	TMDS Data 2 / 4 Shield	15	Ground (Return for +5V)
4	TMDS Data 4 -	16	Hot Plug Detect
5	TMDS Data 4 +	17	TMDS Data 0 -
6	DDC Clock	18	TMDS Data 0 +
7	DDC Data	19	TMDS Data 0 / 5 Shield
8	No Connect	20	TMDS Data 5 -
9	TMDS Data 1 -	21	TMDS Data 5 +
10	TMDS Data 1 +	22	TMDS Clock Shield
11	TMDS Data 1 / 3 Shield	23	TMDS Clock +
12	TMDS Data 3 -	24	TMDS Clock -

Free Manuals Download Website

<http://myh66.com>

<http://usermanuals.us>

<http://www.somanuals.com>

<http://www.4manuals.cc>

<http://www.manual-lib.com>

<http://www.404manual.com>

<http://www.luxmanual.com>

<http://aubethermostatmanual.com>

Golf course search by state

<http://golfingnear.com>

Email search by domain

<http://emailbydomain.com>

Auto manuals search

<http://auto.somanuals.com>

TV manuals search

<http://tv.somanuals.com>