



LV1561w, LV1561ws, LV1561x,
CQ1569, and CQ1569x LCD Monitors

User Guide

© 2009, 2011 Hewlett-Packard
Development Company, L.P.

Microsoft, Windows, and Windows Vista are either trademarks or registered trademarks of Microsoft Corporation in the United States and/or other countries.

The only warranties for HP products and services are set forth in the express warranty statements accompanying such products and services. Nothing herein should be construed as constituting an additional warranty. HP shall not be liable for technical or editorial errors or omissions contained herein.

This document contains proprietary information that is protected by copyright. No part of this document may be photocopied, reproduced, or translated to another language without the prior written consent of Hewlett-Packard Company.

Third Edition (August 2011)

Document Part Number: 518115-003

About This Guide

This guide provides information on setting up the monitor, installing drivers, using the on-screen display menu, troubleshooting and technical specifications.

 **WARNING!** Text set off in this manner indicates that failure to follow directions could result in bodily harm or loss of life.

 **CAUTION:** Text set off in this manner indicates that failure to follow directions could result in damage to equipment or loss of information.

 **NOTE:** Text set off in this manner provides important supplemental information.

Table of contents

1 Product Features	1
LCD Monitors	1
2 Safety and Maintenance Guidelines	2
Important Safety Information	2
Monitor Placement Considerations	2
Maintenance Guidelines	3
Cleaning the Monitor	4
Shipping the Monitor	4
3 Setting Up the Monitor	5
Installing the Monitor Base	5
Identifying Rear Components	6
Connecting the Cables	7
Mounting the Monitor	8
Locating the Rating Labels	10
4 Operating the Monitor	11
Installing the Driver	11
Installing from the CD	11
Downloading from the Internet	11
Setting the Optimal Resolution	11
Front Panel Controls	11
Adjusting the Monitor Settings	13
OSD Menu Selections	13
Using the Auto-Adjustment Function	17
Using the Auto-Adjustment Pattern Software (Select Models)	17
Appendix A Troubleshooting	18
Solving Common Problems	18
Online Technical Support	19
Preparing to Call Technical Support	19
Appendix B Technical Specifications	20
Recognizing Preset Display Resolutions	21

Entering User Modes	22
Energy Saver Feature	22
Plug & Play DDC2B Feature	22

Appendix C Agency Regulatory Notices 23

Federal Communications Commission Notice	23
Modifications	23
Cables	23
Declaration of Conformity for Products Marked with the FCC Logo (United States Only)	23
Canadian Notice	24
Avis Canadien	24
European Union Regulatory Notice	24
German Ergonomics Notice	25
Japanese Notice	25
Korean Notice	25
Power Cord Set Requirements	25
Japanese Power Cord Requirements	25
Product Environmental Notices	26
ENERGY STAR® Qualification	26
Materials Disposal	26
Disposal of Waste Equipment by Users in Private Household in the European Union	27
HP Recycling Program	27
Chemical Substances	27
Restriction of Hazardous Substances (RoHS)	27
Turkey EEE Regulation	28
Україна обмеження на наявність небезпечних речовин (Ukraine restriction of hazardous substances)	28

Appendix D LCD Monitor Quality and Pixel Policy 29

1 Product Features

LCD Monitors

The LCD (liquid crystal display) monitors have an active matrix, thin-film transistor (TFT) panel. The monitor models and features include:

- 39.5 cm (15.6-inch) viewable area display
- 1366 x 768 resolution, plus full-screen support for lower resolutions
- Non-glare panel with an LED backlight that provides better clarity and consumes less energy than traditional CCFL backlights (LV1561x and CQ1569x models)
- Tilt capability
- Video signal input to support VGA analog with VGA signal cable provided
- Removable base and VESA 75mm mounting holes for flexible monitor panel mounting solutions
- Built-in stereo speakers with audio cable provided (select models)
- Plug and play capability if supported by the system
- On-Screen Display (OSD) adjustments in several languages for easy setup and screen optimization
- Software and documentation CD that includes driver and product documentation (select models)
- Energy Saver feature for Energy Star compliance
- Security lock slot
- Energy Star qualified
- Compliant with the following regulated specifications:
 - European Union CE Directives

2 Safety and Maintenance Guidelines

Important Safety Information

A power cord is included with the monitor. If another cord is used, use only a power source and connection appropriate for this monitor. For information on the correct power cord set to use with the monitor, refer to the [Power Cord Set Requirements on page 25](#) in Appendix C.

⚠ WARNING! To reduce the risk of electric shock or damage to the equipment:

- Do not disable the power cord grounding feature. The grounding plug is an important safety feature.
- Plug the power cord in a grounded (earthed) outlet that is easily accessible at all times.
- Disconnect power from the product by unplugging the power cord from the electrical outlet.

For your safety, do not place anything on power cords or cables. Arrange them so that no one may accidentally step on or trip over them. Do not pull on a cord or cable. When unplugging from the electrical outlet, grasp the cord by the plug.

To reduce the risk of serious injury, read the *Safety and Comfort Guide*. It describes proper workstation, setup, posture, and health and work habits for computer users, and provides important electrical and mechanical safety information. This guide is located on the Web at <http://www.hp.com/ergo> and/or on the documentation CD, if one is included with the monitor.

⚠ CAUTION: For the protection of the monitor, as well as the computer, connect all power cords for the computer and its peripheral devices (such as a monitor, printer, scanner) to some form of surge protection device such as a power strip or Uninterruptible Power Supply (UPS). Not all power strips provide surge protection; the power strips must be specifically labeled as having this ability. Use a power strip whose manufacturer offers a Damage Replacement Policy so you can replace the equipment, if surge protection fails.

Use the appropriate and correctly sized furniture designed to properly support your HP LCD monitor.

⚠ WARNING! LCD monitors that are inappropriately situated on dressers, bookcases, shelves, desks, speakers, chests, or carts may fall over and cause personal injury.

Care should be taken to route all cords and cables connected to the LCD monitor so that they can not be pulled, grabbed, or tripped over.

Monitor Placement Considerations

For displays with glossy bezels, the user should consider the placement of the display to minimize disturbing reflections from surrounding light and bright surfaces.

Maintenance Guidelines

To enhance the performance and extend the life of the monitor:

- Do not open the monitor cabinet or attempt to service this product yourself. Adjust only those controls that are covered in the operating instructions. If the monitor is not operating properly or has been dropped or damaged, contact an authorized HP dealer, reseller, or service provider.
- Use only a power source and connection appropriate for this monitor, as indicated on the label/back plate of the monitor.
- Be sure the total ampere rating of the products connected to the outlet does not exceed the current rating of the electrical outlet, and the total ampere rating of the products connected to the cord does not exceed the rating of the cord. Look on the power label to determine the ampere rating (AMPS or A) for each device.
- Install the monitor near an outlet that you can easily reach. Disconnect the monitor by grasping the plug firmly and pulling it from the outlet. Never disconnect the monitor by pulling the cord.
- Turn the monitor off when not in use. You can substantially increase the life expectancy of the monitor by using a screen saver program and turning off the monitor when not in use.



NOTE: Monitors with a “burned-in image” are not covered under the HP warranty.

- Slots and openings in the cabinet are provided for ventilation. These openings must not be blocked or covered. Never push objects of any kind into cabinet slots or other openings.
- Do not drop the monitor or place it on an unstable surface.
- Do not allow anything to rest on the power cord. Do not walk on the cord.
- Keep the monitor in a well-ventilated area, away from excessive light, heat or moisture.
- When removing the monitor base, you must lay the monitor face down on a soft area to prevent it from getting scratched, defaced, or broken.

Cleaning the Monitor

1. Turn off the monitor and unplug the power cord from the back of the unit.
2. Dust the monitor by wiping the screen and the cabinet with a soft, clean antistatic cloth.
3. For more difficult cleaning situations, use a 50/50 mix of water and Isopropyl alcohol.

⚠ CAUTION: Spray the cleaner onto a cloth and use the damp cloth to gently wipe the screen surface. Never spray the cleaner directly on the screen surface. It may run behind the bezel and damage the electronics.

CAUTION: Do not use cleaners that contain any petroleum based materials such as benzene, thinner, or any volatile substance to clean the monitor screen or cabinet. These chemicals may damage the monitor.

Shipping the Monitor

Keep the original packing box in a storage area. You may need it later if you move or ship the monitor.

3 Setting Up the Monitor

To set up the monitor, ensure that the power is turned off to the monitor, computer system, and other attached devices, then follow the instructions below.

Installing the Monitor Base

To install the monitor base:

1. Place the base on a smooth, flat surface.
2. Align the pedestal column on top of the base and press down to install.
3. Using both hands, position the monitor over the pedestal base.

 **NOTE:** Do not install the base if the monitor will be used on a wall, swing arm, or other mounting fixture; instead see [Mounting the Monitor on page 8](#) in this chapter.

4. Press down firmly to lock the pedestal base in place. When the base locks, it will make a clicking sound.

 **NOTE:** Be sure the pedestal base is securely locked before continuing with the setup.

Figure 3-1 Inserting the Monitor into the Pedestal Base



Identifying Rear Components

Figure 3-2 Rear Components

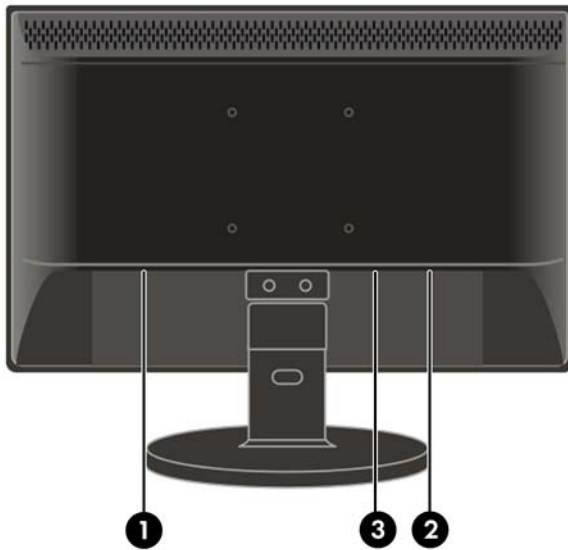

Component	Function
1 AC Power Connector	Connects the AC power cord to the monitor.
2 VGA Connector	Connects the VGA (15-pin D-Sub) cable to the monitor.
3 Audio Port (select models)	Connects the audio cable (provided with select models) to the monitor.

Connecting the Cables

1. Place the monitor in a convenient, well-ventilated location near the computer.
2. Connect the power cable to the AC power connector on the back of the monitor.

⚠ WARNING! To reduce the risk of electric shock or damage to the equipment:

Do not disable the power cord grounding plug. The grounding plug is an important safety feature.

Plug the power cord into a grounded (earthed) electrical outlet that is easily accessible at all times.

Disconnect power from the equipment by unplugging the power cord from the electrical outlet.

For your safety, do not place anything on power cords or cables. Arrange them so that no one may accidentally step on or trip over them. Do not pull on a cord or cable. When unplugging from the electrical outlet, grasp the cord by the plug.

3. Connect one end of the VGA 15-pin D-Sub cable to the back of the monitor and connect the other end to the computer's D-Sub port.
4. Connect the audio cable to Audio IN port (available on select models) on the back of the monitor.
5. Adjust the monitor as needed for your comfort using the monitor's tilt adjustment capability.
 - For optimal viewing it is recommended to look at the full face of the monitor, then adjust the monitor's angle to your own preference.
 - Hold the stand so you do not topple the monitor when you change the monitor's angle.
 - You are able to adjust the monitor's angle from -5° to 20° .

📄 NOTE: Do not touch the LCD screen when you change the angle. It may cause damage or break the LCD screen.

Figure 3-3 Tilting the Monitor

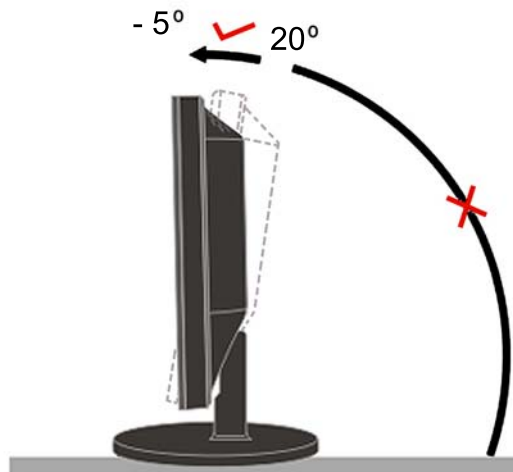

6. Press the power switch to turn on the monitor.

⚠ CAUTION: Burn-in image damage may occur on monitors that display the same static image on screen for a prolonged period of time. To avoid burn-in image damage on your monitor screen, you should always activate a screen saver application or turn off the monitor when it is not in use for a prolonged period of time. Image retention is a condition that may occur on all LCD screens.

Mounting the Monitor

You can remove the monitor base to mount the monitor on a wall, a swing arm, or other mounting fixture.

Four threaded mounting holes are provided on the monitor back panel to be used for mounting purposes. These mounting holes are 75mm apart and are compliant with the Video Electronics Standards Association (VESA) standard for mounting flat panel displays.

⚠ CAUTION: This monitor supports the VESA industry standard 75 mm mounting holes. To attach a third-party mounting solution to the monitor, four 4 mm, 0.7 pitch, and 10 mm long screws are required. Longer screws must not be used because they may damage the monitor. It is important to verify that the manufacturer's mounting solution is compliant with the VESA standard and is rated to support the weight of the monitor display panel. For best performance, it is important to use the power and video cables provided with the monitor.

1. Disconnect and remove the signal and power cables from the back of the monitor.
2. Lay the monitor face down on a flat surface.

⚠ CAUTION: Do not remove the base from the monitor while the monitor is in the upright position. Lay the front bezel down on a soft area to prevent it from getting scratched, defaced, or broken. Ensure that the bottom of the monitor base is positioned over a table or desktop before removing the base from the monitor.

3. Remove the pedestal base as shown in the following illustration.
4. Place the mounting fixture onto the back of the monitor. Line up the holes on the mounting fixture with the holes in the back of the monitor.
5. Insert four screws into the holes and tighten.
6. Reconnect the cables.

7. Refer to the user manual that came with the optional mounting fixture additional mounting instructions.

Figure 3-4 Removing the Monitor Base

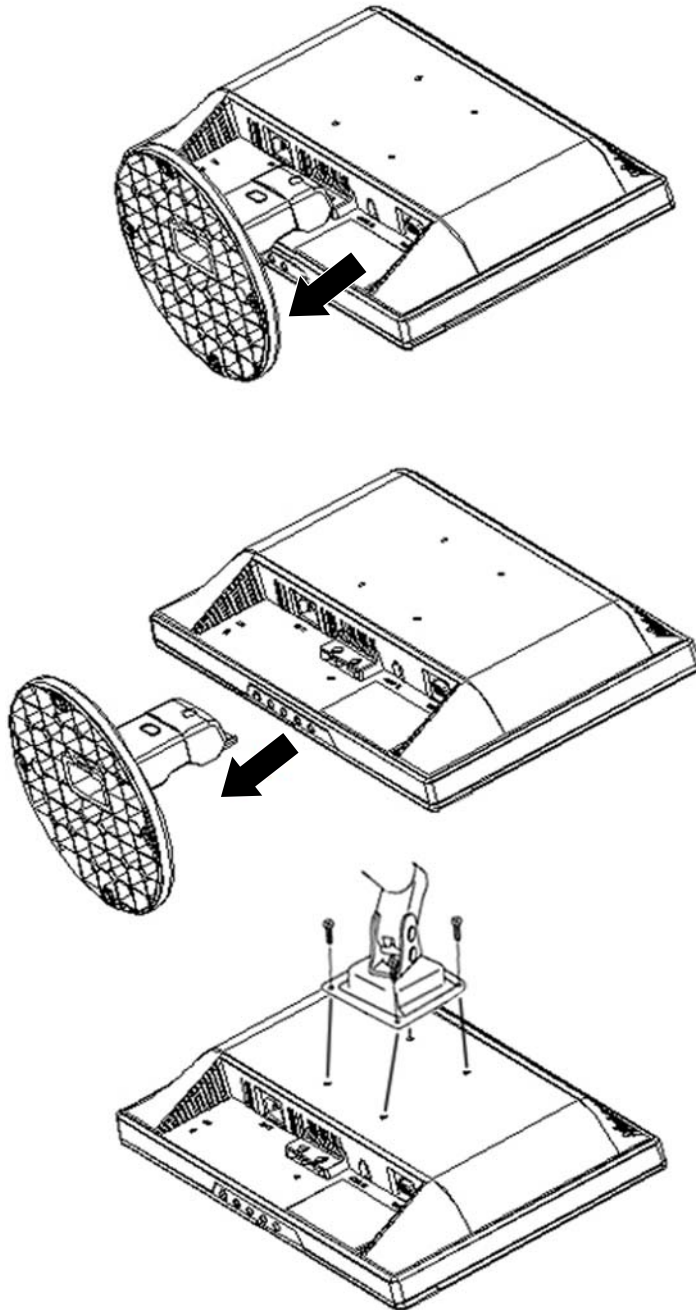

Locating the Rating Labels

The rating labels on the monitor provide the spare part number, product number, and serial number. You may need these numbers when contacting HP about the monitor model.

The rating labels are located on the back of the monitor.

4 Operating the Monitor

Installing the Driver

You can install the monitor-driver INF and ICM files from the CD (included with select models) or download from the Internet.

Installing from the CD

To install the .INF and .ICM files on the computer from the CD:

1. Insert the CD in the computer CD-ROM drive. The CD menu is displayed.
2. Select the language.
3. View the **Monitor Driver Software Readme** file.
4. Select **Install Monitor Driver Software**.
5. Follow the on-screen instructions.
6. Ensure that the proper resolution and refresh rates appear in the Windows Display control panel.



NOTE: You may need to install the digitally signed monitor .INF and .ICM files manually from the CD in the event of an installation error. Refer to the Monitor Driver Software Readme file on the CD.

Downloading from the Internet

To download the latest version of .INF and .ICM files from the HP monitors support Web site:

1. Refer to <http://www.hp.com/support> and select the country region.
2. Select **Download Drivers and Software**.
3. Enter the model number of the monitor. The software download pages for the monitor are displayed.
4. Ensure the system meets the requirements.
5. Download the software by following the instructions.

Setting the Optimal Resolution

The recommended resolution for this monitor is 1366 x 768. To configure the monitor to this resolution, do the following.

1. Click the Windows **Start** button, and then select **Control Panel**.
2. Under **Appearance and Personalization**, select **Adjust Screen Resolution**.
3. Set the resolution **slide bar** to 1366 x 768.

Front Panel Controls

The front panel control buttons lets you adjust the monitor's picture settings to your personal preferences.

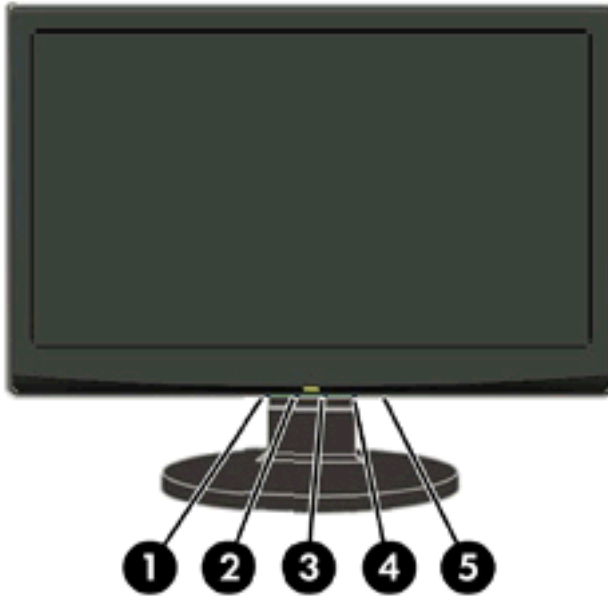

Table 4-1 Monitor Front Panel Controls

Control	Function
1 Auto/OK	When the OSD is open, press to select the menu. When the OSD is closed, press to activate the auto-adjustment function.
2 – (Minus)	When the OSD is closed, press to activate the volume adjustment bar. When the OSD is open, press – to navigate through the OSD menu or change the setting of a selected function; adjusts volume (for models with speakers).
3 + (Plus)	When the OSD is closed, press to activate the volume adjustment bar. When the OSD open, press + to navigate through the OSD menu or change the setting of a selected function; adjusts volume (for models with speakers).
4 Menu	Press to open the OSD window.
5 Power	Turns the monitor on and off. LED status: <ul style="list-style-type: none"> • Full Power Mode - Green or Blue • Active-off Mode - Orange or Red

Adjusting the Monitor Settings

The monitor settings can be adjusted from the On-Screen Display (OSD) menu. To access the OSD and adjust screen settings base on your viewing preference, do the following:

1. If the monitor is not already on, press the power button to turn on the monitor. The power indicator will light up.
2. To access the OSD menu, press the **Menu** button.
3. To navigate through the Main Menu, press the **-** or **+** buttons. Once the desired function is highlighted, press the **Menu** button to activate the Submenu. Press the **Menu** button to select the highlighted function.
4. Press the **-** or **+** button to change the settings of the selected function. Press the **-** or **+** button to select another function in the Submenu.
5. Press **Auto/OK** to select the highlighted function.

If you want to adjust any other function, repeat steps 3-4.

OSD Lock Function: This function locks the OSD in order to keep the current menu settings or prevent others from adjusting the current settings.

- To lock the OSD, press and hold the **Menu** button for 10 seconds.
- To unlock the OSD, press and hold the **Menu** button for 10 seconds.

Power Button Lockout: Indicates the power button is locked. If the power button is locked, the warning message **Power Button Lockout** displays.

- If the power button is locked, press and hold the power button for 10 seconds to unlock the power button function.
- If the power button is unlocked, press and hold the power button for 10 seconds to lock out the power button function.

Volume adjustment hot key: When the OSD window is closed, press **+** or **-** to activate the volume adjustment bar, and then press **-** or **+** to adjust the volume (only for the models with speakers).

Auto-Adjustment hot key: When the OSD window is closed, press the **Auto** button to activate the auto-adjustment feature to optimize the screen image.

OSD Menu Selections

The following table lists the On-Screen Display (OSD) menu selections and their functional descriptions.

Table 4-2 OSD Menu





Icon	Main Menu	Submenu	Description
	Brightness	Adjustable scale	Adjusts the brightness level of the screen.
	Contrast	Adjustable scale	Adjusts the contrast level of the screen.
	Image Control		Adjusts the screen image. (VGA input only)
		Auto Adjustment	Automatically adjusts the screen image.

Table 4-2 OSD Menu (continued)











Icon	Main Menu	Submenu	Description
		Horizontal Position	Adjusts the position of the screen image left and right.
		Vertical Position	Adjusts the position of the screen image up and down.
		Custom Scaling	<p>Selects the method on how displayed information on the monitor will be formatted. Select:</p> <ul style="list-style-type: none"> • Fill to Screen - image fills the entire screen and may look distorted or elongated because of non-proportional scaling of height and width • Fill to Aspect Ratio - image is sized to fit the screen and maintains proportional image
		Clock	Minimizes any vertical bars or strips visible on the screen background. Adjusting the Clock will also change the horizontal screen image.
		Clock Phase	Adjusts the focus of the display. This adjustment allows you to remove any horizontal noise and clear or sharpen the image of characters.
	Color		Selects the screen color. The factory default is 6500K or Custom Color, depending on the model.
		9300 K	Changes to slightly blueish white.
		6500 K	Changes to slightly reddish white.
		Custom Color	<p>Selects and adjusts your own color scales:</p> <ul style="list-style-type: none"> • R—sets your own red color levels • G—sets your own green color levels • B—sets your own blue color levels
	QuickView		Selects viewing mode.
		Movie	Selects the movie mode.
		Photo	Selects the photo mode.
		Gaming	Selects the gaming mode.
		Text	Selects the text mode.
		Custom	Settings saved when user adjusts the Brightness, Contrast, or Color in one of the QuickView options.
	Language		Selects the language in which the OSD menu is displayed.
	Management		Selects the power-management features of the monitor.
		Volume	Adjusts the volume level.

Table 4-2 OSD Menu (continued)









Icon	Main Menu	Submenu	Description
		OSD Control	Adjusts the position of the OSD menu screen to: <ul style="list-style-type: none">• Horizontal OSD Position-Changes the viewing position of the OSD menu to the left or right area of the screen. The factory default range is 50.• Vertical OSD Position-Changes the viewing position of the OSD menu to the top or bottom area of the screen. The factory default range is 50.• OSD Transparency-Adjust to view the background information through the OSD• OSD Timeout-Sets the time duration in seconds that the OSD is visible after the last button is pressed. The factory default is 30 seconds.
		Power Saver	Enables the power saving feature (see Energy Saver Feature on page 22). Select: <ul style="list-style-type: none">• On• Off
		Mode Display	Displays the resolution, refresh rate and frequency information on the screen each time the OSD Main Menu is accessed. Select: <ul style="list-style-type: none">• On• Off
		Power-On Status Display	Displays the operating status of the monitor each time the monitor is powered on. Select the location to display the status to: <ul style="list-style-type: none">• Top• Middle• Bottom• Off
		DDC/CI Support	Allows the computer to control some OSD menu features such as brightness, contrast and color temperature. Set to: <ul style="list-style-type: none">• On• Off
		Bezel Power LED	Turns the light (LED) in the power button On and Off. When set to Off, the light will remain off at all times.

Table 4-2 OSD Menu (continued)

Icon	Main Menu	Submenu	Description
		Sleep Timer	Provides the timer adjustment menu options: <ul style="list-style-type: none">• Set Current Time—sets the current time in hours and minutes• Set Sleep Time—sets the time you want to place the monitor in sleep mode• Set on Time—sets the time you want the monitor to wake up from sleep mode• Timer—sets the Sleep Timer feature On or Off. The default setting is Off• Sleep Now—immediately sets the monitor to enter sleep mode
	Information		Selects and displays important information about the monitor.
		Current Settings	Provides the current input video mode.
		Recommended Settings	Provides the recommended resolution mode and refresh rate for the monitor.
		Serial Number	Reports the serial number of the monitor. The serial number is needed if contacting HP technical support.
		Version	Reports the firmware version of the monitor.
		Backlight Hours	Reports the total hours of backlight operation.
		Service Support	For service support, go to http://www.hp.com/support .
	Factory Reset		Returns settings to factory defaults.

Using the Auto-Adjustment Function

You can optimize the screen performance for the VGA (analog) input by using the **Auto/OK** button on the monitor.

This procedure can correct the following image quality conditions:

- Fuzzy or unclear focus
- Ghosting, streaking or shadowing effects
- Faint vertical bars
- Thin, horizontal scrolling lines
- An off-center picture

To use the auto-adjustment feature:

1. Allow the monitor to warm up for 20 minutes before adjusting.
2. Press the **Auto/OK** button on the monitor front panel. You can also press the **Menu** button to open the OSD window, then select the Image Control, followed by Auto-Adjustment.

Using the Auto-Adjustment Pattern Software (Select Models)

If a CD is provided with your monitor, use the Auto-Adjustment Pattern software provided on the CD to improve the screen image.

1. Insert the CD in your computer CD drive. The CD menu is displayed.
2. Select the language.
3. Select **Open Auto-Adjustment Software**. The setup test pattern displays.
4. Press the **Auto/OK** button on the monitor front panel to produce a stable, centered image.
5. Press the **ESC** key or any other key on the keyboard to exit the test pattern.

A Troubleshooting

Solving Common Problems

The following table lists possible problems, the possible cause of each problem, and the recommended solutions.

Problem	Possible Cause	Solution
Power LED is not on.	Monitor is not turned on or plugged in.	Be sure to press the power button to turn on the monitor and that the power cord is properly connected to a grounded power outlet and to the monitor.
No Plug & Play.	Computer is not Plug & Play compatible.	In order for the Plug & Play feature of the monitor to work, you need a Plug & Play compatible computer & video card. Check with your computer manufacturer. Also check the monitor's video cable and make sure none of the pins are bent Make sure the HP monitor driver is installed (HP monitor drivers are available at http://www.hp.com or on the monitor CD if one is provided).
Picture is fuzzy and has ghosting shadowing problem.	Screen image may need adjusting.	Adjust the contrast and brightness controls. Make sure you are not using an extension cable or switch box. HP recommends plugging the monitor directly into the video card output connector on the back of the computer.
Picture bounces, flickers or wave pattern is present in the picture.	Electrical interference.	Move electrical devices that may cause electrical interference as far away from the monitor as possible. Use the maximum refresh rate your monitor is capable of at the resolution you are using.
Monitor is stuck in active off-mode.	An external device connected to the monitor may be loose or not connected.	Check the following: <ul style="list-style-type: none">• The computer power switch should be in the on position.• The computer video card should be snugly seated in its slot.• Make sure the monitor's video cable is properly connected to the computer.• Inspect the monitor's video cable and make sure none of the pins are bent.• Make sure the computer is operational by pressing the Caps Lock key on the keyboard while observing the Caps Lock LED. The LED should either turn on or off after pressing the Caps Lock key.

Problem	Possible Cause	Solution
Missing one of the primary colors (Red, Green, or Blue).	The video cable or video card is not properly connected.	Inspect the monitor's video cable and make sure that none of the pins are bent. Make sure the monitor's video cable is properly connected to the computer.
Screen image is not centered or sized properly.	Position may need adjustment.	Adjust the Horizontal Position and Vertical Position from the OSD menu or press the Auto/OK button on the front panel to adjust the screen image.
Picture has color defects (white does not look white).	Color needs adjusting.	Adjust RGB color or select Custom Color from the OSD menu.
Horizontal or vertical disturbances on the screen.	Screen image needs adjustment.	Turn off the system using the operating system's Shut Down mode. Turn on the system, then adjust the monitor's Clock and Clock Phase from the OSD menu or press the Auto/OK button on the front panel to adjust the screen image.

Online Technical Support

For the online access to technical support information, self-solve tools, online assistance, community forums of IT experts, broad multivendor knowledge base, monitoring and diagnostic tools, go to <http://www.hp.com/support>

Preparing to Call Technical Support

If you cannot solve a problem using the troubleshooting tips in this section, you may need to call technical support. Have the following information available when you call:

- Monitor model number
- Monitor serial number
- Purchase date on invoice
- Conditions under which the problem occurred
- Error messages received
- Hardware configuration
- Name and version of the hardware and software you are using

B Technical Specifications

 **NOTE:** All performance specifications are provided by the component manufacturers. Performance specifications represent the highest specification of all HP's component manufacturers' typical level specifications for performance and actual performance may vary either higher or lower.

Table B-1 15.6" LCD Monitors

Display	39.5 cm	15.6 inches
Type	TFT LCD	
Viewable Image Size	39.5 cm diagonal	15.6-inch diagonal
Tilt	-5 to 20°	
Maximum Weight (LV1561w, LV1561ws, and CQ1569 models)		
Monitor only	2.7 kg	5.9 lbs
With packaging	3.7 kg	8.15 lbs
Maximum Weight (LV1561x and CQ1569x models)		
Monitor only	1.9 kg	4.19 lbs
With packaging	2.9 kg	6.39 lbs
Dimensions		
Height (with base)	304.7 mm	11.99 inches
Depth	190 mm	7.48 inches
Width	376.3 mm	14.81 inches
Maximum Preset Resolution	1366 x 768 (60 Hz)	
Optimal Preset Resolution	1366 x 768 (60 Hz)	
Pixel Clock	140 MHz	
Plug & Play	VESA DDC2B/CI	
Input Connector	D-Sub 15pin	
Input Video Signal	Analog: 0.7Vp-p (standard), 75 OHM, Positive	
Connector Type	15-pin Mini D-Sub	
Signal Cable Type	Detachable	
Horizontal scan range	24 kHz - 83 kHz	
Horizontal scan Size (Maximum)	344.232 mm	
Vertical scan range	57 Hz - 73 Hz	
Vertical scan Size (Maximum)	193.536 mm	
Speakers (Select Models)	2 x 1W	

Table B-1 15.6" LCD Monitors (continued)

Environmental Requirements		
Temperature		
Operating Temperature	0° to 40° C	32° to 104° F
Storage Temperature	-20° to 60° C	-4° to 140° F
Relative Humidity (LV1561w, LV1561ws, and CQ1569 models)		
Operating	10% to 85% (non-condensing)	
Non-operating	5% to 80% (non-condensing)	
Relative Humidity (LV1561x and CQ1569x models)		
Operating	20% to 85% (non-condensing)	
Non-operating	10% to 85% (non-condensing)	
Power Source (LV1561w, LV1561ws, and CQ1569 models)		
	100 ~ 240 VAC, 50/60 Hz	
Power Source (LV1561x and CQ1569x models)		
	100–240 VAC, 50/60 Hz	
Measured Power Consumption (LV1561x and CQ1569x models with LED Backlight):		
Full Power	≅ 12 W	
Typical Settings	≅ 10 W	
Sleep	≅ 2 W	
Switch Off	≅ 1 W	
Altitude (LV1561w, LV1561ws, and CQ1569 models)		
Operating	0 ~ 3000 m	0 ~ 10000 ft.
Non-operating	0 ~ 5000 m	0 ~ 15000 ft.
Altitude (LV1561x and CQ1569x models)		
Operating	0–3000 m	0–9842 ft.
Non-operating	0–5000 m	0–16404 ft.

Recognizing Preset Display Resolutions

The display resolutions listed below are the most commonly used modes and are set as factory defaults. This monitor automatically recognizes these preset modes and they will appear properly sized and centered on the screen.

Table B-2 Factory Preset Modes

Preset	Pixel Format	Horz Freq (kHz)	Vert Freq (Hz)
1	640 × 480	31.47	59.94
2	800 × 600	37.88	60.32
3	1024 × 768	48.36	60.00

Table B-2 Factory Preset Modes (continued)

4	1280 x 720	45.00	60.00
5	1280 x 1024	63.98	60.02
6	1366 x 768	47.712	59.79

Entering User Modes

The video controller signal may occasionally call for a mode that is not preset if:

- You are not using a standard graphics adapter.
- You are not using a preset mode.

If this occurs, you may need to readjust the parameters of the monitor screen by using the on-screen display. Your changes can be made to any or all of these modes and saved in memory. The monitor automatically stores the new setting, then recognizes the new mode just as it does a preset mode.

Energy Saver Feature

When the monitor is in its normal operating mode, the monitor uses less than 28 watts and the Power light is green or blue.

The monitor also supports a power saver mode that is controlled by the computer. When the monitor is in the reduced-power state, the monitor screen is blank, the backlight is off, and the Power light is amber. The monitor uses minimum power. When the monitor is “awakened,” a brief warm-up period occurs before the monitor returns to normal operating mode. The energy-saving reduced power state activates if the monitor does not detect either the horizontal sync signal or the vertical sync signal. The power-saver feature must be activated on your computer for this feature to work.

Refer to the computer manual for instructions on setting energy saver features (sometimes called power management features).



NOTE: The above power saver feature only works when connected to computers that have energy saver features.

By selecting the settings in the monitor's power saver feature, you can also program the monitor to enter into the reduced power state at a predetermined time. When the monitor's power saver feature causes the monitor to enter the reduced power state, the power light blinks amber.

Plug & Play DDC2B Feature

This monitor is equipped with VESA DDC2B capabilities according to the VESA DDC STANDARD. It allows the monitor to inform the host system of its identity and, depending on the level of DDC used, communicate additional information about its display capabilities.

The DDC2B is a bi-directional data channel based on the I2C protocol. The host can request EDID information over the DDC2B channel.

C Agency Regulatory Notices

Federal Communications Commission Notice

This equipment has been tested and found to comply with the limits for a Class B digital device, pursuant to Part 15 of the FCC Rules. These limits are designed to provide reasonable protection against harmful interference in a residential installation. This equipment generates, uses, and can radiate radio frequency energy and, if not installed and used in accordance with the instructions, may cause harmful interference to radio communications. However, there is no guarantee that interference will not occur in a particular installation. If this equipment does cause harmful interference to radio or television reception, which can be determined by turning the equipment off and on, the user is encouraged to try to correct the interference by one or more of the following measures:

- Reorient or relocate the receiving antenna.
- Increase the separation between the equipment and the receiver.
- Connect the equipment into an outlet on a circuit different from that to which the receiver is connected.
- Consult the dealer or an experienced radio or television technician for help.

Modifications

The FCC requires the user to be notified that any changes or modifications made to this device that are not expressly approved by Hewlett Packard Company may void the user's authority to operate the equipment.

Cables

Connections to this device must be made with shielded cables with metallic RFI/EMI connector hoods to maintain compliance with FCC Rules and Regulations.

Declaration of Conformity for Products Marked with the FCC Logo (United States Only)

This device complies with Part 15 of the FCC Rules. Operation is subject to the following two conditions:

1. This device may not cause harmful interference.
2. This device must accept any interference received, including interference that may cause undesired operation.

For questions regarding the product, contact:

Hewlett Packard Company

P. O. Box 692000, Mail Stop 530113

Houston, Texas 77269-2000

Or, call 1-800-HP-INVENT (1-800 474-6836)

For questions regarding this FCC declaration, contact:

Hewlett Packard Company

P. O. Box 692000, Mail Stop 510101

Houston, Texas 77269-2000

Or, call (281) 514-3333

To identify this product, refer to the Part, Series, or Model number found on the product.

Canadian Notice

This Class B digital apparatus meets all requirements of the Canadian Interference-Causing Equipment Regulations.

Avis Canadien

Cet appareil numérique de la classe B respecte toutes les exigences du Règlement sur le matériel brouilleur du Canada.

European Union Regulatory Notice

Products bearing the CE marking comply with the following EU Directives:

- Low Voltage Directive 2006/95/EC
- EMC Directive 2004/108/EC
- Ecodesign Directive 2009/125/EC, where applicable

CE compliance of this product is valid if powered with the correct CE-marked AC adapter provided by HP.

Compliance with these directives implies conformity to applicable harmonized European standards (European Norms) that are listed in the EU Declaration of Conformity issued by HP for this product or product family and available (in English only) either within the product documentation or at the following web site: <http://www.hp.eu/certificates> (type the product number in the search field).

The compliance is indicated by one of the following conformity markings placed on the product:



For non-telecommunications products and for EU harmonized telecommunications products, such as Bluetooth® within power class below 10mW.



For EU non-harmonized telecommunications products (If applicable, a 4-digit notified body number is inserted between CE and !).

Please refer to the regulatory label provided on the product.

The point of contact for regulatory matters is: Hewlett-Packard GmbH, Dept./MS: HQ-TRE, Herrenberger Strasse 140, 71034 Boeblingen, GERMANY.

German Ergonomics Notice

HP products which bear the “GS” approval mark, when forming part of a system comprising HP brand computers, keyboards and monitors that bear the “GS” approval mark, meet the applicable ergonomic requirements. The installation guides included with the products provide configuration information.

Japanese Notice

この装置は、クラスB情報技術装置です。この装置は、家庭環境で使用することを目的としていますが、この装置がラジオやテレビジョン受信機に近接して使用されると、受信障害を引き起こすことがあります。取扱説明書に従って正しい取り扱いをして下さい。

VCCI-B

Korean Notice

B급 기기
(가정용 방송통신기기)

이 기기는 가정용(B급)으로 전자파적합등록을 한 기기로서 주로 가정에서 사용하는 것을 목적으로 하며, 모든 지역에서 사용할 수 있습니다.

Power Cord Set Requirements

The monitor power supply is provided with Automatic Line Switching (ALS). This feature allows the monitor to operate on input voltages between 100–120V or 200–240V.

The power cord set (flexible cord or wall plug) received with the monitor meets the requirements for use in the country where you purchased the equipment.

If you need to obtain a power cord for a different country, you should purchase a power cord that is approved for use in that country.

The power cord must be rated for the product and for the voltage and current marked on the product's electrical ratings label. The voltage and current rating of the cord should be greater than the voltage and current rating marked on the product. In addition, the cross-sectional area of the wire must be a minimum of 0.75 mm² or 18 AWG, and the length of the cord must be between 6 feet (1.8 m) and 12 feet (3.6 m). If you have questions about the type of power cord to use, contact an authorized HP service provider.

A power cord should be routed so that it is not likely to be walked on or pinched by items placed upon it or against it. Particular attention should be paid to the plug, electrical outlet, and the point where the cord exits from the product.

Japanese Power Cord Requirements

For use in Japan, use only the power cord received with this product.

⚠ CAUTION: Do not use the power cord received with this product on any other products.

Product Environmental Notices

ENERGY STAR® Qualification

HP Displays marked with the ENERGY STAR® certification mark meet the requirements of the U.S. Environmental Protection Agency (EPA) ENERGY STAR program. The EPA ENERGY STAR® certification mark does not imply endorsement by the EPA. As an ENERGY STAR Partner, Hewlett Packard Company has determined that this product meets the ENERGY STAR® program requirements for display energy efficiency.

The following ENERGY STAR® certification mark appears on all ENERGY STAR qualified displays:



The ENERGY STAR® program specifications for displays and computers were created by the EPA to promote energy efficiency and reduce air pollution through more energy-efficient equipment in homes, offices, and factories. One way products achieve this goal is by using the Microsoft Windows power management feature to reduce power consumption when the product is not in use.

The power management feature enables the computer to initiate a low-power or “sleep” mode after a period of user inactivity. When used with an external ENERGY STAR® qualified display, this feature also supports similar power management features for the display. To take advantage of these potential energy savings, users should use the default power management settings that are provided with ENERGY STAR qualified computers and displays. The default power management settings on ENERGY STAR qualified computers are preset to behave in the following ways when the system is operating on AC power:

- Turn off an external display after 15 minutes of user inactivity
- Initiate a low power sleep mode for the computer after 30 minutes of user inactivity

ENERGY STAR® qualified computers exit the low power sleep mode and ENERGY STAR qualified displays resume operation when the user resumes use of the computer. Examples include the user pressing the power/sleep button, receiving an input signal from an input device, receiving an input signal from a network connection with the Wake On LAN (WOL) feature enabled, etc.

Additional information on the ENERGY STAR® program, its environmental benefits and the potential energy and financial savings of the power management feature can be found on the EPA ENERGY STAR Power Management Web site at <http://www.energystar.gov/powermanagement>.

Materials Disposal

This HP product contains mercury in the fluorescent lamp in the display LCD that might require special handling at end-of-life.

Disposal of this material can be regulated because of environmental considerations. For disposal or recycling information, contact the local authorities or the Electronic Industries Alliance (EIA) <http://www.eiae.org>.

Disposal of Waste Equipment by Users in Private Household in the European Union



This symbol on the product or on its packaging indicates that this product must not be disposed of with your household waste. Instead, it is your responsibility to dispose of your waste equipment by handing it over to a designated collection point for the recycling or waste electrical and electronic equipment. The separate collection and recycling of your waste equipment at the time of disposal will help to conserve natural resources and ensure that it is recycled in a manner that protects human health and the environment. For more information about where you can drop off your waste equipment for recycling, please contact the local city office, the household waste disposal service or the shop where you purchased the product.

HP Recycling Program

HP encourages customers to recycle used electronic hardware, HP original print cartridges, and rechargeable batteries. For more information about recycling programs, go to <http://www.hp.com/recycle>.

Chemical Substances

HP is committed to providing our customers with information about the chemical substances in our products as needed to comply with legal requirements such as REACH (Regulation EC No 1907/2006 of the European Parliament and Council). A chemical information report for this product can be found at <http://www.hp.com/go/reach>.

Restriction of Hazardous Substances (RoHS)

A Japanese regulatory requirement, defined by specification JIS C 0950, 2005, mandates that manufacturers provide Material Content Declarations for certain categories of electronic products offered for sale after July 1, 2006. To view the JIS C 0950 material declaration for this product, visit <http://www.hp.com/go/jisc0950>.

2008年、日本における製品含有表示方法、JISC0950が公示されました。製造事業者は、2006年7月1日以降に販売される電気・電子機器の特定化学物質の含有につきまして情報提供を義務付けられました。製品の部材表示につきましては、www.hp.com/go/jisc0950を参照してください。

产品中有毒有害物质或元素的名称及含量

根据中国《电子信息产品污染控制管理办法》

LCD 显示器

部件名称	有毒有害物质或元素					
	铅 (Pb)	汞 (Hg)	镉 (Cd)	六价铬 (Cr(VI))	多溴联苯 (PBB)	多溴二苯醚 (PBDE)
液晶显示屏 - CCFL	X	X	○	○	○	○
液晶显示屏 - WLED	X	○	○	○	○	○
机箱 / 其他	X	○	○	○	○	○

○: 表示该有毒或有害物质在该部件所有均质材料中的含量均在 SJ/T11363-2006 标准规定的限量要求以下。

X: 表示该有毒或有害物质至少在该部件的某一均质材料中的含量超出 SJ/T11363-2006 标准规定的限量要求。

表中标有 "X" 的所有部件都符合欧盟 RoHS 法规, 即“欧洲议会和欧洲理事会 2003 年 1 月 27 日关于在电子电气设备中限制使用某些有害物质的 2002/95/EC 号指令”。

注: 环保使用期限的参考标识取决于产品正常工作的温度和湿度等条件。

Turkey EEE Regulation

In Conformity with the EEE Regulation

EEE Yönetmeliğine Uygundur

Україна обмеження на наявність небезпечних речовин (Ukraine restriction of hazardous substances)

Обладнання відповідає вимогам Технічного регламенту щодо обмеження використання деяких небезпечних речовин в електричному та електронному обладнанні, затвердженого постановою Кабінету Міністрів України від 3 грудня 2008 № 1057.

The equipment complies with requirements of the Technical Regulation, approved by the Resolution of Cabinet of Ministry of Ukraine as of December 3, 2008 № 1057, in terms of restrictions for the use of certain dangerous substances in electrical and electronic equipment.

D LCD Monitor Quality and Pixel Policy

The TFT monitor uses high-precision technology, manufactured according to HP standards, to guarantee trouble-free performance. Nevertheless, the display may have cosmetic imperfections that appear as small bright or dark spots. This is common to all LCD displays used in products supplied by all vendors and is not specific to the HP LCD. These imperfections are caused by one or more defective pixels or sub-pixels.

- A pixel consists of one red, one green, and one blue sub-pixel.
- A defective whole pixel is always turned on (a bright spot on a dark background), or it is always off (a dark spot on a bright background). The first is the more visible of the two.
- A defective sub-pixel (dot defect) is less visible than a defective whole pixel and is small and only visible on a specific background.

To locate defective pixels, the monitor should be viewed under normal operating conditions, in normal operating mode at a supported resolution and refresh rate, from a distance of approximately 50 cm (20 in).

HP expects that, over time, the industry will continue to improve its ability to produce LCDs with fewer cosmetic imperfections and HP will adjust guidelines as improvements are made.

Free Manuals Download Website

<http://myh66.com>

<http://usermanuals.us>

<http://www.somanuals.com>

<http://www.4manuals.cc>

<http://www.manual-lib.com>

<http://www.404manual.com>

<http://www.luxmanual.com>

<http://aubethermostatmanual.com>

Golf course search by state

<http://golfingnear.com>

Email search by domain

<http://emailbydomain.com>

Auto manuals search

<http://auto.somanuals.com>

TV manuals search

<http://tv.somanuals.com>