



# HP ZR2040w, ZR2240w, ZR2440w and ZR2740w LCD Monitors

User Guide

© 2011, 2012 Hewlett-Packard  
Development Company, L.P.

Microsoft, Windows, and Windows Vista are either trademarks or registered trademarks of Microsoft Corporation in the United States and/or other countries.

The only warranties for HP products and services are set forth in the express warranty statements accompanying such products and services. Nothing herein should be construed as constituting an additional warranty. HP shall not be liable for technical or editorial errors or omissions contained herein.

This document contains proprietary information that is protected by copyright. No part of this document may be photocopied, reproduced, or translated to another language without the prior written consent of Hewlett-Packard Company.

First Edition (September 2011)

Second Edition (April 2012)

Document Part Number: 647215-002

## About This Guide

This guide provides information on setting up the monitor and technical specifications.

 **WARNING!** Text set off in this manner indicates that failure to follow directions could result in bodily harm or loss of life.

 **CAUTION:** Text set off in this manner indicates that failure to follow directions could result in damage to equipment or loss of information.

 **NOTE:** Text set off in this manner provides important supplemental information.

---



---

# Table of contents

<b>1 Product Features</b> .....	<b>1</b>
ZR2040w Model .....	1
ZR2240w Model .....	2
ZR2440w Model .....	2
ZR2740w Model .....	4
<b>2 Setting Up the Monitor</b> .....	<b>5</b>
Installing the Pedestal .....	5
Rear Components .....	6
ZR2040w Model .....	6
ZR2240w Model .....	7
ZR2440w Model .....	8
ZR2740w Model .....	10
Routing and Connecting the Cables .....	11
ZR2040w Model .....	11
ZR2240w, ZR2440w, and ZR2740w Models .....	13
Mounting the Monitor to User-Supplied Support Hardware .....	14
Mounting the ZR2040w Panel .....	15
Mounting a Quick-Release Panel .....	16
Locating the Information Card (Select Models) .....	18
Installing a Cable Lock .....	19
Turning on the Monitor .....	19
Adjusting the Monitor .....	20
Portrait Orientation .....	22
<b>3 Operating the Monitor</b> .....	<b>23</b>
Overview of Operation .....	23
ZR2040w and ZR2240w Model .....	23
ZR2440w Model .....	25
ZR2740w Model .....	26
Using the On-Screen Display Menu (Select Models) .....	27
<b>4 Locating Additional Information</b> .....	<b>28</b>
<b>Appendix A Technical Specifications</b> .....	<b>29</b>
ZR2040w Model .....	29

ZR2240w Model .....	30
ZR2440w Model .....	31
ZR2740w Model .....	32
Preset Display Resolutions .....	33
ZR2040w Model Preset Modes .....	33
ZR2240w Model Preset Modes .....	33
ZR2440w Model Preset Modes .....	34
ZR2740w Model Preset Modes .....	36
Energy Saver Feature .....	36

---

# 1 Product Features

The LCD (liquid crystal display) monitors have an active matrix of thin-film transistors (TFT). All models have the following features:

- Mercury-free LED backlight
- Wide viewing angle to allow viewing from a sitting or standing position, or moving side-to-side
- Removable pedestal and VESA-standard mounting holes for flexible mounting solutions
- Support for the optional HP speaker bar (purchased separately)
- Plug and play capability when supported by the operating system
- Security slot provision on rear of monitor for optional cable lock
- Cable management feature for placement of cables and cords
- HDCP (High-Bandwidth Digital Content Protection) copy protection on all digital inputs
- Software and documentation CD that includes monitor drivers, utilities, and product documentation
- Energy saver feature to meet requirements for reduced power consumption
- Intelligent Management AssetControl
- Compliant with the European Union RoHS Directive

## ZR2040w Model

Features of the ZR2040w model include:

- 50.8 cm (20-inch) diagonal viewable area display with 1600 × 900 resolution, plus full-screen support for lower resolutions
- Video signal input to support VGA analog with VGA signal cable provided
- Video signal input to support DVI digital with DVI-D signal cable provided
- Video signal input to support DisplayPort digital with DisplayPort signal cable provided
- Landscape and portrait orientations
- Tilt adjustment
- On-Screen Display (OSD) adjustments in several languages for ease of setup and screen optimization
- HP Display Assistant utility software for adjusting monitor settings and enabling the theft deterrence feature
- Auto-adjustment Pattern Utility
- Privacy filter slots to insert filters (purchased separately) to block side screen viewing
- Energy Star Qualified and meets TCO Requirements

## ZR2240w Model

Features of the ZR2240w model include:

- 54.72 cm (21.5-inch) diagonal viewable area display with 1920 × 1080 resolution, plus full-screen support for lower resolutions
- Video signal input to support VGA analog with VGA signal cable provided
- Video signal input to support DVI digital with DVI-D signal cable provided
- Video signal input to support HDMI digital
- Dynamic Contrast Ratio: 2,000,000:1
- Video signal input to support DisplayPort digital with DisplayPort signal cable provided
- USB 2.0 hub with one upstream (connects to the computer) and four downstream (connect to USB devices) ports
- USB cable included to connect to the monitor's USB hub and to a USB connector on a computer
- 8-way comfort adjust including Height, Tilt, Pivot and Swivel adjustments
- HP Quick Release 2 is now a flush mount solution that lets you quickly install the panel with a simple click and remove it with the convenient sliding tab release
- Easy access pull-out information card with the information needed for a support call
- On-Screen Display (OSD) adjustments in several languages for ease of setup and screen optimization
- HP Display Assistant utility software for adjusting monitor settings and enabling the theft deterrence feature
- Auto-adjustment Pattern Utility
- Privacy filter slots to insert filters (purchased separately) to block side screen viewing
- Energy Star Qualified and meets TCO Requirements

## ZR2440w Model

Features of the ZR2440w model include:

- 61.13 cm (24-inch) diagonal viewable area display with 1920 × 1200 resolution, plus full-screen support for lower resolutions
- Video signal input to support DisplayPort digital with DisplayPort signal cable provided
- Video signal input to support HDMI digital
- Video signal input to support DVI digital with DVI-D signal cable provided
- Dynamic Contrast Ratio: 2,000,000:1
- USB 2.0 hub with one upstream (connects to the computer) and four downstream (connect to USB devices) ports
- USB cable included to connect to the monitor's USB hub and to a USB connector on a computer
- SPDIF Digital Audio Output signal
- Analog audio output signal to support 2.0 Sound



- 8-way comfort adjust including Height, Tilt, Pivot and Swivel adjustments
- HP Quick Release 2 is now a flush mount solution that lets you quickly install the panel with a simple click and remove it with the convenient sliding tab release
- Easy access pull-out information card with the information needed for a support call
- On-Screen Display (OSD) adjustments in several languages for ease of setup and screen optimization
- HP Display Assistant utility software for adjusting monitor settings and enabling the theft deterrence feature
- Privacy filter slots to insert filters (purchased separately) to block side screen viewing
- Energy Star Qualified and meets TCO Requirements

## ZR2740w Model

Features of the ZR2740w model include:

- 68.74 cm (27-inch) diagonal viewable area display with 2560 x 1440 resolution
- Video signal input to support DVI digital with DVI-Dual Link signal cable provided
- Video signal input to support DisplayPort digital with DisplayPort signal cable provided
- USB 2.0 hub with one upstream (connects to the computer) and four downstream (connect to USB devices) ports
- USB cable included to connect to the monitor's USB hub and to a USB connector on a computer
- 8-way comfort adjust including Height, Tilt, Pivot and Swivel adjustments
- HP Quick Release 2 is now a flush mount solution that lets you quickly install the panel with a simple click and remove it with the convenient sliding tab release
- Easy access pull-out information card with the information needed for a support call

## 2 Setting Up the Monitor

To set up the monitor, ensure that the power is turned off to the monitor, computer system, and other attached devices, then follow the instructions below.

 **NOTE:** Be sure the master power switch, located on the rear panel of the monitor, is in the off position. The master power switch turns off all power to the monitor.

### Installing the Pedestal

 **NOTE:** Do not install the pedestal if the monitor will be used on a wall, swing arm, or other mounting fixture; instead see [Mounting the Monitor to User-Supplied Support Hardware on page 14](#) in this chapter.

 **CAUTION:** Whenever you handle the monitor, take care not to touch the surface of the LCD panel. Pressure on the panel may cause non-uniformity of color or disorientation of the liquid crystals. If this occurs the screen will not recover to its normal condition.

To assemble the ZR2040w, slide the pedestal upright into its base, as shown on the following page.

**Figure 2-1** Assembling the ZR2040w pedestal



Models ZR2240w, ZR2440w, and ZR2740w use the HP Quick Release 2 mechanism for easy moving of the monitor. To mount the panel onto the pedestal:

1. Slide the mounting plate on the pedestal under the upper lip of the recess in the back of the panel.
2. Lower the pedestal into the recess until it snaps into place.
3. The HP Quick Release 2 latch pops up when the monitor is locked in place.

**Figure 2-2** Mounting the Panel onto the HP Quick Release 2



## Rear Components

### ZR2040w Model

**Figure 2-3** ZR2040w Rear Components

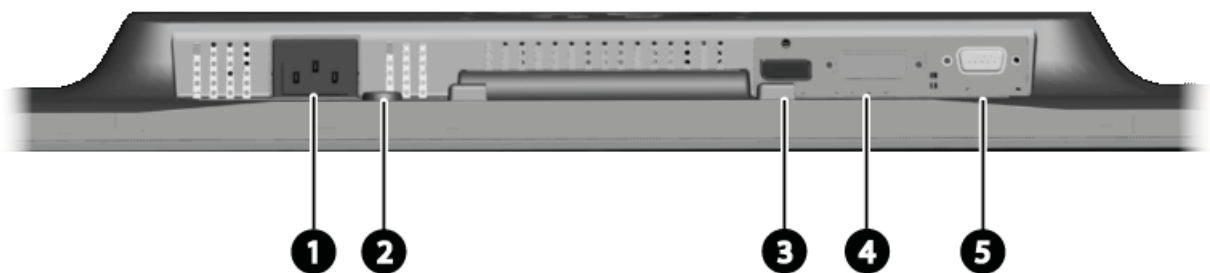

Component	Function
1 AC Power Connector	Connects the AC power cord to the monitor.
2 Cable Lock Provision	Provides slot for use with cable security locks.
3 DisplayPort Connector	Connects the DisplayPort cable to the monitor.
4 DVI-D Connector	Connects the DVI-D cable to the monitor.
5 VGA Connector	Connects the VGA cable to the monitor.

## ZR2240w Model

Figure 2-4 ZR2240w Rear Components

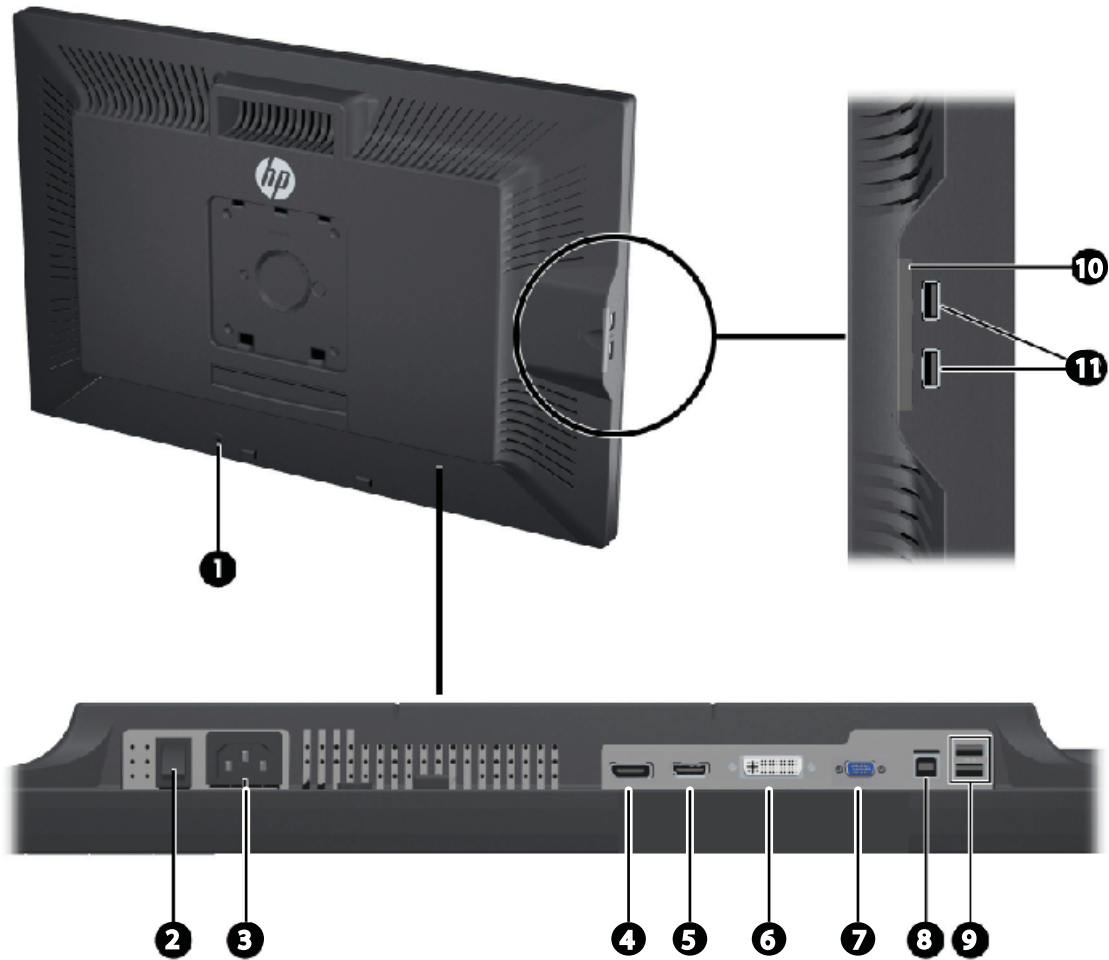

Component	Function
1 Cable Lock Provision	Provides slot for use with cable security locks.
2 Master Power Switch	Turns off all power to the monitor. <b>NOTE:</b> Putting the switch in the Off position will yield the lowest power state for the monitor when not in use.
3 AC Power Connector	Connects the AC power cord to the monitor.
4 DisplayPort Connector	Connects the DisplayPort cable to the monitor.
5 HDMI Connector	Connects an HDMI cable to the monitor.
6 DVI-D Connector	Connects the DVI-D cable to the monitor.
7 VGA Connector	Connects the VGA cable to the monitor
8 USB Upstream Connector	Connects the monitor USB hub cable to a host USB port/hub.
9 USB Downstream Connectors	Connects optional USB devices to the monitor.

Component	Function
10 Information Card	Provides information needed for a support call.
11 USB Downstream Connectors (side panel)	Connects optional USB devices to the monitor.

## ZR2440w Model

Figure 2-5 ZR2440w Rear Components

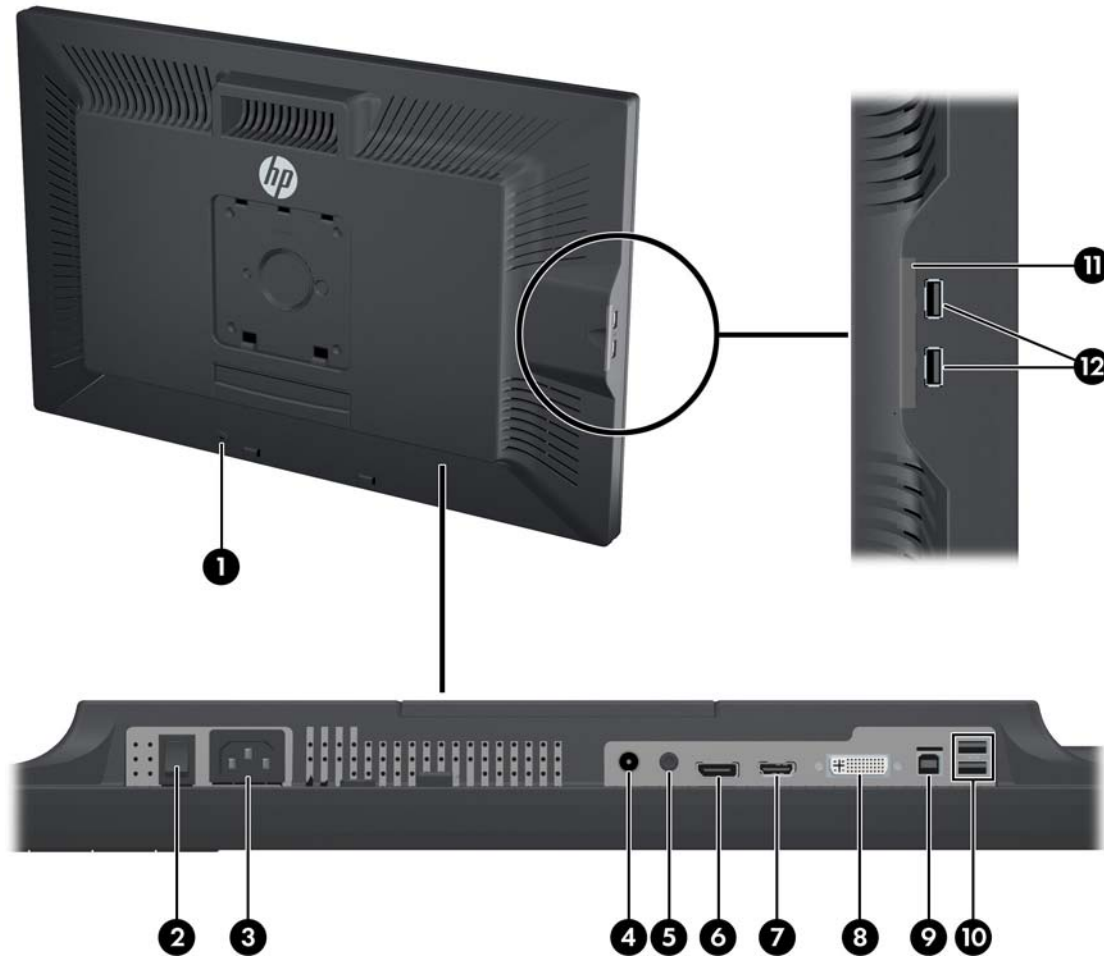

Component	Function
1 Cable Lock Provision	Provides slot for use with cable security locks.
2 Master Power Switch	Turns off all power to the monitor. <b>NOTE:</b> Putting the switch in the Off position will yield the lowest power state for the monitor when not in use.
3 AC Power Connector	Connects the AC power cord to the monitor.
4 Digital Audio Output	Connects an audio cable with RCA plug to the monitor.

---

<b>Component</b>		<b>Function</b>
5	Analog Audio Output	Connects an audio cable with 3.5 mm L/R mini-plug to the monitor.
6	DisplayPort Connector	Connects the DisplayPort cable to the monitor.
7	HDMI Connector	Connects an HDMI cable to the monitor.
8	DVI-D Connector	Connects the DVI-D cable to the monitor.
9	USB Upstream Connector	Connects the monitor USB hub cable to a host USB port/hub.
10	USB Downstream Connectors	Connects optional USB devices to the monitor.
11	Information Card	Provides information about the monitor.
12	USB Downstream Connectors (side panel)	Connects optional USB devices to the monitor.

---

## ZR2740w Model

Figure 2-6 ZR2740w Rear Components

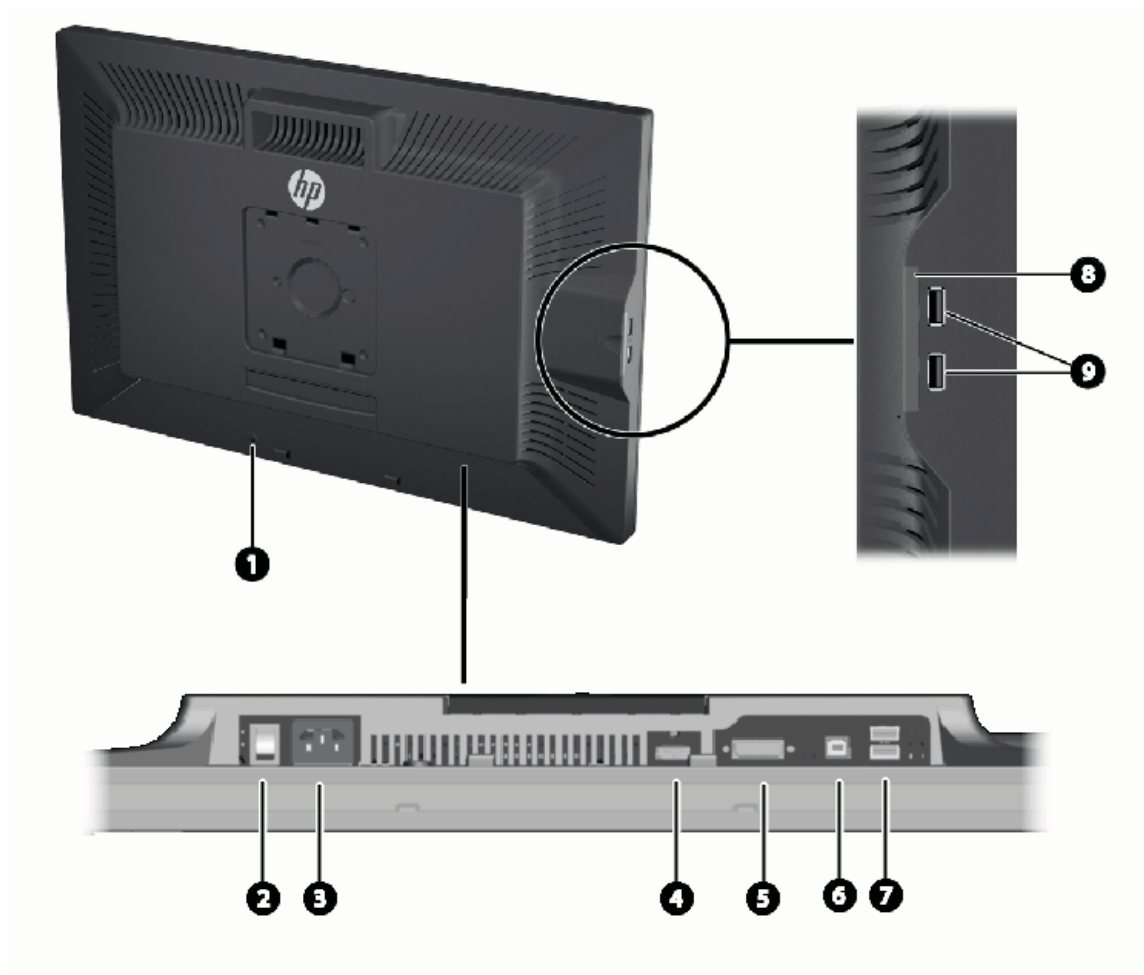

Component	Function
1 Cable Lock Provision	Provides slot for use with cable security locks.
2 Master Power Switch	Turns off all power to the monitor. <b>NOTE:</b> Putting the switch in the Off position will yield the lowest power state for the monitor when not in use.
3 AC Power Connector	Connects the AC power cord to the monitor.
4 DisplayPort Connector	Connects the DisplayPort cable to the monitor.
5 DVI-D Connector	Connects the DVI-D cable to the monitor.
6 USB Upstream Connector	Connects the monitor USB hub cable to a host USB port/hub.
7 USB Downstream Connectors	Connects optional USB devices to the monitor.
8 Information Card	Provides information needed for a support call.
9 USB Downstream Connectors (side panel)	Connects optional USB devices to the monitor.



## Routing and Connecting the Cables

Place the monitor in a convenient, well-ventilated location near the computer.

### ZR2040w Model

The cable-restraining bar on the pedestal of the ZR2040w is held in place by four tabs.

**Figure 2-7** Cable-Restraining Bar

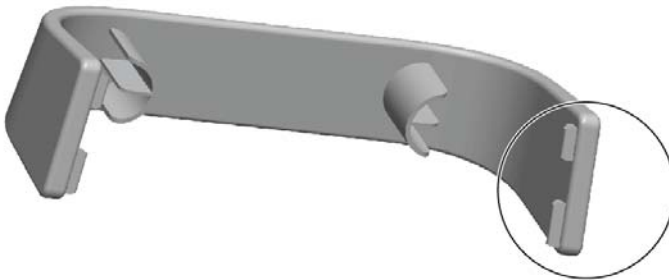

1. To remove the bar, first pull one end of the bar away from the pedestal (1). When it is free, the bar can be removed (2).

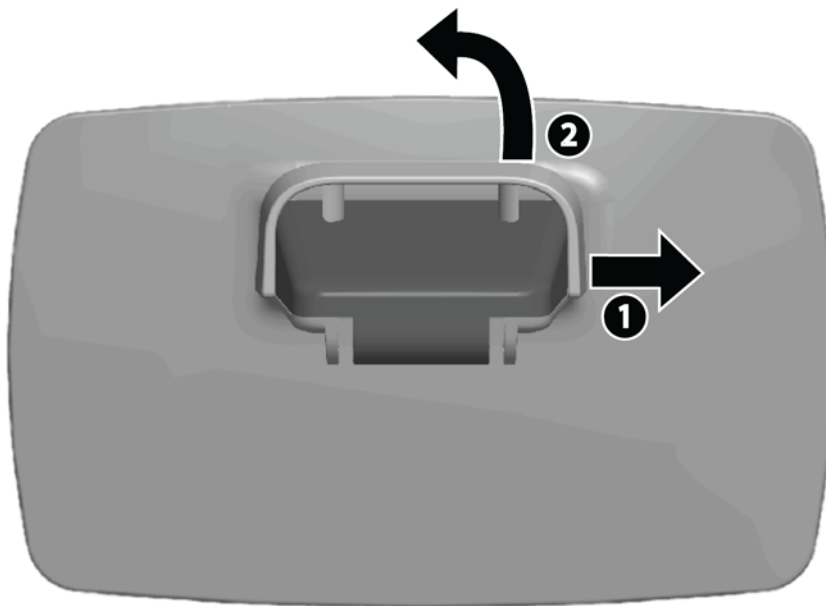

2. Connect the video cables provided to the connectors shown in [ZR2040w Model on page 6](#). You do not have to connect them all.
3. For each cable you've attached, plug the other end into the appropriate connector on the computer.

4. Connect the AC power cord and plug it into the wall outlet.

**⚠ WARNING!** To reduce the risk of electric shock or damage to the equipment:

Do not disable the power cord grounding plug. The grounding plug is an important safety feature.

Plug the power cord into a grounded (earthed) electrical outlet that is easily accessible at all times.

Disconnect power from the equipment by unplugging the power cord from the electrical outlet.

For your safety, do not place anything on power cords or cables. Arrange them so that no one may accidentally step on or trip over them. Do not pull on a cord or cable. When unplugging from the electrical outlet, grasp the cord by the plug.

5. Gather the video cables and replace the cable-restraining bar so as to contain the cables.

**Figure 2-8** ZR2040w Model Cable Routing

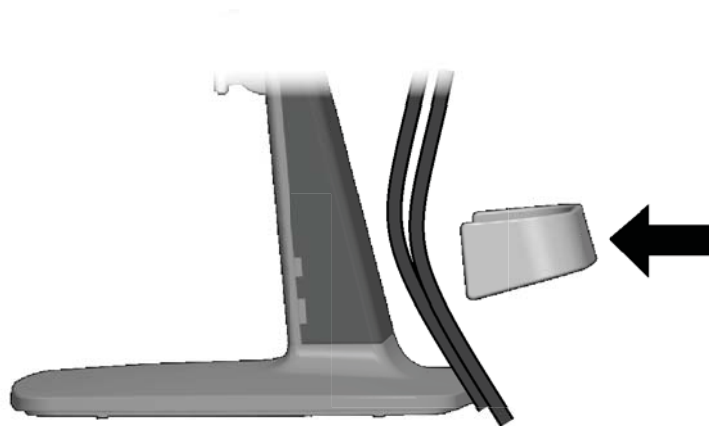

## ZR2240w, ZR2440w, and ZR2740w Models

1. Remove the cable routing cover by pulling it straight off the front of the column.

**Figure 2-9** Cable Routing Cover



2. Before connecting the cables, route them through the cable routing hole in the column (1) and replace the cable routing cover (2).

**Figure 2-10** Cable Routing



3. Connect the desired signal sources. Refer to the drawings in ([Rear Components on page 6](#)) to identify the connectors on your monitor. For each one, plug in one end of the appropriate cable. Attach the other end to your computer or other video source.

The ZR2440w model supports audio output from the HDMI and DisplayPort inputs. Use the RCA jack for digital output and the 3.5 mm mini-jack for analog 2.0 Sound.

---

 **NOTE:** It is not necessary to connect all the connectors to video sources.

---

4. If you will be using USB devices (such as a digital camera, USB keyboard, or USB mouse), connect one end of the provided USB cable to the USB hub connector on the rear panel of the computer, and the other end to the upstream USB connector on the monitor. The four downstream USB ports (two on the rear and two on the side) are now available for your devices.

**Figure 2-11** Connecting USB Cables



5. Connect one end of the power cable to the AC power connector on the back of the monitor, and the other end to an electrical wall outlet.

---

 **WARNING!** To reduce the risk of electric shock or damage to the equipment:

Do not disable the power cord grounding plug. The grounding plug is an important safety feature.

Plug the power cord into a grounded (earthed) electrical outlet that is easily accessible at all times.

Disconnect power from the equipment by unplugging the power cord from the electrical outlet.

For your safety, do not place anything on power cords or cables. Arrange them so that no one may accidentally step on or trip over them. Do not pull on a cord or cable. When unplugging from the electrical outlet, grasp the cord by the plug.

---

## Mounting the Monitor to User-Supplied Support Hardware

The monitor can be installed to any support that meets the VESA standards.

---

 **NOTE:** This apparatus is intended to be supported by a UL or CSA Listed wall mount bracket.

---

**⚠ CAUTION:** The HP Quick Release 2 can be installed directly to a wall to mount the monitor panel. It is designed to support a maximum of up to 10.9 kg (24 lbs). If you are mounting to a wall, HP recommends that you consult with a qualified engineering, architectural, or construction professional to determine the appropriate type and quantity of mounting fasteners required for your application and to ensure that the mounting solution is properly installed to support applied loads.

The weight for your model can be found in [Technical Specifications on page 29](#).

Before you begin, make sure the monitor is turned off and the power and signal cables are disconnected. Also disconnect any USB cables. To protect the panel, lay it face down on a soft, flat surface.

## Mounting the ZR2040w Panel

1. Remove the four screws holding the panel to the pedestal.
2. To mount the panel, use the four holes surrounding the HP logo on the back of the monitor.

**Figure 2-12** Mounting the ZR2040w Model

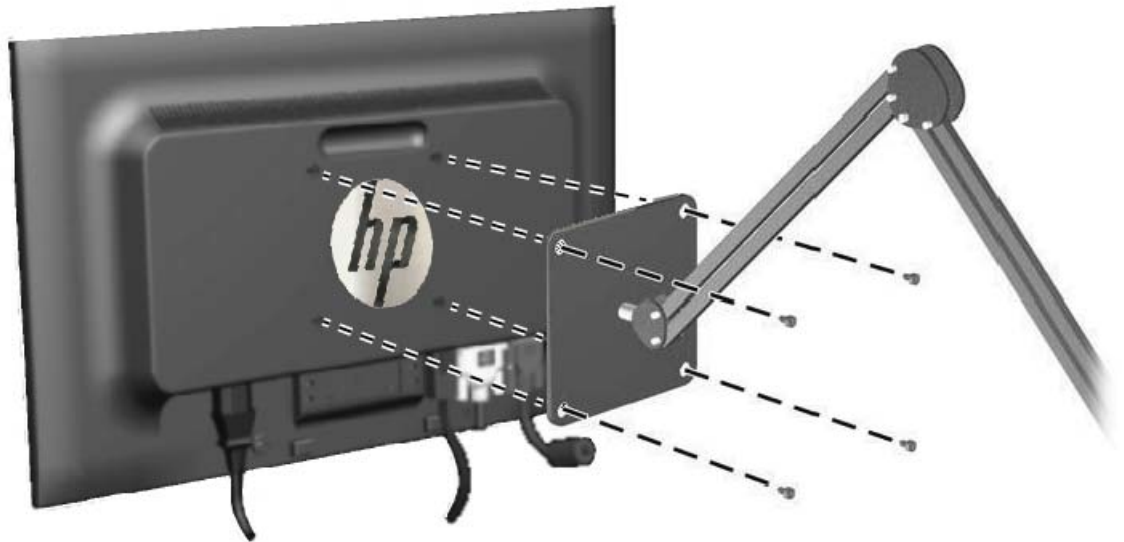

**⚠ CAUTION:** This monitor supports the VESA industry standard 100 mm mounting holes. To attach a third-party mounting solution to the monitor, four 4 mm, 0.7 pitch, and 10 mm long screws are required. Longer screws must not be used because they may damage the monitor. It is important to verify that the manufacturer's mounting solution is compliant with the VESA standard and is rated to support the weight of the monitor display panel. For best performance, it is important to use the power and video cables provided with the monitor.

3. If you mount the panel in portrait orientation, you will need to rotate the image to match. See [Portrait Orientation on page 22](#) for instructions.

## Mounting a Quick-Release Panel

The ZR2240w, ZR2440w and ZR2740w support mounting to VESA-compliant hardware in two ways:

- Remove the HP stand and use the 4 VESA mount threaded holes (100 x 100 pattern) that are in the Quick Release 2 recess. Screws of the appropriate length are provided.

**Figure 2-13** Mounting a VESA Arm

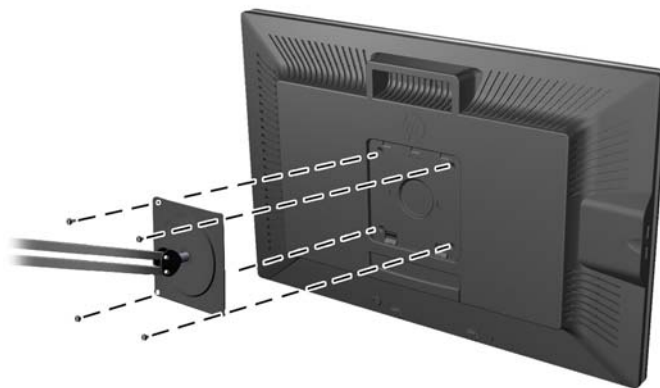

- Alternatively, follow the instructions below to use the HP Quick Release 2 feature with your VESA mounting hardware.

Start by removing the pedestal.

**Figure 2-14** Removing the Pedestal

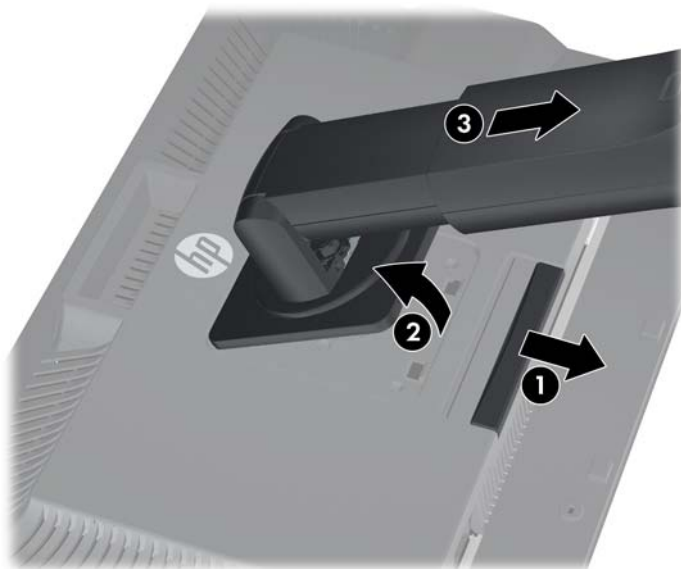

1. Press down on the latch near the bottom center of the monitor to unlock the HP Quick Release 2.
2. Swing the bottom of the pedestal up until the mounting plate clears the recess in the panel.

3. Slide the pedestal out of the recess.
4. Remove four screws holding the mounting plate to the head of the pedestal:

**Figure 2-15** Removing the Mounting Plate from the Pedestal

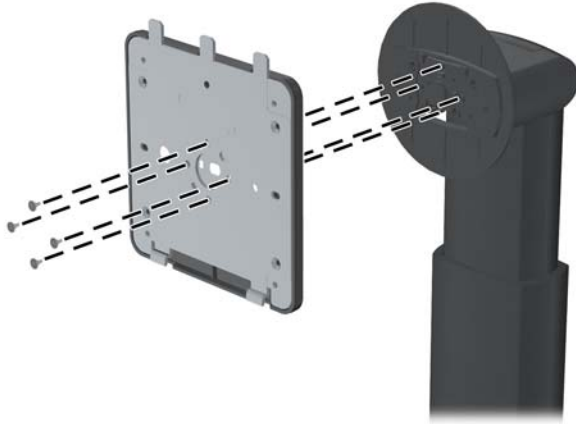

5. Remove four screws to separate the mounting plate from its cover:

**Figure 2-16** Removing the Cover from the Mounting Plate

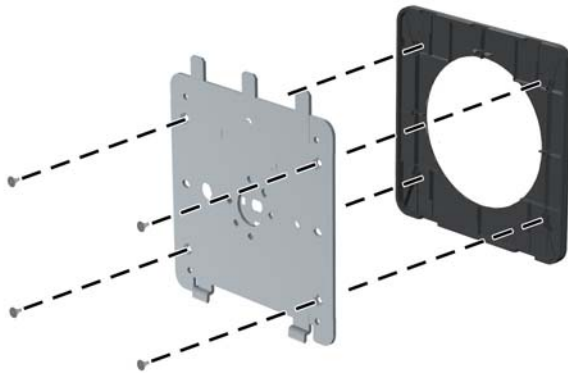

6. Attach the mounting plate to the wall or swing arm of your choice.

**Figure 2-17** Installing the Mounting Plate

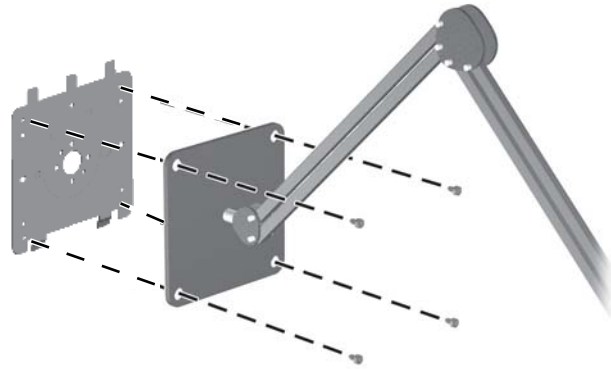

**CAUTION:** This monitor supports the VESA industry standard 100 mm mounting holes. To attach a third-party mounting solution to the monitor, four 4 mm, 0.7 pitch, and 10 mm long screws are required. Longer screws must not be used because they may damage the monitor. It is important to verify that the manufacturer's mounting solution is compliant with the VESA standard and is rated to support the weight of the monitor display panel. For best performance, it is important to use the power and video cables provided with the monitor.

7. Place the panel on the mounting bracket you've installed by aligning its recess with the mounting bracket, then sliding it down over the top of the bracket and pressing it back into place against the bracket. The release latch on the monitor will pop up when the monitor is safely locked in place.

## Locating the Information Card (Select Models)

**Figure 2-18** The Pull-out Information Card



The ZR2240w, ZR2440w, and ZR2740w models provide a card with the information you will need when contacting HP for support. The card pulls out from behind the USB connectors on the left side of the panel.



Identifying information is located on the pull-out card (instead of on labels on the back of the monitor). Warranty support information (model number, serial number, product number) is printed on the front of the card and regulatory information is printed on the back of the card.

## Installing a Cable Lock

You can secure the monitor to a fixed object with an optional cable lock available from HP.

**Figure 2-19** Installing a Cable Lock

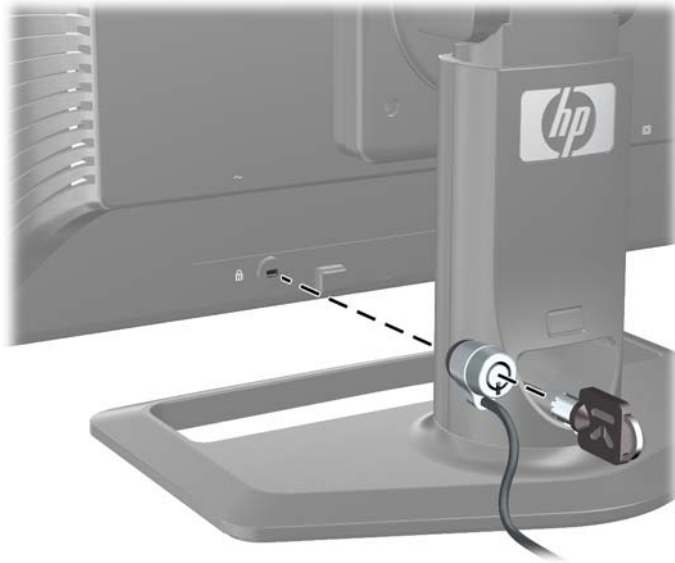

## Turning on the Monitor

1. If your monitor has a master power switch (located on the rear of the monitor), put it in the On position (I) .
2. Press the power button on the computer to turn it on.
3. Press the power button on the front of the monitor to turn it on.

**CAUTION:** Burn-in image damage may occur on monitors that display the same static image on screen for a prolonged period of time (12 consecutive hours of non-use). To avoid burn-in image damage on the monitor screen, you should always activate a screen saver application or sleep timer, or turn off the monitor when it is unused for a long time. Image retention is a condition that may occur on all LCD screens. Monitors with a “burned-in image” are not covered under the HP warranty.

**NOTE:** If pressing the power button has no effect, the Power Button Lockout feature may be enabled. To disable this feature, press and hold the monitor power button for 10 seconds.

You may see a status message or an image on the screen. The LED on the front panel will turn blue. If the monitor is not receiving any input, it will soon go into low-power mode, indicated by the LED turning amber.

## Adjusting the Monitor

1. Tilt the monitor's panel forward or backward to set it to a comfortable eye level.

**Figure 2-20** Adjusting the Tilt



2. If your monitor has the ability to swivel, adjust it to the left or right for the best viewing angle.

**Figure 2-21** Adjusting the Viewing Angle (Select Models)

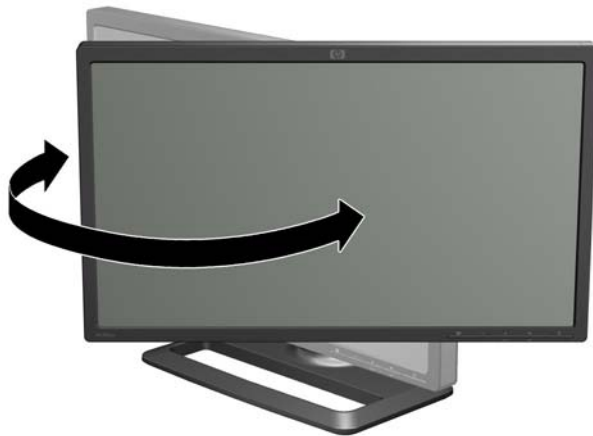

3. Models ZR2240w, ZR2440w, and ZR2740w provide for height adjustment. Adjust the monitor's height so that it is parallel to your eye height for a comfortable viewing position. A lock-down/release button on the back of the column prevents the display head from sliding up when the

monitor is lifted. If the display head is locked in the lowest position, release and adjust it as follows:

**Figure 2-22** Adjusting the Height (Select Models)

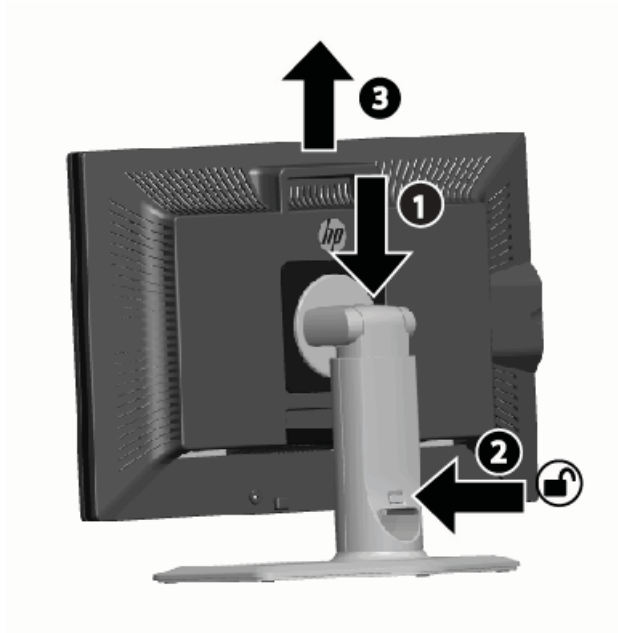

- a. Make sure that the monitor is safely positioned on a stable surface.
  - b. Gently push down on the display head (1).
  - c. While pushing down the display head, press the lock-down/release button on the back of the column (2).
  - d. Guide the display head up to the desired height (3).
4. The default orientation of the monitor is landscape. If you want to change to portrait, follow the instructions in the next section, [Portrait Orientation on page 22](#).

## Portrait Orientation

The ZR2040w must be mounted in the orientation you wish to use. Other models can be pivoted after mounting. To do this, raise the panel to its highest position and pivot it clockwise from landscape to portrait.

**Figure 2-23** Pivoting the Monitor (Select Models)



**NOTE:** It may be necessary to tilt the monitor panel back to prevent the corner of the panel from coming in contact with the base when pivoting.

If your model is a ZR2740w, rotate the image using the workstation video driver control panel (for AMD Graphics, start the CATALYST Control Center; for NVIDIA graphics, start the NVIDIA Control Center). Refer to the Online Help of your workstation video driver for more information.

For other models, use the HP Display Assistant software (included on the software and documentation CD) to rotate the image. If your model has an OSD, it can be rotated to portrait mode by pressing the Menu button on the monitor's front panel, then selecting **OSD Control > Rotate OSD**.

---

# 3 Operating the Monitor

## Overview of Operation

If you are not familiar with HP Performance monitors, read this section for an overview of how they operate. This will help you locate specific information elsewhere in this manual.

Your monitor provides for more than one source of input. It will scan the various inputs to find an active one and display that image. You can change sources manually, using the **SOURCE** button on the front panel. The scanning order is initially set to DisplayPort, DVI-D, HDMI, VGA, making DisplayPort the default source of video.

Some models give you control of the scanning order and default source through an On-Screen Display (OSD) menu. If your front panel has a menu () button, it provides an OSD. The OSD also lets you prevent the monitor from switching sources.

If the monitor is not receiving any input, it will go into low power mode (“sleep”) and the LED on the front will turn from blue to amber. This means that the monitor will sleep when the computer does, unless it has some other source of input. You can send it into low-power mode using the power () button on the front. The OSD lets you put sleeping and waking on a timer or stay awake all the time (not recommended).

Your monitor displays its state through the LED on the front panel and through messages on the screen. These indicators vary from one model to another, but all use the following LED indicators:

- Blue – normal operation
- Amber – low-power mode
- Flashing blue – the input calls for higher resolution than the monitor can provide
- Flashing amber – timed sleep, that is, the monitor is in low-power mode and will awaken on a timer
- No light – normal operation or power off

In addition to these indicators, some models use screen messages as well, detailed later in this chapter.

Image quality is well-controlled with digital inputs. For analog input, various tools are provided for adjusting the quality: a software utility, an auto-adjust function, and options in the OSD.





### ZR2040w and ZR2240w Model

The order in which these monitors scan the inputs begins with the DisplayPort, making it the default input. If DisplayPort is inactive, the monitor will scan for an active input in this order: DVI-D, HDMI (ZR2240w only), VGA. You can change the current input, the default source, and the scan order

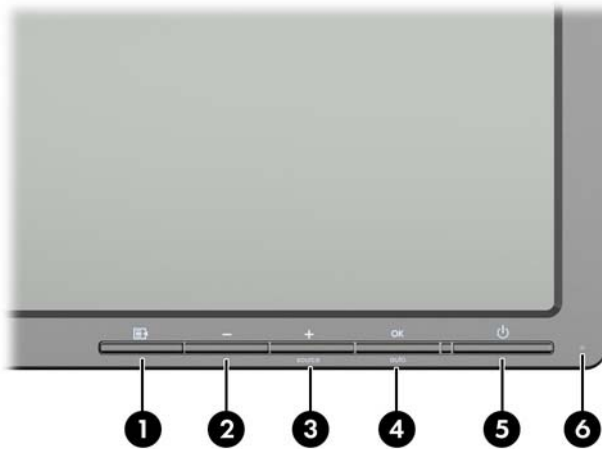
through the OSD. Pressing the + button on the front of the monitor will take you directly to the OSD source-control submenu.

**Figure 3-1** ZR2040w and ZR2240w Front Panel Controls







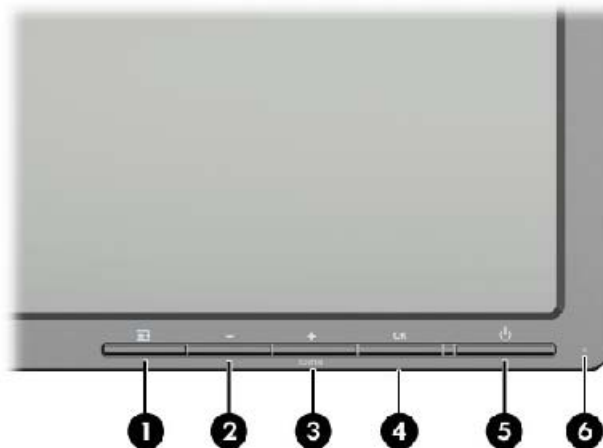

Control	Function
1  Menu	Opens, selects or exits the OSD menu.
2  Minus	If the OSD menu is on, press to navigate backward through the OSD menu and decrease adjustment levels.  If the OSD menu is inactive, resets OSD choices to their factory defaults, ZR2040w model only.
3  Plus/source	If the OSD menu is on, press to navigate forward through the OSD menu and increase adjustment levels.  If the OSD menu is inactive, press to activate the source button that chooses the video signal input.
4  OK/auto	If the OSD menu is on, press to select the highlighted menu item.  If the OSD menu is inactive, press to activate the auto adjustment feature to optimize the screen image.
5  Power	Puts the monitor into low-power mode.
6 Power LED	Blue = Fully powered.  Amber = Sleep mode.  Flashing Amber = Sleep Timer mode.  Off indicates power off, or normal operation if the LED is suppressed.

## ZR2440w Model

The default input on the ZR2440w is DisplayPort and the scan order is initially set to DisplayPort, DVI-D, HDMI. You can change the current input, the default and the scan order through the OSD. Pressing the + button on the front of the monitor will take you directly to the OSD source-control submenu.

**Figure 3-2** ZR2440w Front Panel Controls



Control	Function
1  Menu	Opens, selects or exits the OSD menu.
2  Minus	If the OSD menu is on, press to navigate backward through the OSD menu and decrease adjustment levels.
3  Plus/source	If the OSD menu is on, press to navigate forward through the OSD menu and increase adjustment levels.  If the OSD menu is inactive, press to activate the source button that chooses the video signal input (VGA, DVI, or DisplayPort).
4  OK	If the OSD menu is on, press to select the highlighted menu item.
5  Power	Turns the monitor on or off as long as the master power switch on the rear panel is on.
6  Power LED	Blue = Fully powered.  Amber = Sleep mode.  Flashing Amber = Sleep Timer mode.  No light indicates power off, or normal operation if the LED is suppressed.

## ZR2740w Model

For the ZR2740w model, the default input is DisplayPort. You can change the current input by pressing the SOURCE button on the front of the panel.

The front buttons also let you adjust brightness and put the monitor in low-power mode:

**Figure 3-3** ZR2740w Front Panel Controls

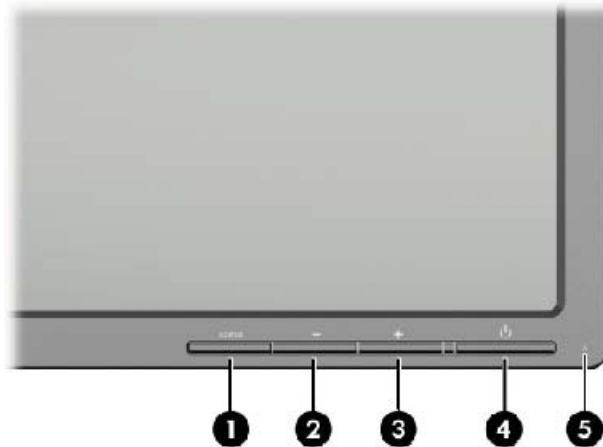

Control	Function
1 <b>SOURCE</b> Source	Toggles the video signal input source between DisplayPort and DVI-D.
2 - Minus	Decreases brightness.
3 + Plus	Increases brightness.
4  Power	Turns the monitor on or off as long as the master power switch on the rear panel is on.
5 Power LED	Solid blue indicates the first 30 seconds of normal operation. Solid amber indicates low-power mode. Continuously-flashing blue indicates signal input in a non-supported mode. (See <a href="#">ZR2740w Model Preset Modes on page 36</a> for supported modes.) Three blue flashes while you are adjusting brightness indicate the limit of the screen's brightness range. No light indicates normal operation or power off.

Holding down either the + or — button causes the brightness setting to change more rapidly. When you reach either the minimum or maximum brightness, the LED will flash three times.



Pressing the Power button, , puts the monitor in low power mode. (To turn power off completely, use the switch on the rear of the panel.) The monitor also enters low-power mode when there is no video signal input.

When the monitor is first powered on, the LED turns blue and remains blue for about half a minute. It then turns off. If the monitor receives a signal outside its range (e.g., too high a frequency), the LED flashes blue continuously.

This model does not use an OSD or on-screen messages.

## Using the On-Screen Display Menu (Select Models)

The On-Screen Display (OSD) menu gives you choices for operating your monitor. Not all menu options below are available on all models. For example, monitors with no analog input do not show menus specific to analog images. The ZR2740w does not use an OSD. Models that use an OSD have a menu  button on the front.

---

 **NOTE:** If there is a problem with the display settings, try resetting the settings to the factory defaults by opening the OSD and selecting **Factory Reset** from the OSD menu.

 **NOTE:** To view an OSD menu simulator, visit the HP Customer Self Repair Services Media Library at <http://www.hp.com/go/sml>.

---

---

# 4 Locating Additional Information

Refer to the *HP LCD Monitors Reference Guide* included on the CD with your monitor for additional information on:

- Optimizing monitor performance
- Safety and maintenance guidelines
- Installing software from the CD
- Using the OSD menu
- Downloading software from the Web
- Agency and regulatory notices
- Troubleshooting and recommended solutions to common problems

For additional information on using and adjusting your monitor, go to <http://www.hp.com/support>. Select your country or region, select Product Support & Troubleshooting, and then enter your monitor model in the SEARCH window.



**NOTE:** The monitor user guide, reference guide, and drivers are available at <http://www.hp.com/support>.

If the information provided in the guide or in the *HP LCD Monitors Reference Guide* do not address your questions, you can contact support. For U.S. support, go to <http://www.hp.com/go/contactHP>.

For worldwide support, go to [http://welcome.hp.com/country/us/en/wwcontact\\_us.html](http://welcome.hp.com/country/us/en/wwcontact_us.html). Here you can:

- Chat online with an HP technician



**NOTE:** When support chat is not available in a particular language, it is available in English.

- E-mail support
- Find support telephone numbers
- Locate an HP service center

# A Technical Specifications

 **NOTE:** All performance specifications are provided by the component manufacturers. Performance specifications represent the highest specification of all HP's component manufacturers' typical level specifications for performance and actual performance may vary either higher or lower.

## ZR2040w Model

Display	50.8 cm diagonal	20 inches diagonal
Type	TFT LCD	
Viewable Image Size	44.28 x 24.9 cm	17.4 x 9.8 inches
Tilt	-5 to 25°	
Maximum Weight (Unpacked)	3.8 kg	8.44 lbs
Dimensions (including base)		
Height	35.92 cm	14.14 inches
Depth	15.11 cm	5.94 inches
Width	48.2 cm	18.97 inches
Maximum Graphic Resolution	1600 x 900 (60 Hz)	
Optimum Graphic Resolution	1600 x 900 (60 Hz)	
Text Mode	720 x 400	
Dot Pitch	0.276 (W) x 0.276 (H) mm	
Pixels Per Inch	92	
Horizontal Frequency	83 kHz	
Vertical Refresh Rate	60 Hz	
Environmental Requirements Temperature		
Operating Temperature	5 to 35° C	41 to 95° F
Storage Temperature	-20 to 60° C	-4 to 140° F
Relative Humidity:		
Operating	20 to 80%	
Storage	5 to 95%	
Power Source	100 to 240 VAC, 50/60 Hz	
Altitude:		
Operating	0 to 5000 m	0 to 16,400 feet
Storage	0 to 12,192 m	0 to 40,000 feet

Power Consumption (maximum)	33 watts
Low-power mode	0.3 watts
Input Terminal	One DVI connector with cable included; one DisplayPort connector with cable included; one VGA connector with cable

## ZR2240w Model

**Table A-1 ZR2240w Specifications**

Display	54.72 cm diagonal	21.5 inches diagonal
Type	TFT LCD	
Viewable Image Size	47.66 x 26.89 cm	18.76 x 10.59 inches
Tilt range	-5 to 35°	
Swivel range	-45 to 45°	
Maximum Weight (Unpacked)	7.92 kg	17.44 lbs.
Dimensions (including base)		
Height (highest position)	45.71 cm	18 inches
Height (lowest position)	36.71 cm	14.45 inches
Depth	23.39 cm	9.2 inches
Width	50.74 cm	19.98 inches
Maximum Graphic Resolution	1920 x 1080 (60 Hz) analog input 1920 x 1080 (60 Hz) digital input	
Optimum Graphic Resolution	1920 x 1080 (60 Hz) analog input 1920 x 1080 (60 Hz) digital input	
Text Mode	720 x 400	
Dot Pitch	0.2475 mm	0.0097 inches
Pixels Per Inch	102	
Horizontal Frequency	24 – 83 kHz	
Vertical Refresh Rate	50 – 76 Hz	
Environmental Requirements Temperature		
Operating Temperature	5 to 35° C	41 to 95° F
Storage Temperature	-20 to 60° C	-4 to 140° F
Relative Humidity:		
Operating	20 to 80%	
Storage	5 to 95%	
Power Source	100 – 240 VAC, 50/60 Hz	

**Table A-1 ZR2240w Specifications (continued)**

Altitude:		
Operating	0 to 5000 m	0 to 16,400 feet
Storage	0 to 12,192 m	0 to 40,000 feet
Power Consumption (maximum)		
	46 watts	
Low-power mode		
	0.3 watts	
Input Terminal		
	One VGA connector with cable included; one DVI connector with cable included; one HDMI connector; one DisplayPort connector with cable included	

## ZR2440w Model

Display	61.13 cm diagonal	24.06 inches diagonal
Type	TFT LCD	
Viewable Image Size	51.84 x 32.4 cm	20.41 x 12.76 inches
Tilt	-5 to 35°	
Swivel	-45 to 45°	
Maximum Weight (Unpacked)	8.5 kg	18.88 lbs.
Dimensions (including base)		
Height (highest position)	52.85 cm	20.80 inches
Height (lowest position)	42.85 cm	16.87 inches
Depth	23.53 cm	9.26 inches
Width	56.24 cm	22.14 inches
Maximum Graphic Resolution	1920 x 1200 (60 Hz)	
Optimum Graphic Resolution	1920 x 1200 (60 Hz)	
Text Mode	720 x 400	
Dot Pitch	0.2708 (W) x 0.2713 (H) mm	
Pixels Per Inch	94	
Horizontal Frequency	24 – 80 kHz	
Vertical Refresh Rate	24 – 60 Hz	
Environmental Requirements Temperature		
Operating Temperature	5 to 35° C	41 to 95° F
Storage Temperature	-20 to 60° C	-4 to 140° F
Relative Humidity:		
Operating	20 to 80%	
Storage	5 to 95%	

Power Source	100 – 240 VAC, 50/60 Hz	
Altitude:		
Operating	0 to 5000 m	0 to 16,400 feet
Storage	0 to 12,192 m	0 to 40,000 feet
Power Consumption (maximum)	51 watts	
Low-power mode	0.5 watts	
Input Terminal	One DVI connector with cable included; one DisplayPort connector with cable included; one HDMI connector	

## ZR2740w Model

Display	68.74 cm diagonal	27 inches diagonal
Type	TFT LCD	
Viewable Image Size	59.87 x 33.77 cm	23.57 x 13.29 inches
Tilt	-5 to 30°	
Swivel	-45 to 45°	
Maximum Weight (Unpacked)	10.3 kg	22.88 lbs.
Dimensions (including base)		
Height (highest position)	54.04 cm	21.28 inches
Height (lowest position)	44.04 cm	17.34 inches
Depth	23.53 cm	9.26 inches
Width	64.6 cm	25.43 inches
Maximum Graphic Resolution	2560 x 1440 (60 Hz)	
Optimum Graphic Resolution	2560 x 1440 (60 Hz)	
Dot Pitch	0.2331 (W) x 0.2331 (H) mm	
Pixels Per Inch	108	
Horizontal Frequency	31.5 – 90 kHz	
Vertical Refresh Rate	60 Hz	
Environmental Requirements Temperature		
Operating Temperature	5 to 35° C	41 to 95° F
Storage Temperature	-20 to 60° C	-4 to 140° F
Relative Humidity:		
Operating	20 to 80%	
Storage	5 to 95%	
Power Source	100 – 240 VAC, 50/60 Hz	

Altitude:		
Operating	0 to 5000 m	0 to 16,400 feet
Storage	0 to 12,192 m	0 to 40,000 feet
Power Consumption (maximum)	120 watts	
Low-power mode	2 watts	
Input Terminal	One DVI connector with cable included; one DisplayPort connector with cable included	

## Preset Display Resolutions

The display resolutions listed below are the most commonly used modes and are set as factory defaults. The monitor automatically recognizes these preset modes and they will appear properly sized and centered on the screen.

### ZR2040w Model Preset Modes

Preset	Resolution (pixels)	Horizontal Frequency (kHz)	Refresh Rate (Hz)
1	640 x 480	31.469	59.94
2	720 x 400	31.469	70.087
3	800 x 600	37.879	60.317
4	1024 x 768	48.363	60.004
5	1280 x 720	45	59.94
6	1280 x 1024	63.981	60.02
7	1440 x 900	55.935	59.887
8	1600 x 900	60	60

**Table A-2 ZR2040w High Definition Video Formats**

Preset	Timing Name	Pixel Format	Horz Freq (kHz)	Vert Freq (kHz)	Pixel Rate (MHz)	OSD Display
1	480p	720 x 480	31.469	60	27	480p
2	720p60	1280 x 720	45	60	74.25	720p-60Hz
3	576p	720 x 576	31.25	50	27	576p
4	720p50	1280 x 720	37.5	50	74.25	720p-50Hz

### ZR2240w Model Preset Modes

Preset	Pixel Format	Horizontal Frequency (kHz)	Vertical Frequency (Hz)
--------	--------------	----------------------------	-------------------------

1	640 x 480	31.469	59.940
2	720 x 400	31.469	70.087
3	800 x 600	37.879	60.317
4	1024 x 768	48.363	60.004
5	1280 x 720	45.00	59.94
6	1280 x 960	60.0	60.0
7	1280 x 1024	63.981	60.020
8	1440 x 900	55.935	59.887
9	1600 x 900	60.0	60.0
10	1680 x 1050	65.290	59.954
11	1920 x 1080	67.5	60.00

**Table A-3 ZR2240w High Definition Video Formats**

Preset	Timing Name	Pixel Format	Horz Freq (kHz)	Vert Freq (kHz)	Pixel Rate (MHz)	OSD Display
1	480i	720 x 480	15.734	60	13.5	480i
2	480p	720 x 480	31.469	60	27	480p
3	720p60	1280 x 720	45	60	74.25	720p-60Hz
4	1080i60	1920 x 1080	33.75	60	74.25	1080i-60Hz
5	576i	720 x 576	15.625	50	13.5	576i
6	576p	720 x 576	31.25	50	27	576p
7	720p50	1280 x 720	37.5	50	74.25	720p-50Hz
8	1080i50	1920 x 1080	28.125	50	74.25	1080i-50Hz
9	1080p60	1920 x 1080	67.5	60	148.5	1080p-60Hz
10	1080p50	1920 x 1080	56.25	50	148.5	1080p-50Hz

## ZR2440w Model Preset Modes

Preset	Pixel Format	Horizontal Frequency (kHz)	Vertical Frequency (Hz)
1	640 x 480	31.469	59.940
2	720 x 400	31.469	70.087
3	800 x 600	37.879	60.317
4	720 x 480	31.469	59.940
5	1024 x 768	48.363	60.004
6	1152 x 720	44.86	60.00



7	1280 x 720	45.00	59.94
8	1280 x 768	47.396	59.995
9	1280 x 800	49.702	59.810
10	1280 x 960	60.00	60.00
11	1280 x 1024	63.981	60.020
12	1366 x 768	47.712	59.790
13	1440 x 900	55.935	59.887
14	1440 x 900	55.469	59.901
15	1600 x 900	60.000	60.00
16	1600 x 1000	61.648	60.00
17	1600 x 1200	75.000	60.000
18	1680 x 1050	65.290	59.954
19	1920 x 1080	67.5	60.00
20	1920 x 1200	74.04	60.00

**Table A-4 ZR2440w High Definition Video Formats**

Preset	Timing Name	Aspect Ratio	Pixel Format	Horz Freq (kHz)	Vert Freq (Hz)	Pixel Rate (MHz)	CEA VIC	OSD Display
1a	480i60	4:3	720 x 480	15.734	60	13.5	6	480i-60Hz
1b	480i60	16:9	720 x 480	15.734	60	13.5	7	480i-60Hz
2a	480p60	4:3	720 x 480	31.469	60	27	2	480p-60Hz
2b	480p60	16:9	720 x 480	31.469	60	27	3	480p-60Hz
3	720p60		1280 x 720	45	60	74.25		720p-60Hz
4	1080i60		1920 x 1080	33.75	60	74.25		1080i-60Hz
5a	576i50	4:3	720 x 576	15.625	50	13.5	21	576i-50Hz
5b	576i50	16:9	720 x 576	15.625	50	13.5	22	576i-50Hz
6a	576p50	4:3	720 x 576	31.25	50	27	17	576p-50Hz
6b	576p50	16:9	720 x 576	31.25	50	27	18	576p-50Hz
7	720p50		1280 x 720	37.5	50	74.25		720p-50Hz
8	1080i50		1920 x 1080	28.125	50	74.25		1080i-50Hz
9	1080p60		1920 x 1080	67.5	60	148.5		1080p-60Hz
10	1080p50		1920 x 1080	56.25	50	148.5		1080p-50Hz
11	1080p23.976		1920 x 1080	27.0	24	74.250	32	1080p-24Hz
12	1080p24		1920 x 1080	27.0	24	74.250	32	1080p-24Hz

**Table A-4 ZR2440w High Definition Video Formats (continued)**

13	1080p25	1920 x 1080	28.125	25	74.250	33	1080p-25Hz
14	1080p29.97	1920 x 1080	33.750	30	74.250	34	1080p-30Hz

## ZR2740w Model Preset Modes

Preset	Pixel Format	Horizontal Frequency (kHz)	Vertical Frequency (Hz)
1	640 x 480	31.468	59.9
2	1280 x 720	44.771	59.8
3	2560 x 1400	88.786	59.9

## Energy Saver Feature

In addition to normal operating mode, your monitor has a low-power, or "sleep" mode that uses less than .5 watts and from which it will awaken with any signal input. The monitor will go to sleep automatically when it stops receiving input, so putting your computer on a timer is one way to put the monitor on a timer. Some models also have their own sleep timers. The power LED on the front panel indicates the monitor's state: blue under full power, amber in sleep mode, and blinking amber on a sleep timer.



**NOTE:** If your monitor has a master power switch (located on the rear of the monitor), putting the switch in the Off position will yield the lowest power state for the monitor when not in use.

## Free Manuals Download Website

<http://myh66.com>

<http://usermanuals.us>

<http://www.somanuals.com>

<http://www.4manuals.cc>

<http://www.manual-lib.com>

<http://www.404manual.com>

<http://www.luxmanual.com>

<http://aubethermostatmanual.com>

Golf course search by state

<http://golfingnear.com>

Email search by domain

<http://emailbydomain.com>

Auto manuals search

<http://auto.somanuals.com>

TV manuals search

<http://tv.somanuals.com>