

RCA

DVD Player User's Manual

Changing Entertainment. Again.



RC5240P

Important Information

WARNING

RISK OF ELECTRIC SHOCK
DO NOT OPEN

To reduce the risk of electric shock, do not remove cover (or back). No user serviceable parts inside. Refer servicing to qualified personnel.



This symbol indicates "dangerous voltage" inside the product that presents a risk of electric shock or personal injury.



This symbol indicates important instructions accompanying the product.

WARNING

To reduce the risk of fire or shock hazard, do not expose this DVD player to rain or moisture. No objects filled with liquids, such as vases, shall be placed on the apparatus.

CAUTION

THIS PRODUCT UTILIZES A LASER. USE OF CONTROLS OR ADJUSTMENTS OR PERFORMANCE OF PROCEDURES OTHER THAN THOSE SPECIFIED HEREIN MAY RESULT IN HAZARDOUS RADIATION EXPOSURE. DO NOT OPEN COVERS AND DO NOT REPAIR YOURSELF. REFER SERVICING TO QUALIFIED PERSONNEL.

CAUTION

FCC Regulations state that unauthorized changes or modifications to this equipment may void the user's authority to operate it.

Note:

This DVD player is designed and manufactured to respond to the Region Management Information. If the Region number of a DVD disc does not correspond to the Region number of this DVD player, this DVD player cannot play the disc. The Region number for this DVD player is Region No 1.

Note:

This device is protected by U.S. patent numbers 4,631,603 and 4,577,216 and 4,819,098 and other intellectual property rights. The use of Macrovision's copy protection technology in the device must be authorized by Macrovision and is intended for home and other limited pay-per-view uses only, unless otherwise authorized in writing by Macrovision. Reverse engineering or disassembly is prohibited.

FCC NOTE (for U.S.A.):

This equipment has been tested and found to comply with the limits for a Class B digital device, pursuant to Part 15 of the FCC rules. These limits are designed to provide reasonable protection against harmful interference in a residential installation. This equipment generates, uses and can radiate radio frequency energy and, if not installed and used in accordance with the instructions, may cause harmful interference to radio communications. However, there is no guarantee that interference will not occur in a particular installation. If this equipment does cause harmful interference to radio or television reception, which can be determined by turning the equipment off and on, the user is encouraged to try to correct the interference by one or more of the following measures.

- Reorient or relocate the receiving antenna.
- Increase the separation between the equipment and receiver.
- Connect this equipment into an outlet on a circuit different from that to which the receiver is connected.
- Consult the dealer or an experienced radio/TV technician for help.

This class B digital apparatus meets all requirements of the Canadian Interference--Causing Equipment Regulations.

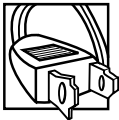

Caution: To prevent electric shock, match wide blade of plug to wide slot, fully insert.

Attention: Pour éviter les chocs électriques, introduire la lame la plus large de la fiche dans la borne correspondante de la prise et pousser jusqu'au fond.

Refer to the identification/rating label located on the back panel of your product for its proper operating voltage.

FCC Regulations state that unauthorized changes or modifications to this equipment may void the user's authority to operate it.

Caution: Using video games or any external accessory with fixed images for extended periods of time can cause them to be permanently imprinted on the picture tube (or projection TV picture tubes). ALSO, some network/program logos, phone numbers, etc. may cause similar damage. This damage is not covered by your warranty.

Cable TV Installer: This reminder is provided to call your attention to Article 820-40 of the National Electrical Code (Section 54 of the Canadian Electrical Code, Part 1) which provides guidelines for proper grounding and, in particular, specifies that the cable ground shall be connected to the grounding system of the building as close to the point of cable entry as practical.

**CLASS 1
LASER
PRODUCT**

Product Registration

Please fill out the product registration card and return it immediately. Returning this card allows us to contact you if needed.

Keep your sales receipt to obtain warranty parts and service and for proof of purchase. Attach it here and record the serial and model numbers in case you need them. The numbers are located on the back of the player.

Model No. **RC5240P**

Serial No. _____

Purchase Date: _____

Dealer/Address/Phone: _____

Chapter 1: Connections and Setup

Things to Consider Before You Connect	6
Types of Discs Your DVD Player will Play	6
Choose Your Connection	7
Cables Needed to Connect Components to Your TV	7
DVD Player + TV with Audio/Video Input Jacks	8
DVD Player + TV + VCR	9
DVD Player + TV + Dolby Pro Logic, Dolby Digital or DTS Receiver	11
DVD Player + TV + Dolby Pro Logic or Stereo Receiver	13
DVD Player + TV + VCR + Satellite Receiver	15
The Jacks on the Back of the DVD Player	16
Front Panel Controls	17
Install Batteries in the Remote	18
Important Battery Information	18
Point the Remote in the Right Direction	18
How to Find Your TV's Video Input Channel	19
Remote Control Buttons	20

Chapter 2: Playing DVDs

Regional Coding	24
Using Different Menus	24
Loading and Playing Discs	24
Using a Disc Menu	25
DVD Playback Features	27
Fast Motion Playback (Picture Scan)	27
Freeze Frame and Frame Advance	27
Skipping Chapters	27
Play Mode	28
Random	28
Program	28
Selecting a Chapter Number	29
Selecting a Title Number	29
Entering an Elapsed Time	29
Subtitles	30
Changing the Audio Language	30
Changing the Camera Angle	30
Using the Repeat Feature	31
To Repeat a Chapter or Title	31
A•B Repeat	31

Manufactured under license from Dolby Laboratories. "Dolby" and the double-D symbol are trademarks of Dolby Laboratories. Confidential unpublished works. ©1992-1997 Dolby Laboratories, Inc. All rights reserved.

DTS is a registered trademark of Digital Home Theater Systems, Inc.

Table of Contents

Chapter 3: Playing Audio CDs and MP3 Discs

Loading and Playing an Audio CD	34
Audio CD Playback Features	34
Skipping Tracks	34
Time Search	34
Play Mode	35
Random	35
Using the Repeat Feature	36
To Repeat a Track or Disc	36
A-B Repeat	36
Playing MP3 Discs	37
Selecting Tracks	37
Skipping Tracks	37

Chapter 4: Playing Video CDs

What is a Video CD?	40
The Video CD Disc Menu	40
If the Video CD Has Playback Control	40
Bypassing Playback Control	40
Resuming Playback Control	41
Using the Time Search Feature	41
The Index Feature	41

Chapter 5: The Menu System

The Display Menu	44
Image	44
Video Out	45
Menu Language	45
The Sound Menu	46
Selecting Digital Output Type	46
Range	46
Speakers	47
The Password Menu	48
Creating a Password	48
Changing the Password Mode	48
The Preferences Menu	49
Selecting the Audio Preference	49
Selecting the Subtitle Language	49
Changing the Disc Menu Language	50
Setting the Rating Limit	50
Dimming the Front Display	51
Defaults	51
Language Code List	52

Chapter 6: Other Information

Troubleshooting	54
Warranty	56
Accessories Order Form	59
Index	61

This page intentionally left blank.

Connections & Setup

Chapter Overview:

- Things to Consider
- Choose your Connection
- The Jacks on the Back of the DVD Player
- Front Panel Controls
- Installing the Batteries
- How to Find Your TV's Input Channel
- The Remote Control

Changing Entertainment. Again.



Connections and Setup

Things to Consider Before You Connect

Protect Against Power Surges

- Connect all components before you plug any of their power cords into the wall outlet.
- Turn off the TV and/or components before you connect or disconnect any cables.
- Make sure all antennas and cables are properly grounded. Refer to the Important Safeguards sheet packed with your DVD player.

Protect Components from Overheating

- Don't block ventilation holes on any of the components. Arrange the components so that air can circulate freely.
- Don't stack components.
- When you place components in a stand, make sure you allow adequate ventilation.
- If you connect an audio receiver or amplifier, place it on the top shelf so the heated air from it won't flow around other components.

Position Cables Properly to Avoid Audio Interference

- Insert each cable firmly into the designated jack.
- If you place components above the TV, route all cables down the side of the back of the TV instead of straight down the middle of the back of the TV.
- If your antenna uses 300-ohm twin lead cables, do not coil the cables. Also, keep the twin lead cables away from audio/video cables.

Connection Pictures

Audio/video cables are usually bundled together. For better visibility, the connection pictures in this book show each cable separately (audio left, audio right, and video).

Note: The illustrations in this book are representational, and in some instances may not exactly match the item represented.



Types of Discs Your DVD Player will Play

- DVD video discs – DVD video discs contain high quality picture and sound content.
- Audio discs – Audio CDs contain musical or sound content only.
- Video CDs – Like DVD discs, VCDs contain picture and sound content. VCDs hold less content than DVD discs.
- CD-R (MP3 files) – CD-R discs with MP3 files recorded or downloaded onto them.

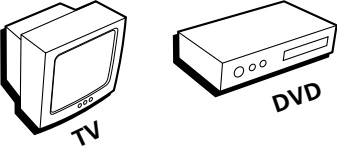

Choose Your Connection

There are several ways to connect your DVD player. Please use the following chart to determine which connection is best for you. Turn to the appropriate page and connect your DVD player.

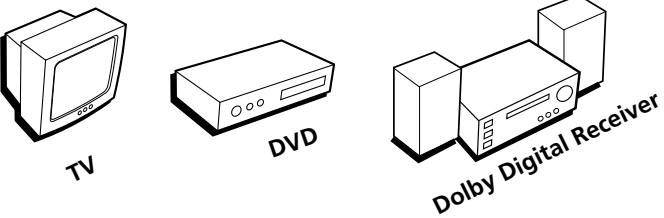
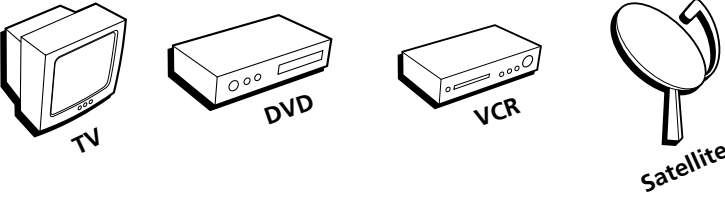
Components	Cables Needed	Connection Title	Go to...
	<ul style="list-style-type: none"> • Coaxial • Audio/video • S-Video (optional) 	TV + DVD	page 8
	<ul style="list-style-type: none"> • Coaxial • Audio/video • S-Video (optional) 	TV + DVD + VCR	page 9
	<ul style="list-style-type: none"> • Coaxial • Audio/video • S-Video (optional) • Optical connector (optional) 	TV + DVD + Dolby Digital	pages 10-13
	<ul style="list-style-type: none"> • Coaxial • Audio/video • S-Video (optional) 	TV + DVD + VCR + Satellite	page 14-15

Cables Needed to Connect Components to Your TV

The pictures below show the cables needed for the connections represented in this book.

Note: Audio/Video cables (A/V cables for short) are usually sold as a bundled set, but the connection pictures in this book show each cable separately for better visibility.

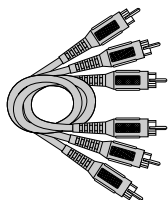

Audio/Video cables

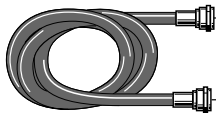

Coaxial cable

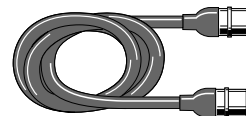

S-Video cable

Connections and Setup

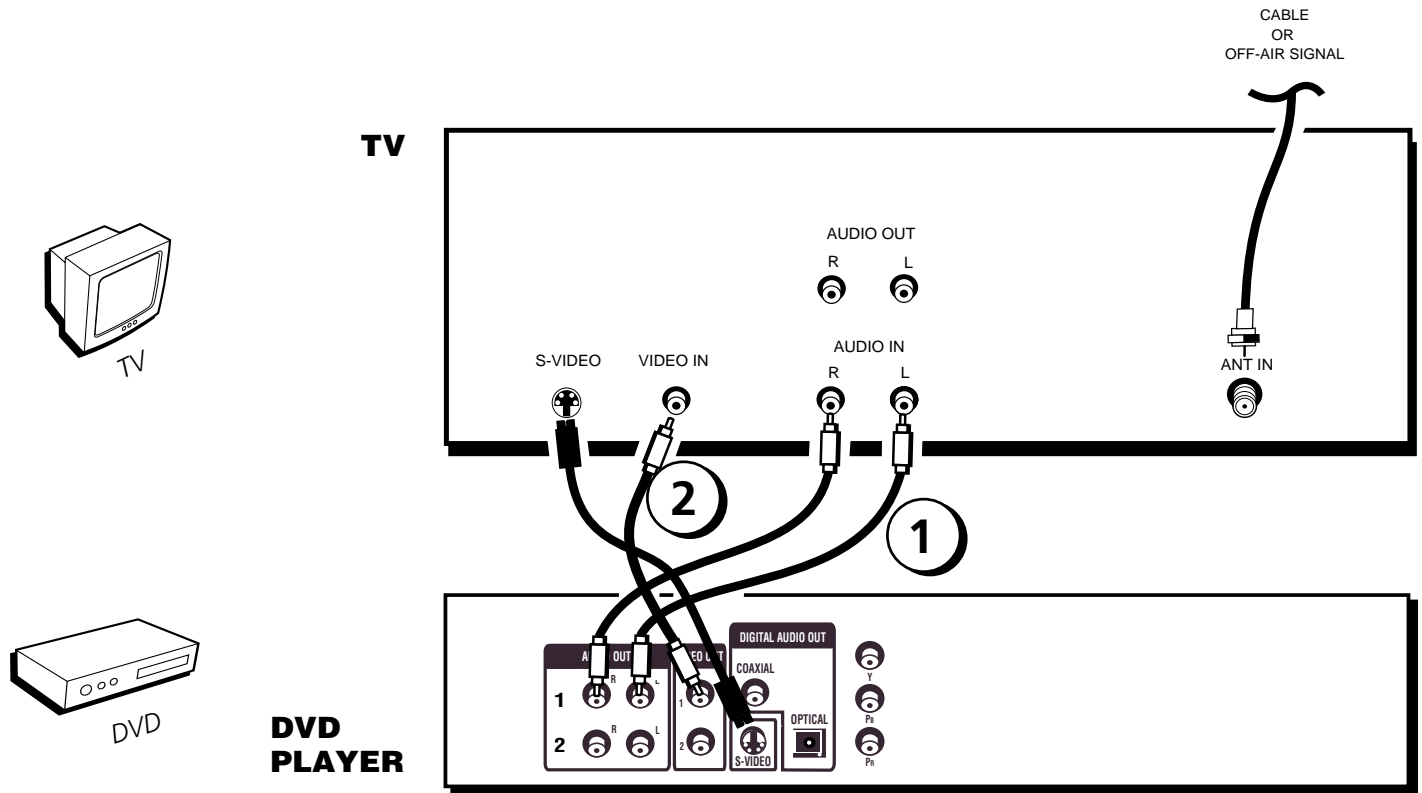

DVD Player + TV with Audio/Video Input Jacks

1. Connect the audio cables to the AUDIO OUT L (left – white) and R (right – red) jacks on the back of your DVD Player, and to the corresponding Audio Input jacks on your TV.
2. Connect the video cable.
 - **Basic video connection** – Connect the video cable (yellow) to the VIDEO OUT jack on the back of your DVD Player, and to the Video Input jack on your TV.

OR

- **S-Video** (optional) – If your TV has an S-Video Input jack, connect the S-Video cable to the S-VIDEO OUT jack on the back of your DVD Player and to the S-Video jack on your TV. If your TV doesn't have S-Video, use the basic video connection listed above.

Note: Your cable or off-air connection to the television should not be affected by this connection. Connect your cable or off-air antenna to your television as you normally would. You may need to consult your television manual for details.

Go to page 19

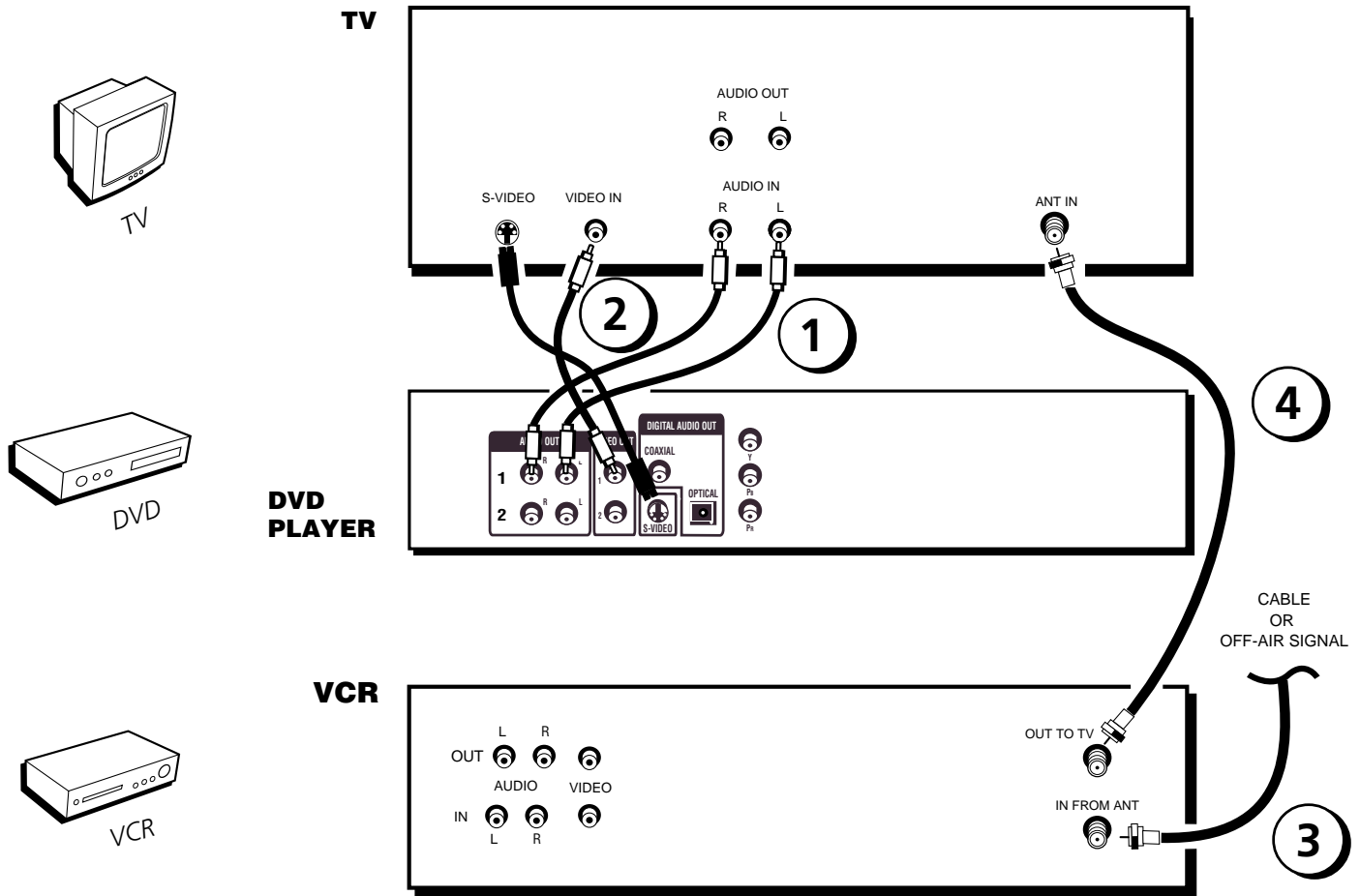

DVD Player + TV + VCR

1. Connect the audio cables to the AUDIO OUT L (left – white) and R (right – red) jacks on the back of your DVD Player, and to the corresponding Audio Input jacks on your TV.
2. Connect the video cable.
 - **Basic video connection** – Connect the video cable (yellow) to the VIDEO OUT jack on the back of your DVD Player, and to the Video Input jack on your TV.

OR

- **S-Video (optional)** – If your TV has an S-Video Input jack, connect the S-Video cable to the S-VIDEO OUT jack on the back of your DVD Player and to the S-Video jack on your TV. If your TV doesn't have S-Video, use the basic video connection listed above.
3. Connect the antenna or cable to the Antenna Input jack on the VCR.
 4. Connect a coaxial cable to the Antenna Output jack on the VCR and to the Antenna Input jack on the television.
 5. Plug the power cord into an AC outlet.

Go to page 19

Connections and Setup

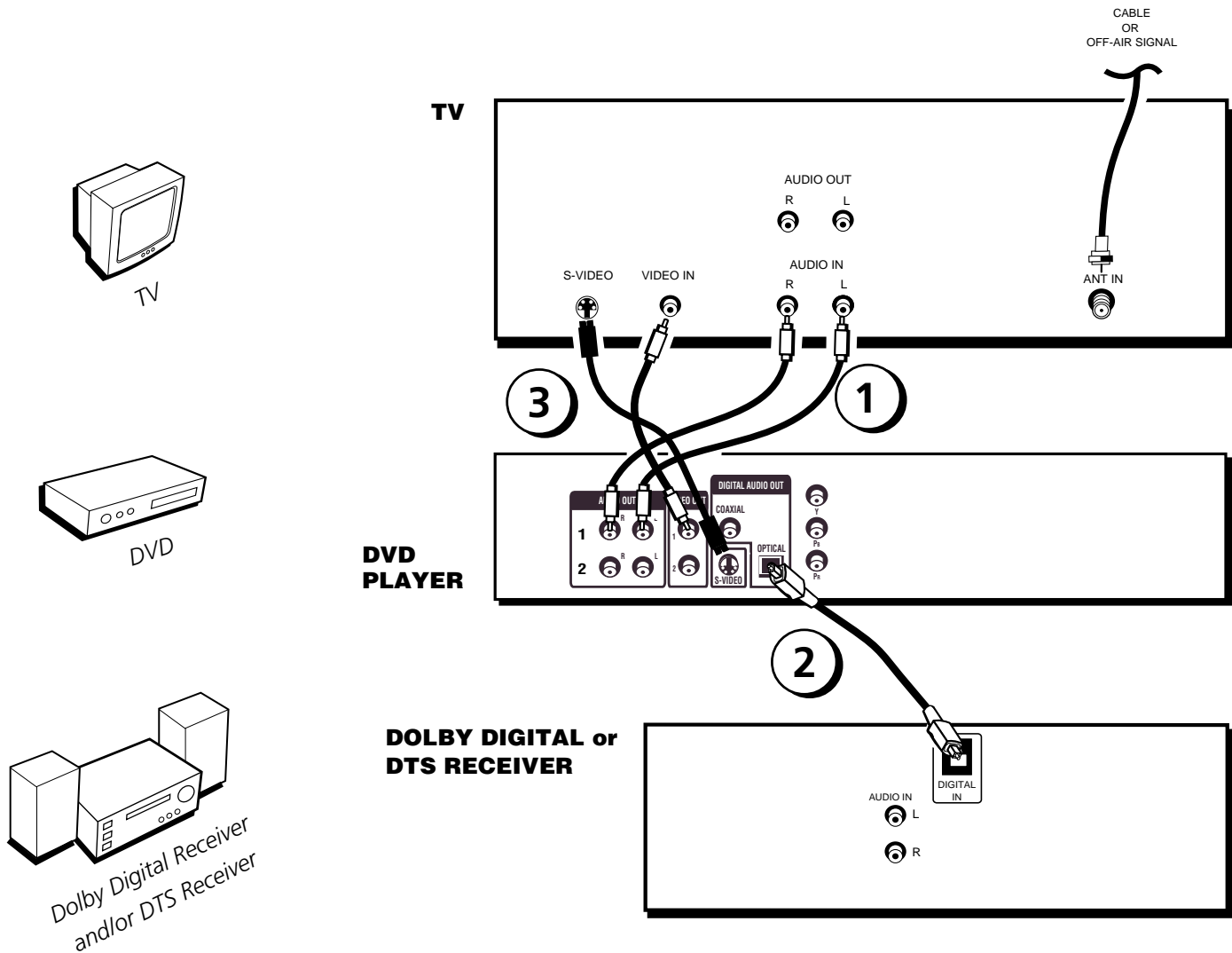

Dolby Digital® and DTS®

Both Dolby Digital and DTS are audio formats used to record 5.1-channel audio signals onto the digital track of film (while the film is being made). Both of these formats provide up to six separate channels: left, right, center, left rear, right rear, and common subwoofer.

The disc will play 5.1-channel sound only if you've connected a DTS or Dolby Digital receiver or decoder and if the original movie the disc was recorded from was encoded in the Dolby Digital or DTS format.

Please Read This Before Using the DIGITAL AUDIO OUT Jack!

This player's digital output jack is designed for a connection to a Dolby Digital or DTS receiver or decoder.

Older digital equipment may not be compatible with the Dolby Digital bitstream. Such a connection can create a high level of noise that may be harmful to your ears, and could damage headphones or speakers.

It is important to choose the correct Digital Output setting in the DVD Player's Sound menu, especially when you use the DIGITAL AUDIO OUT jack. For more information, see chapter 5.

DVD Player + TV + Dolby Digital or DTS Receiver

To Connect the DVD Player

1. Connect the left and right audio cables to your audio/video receiver and to the AUDIO OUT L (left – white) and R (right – red) jacks on the back of your DVD Player.
 2. If you have a Dolby Digital or DTS receiver, insert an optical digital cable (not provided) to the DIGITAL AUDIO OUT jack on the DVD player to the Digital Input jack on the back of the receiver. You must also set the Digital Output setting in the Sound menu (see chapter 5).
 3. Connect the video cable.
 - **Basic video connection** – Connect the video cable (yellow) to the VIDEO OUT jack on the back of your DVD Player, and to the Video Input jack on your TV.
- OR**
- **S-Video** (optional) – If your TV has an S-Video Input jack, connect the S-Video cable to the S-VIDEO OUT jack on the back of your DVD Player and to the S-Video jack on your TV. If your TV doesn't have S-Video, use the basic video connection listed above.
 4. Plug the power cord into an AC outlet.

Go to page 19

Manufactured under license from Dolby Laboratories. "Dolby" and the double-D symbol are trademarks of Dolby Laboratories. Confidential unpublished works. ©1992-1997 Dolby Laboratories, Inc. All rights reserved.

DTS is a registered trademark of Digital Home Theater Systems, Inc.

Connections and Setup

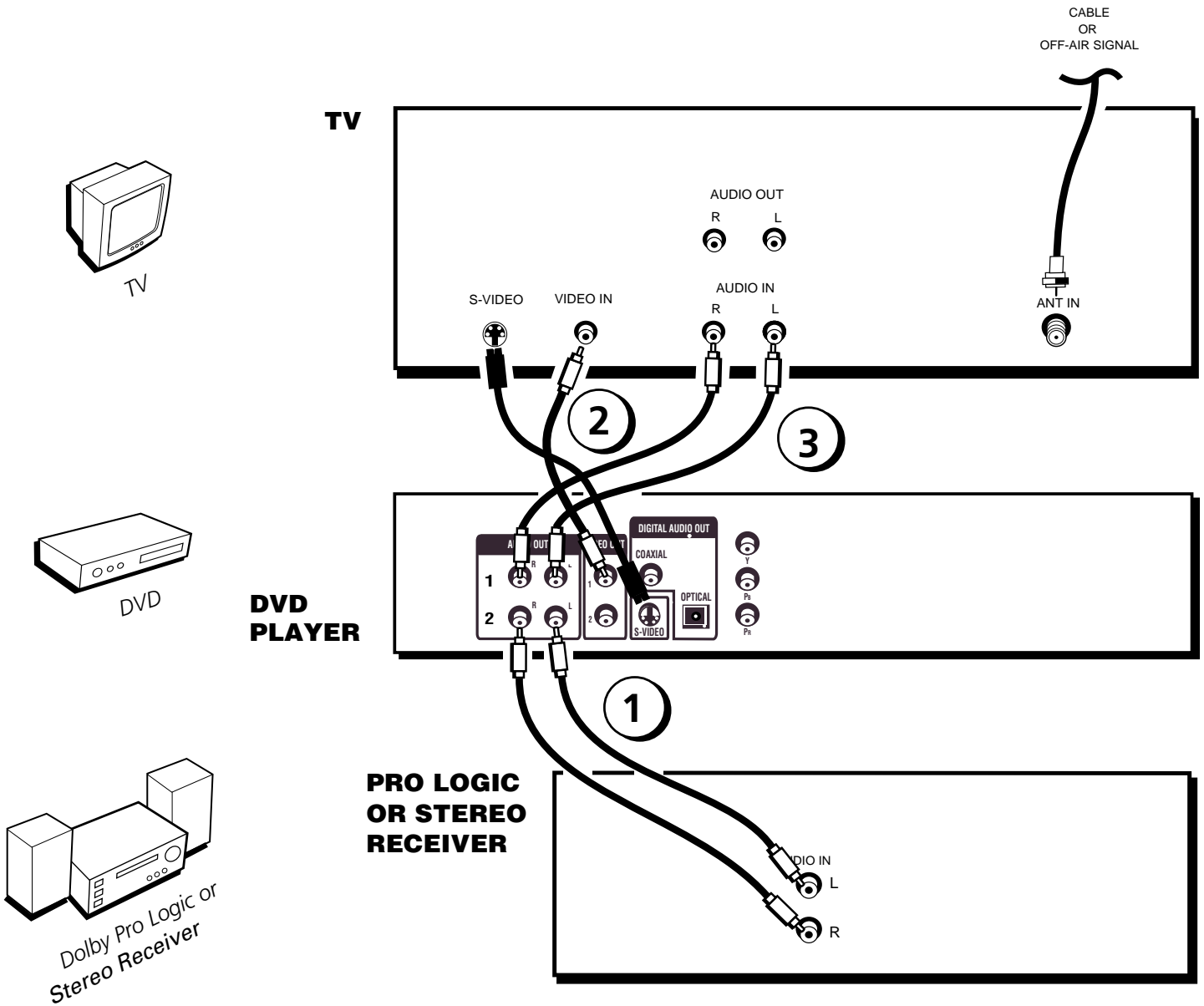

DVD Player + TV + Dolby Pro Logic or Stereo Receiver

To Connect the DVD Player

1. Connect the left and right audio cables to your audio/video receiver and to the AUDIO OUT FRONT L (left – white) and R (right – red) jacks on the back of your DVD Player.
2. Connect the video cable.
 - **Basic video connection** – Connect the video cable (yellow) to the VIDEO OUT jack on the back of your DVD Player, and to the Video Input jack on your TV.

OR

- **S-Video** – If your TV has an S-Video Input jack, connect the S-Video cable to the S-VIDEO OUT jack on the back of your DVD Player and to the S-Video jack on your TV. If your TV doesn't have S-Video, use the basic video connection listed above.
3. **Down Mix Audio** (optional) – Connect the second set of AUDIO OUT jacks on the back of the DVD player to the AUDIO IN jacks on the back of the TV. This allows you to listen to discs without going through the receiver. For example, if it's late at night and you want to listen to a disc without 6-channel sound on, you can turn off the receiver and listen to the disc through the TV speakers.
 4. Connect the AC power cord to an AC outlet.

Go to page 19

Connections and Setup

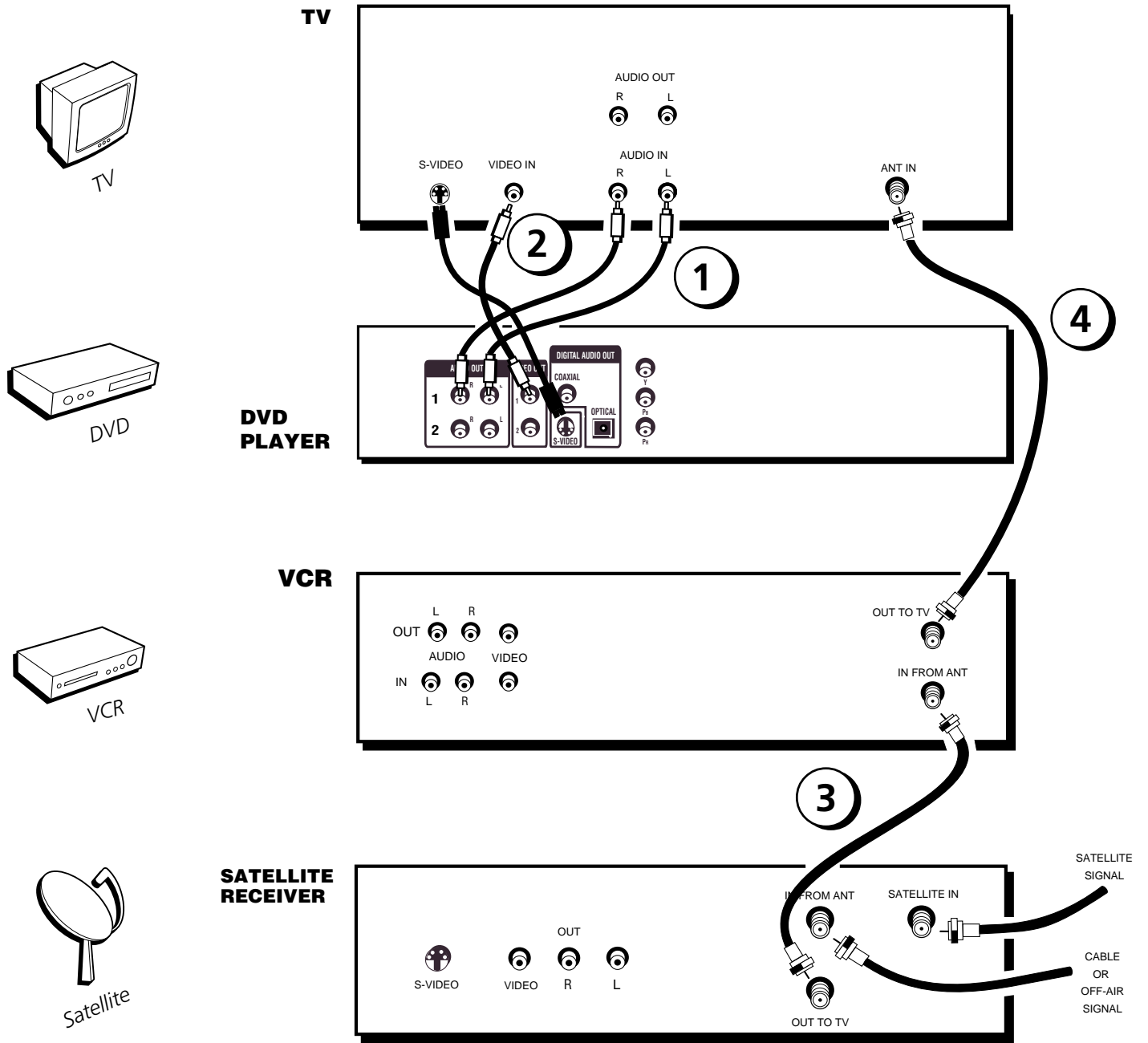

DVD Player + TV + VCR + Satellite Receiver

1. Connect the audio cables to the AUDIO OUT L (left – white) and R (right – red) jacks on the back of your DVD Player, and to the corresponding Audio Input jacks on your TV.
2. Connect the video cable.
 - **Basic video connection** – Connect the video cable (yellow) to the VIDEO OUT jack on the back of your DVD Player, and to the Video Input jack on your TV.

OR

- **S-Video (optional)** – If your TV has an S-Video Input jack, connect the S-Video cable to the S-VIDEO OUT jack on the back of your DVD Player and to the S-Video jack on your TV. If your TV doesn't have S-Video, use the basic video connection listed above.
3. Connect a coaxial cable to the antenna output jack on the VCR and to the Antenna Input jack on the television.
 4. Use a coaxial cable to connect the antenna output on the satellite receiver to the antenna input on the VCR.
 5. Plug the power cord into an AC outlet.

Go to page 19

The Jacks on the Back of the DVD Player

When connecting, make sure you connect Output jacks to Input jacks, Video to Video, Right Audio to Right Audio, etc.

AUDIO OUT R and L

Insert audio cables (left and right) from these jacks on your DVD player to the corresponding Audio Input jacks (left and right) on your TV or receiver.

VIDEO OUT

(Composite Video Output)

Connect a video cable to this jack and to the Video Input jack on your TV.

DIGITAL AUDIO OUT

Use a digital optical cable (not provided) to connect your DVD Player to a compatible Dolby Digital or DTS receiver or decoder.

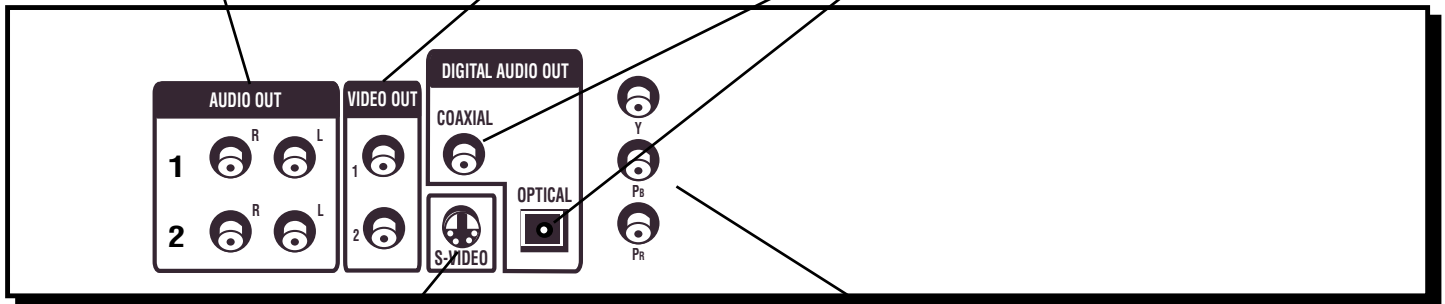

S-VIDEO

If your TV has an S-Video jack, you can connect an S-Video cable for increased video quality. The S-Video cable only carries the picture signal; remember to connect the left and right audio cables.

Component Video (Y P_B P_R) Jacks

If your TV has an component video jacks, you can connect component video cables for optimum video quality. To ensure maximum picture quality, use three video-grade cables for the connection. Remember to connect the left and right audio cables because the Y P_B P_R jacks and cables carry only the picture signal.

Front Panel Controls

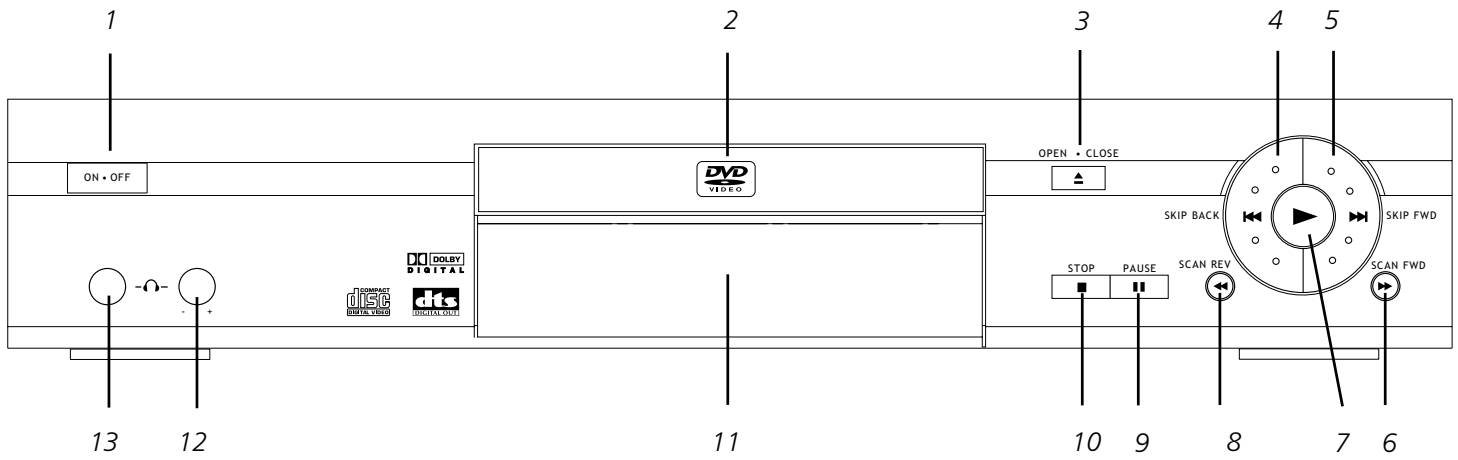

1. **ON•OFF** Use to turn the power on and off.
2. **Disc Tray** Discs are inserted here. Press **OPEN•CLOSE** to open and close disc tray.
3. **OPEN•CLOSE** Press to open and close the disc tray.
4. **SKIP BACK** During playback, moves to the beginning of the preceding title, chapter, or track on a disc.
5. **SKIP FWD** During playback, advances to the next chapter.
6. **SCAN FWD** Press and hold to scan through a DVD or CD; each press of the button increases the speed from 2X to 8X, then cycles back to **PLAY**.
7. **PLAY** Begins disc play (and closes disc tray if open).
8. **SCAN REV** Press and hold to reverse through a DVD or CD; each press of the button increases the speed from 2X to 8X, then cycles back to **PLAY**.
9. **PAUSE** Pauses disc play.
10. **STOP** Stops disc play.
11. **Front Panel Display** Displays information about the current state of the player and/or disc..
12. **VOLUME** Push and release the button (button extends out) and turn to adjust the volume of the headphones.
13. **PHONES** Plug in headphones here.

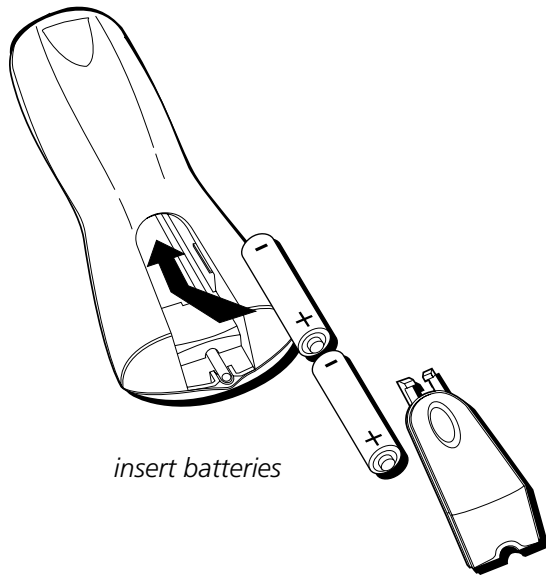

Install Batteries in the Remote

1. Remove the battery compartment cover on the back of the remote.
2. Insert new batteries. Match the polarities (+ and -) on the batteries with the diagram on the remote.
3. Put the battery compartment cover back on the remote.

Important Battery Information

- If you're not going to use the remote for a month or more, be sure to remove the batteries because they can leak and cause damage.
- Dispose of batteries in the proper manner, according to federal, state, and local regulations.
- Any battery may leak electrolyte if mixed with a different battery type, if inserted incorrectly, if all batteries are not replaced at the same time, if disposed of in fire, or if an attempt is made to charge a battery not intended to be recharged.
- Discard leaky batteries immediately. Leaking batteries can cause skin burns or other personal injury.

Point the Remote in the Right Direction

When you want the remote to operate the DVD Player, point the remote at the DVD Player, *not* the TV. The remote has to be pointed in the correct direction and toward the correct component in order for the remote control's signal to communicate with the sensor on the component. Make sure there is a clear path between the remote control and the component you want to operate so the signal isn't blocked.

Turn on the TV and DVD Player

1. Turn on your TV and tune to the correct video input channel (see following page).
2. Press the POWER button on the remote or the ON•OFF button on the DVD player.

How to Find Your TV's Video Input Channel

You need to tune your TV to the Video Input Channel (or S-Video Channel if you connected the S-Video cable to your TV and to your DVD Player) to see the DVD Player's menu and to see the content that's on a disc. The video channel on TVs varies for different brands and different models. In order for your DVD remote to work, your TV must be set on the correct video input channel.

- If your TV brand is RCA, GE, or PROSCAN, press the TV button on the remote. Then press the INPUT button on the remote.
- If you have another brand, consult your TV's Owner's Manual.

If those options don't work, try one of the following options.

- Press a button on the remote (see table below).
- Select it from the TV's menu system.
- Tune directly to the DVD input channel by pressing a specific number (see table below).
- Go through all the channels in the channel list by pressing the channel up/down buttons on the TV.

Some common scenarios are listed in the following table:

Video Input Channel Variations		
Button/switch on the TV	Button on the TV Remote	Channel #
VIDEO	VID 1	00
SIGNAL	LINE	90
VID 1	VID	91
VID 2	VIDEO	92
S-VID	S-VID	93
S-VIDEO	INPUT	VID 1
	S-VIDEO	VID 2
	SOURCE	
	AUX	

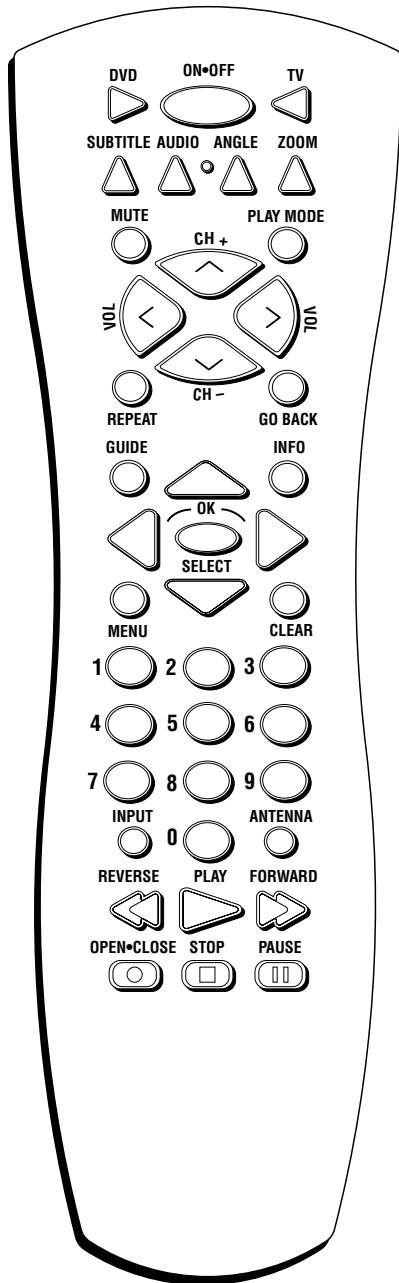

A Quick Tour of The Remote

You can use this remote to control compatible components. The component buttons are programmed to operate some Proscan, RCA and GE components. The buttons must be programmed to operate other brands of components. (See “Programming the Remote” in chapter 5.)

Component Buttons

(from left to right)

Use these buttons to turn on the component and set the remote to control the selected component.

DVD Use this button to turn on the DVD player and set the remote to control the DVD player.

TV Use this button to turn on a compatible TV and set the remote to control the TV. Used with the ON•OFF button to turn on some brands of TVs.

Remote Control Buttons

(from left to right)

This section describes what each button does when the remote is operating the DVD Player.

ON•OFF Turns on the player when it is in standby mode or puts the player in standby mode when power is on.

SUBTITLE When a disc is playing, press this button to show the Subtitle display (if the disc was created with subtitles).

AUDIO Press this button to select a different language to play a DVD disc in (provided the disc was authored with multiple languages).

ANGLE Press this button to access various camera angles on a disc (if the disc contains multiple camera angles).

ZOOM Zooms in on picture.

MUTE In TV mode, reduces sound to an inaudible level.

PLAY MODE Press this button to access the Play Mode info display to set random and program playback.

CH + Advances to the next chapter, track, index or MP3 title.

CH - Reverses to the preceding chapter, track, index or MP3 title.

VOL</> In TV mode, lowers and raises the volume.

REPEAT Press this button to bring up the Repeat info display. You can repeat part or all of a chapter, track, or an entire disc.

GO BACK Returns you to the previous menu.

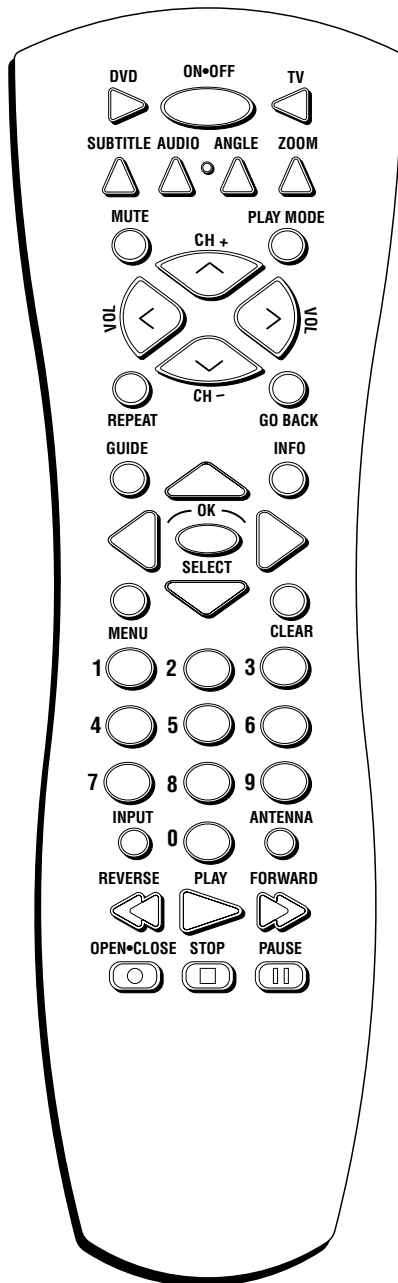

GUIDE Accesses the DVD disc guide (if available). When playing a VCD, brings up the index menu.

INFO Brings up the Info Display.

OK/SELECT Begins disc play and selects menu items.

Arrow buttons Use the arrow buttons (left, right, up, and down) to move through the on-screen menus. You highlight a menu item by pressing the arrow buttons and select a highlighted item by pressing the OK button.

MENU Brings up the DVD player menu.

CLEAR Clears on-screen displays from screen.

Number buttons Use the number buttons to input information such as chapter numbers, track numbers, or to make selections on some menu screens.

REVERSE Press this button during playback to reverse through the disc.

PLAY Begins disc play.

FORWARD Press this button during playback to advance through the disc.

OPEN/CLOSE Press and hold to open and close the disc tray.

STOP Stops disc play.

PAUSE Press this button to pause disc play. For DVD discs, press again to play forward a frame at a time. For audio CDs, the second press resumes playback.

This page intentionally left blank.

Playing DVDs

Chapter Overview:

- Regional Coding
- Using Different Menus
- Loading and Playing Discs
- Using a Disc Menu
- DVD Playback Features
- Special Features



Changing Entertainment. Again.



Regional Coding

Both the DVD player and the discs are coded by region. These regional codes must match in order for the disc to play. If the codes don't match, the disc won't play. This player's code is region 1.

Using Different Menus

Each disc is programmed with different features. There are three separate ways to access features:

- **The Disc menu** – The Disc menu is part of each disc and is separate from the DVD player's menu. The contents of each disc menu varies according to how the disc was authored and what features are included. The disc menu is turned on and off (while the disc is playing) with the MENU button on the remote.
- **The DVD player menu** – The DVD player's menu system is accessed only when a disc isn't playing. Press MENU on the remote to bring up the DVD player menu.

Remember that a feature will only work if the disc was programmed with that feature. For example, if you have subtitles turned on, the subtitles will only appear if the disc was created with subtitles. If a menu item is "grayed out" it means that item isn't available.

- **Information Banners** – Banners are a type of information display that appear across the top of the screen during playback. Information banners are activated by pressing the INFO button on the remote.

Loading and Playing Discs

Your DVD player plays DVD discs and audio CD discs. Before you load a disc, make sure that it is compatible with the player. The following discs CANNOT be used with this player:

- Laserdiscs
- CD-I, CD-ROM (computer-only discs), CD-RW, DVD-ROM
- Discs recorded using other broadcast standards (i.e. PAL or SECAM)
- CD-G discs play audio only, not graphics

To Load and Play a Disc

Turn on the TV and your DVD player (press ON•OFF on the player or the remote control).



This is an example of a one-sided disc.

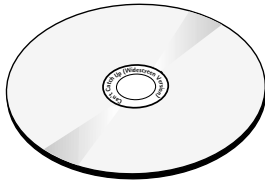

This is an example of a 2-sided disc. The title is in the center.

1. Press the OPEN•CLOSE button on the remote control or the front of the DVD Player.
2. Place a disc gently into the tray with the disc's label facing up (double-sided discs have content on both sides, so you can place either side up).
3. Press the OPEN•CLOSE or PLAY button on the front of the player to close the disc tray.

The DVD Player reads the disc's table of contents, and then one of three things happens depending on how the disc was programmed:

- The disc starts playing.
- The disc menu appears on the screen. One of the options will start disc play. Highlight that option and press OK.
- The DVD Player's main menu appears on the screen. Press the PLAY/OK button on the remote.

When you stop playing a disc, the player remembers where you stopped. When you start playing the disc again, the DVD Player picks up where you left off. To begin the title over, press STOP twice.

Using a Disc Menu

A disc is capable of having an on-screen menu that is separate from the DVD player's menu system and on-screen information banners. The disc menu might only contain a list of the titles and chapters, or it may allow you to change features such as language and playback settings.

Note: "Default settings" are the settings that the player will default to each time it is turned on.

Any settings you change with the disc menu only temporarily override the default settings.

Use the Setup Menu of the DVD player to change the default settings (See chapter 5).

Although the content and operation of disc menus varies from disc to disc, the following example will give you an idea of what to expect.

Tip

Many discs skip the disc menu and start playing automatically. To access the disc menu when you're playing a disc, press MENU on the remote.

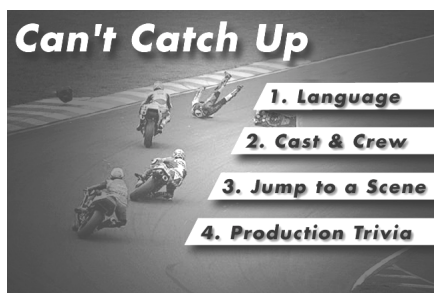

An example of a disc menu. Menus on discs vary.

1. While the disc is playing, press MENU. The disc menu appears.

Playing DVDs

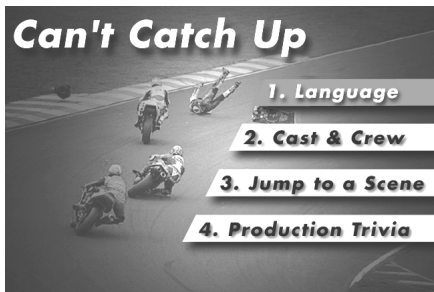

In this example, The *Language* setting is highlighted. To see language options, press OK on the remote.



In the example on the left, English is highlighted. Press OK on the remote to play the disc with English dialog.

2. Press the up/down arrow buttons to highlight the menu item you want to choose, and press OK. In the example on the left, *Language* has been highlighted.

3. Press the up/down arrows to select a language, and press OK.
4. Press MENU to resume playback.

Note: Any settings you change on the disc menu only override the settings in the DVD Player's menu temporarily. Default settings are the settings that you set up in the DVD Player's menu system. To change the default settings, see Chapter 5.

DVD Playback Features

Fast Motion Playback (Picture Scan)

You can search in forward or reverse mode.



In the above example, the picture advances 2 frames at a time.

1. Press the REVERSE or FORWARD button on the remote during playback to search through a disc.
2. Press the button again on the remote to search at the next speed. Picture Scan has four speeds. With each consecutive press of the button, the search speed increases. If you press the button five times, Picture Scan cycles back to normal playback.
3. Press the PLAY button on the remote to resume normal playback.

Freeze Frame and Frame Advance

1. Press **||** (pause) once to freeze playback.
2. Press of the **||** (pause) button again to advance the picture one frame at a time.
3. Press PLAY/OK to resume normal playback.

Skipping Chapters

Use the CH+ button to go to the next chapter and the CH- button to go to the previous chapter.

Play Mode

Random

The Random option plays a disc's chapters in random order. If there is more than one title, the title with the most chapters is selected. If there is more than one title and all titles have an equal amount of chapters, the first title is selected. If each title has only one chapter each, the titles/chapters will be played in random order.

1. Press STOP to stop playback.
2. Press PLAY MODE on the remote control (the Play Mode info banner appears).
3. Press the PLAY MODE button until the *Random* option is displayed.
4. Press OK.

To stop Random playback, press STOP and PLAY to resume normal playback.

Program

The Program playback option allows you to enter the order in which you want chapters to play.



In the example above, the first chapter in the program will be the fifth chapter.

1. Press STOP to stop playback.
2. Press PLAY MODE on the remote control (the Play Mode info banner appears).
3. Press the PLAY MODE button until the *Program* option is displayed.
4. Use the number buttons to enter the chapters/tracks in the order you want them to play.
5. Press OK. The chapters will play in the programmed order.

To stop Program playback, press STOP and PLAY to resume normal playback.

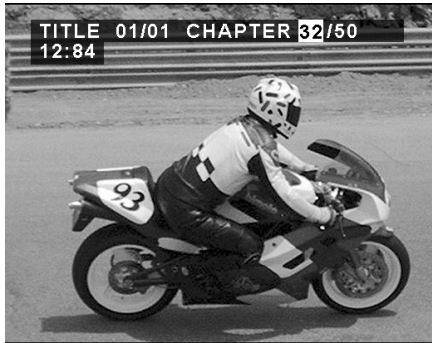

In the example above, the Chapter number is highlighted. Use the number buttons on the remote to enter the desired chapter number.

Selecting a Chapter Number

1. Press the INFO button on the remote control to bring up the Info banner.
2. Press INFO again to highlight the *Chapter* number. Use the number buttons to enter the chapter you want to play.

Selecting a Title Number

1. Press the INFO button on the remote control to bring up the Info banner.
2. Press INFO again to bring up the highlight. The highlight automatically appears on the chapter number.
3. Press the left arrow key to highlight the *Title* number. Use the number buttons to enter the title you want to play.
4. Press INFO again to clear the Info banner from the screen.

Note: These features won't work with a DVD without title and chapter numbers.

Entering an Elapsed Time

You can use the Time Search feature to go to a specific point in a Title.

1. Press the INFO button to bring up the info banner.
2. Press the INFO button twice more to bring up the Time option. Use the number buttons to enter the elapsed time you want to go to in that title. For example, entering 01:35:12 will start playback one hour, thirty-five minutes and twelve seconds into the title.
3. Press INFO again to clear the info banner from the screen.

Subtitles

When a DVD is recorded with subtitles, you can use the Subtitle feature to view the subtitles on-screen. To turn subtitles on:



When the SUBTITLE button is pressed twice, subtitles will be displayed in the default language.

1. Press the SUBTITLE button on the remote. The Subtitle info banner appears. By default, subtitles are off. The info banner will display SUBTITLES OFF. If no subtitles are available, the  icon will appear.
2. To display subtitles, press the SUBTITLE button again. The default language will be displayed in the info banner and subtitles will be displayed in that language. To select a different language, press the right arrow button to scroll through the available languages. When the desired language is highlighted, press OK to turn subtitles on.
3. To turn subtitles off, press the SUBTITLE button until SUBTITLES OFF is displayed.

Note: If the disc does not contain this language, the disc's default language is automatically selected.

Changing the Audio Language

When a DVD is recorded with multiple soundtracks, you can use the Audio feature to temporarily change the audio language (the language of the soundtrack).

1. During disc playback, press AUDIO on the remote (the audio language info banner appears).
2. Press the down arrow key to scroll through available languages.
3. When the highlight is on the desired language, press OK to select it.

Note: When you play a disc the player's default audio language is selected. If the disc does not contain the language you selected, the disc's default language is automatically selected.

This feature is disc-dependent, and may not work with all DVDs.

Changing the Camera Angle

Some DVDs contain multiple angles of a particular scene or sequence.

1. During disc playback, press ANGLE on the remote. (The angle icon appears. If no additional camera angles are available, the  symbol will be displayed.)
2. If multiple camera angles are available, the ANGLE icon displays the current angle number and the number of angles available. For example, 1/4 indicates that angle one is being displayed, and there are four different angles available.
3. Press the ANGLE button again to go to the next camera angle.
4. To resume normal playback, scroll through the camera angles until ANGLE turns off.

Note: This feature does not work when a DVD has not been recorded with a multi-camera angle system.

Using the Repeat Feature

There are four repeat options:

- Off
- Chapter – repeats the chapter that is playing
- Title – repeats the title that is playing
- A-B Repeat – repeats a selected segment of the disc

Repeating a Chapter or Title

The REPEAT button toggles between chapter repeat, title repeat, AB repeat and off.



Press the REPEAT button to select Chapter, Title or AB Repeat.

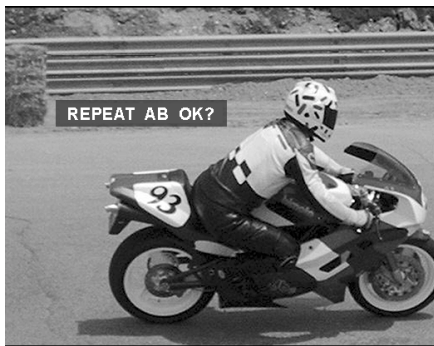

Use A-B Repeat to set a specified segment to repeat.

1. While a disc is playing, press REPEAT (the repeat banner appears).
2. Press REPEAT again to turn on chapter repeat. The current chapter will repeat until you turn REPEAT off or select title or AB repeat.
3. To repeat a title, push the REPEAT button until REPEAT TITLE is displayed.
4. To turn repeat off, press the REPEAT button until REPEAT OFF is displayed.

AB Repeat

AB Repeat lets you repeat a specific segment on the disc that you define.

1. A few minutes before the start of the segment you want to repeat, Press the REPEAT button on the remote until REPEAT AB OK? is displayed.
2. When the disc is at the beginning point of the segment you want to repeat, press OK to set the A point.
3. REPEAT A will be displayed. Allow the disc to play to the end of the segment you want to mark. You must let the disc play in standard playback mode to set the B point in A-B Repeat. If you rewind or fast-forward, A-B Repeat is cancelled.
5. Press OK to set the B point. The A-B Repeat that you set plays until you turn off Repeat.
6. To turn off A-B repeat, press the REPEAT button until REPEAT OFF is displayed. Press OK.

This page intentionally left blank.

Playing Audio CDs and MP3 discs

Chapter Overview:

- Loading and Playing an Audio CD
- Audio CD Playback Features
- Playing MP3 Discs



Changing Entertainment. Again.



Playing Audio CDs and MP3 Discs

Loading and Playing an Audio CD

Before you load a disc, make sure that it is compatible with the player. Note that the following discs CANNOT be used with this player:

- Laserdisc
- CD-I, CD-ROM, DVD-ROM
- MiniDisc
- CD-G discs play audio only, not graphics



Insert with the label facing up.

To Load and Play an Audio CD

1. Press the OPEN•CLOSE button on the front of the DVD player.
2. Place a disc gently into the tray with the disc's label facing up.
3. Press OPEN•CLOSE or PLAY to close the disc tray.

The DVD player reads the disc's table of contents and displays the total number of tracks and the total playing time.

4. Press PLAY to begin playback.
5. Press STOP to stop playback.

Audio CD Playback Features

When playing audio CDs, your DVD player has many of the same features that your CD player has, including track skip, repeat play, and programmed playback.

Skipping Tracks

The info banner shows the current track and the elapsed playing time of that track. Use the CH+ button to go to the next track and the CH- button to go to the previous track.

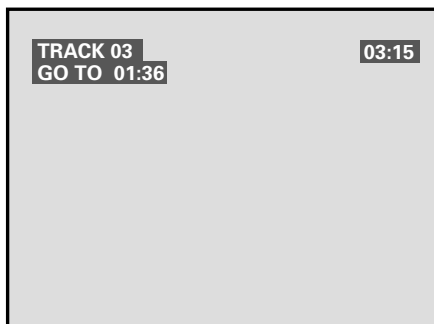

Use the Time Search feature to go to an elapsed time in a track.

Time Search

You can use the TIME SEARCH feature to go to a specific point in a track.

1. Press the INFO button twice. A prompt appears beneath the track number in the Info banner.
2. Use the number buttons to enter the elapsed time you want to go to in that track. For example, entering 01:36 will start playback one minute and thirty-six seconds into the track.

Play Mode

Random

The Random option plays a disc's tracks in random order.

1. Press STOP to stop playback.
2. Press PLAY MODE on the remote control (the *Play Mode* info banner appears).
3. Press the PLAY MODE button until the *Random* option is displayed.
4. Press OK.

To resume normal playback, press STOP and PLAY or press PLAY MODE until the PLAY option is displayed.

Program

The Program playback option allows you to enter the order in which you want tracks to play.

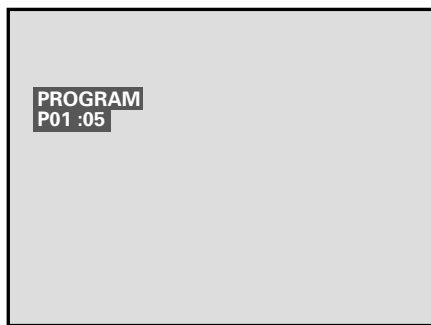

In the example above, the first in the Program Play list will be track 5.

1. Press STOP to stop playback.
2. Press PLAY MODE on the remote control (the Play Mode info banner appears).
3. Press the PLAY MODE button until the *Program* option is displayed.
4. Use the number buttons to enter the first track you want to play. As soon as you enter a number, The info banner shows the order number followed by a colon and the track number.
5. Enter the remaining tracks in the order you want them to play.
6. Press OK.

To resume normal playback, press STOP and PLAY or press PLAY MODE until the PLAY option is displayed.

Playing Audio CDs and MP3 Discs

Using the Repeat Feature

There are four repeat options:

- Repeat Off – Repeat is turned off
- Disc – repeats the entire disc
- Track – repeats the track that is playing
- A-B Repeat – repeats a selected segment of the disc

To Repeat a Track or Disc:

1. While a disc is playing, press REPEAT (the repeat info banner appears and displays REPEAT ONE TRACK).
2. The current track will repeat until you turn Repeat off or select another Repeat option.
3. To repeat the entire disc, press REPEAT until the repeat banner displays REPEAT ALL TRACKS.
4. To turn repeat off, press the REPEAT button until REPEAT OFF is displayed.

A-B Repeat

A-B Repeat lets you repeat a specific segment on the disc that you define.

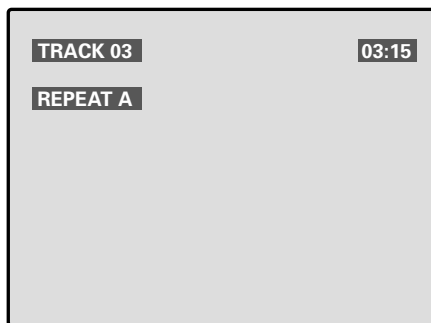

Use the A-B Repeat feature to repeat a segment you have set.

1. At the start of the segment you want to repeat, Press the REPEAT button on the remote until REPEAT AB OK? is displayed.
2. Press OK.
3. REPEAT A will be displayed. When the disc is at the beginning point of the segment you want to repeat, press OK to set the A point.
4. REPEAT AB will be displayed. Allow the disc to play to the end of the segment you want to mark. You must let the disc play in standard playback mode to set the B point in A-B Repeat. If you rewind or fast-forward, A-B Repeat is cancelled.
5. Press OK to set the B point. The A-B Repeat that you set plays until you turn off Repeat.
6. To turn off A-B repeat, press the REPEAT button until REPEAT OFF is displayed. Press OK.

Playing MP3 discs

When you play a MP3 disc, the MP3 menu will be displayed instead of the DVD player menu. The DVD player menu is not available when playing MP-3 discs.

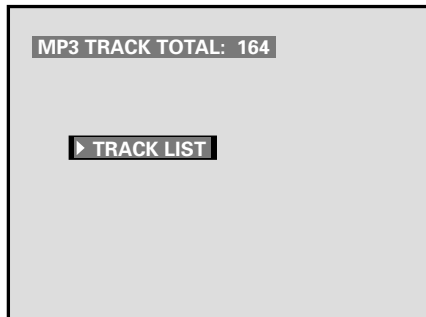

When you first load an MP3 disc, press PLAY to bring up the track list.

1. Press the OPEN•CLOSE button on the front of the DVD player.
2. Place a disc gently into the tray with the disc's label facing up.
3. Press OPEN•CLOSE to close the disc tray.

The number of tracks on the disc is displayed at the top of the screen. The *Track List* option is highlighted.

4. Press PLAY. Track 1 begins playing.
5. Press STOP to stop playback.

Selecting Tracks

Once you load an MP3 disc, press PLAY to bring up the list of tracks available on that disc. The track list is displayed in two columns.

Use the arrow buttons on the remote to select different tracks. As you highlight a track in the track list, that track will begin playing.

Skipping Tracks

- To skip forward to the beginning of the next song on a MP3 disc, press CH+ on the remote or the front of the player.
- To skip backward to the beginning of the song that is playing on a MP3 disc, press CH- on the remote or the front of the player. Press the button again to go to the beginning of the preceding song.

When skipping tracks, the highlight moves from left to right across the columns, so track 1 is the first track listed in column one, track 2 is the first track listed in column 2, track 3 is the second song in column 1, etc.

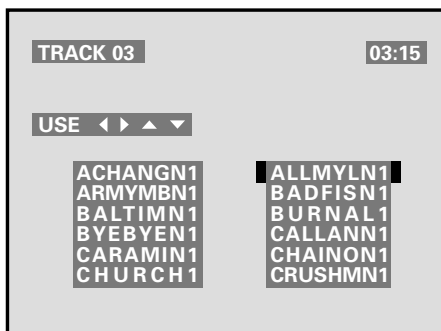

In the example above, track 2 is highlighted. Track 3 is the second track in column 1 (ARMYMBN1).

This page intentionally left blank.

Playing Video CDs

Chapter Overview:

- What is Video CD?
- The Video CD Disc Menu
- Loading and Playing a Video CD
- Video CD Playback Features



Changing Entertainment. Again.



What is a Video CD?

Like DVD video discs, Video CDs contain picture and sound content. Video CDs (VCDs) are encoded in a different format. VCDs don't hold as much information as DVD discs and the picture quality is not as high.

VCDs can have more than one title. Each title is divided into tracks (similar to chapters on a DVD disc).

The Video CD Disc Menu

A Video CD disc is capable of having an on-screen menu that is separate from the DVD player's menu system and on-screen information banners. If the disc has a menu, the menu will appear after the disc is loaded into the player.

The content and operation of disc menus varies from disc to disc. Check the instructions that accompany the Video CD for more information on how to use the playback control functions for that specific disc.

If a disc menu appears:

1. Use the number buttons on the remote to select a track (similar to a chapter).
2. Press OK on the remote to begin playback of the selected track.
3. Press CH+ or CH- on the remote to scroll through the tracks.
4. Press the STOP button on the remote to stop playback and return to the disc menu.

To bring up the disc menu during disc play, press the MENU button on the remote.

If the Video CD Has Playback Control

If a disc is encoded with the playback control function, a menu screen appears after the disc is loaded into the player.

1. Use the number buttons on the remote to select a track.
2. Press OK to begin playback of the selected track.
3. Press CH+ or CH- on the remote to scroll through the tracks.
4. Press STOP to stop playback and return to the menu or press STOP twice to stop playback and remove the menu from the screen.

Bypassing Playback Control

If a Video CD has playback control, you can bypass the disc's menu by following these steps when you first load the discs.

1. Press STOP to put the player in the stop mode.
2. Use the number buttons on the remote to enter the desired track number, and then press OK. When playback begins, the disc will respond as if it is not in the Playback Control mode.

Resuming Playback Control

To resume the Playback Control mode, press MENU (the disc's menu appears).

Using the Time Search Feature

You can use the Time Search feature to begin playback from any point on the disc (in the currently playing title) by entering the elapsed time. For example, if you have a favorite scene that begins 12:34 minutes into the movie, you can go directly to that point in the title.

1. With the disc playing, press the INFO button on the remote twice (the time search prompt will be displayed).
2. Enter the elapsed time where you want to begin playback. As soon as you enter the last number, playback will begin from the time that you specified.

Note: This feature does not work in Playback Control mode.



This is the Index menu. Press a number button to select the corresponding option.



Tracks are displayed nine to a page. Press the number button displayed in the corner of a thumbnail to select that track.

The Index Feature

The index feature displays small pictures or “thumbnails” of each title and track on the disc.

1. Press STOP twice.
2. Press the GUIDE button (the index may take a moment to load).
3. The Index menu is displayed. The options are numbered. Use the number buttons on the remote to select an option.
 - **Intro** plays the first few seconds of the title.
 - **Disc Index** shows thumbnails of the titles available on the disc.
 - **Track Index** shows thumbnails of the tracks of the currently selected title.
4. If you select Disc Index or Track Index, the screen displays thumbnails of the available titles or chapters. Up to nine thumbnails are displayed per screen. Each thumbnail has a number in the corner. You can select and play a chapter by pressing that number on the remote.
5. To view the next nine thumbnails, press the CH+ button to go forward and the CH- button to go to the previous page.
6. To exit the digest without making a selection, press the STOP button.

This page intentionally left blank.

The Menu System

Chapter Overview:

- The Display Menu
- The Sound Menu
- The Password Menu
- The Preferences Menu

Changing Entertainment. Again.



The Menu System

The Setup Menu

The Display Menu



4x3 PS (Pan & Scan)

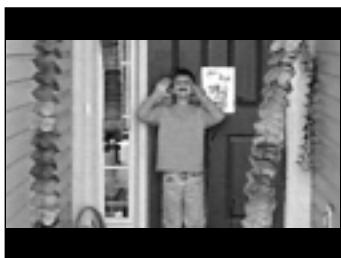

4x3 Letterbox



16x9 Widescreen

Image

Depending on the type of television you have, you may want to adjust the screen setting (aspect ratio). The default setting is 4x3 (pan & scan).

1. With no disc playing, press MENU (the main menu appears).
2. Use the arrow buttons to highlight the *Display* option. Press OK to select it. (The Display menu is appears).
3. Use the up/down arrow buttons to highlight the *Image* option. The image display options appear on the right.
4. Press the right arrow button to move to the image options. Use the up/down arrow buttons to highlight the desired image display. When an option is highlighted, the option description appears at the bottom of the screen.
5. Press OK to select the option.
6. Press the left arrow button to return to the Display menu options on the left. To return to the main menu, highlight the *Main Menu* option and press OK.

4 x 3 P&S – Choose this setting if you want the movie to fill the entire screen of your TV. This might mean that parts of the picture (the left and right edges) won't be seen.

Most discs produced in a widescreen format can't be cropped in this fashion. This means the black bars will appear at the top and the bottom of the screen.

4 x 3 LB – Choose this setting if you want to see movies in their original aspect ratio (height-to-width ratio). You'll see the entire frame of the movie, but it will take up a smaller portion of the screen vertically. The movie might appear with black bars at the top and bottom of the screen.

16 x 9 Wide – Choose this setting if your DVD Player is connected to a widescreen TV. If you choose this setting and you don't have a widescreen TV, the images on the screen may appear distorted due to vertical compression.

If you play a disc recorded in 4 x 3 format on a widescreen TV, black bars will appear on the left and right side of the screen.

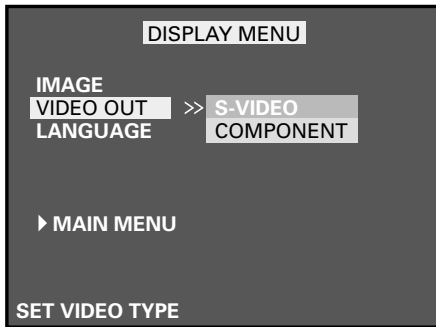

The Display Menu with the VIDEO OUT option selected.

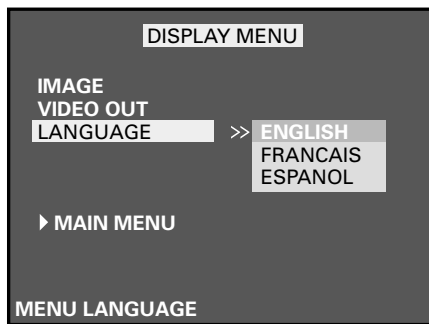

The Display Menu with the Language option highlighted.

Video Out

The VIDEO OUT option is used to select the correct video connection. If you connected your DVD player with an S-Video cable, select the *S-Video* option. If you used component cables to connect your player, select the *Component* option.

Menu Language

Use this feature to change the language for the player's on-screen menu system. The default is English.

1. With no disc playing, press MENU (the main menu appears).
2. Use the arrow buttons to highlight the *Display* option. Press OK to select (The Display menu appears).
3. Use the up/down arrow buttons to highlight the *Language* option. The language choices appear on the right.
4. Press the right arrow button to move to the language choices. Use the up/down arrow buttons to highlight the desired language.
5. Press OK to select the language. The menu will immediately change to the selected language.
6. Press the left arrow button to return to the Display menu options on the left. To return to the main menu, highlight the *Main Menu* option and press OK.

The Sound Menu

Selecting Digital Output Type

If you have a receiver with a digital signal input, use this feature to select your player's type of digital output.

OFF No signal is output from the optical or coaxial port.

BITSTREAM Select this option when the DVD player is connected with a power amplifier through optical or coaxial port. The power amplifier connected must have Dolby Digital, DTS and MPEG decoding.

PCM Select this option when the DVD player is connected with a 2-channel digital or stereo amplifier.

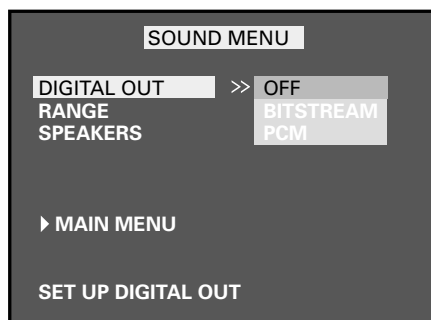

The Sound menu with the Digital Out option highlighted.

1. With no disc playing, press MENU (the main menu appears).
2. Use the arrow buttons to highlight the *Sound* option. Press OK to select (The Sound menu is displayed).
3. Use the up/down arrow buttons to highlight the *Digital Output* option. The digital output choices appear on the right.
4. Press the right arrow button to move to the digital output choices. Use the up/down arrow buttons to highlight the desired choice. When an option is highlighted, the option description appears at the bottom of the screen.
5. Press OK to select the choice.
6. Press the left arrow button to return to the Sound menu options on the left. To return to the main menu, highlight the *Main Menu* option and press OK.

Range

This feature compresses the dynamic range (quietest sound to loudest sound) of a disc's soundtrack. For example, action scenes might be very loud, while whispered dialog is quiet. The Range feature evens out the range of the volume by making loud sounds quieter and soft sounds louder. The Range option is always on. You can adjust the dynamic range with the Range option.

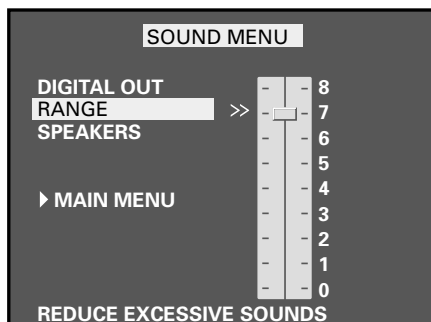

Use the up/down arrow keys to set the Dynamic Range.

1. With no disc playing, press MENU (the main menu appears).
2. Use the arrow buttons to highlight the *Sound* option and press OK to select it (The Sound menu is displayed).
3. Highlight the *Range* option and press OK to select it.
4. A slider bar appears. Press the right arrow button to move to the slider bar. Use the up/down arrow buttons to adjust the range.
5. When the range is adjusted, press the left arrow button to return to the Sound menu options. To return to the main menu, highlight the *Main Menu* option and press OK.

Speakers

The Front Speaker feature has two options:

- **STEREO+** If you have a Dolby Pro Logic receiver hooked up, select this option so the receiver can decode the signals and reproduce a surround sound effect.
- **STEREO** Select this option if you have a stereo receiver hooked up.

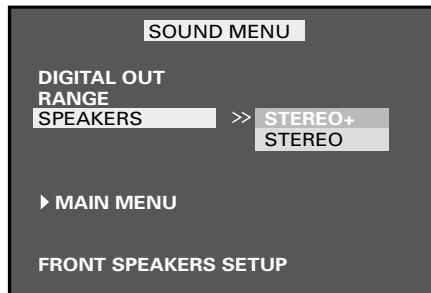

The Sound Menu with the Speakers option selected.

1. With no disc playing, press MENU (the main menu appears).
2. Select the *Sound* option (the Sound menu appears).
3. Use the up/down arrow buttons to highlight the *Speakers* option. The speaker choices appear on the right.
4. Press the right arrow button to move to the speaker choices. Use the up/down arrow buttons to highlight the desired choice. When an choice is highlighted, it's description appears at the bottom of the screen.
5. Press OK to select the choice.
6. Press the left arrow button to return to the Display menu options on the left. To return to the main menu, highlight the *Main Menu* option and press OK.

The Password Menu

Creating a Password

You can use a password to control what types of movies your family watches.

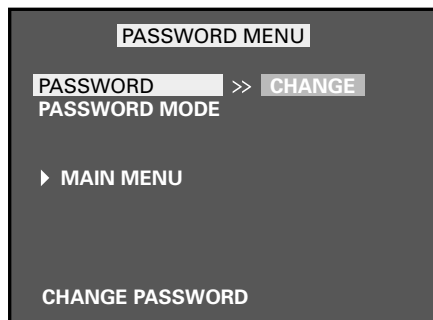

Setting a Password gives you control over what type of content your family watches.

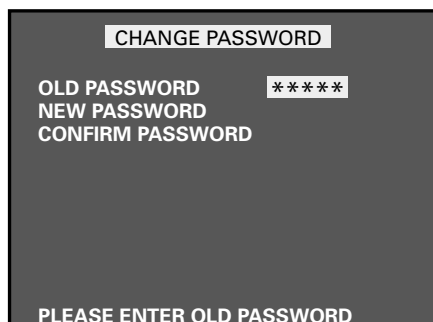

You can change the password at any time.

1. With no disc playing, press MENU (the main menu appears).
2. Use the down arrow to highlight *Password* (the *Password* menu appears).
3. Highlight the *Password* option.
4. Press the right arrow to highlight the *Change* option and press OK to select it (the Change Password screen appears).
5. You will be prompted for the old password. The first time you use the password feature, you will need to enter the default password, which is 99999.
6. You will be prompted for a new password. Enter a 5-digit number (this is your password).
7. To confirm the new password, you will be prompted to re-enter it. Re-enter the new password.
 - If you've re-entered the new password incorrectly, the message *New password not confirmed* appears at the bottom of the screen. Re-enter the new password.
8. Press OK to return to the Password menu.

Changing the Password Mode

The Password feature can be turned on or off. In order for parental rating to work, password must be turned on.

1. With no disc playing, press MENU (the main menu appears).
2. Use the down arrow to highlight *Password* (the Password menu appears).
3. Highlight the *Password Mode* option.
4. Use the right arrow to move to the on/off options. Use the up/down arrows to highlight the desired option.
5. Press OK to select the option.
6. Enter your password.
7. Press OK to return to the Password menu.

Note: If Password Mode is turned on and you play a disc which is higher than the parental rating you've set, you must enter your password to play that disc.

The Preferences Menu

If the Password mode is on, the Preferences menu will appear grayed out and you won't be able to select it. In order to use the Preferences menu, Password mode must be turned off. If Password mode is on, turn it off in the Password menu and exit the menu system completely. Press the Menu button to bring up the main menu again.

Selecting the Audio Preference

Use the Audio menu to select the soundtrack language that you prefer. If the disc you are playing has that language available, it will play in that language. If your preferred audio language isn't available, the disc's default language will be played.

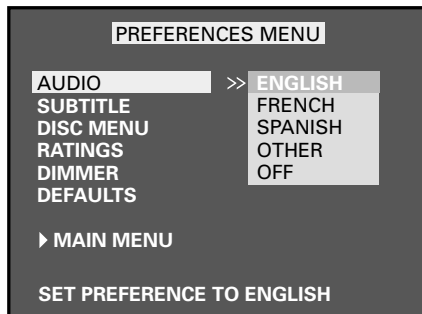

The Preferences Menu with the Audio option selected.

1. With no disc playing, press MENU (the main menu appears).
2. Use the down arrow to highlight *Preferences* (the Preferences menu appears).
3. Highlight the *Audio* option. A list of language choices appear on the right.
4. Use the right arrow to move to the language choices. Use the up/down arrows to highlight the desired choice.
5. Press OK to select the option.
6. Press the left arrow to return to the Preferences menu.

Notes:

Not all discs provide multiple languages for the soundtrack.

Some discs may not contain the language you selected as your initial language; in that case the disc will use its own default language setting.

Selecting the Subtitle Language

Use the Subtitle Language menu to select the subtitle language you prefer. If the disc you are playing has that language available, it will display subtitles in that language. If your preferred subtitle language isn't available, the disc's default language will be displayed.

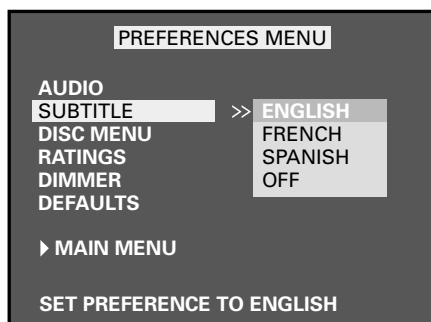

The Preferences Menu with the Subtitle option selected.

1. With no disc playing, press MENU (the main menu appears).
2. Use the down arrow to highlight *Preferences* (the Preferences menu appears).
3. Highlight the *Subtitle* option. A list of languages appears on the right.
4. Use the right arrow to move to the language choices. Use the up/down arrows to highlight the desired choice.
5. Press OK to select the choice.
6. Press the left arrow to return to the Preferences menu.

Note: Not all discs provide multiple languages for the subtitles.

The Menu System

Changing the Disc Menu Language

Use the *Disc Menu* option to select the language you want a DVD's disc menu to be displayed in (not the same as the player menu).

1. With no disc playing, press MENU (the main menu appears).
2. Use the down arrow to highlight *Preferences* (the *Preferences* menu appears).
3. Highlight the *Disc Menu* option. A list of languages appears on the right.
4. Use the right arrow to move to the language choices. Use the up/down arrows to highlight the desired choice.
5. Press OK to select the choice.
6. Press the left arrow to return to the Preferences menu.

Setting the Ratings Limit

The Ratings feature is a rating limit system, like movie ratings. It works with DVD discs that have been assigned a rating. This helps you control the types of DVDs that your family watches.

This option lets you determine how your player will react to discs that contain movies that are rated (in the U.S.A., the Motion Pictures Association of America rates movies as G, PG, PG-13, etc.).

You decide which ratings require a password and which ones don't. This system ranks the ratings 1 through 8 in order to accommodate different countries' ratings systems (1 is considered a movie title with the least offensive material).

In order for the Ratings feature to work, the disc must be encoded with rating information and the Password mode must be turned on.

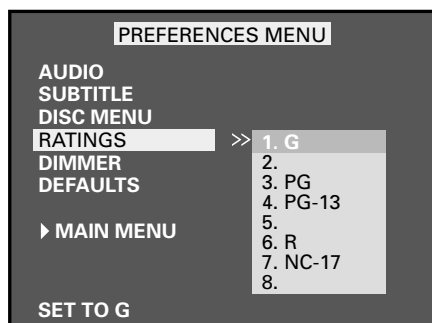

The Preferences Menu with the Ratings option selected.

1. With no disc playing, press MENU (the main menu appears).
2. Use the down arrow to highlight *Preferences* (the Preferences menu appears).
3. Highlight the *Ratings* option. The ratings list appears on the right.
4. Use the right arrow to move to the rating options. Use the up/down arrows to highlight the desired rating.
5. Press OK to select the option.
6. Press the left arrow to return to the Preferences menu.

Dimming the Front Display

The DIMMER option is used to dim the display on the front of the player.

1. With no disc playing, press MENU (the main menu appears).
2. Use the down arrow to highlight *Preferences* (the Preferences menu appears).
3. Highlight the *Dimmer* option.
4. Use the right arrow to move to the dimmer options. Use the up/down arrows to highlight the desired setting.
5. Press OK to select the option.
6. Press the left arrow to return to the Preferences menu.

Defaults

Use the Default feature to reset ALL options to the factory defaults.

1. With no disc playing, press MENU (the main menu appears).
2. Use the down arrow to highlight *Preferences* (the Preferences menu appears).
3. Highlight the *Defaults* option.
4. Use the right arrow to move to the *Reset* option.
5. Press OK to select the option.
6. Press the left arrow to return to the Preferences menu. To return to the main menu, highlight the *Main Menu* option and press OK.

This page intentionally left blank.

Other Information

Chapter Overview:

- Troubleshooting
- Limited Warranty
- Accessory Ordering Information

Changing Entertainment. Again.



Troubleshooting

Common Problem	Solution
No Power	Insert the power cord's plug securely into the outlet.
Power turns itself off	The power is automatically turned off after approx 30 minutes have elapsed in the stop mode (auto power-off feature). Turn power back on.
Player fails to start, even when PLAY is pressed	<ul style="list-style-type: none"> • Ensure that the disc is installed with the label side facing up. • This player plays only DVD discs, Audio CDs and Video CDs.
Play commences but then stops immediately	<ul style="list-style-type: none"> • The disc is dirty. Clean it. • Condensation has formed. Allow player to dry out.
No picture	<ul style="list-style-type: none"> • Ensure that the equipment is connected properly. • Turn on the TV's power. • Ensure that the input setting for the TV is correct.
Picture is distorted during forward and reverse scan	<ul style="list-style-type: none"> • It is normal for some distortion to appear while scanning.
No sound or distorted sound	<ul style="list-style-type: none"> • Ensure that the equipment is connected properly. • Ensure that the input settings and the volume adjustment for the TV and/or receiver are correct. • No sound is heard during still, frame advance, or slow-motion play.
No operations can be performed with remote	<ul style="list-style-type: none"> • The batteries in the remote may need replacing. • Operate the remote control closer to the DVD player. • Remove any obstacles between the remote and the DVD player or other component. • Remove batteries and hold down one or more buttons for 60 seconds to drain the microprocessor inside the remote to reset it. Reinstall batteries and try remote again. You may need to reprogram it.
The  icon appears on screen	<ul style="list-style-type: none"> • The feature or action cannot be completed at this time because: <ol style="list-style-type: none"> 1. The disc's software restricts it. 2. The disc's software doesn't support the feature (e.g., angles). 3. The feature is not available at the moment. 4. You've requested a title or chapter number or search time that is out of range.
No sound while playing a DVD	<ul style="list-style-type: none"> • The DTS option is selected but your receiver has no DTS decoder, or you don't have a receiver connected.

Troubleshooting

DVD Problem	Solution
Subtitle and/or audio language is not the one selected from the initial setting	If the subtitle and/or audio language does not exist on the disc, the initial settings will not be seen/heard. The disc's priority language is selected instead. Set the subtitle and or audio language initial setting manually.
No on-screen display	The OFF setting is selected for OSD Display; select ON in the Setup menu.
The menu is displayed in a foreign language	The Menu Language preference is set to that language. With no disc playing, press the MENU button on the remote. From the main menu, press 3 to access the PLAYER MENU LANGUAGE screen.
Play doesn't begin when a title is selected	The rating level has been set and the disc is subject to that restriction.
No forward or reverse scan	Some DVDs have sections that prohibit rapid scanning, or title and chapter skip.
Disc won't play	<ul style="list-style-type: none"> • Both the player and the DVD is coded by region. If the regional codes don't match, the disc cannot be played. This player is Region No. 1. Check the disc code. • Verify that the disc is a type that this player can read. See page 22. • Clean the disc. • Try another disc to see if the disc that won't play is bad.
Desired angle cannot be changed	Some DVDs do not have the multi-camera angle system, and some discs have it only on certain portions.
Picture is not displayed with correct aspect ratio	Make sure the TV SCREEN feature in the Setup menu is set correctly for your television.
Forgot Rating Limit Password	With the power on, press and hold the STOP and PLAY/PAUSE buttons on the player. This resets the password feature and all other settings to the initial factory settings. You may be required to select a menu language the next time you power up.
Cannot copy discs to video tape	This player is equipped with anticopy protection.
"will not read disc" or other error message	Turn the player off and unplug it to reset the DVD player. Wait approximately 2 minutes, plug the player back in and turn it on.

Limited Warranty RCA Digital Video Disc (DVD) Player

What your warranty covers:

- Defect in materials or workmanship.

For how long after your purchase:

- 90 days from date of purchase - Unit exchange, which includes parts and labor.
- 91 days to 1 year from date of purchase - Unit exchange, which includes parts only; you pay the labor.
- The warranty for rental units begins with the first rental or 45 days from date of shipment to the rental firm, whichever comes first.

What we will do:

During the initial 90 days:

Exchange the DVD unit with a new or, at our option, refurbished unit.

After the 90 days and within one year:

Exchange the DVD unit with a new or, at our option, refurbished unit. We will bill you a flat exchange charge to replace a defective unit. This charge covers the labor cost for its repair.

How you get service:

- Call 1-800-311-9263 and have your unit's date of purchase and model/serial number ready. The model/serial number information is on the back of your unit.
- A representative will troubleshoot your problem over the phone.
- If the representative determines that you should receive a replacement unit you will be provided with a Service Request (SR) number and the location of a nearby exchange point if one exists. No returns will be accepted without the SR number.
- Proof of purchase in the form of a bill of sale or receipted invoice which is evidence that the product is within the warranty period must be presented to obtain warranty service. For rental firms, proof of first rental is also required.

To receive a replacement unit before you return yours:

Option I:

1. Provide your Discover, MasterCard or Visa account number and expiration date to your phone representative. This is for security purposes only and your account will not be charged at this time.
2. We will send you a replacement unit.
3. If you return the unit to us within 14 days from the date you were provided a SR number, only items not covered by warranty will be charged to your account. If your unit is not received within 14 days, the suggested retail value of the unit will be charged to your credit card. This amount will be credited, less a \$10 handling fee, if the unit is subsequently received.
4. Ship your defective unit back to us using the replacement unit's carton. Shipping instructions will be included on the carton along with your SR number which will allow you to easily ship the unit back to us. Make sure you insure your shipment in case of damage or loss. Include with the shipment:
 - Evidence of purchase date such as a bill of sale.
 - A brief note describing your unit's problem.
 - Your name, address and phone number.

Option II:

1. For a fee of \$10.00, we will send a replacement unit to our exchange point.
2. The exchange location will notify you of its arrival.
3. Take your unit and evidence of purchase date, such as a bill of sale, to the exchange location and you will be provided the new or refurbished unit. Please retain all accessories such as the remote control hand unit.
4. If the repairs are covered by your warranty, you will not be billed.

Thomson assumes no responsibility for warranty shipments from the customer to the factory if not shipped in the manner prescribed by Thomson.

Return transportation, storage, handling and insurance costs are your responsibility. We accept no responsibility in case of damage or loss.

To receive a replacement unit after we have received your unit:

- Write the SR number on the outside of the carton used to return the unit. Make sure you insure your shipment in case of damage or loss.
- Carefully pack the unit using the original box and packing material if possible. Please retain all accessories that were included with your unit such as the remote control hand unit.
- Include with the shipment:
 1. Evidence of purchase date, such as a bill of sale, to verify your unit's warranty eligibility.
 2. A brief note describing your unit's problem.
 3. Your name, address and phone number.
- The representative will advise the address to mail a cashier's check or money order for payment if there are any out of warranty labor or parts charges, and you elect not to use your credit card.
- After we receive your product, a new or refurbished unit will be shipped to you.

What your warranty does not cover:

- Acts of nature, such as but not limited to lightning damage.
- Adjustment of customer controls.
- Damage from misuse or neglect.
- A unit that has been modified or incorporated into other products or is used for institutional or other commercial purposes.
- Batteries.
- Units purchased or serviced outside the U.S.A.
- Shipping damage if the unit was not packed and shipped in the manner prescribed by Thomson.
- Storage fees may be charged by the exchange point if you fail to pickup the replacement unit in a timely manner.

Product Registration:

- Please complete and mail the Product Registration Card packed with your DVD product. It will make it easier to contact you should it ever be necessary. The return of the card is not required for warranty coverage.

Limitation of Warranty:

- **THE WARRANTY STATED ABOVE IS THE ONLY WARRANTY APPLICABLE TO THIS PRODUCT. ALL OTHER WARRANTIES, EXPRESS OR IMPLIED (INCLUDING ALL IMPLIED WARRANTIES OF MERCHANTABILITY OR FITNESS FOR A PARTICULAR PURPOSE) ARE HEREBY DISCLAIMED. NO VERBAL OR WRITTEN INFORMATION GIVEN BY THOMSON MULTIMEDIA INC., ITS AGENTS OR EMPLOYEES SHALL CREATE A WARRANTY OR IN ANY WAY INCREASE THE SCOPE OF THIS WARRANTY.**
- **REPAIR OR REPLACEMENT AS PROVIDED UNDER THIS WARRANTY IS THE EXCLUSIVE REMEDY OF THE CONSUMER. THOMSON MULTIMEDIA INC. SHALL NOT BE LIABLE FOR INCIDENTAL OR CONSEQUENTIAL DAMAGES RESULTING FROM THE USE OF THIS PRODUCT OR ARISING OUT OF ANY BREACH OF ANY EXPRESS OR IMPLIED WARRANTY ON THIS PRODUCT. THIS DISCLAIMER OF WARRANTIES AND LIMITED WARRANTY ARE GOVERNED BY THE LAWS OF THE STATE OF INDIANA. EXCEPT TO THE EXTENT PROHIBITED BY APPLICABLE LAW, ANY IMPLIED WARRANTY OF MERCHANTABILITY OR FITNESS FOR A PARTICULAR PURPOSE ON THIS PRODUCT IS LIMITED TO THE APPLICABLE WARRANTY PERIOD SET FORTH ABOVE.**

How state law relates to warranty:

- Some states do not allow the exclusion nor limitation of incidental or consequential damages, or limitations on how long an implied warranty lasts, so the above limitations or exclusions may not apply to you.
- This warranty gives you specific legal rights, and you also may have other rights that vary from state to state.

If you purchased your product outside the United States:

- This warranty does not apply. See your dealer for warranty information.

This page intentionally left blank.

Accessories and Order Form



Optical Plug to Optical Plug DV3 (3 ft.) DV6 (6 ft.)



Optical Plug to Mini Plug DV3M (3 ft.) DV6M (6 ft.)



Coaxial Digital Audio Cable

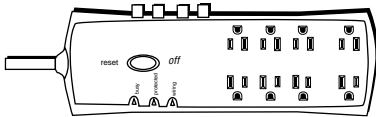

Surge Protector (SCTV160)

Accessory Order Form for Your DVD Player

Description	Part No.	Price	Qty
Optical Plug to Optical Plug (3 ft.)	DV3	\$15.95	
Optical Plug to Optical Plug (6 ft.)	DV6	\$19.95	
Optical Plug to Mini Plug (3 ft.)	DV3M	\$15.95	
Optical Plug to Mini Plug (6 ft.)	DV6M	\$19.95	
Coaxial Digital Audio Cable (3 ft.)	DT3A	\$9.95	
Coaxial Digital Audio Cable (6 ft.)	DT6A	\$14.95	
Surge Protector	SCTV160	\$49.95	

Total Merchandise	\$
Sales Tax	\$
We are required by law to collect the appropriate sales tax for each individual state, country, and locality to which the merchandise is being sent.	
Shipping and Handling	\$ 5.00
Total Amount Enclosed	\$
Use VISA, MasterCard or Discover Card preferably. Money order or check must be in U.S. currency only. No COD or CASH.	

Prices are subject to change without notice.

All accessories are subject to availability.

Please complete other side also 



Detach Here

Charge your order on your VISA, MasterCard, or Discover Card by filling in below

USE YOUR CREDIT CARD

IMPORTANT: Copy and complete account number from your VISA card



My card expires:

IMPORTANT: Copy and complete account number from your MasterCard



Copy Number above your name on MasterCard: My card expires:

IMPORTANT: Copy and complete account number from your Discover Card



My card expires:

AUTHORIZED SIGNATURE
(Credit card order will not be processed without signature)

Print or type your name and address clearly.



A complete and correct order will save you days of waiting.

Name: _____

Street: _____

_____ Apt. _____

City: _____

State: _____ Zip: _____

Daytime Telephone No.: _____

Please make sure that both sides of this form have been filled out completely.

- Allow 4 weeks for delivery.
- All accessories are subject to availability.
- Prices are subject to change.

To Place an Order:

To place your order by phone, have your Visa, MasterCard or Discover Card ready and call the toll-free number listed below.

Use this number only to place an order for accessory items listed on this order form.

1-800-338-0376

To place your order by mail, detach and mail the completed order form with credit card information, money order or check in US currency (made payable to Thomson multimedia Inc.) to the following address:

Video Accessories
PO Box 8419
Ronks, PA 17573

Index

Symbols

- 16 x 9 wide 44
- 4 x 3 Letterbox 44
- 4 x 3 Standard 44

A

- A-B repeat
 - Audio CD 36
 - DVD 31
- Accessories 59
- ANGLE button 20, 30
- Arrow buttons 21
- Aspect ratio 44
- Audio
 - Dolby Digital 10
- AUDIO button 20, 30
- Audio CD
 - loading a disc 34
 - playback features 34
- Audio equipment
 - Dolby Digital 10
 - DTS 10
- Audio language
 - changing 30
- Audio R and L jacks 16

B

- Batteries, remote 18
- Buttons, remote 20

C

- Cables
 - needed for connecting 7
- Camera angle 30
- CH+ button 20
- CH- button 20
- Chapter number, selecting 29
- Chapter, repeating 31
- CLEAR button 21
- Common Problems 54
- Connections 8, 9, 11
 - DVD player + TV with Audio/Video Input
 - Jacks 8
 - DVD player + TV + VCR 9
 - DVD player + TV+ Dolby Digital or DTS
 - Receiver 11
 - DVD player + TV+ Dolby Pro Logic or Stereo
 - Receiver 13
 - DVD player + TV + VCR + Satellite Receiver
 - 15
- Connections, types of 7

D

- Defaults 51
- DIGITAL AUDIO OUT jack 10, 16
- Digital output type, selecting 46
- Dimming the Front Display 51
- Disc
 - loading and playing 24
- Disc menu 24
- Disc Menu Language 51
- Discs
 - digital video discs 24
 - types you can't play 24
- Display, dimming 51
- Dolby Digital 11
- Dolby Pro Logic 11, 13
- DTS 10
- DVD
 - playback features 27

F

- Fast motion playback 27
- FORWARD button 21
- Frame Advance 27
- Freeze frame (pause) 27
- Front panel controls 17

G

- GO BACK button 20
- GUIDE button 20

I

- Index 41
- INFO button 21
- Input channel 19
- Installing batteries 18

J

- Jacks
 - AUDIO OUT R L 16
 - DIGITAL AUDIO OUT 16
 - R and L 16
 - S-VIDEO 16
 - VIDEO OUT 16

L

- Language Code List 52
- Loading a disc
 - audio CD 34
 - DVD 25

M

- Menu button 21
- MP3, playing files 37
- Motion Pictures Association of America 50
- MUTE button 20

N

- Number buttons 21

O

- OK/SELECT button 21
- ON•OFF button 17
- OPEN•CLOSE button 17
- Order form, accessories 59

P

- Password, changing 48
- PAUSE button 21, 27
- Picture scan 27
- PLAY button 17, 21, 27
- PLAY MODE button 20
- Play Mode
 - Random 28, 35
 - Program 28, 35
- Playback features
 - audio CD 34
 - DVD 27
 - Frame advance 27
 - Freeze frame 27
 - Skipping chapters 27
- Playing
 - digital video discs 24

R

- R and L jacks 16
- Range 46
- Rating Limit 50
- Regional coding 24
- Remote control
 - pointing 18
- Remote, installing batteries 18
- Repeat
 - A-B 31, 36, 41
 - chapter 31
 - disc 36
 - title 31
- REPEAT button 21, 31, 36
- Repeat play 31, 36
- REVERSE button 21, 27

Reference

S

- S-VIDEO jack 16
- Satellite
 - connecting 15
- Search
 - fast motion playback 27
- Selecting
 - Chapter number 29
 - Title number 29
- Skipping Chapters 27
- Skipping Tracks
 - CDs 34
 - MP3 37
 - VCDs 40
- Sound Menu 46
- Speakers 47
- STOP button 21
- Subtitles
 - turning on/off 30
 - selecting a language 30
 - codes 52
- SUBTITLE button 20

T

- Time Search feature 41
- Title
 - repeating 31
- Title Number
 - selecting 29
- Troubleshooting 54
- TV's Video Input Channel 19
- Types of Discs the Player Can Play 18

V

- VCDs 40
- Video CDs 40
- Video Input Channel 19
- VIDEO OUT jack 16
- VOL< button 20
- VOL> button 20

Z

- ZOOM button 20

Please do not send any products to the Indianapolis address listed in this manual or on the carton. This will only add delays in service for your product.

Thomson multimedia Inc.

10330 North Meridian Street
Indianapolis, IN 46290

©2001 Thomson multimedia Inc.

Trademark(s)® Registered

Marca(s) Registrada(s)

Printed in China

TOCOM 15739290

Free Manuals Download Website

<http://myh66.com>

<http://usermanuals.us>

<http://www.somanuals.com>

<http://www.4manuals.cc>

<http://www.manual-lib.com>

<http://www.404manual.com>

<http://www.luxmanual.com>

<http://aubethermostatmanual.com>

Golf course search by state

<http://golfingnear.com>

Email search by domain

<http://emailbydomain.com>

Auto manuals search

<http://auto.somanuals.com>

TV manuals search

<http://tv.somanuals.com>