

HP Photosmart  
M730 series  
Digital Camera  
User Guide



## Legal and notice information

© Copyright 2007 Hewlett-Packard Development Company, L.P.

The information contained herein is subject to change without notice. The only warranties for HP products and services are set forth in the express warranty statements accompanying such products and services. Nothing herein should be construed as constituting an additional warranty. HP shall not be liable for technical or editorial errors or omissions contained herein.

Windows® is a U.S. registered trademark of Microsoft Corporation.



SD Logo is a trademark of its proprietor.

---

# Contents

<b>1 Getting started</b>	
Camera top and back .....	3
Camera front, side, and bottom.....	4
Before taking pictures.....	4
Install the batteries.....	4
Turn on the camera.....	4
Choose the language.....	5
Set the region.....	5
Set the date and time.....	5
Install and format an optional memory card.....	6
Install the software.....	6
Using your camera.....	7
<b>2 Taking pictures and recording video clips</b>	
Taking pictures.....	8
Recording video clips.....	9
Instant Review.....	9
Auto focus and exposure.....	9
Focusing on the subject.....	10
Optimizing focus.....	10
Using Focus Lock.....	11
Optimizing exposure.....	11
Using zoom.....	11
Optical zoom.....	12
Digital zoom.....	12
<b>3 Setting options for taking pictures and recording video clips</b>	
Setting the flash.....	13
Flash Setting—Red-Eye.....	13
Using the Picture Capture and Video Record menus.....	14
Using Panorama mode.....	15
Using the Self-Timer setting.....	16
Using the Burst setting.....	17
Adaptive Lighting.....	17
White Balance.....	17
<b>4 Reviewing images and video clips</b>	
Deleting images.....	19
Viewing thumbnails.....	19
Magnifying images.....	19
Using the Playback Menu.....	20
Removing red eyes.....	20
Tagging images as Favorites.....	21
Viewing slideshows.....	21
Previewing panoramas.....	21

<b>5 Using the Design Gallery Menu</b>	
Applying artistic effects.....	22
Modifying colors.....	23
Adding borders.....	23
Cropping images.....	23
<b>6 Transferring and printing images</b>	
Transferring images with HP Photosmart Software.....	25
Transferring images without HP Photosmart Software.....	26
Connecting to the computer.....	26
Using a memory card reader.....	27
Printing images directly to a printer.....	27
<b>7 Using HP Photosmart Express</b>	
Using the Photosmart Express Menu.....	29
Marking images for printing.....	29
Buying prints online.....	30
Sharing images.....	31
Setting up online destinations in the camera.....	31
Sending images to online destinations.....	31
<b>8 Using the Camera Setup Menu</b> .....	33
<b>9 Troubleshooting</b>	
Resetting the camera.....	34
Problems and solutions.....	34
Camera error messages.....	39
<b>10 Product support</b>	
Helpful websites.....	40
Getting assistance.....	40
<b>A Managing batteries</b>	
Top points about batteries.....	41
Extending battery life.....	41
Safety precautions for using batteries.....	41
Power indicators.....	42
Battery performance.....	42
Recharging NiMH batteries.....	43
<b>B Specifications</b>	
Memory capacity.....	45
Image quality.....	45
<b>Index</b> .....	46

# 1 Getting started

Use this section to get familiar with camera controls, set up your digital camera for use, and begin taking pictures.

## Camera top and back

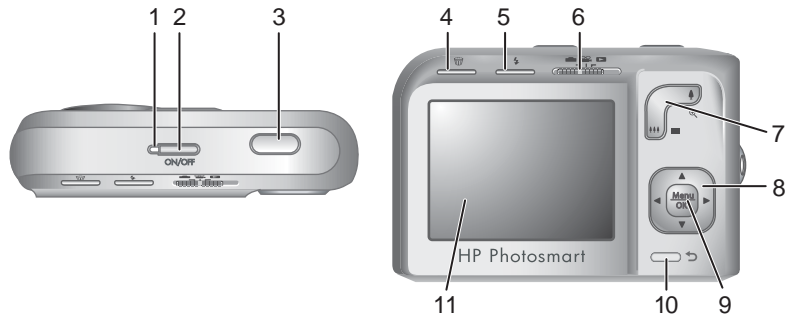

1	Power light.
2	ON/OFF button.
3	<b>Shutter</b> button.
4	<b>Delete</b> button—Accesses the <b>Delete</b> function while in <b>Instant Review</b> (see <a href="#">“Instant Review”</a> on page 9) and <b>Playback</b> (see <a href="#">“Deleting images”</a> on page 19).
5	<b>Flash</b> button— Accesses the flash settings while in <b>Picture Capture</b> (see <a href="#">“Setting the flash”</a> on page 13).
6	selector—Switches between <b>Picture Capture</b> , <b>Video Record</b> , and <b>Playback</b> (see <a href="#">“Taking pictures”</a> on page 8, <a href="#">“Recording video clips”</a> on page 9, and <a href="#">“Reviewing images and video clips”</a> on page 18).
7	<b>Zoom lever</b> —Accesses <b>Zoom</b> (see <a href="#">“Using zoom”</a> on page 11), <b>Thumbnails</b> (see <a href="#">“Viewing thumbnails”</a> on page 19), and <b>Magnify</b> (see <a href="#">“Magnifying images”</a> on page 19) functions.
8	and  buttons—Scroll through menus and images.
9	<b>Menu/OK</b> button—Displays camera menus, selects options, and confirms actions.
10	<b>Back</b> button—Returns you to the previous menu or view.
11	Image Display.

## Camera front, side, and bottom

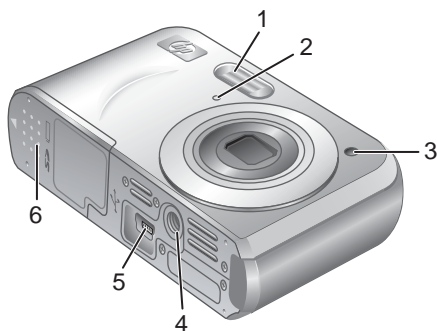

1	Flash.
2	Microphone.
3	Self-Timer light (see <a href="#">“Using the Self-Timer setting”</a> on page 16).
4	Tripod mount.
5	Dock/USB connector—Provides direct and indirect (via optional dock) USB connectivity.
6	Battery/Memory Card door.

## Before taking pictures

Complete the following procedures before taking pictures or recording video clips.

### Install the batteries

1. Open the Battery/Memory Card door by sliding the latch as indicated on the Battery/Memory Card door.
2. Insert the two AA batteries.
3. Close the Battery/Memory Card door.

 **NOTE:** If using rechargeable NiMH batteries, fully charge the batteries before using them the first time (see [“Recharging NiMH batteries”](#) on page 43). Turn off the camera before removing the batteries.



### Turn on the camera

To turn on the camera, press the ON/OFF button.

## Choose the language

Use ▲▼ ◀▶ to choose the language you want, then press  $\frac{\text{Menu}}{\text{OK}}$ .

To change the language later, use the  **Camera Setup Menu** (see [“Using the Camera Setup Menu”](#) on page 33).



## Set the region

Along with the language setting, the region setting determines the default date format.

Use ▲▼ to choose the region you want, then press  $\frac{\text{Menu}}{\text{OK}}$ .

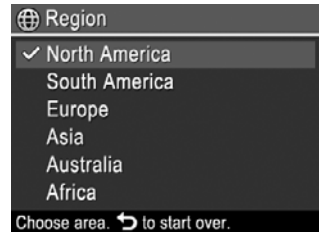

## Set the date and time

Accurately setting the date and time will help you locate images once you have transferred them to your computer, and will ensure that images are accurately marked if you use the date and time imprint feature. See **Date & Time Imprint** under [“Using the Picture Capture and Video Record menus”](#) on page 14.

1. Use ▲▼ to adjust the highlighted value.
2. Use ◀▶ to move to the other selections and repeat Step 1 until the date and time are set correctly.
3. Press  $\frac{\text{Menu}}{\text{OK}}$  when the date, time, and format settings are correct, then press  $\frac{\text{Menu}}{\text{OK}}$  again to confirm.

To change the date and time later, use the  **Camera Setup Menu** (see [“Using the Camera Setup Menu”](#) on page 33).





## Install and format an optional memory card



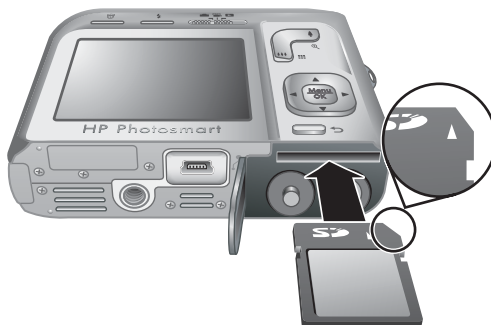









This camera supports standard, high speed, and high capacity Secure Digital (SD and SDHC) memory cards, 32MB to 8GB.

1. Turn off the camera and open the Battery/Memory Card door.
2. Insert the memory card in the smaller slot as shown. Make sure the memory card snaps into place.
3. Close the Battery/Memory Card door and turn on the camera.



 **NOTE:** When you turn on your camera with a memory card installed, the camera indicates the number of images you can store on the memory card at the current  **Image Quality** setting. This camera supports storing a maximum of 2000 images on a memory card.

Always format new memory cards before first use. Formatting removes all images from the memory card, so make sure to transfer existing images before formatting (see [“Transferring and printing images”](#) on page 25).

1. With the camera turned on, slide    to .
2. Press .
3. Use   to select **Format Card**, then press  .
4. Use   to select **Yes**, then press   to format the card.

 **NOTE:** Once you install a memory card, all new images and video clips are stored on the card, rather than in internal memory. To use internal memory and view images stored there, turn off the camera then remove the memory card. To transfer images from internal memory to an optional memory card, see **Move Images to Card** under [“Using the Playback Menu”](#) on page 20.

For information about supported memory cards, see [“Storage”](#) on page 44.

## Install the software

The HP Photosmart Software provides features for transferring images and video clips to your computer, as well as features for modifying stored images (remove red eyes, rotate, crop, resize, and more).

To install the HP Photosmart Software, your computer must meet the system requirements as stated on the camera packaging.

If you have trouble installing or using the HP Photosmart Software, see the Hewlett-Packard Technical Support website for more information: [www.hp.com/support](http://www.hp.com/support). Known issues are often fixed with new releases of firmware. To optimize your digital photography



experience, periodically check this website for updates to your camera's firmware, software, and drivers.

To learn about Windows Vista support for your camera, see [www.hp.com/go/windowsvista](http://www.hp.com/go/windowsvista) (English only).

**Windows:**

1. Close all programs and temporarily disable any virus protection software.
2. Insert the HP Photosmart Software CD into the CD drive and follow the on-screen instructions. If the installation screen does not appear, click **Start**, click **Run**, type **D:\Setup.exe**, where **D** is the letter of your CD drive, then click **OK**.
3. When the software has finished installing, re-enable virus protection software.

**Macintosh:**

1. Insert the HP Photosmart Software CD into the CD drive.
2. Double-click the CD icon on the computer desktop.
3. Double-click the installer icon, then follow the on-screen instructions.

Once installation is complete and you have restarted your computer, **System Preferences** automatically opens to the **HP Photosmart Camera** settings. You may change settings so the HP Photosmart Software starts automatically when you connect your camera to your Macintosh (click the help button on the **HP Photosmart Camera** settings dialog for more information).

## Using your camera

Now that you've completed setup, you can take and review pictures and video clips.





For information on taking pictures and recording video clips	See " <a href="#">Taking pictures</a> " on page 8 and " <a href="#">Recording video clips</a> " on page 9
For information on setting picture capture and video record settings	See " <a href="#">Setting options for taking pictures and recording video clips</a> " on page 13
For information on reviewing images and video clips on the camera	See " <a href="#">Reviewing images and video clips</a> " on page 18
For information on enhancing your images	See " <a href="#">Using the Design Gallery Menu</a> " on page 22
For information on transferring images from your camera to a computer	See " <a href="#">Transferring images with HP Photosmart Software</a> " on page 25
For information on printing images	See " <a href="#">Printing images directly to a printer</a> " on page 27

 **TIP:** To switch between  **Picture Capture**,  **Video Record**, and  **Playback**, slide    to the desired option.

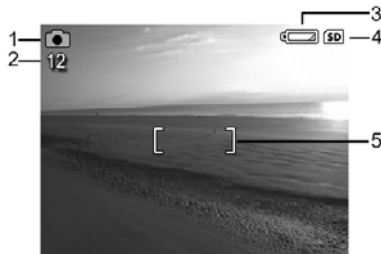
## 2 Taking pictures and recording video clips



You can take pictures when you are in  **Picture Capture** and you can record video when you are in  **Video Record**. Slide   to  to take pictures or to  to record video clips. The Image Display resembles the following:



1	 	<ul style="list-style-type: none"> <li>• Picture Capture indicator.</li> <li>• Video Record indicator.</li> </ul>
2	<b>12</b> <b>0:15</b>	<ul style="list-style-type: none"> <li>• When taking pictures, pictures remaining count.</li> <li>• When recording video clips, time remaining.</li> </ul>
3		Battery level indicator (see <a href="#">“Power indicators”</a> on page 42).
4		Memory card indicator.
5		Focus brackets (see <a href="#">“Auto focus and exposure”</a> on page 9).

### Taking pictures



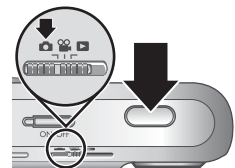

You can take a picture when the camera is set to  **Picture Capture**.

1. Slide   to .
2. Frame the subject for your picture in the Image Display.
3. Press the **Shutter** button halfway down to measure and lock the focus and exposure. The focus brackets in the Image Display turn solid green when focus is locked (see [“Auto focus and exposure”](#) on page 9).
4. Press the **Shutter** button all the way down to take the picture.



## Recording video clips

You can record a video clip when the camera is set to  **Video Record**.

1. Slide    to .
2. Frame the subject in the Image Display.
3. Press the **Shutter** button halfway down to measure focus and exposure. The focus brackets in the Image Display turn solid green when focus is locked (see [“Auto focus and exposure” on page 9](#)).
4. Press the **Shutter** button all the way down and release to begin recording video.
5. To stop recording video, press and release the **Shutter** button again.

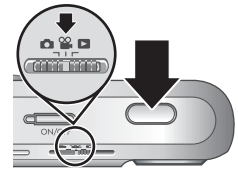

## Instant Review



After you have taken a picture or recorded a video clip, the camera displays it briefly in **Instant Review**. If you want to delete the image or video clip, press , select **This Image** from the  **Delete** menu, then press  **OK**.

 **NOTE:** To hear audio associated with video clips, transfer them to your computer (see [“Transferring and printing images” on page 25](#)).

## Auto focus and exposure

When you press the **Shutter** button halfway down, the camera automatically measures and locks the focus (for pictures and video clips) and exposure (for pictures only). When you auto focus:

Indicator	Description
Green focus brackets	Focus found.
Red focus brackets	Focus not found (see <a href="#">“Optimizing focus” on page 10</a> ).
 (shaking hand icon)	(Pictures only) Long exposure required (see <a href="#">“Optimizing exposure” on page 11</a> ).

 **TIP:** If you follow the suggestions for focus and exposure and your image does not appear to be in proper focus or exposure when viewed in  **Playback**, see the topics on blurry, dark, light, or grainy images in [“Troubleshooting” on page 34](#).

## Focusing on the subject

When you press the **Shutter** button halfway down, the camera searches for focus within the focus brackets. When it finds focus, the focus brackets turn green.

If the focus brackets do not frame your subject, use **Focus Lock** (see [“Using Focus Lock”](#) on page 11).







## Optimizing focus

When the camera cannot auto focus, the focus brackets turn red. This indicates the picture may be out of focus because the subject is out of the focus range or the scene has low contrast.

If you are recording a video or taking a picture with a shooting mode (see [“Using the Picture Capture and Video Record menus”](#) on page 14) other than  **Close-up** and the camera cannot focus, it will still take the picture. Try releasing the **Shutter** button, reframing, and then pressing the **Shutter** button halfway down again. If the focus brackets are still red, try the following.

**For pictures and video clips:** If the scene has low contrast, use **Focus Lock** (see [“Using Focus Lock”](#) on page 11) and aim at a point on the subject that has more colors or crisp edges.

### For pictures only:

- Select a shooting mode more appropriate for the scene you are capturing (see **Shooting Mode** under [“Using the Picture Capture and Video Record menus”](#) on page 14).
- If the subject is too close (less than 400 mm or 15.7 in), move farther away from the subject or use  **Close-up** (see **Close-up** under [“Using the Picture Capture and Video Record menus”](#) on page 14).
- If the camera is set to  **Close-up** and cannot focus, the camera will not take the picture. Try one of the following:
  - Move within the  **Close-up** range (150 mm-1m or 5.9-39.97 in) or set the camera to  **Auto** (see **Auto** under [“Using the Picture Capture and Video Record menus”](#) on page 14).
  - In low contrast scenes, use **Focus Lock** (see [“Using Focus Lock”](#) on page 11).

## Using Focus Lock

Use **Focus Lock** to focus on a subject that is not in the center of the picture, to capture action shots more quickly by pre-focusing in the area where the action will occur, or to focus in low light or low contrast situations.

1. Frame the subject for your picture within the focus brackets. In low light or low contrast situations, frame a brighter or higher contrast object.
2. Press the **Shutter** button halfway down.
3. Hold the **Shutter** button halfway down and re-frame.
4. Press the **Shutter** button all the way down to take the picture.



## Optimizing exposure

When you are taking a picture and press the **Shutter** button halfway down, the camera also measures the light level to set the proper exposure.

If the camera determines the scene will require a very long exposure, a shaking hand icon (👉) appears. The camera will take the picture, but it may be blurry because it is difficult to hold the camera still for the length of time required. Try one of the following:

- Set the flash to **Auto Flash** or **Flash On** (see [“Setting the flash”](#) on page 13).
- Set the camera on a tripod or stable surface.
- If the subject is out of the flash range or you do not have a tripod, set the shooting mode to **Steady Photo** (see **Steady Photo** under [“Using the Picture Capture and Video Record menus”](#) on page 14).
- Turn on more light.

---



 **NOTE:** When you are recording a video, the camera continuously updates exposure.

---

## Using zoom

Your camera has both optical and digital zoom. Optical zoom physically extends the lens to make the subject of your picture appear closer. After you have extended the lens fully using optical zoom, the camera employs digital zoom. Digital zoom uses no moving lens parts.





---

 **TIP:** The more you zoom in on the subject of your picture, the more small movements of the camera are magnified (this is called camera shake). If  appears when you press the **Shutter** button halfway down, the picture may be blurry. To reduce potential blur, see the suggestions in [“Optimizing exposure”](#) on page 11.

---

## Optical zoom

Optical zoom moves the lens between wide angle (1x) and telephoto (3x).

While in  **Picture Capture** or  **Video Record**, use the buttons on the **Zoom** lever to control zoom. Press  to zoom in and  to zoom out.

---

 **NOTE:** You can set the optical zoom to the position you want just before recording video clips. However, you cannot use optical zoom while the video clip is recording.

---







## Digital zoom



In digital zoom, the Image Display shows a yellow frame around the scene and the image quality setting (MP value). As you zoom in, the scene expands to show what the camera will capture, and the MP value decreases to indicate the resolution at which the scene will be captured.

When capturing images using digital zoom, make sure that the MP value on the Image Display is appropriate for the size at which you want to print the captured image. For MP values and their recommended print sizes, see **Image Quality** under [“Using the Picture Capture and Video Record menus”](#) on page 14.

To use digital zoom:

1. While in  **Picture Capture**, press  on the **Zoom** lever to optically zoom to the maximum level, then release the lever.
2. Press and hold  until the image you want to capture fills the yellow frame. If you zoom in too far, press .
3. To return to optical zoom, press .

---

 **NOTE:** Digital zoom is not available in  **Panorama** mode nor when recording video clips.





---

# 3 Setting options for taking pictures and recording video clips









Your camera's default settings work well for most shooting situations. For some situations, however, the features described in this chapter can improve the pictures you take and the video clips you record. In addition to setting features that optimize the camera for lighting and motion, you can also set the camera to take a series of pictures rapidly or take images 10 seconds after you press the **Shutter** button, giving you time to place yourself in the image.

## Setting the flash

To select a flash setting, press  while in  **Picture Capture**, use   to highlight the desired flash mode, then press  Menu OK. To exit without changing the flash setting, press .

	<b>Auto Flash</b> (Default)—The camera uses the flash if necessary.
	<b>Red-Eye</b> —The camera uses the flash with red-eye reduction, if necessary, to minimize the possibility of human eyes appearing red in the final image. For information about red-eye, see <a href="#">“Flash Setting—Red-Eye” on page 13</a> .
	<b>Flash On</b> —The camera always uses flash. If the light is behind your subject, use this setting to increase the light on the front of your subject.
	<b>Flash Off</b> —The camera does not use flash. Use this setting to capture poorly lit subjects beyond the flash range or to capture scenes with the existing light.



The flash setting remains in effect until it is changed again, or you turn off the camera.

















 **NOTE:** The flash is set to  **Flash Off** in  **Landscape**,  **Panorama**,  **Sunset**, and  **Theatre** shooting modes and while recording video clips. The flash is set to  **Red-Eye** in  **Night Portrait** shooting mode.



## Flash Setting—Red-Eye

The red-eye phenomenon is caused when light from the flash reflects off the subjects' eyes, which can make human eyes appear red in the captured image. Using  **Red-Eye** causes the camera to flash quickly up to three times to shrink the subject's pupils (reducing the effect of the red-eye phenomenon) before using the main flash and capturing the image. Since it takes longer to take a picture using this setting, make sure your subjects wait for the additional flashes.

















## Using the Picture Capture and Video Record menus

The  **Picture Capture** and  **Video Record** menus allow you to adjust camera settings that affect the characteristics of the pictures and video clips you capture. The  **Picture Capture Menu** displays only those features available for taking pictures while the  **Video Record Menu** displays only features available for recording video clips.

1. Slide    to  or , then press .
2. Use   to highlight an option, then press  to display the option's menu.
3. Use   to highlight a setting, then press  to change the setting or press  to exit without changing the setting.
4. To exit the menu, press  repeatedly until you return to  **Picture Capture** or  **Video Record**.

















For on-camera information about an option, use   to highlight **? Help...** in the option's menu, then press .

Unless otherwise noted, the setting remains in effect until you turn off the camera. The next time you turn on the camera, the settings reset to their defaults.

<div style="border: 1px solid black; border-radius: 10px; padding: 2px 5px; display: inline-block;">Mode</div>	<p><b>Shooting Mode</b> ( only)—For selecting a predefined setting optimized for particular types of scenes or shooting situations.</p> <ul style="list-style-type: none"> <li>•  <b>Auto Mode</b> (Default)—For taking good shots quickly, when you do not have time to select a special shooting mode.</li> <li>•  <b>Close-up</b>—For taking close-up pictures of subjects between 150 mm and 1 m (5.9 to 39.97 in) away.</li> <li>•  <b>Steady Photo</b>—For minimizing picture blur when the subject is moving or you cannot hold the camera still long enough in moderate to dim light conditions (see <a href="#">“Optimizing exposure”</a> on page 11).</li> <li>•  <b>Theatre</b>—For capturing images at school programs, concerts, or indoor sporting events without using flash.</li> <li>•  <b>Panorama</b>—For grand landscapes or group pictures where you need to capture a wide shot that one image cannot capture (see <a href="#">“Using Panorama mode”</a> on page 15).</li> <li>•  <b>Landscape</b>—For scenes with deep perspective, such as mountain scenes.</li> <li>•  <b>Portrait</b>—For pictures that have one or more people as their primary subject.</li> <li>•  <b>Action</b>—For capturing sporting events, moving cars, or any scene where you want to stop the action.</li> <li>•  <b>Night Portrait</b>—For capturing images of people at night. This mode uses the flash and a long exposure. As a result, you must set the camera on a tripod or stable surface.</li> <li>•  <b>Beach</b>—For capturing scenes at the beach.</li> <li>•  <b>Snow</b>—For capturing scenes in snow.</li> <li>•  <b>Sunset</b>—For capturing outdoor scenes at sunset.</li> </ul>
	<p><b>Self-Timer</b>—For capturing images or recording video after a 10-second delay (see <a href="#">“Using the Self-Timer setting”</a> on page 16).</p>
	<p><b>Adaptive Lighting</b> ( only)—Balances the relationship between light and dark areas. For more information, see <a href="#">“Adaptive Lighting”</a> on page 17.</p> <p><b>Off (Default), On</b></p>





(continued)







	<p><b>Image Quality</b> (📷 only)—Sets resolution and compression for images. The greater the number, the higher the resolution. The setting remains in effect until it is changed, even when you turn off the camera.</p> <ul style="list-style-type: none"><li>• <b>8MP Best</b>—For enlarging or printing images greater than 41 x 51 cm (16 x 20 in).</li><li>• <b>Normal (8MP)</b> (Default)—For printing images up to 41 x 51 cm (16 x 20 in).</li><li>• <b>5MP</b>—For printing images up to 28 x 36 cm (11 by 14 in).</li><li>• <b>2MP</b>—For printing images up to 13 x 18 cm (5 by 7 in).</li><li>• <b>VGA</b>—For sending images via e-mail or posting them to the Internet.</li></ul>
	<p><b>Burst</b> (📷 only)—For taking up to three shots quickly in succession (see <a href="#">“Using the Burst setting” on page 17</a>).</p>
	<p><b>Date &amp; Time Imprint</b> (📷 only)—Imprints date in lower left corner of image. The setting remains in effect until it is changed, even when you turn off the camera.</p> <ul style="list-style-type: none"><li>• <b>Off</b> (Default)—No date or time imprinted on the image.</li><li>•  <b>Date Only</b>—Date permanently imprinted.</li><li>•  <b>Date &amp; Time</b>—Date and time permanently imprinted.</li></ul>
	<p><b>White Balance</b>—Balances color based on lighting conditions. For more information, see <a href="#">“White Balance” on page 17</a>.</p> <ul style="list-style-type: none"><li>• <b>Auto</b> (Default)—Corrects for scene illuminance. For general picture taking.</li><li>•  <b>Sun</b>—For outdoor scenes in sunny or cloudy conditions.</li><li>•  <b>Shade</b>—For outdoor scenes in shade or at dusk.</li><li>•  <b>Tungsten</b>—For indoor scenes with incandescent or halogen lighting.</li><li>•  <b>Fluorescent</b>—For indoor scenes with fluorescent lighting.</li></ul>
	<p><b>AE Metering</b>—Specifies which region of a scene the camera uses to calculate the exposure.</p> <ul style="list-style-type: none"><li>• <b>Average</b> (Default)—Useful when you want the entire scene to be used when calculating exposure.</li><li>•  <b>Spot</b>—Useful in backlit scenes or when the subject is very dark or light compared to the rest of the scene. For best results, use <b>Focus Lock</b> (see <a href="#">“Using Focus Lock” on page 11</a>) with  <b>Spot</b>.</li></ul>
	<p><b>Camera Setup...</b>—Displays the  <b>Camera Setup Menu</b> for setting camera behavior (see <a href="#">“Using the Camera Setup Menu” on page 33</a>).</p>
	<p><b>Camera Help...</b>—Displays a list of help topics for commonly used features.</p>

 **NOTE:** Some menu options are not available in certain shooting modes.

## Using Panorama mode

The  **Panorama** mode allows you to take a sequence of 2 to 5 pictures that can be stitched together to capture a scene too wide to fit into a single picture. To preview your panoramic sequence, use  **Preview Panorama** on the camera (see [“Previewing panoramas” on page 21](#)). If you installed the HP Photosmart Software (see [“Install the](#)

[software](#)” on page 6), you can also stitch panoramas automatically as you transfer them to your computer.



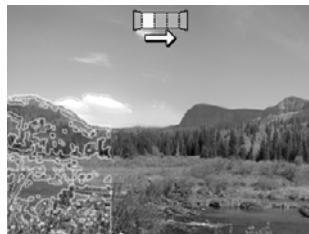

1. While in the  **Picture Capture Menu**, use  $\blacktriangle$  $\blacktriangledown$  to highlight  **Shooting Mode**, then press  $\frac{\text{Menu}}{\text{OK}}$ .
2. In the  **Shooting Mode** menu, use  $\blacktriangle$  $\blacktriangledown$  to highlight either  **Panorama** (left to right) or  **Panorama** (right to left), press  $\frac{\text{Menu}}{\text{OK}}$ , then press  $\curvearrowright$  repeatedly until you return to  **Picture Capture**.
3. Press the **Shutter** button to take the first picture in the panoramic sequence.
4. Position the camera to take the second picture. Use the transparent overlay of the first image superimposed on one third of the Image Display to align your second picture with the first.
5. Press the **Shutter** button to take the second picture.
6. Continue adding up to three more pictures to the panorama, or press  $\frac{\text{Menu}}{\text{OK}}$  to end the panoramic sequence.



During **Instant Review** (see [“Instant Review”](#) on page 9), each image in the panoramic sequence is displayed. To delete the panoramic sequence, press , select **Entire Panoramic Sequence**, then press  $\frac{\text{Menu}}{\text{OK}}$ .

## Using the Self-Timer setting

The  **Self-Timer** allows you to take an image or video clip 10 seconds after pressing the **Shutter** button.







1. While in the  **Picture Capture** or  **Video Record** menu, use  $\blacktriangle$  $\blacktriangledown$  to highlight  **Self-Timer**, press  $\frac{\text{Menu}}{\text{OK}}$ , highlight **On**, press  $\frac{\text{Menu}}{\text{OK}}$ , then press  $\curvearrowright$  repeatedly until you return to  **Picture Capture** or  **Video Record**.
2. Set the camera on a tripod or stable surface.
3. Frame the subject in the Image Display.
4. Press the **Shutter** button halfway down to lock focus and exposure. When the focus brackets turn green, press the **Shutter** button all the way down. The camera begins the 10-second countdown, then takes the picture or begins recording the video clip.
5. If you are recording a video clip, press the **Shutter** button to stop recording.

 **TIP:** If you want to include yourself in the picture, place the camera on a tripod or stable surface, then press the **Shutter** button all the way down. The camera locks focus and exposure just before the end of the countdown, allowing you time to place yourself in the scene.

The  **Self-Timer** setting resets to **Off** after the image is taken.

## Using the Burst setting

 **Burst** allows you to take two or more pictures as quickly as possible when you press and hold the **Shutter** button all the way down.



1. While in the  **Picture Capture Menu**, use  to highlight  **Burst**, press , highlight **On**, press , then press  repeatedly until you return to  **Picture Capture**.
2. Frame the subject, then press the **Shutter** button halfway down to lock the focus and exposure. Then press the **Shutter** button all the way down and hold it. The camera takes pictures as quickly as possible until you release the **Shutter** button or the camera runs out of memory.

During burst capture, the Image Display remains off and the flash is set to  **Flash Off**. After the burst images have been taken, each image appears one at a time in **Instant Review** (see “[Instant Review](#)” on page 9). You can delete the entire burst sequence in **Instant Review**. To delete individual images, see “[Deleting images](#)” on page 19.

The  **Burst** setting remains in effect until it is changed again, or until it resets to the default **Off** setting when you turn off the camera.

## Adaptive Lighting

This setting balances the relationship between bright and dark areas in a picture, preserving gentle contrasts while reducing harsh contrasts. When used with a flash,

 **Adaptive Lighting** can brighten areas that a flash wouldn't reach.  **Adaptive Lighting** is useful in situations like these:

- Outdoor scenes with a mixture of sun and shade
- High contrast scenes that contain both light and dark objects
- Indoor scenes that use flash photography (to soften or even out the effect of the flash)
- Backlit scenes where the subject is too far away for the flash to reach, or is severely backlit (for example, in front of a window)

## White Balance

Different lighting conditions cast different colors. This setting allows the camera to compensate for this, reproducing colors more accurately and ensuring that whites appear white in the final image. You can also adjust the white balance to produce creative effects. For example, the  **Sun** setting produces a warmer look to the image.

# 4 Reviewing images and video clips

You can review and manipulate images and video clips in **▶ Playback** as described here. For information about enhancing images, see [“Using the Design Gallery Menu” on page 22](#).

1. Slide to .
2. Use to scroll through your images and video clips.  
Press to view video clips; press to pause a clip. When paused, use to scroll through the individual frames; press to resume playing the video.



During **▶ Playback**, the Image Display also indicates additional information about each image or video clip.









1		Playback indicator.
2		Battery indicator (see <a href="#">“Power indicators” on page 42</a> ).
3		Memory card indicator.
4	<b>1 of 30</b>	Number of this image or video clip out of the total number of stored images and video clips.
5		Image position in a panoramic sequence.
6		Image tagged as <b>Favorite</b> (see <a href="#">“Tagging images as Favorites” on page 21</a> ).
7		Image marked for printing via an online printing service (see <a href="#">“Buying prints online” on page 30</a> ).
8	1	Number of electronic Photosmart Share destinations (see <a href="#">“Using HP Photosmart Express” on page 29</a> ).
9	3	Number of copies to print (see <a href="#">“Transferring and printing images” on page 25</a> ).

## Deleting images

To delete a displayed image during **▶ Playback**:







1. Press .
2. Use   to select an option, then press  $\frac{\text{Menu}}{\text{OK}}$ .
  - **This Image**—Deletes the image or video clip.
  - **All Except Favorites**—Deletes all images except those tagged as **Favorites**. This menu option only appears if you have images tagged as **Favorites** (see [“Tagging images as Favorites” on page 21](#)).
  - **All Images (in Memory/on Card)**—Deletes all stored images and video clips.
  - **Format (Memory/Card)**—Deletes all stored files, then formats the internal memory or memory card.

## Viewing thumbnails

1. While in **▶ Playback**, press  **Thumbnails** (same as  **Zoom Out** on the **Zoom** lever) to view thumbnails.
2. Use   and   to scroll through the thumbnails.
3. Press  $\frac{\text{Menu}}{\text{OK}}$  to exit  **Thumbnails** and view the highlighted image on the Image Display.











Once in  **Thumbnails** view, you can sort thumbnails by date:

1. Press . Each thumbnail in this view represents a group of images taken on the same date.
2. Use   and   to scroll through the thumbnails.
3. With a dated thumbnail highlighted, press  $\frac{\text{Menu}}{\text{OK}}$  to display thumbnails of images taken on that date.
4. Press  $\frac{\text{Menu}}{\text{OK}}$  to exit  **Thumbnails** and view the highlighted image on the Image Display.





## Magnifying images

This feature is for viewing purposes only; it does not permanently alter the image.

1. While in **▶ Playback**, press  (same as  **Zoom In** on the **Zoom** lever). The currently displayed image is magnified 2x.
2. Use   and   to pan around the magnified image.
3. Use  and  to change the magnification.
4. Press  $\frac{\text{Menu}}{\text{OK}}$  to return to **▶ Playback**.













## Using the Playback Menu

1. While in **▶ Playback**, press .
2. Use  to highlight an option.
3. Use  to select an image or video clip, press , and follow any on-camera instructions.

 **NOTE:** To hear audio associated with video clips, transfer them to your computer (see [“Transferring and printing images”](#) on page 25).

4. To exit the menu, press  repeatedly until you return to **▶ Playback**.

	<b>Remove Red Eyes</b> —Allows you to remove red eyes in images containing human subjects (see <a href="#">“Removing red eyes”</a> on page 20).
	<b>Design Gallery...</b> —Allows you to enhance images by editing, cropping, adding borders, and more (see <a href="#">“Using the Design Gallery Menu”</a> on page 22).
	<b>Photosmart Express...</b> —Allows you to mark images for printing, sharing, and ordering prints online (see <a href="#">“Using HP Photosmart Express”</a> on page 29).
	<b>Favorites</b> —Allows you to tag images as <b>Favorites</b> (see <a href="#">“Tagging images as Favorites”</a> on page 21).
	<b>View Slideshow</b> —Allows you to create and view slideshows of your pictures and videos (see <a href="#">“Viewing slideshows”</a> on page 21).
	<b>Preview Panorama</b> —Allows you to preview a panoramic sequence as a single image (see <a href="#">“Previewing panoramas”</a> on page 21).
	<b>Move Images to Card</b> —Moves images from internal memory to memory card. Available only if there are images in internal memory and a memory card is inserted. To move images, select this option and follow the on-screen prompts.
	<b>Camera Setup...</b> —Displays the  <b>Camera Setup Menu</b> for setting camera behavior (see <a href="#">“Using the Camera Setup Menu”</a> on page 33).
	<b>Camera Help...</b> —Displays a list of help topics for commonly used features.

### Removing red eyes

When you select  **Remove Red Eyes**, the camera processes the current picture to remove red eyes from the subjects.

 **Remove Red Eyes** is only available for pictures taken with a flash.

 **NOTE:** To prevent red eyes in images, see [“Flash Setting—Red-Eye”](#) on page 13.













The red-eye removal process takes a few seconds, after which the image displays with green boxes around corrected areas, along with the  **Remove Red Eyes** menu:

- **Save Changes** (Default)—Saves a copy of the original image with the changes and returns to the **▶ Playback Menu**.
- **View Changes**—Displays a magnified view of the image with green boxes around the corrected areas.

To exit the  **Remove Red Eyes** menu without saving changes, press .

## Tagging images as Favorites



Tagging an image as a **Favorite** allows you to quickly select the group of images tagged as **Favorites** for printing or viewing as a group.

1. While in  **Playback**, use  to scroll to an image, then press .
2. Use  to highlight  **Favorites**, press , then press  again to tag the displayed image. **This Image** is checked in the  **Favorites** menu. To untag the image as a **Favorite**, press  again.
3. For each additional image you want to tag as a **Favorite**, use  to display the image, then repeat Step 2.
4. To exit the menu, press  repeatedly until you return to  **Playback**.

If you have the HP Photosmart Software installed on your computer, tagged images retain the tag when transferred to your computer (see [“Transferring and printing images”](#) on page 25).

## Viewing slideshows







Select  **View Slideshow** to configure and run a slideshow of images and/or video clips on the camera Image Display.

From the  **View Slideshow** menu, use  to select a slideshow option.

- **Images**—Plays the specified images: **All** (default), **Favorites**, **Pictures Only**, **Videos Only**.
- **Interval**—Sets the amount of time each image is shown: **2 secs**, **5 secs** (Default), **10 secs**, **15 secs**, **60 secs**.
- **Loop**—Specifies how often the slideshow repeats: **Once** (Default), **2x**, **3x**, **Continuous**.

## Previewing panoramas

When an image from a panoramic sequence is displayed and you select  **Preview Panorama**, the camera displays a stitched view of the panoramic sequence.

1. Scroll to one of the images in a panoramic sequence, then press .
2. While in the  **Playback Menu**, use  to select  **Preview Panorama**, then press  to view a preview of the panorama. Use  to pan left and right on the preview of the stitched panorama.
3. Press  exit panorama preview.









---







 **NOTE:** If you are using the HP Photosmart Software, images in a panoramic sequence are automatically stitched when you transfer them to your computer (see [“Transferring and printing images”](#) on page 25).

---

# 5 Using the Design Gallery Menu

You can use the  **Design Gallery** features to enhance your captured images.

1. While in  **Playback**, use  to scroll to an image, then press .
2. Use  to highlight  **Design Gallery**, then press .
3. Use  to highlight an option, then press  and follow any on-camera instructions.











	<b>Apply Artistic Effects</b> —Allows you to apply an artistic effect to an image (see <a href="#">“Applying artistic effects”</a> on page 22).
	<b>Modify Color</b> —Allows you to apply a color effect to an image (see <a href="#">“Modifying colors”</a> on page 23).
	<b>Add Borders</b> —Allows you to add a border to an image (see <a href="#">“Adding borders”</a> on page 23).
	<b>Rotate</b> —Rotates images in 90-degree increments. Use  to rotate the image clockwise or counter-clockwise in 90-degree increments. Press  to save the image in the new orientation.
	<b>Crop</b> —Allows you to crop an image to the selected orientation (see <a href="#">“Cropping images”</a> on page 23).

Unless otherwise stated,  Design Gallery effects are applied to a copy of the image; the original image is retained.

## Applying artistic effects

 **TIP:** If you need to crop an image (see [“Cropping images”](#) on page 23), do so before applying artistic effects or adding borders. If you plan to apply artistic effects or modify colors, do so before adding a border.

 **Apply Artistic Effects** allows you to create a copy of a selected image and apply creative effects to the copy. To apply artistic effects:

1. While in the  **Design Gallery Menu**, use  to select  **Apply Artistic Effects**, then press .
2. Use  to select an option and preview the effect it has on the image.
  - **Posterize**—Creates a high-contrast, flat-toned effect.
  - **Soft Glow**—Adds a diffuse, bright ethereal glow.
  - **Slimming**—Compresses centered subjects for a slimmer look.
  - **Kaleidoscope**—Mirrors the image in four directions.
3. Press  to select the artistic effect and display the  **Apply Artistic Effects** menu. Follow the on-camera instructions to adjust the artistic effect.
4. Press  to save a copy of the image with the artistic effect and return to the  **Design Gallery Menu**. Press  to exit without saving and return to the  **Apply Artistic Effects** menu.







## Modifying colors

---

 **TIP:** If you plan to modify colors, do so before adding a border.

---

 **Modify Color** allows you to apply color schemes to the displayed image. To modify colors:

1. Use ▲▼ to select  **Modify Color**, then press  $\frac{\text{Menu}}{\text{OK}}$ .
2. Use ▲▼ to select a color scheme and preview the effect it has on the image.
  - **Black & White**—Converts color images to black and white.
  - **Sepia**—Converts image to a brownish tone to look old-fashioned.
  - **B&W Tints**—Applies color tones on a black and white version of an image.
3. Press  $\frac{\text{Menu}}{\text{OK}}$  to select the color scheme and display the  **Modify Color** menu. Follow the on-camera instructions to adjust the color.
4. Press  $\frac{\text{Menu}}{\text{OK}}$  to save a copy of the image with the specified color scheme and return to the  **Design Gallery Menu**. Press ↵ to exit without saving and return to the  **Modify Color** menu.





## Adding borders

---

 **TIP:** If you plan to modify colors or crop your image, do so before adding a border.

---

 **Add Borders** allows you to add one or more predefined borders to the displayed image. To add a border:

1. Use ▲▼ to select  **Add Borders**, then press  $\frac{\text{Menu}}{\text{OK}}$ .
2. Use ▲▼ to select a border type and preview the effect it has on the image.
  - **Soft Edge**—Applies a soft, vignetted frame to the image.
  - **Inset Border**—Image extends beyond the inset frame.
  - **Oval**—Adds an oval matte border with beveled edges.
  - **Circle**—Adds a circular matte border with beveled edges.
  - **Rectangle**—Adds a rectangular matte border with sharp corners.
  - **Rounded Rectangle**—Uses a rectangle with soft corners for the matte border.
  - **Square**—Adds a square matte border with beveled edges.
3. Press  $\frac{\text{Menu}}{\text{OK}}$  to select the border and display the  **Add Border** menu. Follow the on-camera instructions to adjust the border.
4. Press  $\frac{\text{Menu}}{\text{OK}}$  to save a copy of the image with the specified border and return to the  **Design Gallery Menu**. Press ↵ to exit without saving and return to the  **Add Borders** menu.

## Cropping images

 **Crop** allows you to crop the displayed image to the selected orientation, then use the **Zoom** lever and ▲▼ ◀▶ to ensure that the image content you want gets saved.



 **TIP:** Make sure you crop images as needed before adding borders.

---

1. Use ▲▼ to select  **Crop**, then press  $\frac{\text{Menu}}{\text{OK}}$ .
2. Use ▲▼ to select a crop orientation and preview the effect it has on the image.
  - **Landscape** (Default)—Horizontally crops the displayed image to a 3:2 aspect ratio (one third wider than tall).
  - **Portrait**—Vertically crops the displayed image to a 2:3 aspect ratio (one-third taller than wide).
  - **Help...**—Accesses the on-camera help topic for cropping images.

Follow the on-camera instructions to use the **Zoom** lever and adjust what appears in the cropped image.

When you print, the normal aspect ratios get cropped on the top and bottom (landscape) or on the sides (portrait). Cropping helps ensure that the content you want gets printed.

3. Press  $\frac{\text{Menu}}{\text{OK}}$  to save a copy of the cropped image and return to the  **Design Gallery Menu**. Press ↩ to exit without saving and return to the  **Crop** menu.

---

# 6 Transferring and printing images

Regularly transferring images to your computer and deleting them from the memory card will reduce the time it takes to turn on your camera, to review images, and to transfer images. You can transfer pictures and video clips with or without the HP Photosmart Software that came with your camera. However, the HP Photosmart Software has several features for transferring and managing your images and also guides you through the transfer process.

---

 **NOTE:** Transferring a large number of high-resolution images from a memory card to your computer may take up to two hours. Even if your Image Display turns off during the transfer process or it appears that nothing is happening on the computer, do not disconnect your camera from your computer until your computer indicates that image transfer is complete. When transferring a large number of images, be sure your camera batteries are fully charged or use an optional HP Photosmart dock or memory card reader.

---

## Transferring images with HP Photosmart Software

If you have installed the HP Photosmart Software (see [“Install the software”](#) on page 6), use this method to transfer images and video clips to your computer.

When you connect your camera to a computer with the HP Photosmart Software installed:

- If you have tagged images as **Favorites** (see [“Tagging images as Favorites”](#) on page 21), the tags are transferred with the images to your computer.
- If you have marked images for printing (see [“Marking images for printing”](#) on page 29) and the computer is connected to a printer, the marked images are automatically printed.
- If you have marked images for sharing (see [“Sharing images”](#) on page 31) and the computer is connected to the Internet, the selected images are automatically sent to their destinations.
- If you have marked images to buy as prints (see [“Buying prints online”](#) on page 30) and the computer is connected to the Internet, you can follow the instructions on the computer screen to buy prints of those images you selected.
- You can transfer the images on the camera to the computer by following the instructions on the computer screen. Panoramic sequences (see [“Using Panorama mode”](#) on page 15) are automatically stitched as you transfer them.

---

 **TIP:** You can also perform these tasks using an optional HP Photosmart dock (see the documentation that came with your dock).

---

To transfer images using the HP Photosmart Software:

1. If you have marked images for sharing, printing, or buying prints online (see [“Using HP Photosmart Express”](#) on page 29), verify that the computer is connected to a printer and/or the Internet.
2. Turn off the camera.

3. Connect the camera and computer using the USB cable that came with your camera.
4. Turn on the camera. When the Image Display indicates that the camera is connected to the computer, follow the instructions on the computer screen. For more information, see the Help feature in the HP Photosmart Software.

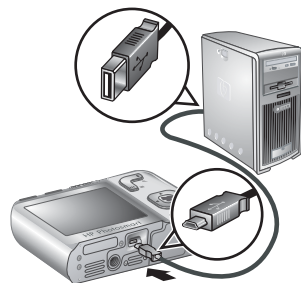

---



 **NOTE:** If the camera does not successfully connect to the computer, see [“My camera stalls when establishing a connection to the computer.”](#) on page 38.

---

After you have transferred the images, you can then use the HP Photosmart Software to edit, print, or send the images from your computer.

## Transferring images without HP Photosmart Software

If you do not install the HP Photosmart Software:

- You cannot use the  **Share** features or  **Buy Prints Online** on the camera's  **Photosmart Express Menu** (see [“Using HP Photosmart Express”](#) on page 29).
- Panoramic sequences are not automatically stitched when you transfer the images to your computer.
- Images marked for printing do not automatically print when the camera is connected to the computer.
- **Favorites** tags do not transfer to the computer.

However, you can still transfer images and video clips to your computer by:

- Connecting your camera directly to the computer (see [“Connecting to the computer”](#) on page 26)
- Using a memory card reader (see [“Using a memory card reader”](#) on page 27)

### Connecting to the computer

1. Turn off the camera, connect the camera and computer using the USB cable that came with your camera, then turn on the camera. Your computer's provided image transfer software should start. Follow the on-screen instructions to transfer your images.
2. When you have finished transferring images, disconnect the camera from the computer.

If you encounter problems, set the camera's  **USB Configuration** to **Disk Drive** (see **USB Configuration** under [“Using the Camera Setup Menu”](#) on page 33) and reconnect to your computer.

---

 **NOTE:** On Macintosh computers, if you set the camera to **Disk Drive** and neither Image Capture nor iPhoto starts automatically, look on the desktop for a disk drive icon labeled with your camera model number and copy the images manually. For more information about how to copy files, visit Mac help.

---

## Using a memory card reader

You can put your camera's optional memory card into a (separately purchased) memory card reader. Some computers and HP Photosmart printers have built-in memory card slots which act as a memory card reader.

1. Insert your camera's memory card into the memory card reader (or into your computer's memory card slot, if your computer has one).
2. Your computer's provided image transfer software starts automatically and guides you through the process of transferring images.
3. After verifying that the images were successfully transferred, return the memory card to your camera.

If no application starts automatically or if you want to copy the images manually, look for the disk drive for the memory card, then copy the images to your local hard drive. For more information about how to copy files, refer to your computer's help.

## Printing images directly to a printer

You can print images directly from the camera to any PictBridge-certified printer. For information about printing images from your computer, see ["Transferring images with HP Photosmart Software"](#) on page 25.



 **NOTE:** You cannot print video clips using the method described in this section. You can, however, print a frame from a video clip using the HP Photosmart Software. For more information, see Help in the HP Photosmart Software.

1. Check that the printer is turned on, there is paper in the printer, and there are no printer error messages.
2. Turn off the camera, connect the camera and printer using the USB cable that came with your camera, then turn on the camera.
3. If the **Print marked pictures?** screen is displayed on the camera's Image Display, do one of the following:
  - If you want to print the pictures you marked for printing (see ["Marking images for printing"](#) on page 29), highlight **Yes**, press , then follow the on-camera instructions to select print options and print the marked pictures.

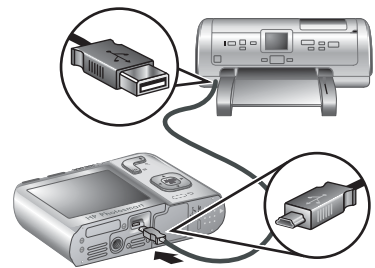

 **NOTE:** After the printer prints the marked images, the Image Display on the camera shows an image. You can then select individual images to print by following the remaining steps in this procedure.

- If you want to select individual images to print, highlight **No**, then press .

4. When the Image Display on the camera shows an image:
  - If you want to print one or more images, use ◀▶ to display an image you want to print, use ▲▼ to specify the number of copies, then press  $\frac{\text{Menu}}{\text{OK}}$ . In the **Print Options** menu, highlight **Print This Image Now**, and press  $\frac{\text{Menu}}{\text{OK}}$ .
  - If you want to print a group of images or modify the printer settings, press  $\frac{\text{Menu}}{\text{OK}}$ , highlight **Print Menu...**, then press  $\frac{\text{Menu}}{\text{OK}}$  again. Highlight the option you want.
    - **Printer Settings**—Specifies paper size, print size and quality, and borderless printing. Use ▲▼ to select a print option and use ◀▶ to modify the selected print option. When you are done specifying print options, press  $\frac{\text{Menu}}{\text{OK}}$ .
    - **Print All**—Prints one copy of each image. Press  $\frac{\text{Menu}}{\text{OK}}$  and follow the on-camera instructions to begin printing.
    - **Print Index**—Prints all images as thumbnails. Press  $\frac{\text{Menu}}{\text{OK}}$  to begin printing.
    - **Print Favorites**—Prints one copy of each image tagged as a **Favorite**. Press  $\frac{\text{Menu}}{\text{OK}}$  to begin printing. This option is available only if you have tagged at least one image as a **Favorite** (see [“Tagging images as Favorites” on page 21](#)).
    - **Cancel Printing**—Stops the printing of any images that have not yet printed. Press  $\frac{\text{Menu}}{\text{OK}}$ , highlight **Yes**, then press  $\frac{\text{Menu}}{\text{OK}}$ .
5. After the printer has printed all the images you selected, disconnect the camera from the printer.



**NOTE:** If you connect the camera to a non-HP printer and encounter problems with printing, contact your printer manufacturer. HP does not provide customer support for non-HP printers.

---

# 7 Using HP Photosmart Express

With **HP Photosmart Express**, you can select pictures in your camera to print automatically (see [“Marking images for printing”](#) on page 29), to buy prints online (see [“Buying prints online”](#) on page 30), or to send to custom destinations (see [“Sharing images”](#) on page 31) the next time you connect the camera to your computer or printer.

You must have the HP Photosmart Software installed on your computer to use some features in the  **Photosmart Express Menu**. For information about installing this software, see [“Install the software”](#) on page 6.

---

 **NOTE:** Available online services vary by country or region.



---

## Using the Photosmart Express Menu



To display the  **Photosmart Express Menu**:

1. Slide  to  and press .
2. Use  to highlight  **Photosmart Express...**, then press .
3. Use  to highlight a menu option, then press .

---

	<b>Print</b> —Allows you to select images and specify number of copies to print. See <a href="#">“Marking images for printing”</a> on page 29.
	<b>Share</b> —Allows you to add custom online destinations and share images to one or more destinations. See <a href="#">“Sharing images”</a> on page 31.
	<b>Buy Prints Online</b> —Specifies images you want printed by an online printing service. See <a href="#">“Buying prints online”</a> on page 30.

---







 **NOTE:** The features in the  **Photosmart Express Menu** are available only for pictures. They are not available for video clips.

---

## Marking images for printing

Marked images are automatically printed when you connect the camera to a PictBridge-certified printer or a computer with the HP Photosmart Software installed. You can mark

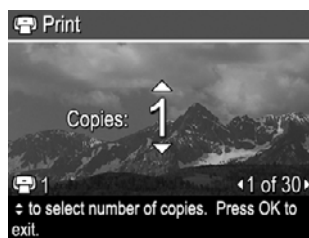

individual images, all images, or groups of images tagged as **Favorites** (see [“Tagging images as Favorites”](#) on page 21).

1. While in the  **Photosmart Express Menu**, use  $\blacktriangle\blacktriangledown$  to highlight  **Print**, then press  $\frac{\text{Menu}}{\text{OK}}$ .
2. In the  **Print** menu, highlight an option, then press  $\frac{\text{Menu}}{\text{OK}}$ .
  - **This Image**—Marks the image currently displayed. You can scroll to a different image using  $\blacktriangle\blacktriangledown$ .
  - **All Favorites...**—Displays the **Print All Favorites** entry. Press  $\frac{\text{Menu}}{\text{OK}}$ . This option is available only if you have tagged more than one image as a **Favorite** (see [“Tagging images as Favorites”](#) on page 21).
  - **All Images...**—Displays the **Print All Images** entry. Press  $\frac{\text{Menu}}{\text{OK}}$ . This option is available only if you have more than one image in the camera.
3. If you want to print more than one copy, highlight **Change Number of Copies**, then press  $\frac{\text{Menu}}{\text{OK}}$ . In the  **Print** menu for changing the number of copies, use  $\blacktriangle\blacktriangledown$  to specify the number of copies to print, then press  $\frac{\text{Menu}}{\text{OK}}$ .
4. From the main  **Print** menu, you can mark additional images for printing, using  $\blacktriangle\blacktriangledown$  to display an image, then repeating Steps 2 and 3.
5. When you are done marking images for printing, press  $\curvearrowright$  repeatedly until you return to  **Playback**.
6. To print the marked images directly to a printer, see [“Printing images directly to a printer”](#) on page 27. To print them from a computer connected to a printer, see [“Transferring images with HP Photosmart Software”](#) on page 25.



## Buying prints online

You can mark images you want to order as prints. The next time you connect the camera to a computer with the HP Photosmart Software installed, you can order prints of the marked images online.

1. While in the  **Photosmart Express Menu**, use  $\blacktriangle\blacktriangledown$  to highlight  **Buy Prints Online**, then press  $\frac{\text{Menu}}{\text{OK}}$ .
2. In the  **Buy Prints Online** menu, highlight an option, then press  $\frac{\text{Menu}}{\text{OK}}$ .
  - **This Image**—Marks the image currently displayed. You can scroll to a different image using  $\blacktriangle\blacktriangledown$ .
  - **All Favorites...**—Displays the **Buy Prints of All Favorites** entry. Press  $\frac{\text{Menu}}{\text{OK}}$ , then press  $\curvearrowright$ . This option is available only if you have tagged more than one image as a **Favorite** (see [“Tagging images as Favorites”](#) on page 21).
  - **All Images...**—Displays the **Buy Prints of All Images** entry. Press  $\frac{\text{Menu}}{\text{OK}}$ , then press  $\curvearrowright$ . This option is available only if you have more than one image in the camera.
3. To mark additional images, use  $\blacktriangle\blacktriangledown$  to display an image, then repeat Step 2.









4. When you are done marking images for which you want to buy prints, press **↶** repeatedly until you return to **▶ Playback**.
5. To buy prints of the images you selected, see [“Transferring images with HP Photosmart Software”](#) on page 25.

## Sharing images

You can customize the  **Share** menu to include e-mail addresses, group distribution lists, or other online services. You can then select images to send to these destinations.

### Setting up online destinations in the camera





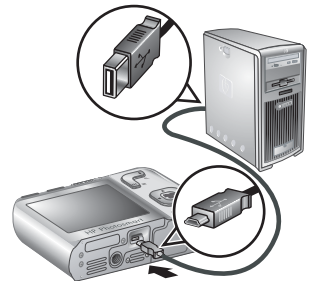

You can specify up to 34 custom destinations (such as individual e-mail addresses or group distribution lists) in the  **Photosmart Express Menu**.

1. Verify that your computer is connected to the Internet.
2. While in the  **Photosmart Express Menu**, use **▲▼** to highlight  **Share**, then press . If you have already created destinations, highlight **Share Menu Setup** and press  again.
3. Connect the camera to your computer. Follow the on-screen instructions to set up destinations in your camera.
4. Turn off the camera and disconnect the camera from the computer. Turn on the camera, access the  **Photosmart Express Menu**, then highlight  **Share** and press  to verify that the new destinations are now in the camera.



### Sending images to online destinations

After you have set up online destinations in the camera, you can mark images to be sent to these custom destinations the next time you connect your camera to your computer.





1. While in the  **Photosmart Express Menu**, use **▲▼** to highlight  **Share**, then press .
2. In the  **Share** menu, highlight an option, then press .
  - **Custom Destinations**—Selects the destination to send the image displayed in the background. There may be multiple destinations depending on the number of them you created (see [“Setting up online destinations in the camera”](#) on page 31). You can scroll to a different image using **◀▶**.
  - **All Favorites...**—Displays a list of destinations. Highlight each destination to which you want to send all **Favorites**, pressing  to select each destination. After selecting destinations, press **↶**. This option is available only if you have

















tagged more than one image as a **Favorite** (see [“Tagging images as Favorites”](#) on page 21).







- **All Images...**—Displays a list of destinations. Highlight each destination to which you want to send all images, pressing  $\frac{\text{Menu}}{\text{OK}}$  to select each destination. After selecting destinations, press  $\leftarrow$ . This option is available only if you have more than one image in the camera.
3. To select additional images to share, use  $\blacktriangleleft\blacktriangleright$  to display an image, then repeat Step 2.
  4. When you are done marking images to share, press  $\leftarrow$  repeatedly until you return to **▶ Playback**.
  5. To send the images to the destinations, see [“Transferring images with HP Photosmart Software”](#) on page 25.

# 8 Using the Camera Setup Menu

The  **Camera Setup Menu** allows you to set preferences for the camera's behavior. The  **Camera Setup Menu** is available from the  **Picture Capture**,  **Video Record**, and  **Playback** menus.

1. While in the  **Picture Capture**,  **Video Record**, or  **Playback** menu, use  to highlight  **Camera Setup...**, then press .
2. Use  to highlight a menu option, then press  to display the menu option's sub-menu.
3. Use  to highlight a setting, then press .
4. To exit the  **Camera Setup Menu**, press  repeatedly until you return to  **Picture Capture**,  **Video Record**, or  **Playback**.

Settings you specify remain until you change them.

	<b>Display Brightness</b> —Adjusts the brightness of the Image Display. <ul style="list-style-type: none"><li>• <b>Automatic</b> (Default)—For automatic adjustment of Image Display brightness based on lighting conditions.</li><li>• <b>Low</b>—For extending battery life.</li><li>• <b>Medium</b>—For normal viewing conditions.</li><li>• <b>High</b>—For very bright lighting conditions.</li></ul>
	<b>Camera Sounds</b> —Turns the camera sounds (such as button presses and shutter clicks) off and on. <b>On</b> (Default), <b>Off</b> .
	<b>Display Timeout</b> —Specifies the time after which the Image Display turns off if you do not press a button. <b>Never, 15, 30, 45</b> (Default), <b>60 seconds</b> .
	<b>Date &amp; Time</b> —Sets the date and time. See <a href="#">“Set the date and time”</a> on page 5.
	<b>USB Configuration</b> —Specifies how a computer recognizes the camera. See <a href="#">“Connecting to the computer”</a> on page 26. <ul style="list-style-type: none"><li>• <b>Digital Camera</b> (Default)—Recognizes the camera as a digital camera using PTP (Picture Transfer Protocol).</li><li>• <b>Disk Drive</b>—Recognizes the camera as a disk drive using MSDC (Mass Storage Device Class).</li></ul>
	 (Language)—Sets the language. See <a href="#">“Choose the language”</a> on page 5.

---

# 9 Troubleshooting

Use this section to find information on:

- Resetting the camera (see [“Resetting the camera”](#) on page 34)
- Possible problems and solutions (see [“Problems and solutions”](#) on page 34)

## Resetting the camera

If your camera does not respond when you press buttons, reset the camera.

1. Turn off the camera.
2. Remove the memory card and batteries for at least 5 seconds.
3. Reinsert the batteries and close the Battery/Memory Card door.
4. Turn on the camera. On successful reset, you may be prompted to set the date and time (see [“Set the date and time”](#) on page 5).
5. Verify that the camera works without an optional memory card, turn off the camera, then reinstall the card.

When the camera is reset, any images or video clips stored in memory are retained.

## Problems and solutions



Use this information to find solutions to common issues you may have using your camera.

---

 **NOTE:** Known issues are often fixed with new releases of firmware. To optimize your digital photography experience, periodically check the Hewlett-Packard Technical Support website ([www.hp.com/support](http://www.hp.com/support)) for updates to your camera's firmware, software, and drivers.

---

### How can I get professional-quality prints if I don't have a photo printer?

Use the  **Buy Prints Online** feature on the  **Photosmart Express Menu** (see [“Buying prints online”](#) on page 30).

### The camera does not turn on.

- Install new or recharged batteries, ensuring that the batteries are inserted correctly (see [“Install the batteries”](#) on page 4). If you are using rechargeable batteries, ensure they are rechargeable Nickel Metal Hydride (NiMH) batteries.
- Reset the camera (see [“Resetting the camera”](#) on page 34).
- Ensure that the memory card is the proper type (see [“Storage”](#) on page 44). If so, remove the memory card and turn on the camera; if the camera turns on, turn off the camera, install the memory card, turn on the camera, and format the memory card (see [“Install and format an optional memory card”](#) on page 6). If the camera does not turn on after you reinstalled the memory card, format the memory card using a memory card reader, or replace the memory card.

**I have to recharge the NiMH batteries frequently.**

- New batteries or batteries that have not been charged recently must be recharged to reach full capacity.
- If you have not used the batteries for two months or longer, recharge them.
- For tips on conserving battery life, see [“Extending battery life”](#) on page 41.

**The NiMH batteries will not charge.**

- Try charging the batteries again after they have drained awhile.
- If charging the batteries in an optional battery charger or by docking the camera in an optional HP Photosmart dock does not work, replace the batteries.

**It takes the camera a long time to turn on.**

- Your camera may be slower to turn on if you have a high capacity (4GB or larger) memory card inserted.
- Having a large number of files (over 300) stored on a memory card affects the time it takes for the camera to turn on. Transfer stored files to your computer, then format the memory card.
- Power-on time in  **Playback** is slow if you have a large number of tagged images on your memory card. Transfer the images to your computer (see [“Transferring and printing images”](#) on page 25) and review them there.

**The camera does not respond when I press a button.**

- Turn on the camera.
- Most of the camera buttons do not respond when the camera is connected to a computer (directly or through an optional dock).
- Replace or recharge the batteries.
- Reset the camera (see [“Resetting the camera”](#) on page 34).
- The memory card may be defective. Remove the memory card and test the camera; if the camera works, replace the memory card.
- Format the internal memory and/or the memory card (see [“Install and format an optional memory card”](#) on page 6).





**The camera does not take a picture when I press the Shutter button.**

- Press the **Shutter** button all the way down.
- The memory card or internal memory may be full. Transfer images from the camera to your computer, then format the internal memory or the memory card (see [“Install and format an optional memory card”](#) on page 6). Or replace the card with a new one.
- The camera may be processing. Wait a few seconds for the camera to finish processing the last image before taking another picture.

**The Image Display is not working.**

- The Image Display may have timed out. Press any camera button to wake up the camera.
- Reset the camera (see [“Resetting the camera”](#) on page 34).
- Replace or recharge the batteries.



**My image is blurry.**

- Use **Focus Lock** (see [“Using Focus Lock”](#) on page 11).
- Use a tripod to hold the camera steady, or improve lighting conditions.
- Use  **Steady Photo** shooting mode (see **Steady Photo** under [“Using the Picture Capture and Video Record menus”](#) on page 14).
- Set the flash to  **Auto Flash** or  **Flash On** and set the shooting mode to  **Action**.

**My image is too bright.**

- Turn the flash off (see [“Setting the flash”](#) on page 13).
- Move back from the subject and use zoom.

**My image is too dark.**

- Wait for natural lighting conditions to improve, use the flash (see [“Setting the flash”](#) on page 13), or add indirect lighting.
- If the subject you are trying to capture is outside the flash range, turn off the flash. This causes a longer exposure time, so use a tripod or hold the camera steady. For information about flash working distance for this camera, go to [www.hp.com/support](http://www.hp.com/support), select your language and region, enter your camera model number in the **Search: Product** field, click **Product Information**, then click **Specifications**.
- Use  **Adaptive Lighting** (see **Adaptive Lighting** under [“Using the Picture Capture and Video Record menus”](#) on page 14).
- Use the  **Spot** setting for  **AE Metering** (see **AE Metering** under [“Using the Picture Capture and Video Record menus”](#) on page 14).

**My image is grainy.**

- Add indirect lighting, use the flash (see [“Setting the flash”](#) on page 13), or wait for natural lighting conditions to improve.
- Using  **Steady Photo** shooting mode can increase graininess.
- You may have zoomed in too far using digital zoom (see [“Digital zoom”](#) on page 12).
- If the camera is warm, the effect will diminish as the camera cools. For best image quality, avoid storing the camera in very hot locations.

**Images are missing on my camera.**

Remove the memory card and see if the images are stored in internal memory. If so, transfer the images to the memory card (see **Move Images to Card** under [“Using the Playback Menu”](#) on page 20).

**I have two memory cards that are the same size, but one stores many more pictures than the other.**

- Your memory card may contain files that are not images or videos recognized by the camera. Save any data on the memory card that you want to keep, then format the memory card (see [“Install and format an optional memory card” on page 6](#)).
- If your memory cards are 4GB or larger, the card that stores fewer images may have been improperly formatted by a device that does not support 4GB or larger cards. A new type of High Capacity Secure Digital (marked SDHC) memory card is now available that prevents improper formatting and use by devices not supporting 4GB or larger cards. Try formatting the card in this camera, which supports SDHC cards.
- Your memory card may be defective. If you have formatted your memory card in the camera and it does not show the expected capacity, consider replacing the memory card.



**My camera indicates I can store 2000 images regardless of the Image Quality setting.**

When you turn on your camera with a memory card installed, the camera indicates the number of pictures and video images you can store on the memory card at the current  **Image Quality** setting. This camera supports storing a maximum of 2000 images on a memory card.

**It takes a long time to “Delete All” images from my memory card.**

Having a large number of images stored on a memory card increases the time the camera takes to delete them. Instead of deleting them, format the memory card (see [“Install and format an optional memory card” on page 6](#)).

**The Power light is on but the Image Display is off, or the camera seems stuck and won't operate.**

- Slide    to a different position or press any camera button to reactivate the Image Display.
- Reset the camera (see [“Resetting the camera” on page 34](#)).

**The camera responds sluggishly when trying to review images.**

- Power-on time in  **Playback** is slow if you have a large number of tagged images on your memory card. Transfer the images to your computer (see [“Transferring and printing images” on page 25](#)) and review them there.
- See [“Storage” on page 44](#) and [“Memory capacity” on page 45](#) for tips about memory cards.

**Video recording terminates abruptly. The video is saved successfully, but it is shorter than expected.**

Replace your memory card with a faster card. Look for cards marked High Performance, Pro, Ultra, or High Speed.

**Video recording terminates abruptly and the video will not play back.**

- Remove the memory card and see if the video is stored in internal memory. If so, transfer the video to a memory card (see **Move Images to Card** under [“Using the Playback Menu”](#) on page 20) or to your computer (see [“Transferring and printing images”](#) on page 25).
- If the video is stored on a memory card, transfer the video to your computer (see [“Transferring and printing images”](#) on page 25), then reformat the card (see [“Install and format an optional memory card”](#) on page 6).

**The camera gets warm (or even hot) to the touch.**

This is normal. However, if anything seems out of the ordinary, turn off the camera and allow the camera to cool. Then examine the camera and the batteries for signs of possible damage.

For best image quality, turn off the camera when not using. Always store the camera in a cool place.

**My camera stalls when establishing a connection to the computer.**

- Your memory card may have a large number of images stored on it. The more images you have on your card, the longer it takes to establish a connection to the computer (up to 5 minutes). If you have a large number of images on the memory card, be sure to allow this additional time to establish the connection.
- Ensure that the USB cable is properly connected to the camera and computer, either directly or via an optional dock.
- Try connecting the USB cable to another USB port on the computer.
- Turn the camera off, then on again. If that does not fix the problem, reset the camera (see [“Resetting the camera”](#) on page 34).
- If the problem persists, contact HP Support (see [“Product support”](#) on page 40).

**I cannot transfer images from the camera to my computer.**

- Either install the HP Photosmart Software (see [“Install the software”](#) on page 6), or see [“Transferring images without HP Photosmart Software”](#) on page 26.
- Set your camera to act as a **Disk Drive** (see **USB Configuration** in [“Using the Camera Setup Menu”](#) on page 33), then follow the steps in [“Connecting to the computer”](#) on page 26.

**I get an error message when transferring images to my computer.**

A power surge or electrostatic discharge may have affected the camera. Close the HP Photosmart Software, remove the camera from the optional dock or disconnect the camera from the USB cable and reset the camera (see [“Resetting the camera”](#) on page 34). Then, restart the image transfer process (see [“Transferring images with HP Photosmart Software”](#) on page 25).

**The HP Photosmart Software does not start automatically when I connect to my Macintosh.**

Configure your camera preferences so the HP Photosmart software starts automatically when you connect your camera to your Macintosh. Open the **HP Photosmart Camera** settings in **System Preferences** to make changes, or to view the camera software help.



**The HP Photosmart Software takes a long time before it is ready to transfer images from my camera.**

Having a large number of files stored on an optional memory card affects the amount of time it takes for the HP Photosmart Software to start transferring images. Transfer all images stored on the memory card, then format the card (see "[Install and format an optional memory card](#)" on page 6).

**My camera shuts down unexpectedly.**

- A power surge or electrostatic discharge may have affected the camera. Remove the battery and reset the camera (see "[Resetting the camera](#)" on page 34). Then reinstall the battery and turn on the camera.
- Recharge the battery.
- Replace the battery.

**I am having a problem installing or using the HP Photosmart Software.**

- Make sure your computer meets the minimum system requirements as stated on the camera packaging.
- Refer to the Hewlett-Packard Technical Support website: [www.hp.com/support](http://www.hp.com/support).

## Camera error messages

Should you receive one of the following error messages when using your camera, you can look up details about the message by visiting [www.hp.com](http://www.hp.com) and searching on the specific code.

- **Lens Error (general)**—M730-021
- **Lens Error (zoom cannot retract)**—M730-022
- **Lens Error (lens cannot extend)**—M730-033
- **Lens Error (zoom in failed)**—M730-041
- **Lens Error (zoom out failed)**—M730-081
- **Unsupported card**—M730-200
- **Unable to format card**—M730-202
- **Error saving image**—M730-100
- **Error saving video**—M730-102
- **Batteries Low** (followed by data on battery types and performance)—AA-400

---

# 10 Product support

Use this section to find support information for your digital camera, including links to helpful websites and an overview of the support process.

## Helpful websites

Camera tips, product registration, newsletter subscriptions, driver and software updates, purchase HP supplies and accessories	<a href="http://www.hp.com">www.hp.com</a> Under <b>Learn about:</b> , click <b>Digital Photography</b>
Customers with disabilities	<a href="http://www.hp.com/hpinfo/community/accessibility">www.hp.com/hpinfo/community/accessibility</a> (English only)
Hewlett-Packard Technical Support; firmware, software, and driver updates; support information	<a href="http://www.hp.com/support">www.hp.com/support</a>
Windows Vista support	<a href="http://www.hp.com/go/windowsvista">www.hp.com/go/windowsvista</a> (English only)

## Getting assistance

To get the best from your HP product, consult the following standard HP support offerings:

1. Consult the product documentation.
  - Review “[Troubleshooting](#)” on page 34 in this document.
  - Review the electronic Help section within the software.
  - Refer to the camera's Help screens.
2. Visit the Hewlett-Packard Technical Support website at [www.hp.com/support](http://www.hp.com/support), or contact the store where you purchased this camera. The Hewlett-Packard Technical Support website is available to all HP customers. The Hewlett-Packard Technical Support website is the fastest source of up-to-date product information and expert assistance, including:
  - Fast e-mail access to qualified online support specialists.
  - Firmware, software, and driver updates for your camera.
  - Valuable product and troubleshooting information for technical issues.
  - Proactive product updates, support alerts, and HP newsletters (available when you register your camera).
3. HP support by phone. Support options and fees vary by product, country/region, and language. For a list of support conditions and phone numbers, visit [www.hp.com/support](http://www.hp.com/support).
4. Post-warranty period. After the limited warranty period, help is available online at [www.hp.com/support](http://www.hp.com/support).
5. Extending or upgrading your warranty. If you would like to extend or upgrade your camera's warranty, please contact the store where you bought the camera or check the HP Care Pack offers at [www.hp.com/support](http://www.hp.com/support).
6. If you already purchased an HP Care Pack Service, please check the support conditions on your contract.

---

# A Managing batteries

Your camera uses two AA batteries, either Alkaline, Photo Lithium, or rechargeable Nickel Metal Hydride (NiMH). Photo Lithium and NiMH batteries provide longer battery life than Alkaline batteries.







## Top points about batteries

- The batteries shipped with your camera are AA Alkaline. These batteries have a short life and are intended to let you begin using your camera immediately. When the camera warns that the battery charge is low (see [“Power indicators” on page 42](#)), HP recommends replacing them with Photo Lithium or rechargeable NiMH batteries for longer battery life.
- Fully charge NiMH batteries before using them for the first time.
- The first several times you recharge NiMH batteries, they may not provide the number of shots per charge that you expect. Their performance will improve after the batteries have been charged, then discharged completely four or five times. You can use the camera normally to discharge the batteries during this conditioning period.
- Always insert the batteries in the camera correctly (see [“Install the batteries” on page 4](#)). If the batteries are inserted improperly, the compartment door may close but the camera will not operate.
- If you do not intend to use your camera for more than one month, remove the batteries from the camera.
- The performance of all batteries will decrease as the temperature drops. To improve battery performance, store the camera and batteries in a warm inside pocket when in a cold environment. To prevent short-circuiting the batteries, never carry small metal items such as keys or coins in the same pocket with your batteries.

## Extending battery life

To conserve battery power, the Image Display automatically dims and brightens based on lighting conditions and turns off after 45 seconds by default. Pressing any button wakes up the camera. After five minutes of inactivity, the camera turns off.

To further extend battery life:

- Set  **Display Brightness** to **Low** (see **Display Brightness** under [“Using the Camera Setup Menu” on page 33](#)).
- Change the  **Display Timeout** value to a shorter interval (see **Display Timeout** under [“Using the Camera Setup Menu” on page 33](#)).
- Set your camera to  **Auto Flash** (see **Auto Flash** under [“Setting the flash” on page 13](#)).
- Use optical zoom sparingly.
- Use video recording sparingly.
- Use Image Display sparingly.
- If you are turning on the camera only to view images, slide  to , then turn on the camera to start in  **Playback** without extending the lens.
- When transferring or printing images, place your camera in an optional HP Photosmart dock connected to AC power.

## Safety precautions for using batteries

- Always use two identical batteries of the same chemistry, brand, and age.
- Do not place batteries in fire or heat them. Always store charged batteries in a cool location.
- Do not connect the positive and negative terminals of the battery to each other with any metal object.
- Do not carry or store batteries with metal objects. Do not drop batteries into a change-filled pocket.

- Do not pierce batteries or subject them to strong impacts or shocks.
- Do not solder directly onto batteries.
- Do not allow batteries to get wet.
- Do not disassemble or modify batteries.
- Immediately discontinue use of a battery if, while using, charging, or storing the battery, the battery emits an unusual smell, feels excessively hot (note that it is normal for the battery to feel warm), changes color or shape, or appears abnormal in any other way.
- In the event batteries leak and the fluid gets into one's eye, do not rub the eye. Rinse well with water and immediately seek medical care. If left untreated, the battery fluid could cause damage to the eye.



---

**⚠ CAUTION:** Risk of explosion if battery is replaced by an incorrect type. Dispose of used batteries according to the instructions.

---

## Power indicators

When the batteries are low or the camera is in a dock connected to AC power, one of the following icons appears in the Image Display. If no battery icon appears in the Image Display, the batteries have sufficient power to function normally.

Icon	Description
	Battery level is low. Camera will soon power down.
 <b>Blinking</b>	Battery is depleted. Camera will power down.
	Camera is operating on AC power.

---

**📖 NOTE:** If the camera is without batteries for a prolonged period, the clock may be reset and you may be prompted to update it the next time you power on the camera.

---

## Battery performance

This graph shows the relative number of photos you can take using Photo Lithium, NiMH, and Alkaline batteries. Actual performance may vary based on usage, battery type, and battery manufacturer. Many additional factors affect the number of photos you can take (see "[Top points about batteries](#)" on page 41).

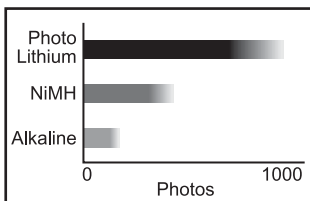

---

**📖 NOTE:** For more information about batteries, go to [www.hp.com/support](http://www.hp.com/support) and search on the code **AA-400**.

---

The following table shows how Alkaline, Photo Lithium, and rechargeable NiMH batteries perform in different types of use scenarios:

Type of Use	Alkaline	Photo Lithium	NiMH
Most economical if you take more than 30 pictures per month	Poor	Fair	Good
Most economical if you take fewer than 30 pictures per month	Fair	Good	Fair
Heavy use of flash, frequent pictures	Poor	Good	Good
Heavy use of video	Poor	Good	Good
Heavy use of Image Display	Poor	Good	Good
Overall battery life	Poor	Good	Fair
Low temperature/winter use	Poor	Good	Fair
Infrequent use (without dock)	Fair	Good	Fair
Infrequent use (with dock)	Fair	Good	Good
Want to recharge battery	No	No	Good

## Recharging NiMH batteries

You can recharge optional NiMH batteries with an optional HP quick recharger or with an optional HP Photosmart dock. For information about recharging NiMH batteries, as well as safety precautions when recharging, see the documentation that came with your HP quick recharger or HP Photosmart dock.

# B Specifications

<b>Resolution</b>	<p>Pictures:</p> <ul style="list-style-type: none"> <li>• 7.7MP (3200 by 2400) effective pixel count</li> <li>• 8MP (3264 by 2448) total pixel count</li> </ul> <p>Video clips (QVGA): 320 by 240 total pixel count, 24 frames/sec</p>
<b>Sensor</b>	Diagonal 7.26 mm (1/2.5-inch, 4:3 format) CCD
<b>Color depth</b>	36 bit (12 bits by 3 colors). 36 bit images are transformed into an optimized 24 bit image and stored in the JPEG format. This transformation results in no discernible change to color or detail in the stored image, and allows the image to be read by computers.
<b>Lens</b>	<p>Focal length:</p> <ul style="list-style-type: none"> <li>• Wide—6.2 mm</li> <li>• Telephoto—18.6 mm</li> <li>• 35 mm equivalent—37.5 mm to 112.5 mm</li> </ul> <p>F-Number:</p> <ul style="list-style-type: none"> <li>• Wide—f/2.8 to f/5.6</li> <li>• Telephoto—f/5.2 to f/10.4</li> </ul>
<b>Viewfinder</b>	None
<b>Zoom</b>	3x optical zoom, 8x digital zoom
<b>Focus</b>	<p>Normal:</p> <ul style="list-style-type: none"> <li>• Wide—400 mm (15.75 in) to infinity</li> <li>• Telephoto—400 mm (15.75 in) to infinity</li> </ul> <p>Close-up: Wide—150 mm to 1 m (5.9 in to 39.37 in)</p>
<b>Shutter speed</b>	1/1000 to 2 seconds
<b>Built-in flash</b>	Yes, 6-second typical recharge time (8-second maximum recharge time at power-on)
<b>Flash working range</b>	To locate the flash working range for this camera, go to <a href="http://www.hp.com/support">www.hp.com/support</a> , select your language and region, enter your camera model number in the <b>Search: Product</b> field, click <b>Product Information</b> , then click <b>Specifications</b> .
<b>Image Display</b>	6.35 cm (2.5 in) color LTPS TFT LCD with backlight, 153,600 pixels (640 by 240) total pixel count
<b>Storage</b>	<ul style="list-style-type: none"> <li>• 32MB internal flash memory.</li> <li>• Slot for memory card.</li> <li>• This camera supports standard, high speed, and high capacity Secure Digital (SD and SDHC) memory cards, 32MB to 8GB.</li> <li>• This camera supports storing a maximum of 2000 images on a memory card.</li> <li>• The number of images or video clips that can be saved in memory depends on the  <b>Image Quality</b> settings (see "<a href="#">Memory capacity</a>" on page 45).</li> </ul>

(continued)

<b>Compression format</b>	<ul style="list-style-type: none"><li>• JPEG (EXIF) for pictures</li><li>• Motion JPEG for video clips</li></ul>
<b>Interfaces</b>	USB mini-B
<b>Standards</b>	<ul style="list-style-type: none"><li>• USB—PTP and MSDC</li><li>• JPEG</li><li>• Motion JPEG</li><li>• DPOF</li><li>• EXIF</li><li>• DCF</li><li>• DPS</li></ul>
<b>External body dimensions</b>	Measurements with camera off and lens retracted (width, depth, height): 96 mm (W) by 24 mm (D) by 62 mm (H) (3.77 in by .94 in by 2.44 in)
<b>Weight</b>	225 grams (7.93 ounces) without battery
<b>Power</b>	Power source: two AA batteries (Alkaline, Photo Lithium, or rechargeable NiMH)
<b>Temperature range</b>	Operational: 0° to 40° C (32° to 104° F) at 15% to 85% relative humidity Storage: –30° to 65° C (–22° to 149° F) at 15% to 90% relative humidity

## Memory capacity

Not all 32MB of internal memory is available for storing images, because some memory is used for internal camera operations. The actual file sizes and number of still images that can be stored in internal memory or on a memory card will vary depending on the content of each still image, or length of each video clip and associated audio clip.

## Image quality

To locate the approximate number and average size of pictures that can be stored in internal memory when the camera is set to different  **Image Quality** settings (see **Image Quality** under “[Using the Picture Capture and Video Record menus](#)” on page 14), go to [www.hp.com/support](http://www.hp.com/support), select your language and region, enter your camera model number in the **Search: Product** field, click **Product Information**, then click **Specifications**.

---

# Index

- A**
  - Action mode 14
  - Adaptive Lighting 14, 17
  - adding borders 23
  - AE Metering 15
  - apply artistic effects 22
  - arrow buttons 3
  - artistic effects 22
  - assistance 40
  - Auto mode 14
- B**
  - Back button 3
  - batteries
    - conserving 41
    - install 4
    - performance 42
    - top points about use 41
  - battery door 4
  - Beach mode 14
  - borders 23
  - Burst setting 15, 17
- C**
  - camera
    - dimensions 45
    - parts 3, 4
    - specifications 44
    - turn on/off 4
    - weight 45
  - Camera Setup Menu 33
  - Camera Sounds 33
  - Close-up mode 14
  - color depth 44
  - colors 23
  - compression format 45
  - computer, connect to 25, 26
- D**
  - Date & Time 5, 33
  - Date & Time Imprint 15
  - Delete button 3
  - digital zoom 12
  - dimensions 45
  - direct print 27
- E**
  - e-mail images 31
  - exposure 11
- F**
  - F-number 44
  - Favorites 21
  - flash
    - red-eye reduction 13
    - setting 13
  - Flash button 3
  - focal length 44
  - focus
    - auto focus 9
    - brackets 9
    - focus lock 11
    - optimizing 10
  - format memory card 6
- G**
  - getting assistance 40
- H**
  - HP Photosmart Express 29
  - HP Photosmart Software 6
- I**
  - Image Display 3
  - Image Quality 15, 45
  - images
    - Date & Time Imprint 15
    - Image Quality 15
    - magnifying 19
    - number remaining 8
    - Panorama mode 15
    - sending 31
    - transfer to computer 25
  - install memory card 6
  - install software 6
  - Instant Review 9, 16, 17
  - interfaces 45
  - internal memory 8, 45
- Display Brightness 33**
- Display Timeout 33**
- L**
  - Landscape mode 14
  - Language 5, 33
- M**
  - Magnify control 3
  - magnifying images 19
  - memory
    - capacity 45
    - card 6, 8, 44
    - card door 4
  - Menu/OK button 3
  - menus
    - Camera Setup 33
    - Design Gallery 22
    - Photosmart Express 29
    - Picture Capture 14
    - Playback 20
    - Video Record 14
  - microphone 4
  - modifying colors 23
  - Move Images to Card 20
- N**
  - Night Portrait mode 14
  - number of
    - pictures remaining 8
    - still images 45
- O**
  - on/off 4
  - ON/OFF button 3
  - online
    - destinations 31
    - print buying 30
  - optical zoom 12
- P**
  - Panorama mode 14, 15, 21
  - parts of camera 3, 4
  - Photosmart Express Menu
    - buying prints online 30
    - marking images for printing 29
    - sharing images 31
  - Picture Capture Menu 14



## Index

- pictures 8, 16
- Playback 18
- Playback Menu 20
- Portrait mode 14
- power
  - indicators 42
  - light 3
  - ON/OFF button 3
- preview Panorama 21
- print images 27, 29
- prints, buy online 30
- problems and solutions 34

## R

- record video clips 9
- red-eye removal 20
- Region 5
- remaining pictures count 8
- removing red eyes 20
- reviewing images 18

## S

- safety precautions for
  - batteries 41
- selecting images for
  - destinations 31
- selecting images for printing 29
- Self-Timer
  - light 4
- Self-Timer setting 14, 16
- sending individual images 31
- set date and time 5
- setting up destinations 31
- share pictures 29
- Shutter button 3, 9
- shutter speed 44
- slideshow 21
- Snow mode 14
- software install 6
- solving problems 34
- sounds of camera 33
- space remaining in memory 8
- specifications 44
- State Selector 3
- Steady Photo mode 14
- storage 44
- Sunset mode 14
- support process 40

## T

- Theatre mode 14
- Thumbnails 19

- Thumbnails control 3
- Time & Date 5, 33
- transfer images 25, 26
- troubleshooting 34
- turn on/off power 4

## U

- USB configuration 26, 33

## V

- video clips 9
- Video Record Menu 14
- View Slideshow 21
- viewing thumbnails 19
- Vista support 40

## W

- weight 45
- White Balance 15, 17
- Windows Vista support 40

## Z

- zoom 11, 12, 44
- Zoom lever 3

## Regulatory / Geltende Richtlinien / Informations réglementaires

Geräuschemission  
LpA < 70 dB  
Am Arbeitsplatz  
Normaler Betrieb  
nach DIN 45635 T. 19

### FCC statement

The United States Federal Communications Commission (in 47 CFR 15.105) has specified that the following notice be brought to the attention of users of this product.

This equipment has been tested and found to comply with the limits for a Class B digital device, pursuant to Part 15 of the FCC Rules. These limits are designed to provide reasonable protection against harmful interference in a residential installation. This equipment generates, uses and can radiate radio frequency energy and, if not installed and used in accordance with the instructions, may cause harmful interference to radio communications. However, there is no guarantee that interference will not occur in a particular installation. If this equipment does cause harmful interference to radio or television reception, which can be determined by turning the equipment off and on, the user is encouraged to try to correct the interference by one or more of the following measures:

- Reorient or relocate the receiving antenna.
- Increase the separation between the equipment and receiver.
- Connect the equipment into an outlet on a circuit different from that to which the receiver is connected.
- Consult the dealer or an experienced radio/TV technician for help.

For further information, contact:

Manager of Corporate Product Regulations  
Hewlett-Packard Company  
3000 Hanover Street  
Palo Alto, Ca 94304  
(650) 857-1501

### HP Photosmart M730 series Digital Camera Declaration of Conformity (European Economic Area)

According to ISO/IEC 17050-1 and EN 17050-1

**Supplier's name:** Hewlett-Packard Company  
Digital Photography and Entertainment Division

declares that the product:

**Product name:** HP Photosmart M730 series Digital Camera (may contain suffixes)  
**Product number(s):** L2478A, L2479A, L2480A, L2481A, L2482A, L2483A  
**Regulatory model:** FCLSD-0701  
**Product options:** HP Photosmart 2200 Camera Charging Dock (product number Q6262A, Regulatory Model SDCAB-0703) .

Conforms to the following Product Specifications:

**Safety** IEC/EN 60950-1:2001  
IEC/EN 60825-1:1994+A1:2002+A2:2001 Class 1 LED

### Electromagnetic compatibility (EMC)

EN 55022:1998+A1:2000+A2:2003, Class B  
IEC/EN 61000-3-2:2000  
IEC/EN 61000-3-3:1995 + A1:2001  
EN 55024:1998+A1:2001+A2:2003

### Supplementary information:

The product herewith complies with the requirements of the Low Voltage Directive 73/23/EEC and the EMC Directive 89/336/EEC and carries the CE marking accordingly.

### Canada

This Class B digital apparatus complies with Canadian ICES-003.

Cet appareil numérique de la classe B est conforme à la norme NMB-003 du Canada.

## Free Manuals Download Website

<http://myh66.com>

<http://usermanuals.us>

<http://www.somanuals.com>

<http://www.4manuals.cc>

<http://www.manual-lib.com>

<http://www.404manual.com>

<http://www.luxmanual.com>

<http://aubethermostatmanual.com>

Golf course search by state

<http://golfingnear.com>

Email search by domain

<http://emailbydomain.com>

Auto manuals search

<http://auto.somanuals.com>

TV manuals search

<http://tv.somanuals.com>