

HP Photosmart
R830/R840 series
Digital Camera
User Guide



Legal and notice information

© Copyright 2007 Hewlett-Packard Development Company, L.P.

The information contained herein is subject to change without notice. The only warranties for HP products and services are set forth in the express warranty statements accompanying such products and services. Nothing herein should be construed as constituting an additional warranty. HP shall not be liable for technical or editorial errors or omissions contained herein.

Windows® is a U.S. registered trademark of Microsoft Corporation.



SD Logo is a trademark of its proprietor.

Contents

1 Getting started	
Camera top, side, and back	4
Camera front and bottom.....	5
Camera dock insert.....	5
Before taking pictures.....	5
Install the battery.....	6
Charge the battery.....	6
Turn on the camera.....	6
Choose the language.....	7
Set the region.....	7
Set the date and time.....	7
Install and format an optional memory card.....	8
Install the software.....	8
Using your camera.....	9
2 Taking pictures and recording video clips	
Taking pictures.....	10
Recording video clips.....	11
Instant Review.....	11
Auto focus and exposure.....	11
Focusing on the subject.....	11
Optimizing focus.....	12
Using Focus Lock.....	12
Optimizing exposure.....	13
Using zoom.....	13
Optical zoom.....	13
Digital zoom.....	13
3 Setting options for taking pictures and recording video clips	
Setting the flash.....	15
Red eye.....	15
Using the shooting modes.....	15
Using Panorama mode.....	16
Using the Picture Capture and Video Record menus.....	17
Using the Self-Timer settings.....	20
Using the Burst setting.....	20
Adaptive Lighting.....	21
Exposure Compensation.....	21
White Balance.....	21
ISO speed.....	21

4	Reviewing images and video clips	
	Using Playback.....	22
	Deleting images.....	23
	Viewing thumbnails.....	23
	Magnifying images.....	23
	Using the Playback Menu.....	24
	Tagging images	24
	Viewing slideshows.....	25
	Stitching panoramas.....	25
5	Using the Design Gallery Menu	
	Removing red eyes.....	27
	Applying artistic effects.....	27
	Enhancing photos.....	28
	Modifying colors.....	29
	Adding borders.....	29
	Cropping images.....	30
6	Transferring and printing images	
	Transferring images with HP Photosmart Software.....	31
	Transferring images without HP Photosmart Software.....	32
	Connecting to the computer.....	32
	Using a memory card reader.....	33
	Printing directly to a printer.....	33
7	Using HP Photosmart Express	
	Using the Photosmart Express Menu.....	35
	Marking images for printing.....	35
	Buying prints online.....	36
	Sharing images.....	36
	Setting up online destinations in the camera.....	37
	Sending images to online destinations.....	37
8	Using the Camera Setup Menu.....	38
9	Troubleshooting	
	Resetting the camera.....	39
	Problems and solutions.....	39
	Camera error messages.....	45
10	Product support	
	Helpful websites.....	46
	Getting assistance.....	46
A	Managing batteries	
	Top points about batteries.....	48
	Extending battery life.....	48
	Safety precautions for using batteries.....	48
	Power indicators.....	49
	Number of shots per battery charge.....	49
	Recharging the Lithium Ion battery.....	49
	Safety precautions for recharging batteries.....	50

Contents

B Specifications









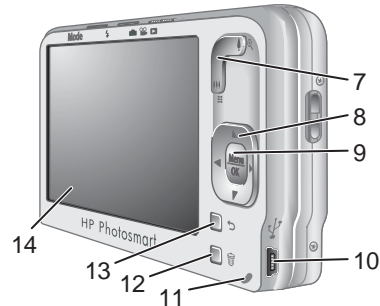
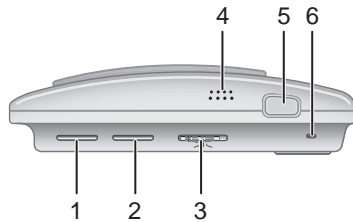









Memory capacity.....	53
Image quality.....	54
Video quality.....	54
Index	55

1 Getting started

Use this section to get familiar with the camera controls, set up your digital camera for use, and begin taking pictures.

Camera top, side, and back



1	Mode button —Accesses the  Shooting Mode menu while in  Picture Capture (see “Using the shooting modes” on page 15).
2	 Flash button —Accesses the flash settings while in  Picture Capture (see “Setting the flash” on page 15).
3	 selector—Switches between  Picture Capture ,  Video Record , and  Playback (see “Taking pictures” on page 10, “Recording video clips” on page 11, and “Reviewing images and video clips” on page 22).
4	Speaker.
5	Shutter button .
6	Power light.
7	Zoom lever —Accesses  Zoom (see “Using zoom” on page 13),  Thumbnails (see “Viewing thumbnails” on page 23), and  Magnify (see “Magnifying images” on page 23) functions.
8	 and  buttons—Scroll through menus and images.
9	 button—Displays camera menus, selects options, and confirms actions.
10	USB connector.
11	Battery Charging light.
12	 Delete button —Accesses the  Delete function while in  Playback (see “Deleting images” on page 23) or Instant Review (see “Instant Review” on page 11).
13	 Back button —Returns you to the previous menu or view.
14	Image Display.

Camera front and bottom

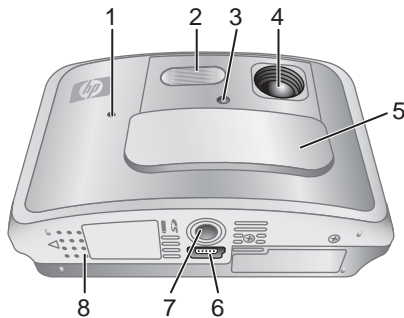

1	Microphone.
2	Flash.
3	Self-Timer/Focus Assist light—See “Using the Self-Timer settings” on page 20.
4	Lens.
5	Lens cover/Power switch—Turns the camera on and off and protects the lens while the camera is off.
6	Dock connector.
7	Tripod mount.
8	Battery/Memory Card door.

Camera dock insert

If you purchase an optional HP Photosmart dock, it will come with multiple plastic inserts. When setting up the dock for use with this camera, use the dock insert with the black triangle tag. For instructions, see the documentation that came with your dock.

Before taking pictures

Complete the following procedures before taking pictures or recording video clips.

Install the battery

1. Open the Battery/Memory Card door by sliding the door latch as indicated on the Battery/Memory Card door.
2. Insert the battery in the larger slot, pushing the battery in until the latch catches.
3. Close the Battery/Memory Card door.

To remove the battery, move the battery latch as shown until the battery springs free.

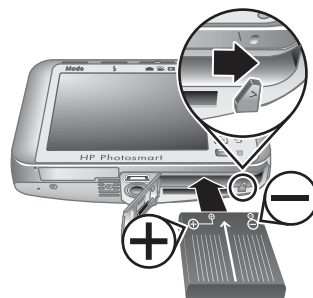

 **NOTE:** Fully charge the battery before using it the first time (see [“Charge the battery” on page 6](#)). Turn off the camera before removing the battery.

Charge the battery

To charge the battery in the camera:

1. Plug the small end of the USB cable into the camera and the large end into the power adapter, then plug the power adapter into an electrical outlet, as shown.

It may take up to one minute for the camera's Battery Charging light to start blinking, indicating that the battery is charging. The battery is fully charged when the Battery Charging light turns on solid (see [“Recharging the Lithium Ion battery” on page 49](#) for information on charging times).

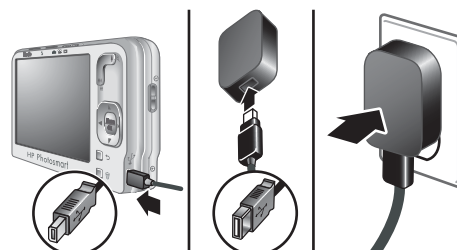

2. When charging is complete, disconnect the camera from the power adapter.

 **NOTE:** For other methods for recharging the battery, see [“Recharging the Lithium Ion battery” on page 49](#).

Turn on the camera

To turn on the camera, slide the lens cover open until it clicks, uncovering the lens.

To turn off the camera, slide the lens cover closed until it clicks, covering the lens.

 **CAUTION:** When sliding the lens cover, keep your fingers clear of the lens. Fingerprints on the lens can impair the quality of the picture.

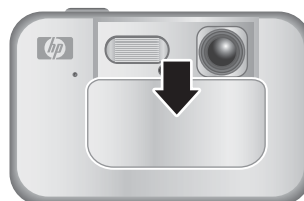

Choose the language

Use ▲▼ ◀▶ to choose the language you want, then press .

To change the language later, use the  **Camera Setup Menu** (see [“Using the Camera Setup Menu”](#) on page 38).



Set the region



Along with the language setting, the region setting determines the default date format and the format of the video signal for displaying camera images on a television when connected through an optional HP Photosmart dock (see [“Using the Camera Setup Menu”](#) on page 38).

Use ▲▼ to choose the region you want, then press .



Set the date and time

Accurately setting the date and time will help you locate images once you have transferred them to your computer, and will ensure that images are accurately marked if you use the date and time imprint feature. See **Date & Time Imprint** under [“Using the Picture Capture and Video Record menus”](#) on page 17.

1. Use ▲▼ to adjust the highlighted value.
2. Use ◀▶ to move to the other selections and repeat Step 1 until the date and time are set correctly.
3. Press  when the date, time, and format settings are correct, then press  again to confirm.

To change the date and time later, use the  **Camera Setup Menu** (see [“Using the Camera Setup Menu”](#) on page 38).





Install and format an optional memory card









This camera supports standard, high speed, and high capacity Secure Digital (SD and SDHC) memory cards, 32MB to 8GB.

1. Turn off the camera and open the Battery/Memory Card door.
2. Insert the optional memory card in the smaller slot as shown. Make sure the memory card snaps into place.
3. Close the Battery/Memory Card door and turn on the camera.



 **NOTE:** When you turn on your camera with a memory card installed, the camera indicates the number of images you can store on the memory card at the current  **Image Quality** setting. This camera supports storing a maximum of 1999 images on a memory card.

Always format new memory cards before first use. Formatting removes all images from the memory card, so make sure to transfer existing images before formatting (see [“Transferring and printing images” on page 31](#)).

1. With the camera turned on, slide    to .
2. Press .
3. Use  to select **Format Card**, then press .
4. Use  to select **Yes**, then press  to format the card.

 **NOTE:** Once you install a memory card, all new images and video clips are stored on the card, rather than in internal memory. To use internal memory and view images stored there, remove the memory card. To transfer images from internal memory to an optional memory card, see **Move Images to Card** under [“Using the Playback Menu” on page 24](#).

For information about supported memory cards, see **Storage** under [“Specifications” on page 52](#).

Install the software

The HP Photosmart Software provides features for transferring images and video clips to your computer, as well as features for modifying stored images (remove red eyes, rotate, crop, resize, and more).

To install the HP Photosmart Software, your computer must meet the system requirements as stated on the camera packaging.

If you have trouble installing or using the HP Photosmart Software, see the Hewlett-Packard Technical Support website for more information: www.hp.com/support. Known issues are often fixed with new releases of firmware. To optimize your digital photography

experience, periodically check this website for updates to your camera's firmware, software, and drivers.

To learn about Windows Vista support for your camera, see www.hp.com/go/windowsvista (English only).

Windows:

1. Close all programs and temporarily disable any virus protection software.
2. Insert the HP Photosmart Software CD into the CD drive and follow the on-screen instructions. If the installation screen does not appear, click **Start**, click **Run**, type **D:\Setup.exe**, where **D** is the letter of your CD drive, then click **OK**.
3. When the software has finished installing, re-enable virus protection software.

Macintosh:

1. Insert the HP Photosmart Software CD into the CD drive.
2. Double-click the CD icon on the computer desktop.
3. Double-click the installer icon, then follow the on-screen instructions.

Once installation is complete and you have restarted your computer, **System Preferences** automatically opens to the **HP Photosmart Camera** settings. You may change settings so the HP Photosmart Software starts automatically when you connect your camera to your Macintosh (click the help button on the **HP Photosmart Camera** settings dialog for more information).

Using your camera

Now that you've completed setup, you can take and review pictures and video clips.





For information on taking pictures and capturing video clips	See " Taking pictures " on page 10 and " Recording video clips " on page 11.
For information on setting picture capture and video record options	See " Setting options for taking pictures and recording video clips " on page 15.
For information on reviewing images and video clips on the camera	See " Reviewing images and video clips " on page 22.
For information on enhancing your images	See " Using the Design Gallery Menu " on page 27.
For information on transferring images from your camera to a computer	See " Transferring images with HP Photosmart Software " on page 31.
For information on printing images	See " Printing directly to a printer " on page 33.

 **TIP:** To switch between  **Picture Capture**,  **Video Record**, and  **Playback**, slide    to the desired option.

2 Taking pictures and recording video clips



You can take pictures when you are in  **Picture Capture** and you can record video when you are in  **Video Record**. Slide   to  to take pictures or to  to record video clips. The Image Display resembles the following:



1	 	<ul style="list-style-type: none"> • Picture Capture indicator. • Video Record indicator.
2	12 0:15	<ul style="list-style-type: none"> • When taking pictures, pictures remaining count. • When recording video clips, time remaining.
3		Memory card indicator.
4		Battery level indicator (see “Power indicators” on page 49).
5		Focus brackets (see “Auto focus and exposure” on page 11).

Taking pictures



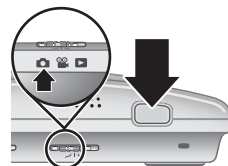

You can take a picture when the camera is set to  **Picture Capture**.

1. Slide   to .
2. Frame the subject for your picture in the Image Display.
3. Press the **Shutter** button halfway down to measure and lock the focus and exposure. The focus brackets in the Image Display turn solid green when focus is locked (see [“Auto focus and exposure”](#) on page 11).
4. Press the **Shutter** button all the way down to take the picture.



Recording video clips

You can record a video clip when the camera is set to  **Video Record**.

1. Slide    to .
2. Frame the subject in the Image Display.
3. Press the **Shutter** button halfway down to measure focus and exposure. The focus brackets in the Image Display turn solid green when focus is locked (see [“Auto focus and exposure”](#) on page 11).
4. Press the **Shutter** button all the way down and release to begin recording video.
5. To stop recording video, press and release the **Shutter** button again.

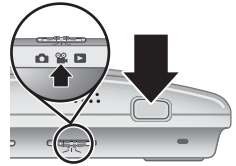



Instant Review

After you have taken a picture or recorded a video clip, the camera displays it briefly in **Instant Review**. If you want to delete the image or video clip, press , select **This Image** from the  **Delete** menu, then press  **OK**.

Auto focus and exposure

When you press the **Shutter** button halfway down, the camera automatically measures and locks the focus (for pictures and video clips) and exposure (for pictures only). When you auto focus:

Indicator	Description
Green focus brackets	Focus found.
Red focus brackets	Focus not found (see “Optimizing focus” on page 12).
 (shaking hand icon)	(Pictures only) Long exposure required (see “Optimizing exposure” on page 13).

 **TIP:** If you follow the suggestions for focus and exposure and your image does not appear to be in proper focus or exposure when viewed in  **Playback**, see the topics on blurry, dark, light, or grainy images in [“Troubleshooting”](#) on page 39.

Focusing on the subject

When you press the **Shutter** button halfway down, the camera searches for focus within the focus brackets. When it finds focus, the focus brackets turn green.

If the focus brackets do not frame your subject, use **Focus Lock** (see [“Using Focus Lock”](#) on page 12).



Optimizing focus

When the camera cannot auto focus, the focus brackets turn red. This indicates the picture may be out of focus because the subject is out of the focus range or the scene has low contrast.



If you are recording a video or taking a picture with a shooting mode (see [“Using the shooting modes” on page 15](#)) other than  **Close-up** and cannot focus, it will still take the picture. Try releasing the **Shutter** button, reframing, and then pressing the **Shutter** button halfway down again. If the focus brackets are still red:

For pictures and video clips: If the scene has low contrast, use **Focus Lock** (see [“Using Focus Lock” on page 12](#)) and aim at a point on the subject that has more colors or crisp edges.

For pictures only:

- Select a shooting mode more appropriate for the scene you are capturing (see [“Using the shooting modes” on page 15](#)).
- If the subject is too close (less than 500 mm or 19.7 in), move farther away from the subject or use  **Close-up** (see **Close-up** under [“Using the shooting modes” on page 15](#)).

If the camera is set to  **Close-up** and cannot focus, the camera will not take the picture. Try one of the following:

- Move within the  **Close-up** range (100 mm to 1 m or 3.94 to 39.4 in) or set the camera to  **Auto** (see **Auto** under [“Using the shooting modes” on page 15](#)).
- In low contrast scenes, use **Focus Lock** (see [“Using Focus Lock” on page 12](#)).

Using Focus Lock

Use **Focus Lock** to focus on a subject that is not in the center of the picture, to capture action shots more quickly by pre-focusing in the area where the action will occur, or to focus in low light or low contrast situations.

1. Frame the subject for your picture within the focus brackets. In low light or low contrast situations, frame a brighter or higher contrast object.
2. Press the **Shutter** button halfway down.
3. Hold the **Shutter** button halfway down and re-frame.
4. Press the **Shutter** button all the way down to take the picture.



Optimizing exposure

When you are taking a picture and press the **Shutter** button halfway down, the camera also measures the light level to set the proper exposure.

If the camera determines the scene will require a very long exposure, a shaking hand icon (👉) appears. The camera will take the picture, but it may be blurry because it is difficult to hold the camera still for the length of time required. Try one of the following:

- Set the flash to **Auto Flash** or **Flash On** (see [“Setting the flash”](#) on page 15).
- Set the camera on a tripod or stable surface.
- If the subject is out of the flash range or you do not have a tripod, turn on (📷) **Steady Photo**. (For R840 series, see [“Using the Picture Capture and Video Record menus”](#) on page 17. For R830 series, see [“Using the shooting modes”](#) on page 15.)
- Turn on more light.

 **NOTE:** When you are recording a video, the camera continuously updates exposure.





Using zoom

Your camera has both optical and digital zoom. Optical zoom physically adjusts the lens to make the subject of your picture appear closer. After you have zoomed the lens fully using optical zoom, the camera employs digital zoom. Digital zoom uses no moving lens parts.

 **TIP:** The more you zoom in on the subject of your picture, the more small movements of the camera are magnified (this is called camera shake). If (👉) appears when you press the **Shutter** button halfway down, the picture may be blurry. To reduce potential blur, see the suggestions under [“Optimizing exposure”](#) on page 13.

Optical zoom

Optical zoom moves the lens between wide angle (1x) and telephoto (3x).

While in  **Picture Capture** or  **Video Record**, use the buttons on the **Zoom** lever to control zoom. Press  to zoom in and  to zoom out.







Digital zoom



In digital zoom, the Image Display shows a yellow frame around the scene and the image quality setting (MP value). As you zoom in, the scene enlarges within the yellow frame to indicate the area of the scene the camera will capture, and the MP value decreases to indicate the resolution at which the scene will be captured.

When capturing images using digital zoom, make sure that the MP value shown in the Image Display is appropriate for the size at which you want to print the captured image.

For MP values and their recommended print sizes, see **Image Quality** under "[Using the Picture Capture and Video Record menus](#)" on page 17.

To use digital zoom:

1. While in  **Picture Capture**, press  on the **Zoom** lever to optically zoom to the maximum level, then release the lever.
2. Press and hold  until the image you want to capture fills the yellow frame. If you zoom in too far, press .
3. To return to optical zoom, press .



 **NOTE:** Digital zoom is not available in  **Panorama** mode nor when recording video clips.

3 Setting options for taking pictures and recording video clips









Your camera's default settings work well for most shooting situations. For some situations, however, the features described in this chapter can improve the pictures you take and the video clips you record. In addition to setting features that optimize the camera for lighting and motion, you can also set the camera to create a panorama, to take a series of pictures rapidly or take images 10 seconds after you press the **Shutter** button, giving you time to place yourself in the image.

Setting the flash

To select a flash setting, press  while in  **Picture Capture**, use   to highlight the desired flash mode, then press . To exit without changing the flash setting, press .

	Auto Flash (Default)—The camera uses the flash, if necessary. The flash may cause a phenomenon called red-eye (see “Red eye” on page 15).
	Flash On —The camera always uses flash. If the light is behind your subject, use this setting to increase the light on the front of your subject. The flash may cause a phenomenon called red-eye (see “Red eye” on page 15).
	Flash Off —The camera does not use flash. Use this setting to capture poorly lit subjects beyond the flash range or to capture scenes with the existing light.

The flash setting remains in effect until it is changed again, or you turn off the camera.





 **NOTE:** The flash is set to  **Flash Off** in  **Landscape**,  **Panorama**,  **Sunset**, and  **Theatre** shooting modes, with the  **Burst** setting, and while recording video clips. The flash is set to  **Flash On** in  **Night Portrait** shooting mode.















Red eye

The red-eye phenomenon is caused when light from the flash reflects off the subjects' eyes, which can make human eyes appear red and animal's eyes appear to glow in the captured image. You can remove the red eyes in human subjects after you have captured the image, using either  **Remove Red Eyes** (see **Remove Red Eyes** under [“Using the Design Gallery Menu”](#) on page 27) or the HP Photosmart Software that came with your camera. You can remove the glowing eyes in animal subjects after you have captured the image using **Pet-Eye Fix** (see [“Enhancing photos”](#) on page 28).

Using the shooting modes

Shooting modes are predefined settings for everyday situations. They are optimized for particular types of scenes or shooting situations.



To select a shooting mode, press **Mode** while in  **Picture Capture**, use   to highlight a shooting mode, then press  **OK**. To exit without changing the shooting mode, press .

	Auto Mode (Default)—For taking good shots quickly, when you do not have time to select a special shooting mode.
	Close-up —Use when taking close-up pictures of subjects between 100 mm and 1 m (3.94 to 39.4 in) away.
	Steady Photo (R830 series only) —For minimizing picture blur when the subject is moving or you cannot hold the camera still long enough in moderate to dim light conditions (see “Optimizing exposure” on page 13). To use  Steady Photo with R840 series cameras, see Steady Photo under “Using the Picture Capture and Video Record menus” on page 17.
	Theatre —For capturing images at school programs, concerts, or indoor sporting events without using flash.
 or 	Panorama —For grand landscapes or group pictures where you need to capture a wide shot that one image cannot capture (see “Using Panorama mode” on page 16).
	Landscape —For scenes with deep perspective, such as mountain scenes.
	Portrait —For pictures that have one or more people as their primary subject.
	Action —For capturing sporting events, moving cars, or any scene where you want to stop the action.
	Night Portrait —For capturing images of people at night. This mode uses the flash and a long exposure. As a result, you must set the camera on a tripod or stable surface.
	Beach —For capturing scenes at the beach.
	Snow —For capturing scenes in snow.
	Sunset —For capturing outdoor scenes at sunset.

 **NOTE:** The shooting modes do not apply when you are recording video clips.

The shooting mode remains in effect until it is changed again, or until you turn off the camera.

Using Panorama mode

The  **Panorama** mode allows you to take a sequence of 2 to 5 pictures that can be stitched together to capture a scene too wide to fit into a single picture. To stitch your panoramic sequence together, use  **Stitch Panorama** on the camera (see [“Stitching panoramas”](#) on page 25). If you installed the HP Photosmart Software (see [“Install the](#)

[software](#)” on page 8), you can also stitch panoramas automatically as you transfer them to your computer.

1. While in **Picture Capture**, press **Mode**, use **◀▶** to select either **▶▶ Panorama** (left to right) or **◀◀ Panorama** (right to left), then press $\frac{\text{Menu}}{\text{OK}}$.
2. Press the **Shutter** button to take the first picture in the panoramic sequence.
3. Position the camera to take the second picture.
Use the transparent overlay of the first image superimposed on one third of the Image Display to align your second picture with the first.
4. Press the **Shutter** button to take the second picture.
5. Continue adding up to three more pictures to the panorama, or press $\frac{\text{Menu}}{\text{OK}}$ to end the panoramic sequence.

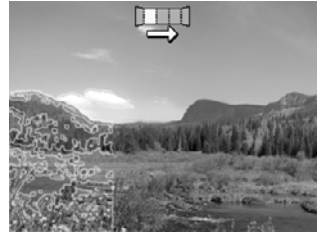

During **Instant Review** (see “[Instant Review](#)” on page 11), each image in the panoramic sequence is displayed. When the last image is displayed, you can stitch the sequence by pressing **◀**, then pressing $\frac{\text{Menu}}{\text{OK}}$ when the stitched panorama appears. You can also delete the panoramic sequence by pressing **🗑**, selecting **Entire Panoramic Sequence**, then pressing $\frac{\text{Menu}}{\text{OK}}$.











Using the Picture Capture and Video Record menus

The **Picture Capture** and **Video Record** menus allow you to adjust camera settings that affect the characteristics of the pictures and video clips you capture. The **Picture Capture Menu** displays only those features available for taking pictures while the **Video Record Menu** displays only features available for recording video clips.





























1. Slide **📷📹▶** to **📷** or **📹**, then press $\frac{\text{Menu}}{\text{OK}}$.
2. Use **▲▼** to highlight an option, then press $\frac{\text{Menu}}{\text{OK}}$ to display the option's menu.
3. Use **▲▼** to highlight a setting, then press $\frac{\text{Menu}}{\text{OK}}$ to change the setting or press **↶** to exit without changing the setting.
4. To exit the menu, press **↶** repeatedly until you return to **Picture Capture** or **Video Record**.

For on-camera information about an option, use **▲▼** to highlight **? Help...** in the option's menu, then press $\frac{\text{Menu}}{\text{OK}}$.

Unless otherwise noted, the setting remains in effect until you turn off the camera. The next time you turn on the camera, the settings reset to their defaults.

	<p>Video Quality (👤 only)—Sets resolution and compression for video clips. The setting remains in effect until it is changed, even when you turn off the camera.</p> <ul style="list-style-type: none"> • Best (Default)—For outdoor action video clips or printing individual video frames up to 10.2 by 15.2 cm (4 by 6 in). • ★ ★ Better —For indoor video clips or printing individual video frames up to 7.6 by 12.7 cm (3 by 5 in). • ★ Good —For capturing longer video clips or e-mailing shorter clips.
	<p>Self-Timer—For capturing images or recording video after a 10-second delay (see “Using the Self-Timer settings” on page 20). The setting resets to Off after the image is taken.</p> <ul style="list-style-type: none"> • Off (Default)—Disables Self-Timer. •  On—For taking one delayed shot or video clip. •  On-2 Shots (📷 only)—For taking two delayed shots.
	<p>Steady Photo (R840 series only; 📷 only)—For minimizing blur in pictures. This setting remains in effect until it is changed, even when you turn off the camera.</p> <p>Off (Default), On</p> <p>To use  Steady Photo with R830 series cameras, see Steady Photo under “Using the shooting modes” on page 15.</p>
	<p>Adaptive Lighting (📷 only)—Balances the relationship between light and dark areas. For more information, see “Adaptive Lighting” on page 21.</p> <p>Off (Default), On</p>
	<p>Image Quality (📷 only)—Sets resolution and compression for images. The greater the number, the higher the resolution. The setting remains in effect until it is changed, even when you turn off the camera.</p> <p>R840 series:</p> <ul style="list-style-type: none"> • 8MP Best—For enlarging or printing images greater than 41 x 51 cm (16 x 20 in). • Normal (8MP) (Default)—For printing images up to 41 x 51 cm (16 x 20 in). • 5MP—For printing images up to 28 x 36 cm (11 by 14 in). • 2MP—For printing images up to 13 x 18 cm (5 by 7 in). • VGA—For sending images via e-mail or posting them to the Internet. <p>R830 series:</p> <ul style="list-style-type: none"> • 7MP Best—For enlarging or printing images greater than 28 x 36 cm (11 by 14 in). • Normal (7MP) (Default)—For printing images up to 28 x 36 cm (11 by 14 in). • 5MP—For printing images up to 28 x 36 cm (11 by 14 in). • 2MP—For printing images up to 13 x 18 cm (5 by 7 in). • VGA—For sending images via e-mail or posting them to the Internet.
	<p>Burst (📷 only)—For taking two or more shots quickly in succession (see “Using the Burst setting” on page 20).</p> <p>Off (Default), On</p>
	<p>Tag—Applies a tag to pictures and video clips as they are taken or recorded. The setting remains in effect until it is changed, even when you turn off the camera.</p> <p>To select a tag to apply, use ▲▼ to highlight a tag, then press .</p> <p>For more information about tags, see “Tagging images” on page 24.</p>

















(continued)

	<p>Date & Time Imprint (📷 only)—Imprints date in lower left corner of image. The setting remains in effect until it is changed, even when you turn off the camera.</p> <ul style="list-style-type: none">• Off (Default)—No date or time imprinted on the image.•  Date Only—Date permanently imprinted.•  Date & Time—Date and time permanently imprinted.
	<p>Exposure Compensation—Overrides the camera's automatic exposure setting. For more information, see "Exposure Compensation" on page 21.</p> <ul style="list-style-type: none">• To make the images you are about to capture brighter, press  to increase the value.• To make the images you are about to capture darker, press  to decrease the value.
	<p>Exposure Bracketing (📷 only)—Creates a set of three images captured at the value set for  Exposure Compensation and under- and over-exposed by the value you select using  .</p> <ul style="list-style-type: none">• Off (Default)•  ± 0.5•  ± 1.0 <p>During Instant Review (see "Instant Review" on page 11), you can delete the entire bracketing sequence. To delete individual images, see "Deleting images" on page 23.</p>
	<p>White Balance—Balances color based on lighting conditions. For more information, see "White Balance" on page 21.</p> <ul style="list-style-type: none">• Auto (Default)—Corrects for scene illuminance. For general picture taking.•  Sun—For outdoor scenes in sunny or cloudy conditions.•  Shade—For outdoor scenes in shade or at dusk.•  Tungsten—For indoor scenes with incandescent or halogen lighting.•  Fluorescent—For indoor scenes with fluorescent lighting.
	<p>ISO Speed—Adjusts the camera's sensitivity to light. For more information, see "ISO speed" on page 21.</p> <ul style="list-style-type: none">• Auto (Default)—Camera selects the best ISO speed for the scene.•  ISO 100—For best quality.•  ISO 200—For lower light conditions.•  ISO 400—For lower light conditions and/or action when short shutter speeds are desired.•  ISO 800—For increased sensitivity in low light conditions.•  ISO 1600—For increased sensitivity in low light conditions.
	<p>AE Metering—Specifies which region of a scene the camera uses to calculate the exposure.</p> <ul style="list-style-type: none">• Average (Default)—Useful when you want the entire scene to be used when calculating exposure.•  Spot—Useful in backlit scenes or when the subject is very dark or light compared to the rest of the scene. For best results, use Focus Lock (see "Using Focus Lock" on page 12) with  Spot.
	<p>Camera Setup...—Displays the  Camera Setup Menu for setting camera behavior (see "Using the Camera Setup Menu" on page 38).</p>
	<p>Camera Help...—Displays a list of help topics for commonly used features.</p>

 **NOTE:** Some options are not available in certain shooting modes or with other settings.

Using the Self-Timer settings

The  **Self-Timer** allows you to take one or two pictures or one video clip after a 10-second delay.









1. While in the  **Picture Capture** or  **Video Record** menu, use  to highlight  **Self-Timer**, then press .
2. In the  **Self-Timer** menu, use  to select  **On** (for one shot) or  **On-2 Shots**, press , then press  repeatedly until you return to  **Picture Capture** or  **Video Record**. For more details on selecting options in the  **Picture Capture** and  **Video Record** menus, see [“Using the Picture Capture and Video Record menus” on page 17](#).
3. Set the camera on a tripod or stable surface.
4. Frame the subject in the Image Display.
5. Press the **Shutter** button halfway down to lock focus and exposure. When the focus brackets turn green, press the **Shutter** button all the way down. The camera begins the 10-second countdown, then takes the picture or begins recording the video clip. If you chose  **On-2 Shots**, the camera takes the second picture a few seconds after the first.
6. If you are recording a video clip, press the **Shutter** button to stop recording.

 **TIP:** If you want to include yourself in the picture, place the camera on a tripod or stable surface, then press the **Shutter** button all the way down. The camera locks focus and exposure just before the end of the countdown, allowing you time to place yourself in the scene.

The  **Self-Timer** setting resets to the default **Off** setting after the picture or video clip is taken.

Using the Burst setting



 **Burst** allows you to take two or more pictures as quickly as possible when you press and hold the **Shutter** button all the way down.

1. While in the  **Picture Capture Menu**, use  to highlight  **Burst**, press , highlight **On**, press , then press  repeatedly until you return to  **Picture Capture**. For more details on selecting options in the  **Picture Capture Menu**, see [“Using the Picture Capture and Video Record menus” on page 17](#).
2. Frame the subject, then press the **Shutter** button halfway down to lock the focus and exposure. Then press the **Shutter** button all the way down and hold it. The camera takes pictures as quickly as possible until you release the **Shutter** button or the camera runs out of memory.

The Image Display remains off during the burst capture. After the burst images have been taken, each image appears one at a time in **Instant Review** (see [“Instant Review” on page 11](#)). You can delete the entire burst sequence in **Instant Review**. To delete individual images, see [“Deleting images” on page 23](#).





The  **Burst** setting remains in effect until it is changed again, or until it resets to the default **Off** setting when you turn off the camera.



Adaptive Lighting

This setting balances the relationship between bright and dark areas in a picture, preserving gentle contrasts while reducing harsh contrasts. When used with a flash,  **Adaptive Lighting** can brighten areas that a flash wouldn't reach.  **Adaptive Lighting** is useful in situations like these:

- Outdoor scenes with a mixture of sun and shade
- High contrast scenes that contain both light and dark objects
- Indoor scenes that use flash photography (to soften or even out the effect of the flash)
- Backlit scenes where the subject is too far away for the flash to reach, or is severely backlit (for example, in front of a window)

Exposure Compensation

You can use  **Exposure Compensation** to override the camera's automatic exposure setting.  **Exposure Compensation** is useful in scenes that contain many light objects (like a white object against a light background) or many dark objects (like a black object against a dark background). Such scenes could turn out gray without the use of  **Exposure Compensation**. For a scene with many light objects, increase the  **Exposure Compensation** to a positive number. For a scene with many dark objects, decrease the  **Exposure Compensation**.

 **TIP:** To see the effect varying  **Exposure Compensation** settings might have on a scene, use  **Exposure Bracketing** (see **Exposure Bracketing** under "[Using the Picture Capture and Video Record menus](#)" on page 17).

White Balance

Different lighting conditions cast different colors. This setting allows the camera to compensate for this, reproducing colors more accurately and ensuring that whites appear white in the final image. You can also adjust the white balance to produce creative effects. For example, the  **Sun** setting produces a warmer look to the image.

ISO speed

This setting adjusts the sensitivity of the camera to light. When  **ISO Speed** is set to the default **Auto** setting, the camera selects the best ISO speed for the scene.

Lower ISO speeds capture images with the least amount of grain (or noise), but result in slower shutter speeds. If taking a picture in low light conditions without a flash at  **ISO 100**, use a tripod.

Higher ISO numbers allow faster shutter speeds, and can be used when taking pictures in dark areas without a flash, or when taking pictures of fast moving objects. Higher ISO speeds produce pictures with more grain (or noise) and, therefore, can be of lower quality.

4 Reviewing images and video clips

You can review and manipulate images and video clips in **▶ Playback** as described here. For information about enhancing images, see [“Using the Playback Menu”](#) on page 24 and [“Using the Design Gallery Menu”](#) on page 27.

Using Playback

1. Slide to .
2. Use to scroll through your images and video clips.
3. Press to play video clips; press to pause a clip. When paused, use to scroll through the individual frames; press to resume playing the video.

During **▶ Playback**, the Image Display also indicates additional information about each image or video clip.







1		Playback indicator.
2		Memory card indicator.
3		Battery indicator (see “Power indicators” on page 49).
4	1 of 30	Number of this image or video clip out of the total number of stored images and video clips.
5		Image position in a panoramic sequence.
6		Tagged image (see “Tagging images” on page 24). If tagged as a Favorite , displays; if tagged with any other tag, and the number of attached tags display.
7		Image marked to buy prints online (see “Buying prints online” on page 36).
8		Number of electronic Photosmart Share destinations (see “Sharing images” on page 36).
9		

(continued)

9	 3	Number of copies to print (see " Marking images for printing " on page 35).
---	---	---











Deleting images

To delete a displayed image during  **Playback**:

1. Press .
2. Use   to select an option, then press  .











 - **This Image**—Deletes the image or video clip.
 - **All Except Favorites**—Deletes all images except those tagged as **Favorites**. This menu option only appears if you have images tagged as **Favorites** (see "[Tagging images](#)" on page 24).
 - **Entire Panoramic Sequence**—If the current image is part of a panoramic sequence, deletes all images in the panoramic sequence.
 - **All Images (in Memory/on Card)**—Deletes all stored images and video clips.
 - **Format (Memory/Card)**—Deletes all stored files, then formats the internal memory or memory card.

Viewing thumbnails

1. While in  **Playback**, press  **Thumbnails** (same as  **Zoom Out** on the **Zoom** lever) to view thumbnails.
2. Use   and   to scroll through the thumbnails.
3. Press   to exit  **Thumbnails** and view the highlighted image on the Image Display.















Once in  **Thumbnails** view, you can view thumbnails by date:

1. Press . Each thumbnail in this view represents a group of images taken on the same date.
2. Use   and   to scroll through the thumbnails.
3. With a dated thumbnail highlighted, press   to display thumbnails of images taken on that date.
4. Press   to exit  **Thumbnails** and view the highlighted image on the Image Display.

Magnifying images









This feature is for viewing purposes only; it does not permanently alter the image.

1. While in  **Playback**, press  (same as  **Zoom In** on the **Zoom** lever). The currently displayed image is magnified 2x.
2. Use   and   to pan around the magnified image.
3. Use  and  to change the magnification.
4. Press   to return to  **Playback**.



Using the Playback Menu



1. While in **▶ Playback**, press $\frac{\text{Menu}}{\text{OK}}$.
2. Use $\blacktriangle\blacktriangledown$ to highlight an option.
3. Use $\blacktriangleleft\blacktriangleright$ to select an image or video clip, press $\frac{\text{Menu}}{\text{OK}}$, and follow any on-camera instructions.
4. Press \curvearrowright repeatedly to return to **▶ Playback**.

	Design Gallery... —Allows you to enhance images by editing, cropping, adding borders, and more (see “Using the Design Gallery Menu” on page 27).
	Photosmart Express... —Allows you to mark images for printing, sharing, and ordering prints online (see “Using HP Photosmart Express” on page 35).
	Tag —Allows you to tag images for printing, sharing, or buying prints online (see “Tagging images” on page 24).
	View Slideshow —Allows you to create and view slideshows of your pictures and videos (see “Viewing slideshows” on page 25).
	Stitch Panorama —Allows you to stitch, on-camera, a panoramic sequence into a single image (see “Stitching panoramas” on page 25).
	Move Images to Card —Moves images from internal memory to a memory card. This option is only available if there are images in internal memory and a memory card is inserted. To move images, select this option and follow the on-screen prompts.
	Camera Setup... —Displays the  Camera Setup Menu for setting camera behavior (see “Using the Camera Setup Menu” on page 38).
	Camera Help... —Displays a list of help topics for commonly used features.

Tagging images

Once transferred to your computer, you can sort images by their tags.

To tag a displayed image during **▶ Playback**:

1. While in the **▶ Playback Menu**, press \blacktriangledown to highlight  **Tag**, then press $\frac{\text{Menu}}{\text{OK}}$.
2. Use $\blacktriangle\blacktriangledown$ to select a tag.
 - Highlight  **Favorites**, **Holidays**, **Birthdays**, **Family**, **Children**, **Friends**, **Pets**, **Activities**, **Vacations**, or **Other**, then press $\frac{\text{Menu}}{\text{OK}}$.
 - Select **Tag Menu Setup...** to define new tags (see [“Defining tags in Windows”](#) on page 25) or transfer tags to your preferred image processing software (see [“Transferring tags from your Macintosh”](#) on page 25).
 - Select **Tag All Images...** then select a tag to tag all images with the same tag.



NOTE: You can apply multiple tags to the same picture or video.

3. Press $\frac{\text{Menu}}{\text{OK}}$ again to tag the displayed image. **This Image** is checked in the selected tag menu. To untag the image, press $\frac{\text{Menu}}{\text{OK}}$ again.
4. Press \curvearrowright repeatedly to return to **▶ Playback**.

Defining tags in Windows

The HP Photosmart Software that came with your camera includes a feature that allows you to define custom tags on your computer, then transfer the tags to your camera.

To define tags:

1. In the  **Tag** menu, select **Tag Menu Setup...**
2. Connect your camera to your computer (see [“Connecting to the computer” on page 32](#)).
The Tag Setup Software launches automatically.
3. Follow the instructions in the Tag Setup Software help system to create, delete, and reorder tags, and to save new and modified tags to your camera.

Transferring tags from your Macintosh

The HP Photosmart Software that came with your camera allows you to use keywords in HP Photosmart Studio or iPhoto as camera tags.

1. Create keywords in HP Photosmart Studio or iPhoto.
2. In the  **Tag** menu, select **Tag Menu Setup...**
3. Connect your camera to your computer (see [“Connecting to the computer” on page 32](#)).
System Preferences opens to the **Organize** tab in the **HP Photosmart Camera** settings.
4. Use the controls in the **Organize** tab to select the keywords you wish to transfer to your camera.

Viewing slideshows

Select  **View Slideshow** to configure and run a slideshow of images and/or video clips on the camera Image Display or on a TV (if the camera is docked in an optional HP Photosmart dock and connected to a TV).

- **Images**—Plays the specified images; options are **All** (default), followed by any Tag that is applied to at least one image.
- **Interval**—Sets the amount of time each image is shown: **2 secs**, **5 secs** (default), **10 secs**, **15 secs**, **60 secs**.
- **Loop**—Specifies how often the slideshow repeats: **Once** (default), **2x**, **3x**, **Continuous**.
- **Image Type**—Specifies the image type to include in the slideshow: **Pictures & Videos**, **Pictures Only**, **Videos Only**.

Stitching panoramas

When an image from a panoramic sequence is displayed and you select  **Stitch Panorama**, the camera displays a stitched view of the panoramic sequence.













 **NOTE:** Stitching on-camera results in a smaller image than if you stitch when transferring images to a computer. To stitch a panorama at the resolution at which you took the panoramic sequence, transfer the panoramic sequence of images to your computer (see [“Transferring images with HP Photosmart Software” on page 31](#)).











1. Scroll to one of the images in a panoramic sequence, then press $\frac{\text{Menu}}{\text{OK}}$.
2. While in the **▶ Playback Menu**, use $\blacktriangle\blacktriangledown$ to select  **Stitch Panorama**, then press $\frac{\text{Menu}}{\text{OK}}$ to view a preview of the stitched image.
You can use \blacklozenge to magnify the stitched panorama preview, and $\blacktriangle\blacktriangledown\blacktriangleleft\blacktriangleright$ to pan around the image and examine the stitching.
3. Press $\frac{\text{Menu}}{\text{OK}}$ to stitch and save the panoramic image; press \curvearrowright to cancel panorama stitching.

A new file is created when you stitch a panorama, and the individual images in the panoramic sequence are retained.

5 Using the Design Gallery Menu

You can use the  **Design Gallery** features to enhance your captured images.



1. While in  **Playback**, use   to scroll to an image, then press .
2. Use   to highlight  **Design Gallery**, then press .
3. Use   to highlight an option, then press  and follow any on-camera instructions.
4. Press  repeatedly to return to  **Playback**.

	Remove Red Eyes —Allows you to remove red eyes in images containing human subjects (see “Removing red eyes” on page 27).
	Rotate —Rotates the displayed image. Use   to rotate the image clockwise or counter-clockwise in 90-degree increments. Press  to save the image in the new orientation.
	Apply Artistic Effects —Allows you apply a creative effect to an image (see “Applying artistic effects” on page 27).
	Enhance Photos —Allows you to correct certain flaws on an image (see “Enhancing photos” on page 28).
	Modify Color —Allows you to apply a color effect to an image (see “Modifying colors” on page 29).
	Add Borders —Allows you to add a border to an image (see “Adding borders” on page 29).
	Crop —Allows you to crop an image (see “Cropping images” on page 30).

Removing red eyes

When you select  **Remove Red Eyes**, the camera processes the current still image to remove red eyes from the subjects.

The red-eye removal process takes a few seconds, after which the image displays with green boxes around corrected areas, along with the  **Remove Red Eyes** menu:











- **Save Changes** (Default)—Overwrites the original image and returns to the  **Design Gallery Menu**.
- **View Changes**—Displays a magnified view of the image with green boxes around the corrected areas.
- **Cancel**—Returns to the  **Design Gallery Menu** without saving the red eye changes.

 **Remove Red Eyes** is only available for pictures taken with a flash.

Applying artistic effects

 **TIP:** If you need to crop an image (see [“Cropping images”](#) on page 30), do so before applying artistic effects, adding borders, or enhancing photos. If you plan to apply artistic effects, modify colors, or enhance photos, do so before adding a border.











 **Apply Artistic Effects** allows you to create a copy of a selected image and apply creative effects to the copy. To apply artistic effects:



1. While in the  **Design Gallery Menu**, use  to select  **Apply Artistic Effects**, then press .
2. Use  to select an option and preview the effect it has on the image.
 - **Ink Dots**—Uses dots to simulate the art technique of pointillism.
 - **Cartoon**—Simulates a highly-graphical comic book image.
 - **Watercolor**—Simulates a watercolor painting.
 - **Center Focus**—Creates a feathered blur radiating from a sharp center to a blurred edge.
 - **Posterize**—Creates a high-contrast, flat-toned effect.
 - **Retro**—Creates a two-color, high-contrast look from the 70s.
 - **Soft Glow**—Adds a diffuse, bright ethereal glow.
 - **Vintage**—Adds an aged, scratched look.
 - **Sky Color**—Enhances sky with a feathered color that fades from the top down.
 - **Ground Color**—Enhances landscapes with a feathered color that fades from the bottom up.
 - **Kaleidoscope**—Mirrors the image in four directions.
 - **Solarize**—Creates a partial reversal of tones and emphasizes outlines.
 - **Drawing**—Creates a pencil drawing using the edges in the image.
3. Press  to select the artistic effect and display the  **Apply Artistic Effects** menu. Follow the on-camera instructions to adjust the artistic effect.
4. Press  to save a copy of the image with the artistic effect and return to the  **Design Gallery Menu**. Press  to exit without saving and return to the  **Apply Artistic Effects** menu.

Enhancing photos

 **TIP:** If you plan to apply artistic effects, modify colors, crop, or enhance photos, do so before adding a border.

 **Enhance Photos** allows you to correct common problems or improve the image.





1. While in the  **Design Gallery Menu**, use  to select  **Enhance Photos**, then press .
2. Use  to select an enhancement.
 - **Slimming**—Compresses centered subjects for a slimmer look.
 - **Pet-Eye Fix**—Allows you to correct glowing-eye problems in images of animals.
 - A yellow selection box displays in the center of the image.
 - Use   to position the selection box over the eye to be corrected.
 - Press  to correct the selected eye.
 - Repeat these steps, if necessary, to correct a second eye.
 - **Touch Up**—Allows you to touch up superficial blemishes in an image.
 - A yellow selection box displays in the center of the image.
 - Use   to position the selection box over the blemish to be corrected.
 - Press  to correct the selected blemish.

- **R830 series:** Repeat these steps, if necessary, to correct additional blemishes.
 - **R840 series:** You can correct a single blemish at a time. To correct additional blemishes, repeat the entire procedure.
 - **Brightness/Contrast**—Allows you to adjust brightness, saturation, and contrast.
3. **Slimming and Brightness/Contrast:** Press $\frac{\text{Menu}}{\text{OK}}$ to select the enhancement and display the effect's menu.
Follow the on-camera instructions to adjust the enhancement.
 4. Once all corrections are made, press $\frac{\text{Menu}}{\text{OK}}$ again to save the changes, create a new file, and return to the  **Design Gallery Menu**. Press \curvearrowright to exit without saving and return to the  **Enhance Photos** menu.

Modifying colors

 **TIP:** If you plan to apply artistic effects, modify colors, or enhance photos, do so before adding a border.

 **Modify Color** allows you to apply color schemes to the displayed image. To modify colors:



1. Use $\blacktriangle\blacktriangledown$ to select  **Modify Color**, then press $\frac{\text{Menu}}{\text{OK}}$.
2. Use $\blacktriangle\blacktriangledown$ to select a color scheme and preview the effect it has on the image.
 - **Black & White**—Converts color images to black and white.
 - **Sepia**—Converts image to a brownish tone to look old-fashioned.
 - **B&W Tints**—Applies color tones on a black and white version of an image.
 - **Color Tints**—Adds an extra color layer to create a mood or feeling.
3. Press $\frac{\text{Menu}}{\text{OK}}$ to select the color scheme and display the  **Modify Color** menu.
Follow the on-camera instructions to adjust the color.
4. Press $\frac{\text{Menu}}{\text{OK}}$ to save a copy of the image with the specified color scheme and return to the  **Design Gallery Menu**. Press \curvearrowright to exit without saving and return to the  **Modify Color** menu.

Adding borders

 **TIP:** If you need to crop an image, do so before adding borders, applying artistic effects, or enhancing photos. If you plan to apply artistic effects, modify colors, or enhance photos, do so before adding a border.

 **Add Borders** allows you to add one or more predefined borders to the displayed image. To add a border:



1. Use $\blacktriangle\blacktriangledown$ to select  **Add Borders**, then press $\frac{\text{Menu}}{\text{OK}}$.
2. Use $\blacktriangle\blacktriangledown$ to select a border type and preview the effect it has on the image.
 - **Soft Edge**—Applies a soft, vignetted frame to the image.
 - **Inset Border**—Image extends beyond the inset frame.
 - **Torn Edge**—Creates random tears for an uneven border effect.
 - **Burned Edge**—Creates a border with darkened areas that appear burned.
 - **Spatter**—Creates an edge that appears to dissolve into the paper, like spray.
 - **Oval**—Adds an oval matte border with beveled edges.

- **Circle**—Adds a circular matte border with beveled edges.
 - **Rectangle**—Adds a rectangular matte border with sharp corners.
 - **Rounded Rectangle**—Uses a rectangle with soft corners for the matte border.
 - **Square**—Adds a square matte border with beveled edges.
3. Press $\frac{\text{Menu}}{\text{OK}}$ to select the border and display the  **Add Borders** menu. Follow the on-camera instructions to adjust the border.
 4. Press $\frac{\text{Menu}}{\text{OK}}$ to save a copy of the image with the specified border and return to the  **Design Gallery Menu**. Press \leftarrow to exit without saving and return to the  **Add Borders** menu.

Cropping images

 **Crop** allows you to crop the displayed image to the selected orientation, then use the **Zoom** lever and $\blacktriangle\blacktriangledown$ $\blacktriangleleft\blacktriangleright$ to ensure that the image content you want gets printed.

 **TIP:** Make sure you crop images as needed before adding borders, applying artistic effects, or enhancing photos.

1. Use $\blacktriangle\blacktriangledown$ to select  **Crop**, then press $\frac{\text{Menu}}{\text{OK}}$.
2. Use $\blacktriangle\blacktriangledown$ to select a crop orientation.
 - **Landscape** (Default)—Horizontally crops the displayed image to a 3:2 aspect ratio (one third wider than tall).
 - **Portrait**—Vertically crops the displayed image to a 2:3 aspect ratio (one-third taller than wide).
 - **Help**—Provides extended help information for the **Crop** function.
3. Press $\frac{\text{Menu}}{\text{OK}}$ to select the crop orientation and display the crop view. Follow the on-camera instructions to use the **Zoom** lever and adjust what appears in the cropped image.
4. Press $\frac{\text{Menu}}{\text{OK}}$ to save a copy of the cropped image and return to the  **Design Gallery Menu**. Press \leftarrow to exit without saving and return to the  **Crop** menu.

When you print, the normal aspect ratios get cropped on the top and bottom (landscape) or on the sides (portrait). Cropping helps ensure that the content you want gets printed.

6 Transferring and printing images

Regularly transferring images to your computer and deleting them from the memory card will reduce the time it takes to turn on your camera, to review images, and to transfer images. You can transfer pictures and video clips with or without the HP Photosmart Software that came with your camera. However, the HP Photosmart Software has several features for transferring and managing your images and also guides you through the transfer process.

 **NOTE:** Transferring a large number of high-resolution images from a memory card to your computer may take up to two hours. Even if your Image Display turns off during the transfer process or it appears that nothing is happening on the computer, do not disconnect your camera from your computer until your computer indicates that image transfer is complete.

Transferring images with HP Photosmart Software

If you have installed the HP Photosmart Software (see [“Install the software”](#) on page 8), use this method to transfer images and video clips to your computer.

When you connect your camera to a computer with the HP Photosmart Software installed:

- If you have marked images for printing (see [“Marking images for printing”](#) on page 35) and the computer is connected to a printer, the marked images are automatically printed.
- If you have marked images for sharing (see [“Sharing images”](#) on page 36) and the computer is connected to the Internet, the selected images are automatically sent to their destinations.
- If you have marked images to buy as prints (see [“Buying prints online”](#) on page 36) and the computer is connected to the Internet, you can follow the instructions on the computer screen to buy prints of those images you selected.
- If you have tagged images (see [“Tagging images”](#) on page 24), the tags are transferred with the images to your computer.
- You can transfer the images on the camera to the computer by following the instructions on the computer screen. Panoramic sequences that you have not stitched on the camera (see [“Using Panorama mode”](#) on page 16) are automatically stitched as you transfer them.

 **TIP:** You can also perform these tasks using an optional HP Photosmart dock (see the documentation that came with your dock).

To transfer images using the HP Photosmart Software:

1. If you have marked images for sharing, printing, or buying prints online (see [“Using HP Photosmart Express”](#) on page 35), verify that the computer is connected to a printer and/or the Internet.
2. Turn off the camera.

3. Connect the camera and computer using the USB cable that came with your camera.
4. Turn on the camera. When the Image Display indicates that the camera is connected to the computer, follow the instructions on the computer screen. For more information, see the Help feature in the HP Photosmart Software.



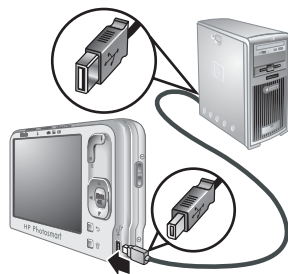

NOTE: If the camera does not successfully connect to the computer, see [“My camera stalls when establishing a connection to the computer.”](#) on page 43.



After you have transferred the images, you can then use the HP Photosmart Software to edit, print, or send the images from your computer.

Transferring images without HP Photosmart Software

If you do not install the HP Photosmart Software:

- You cannot use the  **Share** features or  **Buy Prints Online** on the camera's  **Photosmart Express Menu** (see [“Using HP Photosmart Express”](#) on page 35).
- Panoramic sequences are not automatically stitched when you transfer the images to your computer.
- Images marked for printing do not automatically print when the camera is connected to the computer.
- (Windows only) Tags associated with images transfer depending on the operating system you are using.
 - **Windows XP:** Tags associated with images do not transfer.
 - **Windows Vista:** Tags associated with images transfer to the Vista Photo Gallery.

However, you can still transfer images and video clips to your computer by:

- Connecting your camera directly to the computer (see [“Connecting to the computer”](#) on page 32)
- Using a memory card reader (see [“Using a memory card reader”](#) on page 33)

Connecting to the computer

1. Turn off the camera, connect the camera and computer using the USB cable that came with your camera, then turn on the camera. Your computer's provided image transfer software should start. Follow the on-screen instructions to transfer your images.
2. When you have finished transferring images, disconnect the camera from the computer.

If you encounter problems, set the camera's  **USB Configuration** to **Disk Drive** (see **USB Configuration** under [“Using the Camera Setup Menu”](#) on page 38) and reconnect to your computer.

 **NOTE:** On Macintosh computers, if you set the camera to **Disk Drive** and neither Image Capture nor iPhoto starts automatically, look on the desktop for a disk drive labeled with your camera model number and copy the images manually. For more information about how to copy files, visit Mac help.

Using a memory card reader

You can put your camera's optional memory card into a (separately purchased) memory card reader. Some computers and HP Photosmart printers have built-in memory card slots which act as a memory card reader.

1. Insert your camera's memory card into the memory card reader (or into your computer's memory card slot, if it has one).
2. Your computer's provided image transfer software starts automatically and guides you through the process of transferring images.
3. After verifying that the images were successfully transferred, return the memory card to your camera.

If no application starts automatically or if you want to copy the images manually, look for the disk drive for the memory card, then copy the images to your local hard drive. For more information about how to copy files, refer to your computer's help.

Printing directly to a printer

You can print images directly from the camera to any PictBridge-certified printer. For information about printing images from your computer, see ["Transferring images with HP Photosmart Software" on page 31](#).



 **NOTE:** You cannot print video clips using the method described in this section. You can, however, print a frame from a video clip using the HP Photosmart Software. For more information, see Help in the HP Photosmart Software.

1. Check that the printer is turned on, there is paper in the printer, and there are no printer error messages.

 **NOTE:** If you are printing a stitched panorama (see ["Using Panorama mode" on page 16](#)), verify that your PictBridge-certified printer can print panoramas and that you have loaded panorama paper.

2. Turn off the camera, connect the camera to the printer using the USB cable that came with your camera, then turn on the camera.
3. If the **Print marked pictures?** screen is displayed on the camera's Image Display, do

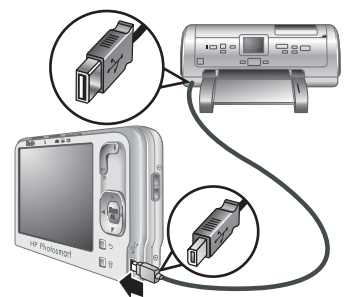

one of the following:

- If you want to print the pictures you marked for printing (see [“Marking images for printing”](#) on page 35), highlight **Yes**, press $\frac{\text{Menu}}{\text{OK}}$, then follow the on-camera instructions to select print options and print the marked pictures.



NOTE: After the printer prints the marked images, the Image Display on the camera shows an image. You can then select individual images to print by following the remaining steps in this procedure.

- If you want to select individual images to print, highlight **No**, then press $\frac{\text{Menu}}{\text{OK}}$.
4. When the Image Display on the camera shows an image:
- If you want to print one or more images, use \blacktriangleleft to display an image you want to print, use \blacktriangleright to specify the number of copies, then press $\frac{\text{Menu}}{\text{OK}}$. In the **Print Options** menu, highlight **Print This Image Now**, and press $\frac{\text{Menu}}{\text{OK}}$.
 - If you want to print a group of images or modify the printer settings, press $\frac{\text{Menu}}{\text{OK}}$, highlight **Print Menu...**, then press $\frac{\text{Menu}}{\text{OK}}$ again. Highlight the option you want.
 - **Printer Settings**—Specifies paper size, print size and quality, and borderless printing. Use \blacktriangleright to select a print option and use \blacktriangleleft to modify the selected print option. When you are done specifying print options, press $\frac{\text{Menu}}{\text{OK}}$.



NOTE: If you are printing a stitched panorama (see [“Stitching panoramas”](#) on page 25), set **Print Size** to **Panorama** in the **Printer Settings** menu.

- **Print All**—Prints one copy of each image. Press $\frac{\text{Menu}}{\text{OK}}$ and follow the on-camera instructions to begin printing.
 - **Print Index**—Prints all images as thumbnails. Press $\frac{\text{Menu}}{\text{OK}}$ to begin printing.
 - **Print Favorites**—Prints one copy of each image tagged as a **Favorite**. Press $\frac{\text{Menu}}{\text{OK}}$ to begin printing. This option is available only if you have tagged at least one image as a **Favorite** (see [“Tagging images”](#) on page 24).
 - **Cancel Printing**—Stops the printing of any images that have not yet printed. Press $\frac{\text{Menu}}{\text{OK}}$, highlight **Yes**, then press $\frac{\text{Menu}}{\text{OK}}$.
5. After the printer has printed all the images you selected, disconnect the camera from the printer.



NOTE: If you connect the camera to a non-HP printer and encounter problems with printing, contact your printer manufacturer. HP does not provide customer support for non-HP printers.

7 Using HP Photosmart Express

With **HP Photosmart Express**, you can select pictures in your camera to print automatically (see [“Marking images for printing”](#) on page 35), to buy prints online (see [“Buying prints online”](#) on page 36), or to send to custom destinations (see [“Sharing images”](#) on page 36) the next time you connect the camera to your computer or printer.



You must have the HP Photosmart Software installed on your computer to use some features in the  **Photosmart Express Menu**. For information about installing this software, see [“Install the software”](#) on page 8.



 **NOTE:** Available online services vary by country or region.

Using the Photosmart Express Menu

To display the  **Photosmart Express Menu**:









1. Slide  to  and press .
2. Use  to highlight  **Photosmart Express...**, then press .
3. Use  to highlight a menu option, then press .

	Print —Allows you to select images and specify number of copies to print. See “Marking images for printing” on page 35.
	Share —Allows you to add custom online destinations and share images to one or more destinations. See “Sharing images” on page 36.
	Buy Prints Online —Specifies images you want printed by an online printing service. See “Buying prints online” on page 36.

 **NOTE:** The features in the  **Photosmart Express Menu** are available only for pictures. They are not available for video clips.

Marking images for printing

Marked images are automatically printed when you connect the camera to a PictBridge-certified printer or a computer with the HP Photosmart Software installed. You can mark individual images, all images, or tagged images (see [“Tagging images”](#) on page 24).

1. While in the  **Photosmart Express Menu**, use  to highlight  **Print**, then press .
2. In the  **Print** menu, highlight an option, then press 
 - **This Image**—Marks the image currently displayed. You can scroll to a different image using .
 - **All Tagged...**—Displays a list of tags. Highlight a tag, then press . To specify the number of copies to print, use ,

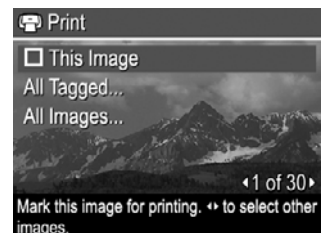

press $\frac{\text{Menu}}{\text{OK}}$. This option is available only if you have tagged at least one image (see [“Tagging images”](#) on page 24).

- **All Images...**—Displays the **Print All Images** entry. Press $\frac{\text{Menu}}{\text{OK}}$. This option is available only if you have more than one image in the camera.
3. If you selected **This Image** or **All Images...** and want to print more than one copy, highlight **Change Number of Copies**, then press $\frac{\text{Menu}}{\text{OK}}$. In the $\left(\frac{\text{Print}}{\text{OK}}\right)$ **Print** menu for changing the number of copies, use $\blacktriangle/\blacktriangledown$ to specify the number of copies to print, then press $\frac{\text{Menu}}{\text{OK}}$.
 4. From the main $\left(\frac{\text{Print}}{\text{OK}}\right)$ **Print** menu, you can mark additional images for printing, using $\blacktriangleleft/\blacktriangleright$ to display an image, then repeating Steps 2 and 3.
 5. When you are done marking images for printing, press \blackloopleft repeatedly until you return to $\left(\frac{\text{Print}}{\text{OK}}\right)$ **Playback**.
 6. To print the marked images directly to a printer, see [“Printing directly to a printer”](#) on page 33. To print them from a computer connected to a printer, see [“Transferring images with HP Photosmart Software”](#) on page 31.

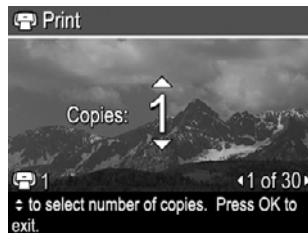

Buying prints online

You can mark images you want to order as prints. The next time you connect the camera to a computer with the HP Photosmart Software installed, you can order prints of the marked images online.









1. While in the $\left(\frac{\text{Print}}{\text{OK}}\right)$ **Photosmart Express Menu**, use $\blacktriangle/\blacktriangledown$ to highlight $\left(\frac{\text{Print}}{\text{OK}}\right)$ **Buy Prints Online**, then press $\frac{\text{Menu}}{\text{OK}}$.
2. In the $\left(\frac{\text{Print}}{\text{OK}}\right)$ **Buy Prints Online** menu, highlight an option, then press $\frac{\text{Menu}}{\text{OK}}$.
 - **This Image**—Marks the image currently displayed. You can scroll to a different image using $\blacktriangleleft/\blacktriangleright$.
 - **All Tagged...**—Displays a list of tags. Highlight a tag, then press $\frac{\text{Menu}}{\text{OK}}$ for each tag you want. When you are done selecting tags, press \blackloopleft . This option is available only if you have tagged at least one image (see [“Tagging images”](#) on page 24).
 - **All Images...**—Displays the **Buy Prints of All Images** entry. Press $\frac{\text{Menu}}{\text{OK}}$, then press \blackloopleft . This option is available only if you have more than one image in the camera.
3. To mark additional images, use $\blacktriangleleft/\blacktriangleright$ to display an image, then repeat Step 2.
4. When you are done marking images for which you want to buy prints, press \blackloopleft repeatedly until you return to $\left(\frac{\text{Print}}{\text{OK}}\right)$ **Playback**.
5. To buy prints of the images you selected, see [“Transferring images with HP Photosmart Software”](#) on page 31.

Sharing images

You can customize the $\left(\frac{\text{Print}}{\text{OK}}\right)$ **Share** menu to include e-mail addresses, group distribution lists, or other online services. You can then select images to send to these destinations.

Setting up online destinations in the camera





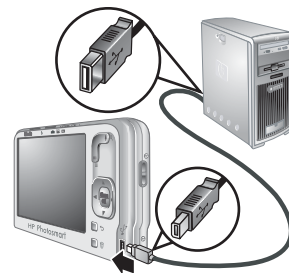













You can specify up to 34 custom destinations (such as individual e-mail addresses or group distribution lists) in the  **Photosmart Express Menu**.

1. Verify that your computer is connected to the Internet.
2. While in the  **Photosmart Express Menu**, use   to highlight  **Share**, then press . If you have already created destinations, highlight **Share Menu Setup** and press  again.
3. Connect the camera to your computer. Follow the on-screen instructions to set up destinations in your camera.
4. Turn off the camera and disconnect the camera from the computer. Turn on the camera, access the  **Photosmart Express Menu**, then highlight  **Share** and press  to verify that the new destinations are now in the camera.



Sending images to online destinations

After you have set up online destinations in the camera, you can mark images to be sent to these custom destinations the next time you connect your camera to your computer.

1. While in the  **Photosmart Express Menu**, use   to highlight  **Share**, then press .
2. In the  **Share** menu, highlight an option, then press .
 - **Custom Destinations**—Selects the destination to send the image displayed in the background. There may be multiple destinations depending on the number of them you created (see [“Setting up online destinations in the camera”](#) on page 37). You can scroll to a different image using  .
 - **All Tagged...**—Displays a list of tags. Highlight the tag you want, press  in the menu, then highlight each destination to which you want to send the pictures with the tag you selected, pressing  to select each destination. After selecting destinations, press . This option is available only if you have tagged at least one image (see [“Tagging images”](#) on page 24).
 - **All Images...**—Displays a list of destinations. Highlight each destination to which you want to send all images, pressing  to select each destination. After selecting destinations, press . This option is available only if you have more than one image in the camera.
3. To mark additional images to share, use   to display an image, then repeat Step 2.
4. When you are done marking images to share, press  repeatedly until you return to  **Playback**.
5. To send the images to the destinations, see [“Transferring images with HP Photosmart Software”](#) on page 31.



8 Using the Camera Setup Menu

The **Camera Setup Menu** allows you to set preferences for the camera's behavior. The **Camera Setup Menu** is available from the **Picture Capture**, **Video Record**, and **Playback** menus.

1. While in the **Picture Capture**, **Video Record**, or **Playback** menu, use to highlight **Camera Setup...**, then press .
2. Use to highlight a menu option, then press to display the menu option's menu.
3. Use to highlight a setting, then press .
4. To exit the **Camera Setup Menu**, press repeatedly until you return to **Picture Capture**, **Video Record**, or **Playback**.

Settings you specify remain until you change them.

	<p>Display Brightness—Adjusts the brightness of the Image Display.</p> <ul style="list-style-type: none"> • Automatic (R840 series only. Default)—For automatic adjustment of Image Display brightness based on lighting conditions. • Low—For extending battery life. • Medium (Default for R830 series)—For normal viewing conditions. • High—For very bright lighting conditions.
	<p>Camera Sounds—Adjusts the speaker volume for camera sounds (such as button presses and shutter clicks) and audio recorded with video clips.</p> <p>Off, Low (Default), High.</p>
	<p>Display Timeout—Specifies the time after which the Image Display turns off if you do not press a button.</p> <p>Never, 15, 30, 45 (Default), 60 seconds.</p>
	<p>Digital Zoom—Enables or disables digital zoom.</p> <p>On (Default), Off.</p>
	<p>Date & Time—Sets the date and time. See “Set the date and time” on page 7.</p>
	<p>USB Configuration—Specifies how a computer recognizes the camera. See “Connecting to the computer” on page 32.</p> <ul style="list-style-type: none"> • Digital Camera (Default)—Recognizes the camera as a digital camera using PTP (Picture Transfer Protocol). • Disk Drive—Recognizes the camera as a disk drive using MSDC (Mass Storage Device Class).
	<p>TV Configuration—Sets the video signal format for displaying camera images on a TV.</p> <ul style="list-style-type: none"> • NTSC—Used primarily in North America, parts of South America, Japan, Korea, and Taiwan. • PAL—Used primarily in Europe, Uruguay, Paraguay, Argentina, and parts of Asia.
	<p> (Language)—Sets the language. See “Choose the language” on page 7.</p>

9 Troubleshooting

Use this section to find information on:

- Resetting the camera (see [“Resetting the camera”](#) on page 39).
- Possible problems and solutions (see [“Problems and solutions”](#) on page 39).

Resetting the camera

If your camera does not respond when you press buttons, reset the camera.

1. Turn off the camera.
 2. Remove the memory card and battery.
 3. Press the straightened end of a paper clip into the **Reset** switch (the small hole located inside the tripod mount, as shown), hold the switch down for 3-6 seconds, then release.
 4. Reinstall the battery and close the Battery/Memory Card door.
 5. Turn on the camera. On successful reset, you may be prompted to set the date and time (see [“Set the date and time”](#) on page 7).
 6. Verify that the camera works without an optional memory card, then reinstall the card.
- When the camera is reset, any images or video clips stored in memory are retained.

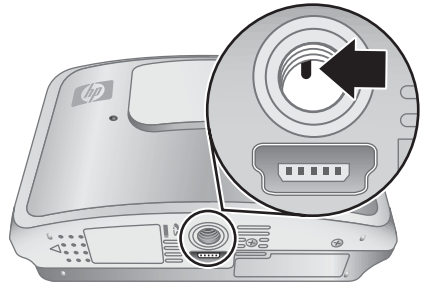



Problems and solutions

Use this information to find solutions to common issues you may have using your camera.

 **NOTE:** Known issues are often fixed with new releases of firmware. To optimize your digital photography experience, periodically check the Hewlett-Packard Technical Support website (www.hp.com/support) for updates to your camera's firmware, software, and drivers.

How can I get professional-quality prints if I don't have a photo printer?

Use the  **Buy Prints Online** feature on the  **Photosmart Express Menu** (see [“Buying prints online”](#) on page 36).

The camera does not turn on.

- Install a new or recharged battery, ensuring that the battery is inserted correctly (see [“Install the battery”](#) on page 6) and that you are using a rechargeable HP Photosmart R07 Lithium Ion battery for HP Photosmart R-series cameras.
- Ensure that a battery is installed in the camera, that the power adapter is connected to the camera and is plugged into a working electrical outlet, and that power adapter is not damaged or defective.

- Ensure that the memory card is the proper type (see [“Storage” on page 53](#)). If so, remove the memory card and turn on the camera; if the camera turns on, turn off the camera, install the memory card, turn on the camera, and format the memory card (see [“Install and format an optional memory card” on page 8](#)). If the camera does not turn on after you reinstalled the memory card, format the memory card using a memory card reader, or replace the memory card.
- Reset the camera (see [“Resetting the camera” on page 39](#)).

The battery gauge goes up and down frequently.

See [“Power indicators” on page 49](#).

I have to recharge the Lithium Ion battery frequently.

- See [“Extending battery life” on page 48](#).
- A battery that is new or has not been charged recently must be recharged to reach full capacity.
- If you have not used the battery for two months or longer, recharge it.

The Lithium Ion battery will not charge.

- Try charging it again after it has drained awhile.
- Use only the power adapter that came with your camera.
- If charging the battery in the HP quick recharger or the spare battery charging bay of an optional HP Photosmart dock does not work, replace the battery.

It takes the camera a long time to turn on.

- Your camera may be slower to turn on if you have a high capacity (4GB or larger) memory card inserted.
- Having a large number of files (over 300) stored on a memory card affects the time it takes for the camera to turn on. Transfer stored files to your computer, then format the memory card.
- Power-on time in  **Playback** is slow if you have a large number of tagged images on your memory card. Transfer the images to your computer (see [“Transferring and printing images” on page 31](#)) and review them there.

The camera does not respond when I press a button.

- Turn on the camera.
- Most of the camera buttons do not respond when the camera is connected to a computer.
- Replace or recharge the battery.
- Reset the camera (see [“Resetting the camera” on page 39](#)).
- The memory card may be defective. Remove the memory card and test the camera; if the camera works, replace the memory card.
- Format the internal memory and/or the memory card (see [“Install and format an optional memory card” on page 8](#)).

The camera does not take a picture when I press the Shutter button.





- Press the **Shutter** button all the way down.
- Make sure you are in  **Picture Capture**.

- The memory card or internal memory may be full. Transfer images from the camera to your computer, then format the internal memory or the memory card (see [“Install and format an optional memory card”](#) on page 8). Or replace the card with a new one.
- The camera may be processing. Wait a few seconds for the camera to finish processing the last image before taking another picture.



The Image Display is not working.

- The Image Display may have timed out. Press any camera button to wake up the camera.
- Reset the camera (see [“Resetting the camera”](#) on page 39).
- Replace or recharge the battery.





My image is blurry.

- Use **Focus Lock** (see [“Using Focus Lock”](#) on page 12).
- **R830 series:** Use  **Steady Photo** shooting mode (see **Steady Photo** under [“Using the shooting modes”](#) on page 15).
- **R840 series:** Make sure  **Steady Photo** is turned on (see **Steady Photo** under [“Using the Picture Capture and Video Record menus”](#) on page 17).
- Use a tripod to hold the camera steady, or improve lighting conditions.
- Set the flash to  **Auto Flash** or  **Flash On** and set the shooting mode to  **Action**.



My image is too bright.

- Turn the flash off (see [“Setting the flash”](#) on page 15).
- Move back from the subject and use zoom.
- Adjust  **Exposure Compensation** (see **Exposure Compensation** under [“Using the Picture Capture and Video Record menus”](#) on page 17).
- Use  **Exposure Bracketing** (see **Exposure Bracketing** under [“Using the Picture Capture and Video Record menus”](#) on page 17).

My image is too dark.

- Wait for natural lighting conditions to improve, use the flash (see [“Setting the flash”](#) on page 15) or add indirect lighting.
- Adjust  **Exposure Compensation** (see **Exposure Compensation** under [“Using the Picture Capture and Video Record menus”](#) on page 17).
- Use  **Exposure Bracketing** (see **Exposure Bracketing** under [“Using the Picture Capture and Video Record menus”](#) on page 17).
- Use  **Adaptive Lighting** (see **Adaptive Lighting** under [“Using the Picture Capture and Video Record menus”](#) on page 17).
- Use the  **Spot** setting for  **AE Metering** (see **AE Metering** under [“Using the Picture Capture and Video Record menus”](#) on page 17).
- If the subject you are trying to capture is outside the flash range, turn off the flash. This causes a longer exposure time, so use a tripod or hold the camera steady. For information about flash working distance for this camera, go to www.hp.com/support, select your language and region, enter your camera model number in the **Search: Product** field, click **Product Information**, then click **Specifications**.

My image is grainy.

- Add indirect lighting, use the flash (see [“Setting the flash”](#) on page 15), or wait for natural lighting conditions to improve.
- Use a lower  **ISO Speed** setting (see **ISO Speed** under [“Using the Picture Capture and Video Record menus”](#) on page 17).
- **R830 series:** Using  **Steady Photo** shooting mode can increase graininess (see **Steady Photo** under [“Using the shooting modes”](#) on page 15).
- **R840 series:** Using  **Steady Photo** can increase graininess (see **Steady Photo** under [“Using the Picture Capture and Video Record menus”](#) on page 17).
- You may have zoomed in too far using digital zoom (see [“Digital zoom”](#) on page 13).
- If the camera is warm, the effect will diminish as the camera cools. For best image quality, avoid storing the camera in very hot locations.

Images are missing on my camera.

Remove the memory card and see if the images are stored in internal memory. If so, transfer the images to the memory card (see **Move Images to Card** under [“Using the Playback Menu”](#) on page 24).

I have two memory cards that are the same size, but one stores many more pictures than the other.

- Your memory card may contain files that are not images or videos recognized by the camera. Save any data on the memory card that you want to keep, then format the memory card (see [“Install and format an optional memory card”](#) on page 8).
- If your memory cards are 4GB or larger, the card that stores fewer images may have been improperly formatted by a device that does not support 4GB or larger cards. A new type of High Capacity Secure Digital (marked SDHC) memory card is now available that prevents improper formatting and use by devices not supporting 4GB or larger cards. Try formatting the card in this camera, which supports High Capacity Secure Digital cards.
- Your memory card may be defective. If you have formatted your memory card in the camera and it does not show the expected capacity, consider replacing the memory card.



My camera indicates I can store 1999 images regardless of the Image Quality setting.

When you turn on your camera with a memory card installed, the camera indicates the number of images you can put on the memory card at the current  **Image Quality** setting. This camera supports storing a maximum of 1999 images on a memory card.

It takes a long time to "Delete All" images from my memory card.

Having a large number of images stored on a memory card increases the time the camera takes to delete them. Instead of deleting them, format the memory card (see [“Install and format an optional memory card”](#) on page 8).

The Power light is on but the Image Display is off, or the camera seems stuck and won't operate.

- Slide    to a different position or press any camera button to reactivate the Image Display.
- Reset the camera (see [“Resetting the camera” on page 39](#)).

The camera responds sluggishly when trying to review images.

- Power-on time in  **Playback** is slow if you have a large number of tagged images on your memory card. Transfer the images to your computer (see [“Transferring and printing images” on page 31](#)) and review them there.
- See [“Storage” on page 53](#) and [“Memory capacity” on page 53](#) for tips about memory cards.

Video recording terminates abruptly. The video is saved successfully, but it is shorter than expected.

- Choose a lower resolution/compression combination for the video. If you used **Best**, consider using **★★ Better** or **★ Good** ; if you used **★★ Better**, consider using **★ Good** (see **Video Quality** under [“Using the Picture Capture and Video Record menus” on page 17](#)).
- Replace your memory card with a faster card. Look for cards marked High Performance, Pro, Ultra, or High Speed.

Video recording terminates abruptly and the video will not play back.

If the video is stored on a memory card, transfer the video to your computer (see [“Transferring and printing images” on page 31](#)), then reformat the card (see [“Install and format an optional memory card” on page 8](#)).

The camera gets warm (or even hot) to the touch.

This is normal. However, if anything seems out of the ordinary, turn off the camera and allow it to cool. Then examine the camera and the battery for signs of possible damage. For best image quality, turn off the camera when not using. Always store the camera in a cool place.

My camera stalls when establishing a connection to the computer.

- Your memory card may have a large number of images stored on it. The more images you have on your card, the longer it takes to establish a connection to the computer (up to five minutes). If you have a large number of images on the memory card, be sure to allow this additional time to establish the connection.
- Ensure that the USB cable is properly connected to the camera and computer.
- Try connecting the USB cable to another USB port on the computer.
- Turn the camera off, then on again. If that does not fix the problem, reset the camera (see [“Resetting the camera” on page 39](#)).
- If the problem persists, contact Hewlett-Packard Technical Support (see [“Product support” on page 46](#)).

I cannot transfer images from the camera to my computer.

- Either install the HP Photosmart Software (see [“Install the software”](#) on page 8), or see [“Transferring images without HP Photosmart Software”](#) on page 32.
- Configure your camera preferences so the HP Photosmart software starts automatically when you connect your camera to your Macintosh. Open the **HP Photosmart Camera** settings in **System Preferences** to make changes, or to view the camera software help.
- Set your camera to act as a **Disk Drive** (see **USB Configuration** in [“Using the Camera Setup Menu”](#) on page 38), then follow the steps in [“Connecting to the computer”](#) on page 32.

I get an error message when transferring images to my computer.

A power surge or electrostatic discharge may have affected the camera. Close the HP Photosmart Software, disconnect the camera from the computer, and reset the camera (see [“Resetting the camera”](#) on page 39). Then restart the image transfer process (see [“Transferring images with HP Photosmart Software”](#) on page 31).

The HP Photosmart Software does not start automatically when I connect to my Macintosh.

Configure your camera preferences so the HP Photosmart software starts automatically when you connect your camera to your Macintosh. Open the **HP Photosmart Camera** settings in **System Preferences** to make changes, or to view the camera software help.

The HP Photosmart Software takes a long time before it is ready to transfer images from my camera.

Having a large number of files stored on an optional memory card affects the amount of time it takes for the HP Photosmart Software to start transferring images. For best results, transfer images to your computer frequently, and always format the card after transferring images (see [“Install and format an optional memory card”](#) on page 8).

My camera shuts down unexpectedly.

- A power surge or electrostatic discharge may have affected the camera. Remove the battery and reset the camera (see [“Resetting the camera”](#) on page 39). Then reinstall the battery and turn on the camera.
- Recharge the battery.
- Connect the camera to AC power via the power adapter (see [“Charge the battery”](#) on page 6), then turn on the camera.
- Replace the battery.

I am having a problem installing or using the HP Photosmart Software.

- Make sure your computer meets the minimum system requirements as stated on the camera packaging.
- Refer to the HP Photosmart Software online help system.
- Refer to the Hewlett-Packard Technical Support website: www.hp.com/support.

Camera error messages

Should you receive one of the following error messages when using your camera, you can look up details about the message by visiting www.hp.com and searching on the specific code.

 **NOTE:** Codes beginning with **R840** apply to HP Photosmart R840 series cameras. Codes beginning with **R830** apply to HP Photosmart R830 series cameras.

- **Lens Error (general)**—R840–021, R830–021
- **Unsupported card**—R840–200, R830–200
- **Unable to format card**—R840–202, R830–202
- **Error saving image**—R840–100, R830–100
- **Error saving video**—R840–102, R830–102
- **Batteries cannot be charged**—R840–435, R830–435

10 Product support

Use this section to find support information for your digital camera, including links to helpful websites and an overview of the support process.

Helpful websites

To optimize your digital photography experience, periodically check the websites listed below for updates to your camera's software, drivers, and firmware.

Camera tips, product registration, newsletter subscriptions, driver and software updates, purchase HP supplies and accessories	www.hp.com Under Learn about: , click Digital Photography
Customers with disabilities	www.hp.com/hpinfo/community/accessibility (English only)
Hewlett-Packard Technical Support; firmware, software, and driver updates; support information	www.hp.com/support
Windows Vista support	www.hp.com/go/windowsvista (English only)

Getting assistance

To get the best from your HP product, consult the following standard HP support offerings:

1. Consult the product documentation.
 - Review "[Troubleshooting](#)" on page 39 in this document.
 - Review the electronic Help section within the software.
 - Refer to the camera's Help screens.
2. Visit the Hewlett-Packard Technical Support website at www.hp.com/support, or contact the store where you purchased this camera. The Hewlett-Packard Technical Support website is available to all HP customers. The Hewlett-Packard Technical Support website is the fastest source of up-to-date product information and expert assistance, including:
 - Fast e-mail access to qualified online support specialists.
 - Firmware, software, and driver updates for your camera.
 - Valuable product and troubleshooting information for technical issues.
 - Proactive product updates, support alerts, and HP newsletters (available when you register your camera).
3. HP support by phone. Support options and fees vary by product, country/region, and language. For a list of support conditions and phone numbers, visit www.hp.com/support.
4. Post-warranty period. After the limited warranty period, help is available online at www.hp.com/support.

5. Extending or upgrading your warranty. If you would like to extend or upgrade your camera's warranty, please contact the store where you bought the camera or check the HP Care Pack offers at www.hp.com/support.
6. If you already purchased an HP Care Pack Service, please check the support conditions on your contract.

A Managing batteries

Your camera uses a rechargeable HP Photosmart R07 Lithium Ion battery (L1812A/L1812B).

Top points about batteries









Always insert the battery in the camera correctly (see [“Install the battery” on page 6](#)). If the battery is inserted improperly, the compartment door may close but the camera will not operate.

- New rechargeable Lithium Ion batteries are shipped partially charged. Fully charge them before first use.
- If you do not intend to use your camera for more than two months, leave the camera connected to AC power using the power adapter that came with your camera. The camera will top off the battery periodically to ensure that the camera is always ready for use.
- A rechargeable Lithium Ion battery can be left in the camera or optional dock or quick recharger for any period of time without harm.
- If a rechargeable Lithium Ion battery has not been used for more than two months, recharge it before using it again. Fully recharge Lithium Ion batteries every six months to a year to prolong their useful life.
- The performance of Lithium Ion batteries degrades over time, especially if stored and used at high temperatures. If battery life is unacceptably short, replace the battery.
- The performance of Lithium Ion batteries will decrease as the temperature drops. To improve battery performance, store the camera and batteries in a warm inside pocket when in a cold environment. To prevent short-circuiting the batteries, never carry small metal items such as keys or coins in the same pocket with your batteries.

Extending battery life

To conserve battery power, the Image Display turns off after 45 seconds by default. For the **R840 series**, the Image Display also automatically dims and brightens based on lighting conditions. Pressing any button wakes up the camera. After five minutes of inactivity, the camera turns off.

To further extend battery life:

- Set  **Display Brightness** to **Low** (see **Display Brightness** under [“Using the Camera Setup Menu” on page 38](#)).
- Change the  **Display Timeout** value to a shorter interval (see **Display Timeout** under [“Using the Camera Setup Menu” on page 38](#)).
- Set your camera to  **Auto Flash** (see **Auto Flash** under [“Setting the flash” on page 15](#)).
- Use optical zoom sparingly.
- If you are turning on the camera only to view images, slide    to , then turn on the camera to start in  **Playback** without zooming the lens.
- When printing directly to a PictBridge-certified printer, place your camera in an optional HP Photosmart dock connected to AC power.

Safety precautions for using batteries









- Do not place the battery in fire or heat the battery. Always store charged batteries in a cool location.
- Do not connect the positive and negative terminals of the battery to each other with any metal object.
- Do not carry or store the battery with metal objects. Do not drop the battery into a change-filled pocket.
- Do not pierce the battery or subject it to strong impacts or shocks.
- Do not solder directly onto the battery.
- Do not allow the battery to get wet.

- Do not disassemble or modify the battery.
- Immediately discontinue use of the battery if, while using, charging, or storing the battery, the battery emits an unusual smell, feels excessively hot (note that it is normal for the battery to feel warm), changes color or shape, or appears abnormal in any other way.
- In the event the battery leaks and the fluid gets into one's eye, do not rub the eye. Rinse well with water and immediately seek medical care. If left untreated, the battery fluid could cause damage to the eye.

△ **CAUTION:** Risk of explosion if battery is replaced by an incorrect type. Dispose of used batteries according to the instructions.

Power indicators

The power indicators are most accurate after a few minutes of use. The following table explains the meaning of these indicators.

Icon	Description
	Battery has more than 70 percent energy remaining.
	Battery has 30 to 70 percent energy remaining.
	Battery has 10 to 30 percent energy remaining.
	Battery level is low. You cannot take pictures or record video clips but you can still review images in  Playback and use the  Playback Menu .
 Blinking	Battery is depleted. Camera will power down.
Animated battery filling up	Camera is operating on AC power and is charging the battery.
	Camera has successfully completed battery charging and is operating on AC power.

 **NOTE:** If the camera is without a battery for a prolonged period, the clock may be reset and you may be prompted to update it the next time you power on the camera.

Number of shots per battery charge



A fully charged HP Photosmart R07 Lithium Ion battery should take approximately 230 pictures using an R830 series camera and 210 pictures using an R840 series camera. These numbers are estimates based on standards established by the Camera and Imaging Products Association (CIPA). However, many factors affect the actual number of pictures you will be able to take (see "[Top points about batteries](#)" on page 48).

 **NOTE:** For more information about batteries, go to www.hp.com/support and search on the code **R-400**.

Recharging the Lithium Ion battery

You can recharge the HP Photosmart R07 Lithium Ion battery using the methods listed below.

The following table shows the average recharge time for a fully discharged battery, based on recharge location.

Charge location	Average charge time	Signals
In camera connected to AC power via the power adapter	2–3 hours	Charging: Camera's battery charging light blinks and the animated battery icon is displayed. Charging complete: Camera's battery charging light turns on solid and the battery gauge changes to  on the Image Display.
In camera connected to a computer or printer via the USB cable	4–6 hours	Charging: For most computers and printers, camera's battery charging light blinks and the animated battery icon is displayed, but see the note at the end of this table. Charging complete: Camera's battery charging light turns on solid and the battery gauge changes to  on the Image Display.
In camera connected to AC power via an HP Photosmart dock	2–5 hours	Charging: Dock's camera battery charging light blinks. Charging complete: Dock's camera battery charging light turns on solid.
In battery bay of an HP Photosmart dock	2–3.5 hours	Charging: Dock's battery bay light blinks. Charging complete: Dock's battery bay light turns on solid.
In an HP Photosmart R-Series quick recharger	1 hour	Charging: Quick recharger light is yellow. Charging complete: Quick recharger light is green.

 **NOTE:** Some printers and computers provide lower power via the USB connection. If you are charging using the USB cable connected to one of these printers or computers, the camera's battery charging light may not blink while the battery is charging, but will turn on solid when charging is complete.

Safety precautions for recharging batteries

You can recharge a Lithium Ion battery in the camera or purchase an optional dock with battery bay or a quick recharger. These devices may be warm while charging a Lithium Ion battery. This is normal. However, you should follow the safety precautions below.



- Do not charge any other battery than the HP Photosmart R07 Lithium Ion battery in the camera, dock, or quick recharger.
- Insert the Lithium Ion battery in the correct orientation.
- Use the camera, dock, or quick recharger in a dry location only.
- Do not charge a Lithium Ion battery in a hot location, such as in direct sunlight or near a fire.
- When recharging a Lithium Ion battery, do not cover the camera, dock, or quick recharger.
- Do not operate the camera, dock, or quick recharger if the Lithium Ion battery appears damaged.
- Do not disassemble the camera, dock, or quick recharger.

- Unplug the power adapter or quick recharger from the electrical outlet before cleaning the power adapter or quick recharger.
- After extensive use, the Lithium Ion battery may begin to swell. If it becomes difficult to insert the battery into or remove the battery from the camera, dock, or quick recharger, discontinue use of the battery and replace it with a new one. Please recycle the old battery.

B Specifications

Resolution	<p>Pictures, R840 series</p> <ul style="list-style-type: none"> • 8.15MP (3298 by 2472) effective pixel count • 8.29MP (3336 by 2484) total pixel count <p>Pictures, R830 series:</p> <ul style="list-style-type: none"> • 7.24MP (3112 by 2328) effective pixel count • 7.4MP (3164 by 2342) total pixel count <p>Video clips:</p> <ul style="list-style-type: none"> • VGA <ul style="list-style-type: none"> • 640 by 480 total pixel count • Best—24 frames/sec • ★★ Better—12 frames/sec • QVGA <ul style="list-style-type: none"> • 320 by 240 total pixel count • ★ Good—24 frames/sec
Sensor	<ul style="list-style-type: none"> • R840 series: Diagonal 7.183 mm (1/2.5 in, 4:3 format) CCD • R830 series: Diagonal 7.208 mm (1/2.5 in, 4:3 format) CCD
Color depth	36 bit (12 bits by 3 colors). 36 bit images are transformed into an optimized 24 bit image and stored in the JPEG format. This transformation results in no discernible change to color or detail in the stored image, and allows the image to be read by computers.
Lens	<p>Focal length:</p> <ul style="list-style-type: none"> • Wide—6.5 mm • Telephoto—19.5 mm • 35 mm equivalent—39 mm to 118 mm <p>F-number:</p> <ul style="list-style-type: none"> • Wide—f/3.5 to f/7.4 • Telephoto—f/4.2 to f/8.8
Viewfinder	None
Zoom	<ul style="list-style-type: none"> • 3x optical zoom with 10 positions between wide and telephoto • 8x digital zoom
Focus	<p>Focus settings: Auto (Default), Close-up</p> <p>Auto (Default):</p> <ul style="list-style-type: none"> • Wide—500 mm (19.7 in) to infinity • Telephoto—600 mm (23.62 in) to infinity <p>Close-up—Wide, 100 mm to 1 m (3.94 in to 39.4 in)</p>
Shutter speed	1/2000 to 10 seconds
Built-in flash	Yes, 6-second typical recharge time (9-second maximum recharge time at power-on)
Flash working range	To locate the flash working range for this camera, go to www.hp.com/support , select your language and region, enter your camera model number in the Search: Product field, click Product Information , then click Specifications .

(continued)

Image Display	7.57 cm (2.98 in) color LTPS TFT LCD with backlight; 230,400 pixels (960 by 240) total pixel count
Storage	<ul style="list-style-type: none">• 32MB internal flash memory, not all of which is available for storing images and video clips (see “Memory capacity” on page 53).• Slot for memory card.• This camera supports standard, high speed, and high capacity Secure Digital (SD and SDHC) memory cards, 32MB to 8GB.• This camera supports storing a maximum of 1999 images on a memory card.• The number of images or video clips that can be saved in memory depends on the  Image Quality and  Video Quality settings (see “Memory capacity” on page 53).
Compression format	<ul style="list-style-type: none">• JPEG (EXIF) for pictures• Motion JPEG for video clips
Interfaces	Dock connector (HP 1253–7135) and USB cable connector (USB 2.0 Full Speed/USB mini-B) connected to either: <ul style="list-style-type: none">• Power adapter (via USB connector on the side of the camera)• Optional HP Photosmart dock (via dock connector on the bottom of the camera)
Standards	<ul style="list-style-type: none">• USB—PTP and MSDC• JPEG• Motion JPEG• DPOF• EXIF• DCF• DPS
External body dimensions	Measurements with camera off and lens cover closed (width, depth, height): 98 mm (3.86 in) by 26.5 mm (1.04 in) by 63.15 mm 2.49 in)
Weight	146 grams (5.15 ounces) without battery
Power	Typical power usage: 1800 mW (with Image Display on). Power sources include: <ul style="list-style-type: none">• One rechargeable HP Photosmart R07 Lithium Ion battery for HP Photosmart R-series cameras• Power adapter included with camera (5 Vdc, 1A, 5 W)• HP AC power adapter included with an optional HP Photosmart dock (5 Vdc, 2A, 10 W)
Temperature range	Operational: 0° to 40° C (32° to 104° F) at 15% to 85% relative humidity Storage: –30° to 65° C (–22° to 149° F) at 15% to 90% relative humidity

Memory capacity

Not all 32MB of internal memory is available for storing images, because some memory is used for internal camera operations. The actual file sizes and number of still images that can be stored in internal memory or on a memory card will vary depending on the content of each still image, or the length of each video clip and associated audio clip.

Image quality

To locate the approximate number and average size of pictures that can be stored in internal memory when the camera is set to different  **Image Quality** settings (see **Image Quality** under “[Using the Picture Capture and Video Record menus](#)” on page 17), go to www.hp.com/support, select your language and region, enter your camera model number in the **Search: Product** field, click **Product Information**, then click **Specifications**.

Video quality

To locate the approximate seconds of video that can be stored in internal memory when the camera is set to different  **Video Quality** settings (see **Video Quality** under “[Using the Picture Capture and Video Record menus](#)” on page 17), go to www.hp.com/support, select your language and region, enter your camera model number in the **Search: Product** field, click **Product Information**, then click **Specifications**.

Index

A

Action mode 16
Adaptive Lighting 18, 21
adding borders 29
AE Metering 19
apply artistic effects 27
arrow buttons 4
artistic effects 27
assistance 46
Auto mode 16

B

Back button 4
battery
 charge 6
 conserving 48
 door 5
 install 6
 shots per 49
 top points about use 48
Beach mode 16
blinking lights on camera 4
borders 29
Burst setting 18, 20

C

camera
 dimensions 53
 dock insert 5
 parts 4, 5
 reset 39
 specifications 52
 turn on/off 6
 weight 53
Camera Setup Menu 38
Camera Sounds 38
Close-up mode 16
color depth 52
colors 29
compression format 53
computer, connect to 31, 32
correcting images 28

D

Date & Time 7, 38
Date & Time Imprint 19

deleting images 4, 23
Design Gallery 27
digital zoom 13, 38
dimensions 53
direct print 33
Display Brightness 38
Display Timeout 38
dock insert 5

E

e-mail images 36, 37
enhancing photos 28
exposure 13
Exposure Bracketing 19
Exposure Compensation 19, 21

F

F-number 52
flash
 settings 15
 working range 52
Flash button 4
focal length 52
focus
 auto focus 11
 brackets 11
 focus lock 12
 optimizing 12
 settings 52
folded lens 5
format memory card 8

G

getting assistance 46

H

HP Photosmart Express 35
HP Photosmart Software 8

I

Image Display 4
Image Quality 18, 54
images
 correcting 28
 Date & Time Imprint 19
 deleting 23

Image Quality 18, 54
 magnifying 23
 number remaining 10
 Panorama mode 16
 per battery 49
 sending 37
 shooting modes 15
 tagging 24
 transfer to computer 31
install memory card 8
install software 8
Instant Review 11, 17, 20
interfaces 53
internal memory 10, 53
ISO Speed 19, 21

L

Landscape mode 16
Language 7, 38
LEDs 4
lens 5
lights on camera 4
Lithium Ion battery 48, 50

M

Magnify control 4
magnifying images 23
memory
 capacity 53
 card 10
 card door 5
memory card 8, 53
Menu/OK button 4
menus
 Camera Setup 38
 Design Gallery 27
 Photosmart Express 35
 Picture Capture 17
 Playback 24
 Video Record 17
microphone 5
modifying colors 29
Move Images to Card 24

N
Night Portrait mode 16

- number of
 - pictures 54
 - pictures remaining 10

O

- on/off 6
- online
 - destinations 36, 37
 - print buying 36
- optical zoom 13

P

- Panorama mode 16, 25
- parts of camera 4, 5
- Photosmart Express Menu
 - buying prints online 36
 - marking images for printing 35
 - sharing images 36
- Picture Capture Menu 17
- pictures 10, 20
- Playback 22
- Playback Menu 24
- Portrait mode 16
- power
 - indicators 49
 - light 4
 - usage 53
- preview Panorama 25
- print images 33, 35
- prints, buy online 36
- problems and solutions 39
- product support 46

R

- record video clips 11
- red-eye removal 15, 27
- Region 7
- remaining pictures count 10
- removing red eyes 27
- reset camera 39
- resolution 52
- reviewing images 22

S

- safety precautions for
 - batteries 48, 50
- selecting images for
 - destinations 36, 37
- selecting images for printing 35

Self-Timer

- light 5
- setting 18, 20
- sending individual images 36, 37
- set date and time 7
- setting up destinations 36, 37
- share pictures 35
- shooting mode 15
- Shutter button 4, 11
- shutter speed 52
- slideshow 25
- Snow mode 16
- software install 8
- solving problems 39
- sounds of camera 38
- space remaining in memory 10
- specifications 52
- State Selector 4
- Steady Photo 18
- Steady Photo mode 16
- Stitch Panorama 25
- storage 53
- Sunset mode 16
- support process 46

T

- tagging images
 - before the image is taken 18
- Theatre mode 16
- Thumbnails 23
- Thumbnails control 4
- Time & Date 7, 38
- transfer images 31, 32
- troubleshooting 39
- turn on/off power 6
- TV Configuration 38

U

- USB configuration 32, 38

V

- video clips 11, 18, 54
- Video Quality 18, 54
- Video Record Menu 17
- View Slideshow 25
- viewing thumbnails 23

W

- websites 46

- weight 53

- White Balance 19, 21

Z

- zoom 13, 52
- Zoom lever 4

Regulatory / Geltende Richtlinien / Informations réglementaires

Geräuschemission
LpA < 70 dB
Am Arbeitsplatz
Normaler Betrieb
nach DIN 45635 T. 19

FCC statement

The United States Federal Communications Commission (in 47 CFR 15.105) has specified that the following notice be brought to the attention of users of this product.

This equipment has been tested and found to comply with the limits for a Class B digital device, pursuant to Part 15 of the FCC Rules. These limits are designed to provide reasonable protection against harmful interference in a residential installation. This equipment generates, uses and can radiate radio frequency energy and, if not installed and used in accordance with the instructions, may cause harmful interference to radio communications. However, there is no guarantee that interference will not occur in a particular installation. If this equipment does cause harmful interference to radio or television reception, which can be determined by turning the equipment off and on, the user is encouraged to try to correct the interference by one or more of the following measures:

- Reorient or relocate the receiving antenna.
- Increase the separation between the equipment and receiver.
- Connect the equipment into an outlet on a circuit different from that to which the receiver is connected.
- Consult the dealer or an experienced radio/TV technician for help.

For further information, contact:

Manager of Corporate Product Regulations
Hewlett-Packard Company
3000 Hanover Street
Palo Alto, Ca 94304
(650) 857-1501

HP Photosmart R830/R840 series Digital Camera Declaration of Conformity (European Economic Area)

According to ISO/IEC 17050-1 and EN 17050-1

Supplier's name: Hewlett-Packard Company
Digital Photography and Entertainment Division

declares that the product:

Product name: HP Photosmart R830/R840 series Digital Camera (may contain suffixes)
Product number(s): L2466A, L2467A, L2468A, L2469A, L2470A, L2471A (R830 series)
L2484A, L2485A, L2486A, L2487A, L2488A (R840 series)
Regulatory model: FCLSD-0703
Product Options HP Photosmart 6221 Premium Camera Dock (Product number Q6221A, Regulatory model FCLSD-0602)
Power adapter: Power Adapter for camera (Product number 405434-001, Regulatory model PSB05R-050Q)
Alternate Power Adapter for camera (Product number 441600-001, Regulatory model EADP-5CB A)

Conforms to the following Product Specifications:

Safety IEC/EN 60950-1:2001
IEC/EN 60825-1:1994+A1:2002+A2:2001 Class 1 LED

Electromagnetic compatibility (EMC)
EN 55022:1998+A1:2000+A2:2003, Class B
IEC/EN 61000-3-2:2000
IEC/EN 61000-3-3:1995 + A1:2001
EN 55024:1998+A1:2001+A2:2003

Supplementary information:

The product herewith complies with the requirements of the Low Voltage Directive 73/23/EEC and the EMC Directive 89/336/EEC and carries the CE marking accordingly.

Canada

This Class B digital apparatus complies with Canadian ICES-003.

Cet appareil numérique de la classe B est conforme à la norme NMB-003 du Canada.

Free Manuals Download Website

<http://myh66.com>

<http://usermanuals.us>

<http://www.somanuals.com>

<http://www.4manuals.cc>

<http://www.manual-lib.com>

<http://www.404manual.com>

<http://www.luxmanual.com>

<http://aubethermostatmanual.com>

Golf course search by state

<http://golfingnear.com>

Email search by domain

<http://emailbydomain.com>

Auto manuals search

<http://auto.somanuals.com>

TV manuals search

<http://tv.somanuals.com>