



i n v e n t

## **User's Guide**

HP f2304 High Definition 23" LCD Monitor

The information in this document is subject to change without notice.

Hewlett-Packard® Company makes no warranty of any kind with regard to this material, including, but not limited to, the implied warranties of merchantability and fitness for a particular purpose.

HP shall not be liable for errors contained herein or for incidental or consequential damages in connection with the furnishing, performance, or use of this material.

THE WARRANTY TERMS CONTAINED IN THIS STATEMENT, EXCEPT TO THE EXTENT LAWFULLY PERMITTED, DO NOT EXCLUDE, RESTRICT OR MODIFY AND ARE IN ADDITION TO ANY MANDATORY STATUTORY RIGHTS APPLICABLE TO THE SALE OF THIS PRODUCT OR SERVICE TO YOU.

HP assumes no responsibility for the use or reliability of its software on equipment that is not furnished by HP.

This document contains proprietary information that is protected by copyright. All rights are reserved. No part of this document may be photocopied, reproduced, or translated to another language without the prior written consent of HP.

Hewlett-Packard Company  
P.O. Box 4010  
Cupertino, CA 95015-4010  
USA

© 2003–2004 Hewlett-Packard Development Company, L.P.  
All rights reserved.

Hewlett-Packard is a registered trademark of Hewlett-Packard Company in the United States of America and other countries/regions.



**WARNING:** Text set off in this manner indicates that failure to follow directions could result in bodily harm or loss of life.

---



**CAUTION:** Text set off in this manner indicates that failure to follow directions could result in damage to equipment or loss of information.

---



Text set off in this manner indicates additional information.

---

---

# Contents

## 1 Product Features

## 2 Safety and Maintenance Guidelines

Important Safety Information . . . . .	2-1
Maintenance Guidelines . . . . .	2-2
Cleaning the Monitor . . . . .	2-4
Shipping the Monitor . . . . .	2-4

## 3 Setting Up the Monitor

Selecting the Signal Connectors and Cable . . . . .	3-5
Removing the Monitor Base . . . . .	3-5
Mounting the Monitor . . . . .	3-7
Removing the Side Panel . . . . .	3-7
Side Panel Connectors . . . . .	3-8
Cable Management . . . . .	3-10

## 4 Operating the Monitor

Installing the Information Files . . . . .	4-1
Using Monitor Buttons . . . . .	4-2
Adjusting Monitor Settings . . . . .	4-5
Using the On-Screen Display . . . . .	4-5
Using the Auto Adjustment Function . . . . .	4-8
Identifying Special OSD Messages . . . . .	4-9
Adjusting Screen Quality . . . . .	4-9
Enhancing the Video Function . . . . .	4-10
Optimizing Digital Conversion . . . . .	4-11

Using Video Connectors . . . . . 4-12  
Composite to S-video Adapter . . . . . 4-12

**5 Troubleshooting**

Solving Common Problems . . . . . 5-1  
Getting Help Using the Worldwide Web . . . . . 5-3  
Preparing to call Technical Support . . . . . 5-3

**A Specifications**

f2304 Flat Panel Monitor . . . . . A-1  
Recognizing Preset Display Resolutions . . . . . A-3  
LCD Monitor Quality and Pixel Policy  
for f2304 Monitor . . . . . A-5  
Entering User Modes . . . . . A-6  
Using the Energy Saver Feature . . . . . A-7

**B Agency Regulatory Notices**

Federal Communications  
Commission Notice . . . . . B-1  
    Modifications . . . . . B-2  
    Cables . . . . . B-2  
Declaration of Conformity for Products Marked  
with FCC Logo, United States Only . . . . . B-2  
Canadian Notice . . . . . B-3  
Avis Canadien . . . . . B-3  
European Notice . . . . . B-3  
Japanese Notice . . . . . B-4  
Korean Notice . . . . . B-4  
EPA Energy Star Compliance . . . . . B-4  
Power Cord Set Requirements . . . . . B-5  
HP Recycling Program . . . . . B-6

**C TCO '99 Requirements**

---

## Product Features

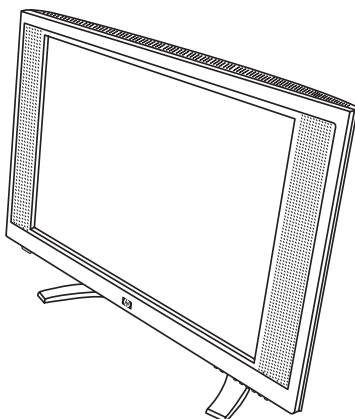

The HP f2304 High Definition 23" LCD Monitor (liquid crystal display) has an active matrix and a thin-film transistor (TFT). The monitor features include:

- Large wide screen 23-inch diagonal (58.4 cm) viewable area display.
- 1920 × 1200 resolution, plus full-screen support for lower resolutions.
- Wide viewing angle to allow viewing from a sitting or a standing position.
- Tilt adjustment capabilities.
- Removable base for flexible mounting solutions.
- Integrated stereo speakers.

- Multiple video inputs supported:
  - VGA analog
  - DVI-I supports either analog or digital signal input
  - S-video with composite video adapter included
  - Component video for high definition video support
- Video input includes PiP (Picture in Picture) option for windowed video display over data display.
- The high definition component video input supports 480i, 480p, 720p, and 1080i video format.
- Audio support connections include a PC line-in connector, RCA connectors for AV input, and a headphone jack connector.
- VGA and DVI-D signal cables included.
- Plug and Play capability if supported by your system.
- On-Screen Display (OSD) adjustments in English, Dutch, French, Italian, Spanish, and German for ease of set-up and screen optimization.
- The *User Guide* CD includes an information file (INF), Image Color Matching file (ICM), Auto Adjustment software, Acrobat Reader software, and product documentation.
- Energy Saver feature for Energy Star<sup>®</sup> compliance.
- Compliant with the following regulated specifications:
  - EPA ENERGY STAR
  - European Union CE Directives
  - TCO '99 Requirements
  - VESA VSI standard

---

## Safety and Maintenance Guidelines

### Important Safety Information

A power cord is included with your monitor. If another cord is used, use only a power source and connection appropriate for this monitor. For information on the correct power cord set to use with your monitor, refer to the "Power Cord Set Requirements" section in Appendix B.



**WARNING:** To reduce the risk of electric shock or damage to your equipment, do not disable the power cord grounding feature. This equipment is designed to be connected to a grounded (earthed) power outlet that is easily accessible to the operator. The grounding plug is an important safety feature.

---



**WARNING:** For your safety, be sure that the power outlet you plug the power cord into is easily accessible and located as close to the equipment as possible. When you need to disconnect the power to the equipment, unplug the power cord from the power outlet by grasping the plug firmly. Never pull on the cord.

---



**WARNING:** For the protection of your monitor, as well as your computer, connect all power cords for your computer and its peripheral devices (such as a monitor, printer, scanner) to some form of surge protection device such as a power strip or Uninterruptible Power Supply (UPS). Not all power strips provide surge protection; the power strips must be specifically labeled as having this ability. Use a power strip whose manufacturer offers a Damage Replacement Policy so you can replace your equipment if surge protection fails.

---

## Maintenance Guidelines

To enhance the performance and extend the life of your monitor:

- Do not open your monitor cabinet or attempt to service this product yourself. Adjust only those controls that are covered in the operating instructions. If your monitor is not operating properly, or has been dropped or damaged, contact your HP authorized dealer, reseller, or service provider.
- Use only a power source and connection appropriate for this monitor, as indicated on the label/back plate of the monitor.
- Be sure the total ampere rating of the products connected to the outlet does not exceed the current rating of the electrical outlet, and the total ampere rating of the products connected to the cord does not exceed the rating of the cord. Look on the power label to determine the ampere rating (AMPS or A) for each device.
- Install your monitor near an outlet that you can easily reach. Disconnect the monitor by grasping the plug firmly and pulling it from the outlet. Never disconnect the monitor by pulling the cord.



- Turn your monitor off when not in use. You can substantially increase the life expectancy of your monitor by using a screen saver program and turning off the monitor when not in use.
- Unplug your monitor from the wall outlet before cleaning. Do not use liquid cleaners or aerosol cleaners. Use a damp cloth for cleaning. If the screen requires additional cleaning, use an antistatic screen cleaner.



**CAUTION:** Do not use benzene, thinner, ammonia, or any other volatile substances to clean your monitor or the screen. These chemicals may damage the cabinet finish as well as the screen.

---

- Slots and openings in the cabinet are provided for ventilation. These openings must not be blocked or covered. Never push objects of any kind into cabinet slots or other openings.
- Do not drop your monitor or place it on an unstable surface.
- Do not allow anything to rest on the power cord. Do not walk on the cord.
- Keep your monitor in a well-ventilated area, away from excessive light, heat, or moisture.
- When removing the monitor base, you must lay the monitor face down on a soft flat area to prevent it from getting scratched, defaced, or broken.

## **Cleaning the Monitor**

To clean the monitor, follow these steps:

1. Turn off the monitor and the computer.
2. Unplug the monitor.
3. Dust the monitor by wiping the screen and the cabinet with a soft, clean cloth.



**CAUTION:** Do not use benzene, thinner, ammonia, or any volatile substance to clean the monitor screen or cabinet. These chemicals may damage the monitor. Never use water to clean an LCD screen.

---

If the screen requires additional cleaning, use a clean cloth dampened with isopropyl alcohol.

## **Shipping the Monitor**

Keep the original packing box. You may need it later if you move or ship your monitor.

---

## Setting Up the Monitor

The f2304 monitor connects to your computer through an analog connector (VGA) or a digital (DVI) connector. Some video cards support a higher resolution through an analog (VGA) connection than through a digital (DVI) connection.

The f2304 monitor supports resolutions up to 1920 x 1200 for both analog and digital connections. Please see the documentation that came with your PC or video card for details regarding the video resolution settings supported by your equipment.



The DVI-D cable supplied with this monitor is for digital-to-digital connection only. Your computer must have a DVI-compatible graphics card installed for use with the DVI-D signal cable. When connecting the DVI-D signal cable to the DVI-I connector on the monitor, you must connect the other end of the DVI-D cable to the DVI connector on the computer.

---

To set up the monitor, ensure that the power is turned off to the monitor, computer system, and other attached devices, then follow these steps:

1. Place the monitor in a convenient, well-ventilated location near your computer.



Your f2304 monitor may have been shipped with the VGA cable attached. This cable may be detached if you want to use only a DVI cable instead.

---

2. Connect one end of the VGA monitor signal cable to the VGA video connector on the rear panel of the computer, and the other end to the back of the monitor.

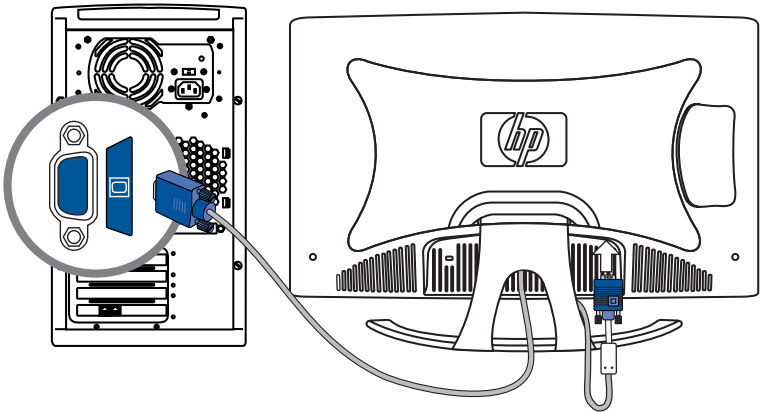

Or

- Connect one end of the DVI-D monitor signal cable to the DVI video connector on the rear panel of the computer, and the other end to the back of the monitor.

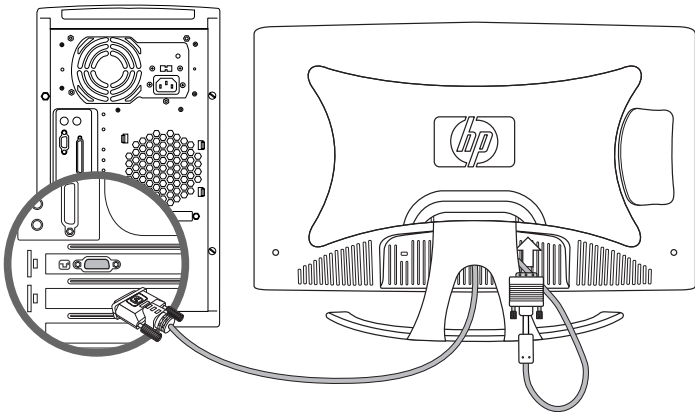



**WARNING:** To reduce the risk of electric shock or damage to your equipment: Do not disable the power cord grounding plug. The grounding plug is an important safety feature.

Plug the power cord into a grounded (earthed) electrical outlet that is easily accessible at all times.

Disconnect power from the monitor by unplugging the power cord from the electrical outlet.

Do not place anything on power cords or cables. Arrange them so that no one may accidentally step on or trip over them. Do not pull on a cord or cable. When unplugging from the electrical outlet, grasp the cord by the plug.

---

3. Connect the power cable to the back of the monitor and connect the other end to an electrical wall outlet.

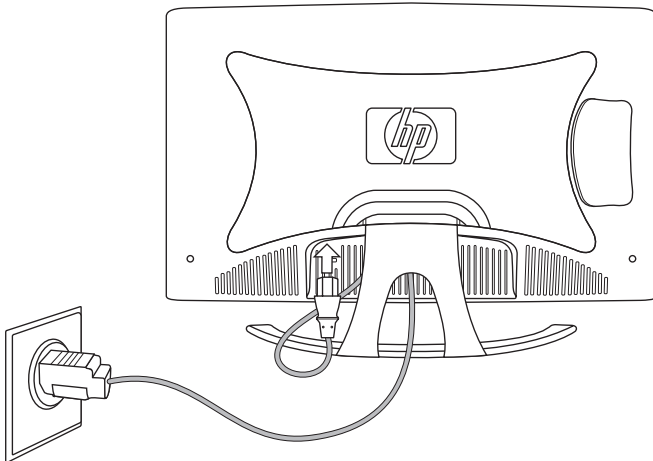

4. Remove side panel. See "Removing the Side Panel" on page 3-7. Connect the speakers cable to the PC Audio In connector on the monitor and then connect the other end to the Audio Out connector on the back of the PC.

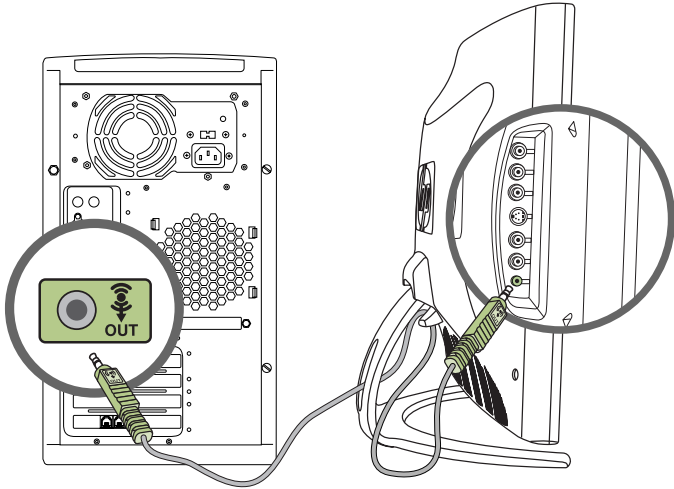

5. Adjust the monitor as needed for your comfort using the monitor's tilt adjustment capabilities.

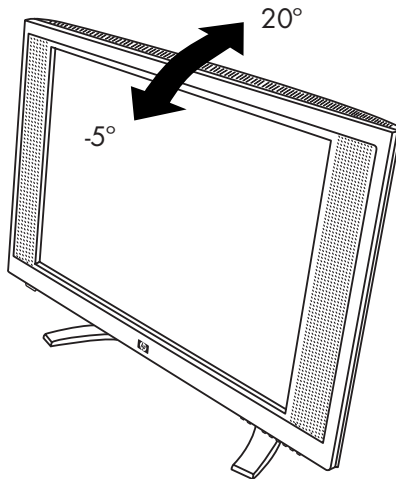



**WARNING:** Burn-in image damage may occur on monitors that display the same static image on screen for a prolonged period of time. To avoid burn-in image damage on your monitor screen, you should always activate a screen saver application or turn off the monitor when it is not in use for a prolonged period of time.

---

## Selecting the Signal Connectors and Cable

There are five signal input connectors: one VGA connector, one DVI-I connector, one S-video connector, two RCA audio connectors, and a PC Audio In connector. The monitor will automatically determine at power-on which inputs have valid video signals. The inputs can be selected via the On-Screen Display (OSD) feature or by pressing the Input button on the monitor's front bezel.

The video mode supported by the DVI-I connector is determined by the video cable used. For digital operation, use the DVI-D to DVI-D signal cable provided.

## Removing the Monitor Base

You can remove the monitor base to mount the monitor on a wall, swing arm, or other mounting fixture. Read the caution and warning statements below before beginning the procedure.



**CAUTION:** Before beginning to disassemble the monitor, be sure the monitor is turned off and the power and all signal cables are disconnected.

---



**WARNING:** Before removing the base from the monitor, lay the monitor flat with the front bezel down. Attempting to remove the base from an upright monitor may result in injury to the user.

---

 **CAUTION:** Ensure that the front bezel of the monitor is positioned over a flat table or desktop to prevent it from getting scratched, defaced, or broken when removing the base from the monitor.

---

To remove the monitor base:

1. Disconnect and remove the signal and power cables from the back of the monitor.
2. Lay the monitor face down on a flat area.
3. Remove the back panel by gently pulling on the handle and then slowly easing the tabs around the panel out of the tab slots.
4. Remove the four screws from the monitor base as shown in the following illustration.
5. Remove the monitor base from the monitor.

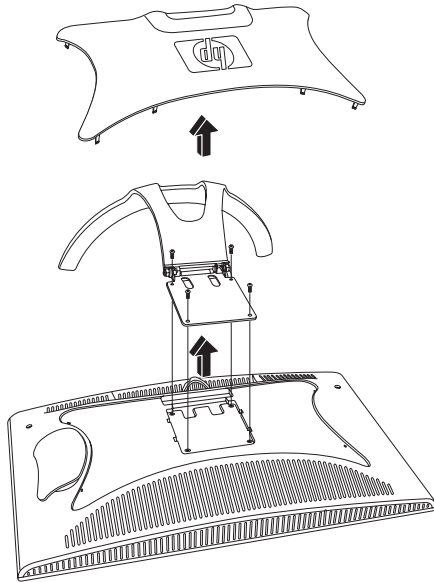



## Mounting the Monitor

1. Remove the monitor base. Refer to "Removing the Monitor Base" steps in the previous section.
2. With the base is removed, use the four threaded screw holes on the monitor panel to mount the monitor. The mounting holes are spaced 4 inches (10.2 cm) apart.



---

Mount the monitor to a swing arm or other mounting fixture by following the instructions included with the mounting fixture to be used.

---

## Removing the Side Panel

On the back of the f2304 monitor there are several connectors behind the side panel.

To remove the side panel:

1. Gently pull on the edge of the side panel.
2. Slowly ease the tabs around the side panel out of the tab slots as shown in the following illustration.

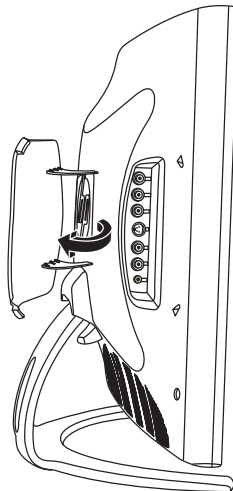

## Side Panel Connectors

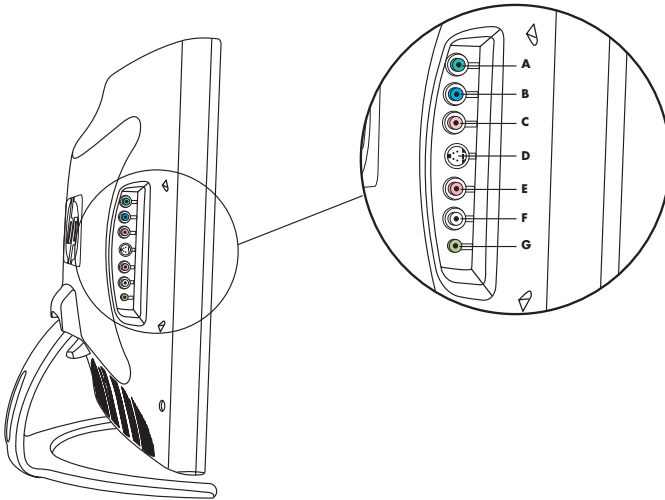

	Label	Connector Color	Function
<b>A</b>	Y	Green	<b>High-Definition Component Video Input</b> Connects to the video component output of a DVD player or set-top box. The f2304 monitor is capable of displaying video from 480i, 480p, 720p, and 1080i sources.
<b>B</b>	P <sub>b</sub>	Blue	
<b>C</b>	P <sub>r</sub>	Red	
<b>D</b>	S-VIDEO IN	Black	<b>S-video Input</b> connects to an S-video output device, such as console game, set-top box, VCR, or DVD player.
			 A composite cable can be attached to the S-video input using the supplied composite-to-S-video adapter.

	Label	Connector Color	Function
<b>E</b>	R	Red	<b>Right/Left RCA audio line-in</b> connects to an audio source, such as a console game, set-top box, VCR, or DVD player. When component or S-video input is selected from the onscreen display, audio will be used from this source.
<b>F</b>	L	White	
<b>G</b>	(  ) ↑	Lime Green	<b>PC Audio In</b> connects to audio from a PC source. When VGA or DVI input is selected, audio will be used from this source.

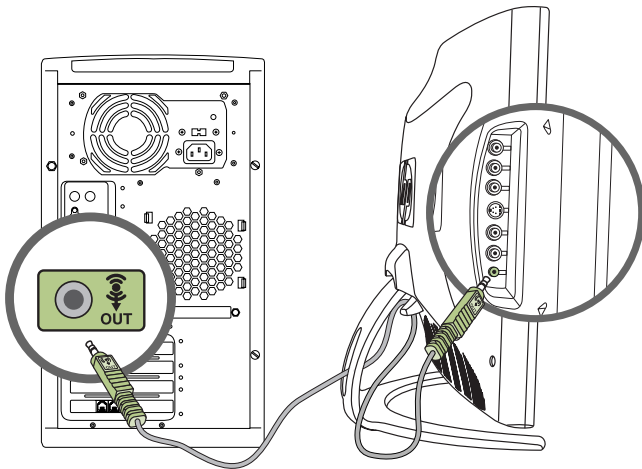

## Cable Management

The f2304 monitor is designed to help you organize your monitor cables in one area. The power cord, the VGA, and DVI cables can be threaded through the hole in the back of the monitor stand and positioned over the two hooks on the inside of the monitor stand, located through the back opening. Similarly, the cables you connect to the back side of your monitor can be threaded through the bottom of the side door and looped through the same opening on the back of the monitor.

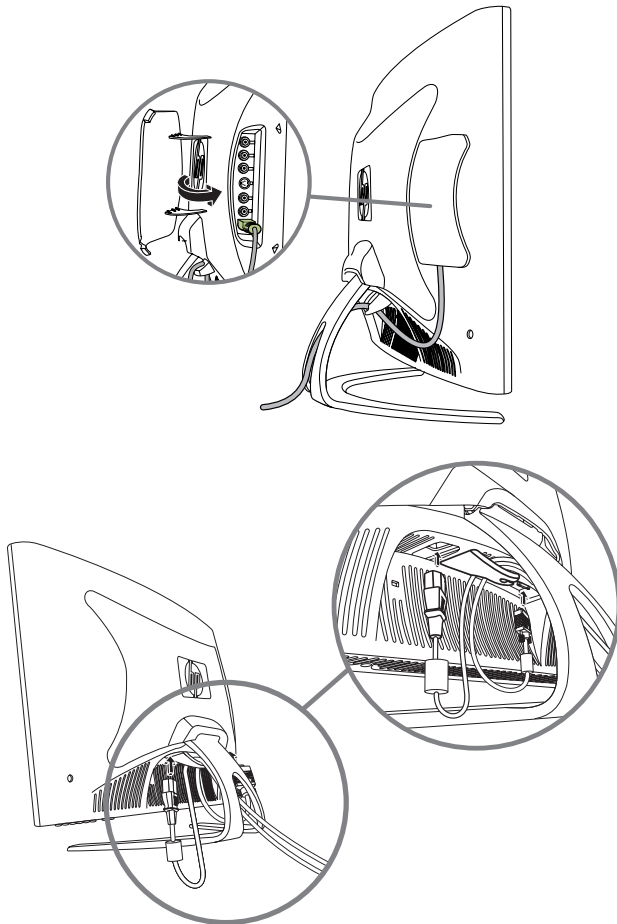

---

# Operating the Monitor

## Installing the Information Files

The *User Guide* CD included with this monitor contains two information files to be installed onto your computer; an .INF file and an .ICM file.

- The .INF file defines monitor resources and provides specifications used by most operating systems to install support software for certain hardware devices. The .INF file ensures monitor compatibility and optimization with your computer's graphics adapter. You can download .INF files by clicking on: <http://www.hp.com/support> and then selecting the desired monitor.
- The .ICM file provides color matching consistency from monitor screen to printer and is activated from within graphics programs that have this feature.

To install these files on your computer, insert the *User Guide* CD into your computer CD-ROM drive. When the CD menu launches, select "Install INF and ICM Files" and follow the onscreen instructions.



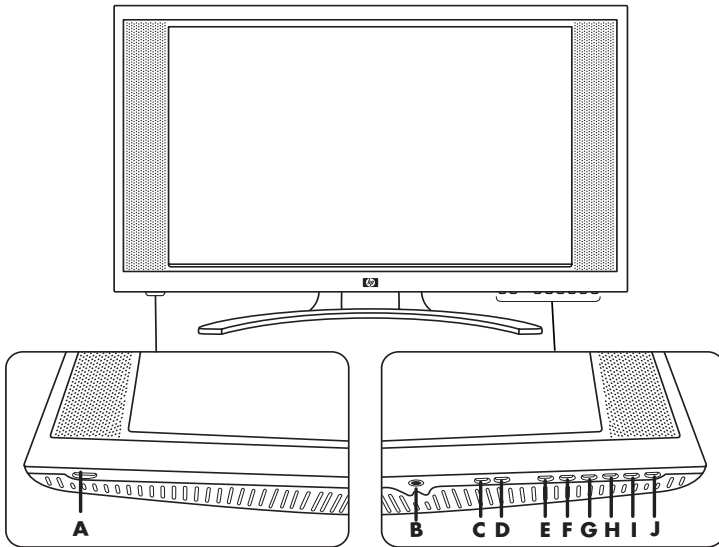

## **Using Monitor Buttons**

The monitor buttons are located under the front panel of the monitor. The monitor buttons are used to:

- Turn on the monitor.
- Open the Main Menu onscreen display (OSD) window where you can change the monitor settings.
- Control the brightness and contrast of the display.
- Open the Picture in Picture (PiP) window when analog or digital video is displayed.
- Select signal input.
- Adjust volume.



### Monitor Buttons

Icon/ Label	Control	Function
<b>A</b> 	Power button and Power LED	Turns the monitor on and off. Full power = Blue Sleep = Amber
<b>B</b> 	Headphone connector	Use a headphone device. Note: When the headphone connector is being used, the monitor speakers are muted.
<b>C</b> 	Volume Down	Turns volume lower.
<b>D</b> 	Volume Up	Turns volume higher.
<b>E</b> 	PiP button	<ul style="list-style-type: none"> <li>• Opens the Picture in Picture (PiP) window when analog or digital video is displayed.</li> <li>• If the PiP setting is selected without valid S-video or component video input signals, the PiP window appears black.</li> </ul>

## Monitor Buttons

Icon/ Label	Control	Function
<b>F</b>	Input	Signal Input button
		Signal input selection — scrolls through VGA-Analog, DVI-Analog, DVI-Digital, S-video, and component video input.
<b>G</b>	Auto	Auto button
		Automatically adjusts the display to the ideal setting.
<b>H</b>	▼	OSD Down Adjustment
		<ul style="list-style-type: none"> <li>• Select and adjust the on-screen display (OSD) Menu settings.</li> <li>• Brightness control hot key. When OSD is not active, pressing the OSD Down control displays the OSD Brightness adjust function. When the OSD Brightness adjust scale is visible, press the OSD Up and Down buttons to adjust the brightness, then press the Menu button to confirm the new setting.</li> </ul>
<b>I</b>	▲	OSD Up Adjustment
		<ul style="list-style-type: none"> <li>• Select and adjust the OSD Menu settings.</li> <li>• Contrast control hot key. When OSD is not active, pressing the OSD Up control displays the OSD Contrast Adjust function. When the OSD Contrast adjust scale is visible, press the OSD Up and Down buttons to adjust the contrast, then press the Menu button to confirm the new setting.</li> </ul>
<b>J</b>		Menu button and (+) and (-) buttons
		<ul style="list-style-type: none"> <li>• Displays the On-Screen Display (OSD) menu and selects functions.</li> <li>• The (+) and (-) buttons move up and down the menu, respectively.</li> <li>• Pressing the Menu button again brings up the second menu level.</li> </ul>



## Adjusting Monitor Settings

Press the Menu button to view the On Screen Display (OSD) Menu. The Main Menu window pops up and you can make adjustments to your monitor's various features. Use the arrow keys in the Main Menu window to make your adjustments.

## Using the On-Screen Display

The adjustments for screen settings are located in the on-screen display (OSD). Press the Menu button on the monitor's front panel to view the OSD menu. Select Language and then select one of six available languages for the menu. The following table shows the menus and their functions at each level:

<b>OSD Menu Levels</b>			
<b>Menu Level 1</b>	<b>Menu Level 2</b>	<b>Menu Level 3</b>	<b>Menu Level 4</b>
Brightness	Adjustment Scale		
Contrast	Adjustment Scale		
Image Control	Auto Adjustment	"Adjusting" Message	
	Horizontal Position	Adjustment Scale	
	Vertical Position	Adjustment Scale	
	Custom Scaling (Displayed when VGA or DVI input is selected)	Fill to Screen	
		Fill to Aspect Ratio	
		One to One	

**OSD Menu Levels**

<b>Menu Level 1</b>	<b>Menu Level 2</b>	<b>Menu Level 3</b>	<b>Menu Level 4</b>
	Image Zoom (Displayed when video device is selected)	Zoom Off	
		Zoom On 1	
		Zoom On 2	
	Sharpness	Sharpness Selection	
	Clock	Adjustment Scale	
	Clock Phase	Adjustment Scale	
Color	9300K		
	6500K - sRGB		
	Custom Color	Red, Green, Blue	
	Video Color	Hue, Saturation	
Language	Deutsch		
	English		
	Español		
	Français		
	Italiano		
	Nederlands		
Management	Power Saver	On/Off Selection	
	Power On Recall	On/Off Selection	
	Mode Display	On/Off Selection	

**OSD Menu Levels**

<b>Menu Level 1</b>	<b>Menu Level 2</b>	<b>Menu Level 3</b>	<b>Menu Level 4</b>
	Serial Number	Display serial number	
	Sleep Timer	Set current & sleep time	
	Basic Menu		
OSD Control	Horizontal Position	Adjustment Scale	
	Vertical Position	Adjustment Scale	
	OSD Timeout	Adjustment Scale	
	OSD Transparency	Adjustment Scale	
Video Input Controls	Video Input Select	Analog (D-SUB)	
		Analog (DVI)	
		Digital (DVI)	
		S-video	
		Component Video	
		Auto Detect	
	PiP Control	PiP Source	S-video
			Component Video
		PiP Size	PiP Off
			Small
			Medium
			Large

### OSD Menu Levels

Menu Level 1	Menu Level 2	Menu Level 3	Menu Level 4
		Horizontal Position	Adj Scale
		Vertical Position	Adj Scale
Factory Reset	Yes		
	No		
Exit			



The Image Control Clock and Clock Phase selections are not available when the monitor is operating in the DVI (digital) mode.

---

## Using the Auto Adjustment Function

You can easily optimize the screen performance for the VGA interface by using the Auto button and the auto-adjustment pattern software on the *User Guide* CD that came with this monitor.

1. Insert the provided CD-ROM disc into the computer.
2. Run the software file Adjustment pattern.exe (from the CD-ROM drive) to display a setup test pattern.
3. Press the Auto button on the monitor to produce a stable, centered image.

## Identifying Special OSD Messages

Special OSD messages appear on the monitor screen for the following monitor conditions:

- **Input Signal Out of Range** — Indicates the monitor is unable to access or fully support the provided input signal. The monitor's preferred video mode is 1920 x 1200 @ 60Hz.
- **Going to Sleep** — Indicates the monitor is entering a reduced power state or "sleep" mode.
- **Check Video Cable** — Indicates the video cable may not be plugged into the computer or monitor, or that the computer may not be turned on.
- **No Input Signal** — Indicates the monitor is not receiving a video signal from the PC or one of the five monitor signal connectors. Check to see if the PC or input signal source is off or in the power saving mode.
- **Multiple Inputs are active - Use the OSD to select the desired video input** — Indicates the monitor has more than one video input.

## Adjusting Screen Quality

Allow the monitor to warm up for 20 minutes before performing the following procedures.

The Auto Adjustment feature automatically fine-tunes the image quality each time a new video mode is utilized. If additional improvement is desired, select the Auto button on the front bezel.

For more precise adjustments, use the adjustment pattern provided on the CD-ROM, and adjust the clock and phase settings (accessed from the OSD menu) as described in the following section.

## Enhancing the Video Function

The monitor includes a zoom feature that allows you to adjust the viewable image to full screen display. It enhances video performance by changing the screen's aspect ratio, the ratio of the picture's width to its height, to get 4 to 3 (standard broadcast) and 16 to 9 (widescreen) formats. The zoom feature is available when the signal input selection is set to super video or component video.

To use the zoom feature:

1. Press the Input button on the front panel of the monitor to select one of the following video sources: S-video or Component Video.
2. Press the Menu button on the front panel of the monitor to launch the On Screen Display (OSD) Main Menu.
3. Select Image Control from the OSD Main Menu. When the Image Control menu opens, scroll down to select Image Zoom.
4. In the Image Zoom menu, use the OSD up and down buttons on the front panel to select and highlight the desired zoom setting:
  - Zoom Off — turns off the Image Zoom feature and defaults to the 1:1 format.
  - Zoom On 1 — optimizes the image for 4:3 format sources such as standard broadcast formats and the full screen DVD format.
  - Zoom On 2 — optimizes the image for 16:9 format sources such as widescreen broadcast and DVD format.



Some DVD wide screen modes may provide formats other than 16:9. When this occurs, black video borders may remain visible above and below the displayed image when Zoom On 2 is active.

---

5. When the desired zoom setting is highlighted, press the Menu button to confirm the selection. The OSD returns to the Image Control menu. Select the option to Cancel or Save the new zoom setting.
6. Press the Menu button and select Exit to close the Main Menu.

## Optimizing Digital Conversion

This monitor contains advanced circuitry that allows the flat panel screen to function like a standard monitor. Two controls in the OSD can be adjusted to improve image performance: Clock and Clock Phase. Use these controls only when the auto adjust function does not provide a satisfactory image.

---



The Clock must first be set correctly since the Clock Phase settings are dependent on the main Clock setting.

---

- Clock — Increase/decrease the value to minimize any vertical bars or stripes visible on the screen background.
  - Clock Phase — Increase/decrease the value to minimize video distortion or video jitter.
- 



When using the controls, you will obtain the best results by using the adjustment pattern provided on the CD-ROM.

---



When adjusting the Clock and Clock Phase values, if the monitor images become distorted, continue adjusting the values until the distortion disappears. To restore the factory settings, select Yes from the Factory Reset menu in the OSD.

---

## Using Video Connectors

The monitor includes the following video connectors for input from external video sources such as DVD players, VHS recorders, and external television tuners:

- S-video with composite video adapter included
- Component video

The monitor is compatible with NTSC, PAL, and SECAM video standards. Additionally, the component video connectors are capable of supporting the 480-line progressive (480p), the 720-line progressive (720p), and the 1080-line interlaced (1080i) High Definition Video modes when connected to an external HD video decoder.

## Composite to S-video Adapter

A Composite to S-video adapter is included with your monitor. Use the following steps to connect the adapter and improve the display quality:

1. Connect the video source composite connector into the Composite to S-video adapter.
2. Connect the S-video connector into the S-video In on your monitor.
3. Turn on the monitor.



4. Press the Input button to select S-video input.
5. If the display becomes distorted, press and hold the PIP button for at least 5 seconds until the display is corrected.



Repeat step 5 whenever the Input button is pressed, or the Factory Reset Function is activated.

---



---

# Troubleshooting

## Solving Common Problems

The following table lists possible problems, the possible cause of each problem, and the recommended solutions.

<b>Problem</b>	<b>Possible Cause</b>	<b>Solution</b>
Screen is blank or the No Input Signal message is displayed.	Power cord is disconnected.	Connect the power cord.
	Monitor power switch is turned off.	Press the power button.
	Video cable is improperly connected.	Connect the video cable properly. Refer to Chapter 3 "Setting Up the Monitor" for more information.
	Screen blanking utility is active or PC is in the power saving mode.	Depress any key on the keyboard or move the mouse to deactivate the screen blanking utility or exit the power saving mode.

---

<b>Problem</b>	<b>Possible Cause</b>	<b>Solution</b>
Image appears blurred, indistinct, or too dark.	Brightness and contrast are too low.	Press the Menu button to open the OSD Menu, and adjust the brightness and contrast as needed.
Image is not centered.	Image position may need adjustment.	Press the Menu button to access the OSD menu. Select Image Control to adjust the horizontal or vertical position of the image.
"Check Video Cable" is displayed on screen.	Monitor video cable is disconnected.	Connect the 15-pin monitor video cable to the VGA connector on the computer. Be sure that the computer power is off while connecting the video cable.
"Input Signal Out of Range" is displayed on screen.	Video resolution and/or refresh rate are set higher than what the monitor supports.	Restart your computer and enter Windows Safe Mode by pressing the F8 Function key when the computer starts to boot up. Change the video resolution or Refresh settings to a supported value. Restart the computer for the new settings to take effect.

## Getting Help Using the Worldwide Web

Before contacting customer services, refer to the support Web site at: <http://www.hp.com/support>

## Preparing to call Technical Support

If you cannot solve a problem using the troubleshooting tips in this section, you may need to call technical support. Have the following information available when you call:

- The monitor
- Monitor model number (on front and back panel)
- Serial number for the monitor (on back panel)
- Purchase date from invoice
- Conditions under which the problem occurred
- Error messages received
- Hardware configuration (found on Windows Control Panel)
- Computer hardware and software you are using



## Specifications

### f2304 Flat Panel Monitor

Display Type	23 inches Wide screen TFT LCD	58.4 cm
Viewable Image Size	23-inch diagonal	58.4 cm
Tilt	-5 to 20°	
Face Treatment	Anti-glare polarizer with hard coating	
Maximum Weight (unpacked)	20.9 lbs.	9.5 kg
Dimensions (includes pedestal)		
Height (maximum)	16.9 inches	428 mm
Depth	7.8 inches	197 mm
Width	25.3 inches	642 mm
Maximum Graphics Resolution	1920 x 1200 (60 Hz) digital input, Reduced Blanking Mode only 1920 x 1200 (60 Hz) analog input	
Text Mode	720 x 400	
Dot Pitch	0.258 x 0.258 mm	
Horizontal Frequency	30 to 94 KHz	
Vertical Refresh Rate	48 to 85 Hz	
Operating Temperature	41 to 95° F	5 to 35° C
Non-operating Temperature	-4 to +140° F	-20 to +60° C

# f2304 Flat Panel Monitor

Relative Humidity		
Operating	20 to 80%	
Non-Operating	5 to 95%	
Power Source		
	100 – 240 V $\surd$ 50 – 60 Hz	
Power Consumption	<100 watts	
Input Terminals	VGA 15-pin D-type connector with cable included. DVI-I connector with DVI-D cable included S-video connector with composite video adapter included Component Video	
Color Display Values		
CIE* Chromaticity Coordinates		
	x (+/-0.030)	y (+/- 0.030)
Red	0.640	0.332
Blue	0.146	0.065
Green	0.288	0.601
White Chromaticity		
(6500 K)	0.313	0.329
(9300 K)	0.283	0.297
Gamma: 2.2		

\* Commission Internationale d'Eclairage (CIE), 1931 Standard.

All performance specifications are provided by the component manufacturers. Performance specifications represent the highest specification of all HP's component manufacturers' typical level specifications for performance and actual performance may vary either higher or lower.



## Recognizing Preset Display Resolutions

The HP f2304 High Definition 23" LCD Monitor supports the display resolution modes listed in the table below. Some of these modes may not be available from the video graphics system used in the computer. Preset modes 20, 22 and 24 supports the f2304 monitor using only the VGA signal input. If using a DVI signal input, these preset modes will not properly display although the operating system and video graphics card may indicate these modes are supported. Using modes 20, 22 and 24 with a DVI signal may not display images properly on the screen. If changing resolution modes does not display images properly, do not touch your keyboard and 15 seconds later your settings will revert to the previous resolution mode.

Preset mode 23, 1920 x 1200, is a new video resolution mode developed for digital monitors that support DVI signal input using reduced blanking techniques. Before selecting this new video mode on the f2304 monitor and to avoid images not displaying properly, refer to the documentation that comes with the video graphics system to confirm if the system supports this 1920 x 1200 reduced blanking mode. If your digital graphics card provides the 1920 x 1200 digital resolution using a single DVI connector, then the reduced blanking mode is supported.

<b>Preset</b>	<b>Pixel Format</b>	<b>Horz Freq (kHz)</b>	<b>Vert Freq (Hz)</b>	<b>Pixel Clk (MHz)</b>	<b>Standard</b>
1	640 x 480	31.47	59.94	25.175	VGA
2	640 x 480	37.50	75.00	31.500	VGA
3	720 x 400	31.47	70.08	28.321	VGA
4	800 x 600	37.88	60.32	40.000	VESA
5	800 x 600	46.88	75.00	49.500	VESA
6	832 x 624	49.72	74.55	57.283	MAC

<b>Preset</b>	<b>Pixel Format</b>	<b>Horz Freq (kHz)</b>	<b>Vert Freq (Hz)</b>	<b>Pixel Clk (MHz)</b>	<b>Standard</b>
7	1024 x 768	48.36	60.00	65.000	VESA
8	1024 x 768	60.02	75.03	78.750	VESA
9	1024 x 768	68.68	85.00	94.500	VESA
10	1152 x 720	44.86	60.00	66.750	CVT 083MA DVT 16:10
11	1152 x 870	68.68	75.06	100.000	MAC
12	1152 x 900	61.80	65.96	92.978	SUN
13	1280 x 768	47.396	60.0	68.25	CVT 0.98M9-R
14	1280 x 960	60.00	60.00	108.000	VESA
15	1280 x 1024	63.98	60.02	108.000	VESA
16	1280 x 1024	79.98	75.02	135.000	VESA
17	1280 x 1024	91.15	85.02	157.500	VESA
18	1600 x 1000	61.648	60.00	108.50	CVT 1.60MA-R
19	1600 x 1200	75.00	60.00	162.000	VESA
20	1600 x 1200	93.80	75.00	202.500	VESA
21	1680 x 1050	65.29	60.00	146.250	CVT 1.76MA
22	1920 x 1080	67.158	60.00	173.00	CVT2.07M9 DVT 16:9
23	1920 x 1200	74.04	60.00	154.000	CVT 2.30MA-R
24	1920 x 1200	74.56	60.00	193.250	CVT 2.30MA



Display modes 20, 22, and 24 are supported by the analog signal input only; Digital video does not support these modes.

---

## LCD Monitor Quality and Pixel Policy for f2304 Monitor

The HP f2304 monitor uses high-precision technology manufactured according to HP standards, to guarantee trouble-free performance. Nevertheless, the display may have cosmetic imperfections that appear as small bright or dark spots. This is common to all LCD displays used in products supplied by all vendors and is not specific to the HP f2304 displays. These imperfections are caused by one or more defective pixels or sub-pixels.

- A pixel consists of one red, one green, and one blue sub-pixel.
- A defective whole pixel is always turned on (a bright spot on a dark background), or it is always off (a dark spot on a bright background). The first is the more visible of the two.
- A defective sub-pixel (dot defect) is less visible than a defective whole pixel and is small and only visible on a specific background.

The HP display does not have more than:

- 5 total defects — combination of full pixel and sub-pixel defects
- 3 defective bright sub-pixels
- 5 defective dark sub-pixels
- Bright dots must have a 15 mm minimum separation
- Bright dot to dim dot must have a 5 mm minimum separation
- Dim dot to dim dot must have 5 mm minimum separation

To locate defective pixels, the monitor should be viewed under normal operating conditions and in normal operating mode at a supported resolution and refresh rate, from a distance of approximately 16 inches (50 cm).

HP expects that, over time, the industry will continue to improve its ability to produce displays with fewer cosmetic imperfections and HP will adjust guidelines as improvements are made.

## Entering User Modes

The video controller signal may occasionally call for a mode that is not preset if:

- You are not using a Hewlett-Packard standard graphics adapter.
- You are not using a preset mode.

If this occurs, you may need to readjust the parameters of the monitor screen by using the on-screen display. Your changes can be made to any or all of these modes and saved in memory. The monitor automatically stores the new setting, then recognizes the new mode just as it does a preset mode. In addition to the 24 factory preset modes, there are four user modes that can be entered and stored.

## Using the Energy Saver Feature

When the monitor is in its normal operating mode, the monitor uses less than 100 watts of power and the Power light is green.

The monitor also supports a reduced power state. The reduced power state will be entered into if the monitor detects the absence of either the horizontal sync signal and/or the vertical sync signal. Upon detecting the absence of these signals, the monitor screen is blanked, the backlight is turned off, and the Power light is turned amber. When the monitor is in the reduced power state, the monitor will utilize less than 3 watts of power. There is a brief warm-up period before the monitor will return to its normal operating mode.

Refer to your computer manual for instructions on setting energy saver features (sometimes called power management features).



The above energy saver feature only works when connected to computers that have energy saver features.

---

By selecting settings in the monitor's Energy Saver utility, you can also program the monitor to enter into the reduced power state at a predetermined time. When the monitor's Energy Saver utility causes the monitor to enter the reduced power state, the Power light blinks amber.



---

## Agency Regulatory Notices

### Federal Communications Commission Notice

This equipment has been tested and found to comply with the limits for a Class B digital device, pursuant to Part 15 of the FCC Rules. These limits are designed to provide reasonable protection against harmful interference in a residential installation. This equipment generates, uses, and can radiate radio frequency energy and, if not installed and used in accordance with the instructions, may cause harmful interference to radio communications. However, there is no guarantee that interference will not occur in a particular installation. If this equipment does cause harmful interference to radio or television reception, which can be determined by turning the equipment off and on, the user is encouraged to try to correct the interference by one or more of the following measures:

- Reorient or relocate the receiving antenna.
- Increase the separation between the equipment and the receiver.
- Connect the equipment into an outlet on a circuit different from that to which the receiver is connected.
- Consult the dealer or an experienced radio or television technician for help.

## **Modifications**

The FCC requires the user to be notified that any changes or modifications made to this device that are not expressly approved by Hewlett-Packard may void the user's authority to operate the equipment.

## **Cables**

Connections to this device must be made with shielded cables with metallic RFI/EMI connector hoods to maintain compliance with FCC Rules and Regulations.

## **Declaration of Conformity for Products Marked with FCC Logo, United States Only**

This device complies with Part 15 of the FCC Rules. Operation is subject to the following two conditions: (1) this device may not cause harmful interference, and (2) this device must accept any interference received, including interference that may cause undesired operation.

For questions regarding your product, contact:

Hewlett-Packard  
P.O. Box 692000, Mail Stop 530113  
Houston, Texas 77269-2000

Or, call 1-800- 652-6672 (1-800-OK COMPAQ)

For questions regarding this FCC declaration, contact:

Hewlett-Packard  
P.O. Box 692000, Mail Stop 510101  
Houston, Texas 77269-2000

Or, call (281) 514-3333



To identify this product, refer to the Part, Series, or Model number found on the product.

## Canadian Notice

This Class B digital apparatus meets all requirements of the Canadian Interference-Causing Equipment Regulations.

## Avis Canadien

Cet appareil numérique de la classe B respecte toutes les exigences du Règlement sur le matériel brouilleur du Canada.

## European Notice

Products with the CE Marking comply with both the EMC Directive (89/336/EEC) and the Low Voltage Directive (73/23/EEC) issued by the Commission of the European Community.

Compliance with these directives implies conformity to the following European Norms (in brackets are the equivalent international standards):

- EN55022 (CISPR 22) – Electromagnetic Interference
- EN55024 (IEC61000-4-2,3,4,5,6,8,11) – Electromagnetic Immunity
- EN61000-3-2 (IEC61000-3-2) – Power Line Harmonics
- EN61000-3-3 (IEC61000-3-3) – Power Line Flicker
- EN60950 (IEC950) – Product Safety

## Japanese Notice

この装置は、情報処理装置等電波障害自主規制協議会（VCCI）の基準に基づくクラスB情報技術装置です。この装置は、家庭環境で使用することを目的としていますが、この装置がラジオやテレビジョン受信機に近接して使用されると、受信障害を引き起こすことがあります。

取扱説明書に従って正しい取り扱いをして下さい。

## Korean Notice

### B급 기기 (가정용 정보통신기기)

이 기기는 가정용으로 전자파적합등록을 한 기기로서  
주거지역에서는 물론 모든지역에서 사용할 수 있습니다.

## EPA Energy Star Compliance

Monitors that are marked with the Energy Star<sup>®</sup> Logo meet the requirements of the EPA Energy Star program. As an Energy Star Partner, Hewlett-Packard has determined that this product meets the Energy Star guidelines for energy efficiency. Specific details on using the Energy Saving features can be found in the energy saver or power management section of the computer manual.

## Power Cord Set Requirements

The monitor power supply is provided with Automatic Line Switching (ALS). This feature allows the monitor to operate on input voltages between 100-120V $\sim$  or 200-240V $\sim$ .

The power cord set (flexible cord or wall plug) received with the monitor meets the requirements for use in the country where you purchased the equipment.

If you need to obtain a power cord for a different country, you should purchase a power cord that is approved for use in that country.

The power cord must be rated for the product and for the voltage and current marked on the product's electrical ratings label. The voltage and current rating of the cord should be greater than the voltage and current rating marked on the product. In addition, the cross-sectional area of the wire must be a minimum of 0.75 mm<sup>2</sup> or 18AWG, and the length of the cord must be between 6 feet (1.8 m) and 12 feet (3.6 m). If you have questions about the type of power cord to use, contact your HP authorized service provider.

A power cord should be routed so that it is not likely to be walked on or pinched by items placed upon it or against it. Particular attention should be paid to the plug, electrical outlet, and the point where the cord exits from the product.

## HP Recycling Program

HP offers product end-of-life return programs for HP and other manufacturers' hardware in several geographic areas.

The terms and availability of these programs vary by geography because of differences in regulatory requirements and local customer demand. For information on the HP recycling program, refer to the HP Web site at: <http://www.hp.com/hpinfo/globalcitizenship/environment/recycle/hardware.html>

---

## TCO '99 Requirements



You have just purchased a TCO '99 approved and labeled product! Your choice has provided you with a product developed for professional use. Your purchase has also contributed to reducing the burden on the environment and to the further development of environmentally adapted electronics products.

*Why do we have environmentally labeled computers?*

In many countries/regions, environmental labeling has become an established method for encouraging the adaptation of goods and services to the environment. The main problem, as far as computers and other electronics equipment are concerned, is that environmentally harmful substances are used both in the products and during their manufacture. Since it is not so far possible to satisfactorily recycle the majority of electronics equipment, most of these potentially damaging substances sooner or later enter nature.

There are also other characteristics of a computer, such as energy consumption levels, that are important from the viewpoints of both the work (internal) and natural (external) environments. Since all methods of electricity generation have a negative effect on the environment (for example, acidic and climate-influencing emissions, radioactive waste), it is vital to save energy. Electronics equipment in offices is often left running continuously and thereby consumes a lot of energy.

*What does the environmental labeling involve?*

This product meets the requirements for the TCO '99 scheme which provides for an international and environmental labeling of personal computers. The labeling scheme was developed as a joint effort by the TCO (The Swedish Confederation of Professional Employees), Svenska Naturskyddsforeningen (The Swedish Society for Nature Conservation), Statens Energimyndighet (The Swedish National Energy Administration), and SEMKO AB.

The requirements cover a wide range of issues: environmental, ergonomic, usability, reduction of electric and magnetic fields, energy consumption, and electrical safety.

The environmental demands impose restrictions on the presence and use of heavy metals, brominated and chlorinated flame retardants, CFCs (freons) and chlorinated solvents, among other things. The product must be prepared for recycling, and the manufacturer is obliged to have an environmental policy which must be adhered to in each country/region where the company implements its operational policy.

The energy requirements include a demand that the computer and/or monitor, after a certain period of inactivity, shall reduce its power consumption to a lower level in one or more stages. The length of time to reactivate the computer shall be reasonable for the user.

Below, you will find a brief summary of the environmental requirements met by this product. The complete environmental criteria document may be ordered from:

TCO Development  
SE-114 94 Stockholm, Sweden  
Fax: +46 8 782 92 07

E-mail (Internet): [development@tco.se](mailto:development@tco.se)

Current information regarding TCO '99 approved and labeled products may also be obtained over the Internet, using the address:

<http://www.tco-info.com/>

## Environmental requirements

### *Flame retardants:*

Flame retardants are present in printed circuit boards, cables, wires, casings and housings. Their purpose is to prevent, or at least to delay, the spread of fire. Up to 30% of the plastic in a computer casing can consist of flame retardant substances. Most flame retardants contain bromine or chloride, and those flame retardants are chemically related to another group of environmental toxins, PCBs. Both the flame retardants containing bromine or chloride and the PCBs are suspected of giving rise to severe health effects, including reproductive damage in fish-eating birds and mammals, due to the bio-accumulative\* processes. Flame retardants have been found in human blood and researchers fear that disturbances in fetus development may occur.

The relevant TCO '99 demand requires that plastic components weighing more than 25 grams must not contain flame retardants with organically bound bromine or chlorine. Flame retardants are allowed in the printed circuit boards since no substitutes are available.

### *Cadmium:\**

Cadmium is present in rechargeable batteries and in the colour-generating layers of certain computer displays. Cadmium damages the nervous system and is toxic in high doses. The relevant TCO '99 requirement states that batteries, the color-generating layers of display screens and the electrical or electronics components must not contain any cadmium.

\* *Bio-accumulative is defined as substances which accumulate within living organisms. Lead, Cadmium and Mercury are heavy metals which are bio-accumulative.*

*Mercury:* \*

Mercury is sometimes found in batteries, relays and switches. It damages the nervous system and is toxic in high doses. The relevant TCO '99 requirement states that batteries may not contain any mercury. It also demands that mercury is not present in any of the electrical or electronics components associated with the labeled unit. There is however one exception. Mercury is, for the time being, permitted in the back light system of flat panel monitors as there today is no commercially available alternative. TCO aims on removing this exception when a mercury free alternative is available.

*CFCs (freons):*

The relevant TCO '99 requirement states that neither CFCs nor HCFCs may be used during the manufacture and assembly of the product. CFCs (freons) are sometimes used for washing printed circuit boards. CFCs break down ozone and thereby damage the ozone layer in the stratosphere, causing increased reception on earth of ultraviolet light with e.g. increased risks of skin cancer (malignant melanoma) as a consequence.

*Lead:* \*

Lead can be found in picture tubes, display screens, solders and capacitors. Lead damages the nervous system and in higher doses, causes lead poisoning. The relevant TCO '99 requirement permits the inclusion of lead since no replacement has yet been developed.

\* *Bio-accumulative is defined as substances which accumulate within living organisms. Lead, Cadmium and Mercury are heavy metals which are bio-accumulative.*



## Free Manuals Download Website

<http://myh66.com>

<http://usermanuals.us>

<http://www.somanuals.com>

<http://www.4manuals.cc>

<http://www.manual-lib.com>

<http://www.404manual.com>

<http://www.luxmanual.com>

<http://aubethermostatmanual.com>

Golf course search by state

<http://golfingnear.com>

Email search by domain

<http://emailbydomain.com>

Auto manuals search

<http://auto.somanuals.com>

TV manuals search

<http://tv.somanuals.com>