



# **Startup and Reference Guide**

## HP Notebook Series

Document Part Number: 335555-001

August 2003

### Part 1: Startup

The Startup part of this guide explains how to set up your notebook for the first time.

### Part 2: Reference

The Reference part of this guide explains how to identify and use the hardware and software features on your notebook.

# Contents

- 1 Startup**
- 2 System Components**
- 3 Keyboard**
- 4 Power**
- 5 Drives**
- 6 Multimedia**
- 7 Communications**
- 8 Hardware Options and Upgrades**
- 9 Software Updates, Restorations and Utilities**
- A Specifications**
- Index**

# Part 1

---

## Startup

This *Startup and Reference Guide* provides information about setting up and using your notebook.

- To set up your notebook hardware and software for the first time, follow the procedures in “Part 1: Startup”.
- To learn more about using your notebook, refer to “Part 2: Reference.” To find information about a specific topic:
  - Refer to the contents list on the first page of each chapter,  
or
  - Refer to the Index.

## Setting Up the Hardware

To set up the notebook for the first time, you need the notebook, the power cord ❶, the AC adapter ❷, and the battery pack ❸.

Insert the battery pack into the notebook, so that the battery can begin to charge as soon as the notebook is connected to external power. (Refer to the next section for details.)

Open the notebook, connect it to external power, and press the power button to turn on the notebook.

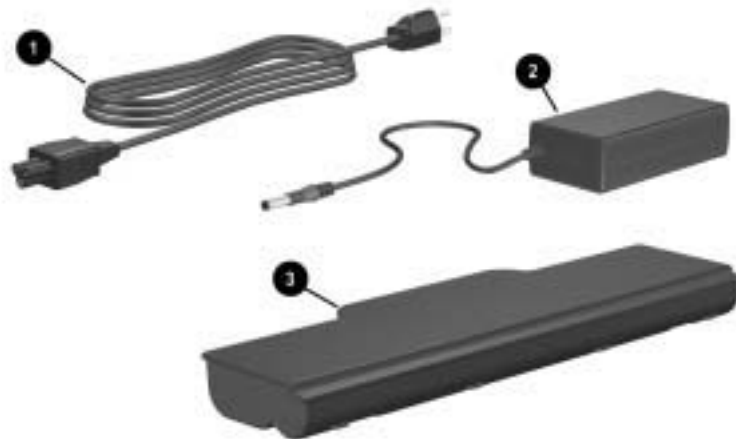

*Identifying the AC adapter, the power cord, and the battery pack  
(Power cords vary by region and country.)*

## Inserting a Battery Pack

To insert the battery pack into the battery bay:

1. Turn the notebook upside down on a flat surface.
2. Insert the alignment tab on the battery pack into the alignment slot on the notebook.
3. Tilt the battery pack downward until it snaps into place.

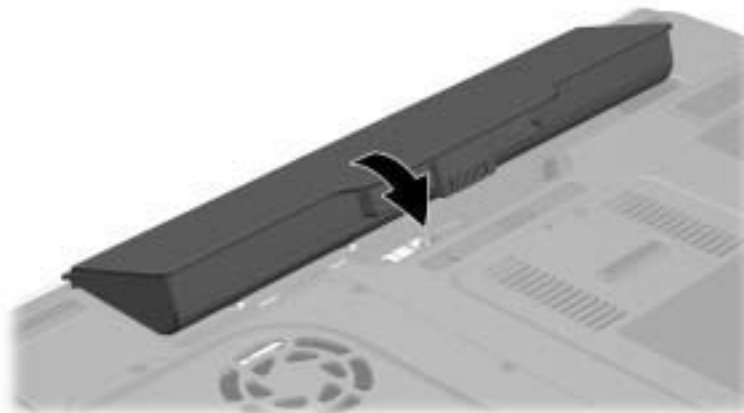

*Inserting a battery pack*



**CAUTION:** To ensure that the correct drivers load and to prevent file corruption or damage to components, do not remove the battery pack until the notebook has been connected to external power.

---

## Opening the Notebook

To open the notebook:

1. Place the notebook display-side up on a flat surface near an electrical outlet.
2. Slide the display release latch ❶, then lift the display ❷.

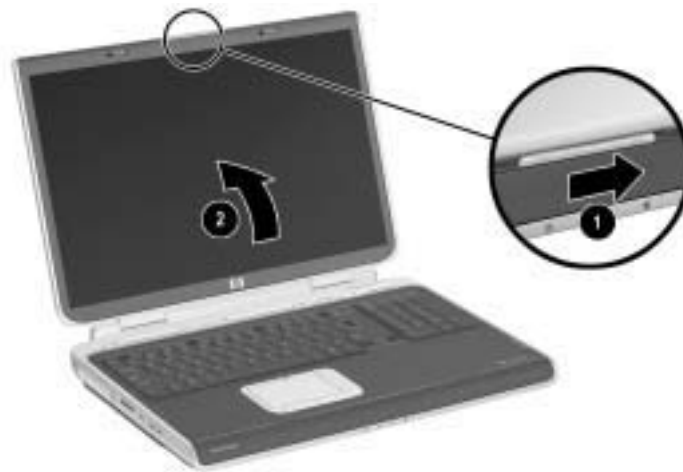

*Opening the notebook*

## Connecting the Notebook to External Power

To connect the notebook to external power:

1. Plug the AC adapter cable into the power connector ❶.
2. Plug the power cord into the AC adapter ❷, then into an electrical outlet ❸.

As soon as the notebook is connected to external power, the battery light turns on, and the battery pack begins to charge.



*Connecting the notebook to external power*

## Charging a New Battery Pack

The battery pack begins to charge as soon as the notebook is connected to external power. Charge status is indicated by the battery charge light.

The battery charge light is on while the battery pack is charging.

HP recommends that you leave the notebook connected to external power until the battery pack is fully charged and the battery charge light turns off.

A partially charged new battery pack can run the notebook, but battery charge displays will not be accurate until the new battery pack has been fully charged.



*Identifying the battery light*



## Turning On the Notebook

To turn on the notebook, press the power button. When the notebook turns on, the power/standby button lights up, the power/standby light turns on, and you are prompted to begin software setup.



*Turning on the notebook*

### If the Notebook Does Not Turn On

- Make sure that the AC adapter is securely plugged into an electrical outlet.
- Make sure that the outlet is providing power. (To confirm that the outlet is providing power, plug another device into the outlet.)
- If you have installed a battery pack, make sure that the battery pack is firmly seated.
- Refer to the *Worldwide Telephone Numbers* booklet included with the notebook to contact an HP Customer Care Center.

## Setting Up the Software

---



**CAUTION:** To prevent file corruption and ensure that the correct drivers are installed, install software only when the notebook is connected to external power through the AC adapter. During the installation:

- Do not unplug the notebook from external power.
  - Do not shut down the notebook or initiate Standby or Hibernation.
  - Do not insert, remove, connect, or disconnect any device, cable, or cord.
- 

## Installing Basic Software

When the notebook is connected to external power and turned on for the first time, a prompt to set up the operating system and other basic software is displayed on the screen.

Before responding to the prompt and proceeding through the on-screen instructions, read the following carefully and follow the installation instructions in this chapter.

- After beginning the software setup, you must complete the entire process without interruption. Setup time varies.
  - If you are prompted to select a language, choose carefully. On some models, the languages that you do not choose are deleted from the system and cannot be restored during the installation.
  - Regional settings and most other preferences can be selected or changed later, after the operating system is installed.
  - When you are prompted to accept the End User License Agreement, you must choose Accept to continue the software setup.
- 



During setup, it is normal for some notebook models to pause occasionally for up to 2 minutes and to restart several times. These pauses and restarts occur only during initial software setup. They will not occur during routine Windows startups.

---

## Installing Optional Software

Instructions for installing and using many of the applications and utilities included with the notebook are provided later in this guide. If you prefer to install optional software now, the following information may be helpful.

To install an application or a utility from a CD, refer to the instructions included with the CD. If printed instructions are not included in the CD package, they may be displayed on the screen when the CD is inserted.

To view or install preloaded utilities or applications, select Start > All Programs > Software Setup. Then:

- To display the descriptions and space requirements of a preloaded item without installing it, select the Next button, then select an item. After viewing the information, select the Cancel button.
- To install a preloaded item, select the check box for the item, select the Next button, then follow the instructions on the screen.

## Setting Regional and Display Preferences

Keyboard language and other regional preferences, such as time, date, and currency format, are set in the Regional Options window of the operating system. To access the Regional Options window, select Start > Control Panel > Date, Time, Language and Regional Options icon.

Screen appearance settings are accessed from the operating system Appearance and Themes window. To access the Appearance and Themes window, select Start > Control Panel > Appearance and Themes icon. To access the settings that control the size of the items displayed on the screen, select the Change Resolution task.

## Turning Off the Notebook

Turn off the notebook by using the Windows shutdown procedure. Select Start > Turn Off Computer > Turn Off.

If the notebook does not respond, try the following emergency shutdown procedures in the order below:

- Press **ctrl+alt+delete**, click the Shut Down button, then select Shut Down from the drop down list.
- Press and hold down the power button for at least 4 seconds.
- Unplug the notebook from external power and remove the battery pack. For instructions refer to “[Replacing a Battery Pack](#)” in Chapter 4.

## Using the Notebook Safely

### Protecting the Notebook Against Computer Viruses

When you use the notebook for email, network, or Internet access, you expose the notebook to computer viruses. Computer viruses can disable the operating system, your applications, or your utilities or cause them to function abnormally.

Antivirus software can detect most viruses, destroy them, and in most cases repair damage they have caused. To provide protection against newly discovered viruses, antivirus software must be updated.

For antivirus instructions and more information about virus updates, refer to the Help file within the application or select Start > Help and Support.

## Protecting the Notebook from Power Surges

To protect the notebook from the power surges that may be caused by an unreliable power supply or an electrical storm:

- Plug the notebook power cord into an optional, high-quality surge protector available from most computer or electronic retailers.
- Provide surge protection for the cable that connects the modem to the telephone jack.
- During an electrical storm, run the notebook on battery power or shut down the notebook and disconnect the power cord.

This equipment has been tested and found to comply with the limits for a Class B digital device, pursuant to part 15 of the FCC Rules. For more information, refer on the *Documentation Library* CD to the *Regulatory and Safety Notices*.



**WARNING:** To reduce the risk of electric shock or damage to your equipment:

- Plug the power cord into an electrical outlet that is easily accessible at all times.
  - Disconnect power from the product by unplugging the power cord from the electrical outlet.
  - If provided with a three-pin attachment plug on your power cable, plug the cable into a grounded (earthed) three-pin outlet. Do not disable the power cord grounding pin. The grounding pin is an important safety feature.
-



**WARNING:** To reduce the risk of serious injury, read the *Safety & Comfort Guide*. It describes proper workstation setup, posture, and health and work habits for computer users, and provides important electrical and mechanical safety information. This guide is located on the Web at <http://www.hp.com/ergo> and on the hard drive or on the *Documentation Library* CD that is included with the product.

---



**WARNING:** This notebook is designed to run demanding applications at full power. As a result of increased power consumption, it is normal for the notebook to feel warm or hot when used continuously. To avoid potential discomfort or burns, do not block the air vents or use the notebook on your lap for extended periods. The notebook complies with the user-accessible surface temperature limits defined by the International Standard for Safety of Information Technology Equipment (IEC 60950).

---

## Getting Help

If you cannot solve a notebook problem by using this guide or the supplementary information, including the *Troubleshooting* guide, on the *Documentation Library* CD, you may need to contact HP.

## Using the Help and Support Center

Installed on your notebook desktop is the Help and Support Center that provides a comprehensive online resource tool that can be used for the following:

- Troubleshooting assistance
- Downloading the latest driver updates and product information
- Learning more about using and maintaining your notebook

With the Help and Support Center, you can get immediate assistance before contacting an HP support specialist. For example, in Help and Support, you can:

- Troubleshoot and fix common notebook problems.
- Learn how to use the software tools for working with your favorite music, video, games, and photos (select models).
- Get basic and detailed information about Windows XP for customizing your notebook.
- Set up your notebook for networking and for communicating on the Web.
- Use administration tools to manage areas such as passwords, file backups, system restore, and user accounts.
- Learn how to print, fax, run performance and maintenance tools, and install and configure new hardware.
- Protect your notebook files by using security and privacy features such as Norton AntiVirus software.
- Undo changes to your notebook with System Restore.
- Improve performance of your hard drive and battery pack.
- Download the latest drivers, utilities, software updates, and product documentation for your notebook.
- Use Tools to view notebook information and diagnose problems.
- Keep your notebook up-to-date using Windows Update.
- Find compatible hardware and software.

To access the online Help and Support Center:

1. Press the **fn+f1** hotkey or select Start > Help and Support.
2. Follow the on-screen directions to select the online Help and Support Center feature that you need.



## Contacting Technical Support

If you cannot solve a problem using the Help and Support Center installed on your notebook or the documentation provided with your notebook, you can call technical support.

To obtain a list of worldwide customer support telephone numbers, use either of the following methods:

- Select Start > Control Panel > Performance and Maintenance icon > System icon. Then, near the lower edge of the System Properties window, select the Support Information button.
- Refer to the *Worldwide Telephone Numbers* booklet included with the notebook to contact an HP Customer Care Center.

To provide the fastest possible resolution of your problem, have the notebook and the following information available when you call:

- Notebook serial number and model description, which are provided on labels affixed to the bottom of the notebook.
- Purchase date, as marked on your sales receipt/invoice.
- Conditions under which the problem occurred.
- Error messages that have displayed.
- Manufacturer and model of any optional printer connected.
- Operating system version number and registration number.  
To view these numbers, select Start > Control Panel > System > General tab.
- Determine the version of the system ROM installed on the notebook.



# **Part 2**

# **Reference**

---

*Startup and Reference Guide—Part 2*



# 2

---

## System Components

### Contents

Display .....	2-2
Top .....	2-3
TouchPad .....	2-3
Keys .....	2-4
Power Controls .....	2-5
Lights .....	2-6
Audio Buttons .....	2-7
Front Panel .....	2-8
Rear Panel .....	2-9
Connectors and Jacks .....	2-9
Vents .....	2-10
Left Side .....	2-11
Connectors and Jacks .....	2-11
Vents .....	2-12
Right Side .....	2-13
Bottom .....	2-14
Bays and Memory Compartment .....	2-14
Vents .....	2-15
Labels .....	2-16
Additional Standard Components .....	2-17
Cables and Cord .....	2-17
Adapters and Battery Pack .....	2-18
Restoration and Documentation CDs .....	2-19

## Display

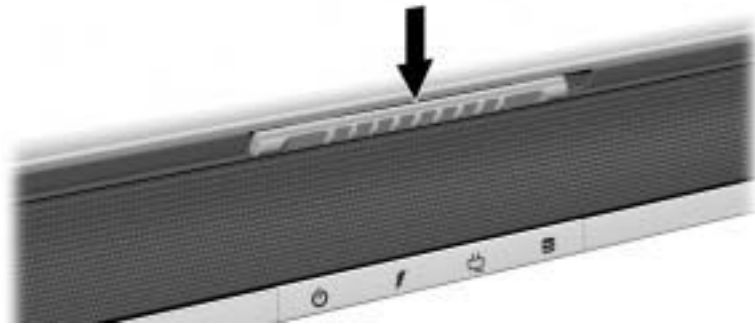

---

### Display

---

Display release latch

Opens the notebook.

---

## Top

### TouchPad

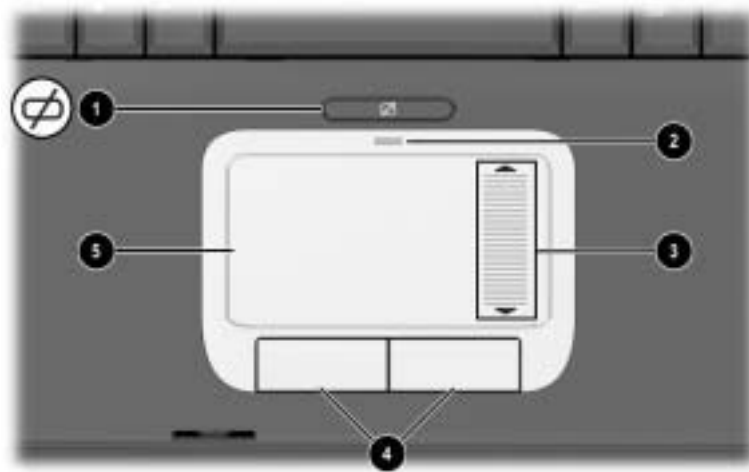

#### Top: TouchPad

❶	TouchPad on/off button	Enables/disables the TouchPad.
❷	TouchPad light	On: TouchPad is enabled.
❸	TouchPad scroll zone*	Scroll up or down.
❹	Left and right TouchPad buttons*	Function like the left and right buttons on an external mouse.
❺	TouchPad*	Moves the pointer and selects or activates items on the screen.

\*This table describes default settings. For information about changing the functions of TouchPad features, refer to “[Setting TouchPad Preferences](#)” in chapter 3.

## Keys

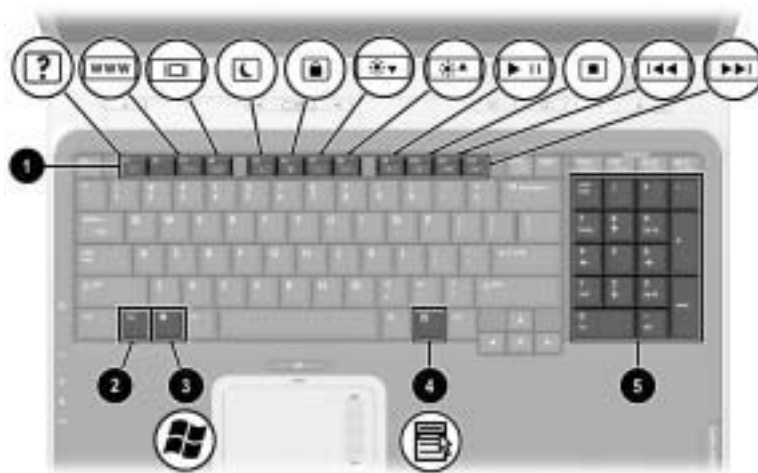

### Top: Keys

❶	Function keys	Perform system and application tasks. When combined with the <b>fn</b> key, the function keys <b>f1</b> and <b>f3</b> through <b>f12</b> perform additional tasks as hotkeys. Refer to the “Hotkey Quick Reference” section in chapter 3 for details.
❷	<b>fn</b> key	Combines with other keys to perform system tasks. For example, pressing <b>fn+f8</b> increases screen brightness.
❸	Microsoft logo key	Displays the Windows Start menu.
❹	Applications key	Displays a shortcut menu for items beneath the pointer.
❺	Keypad keys (17)	Standard numeric keypad.



## Power Controls



---

### Top: Power Controls

---

Power button*	<p>When the notebook is:</p> <ul style="list-style-type: none"><li>■ Off, press to turn on the notebook.</li><li>■ On, briefly press to initiate Hibernation.</li><li>■ In Standby, briefly press to resume from Standby.</li><li>■ In Hibernation, briefly press to restore from Hibernation.</li></ul> <p> If the system has stopped responding and Windows shutdown procedures cannot be used, press and hold for at least 4 seconds to turn off the notebook.</p>
---------------	--

---

\*This table describes default settings. For information about changing the function of the power button or display switch, refer to [“Managing Power Options”](#) in chapter 4.

---

## Lights



---

### Top: Lights

---

❶	Wireless On/Off light	On: An integrated wireless device has been enabled.
❷	Caps lock light	On: Caps lock is on.
❸	Num lock light	On: Num lock or the keypad is on.

---

## Audio Buttons



---

### Top: Audio Buttons

---

❶	Decrease volume button	Pressing the left side, decreases system volume.
❷	Mute button	Mutes or restores volume.
❸	Increase volume button	Pressing the right side, increases system volume.

---

## Front Panel

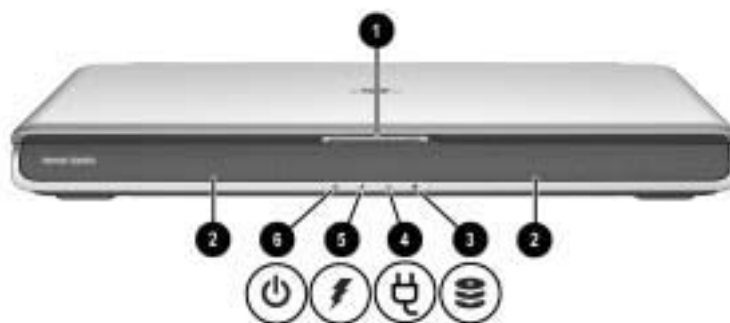

---

### Front Panel

❶	Display release latch	Opens the notebook.
❷	Stereo speakers (2)	Produce stereo sound.
❸	Hard drive activity light	On: The internal hard drive is being accessed.
❹	AC power light	On: The notebook is receiving AC power.
❺	Battery light	On: The notebook is receiving battery power. Flashing: A battery pack is malfunctioning and may need to be replaced.
❻	Power/standby light	On: Notebook is turned on. Flashing: Notebook is in Standby.

---

## Rear Panel

### Connectors and Jacks

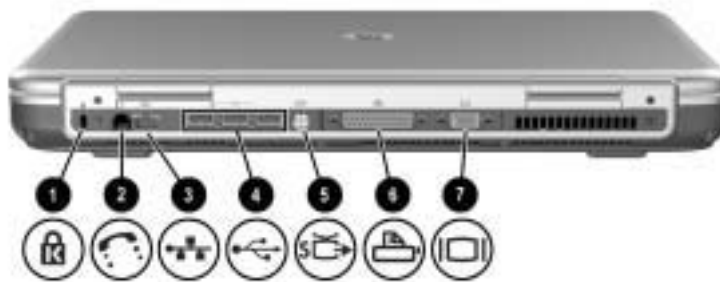

---

#### Rear Panel: Connectors and Jacks

---

①	Security cable slot	Attaches an optional security cable to the notebook.
②	RJ-11 telephone jack	Connects a modem cable. (A modem cable is included with select models.)
③	RJ-45 network jack	Connects an Ethernet network cable. (An Ethernet network cable is included with select models.)
④	USB connectors (3)	Connect optional 1.1 or 2.0-compliant USB devices.
⑤	S-Video jack	Connects an optional S-Video device, such as a television, VCR, camcorder, projector, or video capture card.
⑥	Parallel connector (available on select models)	Connects an optional parallel device such as a printer.
⑦	External monitor connector	Connects an optional VGA external monitor or projector.

---

## Vents

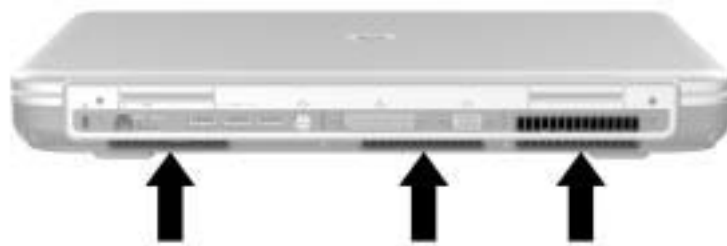

---

### Rear Panel: Vents

---

Exhaust vents

Provides airflow to cool internal components.

⚠ To prevent overheating, do not obstruct vents. Do not allow a hard surface, such as a printer, or a soft surface, such as a pillow, blanket, rug, or thick clothing, to block airflow.

---

## Left Side

### Connectors and Jacks



#### Left Side: Connectors and Jacks

❶	Power connector	Connects an AC adapter cable.
❷	Expansion port	Connects to an optional HP Notebook Expansion Base.
❸	USB connector	Connects an optional 1.1 or 2.0-compliant USB device.
❹	1394 connector	Connects an optional 1394 device, such as a camcorder.
❺	Microphone jack	Connects an optional monaural or stereo microphone.
❻	Audio line-out jack	Connects optional headphones or powered stereo speakers. Also connects the audio function of an audio/video device such as a television or VCR.

## Vents

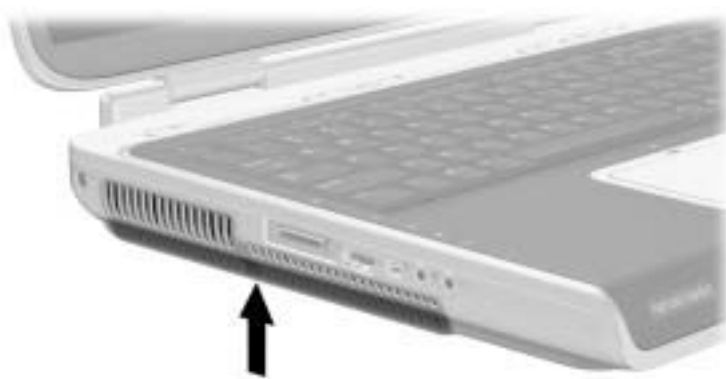

---

### Left Side: Vents

---

Exhaust vents

Provide airflow to cool internal components.

△ To prevent overheating, do not obstruct vents. Do not allow a hard surface, such as a printer, or a soft surface, such as a pillow, blanket, rug, or thick clothing, to block airflow.



## Right Side



### Right Side

①	Infrared port	Provides wireless communication between the notebook and an optional IrDA-compliant device.
②	Digital Media slot	Supports SD, MMC, Memory Stick, and SmartMedia.
③	Optical drive release button	Opens the optical drive.
④	Optical drive*	Supports an optical disc.
⑤	PC Card eject button	Ejects an optional PC Card from the PC Card slot.
⑥	PC Card slot	Supports an optional Type I, Type II, or Type III 32-bit (CardBus) or 16-bit PC Card.

\*The type of optical drive, such as a CD, DVD, or combination CD/DVD drive, varies by model.

## Bottom

### Bays and Memory Compartment

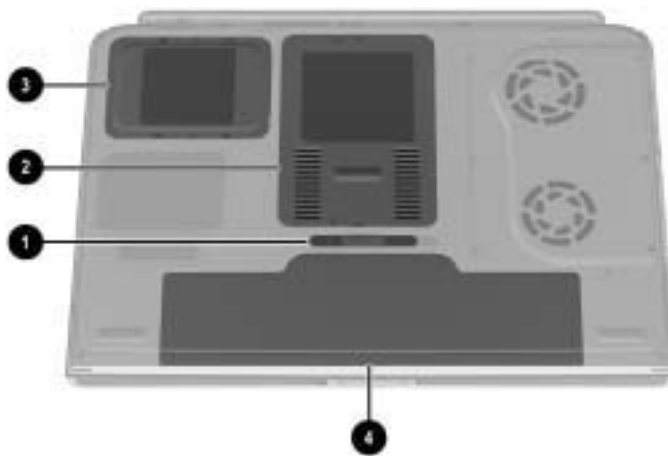

---

#### Bottom: Bays and Memory Compartment

---

❶	Battery pack release latch	Releases a battery pack from the battery bay.
❷	Memory compartment	Contains 2 memory slots. Depending on the model, when the notebook is shipped either one or both memory slots may be filled with a replaceable memory module.
❸	Hard drive bay	Holds the internal hard drive.
❹	Battery bay	Holds a battery pack.

---

## Vents

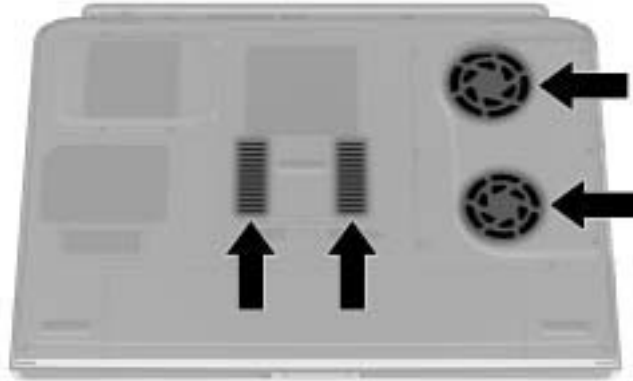

---

### Bottom: Vents

Intake vents

Provide airflow to cool internal components.

△ To prevent overheating, do not obstruct vents. Do not allow a hard surface, such as a printer, or a soft surface, such as a pillow, blanket, rug, or thick clothing, to block airflow.

---

## Labels

The labels affixed to the notebook and some notebook components provide information you may need when troubleshooting system problems or traveling internationally with the notebook.

- The Microsoft Certificate of Authenticity label contains the Product Key number. You may need this number to update or troubleshoot problems with the operating system.
- The system label provides regulatory information about the notebook.
- The product identification label contains the serial number of the notebook and a code describing the original configuration of the notebook. You will need the notebook serial number if you call customer support.
- The modem approvals label, which is affixed to an optional internal modem, provides regulatory information.
- Wireless certification labels, which are specific to various types of optional wireless devices provide regulatory information and lists the countries in which this optional wireless device has been approved for use.

## Additional Standard Components

The components included with the notebook vary by region, country, notebook model, and the optional hardware ordered. The following sections identify the standard external accessories and components included with most notebook models.

### Cables and Cord



#### Additional Standard Components: Cables and Cord

①	Modem cable (included with select models)	Connects a modem to an RJ-11 telephone jack or to a country-specific modem adapter.  ✎ A modem cable has a 6-pin, RJ-11 telephone connector at each end.
②	Network cable (included with select models)	Connects the notebook to an Ethernet network jack.  ✎ A network cable has an 8-pin, RJ-45 network connector at each end.
③	Power cord*	Connects an AC adapter to an AC electrical outlet.

\*Power cords vary in appearance by region and country.

## Adapters and Battery Pack

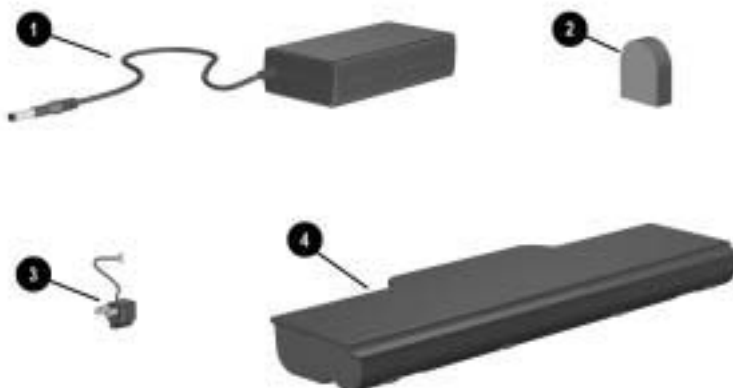

---

### Additional Standard Components: Adapters and Battery Pack

---

①	AC adapter	Converts AC power to DC power.
②	Country-specific modem adapter (included by region as required)	Adapts the modem cable to a non-RJ-11 telephone jack.
③	Japan-specific outlet adapter (Japan only)	Connects the AC adapter to a 2-prong electrical outlet.
④	Battery pack	Runs the notebook when the notebook is not connected to external power.

---

## Restoration and Documentation CDs

CDs for repairing or reinstalling software and for obtaining supplementary information about the notebook are included with the notebook.

- For information about restoring, repairing, or reinstalling software, refer to “[Software Updates, Restorations and Utilities](#).”
- For supplementary information about the notebook, refer to the *Documentation Library* CD. The *Documentation Library* CD provided with all models includes the following guides:
  - ❑ *Maintenance, Shipping and Travel Guide*
  - ❑ *Troubleshooting Guide*
  - ❑ *Modem and Networking Guide*
  - ❑ *Regulatory and Safety Notices*
  - ❑ *Safety & Comfort Guide*





### Contents

TouchPad . . . . .	3-2
Identifying TouchPad Components . . . . .	3-2
Using the TouchPad. . . . .	3-3
Setting TouchPad Preferences . . . . .	3-3
Using Hotkey and Shortcut Keys . . . . .	3-4
Identifying fn and Function Keys . . . . .	3-4
Hotkey and Shortcut Key Quick Reference . . . . .	3-5
Hotkey and Shortcut Key Procedures . . . . .	3-6
Hotkey and Shortcut Key Commands . . . . .	3-6
Keypad . . . . .	3-10
Quick Launch Buttons . . . . .	3-11
Using Custom Assignments and Schemes. . . . .	3-12

## TouchPad

### Identifying TouchPad Components

The TouchPad includes the following components:

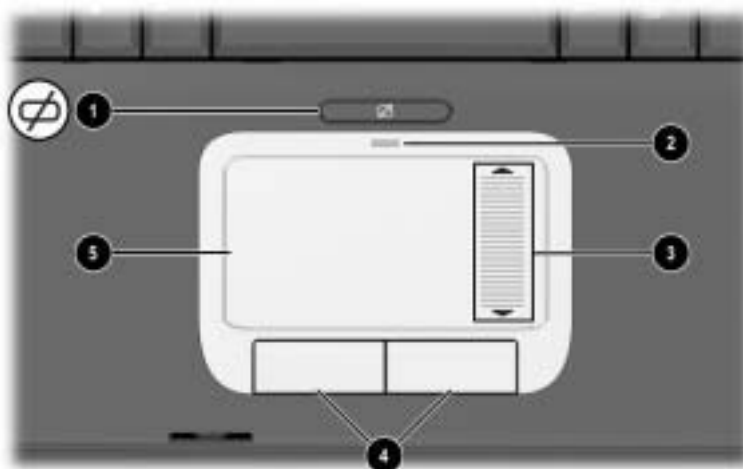

*Identifying TouchPad components*

Button name	Default assignment
❶ TouchPad on/off button	Enables/disables the TouchPad.
❷ TouchPad light	On: TouchPad is enabled.
❸ TouchPad scroll zone	Scroll up or down.
❹ Left and right TouchPad buttons	Function like the left and right buttons on an external mouse.
❺ TouchPad	Moves the pointer and selects or activates items on the screen.

## Using the TouchPad

The TouchPad provides the navigation, selection, and scroll functions of an optional external mouse.

- To move the pointer, slide your finger across the TouchPad surface in the direction you want to move the pointer.
- If the pointer continues to move after you lift your finger from the TouchPad surface, wait a few seconds and the pointer will stop moving.
- To execute the click functions of the left or right button on an external mouse, press the left or right TouchPad button.
- To scroll up or down, slide your finger up or down in the scroll zone.
- To enable or disable the TouchPad, press the TouchPad button. When the TouchPad is enabled, the TouchPad light is on.

The notebook turns on with the TouchPad enabled. Users who work with keystrokes rather than mouse actions may prefer to disable the TouchPad to prevent accidental TouchPad activity.

## Setting TouchPad Preferences

Pointer speed and shape, click speed, mouse trails, and other pointing device preferences are set in the operating system Mouse Properties window. To access Mouse Properties, select Start > Control Panel > Printers and Other Hardware > Mouse icon.

## Using Hotkey and Shortcut Keys

Hotkey and shortcut keys are preset combinations of the **fn** key with other keys on the keyboard.

- A hotkey is a combination of the **fn** key and one of the function keys.
- A shortcut key is a combination of the **fn** key and a key other than a function key.

## Identifying fn and Function Keys

The icons on the function keys **f1**, and **f3** through **f12** represent the hotkey functions available on the notebook.



*Identifying hotkeys*

Item	Component
❶	fn key
❷	Function keys

## Hotkey and Shortcut Key Quick Reference

The following table identifies the default hotkey and shortcut key functions.



For information about changing the function of the **fn+f5** hotkey, refer to the “[Managing Power Options](#)” section in chapter 4.

Default Function	Key combination
Display System information.	<b>fn+esc</b>
Open Help and Support window.	<b>fn+f1</b>
Open Microsoft Internet Explorer.	<b>fn+f3</b>
Switch display and image.	<b>fn+f4</b>
Initiate Standby.	<b>fn+f5</b>
Initiate QuickLock.	<b>fn+f6</b>
Decrease display brightness.	<b>fn+f7</b>
Increase display brightness.	<b>fn+f8</b>
Play, pause, or resume an audio CD or DVD.	<b>fn+f9</b>
Stop an audio CD or DVD.	<b>fn+f10</b>
Play the previous track or chapter on an audio CD or DVD.	<b>fn+f11</b>
Play the next track on an audio CD or DVD.	<b>fn+f12</b>

## Hotkey and Shortcut Key Procedures

To use a hotkey or shortcut key command on the notebook keyboard, use either of the following procedures:

- Briefly press the **fn** key, then briefly press the second key of the hotkeys command.
- Press and hold down the **fn** key, briefly press the second key of the hotkeys command, then release both keys at the same time.

## Hotkey and Shortcut Key Commands

### Display System Information (fn+esc)

Press **fn+esc** to display information about system hardware components and software version numbers. Press **fn+esc** a second time to remove the system information from the screen.



When viewing system information, the system BIOS date is the version number of the system ROM. The BIOS date may display in a decimal format, such as 10/19/2002 F.07.

---

### Open Help and Support Window (fn+f1)

The **fn+f1** hotkey opens the Help and Support Center. From the Help and Support Center, you can access general information about your notebook, links to software updates and online technical support specialists, and other support features.

For more information about the Help and Support window, refer to the [“Getting Help”](#) section in [“Startup.”](#)

### Open Internet Explorer (fn+f3)

The **fn+f3** hotkey opens Internet Explorer. After you have set up your Internet or network services and your Internet Explorer home page, you can use the **fn+f3** hotkey for quick access to your home page and the Internet.

## Switch Display (fn+f4)

The **fn+f4** hotkey switches the image between display devices connected to the external monitor connector or the S-Video jack on the notebook. For example, if an external monitor is connected to the notebook, pressing the **fn+f4** hotkey multiple times will toggle the image between the notebook display, the external monitor display, and a simultaneous display on both the notebook and the monitor.

Most external monitors receive video information from the notebook using the external VGA video standard. The **fn+f4** hotkey can also toggle images between other devices receiving video information from the notebook.

The following five video transmission types, with examples of devices that use them, are supported by the **fn+f4** hotkey:

- LCD (notebook display)
- External VGA (most external monitors)
- S-Video (televisions, camcorders, VCRs, and video capture boards with S-Video-in jacks)
- Composite video (televisions, camcorders, VCRs, and video capture boards with composite-video-in jacks)



Composite video devices can only be connected to the notebook when it is docked in an optional HP Notebook Expansion Base.

---

### **Initiate Standby (fn+f5)**

The **fn+f5** hotkey is set by default to initiate Standby. Standby can be initiated only while the notebook is on. If the notebook is in Hibernation, you must restore from Hibernation before you can initiate Standby.

To restore from Hibernation or resume from Standby, briefly press the power button. For more information about using Standby and Hibernation, refer to “Power.”

For information about changing the function of the **fn+f5** hotkey, refer in chapter 4 to the “Managing Power Options” section.

### **Initiate QuickLock (fn+f6)**

The **fn+f6** hotkey initiates the operating system QuickLock security feature. The QuickLock feature disables the keyboard and displays the log on screen. QuickLock does not disable the TouchPad.

Before you can use the QuickLock feature, you must set a Windows system password. For instructions, refer to your operating system documentation.

After you have set a Windows system password:

- To initiate QuickLock, press **fn+f6**.
- To exit QuickLock, enter your Windows system password.

### **Decrease Screen Brightness (fn+f7)**

The **fn+f7** hotkey decreases notebook screen brightness. Hold down the hotkey to decrease the brightness level incrementally.

### **Increase Screen Brightness (fn+f8)**

The **fn+f8** hotkey increases notebook screen brightness. Hold down the hotkey to increase the brightness level incrementally.



### **Play, Pause, or Resume an Audio CD or DVD (fn+f9)**

The **fn+f9** hotkey functions only when an audio CD or DVD is inserted. If the audio CD or DVD is:

- Not playing, press the **fn+f9** hotkey to begin or resume the play.
- Playing, press the **fn+f9** hotkey to pause the play.

### **Stop an Audio CD or DVD (fn+f10)**

The **fn+f10** hotkey stops the play of an audio CD or DVD that is playing.

### **Play Previous Track of an Audio CD or DVD (fn+f11)**

The **fn+f11** hotkey plays the previously played track of an audio CD or DVD that is playing.

### **Play Next Track of an Audio CD or DVD (fn+f12)**

The **fn+f12** hotkey plays the next track of an audio CD or DVD that is playing.

## Keypad

The keypad consists of 17 keys that can be used like the keys on an external keypad.



*Identifying the keypad keys*

## Quick Launch Buttons

The three Quick Launch buttons enable you to use one keystroke to access a software application or to activate a wireless network device.



*Identifying the Quick Launch buttons*

Button name	Default assignment
① Media button	Launches multimedia application.
② Picture button	Launches digital imaging application.
③ Wireless on/off button	Turns the wireless network device on and off.



The settings for the Quick Launch buttons can be changed. Refer to the next section for information on reassigning these buttons to other applications.

## Using Custom Assignments and Schemes

A Quick Launch button can be re-assigned to an Internet or network destination or to any software application or data file. For example, an Quick Launch button can be assigned to open your Internet browser to a favorite Web page or to open an application, such as Microsoft Word, or a document, such as an Excel worksheet, on a notebook or network drive.

Button assignments can be grouped into schemes. When you select a scheme, only the button assignments within that scheme are active. Button assignments and schemes are set up, changed, or deleted in the Quick Launch buttons window.

To program a Quick Launch button:

1. Select Start > All Programs > Utilities > Quick Launch.
2. On the Quick Launch tab, select the button you want to reprogram.
3. Type a label for the button, then select the application, document, folder, or Web site you want the button to open.

If you want a label to appear onscreen when you press a button, select that option on the Onscreen Display tab.

# 4

---

## Power

### Contents

Selecting a Power Source . . . . .	4-2
Understanding Standby, Hibernation and Shutdown . . . . .	4-3
Standby . . . . .	4-3
Hibernation . . . . .	4-4
Shutdown . . . . .	4-5
Initiating Standby, Hibernation or Shutdown . . . . .	4-6
When Leaving Your Work . . . . .	4-6
When External Power Supply is Uncertain . . . . .	4-6
When Using Infrared or Drive Media . . . . .	4-7
Using Default Power Settings . . . . .	4-8
Identifying Power Controls and Indicators . . . . .	4-8
Turning the Notebook or Display On or Off . . . . .	4-9
Using Emergency Shutdown Procedures . . . . .	4-10
Initiating or Resuming from Standby . . . . .	4-11
Initiating or Resuming from Hibernation . . . . .	4-12
Managing Power Options . . . . .	4-13
Using Battery Power . . . . .	4-16
Identifying the Power Lights . . . . .	4-16
Switching Between Battery and External Power . . . . .	4-17
Charging a Battery Pack . . . . .	4-17
Monitoring the Charge in a Battery Pack . . . . .	4-18
Managing Low-Battery Conditions . . . . .	4-19
Resolving Low-Battery Conditions . . . . .	4-20
Calibrating a Battery Pack . . . . .	4-21
Storing a Battery Pack . . . . .	4-24
Battery Conservation Settings . . . . .	4-25
Replacing a Battery Pack . . . . .	4-26
Disposing of a Used Battery Pack . . . . .	4-27

## Selecting a Power Source

The notebook can run on *internal* power from a battery pack or on *external* power from an AC adapter and other devices. The following table describes the best power source for general tasks.

Task	Recommended Power Source
Work in most software applications.	<ul style="list-style-type: none"> <li>■ Charged battery pack in the notebook</li> <li>■ External power supplied through the following devices:               <ul style="list-style-type: none"> <li><input type="checkbox"/> AC adapter</li> <li><input type="checkbox"/> Optional HP Notebook Expansion Base</li> </ul> </li> </ul>
Charge or calibrate a battery pack in the notebook.	External power supplied through: <ul style="list-style-type: none"> <li>■ AC adapter</li> <li>■ Optional HP Notebook Expansion Base</li> </ul>
Install or modify system software or write to a CD.	External power supplied through: <ul style="list-style-type: none"> <li>■ AC adapter</li> <li>■ Optional HP Notebook Expansion Base</li> </ul>



**WARNING:** This notebook is designed to run demanding applications at full power. As a result of increased power consumption, it is normal for the notebook to feel warm or hot when used continuously. To avoid potential discomfort or burns, do not block the air vents or use the notebook on your lap for extended periods. The notebook complies with the user-accessible surface temperature limits defined by the International Standard for Safety of Information Technology Equipment (IEC 60950).

## Understanding Standby, Hibernation and Shutdown

This section describes Standby, Hibernation, and shutdown and explains when to implement them. Standby and Hibernation are energy-saving features that can be initiated by you or by the system.

### Standby

Standby reduces power to system components that are not in use. When Standby is initiated, your work is saved in random access memory (RAM) and the screen is cleared.

- Saving your work before initiating Standby is not usually necessary, but is a recommended precaution.
- When the notebook is in Standby, the power/standby light flashes.

When you resume from Standby, your work returns to the screen where you left off.



**CAUTION:** To avoid a complete battery discharge, do not leave your notebook in Standby for extended periods. Connect to an external power source if your notebook will not be used for extended periods.

---



The system will not initiate from Standby through touchpad movement.

---

## Hibernation

Hibernation takes a snapshot of the current system memory, saves it to the hard drive, then shuts down the notebook. When you resume from Hibernation, your work returns to the screen exactly as you left it.

When possible, save your work before initiating Hibernation to prevent loss of data. Do not change the notebook configuration during Hibernation.



---

**CAUTION:** If the configuration of the notebook system is changed during Hibernation, it may not be possible to resume from Hibernation. When the notebook is in Hibernation:

- Do not add or remove memory modules.
  - Do not insert or remove the hard drive.
  - Do not connect or disconnect external devices.
  - Do not insert or remove a CD or DVD.
  - Do not insert a PC Card, SD Card, Memory Stick, Smart Media Card, or MMC.
- 

If you cannot resume from Hibernation when power is restored to the system, you will be prompted to delete the restoration data and proceed with system boot. Unsaved data will be lost. If a power-on password has been set, the password must be entered to resume from Hibernation.

Hibernation is enabled by default, but can be disabled. To reduce the risk of power loss during a low battery condition, users should disable Hibernation only during a battery pack calibration.



---

**CAUTION:** If Hibernation is disabled, the system does not automatically save your system memory if the notebook reaches a critical low-battery condition.

---



To verify that Hibernation is enabled, select Start > Control Panel > Performance and Maintenance > Power Options > Hibernate tab. Be sure that the Enable Hibernation check box is selected.



---

Hibernation will not be displayed as a power option in the Power Options window if it has been disabled.

---

## Shutdown

Shutdown procedures turn off the notebook. Whether to leave a battery pack in the notebook or in storage depends on how you work:

- Leaving the battery pack in the notebook enables the battery pack to charge whenever the notebook is connected to external power and also protects your work during a power outage.
- A battery pack in the notebook discharges more quickly, even when the notebook is turned off, than a battery pack that has been removed from the notebook and stored in a cool, dry location.

## Initiating Standby, Hibernation or Shutdown

The following sections describe when to initiate Standby or Hibernation and when to shut down your notebook.

### When Leaving Your Work

Initiate Standby for shorter times and Hibernation for longer times or for more power conservation.

The amount of time a battery pack can support Standby or Hibernation or hold a charge varies by notebook configuration and the condition of the battery pack.

- Initiating Standby clears the screen, uses less power than leaving the notebook on, and your work returns quickly to the screen when you resume from Standby. A fully charged new battery pack can typically support Standby for up to 48 hours.
- Initiating Hibernation clears the screen and uses much less power than Standby. Returning to work saved in Hibernation takes longer than returning to work saved in Standby, but is faster than returning to your place manually after restarting the notebook. A fully charged new battery pack can typically support Hibernation for several weeks.

To extend the life of the battery pack when the notebook will be disconnected from external power for an extended period, shut down the notebook, remove the battery pack, and store it in a cool, dry location.

### When External Power Supply is Uncertain

If an external power supply is uncertain, for example, because of an electrical storm, save your work, then initiate Hibernation or shut down the notebook.

## When Using Infrared or Drive Media

Standby and Hibernation interfere with the use of infrared communication and drive media.

- If the notebook is in Standby or Hibernation, you cannot initiate an infrared transmission.
- If Standby or Hibernation is accidentally initiated while drive media (such as a diskette, disk, CD, or DVD) is in use:
  - ❑ Your playback may be interrupted.
  - ❑ You may see a warning message: “Putting the computer into Hibernation or Standby may stop the playback. Do you want to continue?” Select No.
  - ❑ Resume from Hibernation or Standby by briefly pressing the power button.
  - ❑ Audio and video may resume, or you may need to restart the media.



**CAUTION:** Do not initiate Standby or Hibernation while using drive media. Doing so may result in video and audio degradation and loss of audio and video playback functionality.

---

## Using Default Power Settings

This section explains the default Standby, Hibernation, and shutdown procedures and includes information about turning the display on or off.

You can change many of these settings according to your preferences. If you want to change the default settings, refer to “Setting Power Options” later in this chapter.

## Identifying Power Controls and Indicators

Standby, Hibernation, shutdown, and display procedures use the following controls and indicators:

- ❶ Power button
- ❷ Initiate Standby hotkey (fn+f5)
- ❸ Power/standby light

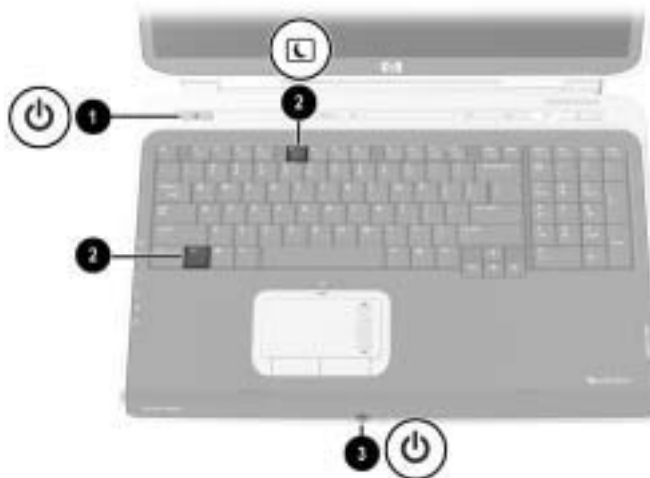

*Identifying Standby, Hibernation, shutdown, and display controls and indicators*

## Turning the Notebook or Display On or Off

Task	Procedure	Results
Turn on the notebook.	<p>Press the power button.</p> <p> Pressing the power button turns on the notebook from Standby, Hibernation, or shutdown.</p>	<ul style="list-style-type: none"> <li>■ The power/standby light turns on.</li> <li>■ The operating system loads.</li> </ul>
Shut down the notebook.*	<p>Save your work and close all open applications. Then:</p> <ul style="list-style-type: none"> <li>■ Press the power button and follow the onscreen instructions (if displayed) for shutting down the notebook.</li> <li>■ Shutdown the notebook through the operating system. Select Start &gt; Turn Off Computer &gt; Turn Off.</li> </ul>	<ul style="list-style-type: none"> <li>■ The power/standby light turns off.</li> <li>■ The operating system shuts down.</li> <li>■ The notebook turns off.</li> </ul>

\*If the system is unresponsive, and you are unable to shut down the notebook with this procedure, refer to the next section, [“Using Emergency Shutdown Procedures.”](#)

## Using Emergency Shutdown Procedures

If the notebook does not respond and you are unable to use normal Windows shutdown procedure, try the following emergency shutdown procedures in the sequence provided:

- Press **ctrl+alt+delete**. Select the Shut Down button, then select Shut down from the drop-down list.
- Press and hold down the power button for at least 4 seconds.
- Unplug the notebook from external power and remove the battery pack. For battery pack removal instructions, refer to the “[Replacing a Battery Pack](#)” section, later in this chapter.





**CAUTION:** Emergency shutdown procedures may result in the loss of unsaved data.

---

## Initiating or Resuming from Standby

Task	Procedure	Result
Initiate Standby	<p>With the notebook on, use either of the following procedures:</p> <ul style="list-style-type: none"> <li>■ Press the <b>fn+f5</b> hotkey.</li> <li>■ Select Start &gt; Turn off Computer &gt; Stand by.</li> </ul>	<ul style="list-style-type: none"> <li>■ The power/standby light flashes.</li> <li>■ The screen clears.</li> </ul>
Allow the system to initiate standby	<ul style="list-style-type: none"> <li>■ If the notebook is running on battery power, the system initiates standby after 10 minutes of notebook inactivity (default setting).</li> <li>■ If the notebook is running on external power, the system does not initiate standby.</li> <li>■ Power settings and timeouts can be changed in the Power Options window.</li> </ul>	<ul style="list-style-type: none"> <li>■ The power/standby light flashes.</li> <li>■ The screen clears.</li> </ul>
Resume from user-initiated or system-initiated Standby.	<ul style="list-style-type: none"> <li>■ Press the power button.</li> </ul>	<ul style="list-style-type: none"> <li>■ The power/standby light turns on.</li> <li>■ Your work returns to the screen.</li> </ul>

## Initiating or Resuming from Hibernation

Task	Procedure	Result
Initiate Hibernation	<p>With the notebook on, use either of the following procedures:</p> <ul style="list-style-type: none"> <li>■ Briefly press the power button.</li> <li>■ Select Start &gt; Shut Down &gt; Hibernate. (If the Hibernate option is not displayed, press and hold <b>shift</b>.)</li> </ul> <p> If the notebook is in Standby, you must resume from Standby before you can initiate Hibernation.</p>	<ul style="list-style-type: none"> <li>■ The power/standby light turns off.</li> <li>■ The screen clears.</li> </ul>
Allow the system to initiate Hibernation (with Hibernation enabled)	<ul style="list-style-type: none"> <li>■ If the notebook is running on battery power, the system initiates Hibernation after 30 minutes of notebook inactivity or when the battery pack reaches a critical low-battery condition.</li> <li>■ If the notebook is running on external power, the system will not initiate Hibernation.</li> <li>■ Power settings and timeouts can be changed in the Power Options window.</li> </ul>	<ul style="list-style-type: none"> <li>■ The power/standby light turns off.</li> <li>■ The screen clears.</li> </ul>
Resume from user-initiated or system-initiated Hibernation.	<p>Press the power button.</p> <p> If the system initiated Hibernation because of a critical low-battery condition, connect external power or insert a charged battery pack before you press the power button.</p>	<ul style="list-style-type: none"> <li>■ The power/standby light turns on.</li> <li>■ Your work returns to the screen.</li> </ul>



---

## Managing Power Options

Many of the default power settings, such as timeouts and alarms, can be changed in Power Options. For example, you can set an audio alert to warn you when the battery reaches a low-power condition.

By default, when the notebook is on:

- Briefly pressing the power button initiates Hibernation.
- Pressing the **fn+f5** hotkey, called the “sleep button” in the operating system, initiates Standby.
- The display switch turns off the display. The display switch is activated by closing the display.

### Accessing the Power Options Window

To change the function of the power button, the **fn+f5** hotkey, or the display switch:

1. Select Start > Control Panel > Performance and Maintenance icon > Power Options icon > Advanced tab.
  - ❑ To change the power button function, select a function from the drop-down list for When I Press The Power Button On My Computer.
  - ❑ To change the function of the **fn+f5** hotkey, select a function from the drop-down list for When I Press The Sleep Button On My Computer.
  - ❑ To change the display switch function, select a function from the drop-down list for When I Close The Lid Of My Portable Computer.
2. Select the OK button.



The Hibernate function is available in the power button, sleep button, and display switch drop-down lists only if Hibernation is enabled.

---

## Displaying the Power Meter Icon

The Power Meter icon changes shape to indicate whether the notebook is running on a battery pack or external power. Double-click the icon to display the Power Options window.

To hide or show the Power Meter icon on the taskbar:

1. Access the Power Options window.
2. Select the Advanced tab.
3. Select or clear the Always show icon on the taskbar check box.
4. Select the OK button.



If you cannot see an icon you have placed on the taskbar, the icon may be hidden. Select the arrow or vertical bar on the taskbar and expand it to view icons.

---

## Setting or Changing a Power Scheme

The Power Schemes tab in the Power Options window assigns power levels to system components. You can assign different schemes depending on whether the notebook is running on a battery pack or external power.

You can also set a power scheme that initiates Standby or turns off the display or hard drive after a time interval that you specify.

To set a power scheme:

1. Access the Power Options window > Power Schemes tab.
2. Select the power scheme you wish to modify, and adjust options in the lists on the screen.
3. Select Apply.

## **Using a Security Password**

You can add a security feature that prompts you for a password when the notebook turns on or resumes from Standby or Hibernation.

To set a password prompt, access the Power Options window > Advanced tab. Select the check box for Prompt For Password When the Computer resumes from Standby, and select OK.

## Using Battery Power

### Identifying the Power Lights

Battery pack procedures refer to the front panel lights:



*Identifying the battery and power/standby lights*

---

#### Top: TouchPad

---

❶	Power/standby light	On when the notebook has power.
❷	Battery light	<ul style="list-style-type: none"><li>■ On in the absence of AC power, when the notebook is running on battery power.</li><li>■ Flashing indicates that the battery pack is malfunctioning and may need to be replaced.</li></ul>
❸	AC power light	<ul style="list-style-type: none"><li>■ On when notebook is connected to AC power.</li><li>■ When AC power is available, the battery will charge.</li></ul>

---

## **Switching Between Battery and External Power**

The notebook switches between AC power and battery power according to the availability of an external AC power source, always preferring AC power. If the notebook contains a charged battery pack and is running on external AC power, the notebook will switch to battery power only if the AC adapter is disconnected from the notebook.

Keeping a battery pack in the notebook enables the battery pack to charge whenever the notebook is connected to external power and also protects your work in case of a power outage. On the other hand, a battery pack in the notebook slowly discharges even when the notebook is powered off.

To prolong battery life, remove and store the battery pack if you will not be using the notebook for 2 weeks or more. Refer to “Storing a Battery Pack” later in this chapter for details.

## **Charging a Battery Pack**

The battery pack charges whenever the notebook is connected to external power through an AC adapter.

The battery pack charges whether the notebook is turned off or turned on, but charges most quickly when the notebook is turned off. When the notebook is turned on, charging times are longer and vary with system activity.

## Monitoring the Charge in a Battery Pack

### Obtaining Accurate Charge Information

To increase the accuracy of all battery charge displays:

- Allow the battery pack to fully discharge before charging it.
- Charge the battery pack fully. Even a new battery pack can display charge information inaccurately if it has not been fully charged.
- Fully charging and discharging the battery pack will reduce the need for battery calibration.

### Displaying Charge Information

To display battery charge information on the screen, select Start > Control Panel > Performance and Maintenance icon > Power Options icon > Power Meter tab.

Power Meter displays battery status in both percent and time:

- The percent indicates the amount of charge remaining in the battery pack.
- The time indicates the approximate running time remaining on the battery pack *if the battery pack continues to provide power at the current level*. For example, the time remaining will decrease if you start playing a DVD and will increase if you stop playing a DVD.

## Managing Low-Battery Conditions

Some low-battery condition alerts and system responses can be changed in the Power Options window of the operating system. The information in this section describes the alerts and system responses set at the factory. Preferences set in the Power Options window do not affect lights.

### Identifying Low-Battery Conditions

This section explains how to identify low and critical battery conditions.

#### Low-Battery Condition

When a battery pack that is the sole power source for the notebook reaches a low-battery condition (5 percent of a full charge), the battery light blinks.

#### Critical Low-Battery Condition

If a low-battery condition is not resolved, the notebook enters a critical low-battery condition (3 percent of a full charge).

In a critical low-battery condition:

- If Hibernation is enabled and the notebook is on or in Standby, the notebook initiates Hibernation.
- If Hibernation is disabled and the notebook is on or in Standby, the notebook remains briefly in Standby, then shuts down and loses your unsaved work.

To verify that Hibernation is enabled, be sure that the Enable Hibernate Support check box on the Hibernate tab is selected. To access the tab select Start > Control Panel > Performance and Maintenance > Power Options icon.

## Resolving Low-Battery Conditions

---



**CAUTION:** If the notebook has reached a critical low-battery condition and has begun to initiate Hibernation, do not restore power until the Power/Standby light turns off.

---

### When External Power Is Available

To resolve a low-battery condition when external power is available, connect the AC adapter.

### When a Charged Battery Pack Is Available

To resolve a low-battery condition when a charged battery pack is available, turn off the notebook or initiate Hibernation, insert a charged battery pack, then turn on the notebook.

### When No Power Source Is Available

To resolve a low-battery condition when no power source is available, initiate Hibernation, or save your work and shut down the notebook.

### When the Notebook Cannot Exit Hibernation

To resolve a low-battery condition when the notebook lacks the power to exit Hibernation:

1. Insert a charged battery pack or connect external power.
2. Exit Hibernation by briefly pressing the power button.



## Calibrating a Battery Pack

### When to Calibrate

Even if a battery pack is heavily used, it should not be necessary to calibrate it more than once a month. It is not necessary to calibrate a new battery pack before first use. Calibrate the battery pack under the following conditions:

- When battery charge displays seem inaccurate.
- When you observe a significant change in battery run time.
- When the battery pack has not been used for one month or more.

### How to Calibrate

To calibrate a battery pack, you must fully charge, fully discharge, then fully recharge the battery pack.

### Charging the Battery Pack

Charge the battery pack while the notebook is in use. To charge the battery pack:

1. Insert the battery pack into the notebook. For instructions, refer to [“Replacing a Battery Pack”](#) later in this chapter.
2. Connect the notebook to external power. (The battery light is on as the battery pack charges.)
3. Leave the notebook connected to external power until the battery pack is fully charged. (The battery light turns off.)

### Discharging the Battery Pack

Hibernation is enabled by default, but can be disabled. Before you begin the full discharge, disable Hibernation. To disable Hibernation, select Start > Control Panel > Performance and Maintenance > Power Options > Hibernate tab. Then clear the Enable Hibernation check box.



**CAUTION:** If you plan to leave the notebook unattended during discharge, save your work before starting the discharge procedure.

---

To fully discharge the battery pack:

1. Select the power icon on the taskbar or select Start > Control Panel > Performance and Maintenance icon > Power Options icon > Power Schemes tab.
2. Record all settings in the Plugged In column and all settings in the Running On Batteries column, so you can reset them after calibration.
3. Use the drop-down lists to set each item in both columns to Never.
4. Select the OK button.
5. Disconnect the notebook from the external power source, but do not turn off the notebook.
6. Run the notebook on battery power until the battery pack is fully discharged. When the battery pack is fully discharged, the battery light turns off and the notebook shuts down.

If you use the notebook occasionally during the discharge procedure and have set energy-saving timeouts, expect the following performance from your system during the discharge process:

- The monitor will not turn off automatically.
- Hard drive speed will not decrease automatically while the notebook is idle.
- System-initiated Standby will not occur.

## Recharging the Battery Pack

1. Connect the notebook to external power and keep the notebook connected until the battery pack is fully recharged and the battery light turns off.

You can use the notebook while the battery pack is recharging, but the battery pack will charge faster if the notebook is turned off.

2. Select the Power icon on the taskbar or select Start > Control Panel > Performance and Maintenance icon > Power Options icon > Power Schemes tab.
3. Reenter the settings you recorded for the items in the Plugged In column and the Running on Batteries column.
4. Select the OK button.



**CAUTION:** After calibrating the battery pack, reenable Hibernation: select Start > Control Panel > Performance and Maintenance > Power Options > Hibernate tab, then select the Enable Hibernation check box.

---

## Storing a Battery Pack

If the notebook will be unused and unplugged for more than 2 weeks, remove and store the battery pack.



**CAUTION:** To prevent damage to a battery pack, do not expose it to high temperatures for extended periods of time.

---

High temperatures accelerate the self-discharge rate of a stored battery pack. To prolong the charge of a stored battery pack, keep it in a cool, dry place.

Use the following table to estimate how long you can safely store a battery pack. The storage times provided are based on a battery pack that contains 50 percent of a full charge. A fully charged battery pack can be safely stored longer.

Temperature Range °F	Temperature Range °C	Safe Storage Time
115°–140°	46°–60°	Less than 1 month
79°–113°	26°–45°	No more than 3 months
32°–77°	0°–25°	1 year

## Battery Conservation Settings

Using the following battery conservation settings and procedures extends the run time of a battery pack.

- Turn off wireless and local area network (LAN) connections and exit modem applications when you are not using them.
- Disconnect from the notebook any external devices that use power from the notebook. Battery run time is not affected by external devices that are plugged into an external power source.
- Stop or remove a PC Card you are not using. For more information, refer to the “Using a PC Card” section in Chapter 8.
- Disable or remove a Digital Media card (SD, MMC, Memory Stick, or SmartMedia) you are not using.
- Lower screen brightness.
- Lower system volume.
- Turn off a device connected to the S-Video jack.
- If you leave your work, initiate Standby or Hibernation or shut down the notebook.
- Select a short wait time, 5 minutes or less, for the monitor timeout. To change monitor timeout settings, select Start > Control Panel > Performance and Maintenance icon > Power Options icon > Power Meter tab. Select a short wait time from the Turn Off Monitor drop-down list, then select OK.

## Replacing a Battery Pack

---

 **CAUTION:** To prevent loss of work when removing a battery pack that is the only power source, initiate Hibernation or turn off the notebook before removing the battery pack.

---

To replace the battery pack:

1. Turn the notebook upside down.
  - ❑ To remove a battery pack, slide the battery release latch **1**. (The battery pack tilts upward.) Then pull the battery pack out of the battery bay **2**.

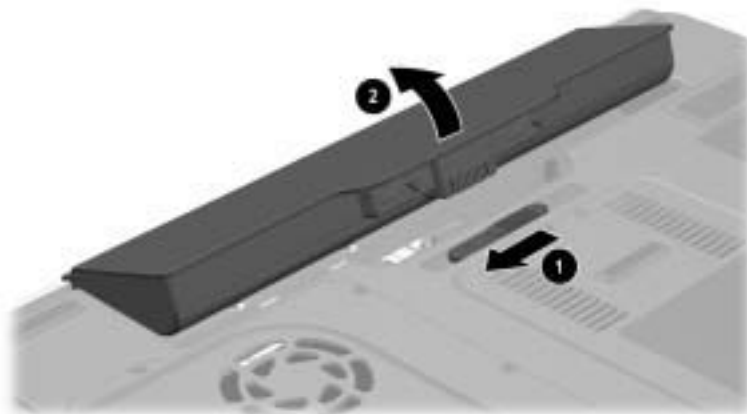

*Removing a battery pack*

- ❑ To insert a battery pack, insert the alignment tab on the battery pack into the alignment slot on the notebook, then tilt the battery pack downward until it snaps into place.

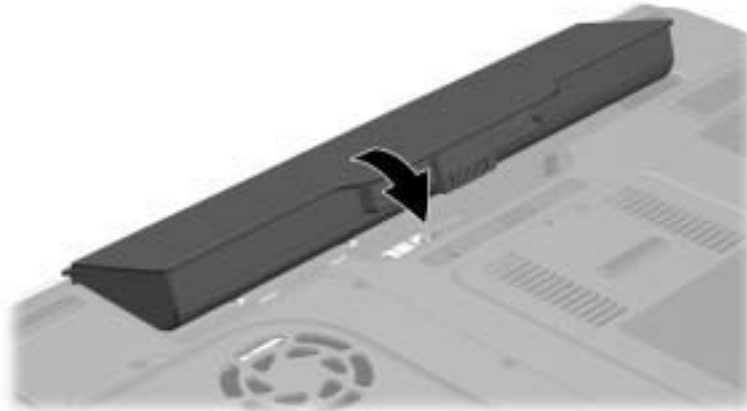

*Inserting a battery pack*

2. To restore from Hibernation or to turn on the notebook, press the power button.

## Disposing of a Used Battery Pack



For information about recycling or disposing of a used battery pack, refer on the *Documentation Library* CD to the *Regulatory and Safety Notices* guide.





# 5

---

## Drives

### Contents

Understanding Drives . . . . .	5-2
Adding a Drive to the System . . . . .	5-2
Types of Drives . . . . .	5-2
Caring for Drives . . . . .	5-3
Hard Drive . . . . .	5-4
Identifying the Hard Drive Activity Light . . . . .	5-4
Replacing the Internal Hard Drive . . . . .	5-5
Optical Drive . . . . .	5-8
Inserting an Optical Disc . . . . .	5-9
Removing an Optical Disc (With Power) . . . . .	5-10
Removing an Optical Disc (Without Power) . . . . .	5-11
Playing an Optical Disc . . . . .	5-12
Setting the Boot Order . . . . .	5-14

## Understanding Drives

The hard drive and optical (CD/DVD) drive are standard features of the notebook, but the optical drive features vary by model. Some notebooks include a diskette drive and/or a USB Digital drive.

## Adding a Drive to the System

Drives enable you to store and access data. An optional external drive can be added to the system by connecting it to one of the USB (Universal Serial Bus) or 1394 connectors on the notebook.

Additional data storage can be added with Digital Media including Secure Digital Card, Multimedia Card, Smart Media, and Memory Stick.

## Types of Drives

*Hard drives* are for the storage of data files and of software such as system files, applications, and drivers. A hard drive is sometimes called a *hard disk drive*.

*Optical drives* include CD and DVD drives. Optical drives support DVDs and/or CDs, often called *discs*, which are used to store or transport data and to play music and movies. DVDs have a higher capacity than CDs. The notebook can read or write to optical drives as described in the following table.

<b>Optical Drive</b>	<b>Read</b>	<b>Write</b>
DVD-ROM drive	Yes	No
DVD/CD-RW drive	Yes	Yes
DVD+RW	Yes	Yes

*Diskette drives* support *diskettes*, which are used to store or transport data. The notebook can read or write to any diskette. A diskette drive is sometimes called a *floppy disk drive*.

---

## Caring for Drives

Drives are fragile notebook components that must be handled with care. The following cautions apply to all drives. Additional cautions are included with the procedures to which they apply.



**CAUTION:** To prevent loss or damage to the notebook or a drive:

- Handle a drive carefully. Do not drop it.
- When inserting a drive, use only enough pressure to seat the drive. Excessive force can damage drive connectors.
- Do not spray a drive with a cleaner or other liquid or expose it to temperature extremes.
- Do not remove the primary hard drive (the hard drive in the hard drive bay) except for repair or replacement.
- Electrostatic discharge can damage electronic components. To prevent electrostatic damage to the notebook or a drive:
  - Discharge yourself from static electricity before handling a drive by touching a grounded metal object, and
  - Avoid touching the connectors on a drive. For more information about preventing electrostatic damage, refer to the *Regulatory and Safety Notices* on the *Documentation Library CD*.
- Avoid exposing a hard drive or a diskette to devices with magnetic fields. Security devices with magnetic fields include airport walk-through devices and security wands. The airport security devices that check carry-on luggage, usually while it is placed on a conveyor belt, use x-rays instead of magnetism and will not damage a hard drive or a diskette.
- If you mail a drive, ship it in packaging that protects it from shock, vibration, temperature, and high humidity. Label the package "FRAGILE."



**CAUTION:** To prevent damage to drive media:

- Do not open the metal shutter of a diskette or touch the disk within the diskette case.
  - Do not expose a diskette to a strong magnetic field, such as the security field used by a walk-through security device or a handheld security wand.
  - Clean a CD or DVD only with a disc cleaning kit, available from most electronics retailers.
-

## Hard Drive

This section discusses the primary hard drive of the notebook.

### Identifying the Hard Drive Activity Light

The hard drive activity light turns on when the internal hard drive is being accessed.



*Identifying the hard drive activity light*

## Replacing the Internal Hard Drive

The hard drive in the hard drive bay is the internal hard drive. Remove the internal hard drive only for repair or replacement.

**CAUTION:** To prevent an unresponsive system and loss of work, do not begin this procedure until you have:

- Saved your work, closed all open applications, and shut down the notebook.
- Disconnected the notebook from external power and removed the battery pack.

1. Save your work and close all open applications.
2. Shut down the notebook and close the display.
3. Disconnect the notebook from external power.
4. Remove the battery pack.
5. Turn the notebook upside down.
6. Remove the 4 hard drive retaining screws from the hard drive bay.

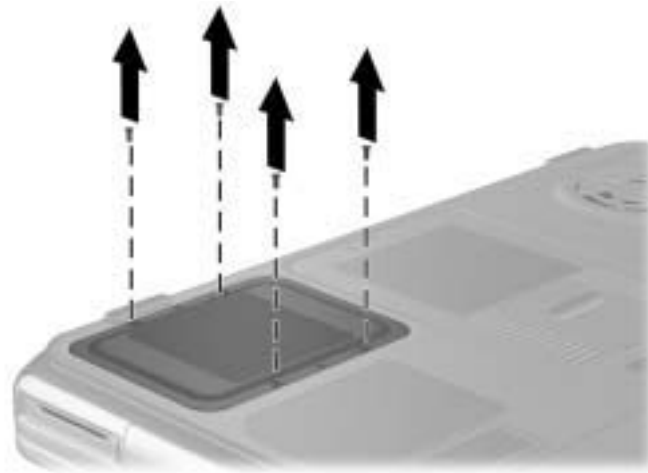

*Removing the hard drive retaining screws*

7. Remove the hard drive cover ❶.
8. Using the handle, unseat the hard drive by sliding the hard drive towards the edge of the notebook ❷, then remove it from the hard drive bay ❸.

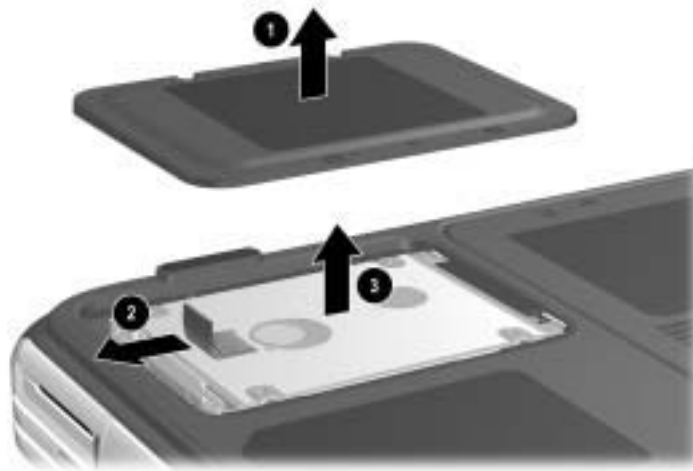

*Removing an internal hard drive*

9. To install a hard drive, lower the hard drive into the hard drive bay ❶, then slide the hard drive away from the notebook edge until it is fully seated ❷. Lower the hard drive cover onto the hard drive bay ❸.

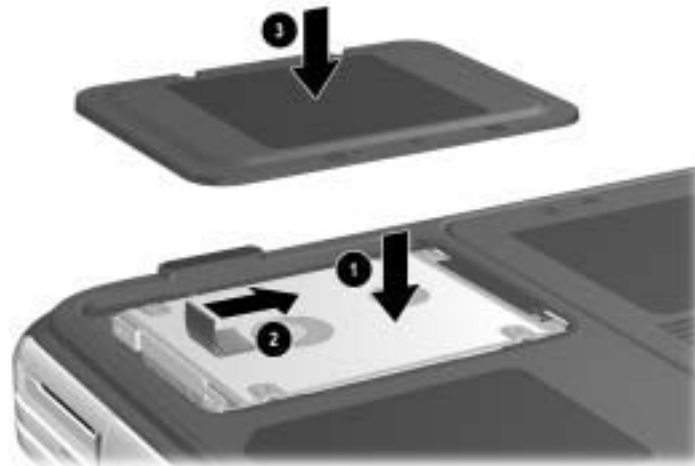

*Installing an internal hard drive*

10. If you have installed a hard drive, reinsert the 4 hard drive retaining screws. (If you removed but did not replace a hard drive, put the retaining screws in a safe place.)

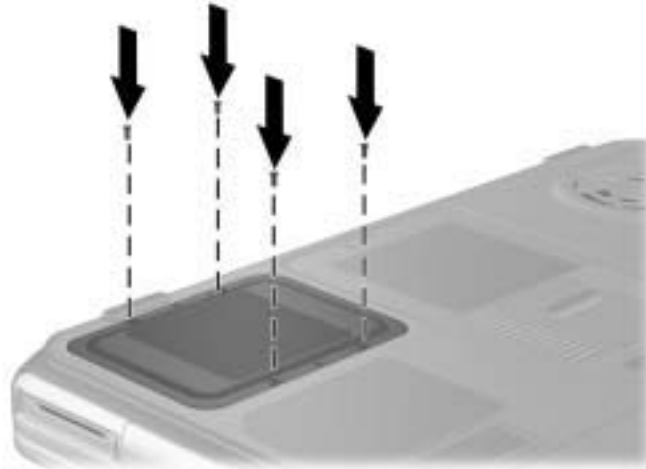

*Replacing the hard drive retaining screws*

## Optical Drive

---

 **CAUTION:** To avoid playback distortion or damage to optical media, stop the CD or DVD and exit media software before inserting or removing an optical drive.

---



## Inserting an Optical Disc

1. Turn on the notebook.
2. Press the release button ❶ on the drive bezel to release the media tray, then pull the tray outward until it is fully extended ❷.
3. Position a CD or one-sided DVD over the tray, label side up.
4. Gently press the center of the disc onto the tray spindle ❸ until the disc snaps into place. Handle the disc by the edges, not the flat surfaces. (If the media tray is not fully extended, tilt the disc to position it over the tray spindle, then press it down into position.)
5. Close the media tray ❹.



*Inserting an optical disc into the optical drive*

## Removing an Optical Disc (With Power)

1. Turn on the notebook.
2. Press the release button **1** on the drive bezel to release the media tray, then pull the tray outward until it is fully extended **2**.
3. Remove the disc from the tray by gently pushing down on the spindle while pulling up on the outer edges of the disc **3**. Handle the disc by the edges, not the flat surfaces. If the media tray is not fully extended, tilt the disc as you remove it.
4. Close the media tray.
5. Place the disc in a protective case.



*Removing an optical disc from the optical drive when power is available*

## Removing an Optical Disc (Without Power)

If the notebook is turned off or if no power is available, the release button on the optical drive will not work. To remove a disc from an optical drive without using the release button:

1. Insert a small object like the end of a paper clip into the release access ❶ in the front bezel of the drive.
2. Press gently on the paper clip until the media tray is released, then pull the tray out until it is fully extended ❷.
3. Remove the disc from the tray by gently pushing down on the spindle while pulling up on the outer edges of the disc ❸. Handle the disc by the edges, not the flat surfaces. If the media tray is not fully extended, tilt the disc as you remove it.
4. Place the disc in a protective case.



*Removing an optical disc from the optical drive when power is not available*

## Playing an Optical Disc

You can play a CD in a CD drive or a DVD drive. You can play a DVD only in a DVD drive.

The information in this section applies to most optical drives and most disc software. For information about specific disc software, including Windows Media Player, WinDVD, and Easy CD Creator, refer to “[Using Multimedia Software](#)” in chapter 6.

## Displaying Optical Disc Contents

When you insert a CD or DVD into the system, the notebook can play the medium, display its contents, take no action, or display a response prompt on the screen. You can choose how the notebook responds to the insertion of a medium by using the operating system AutoPlay feature.

When AutoPlay is enabled, in most cases your notebook responds to the following procedures as described:

- To prevent an audio CD from opening when AutoPlay is enabled on the drive containing it, press the **shift** key as you insert the CD.
- To display the contents of a drive medium when the contents are not displayed by AutoPlay:
  1. Insert the medium into the drive.
  2. Select Start > Run, then type:  
x:  
where x = the designation of the drive containing the disc.
  3. Press **enter**.

## Protecting Playback

---



**CAUTION:** Inserting or removing any device while running any multimedia application may pause or stop the play.

---



**CAUTION:** Initiating Standby or Hibernation while playing a drive medium may stop the play or diminish the quality of the play.

---

If Standby or Hibernation is accidentally initiated during playback:

- If you see the warning message “Putting the computer into Hibernation or Standby may stop the playback. Do you want to continue?” select No. (Audio and video may resume or you may need to restart the drive medium.)
- If Standby or Hibernation initiates and no warning message is displayed, resume from Hibernation or Standby by briefly pressing the power button, then restart the medium.

## Observing the Copyright Warning

It is a criminal offense, under applicable copyright laws, to make unauthorized copies of copyright-protected material, including computer programs, films, broadcasts, and sound recordings. This notebook should not be used for such purposes.

## Setting the Boot Order

By default, the notebook starts up from the internal hard drive. You can set the notebook to start up from any bootable CD or DVD in the optical drive. A bootable CD or DVD contains files needed by the notebook to start up and operate properly. On some models, you can also start up from a drive connected to the notebook by USB.

Startup preferences are set in the Setup utility. The Setup utility is not a Windows utility and does not support the TouchPad. For information about using the Setup utility, refer to the “[Using the Setup Utility](#)” section in Chapter 9.

# 6

---

## Multimedia

### Contents

Adjusting Volume .....	6-3
Using the Volume Buttons .....	6-3
Using the Volume Control .....	6-4
Using the Speakers .....	6-5
Connecting an Audio Device .....	6-5
Identifying the Audio Jacks .....	6-6
Using the Microphone Jack .....	6-7
Using the Audio Line-Out Jack .....	6-7
Connecting an S-Video Device .....	6-8
Connecting the Audio .....	6-8
Connecting the Video .....	6-8
Turning a Video Device On and Off .....	6-9
Changing the Color Television Format .....	6-9
Using Multimedia Software .....	6-10
Playing Audio and Video CDs with Windows Media Player .....	6-10
Playing Video CDs and DVDs with InterVideo WinDVD .....	6-11
Creating CDs with Roxio Easy CD & DVD Creator .....	6-13

Preparing to Use Easy CD & DVD Creator . . . . .	6-15
Formatting Recording Media. . . . .	6-16
Creating CDs . . . . .	6-17
Erasing Recorded Media with Roxio Easy CD & DVD Creator . . . . .	6-17
Selecting Easy CD & DVD Creator Settings . . . . .	6-18
Creating DVDs Using InterVideo WinDVD Creator. . . . .	6-19



## Adjusting Volume

Volume can be adjusted by using the audio buttons on the notebook or by using the volume control software. The mute button overrides all software volume settings.

### Using the Volume Buttons

To adjust volume using the audio buttons:

- To increase volume, press the increase volume button ③.
- To mute or restore volume, press the mute button ②.
- To decrease volume, press the decrease volume button ①.



*Identifying the audio buttons*

## Using the Volume Control

To place the volume control icon on the taskbar:

Select Start > Control Panel > Sounds, Speech, and Audio Devices > Sounds and Audio Devices icon > Volume tab.  
Select the Place volume icon in the task bar check box.

To adjust volume, click the volume control icon. To increase or decrease volume, select the slide bar and drag it up or down. To mute or restore volume, select or clear the Mute check box.



If you cannot see an icon you have placed on the taskbar, the icons may be hidden. Select the arrow or thick vertical bar on the taskbar and expand to view icons.

---

## Using the Speakers

The internal speakers play sound in stereo from applications, the operating system, games, drive media, the Internet, and other sources.



---

If an external device, such as a headset, is connected to the audio-out jack, the internal speakers are disabled.

---



*Identifying the internal speakers*

## Connecting an Audio Device



---

**WARNING:** To reduce the risk of personal injury, adjust the volume before putting on headphones or a headset.

---



---

**CAUTION:** To prevent possible damage to an external device, do not plug a monaural (single sound channel) plug into the audio-out jack.

---

## Identifying the Audio Jacks

The notebook has 2 audio jacks:

- The microphone jack ❶, sometimes called the *line-in* jack, connects an optional monaural or stereo microphone.
- The audio line-out jack ❷, sometimes called a *line-out* jack, connects headphones or external stereo speakers.



Identifying the audio jacks

## Using the Microphone Jack

When connecting a microphone to the microphone jack, use a monaural microphone with a 3.5-mm plug. A monaural electret condenser microphone is recommended.

- If you connect a stereo microphone, left channel sound will record on both channels.
- If you connect a dynamic microphone, the recommended sensitivity may not be achieved.

## Using the Audio Line-Out Jack

The audio-out jack is also used to connect the audio functions of an audio/video device such as a television or VCR.

When you connect a device to the audio-out jack:

- Use only a 3.5-mm plug.
- For best sound quality, use 24-ohm to 32-ohm headphones.
- The internal speakers are disabled.

## Connecting an S-Video Device

### Connecting the Audio

The S-Video jack supports video signals only.

If you are setting up a configuration that combines audio and video functions, such as playing a DVD movie on your notebook and displaying it on your television, you will need a standard 3.5-mm audio cable available from most computer or electronics retailers.

Plug the stereo end of the audio cable into the notebook audio-out jack. Plug the other end of the cable into the audio *input* jack on the external device.

### Connecting the Video

To transmit video signals through the S-Video jack, you will need a standard S-Video cable available from most computer or electronics retailers.

Plug either end of the S-Video cable into the notebook S-Video jack. Plug the other end of the cable into the S-Video *input* jack on the external device.

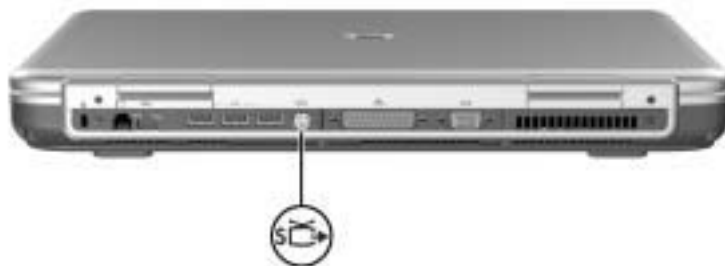

*Identifying the S-Video jack*

## Turning a Video Device On and Off

When an S-Video device is turned on, an image is displayed. When the device is off, an image is not displayed.

To turn on a video device that is connected to the notebook:

- Start or restart the notebook.
- Repeatedly pressing the **fn+f4** hotkey toggles the image between the notebook display, any connected external monitor, and simultaneous display of the notebook and connected monitor.
- Switching the image to a connected video device turns on the video device.
- Switching the image to the notebook display only turns off the video device.

The preceding methods for turning a video device on and off are interchangeable. If you turned off a connected device in Windows, for example, you can turn on the device by either restarting the notebook or pressing the **fn+f4** hotkey.



To conserve power, turn off the device before disconnecting the device from the system.

---

## Changing the Color Television Format

Color television formats are modes by which television video signals are sent and received. To send signals between the notebook and a television, both the notebook and the television must be using the same color television format.

The NTSC format is common in the United States, Canada, Japan, and South Korea. The PAL format is common in Europe, China, Russia, and Africa, and the PAL-M format is common in Brazil. Other South American and Central American countries may use NTSC, PAL, or PAL-M.

Region-specific formats are set at the factory for most notebooks, but the region setting can be changed on any notebook. Refer to “Changing DVD Region Settings” later in this chapter.

Color television format settings are changed in the Setup utility. The Setup utility is not a Windows utility and does not support the TouchPad. For information about using the Setup utility, refer to the “Using the Setup Utility” section in Chapter 9.

## Using Multimedia Software

This section provides guidelines for playing CDs and DVDs using Windows Media Player and WinDVD. This software supports the integrated optical drive on your notebook.

### Playing Audio and Video CDs with Windows Media Player

The Windows Media Player application is a program included with the operating system.

Use Windows Media Player primarily for playing audio CDs. Although video CDs can be played using Windows Media Player, InterVideo WinDVD provides higher quality playback.

To open Windows Media Player and play a CD:

1. Insert a CD into the optical drive, then close the tray.
2. If you do not have Autorun enabled, select Start > All Programs > Windows Media Player.
3. Select the Play button to play the CD. To stop the CD, use the on-screen Play button or Stop button, or use the media hotkeys described in the “Using Hotkey and Shortcut Keys” section of Chapter 3.



To access Windows Media Player Help, select Help on the Windows Media Player menu bar.

---



## Playing Video CDs and DVDs with InterVideo WinDVD

InterVideo WinDVD is an application that enables you to play DVD movies or video CDs. WinDVD is preinstalled on the notebook. Some DVDs contain third-party DVD player programs such as PCFriendly that may interfere with WinDVD.

### Installing WinDVD

If WinDVD has been uninstalled and you insert a DVD that contains a non-HP player program, you are prompted to install that non-HP player program.

If you prefer to use WinDVD, decline the non-HP player installation, close the installation window, and re-install WinDVD.

To re-install WinDVD:

1. Select Start > All Programs > Software Setup. A setup wizard loads, and a list of applications is displayed.
2. Select WinDVD and follow the instructions on the screen.

For more information about WinDVD, select Help on the WinDVD menu bar.

### Playing a Video CD or DVD

For best playback quality, save and close all files and software unrelated to playing the DVD or video CD.

If a DVD displays a Playback Of Content From This Region Is Not Permitted error message, stop the DVD, change the region setting, then restart the DVD. For information about changing the region setting, refer to [“Changing DVD Region Settings”](#) in this chapter.

To play a DVD or video CD:

1. Insert the DVD or video CD into the optical drive.
2. Assign WinDVD to play the video:
  - ❑ If the Microsoft Windows XP AppPicker window is displayed, select Play Video By Using WinDVD.
  - ❑ If the Microsoft Windows XP AppPicker window is not displayed, select Start > All Programs > InterVideo WinDVD > InterVideo WinDVD.
3. Follow the instructions on the screen.



After you insert a DVD, a short pause is normal before Autorun opens the DVD and WinDVD Player.

---

## Changing DVD Region Settings

Most DVDs that contain copyrighted files also contain region codes. The region codes help protect copyrights internationally.

You can play a DVD containing a region code only if the region code on the DVD matches the region setting on your DVD drive.

If the region code on a DVD does not match the region setting on your drive, a Playback Of Content From This Region Is Not Permitted message is displayed when you insert the DVD. To play the DVD, you must change the region setting on your DVD drive.



**CAUTION:** The region setting on your DVD drive can be changed only 5 times.

- The region setting you select the fifth time becomes the permanent region setting on the drive.
  - The number of allowable region changes remaining on the drive is displayed in the Remaining Times Until Permanent field in the WinDVD window. The number in the field includes the fifth and permanent change.
-

To change the region setting on drive media:

1. Open WinDVD by doing one of the following:
  - Select the WinDVD icon on the taskbar.
  - Select Start > All Programs > InterVideo WinDVD > InterVideo WinDVD.
2. Right-click on the WinDVD player window.
3. Select Setup.
4. Select the button for the region.
5. Select the OK button.

## Creating CDs with Roxio Easy CD & DVD Creator

Roxio Easy CD & DVD Creator is a data transfer utility that enables you to create or copy optical drive media. Before you can create CDs, you must install this application using the installation CD provided with your notebook.



If your optical drive has DVD+RW capability, DVDs can be used with Easy CD and DVD Creator to store large amounts of data on a disc. To build DVDs containing movies, refer to “Creating DVDs Using InterVideo WinDVD Creator,” later in this chapter.

---

When Easy CD & DVD Creator is installed on your notebook model, a Roxio Easy CD and DVD Creator icon is displayed in Start > All Programs > Roxio Easy CD and DVD Creator.

## Understanding Easy CD & DVD Creator Features

Easy CD & DVD Creator includes the following 4 applications:

<b>Application</b>	<b>Allows you to</b>
Disc Copier	create backup copies of personal discs.
Creator Classic	create CDs backups or archives of files on your hard drive.
Drag-To-Disc	“drag and drop” files to a CD or DVD and automatically record data was you would with a floppy disk. Drag-to-Disc does not copy and burn audio files.
Roxio Label Creator	create personalized labels for your discs.



Additional applications that appear in the Roxio Easy CD & DVD Creator online User’s Guide are not available on this notebook model, as purchased.

---

These applications can be accessed through the start menu or through the Home window. To open the Home window select Start > All Programs > Roxio Easy CD and DVD Creator > Home.

For a more information concerning Easy CD & DVD Creator applications, features, or use, refer to the Roxio Easy CD & DVD Creator online Userfs Guide. To access the guide, select Start > All Programs > Roxio Easy CD and DVD Creator > User’s Guide.

## Preparing to Use Easy CD & DVD Creator

---



**CAUTION:** To prevent loss of work and damage to a CD or DVD:

- Before writing to a CD, connect the notebook to a reliable external power source. Do not write to a CD while the notebook is running on battery power.
  - Before writing to a CD, close all open applications (including screen savers and antivirus software) except Easy CD and DVD Creator.
  - Do not copy directly from a CD to another CD or from a network drive to a CD. Instead, copy from a CD or network drive to your hard drive, then copy from your hard drive to the CD.
  - Do not type on the notebook keyboard or move the notebook while the notebook is writing to a CD. The write process is sensitive to vibration.
- 

## Choosing Recording Media

HP recommends using high-quality media that correspond to the maximum speed of the optical drive. The notebook can write or copy to CDs which provide one-time, non-erasable recording (CD-R) or to CDs which provide erasable recording (CD-RW).



In order to write data to a CD, you must use a blank CD-R or disc or a CD-RW disc on which the format has not been finalized. For more information about choosing media for use with Easy CD and DVD Creator, refer to the Roxio Easy CD and DVD Creator online User's Guide.

---

## Responding to the UDF Prompt

The first time you insert a CD into an optical drive, you may be prompted to install Universal Disk Format (UDF) Reader.

The UDF Reader is preinstalled on select notebook models. If UDF Reader is installed on your notebook, a CD created with the Drag-to-Disc application can be used in a compatible optical drive on a computer without Drag-to-Disc, provided you select the Make this disc readable on any CD-ROM or DVD-ROM drive option during the eject process.

## Formatting Recording Media

To record information to a disc using Drag-to-Disc, use a CD formatted for Drag-to-Disc. Drag-to-Disc will automatically format blank discs.



Formatting a disc in Drag-to-Disc may take up to 45 minutes to complete.

---

To record information to a CD using Creator Classic or Disc Copier, do not use a CD formatted for Drag-to-Disc or erase the information from a rewriteable disc to use it again.

To manually format a disc so that it can be used in Creator Classic or Disc Copier:

1. Insert a disc into the optical drive.
2. Open Drag-to-Disc by selecting Start > All Programs > Roxio Easy CD and DVD Creator > Drag-to-Disc.
3. Open the Drag-to-Disc menu.
4. Select Manually Format Disc, and choose the format settings.
  - To format a disc for use with only Drag-to-Disc, select Quick Format.
  - To format a disc for use with another application, select Full Format.
5. Select OK.

To record information to a CD using Creator Classic or Disc Copier, do not use a CD formatted for Drag-to-Disc or erase the information from a rewriteable disc to use it again.

## Creating CDs

Refer to the Roxio Easy CD and DVD Creator online User's Guide for details on burning CDs.

## Erasing Recorded Media with Roxio Easy CD & DVD Creator



You cannot erase data from a CD-R or DVD+R disc. Only CD-RW or DVD+RW discs can be used in the following process.

---



Erasing recorded media in Drag-to-Disc or Creator Classic may take up to 45 minutes to complete.

---

## Erasing Recorded Media with Drag-to-Disc

To erase recorded media created with Drag-to-Disc:

1. Insert the CD into the optical drive.
2. Open the Drag-to-Disc window by selecting Start > All Programs > Roxio Easy CD Creator > Drag-to-Disc.
3. Open the Drag-to-Disc menu.
4. Select Erase Disc.
5. Select OK.

## Erasing Recorded Media with Creator Classic

To erase recorded media formatted with Creator Classic:

1. Insert the CD into the optical drive.
2. Open the Creator Classic window by selecting Start > All Programs > Roxio Easy CD and DVD Creator > Creator Classic.
3. In the Source window, select the optical drive containing the disc you wish to erase.
4. On the Creator Classic menu bar, select Disc > Erase Disc.

## Selecting Easy CD & DVD Creator Settings

To use Drag-to-Disc, Creator Classic, or Disc Copier, the default settings shown in the following table must be selected. These settings are compatible; for example, the settings for Drag-to-Disc do not conflict with the settings for Disc Copier.

Application	Required Settings
Drag-to-Disc	Enable Auto Insert Notification*
Creator Classic	Disable Disc-at-Once** and Enable Track-at-Once**
Disc Copier	Disable Disc-at-Once

\* Auto Insert Notification settings are selected through the operating system.  
\*\* Disk-at-Once and Track-at-Once are recording methods that appear in the Record Setup window after you begin burning a CD.



---

The following table describes the Track-at-Once and Disc-at-Once recording methods.

<b>Option</b>	<b>Description</b>
Track-at-Once	Writes data to the disc in multiple passes and allows you to copy one track or data file at a time to the disc. Additional options allow you to choose whether the session is finalized at the end of recording.
Disc-at-Once	Writes all information to the disc at once and finalizes both the session and the disc at the end of recording.

For additional information about Track-at-Once or Disc-at-Once settings, refer to the Roxio Easy CD and DVD Creator online User's Guide.

## **Creating DVDs Using InterVideo WinDVD Creator**

InterVideo WinDVD Creator allows you to create, author, and edit movies and burn them to a DVD. Before you can create DVDs, you must install this application using the installation CD, included with select notebook. This application will not install successfully unless your notebook is equipped with an optical drive that has DVD+RW capability.

## Preparing to Use InterVideo WinDVD Creator

---



**CAUTION:** To prevent loss of work and damage to a DVD:

- Before writing to a DVD, connect the notebook to a reliable external power source. Do not write to a DVD while the notebook is running on battery power.
  - Before writing to a DVD, close all open applications (including screen savers and antivirus software) except InterVideo WinDVD Creator.
  - Do not copy directly from a DVD to another DVD or from a network drive to a DVD. Instead, copy from a DVD or network drive to your hard drive, then copy from your hard drive to the DVD.
  - Do not type on the notebook keyboard or move the notebook while the notebook is writing to a DVD. The write process is sensitive to vibration.
- 

## Choosing Recording Media

HP recommends using high-quality media that correspond to the maximum speed of the optical drive. The notebook can write or copy to DVDs which provide one-time, non-erasable recording (DVD+R) or to DVDs which provide erasable recording (DVD+RW).



In order to write data to a DVD, you must use a blank DVD+R disc or a DVD+RW disc on which the format has not been finalized. For more information about choosing media for use with WinDVD Creator, select Help on the WinDVD Creator menu bar.

---

## Creating DVDs

To open InterVideo WinDVD Creator, select Start > All Programs > InterVideo WinDVD Creator > InterVideo WinDVD Creator.

For instructions on creating DVDs, select Help on the WinDVD Creator menu bar.

---

## Communications

### Contents

Modem . . . . .	7-2
Connecting the Modem . . . . .	7-3
Network . . . . .	7-3
Connecting a Network Cable. . . . .	7-4
Turning a Network Connection Off and On . . . . .	7-4
Accessing the Network at Startup . . . . .	7-4
Wireless (Select Models Only) . . . . .	7-5
To Turn Wireless Communication On and Off. . . . .	7-6
Connecting to a Wireless Network . . . . .	7-7
Infrared. . . . .	7-8
Setting Up an Infrared Transmission. . . . .	7-9
Avoiding Standby While Using Infrared. . . . .	7-9

## Modem

All notebook models include an RJ-11 telephone jack, and a preinstalled V.92 modem. A modem cable with RJ-11 connectors at each end is also included with select models.

If you purchased a notebook with an internal modem in a country where RJ-11 telephone jacks are not standard, a country-specific modem adapter is included with the notebook.

For best performance, you can connect to any Internet Service Provider (ISP) or modem network that has V.90 or V.92 interoperable modems. Check with your ISP for a list of telephone numbers that support V.90 or V.92. (V.92 enables modem on-hold technology that allows an Internet session to be interrupted to answer a phone call, then resumes the Internet session after the call is complete.)

The maximum speed for faxing is 14.4 Kbps, even though the modem is capable of downloading at higher speeds.



**CAUTION:** Your built-in modem may not work with multiple phone lines or a private branch exchange (PBX), cannot be connected to a coin-operated telephone, and does not work with party lines. Some of these connections may result in excess electrical voltage and could cause a malfunction in the internal modem. Check your telephone line type prior to connecting your phone line.

---

## Connecting the Modem

A modem must be connected to an analog telephone line.



**WARNING:** To reduce the risk of electric shock, fire, or damage to the equipment, do not plug a telephone cable into the RJ-45 network jack.

---



**WARNING:** Connecting the notebook to a digital line can permanently damage the modem. Immediately disconnect your modem cable if accidentally connected to a digital line.

---



**CAUTION:** Jacks for digital PBX systems may resemble RJ-11 telephone jacks, but are not compatible with the modem.

---

For more information on connecting and configuring your modem, refer to the *Modem and Networking Guide* included on the *Documentation Library CD*.

## Network

All notebook models ship with an RJ-45 network jack. A network cable with RJ-45 connectors at each end is included with select models.

The notebook can be connected to a network whether or not the internal modem is connected to a telephone line.

If your notebook is connected to a network, you may want to confer with your network administrator before changing network settings.

The notebook supports network speeds up to 10 Mbps when connected to a 10BASE-T network and 100 Mbps when connected to a 100BASE-TX network.

## Connecting a Network Cable

For information on connecting a network cable, refer to the *Modem and Networking Guide* included on the *Documentation Library* CD.

## Turning a Network Connection Off and On

To conserve power, turn off a network connection you are not using.

- To turn off a network connection, log off the network, then disconnect the network cable.
- To turn on a network connection, connect the network cable, then log on to the network.

## Accessing the Network at Startup

To connect the notebook to a PXE (Preboot eXecution Environment) server during startup, you must enable the internal NIC for startup, then respond to the Network Service Boot prompt each time you want to connect to the server.

- To enable the NIC for startup and set the notebook to display the Network Service Boot prompt each time the notebook is started or restarted, set your preferences in the Setup utility. The Setup utility is not a Windows utility and does not support the TouchPad. For more information about using the Setup utility, refer to the “[Using the Setup Utility](#)” section in Chapter 9 of this guide.
- To respond to the Network Service Boot prompt, press **f12** while the prompt **F12 = Boot from LAN** appears very briefly in the lower left corner of the screen before Windows loads.

## Wireless (Select Models Only)

If your notebook is equipped with a wireless device, you can connect by radio to an 802.11b or 802.11g wireless local area network (WLAN) and access computers and other resources on the network.

A wireless network provides all the functions of a typical “wired” network, but also provides for “roaming.” Since your notebook connects to the network by radio rather than through cables, you can move from place to place within the network—from your office to a conference room, for example—and remain on the network the entire time.



*Wireless antennae location*



**WARNING: Exposure to Radio Frequency Radiation.** The radiated output power of this device is below the FCC radio frequency exposure limits. Nevertheless, the device should be used in such a manner that the potential for human contact during normal operation is minimized. To avoid the possibility of exceeding the FCC radio frequency exposure limits, human proximity to the antenna should not be less than 20 cm (8 inches) during normal operation, including when the notebook display is closed.

## To Turn Wireless Communication On and Off

Wireless networks and cellular modems are examples of devices that use wireless communication. Such devices may be restricted in some situations or environments, such as when traveling in an airplane. If in doubt, be sure to ask for authorization before turning on your notebook wireless networking.

In Italy, Singapore, and possibly other countries, you may be required to purchase a license before using the wireless function.

### Turning On Communication and Making a Connection

To turn on wireless communication and connect to a wireless network:

1. If the notebook is not on, turn it on.
2. Press the wireless on-off button (Quick Launch button) located above the number pad of the notebook to turn wireless 802.11b or 802.11g communication on and off

The wireless indicator light on the Wireless On/Off Quick Launch button turns on when 802.11b or 802.11g wireless communication is turned on.

To check the status of your wireless connection, open Network Connections in Control Panel, then select the connection.

### Turning Off Communication and Ending a Connection

To end wireless communication and disconnect from a wireless notebook:

1. Close any files that reside on other network notebooks.
2. To turn off the wireless 802.11b or 802.11g communication without turning off the notebook, press the wireless on-off button.

Putting the notebook in Standby or shutting it down also turns off the wireless function.



## **Connecting to a Wireless Network**

You can connect to an access point that gives you access to a local area network, or you can connect directly to other computers in an “ad hoc” network.

Before you can connect your notebook to an existing 802.11b or 802.11g wireless network, you have to configure the notebook.

For details on how to configure your notebook for wireless networking, open the Windows Help and Support Center and enter “wireless” as a search topic. This provides you with overviews, tutorials, articles, and step by step information on setting up your wireless device.

## Infrared

The notebook is IrDA-compliant and can communicate with another infrared-equipped device that is also IrDA-compliant. The IrDA connection speed standard is 4 megabits per second (Mbps).

The infrared port supports low-speed connections up to 115 kilobits per second (Kbps) as well as high-speed connections up to 4 Mbps.

Infrared signals are sent through an invisible beam of infrared light and must have an unobstructed line of sight. Infrared performance may vary with the performance of infrared peripherals, the distance and angle between infrared devices, and the applications being used.

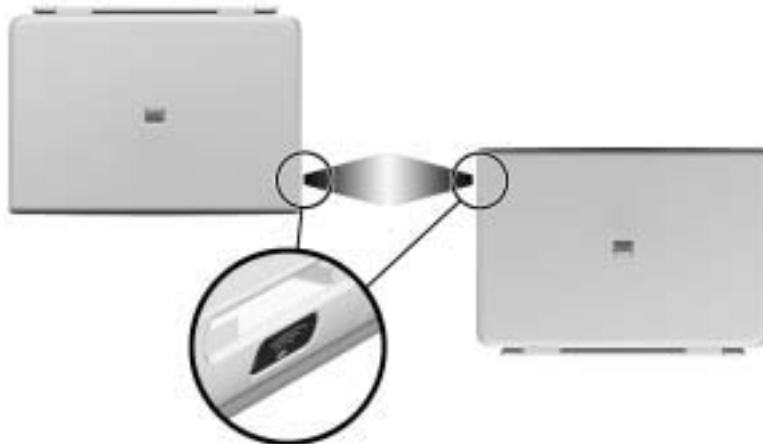

*Linking to an infrared device*

## Setting Up an Infrared Transmission

For information about using infrared software and enabling or disabling infrared ports, refer to the operating system Help files and to the documentation included with the external infrared device.

To set up 2 infrared devices, such as the notebook and an optional printer, for optimal transmission:

- Position the devices so that their infrared ports face each other at a distance of no more than 3.3 feet (1 meter).
- Position the ports so that they face each other directly. The maximum capture angle is 30 degrees, so the ports must be aligned no more than 15 degrees off center.
- Shield the ports from direct sunlight, flashing incandescent light, and fluorescent light.
- Be sure that signals from a remote control or other wireless device (such as a cell phone, a headset, or an audio device) do not aim at either port.
- During the transmission, do not move either device and do not allow objects or movement to disrupt the beam.

## Avoiding Standby While Using Infrared

Standby is not compatible with infrared transmission. If the notebook is in Standby, an infrared transmission cannot be initiated.

If Standby initiates *during* an infrared transmission, the transmission stops. To resume from Standby, briefly press the power button. The transmission resumes when the notebook resumes from Standby.



# 8

---

## Hardware Options and Upgrades

### Contents

External Devices . . . . .	8-2
Connecting a Monitor or Projector . . . . .	8-2
Connecting a USB Device . . . . .	8-3
Using a USB Device . . . . .	8-4
Using a PC Card . . . . .	8-4
Selecting a PC Card . . . . .	8-5
Configuring a PC Card . . . . .	8-5
Inserting a PC Card . . . . .	8-5
Stopping and Removing a PC Card . . . . .	8-6
Using Digital Media . . . . .	8-7
Using the Digital Media Light . . . . .	8-9
Inserting Digital Media . . . . .	8-10
Removing Digital Media . . . . .	8-11
Disabling or Restarting Digital Media . . . . .	8-11
Increasing Memory . . . . .	8-12
Displaying Memory Information . . . . .	8-12
Removing or Inserting a Memory Module . . . . .	8-13
Connecting an Optional Cable Lock . . . . .	8-18

## External Devices

The jacks and connectors described in this guide support standard external devices.

- For information about which jack or connector to use, refer to the documentation included with the device.
- For information about installing or loading any software, such as drivers, required by the device, refer to the documentation included with the device.

To connect a standard external device to the notebook:

1. Turn off the notebook.
2. If you are connecting a powered device, turn off the device.
3. Connect the device to the connector on the notebook.
4. If you are connecting a powered device, plug the device power cord into a grounded electrical outlet.
5. Turn on the device.
6. Turn on the notebook.

To disconnect a standard external device from the notebook, turn off the device, then disconnect the device from the notebook.

## Connecting a Monitor or Projector

To connect an external monitor or projector to the notebook, insert the monitor cable into the external monitor connector on the back of the notebook.



If a properly connected external monitor or projector does not display an image, try pressing the **fn+f4** hotkey to switch the image to the monitor.

---

## Connecting a USB Device

USB (universal serial bus) is a hardware interface that can be used to connect external devices such as a USB keyboard, mouse, drive, printer, scanner, or hub to the notebook or optional HP Notebook Expansion Base.

A hub is a connecting device that can be either powered or unpowered. USB hubs can be connected to a USB connector on the notebook or to other USB devices. Hubs can support several USB devices.

- Powered hubs must be connected to external power.
- Unpowered hubs must be connected either to a USB connector on the notebook or to a port on a powered hub.

The USB connectors on the notebook support USB 2.0 and earlier devices.

Some USB devices may require additional support software, which is usually included with the device. For more information and software installation instructions, refer to the documentation included with the device.

## Using a USB Device

To use a USB device, plug the device into one of the four USB connectors on your notebook.

Legacy USB 1.1 support is enabled by default. This supports a USB keyboard or hub connected to a USB connector on the notebook during startup (before Windows loads) or in a non-Windows application or utility.

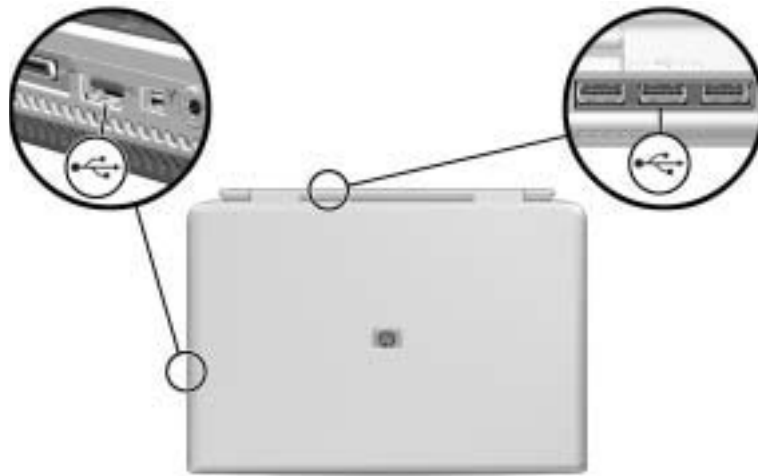

*Identifying the 3 USB connectors on the rear notebook and 1 USB connector on the left side*

## Using a PC Card

A PC Card is a credit card–sized accessory designed to conform to the standard specifications of the Personal Computer Memory Card International Association (PCMCIA). The notebook PC Card slot supports both 32-bit CardBus and 16-bit PC Cards.

PC Cards can be used to add modem, sound, storage, wireless communication, or digital camera functions to the notebook.



## Selecting a PC Card

A Type I, Type II, or Type III PC Card can be used. Zoomed video PC cards are not supported.

## Configuring a PC Card

---



**CAUTION:** If you install all of the software or any of the enablers provided by a PC Card manufacturer, you may not be able to use other PC Cards. If you are instructed by the documentation included with your PC Card to install device drivers:

- Install only the device drivers for your operating system.
  - Do not install other software, such as card services, socket services, or enablers, that may also be supplied by the PC Card manufacturer.
-

## Inserting a PC Card

---



**CAUTION:** To prevent damage to the PC Card connectors:

- Use minimal force when inserting a PC Card into a PC Card slot.
  - Do not move or transport the notebook while a PC Card is inserted.
- 

1. Hold the PC Card label-side up with the connectors facing the notebook.
2. Gently push the card into the slot until the card is seated.



*Inserting a PC Card*

## Stopping and Removing a PC Card



**CAUTION:** To prevent loss of work or an unresponsive system, stop the PC Card before removing it.



Stopping a PC Card, even if it is not in use, conserves power.

1. Close all applications and complete all activities that are supported by the PC Card.
2. To stop a PC Card, select the Safely Remove Hardware icon on the taskbar, then select the PC Card. (To display the Safely Remove Hardware icon on the taskbar, click the arrow icon for Show Hidden Icons.)
3. To release the PC Card, press the PC Card eject button ❶. (If the PC Card button does not extend while a PC Card is in the PC Card slot, press the button once to extend the button, then press the button again to release the PC Card.)
4. Gently pull out the PC Card ❷.



*Removing a PC Card*

## Using Digital Media

The digital media slot supports the following digital media formats:

- Secure Digital (SD)
- Multimedia Card (MMC)
- Memory Stick (MS)
- SmartMedia (SM)



**CAUTION:** To prevent damage to the digital media card connectors:

- Use minimal force when inserting a SD, MMC, Memory Stick, or Smart Media into a Digital Media slot.
  - Do not move or transport the notebook while Digital Media is inserted.
- 

Digital media formats consist of flash memory cards that provide secure data storage and convenient data sharing. These cards are often used with digital media-equipped cameras and PDAs as well as other notebooks.

## Using the Digital Media Light

The digital media light turns on when an inserted Digital Media card is being accessed. The digital media light turns off when inserted digital media is inactive or when the digital media slot is empty.



*Identifying the digital media light*

## Inserting Digital Media

To insert a digital media card:

1. Hold the card label-side up with the connectors facing the notebook.
2. Gently push the card into the Digital Media slot until the card is seated. (The card will extend slightly beyond the edge of the notebook.)



*Inserting a digital media card*

## Removing Digital Media

To remove a Digital Media card:

1. Complete all activities that are supported by the card (such as a data transfer) and close all applications.
2. Push the card in until it is released ❶.
3. Pull the card out of the slot ❷.



*Releasing and removing a digital media card*

## Disabling or Restarting Digital Media

An inserted Digital Media card uses power even when the card is not in use. Disabling the card conserves power.

To disable an inserted Digital Media card, double-click the My Computer icon on the Windows Desktop, right-click the drive assigned to the card, then select Eject. (The card is stopped but is not released from the Digital Media Card slot.)

To restart the card, remove, then reinsert, the card. For instructions, refer to [“Inserting Digital Media”](#) and [“Removing Digital Media”](#) in this chapter.

## Increasing Memory

You can increase the amount of RAM (random access memory) in the notebook with an optional HP-approved memory module.

The notebook memory slot supports one 128-MB, 256-MB, 512-MB, or 1024-MB memory module.

Some notebook models ship with a vacant memory slot. On other models the memory slot contains a preinstalled memory module that can be replaced at any time.

## Displaying Memory Information

When RAM is increased, the operating system increases the hard drive space reserved for the hibernation file.

If you experience problems with Hibernation after increasing RAM, verify that your hard drive has enough free space for the larger hibernation file.

- To display the amount of RAM in the system:  
Select Start > Control Panel > Performance and Maintenance icon > System icon > General tab.
- To display the amount of free space on your hard drive, double-click My Computer and right-click the hard drive and select properties.
- To display the amount of space required by the hibernation file:  
Select Start > Control Panel > Performance and Maintenance icon > Power Options icon > Hibernate tab.



## Removing or Inserting a Memory Module

---



**WARNING:** To prevent exposure to electrical shock, access only the memory compartment during this procedure. The memory compartment and the battery and hard drive bays are the only user-accessible internal compartments on the notebook. All other areas that require a tool to access should be opened only by an HP authorized service provider.

---



**WARNING:** To prevent exposure to electrical shock and damage to the notebook, shut down the notebook, unplug the power cord, and remove the battery pack before installing a memory module.

---



**CAUTION:** To prevent electrostatic discharge from damaging electronic components: before beginning this procedure, discharge yourself of static electricity by touching a grounded metal object. For more information about preventing electrostatic damage, refer on the *Documentation Library* CD to the *Regulatory and Safety Notices* guide, "Electrostatic Discharge" section.

---

1. Save your work and shut down the notebook. If you are not sure whether the notebook is off or in Hibernation, briefly press the power button. If your work returns to the screen, save your work, exit all applications, then shut down the notebook.
2. Disconnect all external devices connected to the notebook.
3. Disconnect the power cord.
4. Remove the battery pack.

5. Turn the notebook upside down.
6. Remove the two memory compartment screws ❶.
7. Slide the memory compartment cover towards the notebook display hinges and lift up to remove ❷.

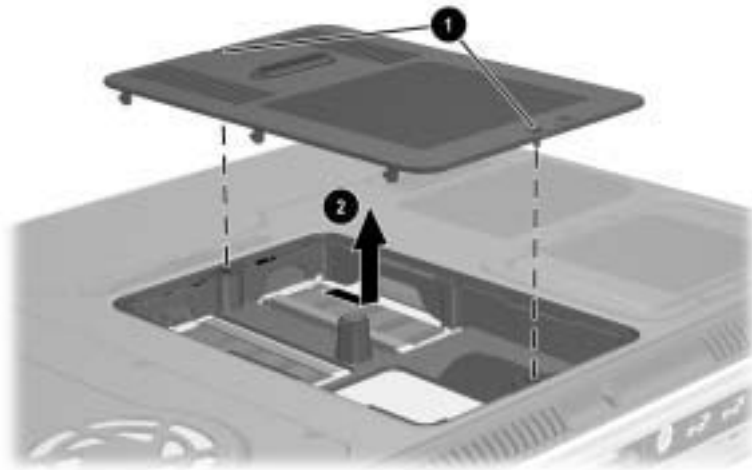

*Opening the memory compartment*

8. Remove or insert the memory module.

To remove a memory module:

- a. Pull away the retention clips on each side of the module ❶. (The module tilts upward.)
- b. Grasp the edges of the module and gently pull the module out of the memory slot ❷.
- c. To protect a memory module after removal, place it in an electrostatic-safe container.

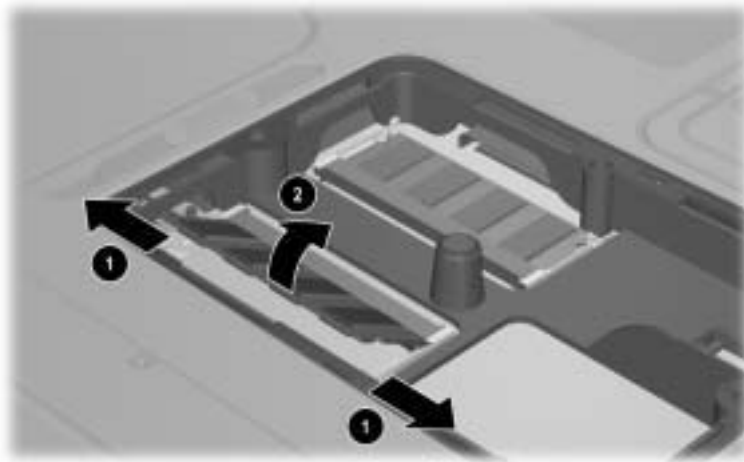

*Removing a memory module*

To insert a memory module:

- a. Align the keyed (notched) edge of the module with the keyed area in the memory slot ❶.
- b. With the module at a 45-degree angle from the surface of the memory compartment, press the module into the memory slot until it is seated ❷.
- c. Push the module down until the retention clips snap into place ❸.

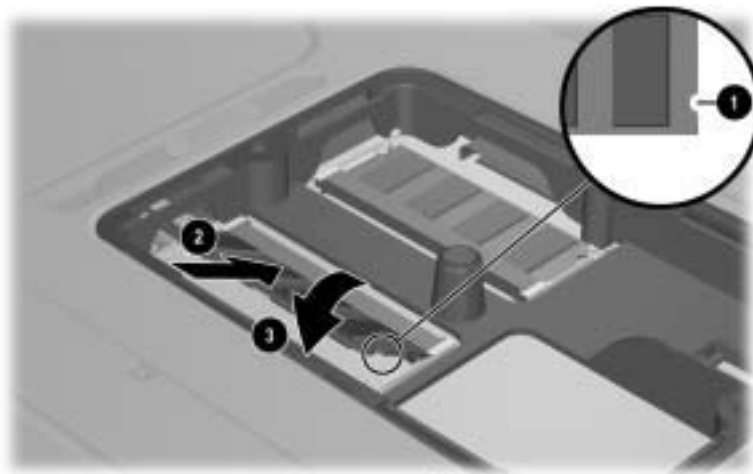

*Inserting a memory module*

9. Align the tabs on the memory compartment cover with the cover slots on the notebook, then lower the cover and slide it towards the front of the notebook ❶.
10. Reinsert and tighten the two memory compartment screws ❷.
11. Replace the battery pack (if you removed a battery pack at the beginning of this procedure), reconnect external power, then restart the notebook.

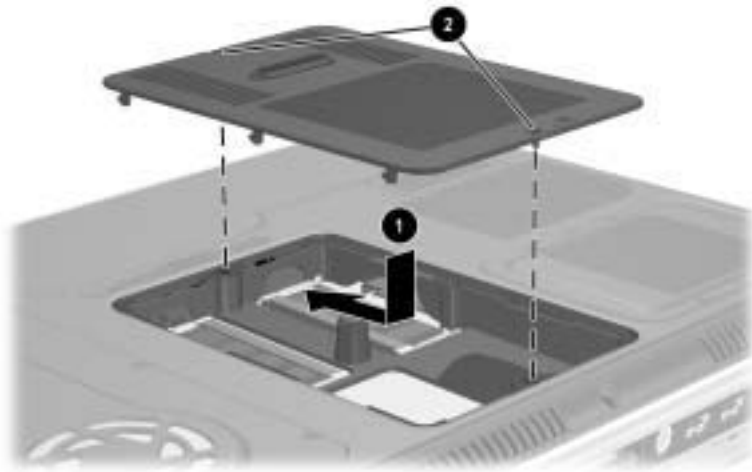

*Closing the memory compartment*

## Connecting an Optional Cable Lock

The purpose of security solutions is to act a deterrent. The solutions do not prevent the product from being mishandled or stolen.

To install a security cable:

1. Loop the cable around a secured object.
2. Insert the cable lock key ❶ into the cable lock.
3. Insert the cable lock ❷ into the security cable slot ❸.
4. Lock it with the cable lock key.



*Connecting an optional cable lock*

---

## Software Updates, Restorations and Utilities

### Contents

Updating Software . . . . .	9-2
Preparing for a Software Update . . . . .	9-2
Downloading and Installing an Update . . . . .	9-4
Backing Up and Restoring Data. . . . .	9-7
Setting a System Restore Point . . . . .	9-7
Restoring to a System Restore Point . . . . .	9-7
Repairing or Reinstalling the Operating System . . . . .	9-8
Repairing the Operating System . . . . .	9-8
Reinstalling the Operating System . . . . .	9-9
Reinstalling Device Drivers and Other Software . . . . .	9-10
Installing a Retail Version of an Operating System. . . . .	9-11
Using the Setup Utility. . . . .	9-11
Opening the Setup Utility . . . . .	9-11
Navigating and Selecting in the Setup Utility . . . . .	9-12
Restoring Setup Utility Default Settings . . . . .	9-12
Exiting the Setup Utility . . . . .	9-12

## Updating Software

For optimal notebook performance and to make sure your notebook remains compatible with changing technologies, install the latest versions of the software provided with your notebook as they become available.

To update notebook software:

Prepare for any update by identifying your notebook type, series or family, and model. Prepare for a ROM (read-only memory) update by identifying the ROM version currently installed on the notebook.

1. Access the updates at the HP Web site.
2. Download and install the updates.



The notebook ROM stores the BIOS (basic input-output system). The BIOS determines how the notebook hardware interacts with the operating system and external devices and also supports such notebook services as time and date.

---

## Preparing for a Software Update

If your notebook connects to a network, consult with your network administrator before installing any software updates, particularly a ROM update.

## Accessing Notebook Product Information

To access the updates for your notebook, you will need the following information:

- The product *category* is Notebook.
- The product *family name* and *series number* are printed on the display bezel.
- More complete *model* information is provided on the serial number label on the bottom of the notebook.



The product name, notebook model, and notebook serial number are also displayed in the same section of the Setup utility that displays ROM information, as described in the next section.

## Accessing Notebook ROM Information

To determine whether an available ROM update is a later ROM version than the ROM version currently installed on the notebook, you need to know the version of the currently installed ROM.

ROM information is displayed in the Setup utility. The Setup utility is a non-Windows utility that does not support the TouchPad. For complete information about using the Setup utility, refer to the [“Using the Setup Utility”](#) section in Chapter 9.

1. To open the Setup utility, turn on or restart the notebook.
2. Before Windows opens and while the Press <F10> to enter setup prompt is displayed in the lower left section of the screen, press **f10**.
3. The ROM version and date are displayed in the System BIOS Version field.
4. To exit the Setup utility without changing any settings:
  - a. Press **esc** to close the window.
  - b. Use the arrow keys to select Ignore changes and exit, then press **enter**.

## Downloading and Installing an Update

Most software at the HP Web site is packaged in a compressed file called a SoftPaq. Some ROM updates may be packaged in a compressed file called a RomPaq. Other ROM updates may be provided as a CPQFlash SoftPaq.

Most download packages contain a file named Readme.txt. Readme.txt contains detailed descriptive, installation, and troubleshooting information about the download. Readme.txt included with RomPaqs are English only.

The following sections provide instructions for downloading and installing:

- A ROM update.
- A SoftPaq containing an update other than a ROM update.

## Downloading and Installing a ROM Update



**CAUTION:** To prevent serious damage to the notebook or an unsuccessful installation, download and install a ROM update only while the notebook is connected to reliable external power. (Do not download or install a ROM update while the notebook is docked or running on battery power.) During the download and installation:

- Do not unplug the notebook from the electrical outlet.
  - Do not shut down the notebook or initiate Standby or Hibernation.
  - Do not insert, remove, connect, or disconnect any device, cable, or cord.
- 

### Downloading a ROM Update:

1. Access the page at the HP Web site that provides software for your notebook: Select Start > Help and Support, then select a software update link. Or, visit the HP Web site at:  
<http://www.hp.com/support>
2. Follow the instructions on the screen to identify your notebook and access the ROM update you want to download.

3. At the download area:
  - a. Record the date, name, or other identifier of any ROM update that is later than the ROM currently installed on your notebook. (You may need to identify the update later, after it has been downloaded to the hard drive.)
  - b. Record the path to the default or custom location on the hard drive to which the ROM package will download. (You may need to access the ROM package after it has been downloaded.)
  - c. Follow the online instructions to download your selection to the hard drive.

### Installing a ROM Update

ROM installation procedures vary. Follow any instructions that are displayed on the screen after the download is complete. If no instructions are displayed:

1. Open Windows Explorer. To open Windows Explorer from the Start button, select Start > All Programs > Accessories > Windows Explorer.
2. In the left pane of the Windows Explorer window, select My Computer > your hard drive designation. (The hard drive designation is typically Local Disk C.) Then follow the path you recorded earlier to the folder on your hard drive containing the update.
3. To begin the installation, open the folder, then double-click the file with an .exe extension, for example, Filename.exe. (The ROM update installation begins.)
4. To complete the installation, follow the instructions on the screen.



After a message on the screen reports a successful installation, you can delete the downloaded file from the destination folder.

---

## Downloading and Installing a Non-ROM SoftPak

To update software other than a ROM update:

1. Access the page at the HP Web site that provides software for your notebook: Select Start > Help and Support, then select a software update link. Or, visit the HP Web site at:

<http://www.hp.com/support>

2. Follow the instructions on the screen to identify your notebook and access the SoftPak you want to download.
3. At the download area:
  - a. Write down the date, name, or other identifier of the SoftPak you plan to download. (You will need to identify the update later, after it has been downloaded to the hard drive.)
  - b. Follow the online instructions to download the SoftPak to the hard drive.
4. When the download is complete, open Windows Explorer. To open Windows Explorer from the Start button, select Start > All Programs > Accessories > Windows Explorer.
5. In the left pane of the Windows Explorer window, select My Computer > your hard drive designation, which is typically Local Disk C > HP.
6. In the HP folder, select the name or number of the software package you have downloaded.
7. Select the file that includes an .exe extension, for example, Filename.exe. (The installation begins.)
8. To complete the installation, follow the instructions on the screen.



After a message on the screen reports a successful installation, you can delete the downloaded file from the HP folder.

---

## Backing Up and Restoring Data

The System Restore utility enables you to safeguard your system files and functional configurations by using System Restore points.

System Restore points are restorable “snapshots” or benchmarks of your system. The notebook may set System Restore points whenever you change personal settings or add software or hardware. Setting System Restore points manually provides additional protection for your system files and settings. HP recommends that you set System Restore points:

- Before you add or extensively modify software or hardware.
- Periodically, whenever the system is performing optimally.

## Setting a System Restore Point

To set a System Restore point manually:

1. Select Start > Help & Support > Tools. (Notebook and diagnostic information is displayed.)
2. Select System Restore, then follow the on-screen instructions for setting a Restore Point.

## Restoring to a System Restore Point

To restore the notebook to a System Restore point:

1. Select Start > Help & Support > Tools. (Notebook and diagnostic information is displayed.)
2. Select System Restore, then follow the on-screen instructions for restoring the notebook to a Restore Point.

## Repairing or Reinstalling the Operating System

The *Operating System* CD included with your notebook can be used to repair or reinstall the operating system. Either operations may take 1 to 2 hours to complete.

- Repairing the operating system preserves your data and settings.
- Reinstalling the operating system deletes all files on the notebook. After the operating system has been reinstalled, all device drivers must also be reinstalled.

HP recommends that you try to restore your system by using the System Restore utility before you consider repairing or reinstalling your operating system. For restoration instructions, refer to “[Backing Up and Restoring Data](#)” earlier in this chapter.

If a System Restore restoration fails to restore functionality, first try to repair the operating system. If the repair procedure does not restore functionality, you may need to reinstall the operating system.

### Repairing the Operating System

To repair the operating system without deleting your personal data, use the *Operating System* CD that was shipped with the notebook:

1. Connect the notebook to external power and turn on the notebook.
2. Immediately insert the *Operating System* CD (included with the notebook) into the optical drive.
3. Press and hold the power button for 5 seconds to turn off the notebook.
4. Press the power button again to start the notebook.
5. When prompted, press any key to boot from CD. After a few minutes, the Welcome to Setup screen is displayed.

6. Press **enter** to continue. A Licensing Agreement screen is displayed.
7. Press **f8** to accept the agreement and continue. The Setup window is displayed.
8. Press **R** to repair the selected Windows installation. The repair process begins. The notebook restarts in Windows after the process is complete.

## Reinstalling the Operating System

If the System Recovery and operating system repair procedures did not restore functionality to your notebook, it may be necessary to reinstall the operating system.



**CAUTION:** Personal data and any software you have installed on the notebook will be lost during the operating system reinstall. To protect your data, back up your data before beginning the procedure. For back up information and instructions, select Start > Help and Support. Also refer to ["Backing Up and Restoring Data"](#) earlier in this section.

---



During the reinstallation, you may be prompted for your product key. The product key is displayed on the Microsoft Certificate of Authenticity label on the bottom of the notebook.

---

To reinstall the operating system using the *Operating System* CD included with the notebook:

1. Connect the notebook to external power and turn on the notebook.
2. Immediately insert the *Operating System* CD into the optical drive.
3. Press and hold the power button for 5 seconds to turn off the notebook.
4. Press the power button again to start the notebook.
5. When prompted, press any key to boot from CD. After a few minutes, the Welcome to Setup screen is displayed.

6. Press **enter** to continue. A Licensing Agreement screen is displayed.
7. Press **f8** to accept the agreement and continue. The Setup window is displayed.
8. Press **esc** to continue installing a new copy of the operating system instead of repairing it.
9. Press **enter** to set up the operating system.
10. Press **C** to continue setup using this partition.
11. Select Format the partition using the NTFS file system (Quick), and press **enter**.  
 Formatting a drive will delete all current files.
12. Press **F** to format the drive. The reinstallation process begins. This process may take up to 2 hours to complete. The notebook restarts in Windows after the process is complete.

## Reinstalling Device Drivers and Other Software

After the installation process is complete, you must reinstall drivers and other software.

To reinstall drivers use the *Driver Recovery* CD included with the notebook:

1. While running Windows, insert the *Driver Recovery* CD into the optical drive.

If you do not have Autorun enabled, select Start > Run. Then type D:\SWSETUP\APPINSTL\SETUP.EXE (where D indicates the optical drive).

2. Follow the on-screen instructions for installing drivers.

After the drivers are reinstalled, you must reinstall any software you added to the notebook. Follow the installation instructions provided with the software.



## Installing a Retail Version of an Operating System

The Windows operating system provided on the notebook or on a restoration CD is enhanced by HP. The HP enhancements add power and security features and provide supplementary support for external devices such as drives and PC Cards.



**CAUTION:** Replacing an operating system enhanced by HP with a retail version of an operating system will result in the loss of all HP enhancements. In some cases, the loss of these enhancements may result in an unresponsive system or the loss of complete USB support.

---

## Using the Setup Utility

The Setup utility is a preinstalled, ROM-based information and customization utility that can be used even when your operating system is not working or will not load.

The utility reports information about the notebook and provides settings for startup, password, port, Setup utility appearance, and other preferences.

## Opening the Setup Utility

To access most settings:

1. Start up or restart the notebook.
2. Before Windows opens and while the Press <F10> to enter setup prompt is displayed in the lower left corner of the screen, press **f10**.

On some models, you must start up (not restart) the notebook to access the settings for a hard drive password.

## Navigating and Selecting in the Setup Utility

Because the Setup utility is not Windows-based, it does not support the TouchPad. Navigation and selection are by keystroke.

- To navigate, use the up and down arrow keys or **tab**.
- To select an item, use the arrow keys to select the item, then press **enter**.
- To close a display but remain in the Setup utility, press **esc**.

An on-screen guide to navigation and selection is displayed at the lower edge of most Setup utility submenu screens. To minimize keystrokes by using the <Alt> Key Activates Accelerators feature:

1. Press and hold **alt**. (A letter or number in most on-screen items is highlighted.)
2. Press the keyboard key corresponding to the highlighted letter or number in the item you want to select.

For example, to select an on-screen OK button, press **alt**. When the “O” in OK is highlighted, press **o**.

## Restoring Setup Utility Default Settings

To return all Setup utility settings to default values, select File menu > Restore Defaults. (Identification information, including ROM version information, is retained.)

## Exiting the Setup Utility

The Setup Utility exit options are on the File menu. When you select either option, Windows opens after the Setup utility closes.

- To close the utility and save your changes from the current session, select “Exit Saving Changes.”
- To close the utility without saving changes from the current session, select “Exit Discarding Changes.”

# A

---

## Specifications

The information in this appendix may be helpful if you plan to use or transport the notebook internationally or in extreme environments.

### Notebook Dimensions

<b>Dimension</b>	<b>Metric</b>	<b>U.S.</b>
Height (front)	4.25 cm	1.67 inches
Height (rear)	4.70 cm	1.85 inches
Width	39.80 cm	15.67 inches
Depth (with hinge)	28.8 cm	11.33 inches

## Operating Environment

Factor	Metric	U.S.
<b>Temperature</b>		
Operating	10° to 35° C	50° to 95° F
Nonoperating	-20° to 60° C	-4° to 140° F
<b>Relative humidity (noncondensing)</b>		
Operating	10% to 90%	10% to 90%
Nonoperating	5% to 95%	5% to 95%
<b>Maximum altitude (unpressurized)</b>		
Operating	3,048 m	10,000 ft
Nonoperating	9,144 m	30,000 ft

## Rated Input Power

The notebook operates on DC power, which can be supplied by an AC or a DC power source. Although the notebook can be powered from a stand-alone DC power source, HP strongly recommends that the notebook be powered only with an AC adapter supplied or approved by HP.

An AC adapter provided by HP for use with this notebook is capable of accepting AC power within the following specifications.

Input Power	Rating
Operating voltage	100–240V AC @1.7A - 50–60Hz
Operating current	1.5A rms
Operating frequency range	50 to 60Hz

---

The notebook is capable of accepting DC power within the following specifications.

<b>Input Power</b>	<b>Rating</b>
Operating voltage	18.5V DC @6.5A- 120W
Operating current	4.9A

This product is designed for IT power systems in Norway with phase-to-phase voltage not exceeding 240 Vrms.

## Finding More Environmental Information

The specifications in this appendix contain information about exposing the notebook to environmental extremes.

- For similar information about storing battery packs, refer to the “[Storing a Battery Pack](#)” section in Chapter 4.
- For information about exposing the notebook to sunlight, ultraviolet light, x-rays, or magnetic fields, refer on the *Documentation Library* CD to the *Maintenance, Shipping and Travel* guide.



---

# Index

1394 connector 2–11

## A

AC adapter  
    connecting 1–5  
    identifying 2–18  
    power connector 2–11  
AC power 1–12  
adapter  
    AC 1–5, 2–18  
    country-specific modem 2–18  
    Japan-specific outlet 2–18  
airport security devices 5–3  
altitude specifications A–2  
antivirus software 1–11  
applications key 2–4  
applications. *See* software;  
    software updates  
audio CD. *See* CD(s)  
audio-out jack  
    connecting 6–6  
    identifying 2–11  
AutoPlay 5–12

## B

backup, system 9–7  
battery bay  
    identifying 2–14  
    inserting battery pack 1–3  
    removing battery pack 4–26  
battery light 2–8  
battery pack  
    calibrating 4–21  
    charging 1–2, 1–6, 4–17, 4–21  
    discharging 4–21  
    inserting 1–3  
    monitoring charge 4–18  
    recharging 4–23  
    removing 4–26  
    storing 4–24  
    when to remove 4–5  
battery power  
    conserving 4–25  
    when to use 4–6  
BIOS (basic input output system)  
    9–2  
boot order 5–14

button(s)  
  PC Card eject 2-13, 8-6  
  power 2-5  
  TouchPad 2-3, 3-3  
  volume 2-7, 6-3  
  *See also* key; latch; switch,  
  display

## C

cable  
  AC adapter 1-5  
  audio 6-8  
  modem 2-9, 2-17, 7-2  
  network 2-17  
  S-Video 6-8  
  *See also* power cord  
cable lock, connecting 8-18  
caps lock light 2-6  
card and socket services, PC Card  
  8-5  
card. *See* memory, modules  
  supported; PC Card; SD Card  
CD drive. *See* drives  
CD(s)  
  *Driver Recovery* 9-10  
  *Operating System* 9-9  
  playing, with Windows Media  
  Player 6-10  
  playing, with WinDVD 6-11  
  starting from 5-14  
  *See also* drive media

Certificate of Authenticity label  
  2-16, 9-9  
compartment, memory 2-14, 8-12  
connector(s)  
  1394 2-11  
  drive 5-3  
  external monitor 2-9  
  infrared port 2-13, 7-8  
  modem 2-9, 7-3  
  network 2-9, 7-3  
  parallel 2-9  
  power 2-11  
  USB 2-9, 2-11, 8-3  
conservation, power 4-25  
country-specific modem adapter  
  identifying 2-18  
currency formats, setting 1-10  
customer support 1-13, 2-19

## D

date, setting the 1-10  
device drivers, reinstalling 9-10  
digital media  
  digital media light 8-9  
  disabling 8-11  
  inserting 8-10  
  inserting, removing 8-8  
  memory stick (MS) 8-7  
  multimedia card (MMC) 8-7  
  removing 8-11  
  secure digital (SD) 8-7  
  smartmedia (SM) 8-7



- display switch
  - function, changing 4–13
  - identifying 4–8
- display, internal
  - brightness 3–8
  - opening 1–4
  - switching image 3–7
- Documentation Library CD* 2–19
- drive media
  - affected by airport security 5–3
  - canceling AutoPlay on 5–12
  - caring for 5–3
  - displaying contents of 5–12
  - inserting, removing CD or DVD 5–9
  - types and terms 5–2
- Driver Recovery CD* 9–10
- drivers, reinstalling 9–10
- drives
  - affected by airport security 5–3
  - avoiding Standby and Hibernation while using
    - optical 5–13
  - IDE drive light 5–4
  - inserting, removing media 5–8
  - shipping 5–3
  - starting from 5–14
  - types and terms 5–2
  - USB 8–3
  - See also* hard drive, internal
- DVD drive. *See* drives
- DVD(s)
  - playing, with WinDVD 6–11
  - region settings 6–12
  - starting from 5–14
  - See also* drive media
- E**
  - Easy CD and DVD Creator
    - creating CDs 6–13
    - erasing media 6–17
    - features 6–14
    - formatting media 6–16
    - preparing to use 6–15
    - settings 6–18
    - UDF prompt 6–16
  - eject button
    - optical drive 5–10
    - PC Card 8–6
  - electric shock warning 1–12
  - electrostatic discharge (ESD) 5–3, 8–13
  - emergency shutdown procedures
    - 1–10, 4–10
  - enablers, PC Card 8–5
  - End User License Agreement 1–8
  - environmental specifications A–1
  - error message
    - Playback Of Content From This Region Not Permitted 6–11
  - ESD (electrostatic discharge) 5–3, 8–13
  - exhaust vent 2–10, 2–12, 2–15
  - external monitor
    - connector 2–9
    - switching image 3–7
- F**
  - fan, vents 2–10, 2–12, 2–15
  - FCC notice 1–12
  - FDD (floppy disk drive) 5–2
  - flash memory card 8–8
  - flash RAM card 8–8

- fn key
  - changing Standby function 4–13
  - identifying 2–4
  - Standby function 4–8
- function keys 2–4

## H

- hard drive bay
  - identifying 2–14
  - replacing hard drive 5–5
- hard drive, internal
  - defined 5–2
  - displaying amount of free space on 8–12
  - replacing 5–5
  - retaining screws 5–5, 5–8
  - space on, required for Hibernation file 8–12
  - See also* drives
- headphones 6–6
- Help and Support window 3–6
- Hibernation
  - avoiding when playing media 5–13
  - changing configuration during 4–4
  - controls and indicators 4–8
  - defined 4–4
  - identifying 5–5
  - initiating 2–5, 4–12
  - resuming from 4–12
  - setting preferences 4–13
  - when to use 4–4
- hotkeys

- changing function of fn+f5 4–13
  - procedures 3–6
  - Quick Reference 3–5
  - hotkeys commands
    - access Help and Support 3–6
    - display brightness 3–8
    - initiate QuickLock 3–8
    - initiate Standby 3–8, 4–11
    - media commands 3–9
    - Open Internet Explorer 3–6
    - Quick Reference 3–5
    - switch image 3–7
  - hub, USB 8–3
  - humidity specifications A–2
- ## I
- IDE (Integrated Drive Electronics) light 5–4
  - identifying components
    - additional 2–17
    - display 2–2
  - infrared port 2–13, 7–8
  - InterVideo WinDVD
    - creating DVDs 6–19, 6–20
    - error message 6–11
    - managing region settings 6–12
- ## J
- jack
    - audio-out 2–11, 6–6
    - microphone 2–11, 6–6
    - RJ-11 2–9
    - RJ-45 2–9
    - S-Video 2–9, 2–11, 6–8
  - Japan-specific modem adapter 2–18

**K**

## key

- applications 2–4
- fn 2–4
- function (F1, F2, etc.) 2–4
- hotkeys 3–4
- keypad 2–4, 3–10
- Microsoft logo 2–4
- See also* button; latch; switch, display

## keyboard language 1–10

**L**

## label

- Microsoft Certificate of Authenticity 2–16, 9–9
- modem approvals 2–16
- product identification 2–16
- system 2–16
- wireless certification 2–16

## language

- choosing during setup 1–8
- selecting keyboard 1–10

## latch

- battery pack locking 4–27
- battery pack release 2–14
- display release 2–2
- See also* button; switch, display

## light

- battery 2–8
- caps lock 2–6
- hard drive 2–8

## IDE drive 5–4

- power/standby 2–8
- line-out jack 2–11, 6–6
- lock, security cable 8–18
- locked system 1–10, 2–5, 4–10
- locking latches, battery pack 4–27

**M***Maintenance, Shipping and Travel* guide 2–19

## media hotkeys 3–9

## Media Player, Windows 6–10

## media, drive

- affected by airport security 5–3
- canceling AutoPlay on 5–12
- caring for 5–3
- displaying contents of 5–12
- inserting, removing CD or DVD 5–9
- types and terms 5–2
- See also* drives

## memory

- compartment 2–14
- displaying amount of 8–12
- increasing RAM 8–12
- module, removing or inserting 8–13
- modules supported 8–12

## microphone jack 2–11

## microphone, connecting 6–6

## Microsoft Certificate of Authenticity label 2–16

Microsoft logo key 2–4  
model, identifying notebook 9–2  
modem  
    approvals label 2–16  
    cable 2–17  
    connecting 7–3  
    country-specific adapter 2–18  
    specifications 7–2  
    virus protection 1–11  
*Modem and Networking* guide  
    2–19  
monitor, external  
    external monitor connector 2–9  
    switching display 3–7  
mouse, external  
    USB connectors 2–9, 2–11  
multimedia card 8–8

**N**

network  
    cable 2–17  
    RJ-45 jack 2–9  
    specifications 7–3  
    speed 7–3  
Norton AntiVirus 2003 1–11  
notebook model, family, type, and  
    serial number 9–2  
NTSC television format 6–9  
num lock light 2–6  
number  
    Product Key 2–16  
    serial 2–16  
numeric keypad 3–10

**O**

opening the notebook 1–4, 2–2  
operating environment  
    specifications A–2  
operating system  
    installing retail version of 9–11  
    loading 4–9  
    Microsoft Certificate of  
        Authenticity label 2–16  
    Product Key number 2–16  
    reinstalling 9–8  
    repairing 9–8  
    shutting down 4–9, 4–10  
*Operating System* CD 9–8, 9–9  
optical disc. *See* CD(s); DVD(s)  
optical drive  
    avoiding Standby and  
        Hibernation while using 5–13  
    boot order 5–14  
    identifying 2–13  
    *See also* drives

**P**

PAL, PAL-M television formats  
    6–9  
parallel connector 2–9  
passwords 9–11  
PC Card  
    configuring 8–5  
    functions 8–4  
    inserting, removing 8–5  
    stopping 8–6  
    types available 8–5  
PC Card eject button 2–13  
pointing device 3–3  
port, infrared 2–13, 7–8

- power
    - button 2–5
    - connecting the notebook to
      - external 1–5
    - conservation 4–4, 4–25
    - controls 4–8
    - cord 2–17
    - emergency shutdown
      - procedures 4–10
    - Hibernation procedures 4–10
    - power connector 2–11
    - power/standby light 2–8
    - rated input A–2
    - setting preferences 4–13
    - shutting down the notebook
      - 1–10
    - Standby procedures 4–11
    - turning on the notebook 1–7
    - See also* battery pack
  - power button
    - function, changing 4–13
    - identifying 4–8
    - resetting with 4–10
  - power connector
    - connecting 1–5
    - identifying 2–11
  - power cord
    - connecting 1–5
    - identifying 2–17
    - See also* cable
  - Power Meter 4–18
  - power, AC 1–12
  - power/standby light 4–8
  - Preboot eXecution Environment (PXE) 7–4
  - preloaded utilities 1–9
  - Product Key number 2–16
  - projector
    - connecting 2–9
    - switching display 3–7
  - PXE (Preboot eXecution Environment) 7–4
- R**
- RAM (Random Access Memory) 8–12
  - region settings
    - currency, date, language, time 1–10
    - DVD 6–12
  - Regulatory and Safety Notices* guide 2–19
  - regulatory information
    - modem approvals label 2–16
    - notices 1–12
    - Regulatory and Safety Notices* guide 2–19
    - system label 2–16
    - wireless certification label 2–16
  - release latch
    - battery pack 2–14
    - display 2–2
  - repairing the operating system 9–8
  - reset (emergency shutdown

- resolution, screen 1–10
- restoring software 2–19
- RJ-11 telephone jack
  - identifying 2–9
  - modem cable 2–17
- RJ-45 network jack
  - identifying 2–9
  - network cable 2–17
- ROM
  - defined 9–2
  - determining current version of 9–3
  - downloading and installing 9–4
  - obtaining updates 9–4
- RomPaq, downloading 9–4
- S**
- Safety & Comfort Guide* 2–19
- safety considerations 1–12
- security cable
  - lock, connecting 8–18
  - slot 2–9
- serial number, notebook 2–16, 9–2
- series, notebook 9–2
- Setup utility 9–11
- shutdown procedures 1–10, 4–9
- sleep button 3–8, 4–13
- Sleep. *See* Standby
- slot
  - memory 8–12
  - PC Card 2–13
  - SD Card 8–8
  - security cable 2–9
- socket services, PC Card 8–5
- SoftPaq
  - described 9–4
  - downloading and installing 9–6
- software
  - antivirus protection 1–11
  - AutoPlay 5–12
  - infrared 7–8
  - installing optional 1–9
  - network 7–4
  - Norton AntiVirus 2003 1–11
  - Power Meter 4–18
  - regional settings 1–10
  - reinstalling 9–8, 9–10
  - repairing 9–8
  - restoring 2–19
  - RomPaq 9–4
  - Setup utility 9–11
  - SoftPaq 9–4
  - updating preloaded software 9–2
  - Windows Media Player 6–10
  - WinDVD 6–11
- software updates
  - downloading and installing 9–4, 9–6
  - obtaining 9–4
  - preparing for 9–2
- speakers, external 6–6

- specifications
    - dimensions A-1
    - modem 7-2
    - network 7-3
    - operating environment A-2
    - rated input power A-2
  - Standby
    - avoiding when playing media 5-13
    - avoiding when using infrared 7-9
    - controls and indicators 4-8
    - initiating 3-8, 4-11
    - power/standby light 2-8
    - resuming from 4-11
    - setting preferences 4-13
  - S-Video
    - connections 6-8
    - jack 2-9
  - system label 2-16
  - system lockup 1-10, 2-5, 4-10
  - System Restore utility 9-7
- T**
- technical support
    - getting help 1-13
    - notebook documentation 2-19
  - telephone (RJ-11) jack
    - identifying 2-9
    - modem cable 2-17
  - telephone numbers, service and support 1-13
  - television
    - changing color format 6-9
    - connecting audio 6-6
    - connecting video 6-8
  - temperature
    - specifications A-2
    - storage, battery pack 4-24
  - 1394 connector 2-11
  - time, setting the 1-10
  - TouchPad
    - components 3-3
    - setting preferences 3-3
  - traveling with notebook
    - battery pack temperature considerations 4-24
    - environmental specifications A-2
    - modem approvals label 2-16
    - regional settings 1-10
    - serial number 2-16
    - wireless certification label 2-16
  - troubleshooting
    - Troubleshooting* guide 2-19
  - turning off notebook 1-10, 4-9, 4-10
  - turning on notebook 1-7, 4-9
- U**
- unresponsive system, emergency shutdown procedures 1-10, 4-10
  - USB
    - connectors, identifying 2-9, 2-11
    - devices, connecting 8-3
  - utilities, preloaded
    - displaying descriptions 1-9
    - installing 1-9
    - See also* software

## V

- VCR
  - audio-out jack
    - function 6–6
  - connecting 6–8
- vents, fan 2–10, 2–12, 2–15
- video CDs, DVDs. *See* CD(s); DVD(s)
- video device
  - connecting audio 6–8
  - S-Video jack 6–8
  - turning on and off 6–9
- viruses, computer 1–11
- volume, adjusting 6–3

## W

- Windows applications key 2–4
- Windows Media Player
  - accessing with Digital Audio button 6–10
  - using with audio CDs
- WinDVD
  - error message 6–11
  - managing region settings 6–12
- wireless device
  - certification label 2–16
  - turning on and off 7–6
- wireless network 7–5



© 2003 Hewlett-Packard Development Company, L.P.

Microsoft and Windows are trademarks of Microsoft Corporation in the U.S. and/or other countries. SD Logo is a trademark.

The information contained herein is subject to change without notice. The only warranties for HP products and services are set forth in the express warranty statements accompanying such products and services. Nothing herein should be construed as constituting an additional warranty. HP shall not be liable for technical or editorial errors or omissions contained herein.

Startup and Reference Guide  
HP Notebook Series  
First Edition August 2003  
Reference Number: zd7000  
Document Part Number: 335555-001







## Free Manuals Download Website

<http://myh66.com>

<http://usermanuals.us>

<http://www.somanuals.com>

<http://www.4manuals.cc>

<http://www.manual-lib.com>

<http://www.404manual.com>

<http://www.luxmanual.com>

<http://aubethermostatmanual.com>

Golf course search by state

<http://golfingnear.com>

Email search by domain

<http://emailbydomain.com>

Auto manuals search

<http://auto.somanuals.com>

TV manuals search

<http://tv.somanuals.com>