



HP ProBook 4340s Notebook PC
HP ProBook 4341s Notebook PC

Maintenance and Service Guide

© Copyright 2012 Hewlett-Packard
Development Company, L.P.

Bluetooth is a trademark owned by its proprietor and used by Hewlett-Packard Company under license. Intel and Core are trademarks or registered trademarks of Intel Corporation in the United States and other countries. Microsoft and Windows are either trademarks or registered trademarks of Microsoft Corporation in the United States and/or other countries. SD Logo is a trademark of its proprietor.

The information contained herein is subject to change without notice. The only warranties for HP products and services are set forth in the express warranty statements accompanying such products and services. Nothing herein should be construed as constituting an additional warranty. HP shall not be liable for technical or editorial errors or omissions contained herein.

First Edition: May 2012

Document Part Number: 679212-001

Safety warning notice

 **WARNING!** To reduce the possibility of heat-related injuries or of overheating the computer, do not place the computer directly on your lap or obstruct the computer air vents. Use the computer only on a hard, flat surface. Do not allow another hard surface, such as an adjoining optional printer, or a soft surface, such as pillows or rugs or clothing, to block airflow. Also, do not allow the AC adapter to contact the skin or a soft surface, such as pillows or rugs or clothing, during operation. The computer and the AC adapter comply with the user-accessible surface temperature limits defined by the International Standard for Safety of Information Technology Equipment (IEC 60950).

Table of contents

1 Product description	1
2 External component identification	6
Display	6
Top	7
TouchPad	7
Lights	8
Buttons, speakers, and fingerprint reader (select models only)	9
Keys	10
Front	11
Left	12
Right	13
3 Illustrated parts catalog	14
Service tag	14
Computer major components	15
Display components	18
Plastics Kit	18
Mass storage devices	19
Miscellaneous parts	20
Sequential part number listing	21
4 Removal and replacement procedures	25
Preliminary replacement requirements	25
Tools required	25
Service considerations	25
Plastic parts	25
Cables and connectors	26
Drive handling	26
Grounding guidelines	27
Electrostatic discharge damage	27

Packaging and transporting guidelines	28
Workstation guidelines	28
Equipment guidelines	29
Component replacement procedures	30
Service tag	30
Battery	31
Using the optional security screw	32
Bottom door	33
SIM	34
Optical drive	35
Hard drive	37
Memory modules	39
WWAN module	41
WLAN/Bluetooth combo card	43
Keyboard	45
Top cover	47
Fingerprint reader board	52
Audio board	54
Function board/Power button board	56
RTC battery	58
Speaker assembly	59
Latch assembly	60
System board	61
Heat sink	63
Processor	66
Display assembly	69
Power connector	77
5 Computer Setup (BIOS) and Advanced System Diagnostics	79
Using Computer Setup	79
Starting Computer Setup	79
Navigating and selecting in Computer Setup	79
Restoring factory settings in Computer Setup	80
Updating the BIOS	81
Downloading SoftPaqs to update the BIOS	81
BIOS management using system diagnostics	81
Using f10 setup to update the BIOS	81
Determining the BIOS version	82
Downloading a BIOS update	83
BIOS Setup Menu	83
Main menu	84

Security menu	84
Diagnostics menu	84
Using Advanced System Diagnostics	84
6 Specifications	86
Computer specifications	86
33.8-cm (13.3-in), HD display specifications	87
Hard drive specifications	88
DVD±RW and CD-RW SuperMulti DL Combo Drive specifications	89
Blu-ray ROM DVD±RW SuperMulti DL Drive	90
Specification information in Device Manager	91
7 Backup and recovery	92
Creating recovery media with HP Recovery Disc Creator	93
Creating recovery media	93
Backing up your information	94
Performing a system recovery	95
Using the Windows recovery tools	95
Using f11 recovery tools	96
Using a Windows 7 operating system DVD (purchased separately)	96
8 Power cord set requirements	98
Requirements for all countries and regions	98
Requirements for specific countries and regions	99
9 Recycling	101
Battery	101
Display	101
Index	107

1 Product description

Category	Description
Product Name	HP ProBook 4340s Notebook PC
	HP ProBook 4341s Notebook PC
Processors	Intel® Core™ i7 processor, Quad Core (6-GB L3 cache)
	3612QM, 2.10-GHz processor
	Intel Core i5 processors, Dual Core (3-MB L3 cache)
	3360M, 2.80-GHz processor
	3320M, 2.60-GHz processor
	Intel Core i3 processors (3-MB L3 cache)
	3110M, 2.40-GHz processor
	2450M, 2.50-GHz processor
	2370M, 2.40-GHz processor
	2350M, 2.30-GHz processor
	Intel Pentium processor, Dual Core (2-MB L3 cache)
	B980, 2.40-GHz processor
	B970, 2.30-GHz processor
Intel Celeron processor (2-MB L3 cache)	
B840, 1.90-GHz processor	
Chipset	Mobile Intel HM76 chipset
Graphics	Intel HD Graphics (UMA)
	AMD Radeon™ HD 7570M, 1-GB (discrete)
Panel	All display assemblies include 2 wireless local area network (WLAN) antennas
	33.8-cm (13.3-inch) HD, 1366x768, includes camera
Memory	Two customer-accessible/upgradeable memory module slots supporting up to 8 GB of RAM
	Supports dual-channel memory
	PC3-10600, 1333-MHz, DDR3

Category	Description
	<p>Supports the following configurations:</p> <ul style="list-style-type: none"> • 8192 (4096 × 2; dual channel) • 6144 (4096 + 2048; dual channel) • 4096 (2048 × 2; dual channel) • 4096 (4096 × 1) • 2048 (2048 × 1)
Hard drives	<p>Supports 7-mm, 6.35-cm (2.50-in) SATA hard drives with HP 3D DriveGuard</p> <p>Customer-accessible</p> <p>Supports the following drives:</p> <ul style="list-style-type: none"> • 500-GB, 5400-rpm • 320-GB, 7200-rpm • 320-GB, 5400-rpm
Fixed optical drives	<p>Supports the following 12.7-mm SATA optical drives:</p> <ul style="list-style-type: none"> • DVD-ROM • DVD+/-RW SuperMulti DL • Blu-ray ROM DVD+/-RW SuperMulti DL <p>Supports no optical drive option</p>
Audio/Visual	<p>Integrated dual-array microphone (webcam models only)</p> <p>Integrated mono (non-webcam models)</p> <p>Stereo speakers (2)</p> <p>Integrated webcam (720p HD)</p> <p>Headphone and microphone jacks</p>
Ethernet	<p>Realtek RTL8151FH-CG 10/100/1000</p> <p>S3/S4/S5 wake on LAN (AC mode only)</p>
Wireless	<p>Integrated WLAN options by way of wireless module:</p> <p>Two WLAN antennas built into display assembly</p> <p>Supports “no WLAN/No BT” option</p> <p>Supports the following WLAN formats:</p> <ul style="list-style-type: none"> • Ralink 802.11 b/g/n 1×1 • Atheros 802.11 b/g/n 1×1 • Atheros 802.11 b/g/n + BT Combo • Broadcom 802.11 b/g/n + BT Combo • Intel 802.11 a/b/g/n 2×2 + BT Combo • Intel 802.11 b/g/n + BT Combo

Category	Description
	Integrated WWAN options by way of wireless module:
	Two WWAN antennas built into display assembly (world-wide 5 band, configured with panels)
	Subscriber identity module (SIM) security
	Supports “no WWAN” option
	Supports the following WWAN modules: <ul style="list-style-type: none"> • Sierra MC8355 (Gobi 3000) HSPA/CDMA with GPS • Ericsson 5321 HSPA+ with GPS
	Integrated personal area network (PAN) options by way of WLAN/Bluetooth® combo card:
	Bluetooth 4.0 only supported by combo card
External media card	6-in-1 Digital Media Reader Slot
Ports	Audio-in (stereo microphone)
	Audio-out (stereo headphone)
	RJ-45 (Ethernet, includes link and activity lights)
	USB 3.0 (3)
	USB 3.0 (1)
	VGA (Dsub 15-pin) supporting 1600 × 1200 external resolution at 75-GHz (hot plug/unplug with auto-detect)
	HDMI
	Multi-pin AC port
Keyboard/pointing devices	Full-sized keyboard
	Touchpad includes: supports 2-way scroll with legend, taps enabled by default, 2-finger scrolling and zoom enabled by default
Power requirements	Smart AC adapter with localized cable plug support (3-wire plug with ground pin):
	90-W
	65-W
	6-cell, 51-Wh Li-ion battery (In-line cavity)
Security	Integrated fingerprint reader
	Intel AT support
	Support Kensington security lock
	Support no fingerprint reader option
Operating system	Preinstalled:
	Windows 7 Professional 32 with Microsoft Basics (Japan only)
	Windows 7 Professional 64 with Microsoft Basics
	Windows 7 Home Premium 64 with Microsoft Basics

Category	Description
	Novell™: SuSE Linux™ – SLED 11, 64-bit, SP2 (not available with WWAN)
	FreeDOS
	Preinstalled with Microsoft Office:
	Windows 7 Professional 64 with Microsoft Office 2010 Starter (not for Japan)
	Windows 7 Professional 64 with Microsoft Office 2010 Starter - PPP (EDGI)
	Windows 7 Professional 64 with Microsoft Office 2010 Starter - MSNA (not for Japan)
	Windows 7 Professional 64 with Microsoft Office 2010 Personal (Japan only)
	Windows 7 Professional 64 with Microsoft Office 2010 Home & Business (Japan only)
	Windows 7 Professional 64 with Microsoft Office 2010 Professional (Japan only)
	Windows 7 Professional 32 with Microsoft Office 2010 Personal (Japan only)
	Windows 7 Professional 32 with Microsoft Office 2010 Home & Business (Japan only)
	Windows 7 Professional 32 with Microsoft Office 2010 Professional (Japan only)
	Windows 7 Home Premium 64 with Microsoft Office 2010 Starter - PPP (EDGI)
	Windows 7 Home Premium 64 with Microsoft Office 2010 Starter (not for Japan)
	Windows 7 Home Premium 64 with Microsoft Office 2010 Personal (Japan only)
	Windows 7 Home Premium 64 with Microsoft Office 2010 Home & Business (Japan only)
	Windows 7 Home Premium 64 with Microsoft Office 2010 Professional (Japan only)
	Windows 7 Home Basic 64 with Microsoft Office 2010 Starter - PPP (EDGI)
	Windows 7 Home Basic 64 with Microsoft Office 2010 Starter (not for Japan)
	Windows 7 Home Basic 64 with Microsoft Office 2010 Professional (Japan only)
	Restore Media:
	Windows 7 Professional 64
	Windows 7 Professional 32
	Windows 7 Home Premium 64
	Windows 7 Home Basic 64
	DRDVD Windows 7
	Web-only support:
	Windows 7 Home Basic 32
	Windows 7 Home Premium 32
	Windows 7 Professional 32
	Windows XP Professional (discrete driver not supported)
	Certified:

Category	Description
	Microsoft WHQL
Serviceability	End-user replaceable parts:
	AC adapter
	Battery (system)
	Hard drive
	Memory module
	Optical drive
	WLAN module
	WWAN module, SIM
	Keyboard

2 External component identification

Display

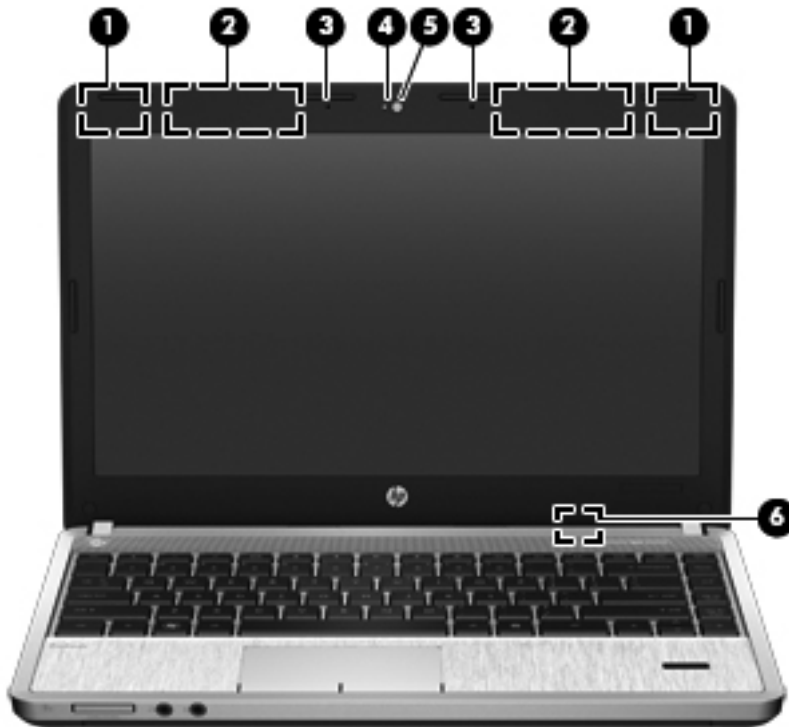

Component	Description
(1) WWAN antennas (2)* (select models only)	Send and receive wireless signals to communicate with wireless wide-area networks (WWAN).
(2) WLAN antennas (2)*	Send and receive wireless signals to communicate with wireless local area networks (WLAN).
(3) Internal microphone(s) (1 or 2 depending on model)	Record sound.
(4) Webcam light (select models only)	On: The webcam is in use.
(5) Webcam (select models only)	Records video and captures still photographs. To use the webcam, select Start > All Programs > Music, Photos and Videos>WebCam Companion .

Component	Description
(6) Internal display switch	Turns off the display or initiates Sleep if the display is closed while the power is on.

NOTE: The display switch is not visible from the outside of the computer.

*The antennas are not visible from the outside of the computer. For optimal transmission, keep the areas immediately around the antennas free from obstructions. To see wireless regulatory notices, refer to the section of the *Regulatory, Safety, and Environmental Notices* that applies to your country or region. These notices are located in Help and Support.

Top

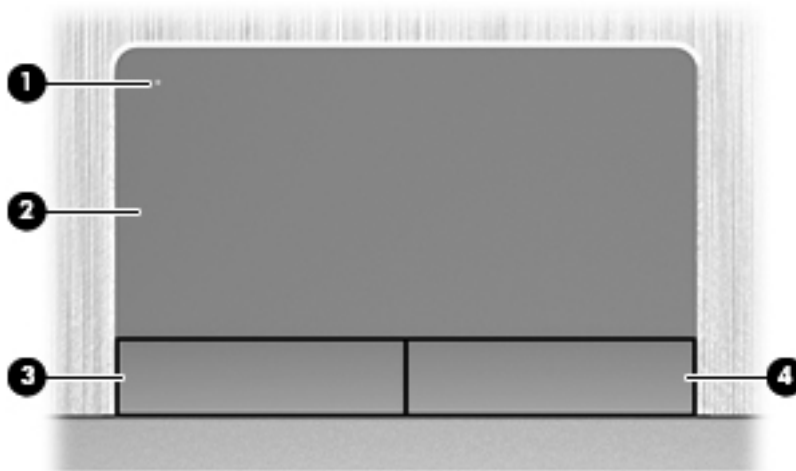

TouchPad

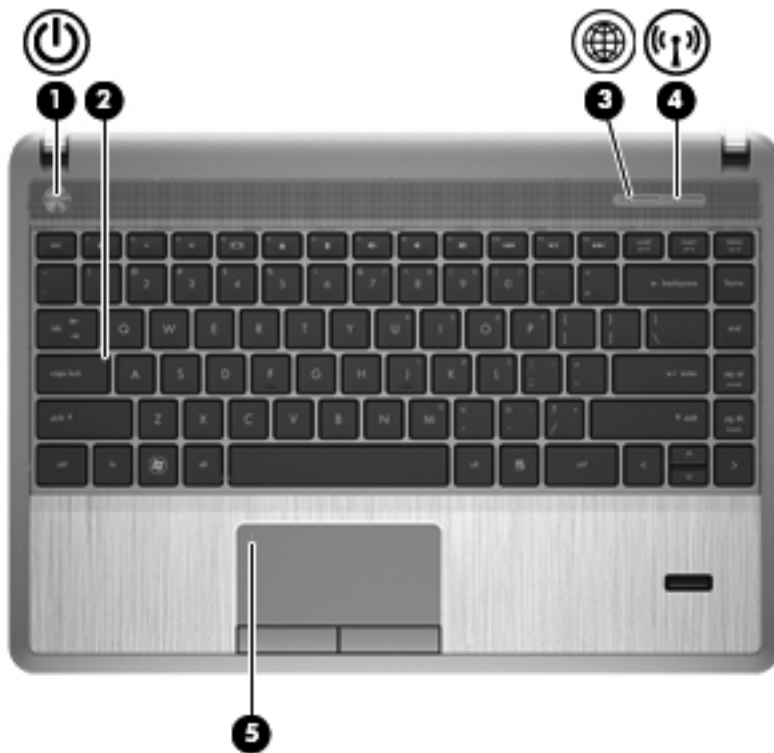

Component	Description
(1) TouchPad on/off button	Turns the TouchPad on and off.
(2) TouchPad zone	Moves the pointer and selects or activates items on the screen.
(3) Left TouchPad button	Functions like the left button on an external mouse.
(4) Right TouchPad button	Functions like the right button on an external mouse.

Lights





Component	Description
(1)  Power light	<ul style="list-style-type: none"> On: The computer is on. Blinking: The computer is in the Sleep state. Off: The computer is off or in Hibernation.
(2) Caps lock light	On: Caps lock is on.
(3)  Web browser light	<ul style="list-style-type: none"> On: The computer is on. Off: The computer is off, in Suspend mode, or in Hibernation.
(4)  Wireless light	<ul style="list-style-type: none"> White: An integrated wireless device, such as a wireless local area network (WLAN) device and/or a Bluetooth® device, is on. Amber: All wireless devices are off.
(5) TouchPad light	<ul style="list-style-type: none"> Amber: The TouchPad is off. Off: The TouchPad is on.

Buttons, speakers, and fingerprint reader (select models only)

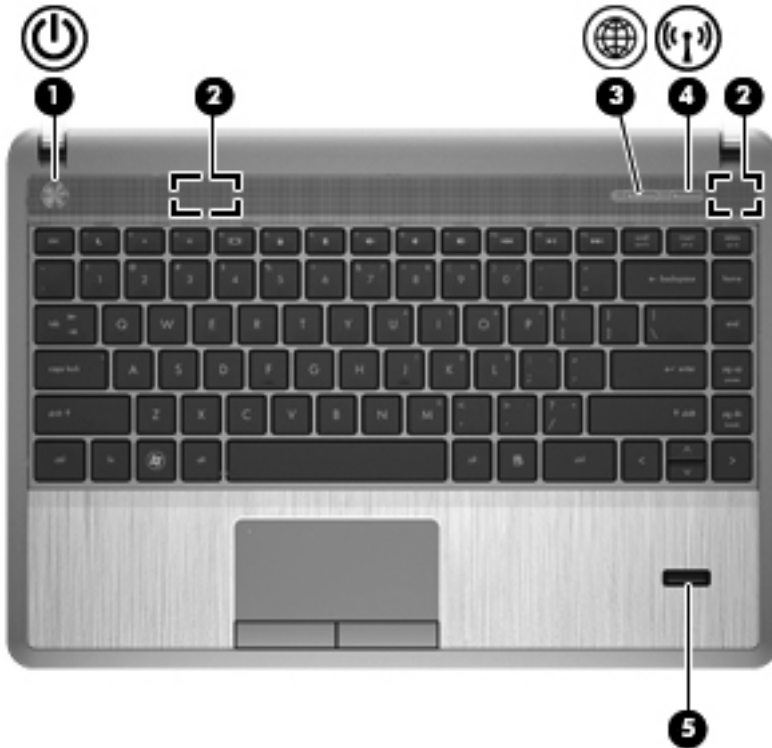
 **NOTE:** Refer to the illustration that most closely matches your computer.





Component	Description
(1)  Power button	<ul style="list-style-type: none"> When the computer is off, press the button to turn on the computer. When the computer is on, press the button briefly to initiate Sleep. When the computer is in the Sleep state, press the button briefly to exit Sleep. When the computer is in Hibernation, press the button briefly to exit Hibernation. <p>If the computer has stopped responding and Microsoft® Windows® shutdown procedures are ineffective, press and hold the power button down for at least 5 seconds to turn off the computer.</p> <p>CAUTION: Pressing and holding down the power button will result in the loss of unsaved information.</p> <p>To learn more about your power settings:</p> <ul style="list-style-type: none"> Select Start > Control Panel > System and Security > Power Options. Refer to the <i>HP Notebook Reference Guide</i>.
(2) Speakers (2)	Produce sound.

Component	Description
(3)  Web browser button	Opens the default Web browser.
(4)  Wireless button	Turns the wireless feature on or off but does not establish a wireless connection.
(5) Fingerprint reader (select models only)	Allows a fingerprint logon to Windows, instead of a password logon.

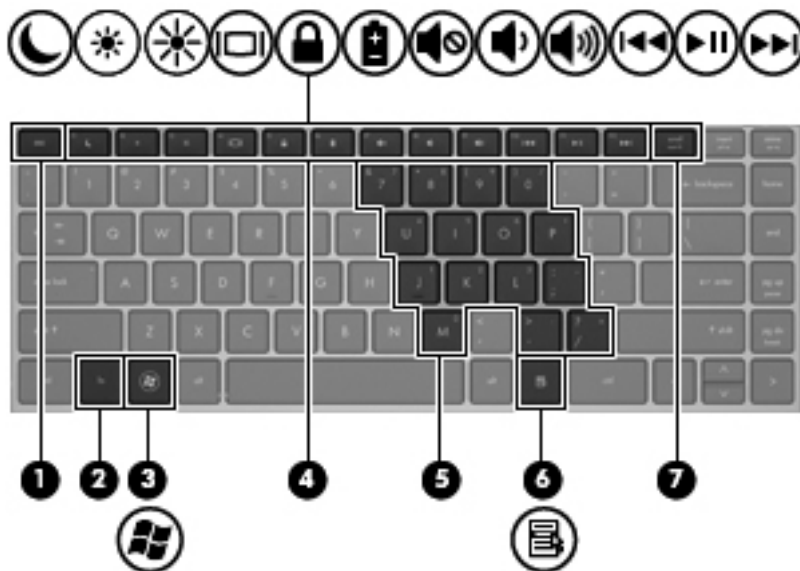
Keys





Component	Description
(1) <code>esc</code> key	Displays system information when pressed in combination with the <code>fn</code> key.
(2) <code>fn</code> key	Executes frequently used system functions when pressed in combination with a function key, the <code>num lk</code> key, the <code>esc</code> key, or other keys.
(3)  Windows logo key	Displays the Windows Start menu.
(4) Function keys	Execute frequently used system functions when pressed in combination with the <code>fn</code> key.
(5) Embedded numeric keypad keys	When the keypad is turned on, it can be used like an external numeric keypad. Each key on the keypad performs the function indicated by the icon in the upper-right corner of the key.

Component	Description
(6)  Windows applications key	Displays a shortcut menu for items beneath the cursor.
(7)  num lk key	Turns the embedded numeric keypad on and off when pressed in combination with the fn key.





Front

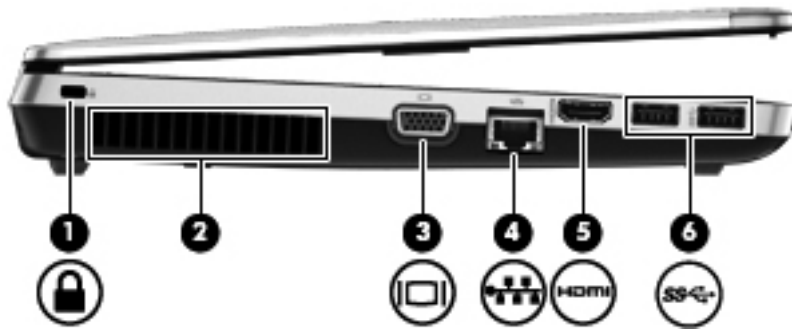

Component	Description
(1)  Drive light	<ul style="list-style-type: none"> • White: The hard drive is being accessed. • Amber: HP 3D DriveGuard has temporarily parked the hard drive. <p>NOTE: For information on HP 3D DriveGuard, refer to the <i>HP Notebook Reference Guide</i>.</p>
(2) Media Card Reader	<p>Supports the following digital card formats:</p> <ul style="list-style-type: none"> • Memory Stick PRO • Memory Stick PRO Duo (needs an adapter) • MultiMediaCard (MMC) • MultiMediaCardplus (MMC+) • Secure Digital (SD) Card • Secure Digital High Capacity (SDHC) Card • Secure Digital Extra Capacity (SDXC) Card
(3)  Audio-out (headphone) jack	<p>Connects optional powered stereo speakers, headphones, earbuds, a headset, or a television audio cable.</p> <p>WARNING! To reduce the risk of personal injury, adjust the volume before putting on headphones, earbuds, or a headset. For additional safety information, refer to the <i>Regulatory, Safety, and Environmental Notices</i></p> <p>NOTE: When a device is connected to the jack, the computer speakers are disabled.</p>
(4)  Audio-in (microphone) jack	<p>Connects an optional computer headset microphone, stereo array microphone, or monaural microphone.</p>



Left

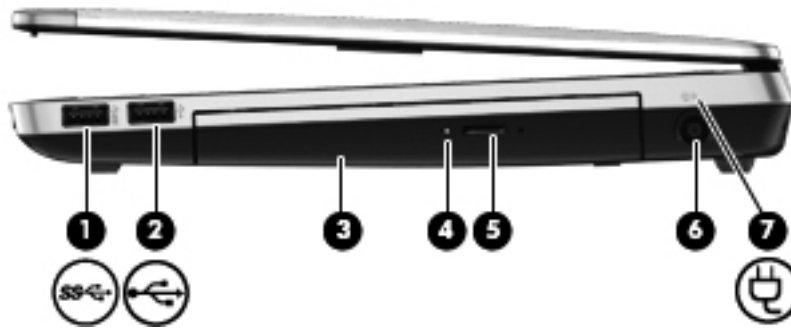

Component	Description
(1) 	Security cable slot Attaches an optional security cable to the computer. NOTE: The security cable is designed to act as a deterrent, but it may not prevent the computer from being mishandled or stolen.
(2)	Vent Enables airflow to cool internal components. NOTE: The computer fan starts up automatically to cool internal components and prevent overheating. It is normal for the internal fan to cycle on and off during routine operation.
(3) 	External monitor port Connects an external VGA monitor or projector.
(4) 	RJ-45 (network) jack Connects a network cable.
(5) 	HDMI port Connects an optional video or audio device, such as a high-definition television, or any compatible digital or audio device.
(6) 	USB 3.0 ports (2) Connect optional USB devices. For more information about USB devices, see the <i>HP Notebook Reference Guide</i> .

Right



Component	Description
(1) 	<p>USB 3.0 port</p> <p>Connects an optional USB device. For more information about USB devices, see the <i>HP Notebook Reference Guide</i>.</p>
(2) 	<p>USB 2.0 port</p> <p>Connects an optional USB device. For more information about USB devices, see the <i>HP Notebook Reference Guide</i>.</p>
(3)	<p>Optical drive (select models only)</p> <p>Reads an optical disc.</p> <p>NOTE: On select models, the optical drive also writes to an optical disc.</p>
(4)	<p>Optical drive light (select models only)</p> <ul style="list-style-type: none"> On: The optical drive is being accessed. Off: The optical drive is idle.
(5)	<p>Optical drive eject button (select models only)</p> <p>Releases the optical drive disc tray.</p>
(6)	<p>Power connector</p> <p>Connects an AC adapter.</p>
(7) 	<p>AC adapter/battery light</p> <ul style="list-style-type: none"> White: The computer is connected to external power and the battery is charged from 90 to 99 percent. Amber: The computer is connected to external power and the battery is charged from 0 to 90 percent. Blinking amber: A battery that is the only available power source has reached a low battery level. When the battery reaches a critical battery level, the battery light begins blinking rapidly. Off: The battery is fully charged.

3 Illustrated parts catalog

Service tag

When ordering parts or requesting information, provide the computer serial number and model description provided on the service tag.

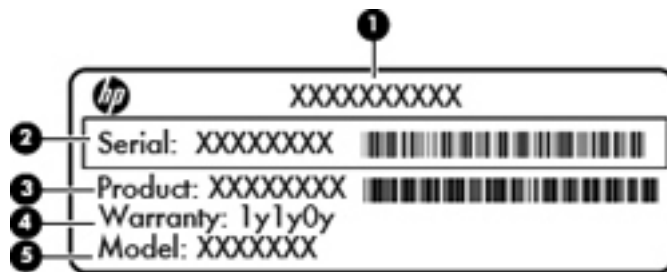

- Product name **(1)**. This is the product name affixed to the front of the computer.
- Serial number (s/n) **(2)**. This is an alphanumeric identifier that is unique to each product.
- Part number/Product number (p/n) **(3)**. This number provides specific information about the product's hardware components. The part number helps a service technician to determine what components and parts are needed.
- Warranty period **(4)**. This number describes the duration (in years) of the warranty period for the computer.
- Model description (select models only) **(5)**. This is the alphanumeric identifier used to locate documents, drivers, and support for the computer.

Computer major components

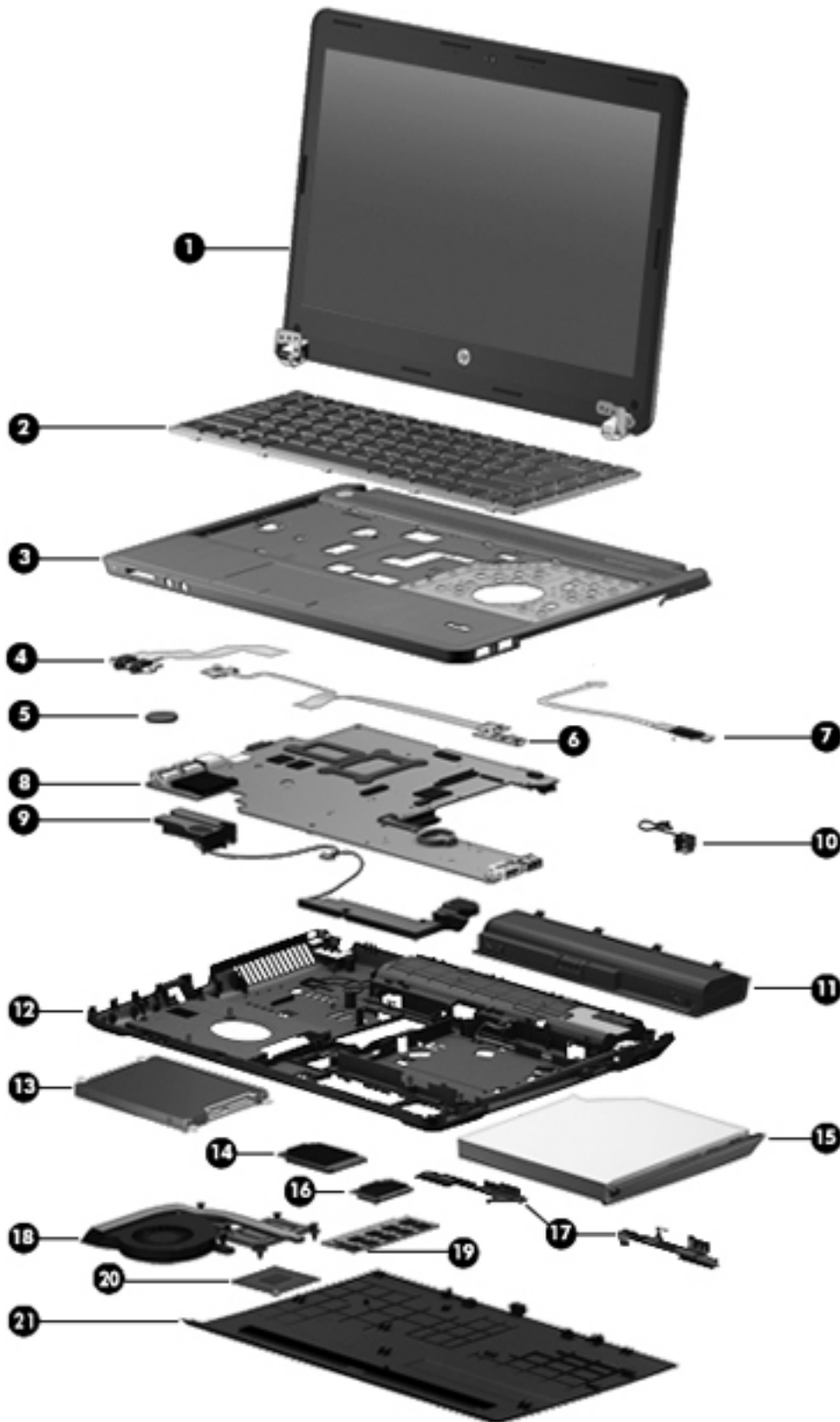

Item	Description	Spare part number
(1)	Display panel , 33.8-cm (13.3-inch) HD, anti-glare	684251-001
(2)	Keyboard (includes cable)	684252-xxx
	NOTE: For a detailed list of available keyboards, see Sequential part number listing on page 21 .	
(3)	Top cover (includes touchpad)	
	For use in models with a fingerprint reader	684243-001
	For use in models without a fingerprint reader	684244-001
(4)	Audio board (includes cable)	684245-001
(5)	RTC battery	684248-001
(6)	Function board/Power button board (includes cables)	684240-001
(7)	Fingerprint reader assembly (includes cable and bracket)	683862-001
(8)	System board (includes replacement thermal material)	
	For use in models with discrete graphics	683855-001
	For use in models with UMA graphics	683856-001
	For use in Japan in models with UMA graphics	696335-001
(9)	Speaker assembly	684242-001
(10)	Power connector cable (includes bracket and screws)	683859-001
(11)	Battery, Li-ion , 6-cell, 51 WHr, 2.55 Ah	669831-001
(12)	Base enclosure	683857-001
(13)	Hard drive	
	500-GB, 5400-rpm	683802-001
	320-GB, 7200-rpm	634862-001
	320-GB, 5400-rpm	645193-001
	128-GB solid-state drive	684253-001
(14)	WWAN modules	
	Ericsson F5321 HSPA+ with GPS	668969-001
	Sierra MC8355 (Gobi3000) HSPA/CDMA	634400-001
(15)	Optical drive (includes bracket, bezel, and screws)	
	DVD±RW Double-Layer Drive	684249-001
	Blu-ray ROM DVD±RW SuperMulti DL Drive	684250-001
(16)	WLAN module	
	Atheros 9485GN 802.11b/g/n 1x1 WiFi and 3012 Bluetooth 4.0 Combo Adapter	655795-001
	Broadcom 4313GN 802.11b/g/n 1x1 WiFi and 20702 Bluetooth 4.0 Combo Adapter	657325-001
	Intel Centrino Wireless-N 2230	670290-001

Item	Description	Spare part number
	Intel Centrino Advanced-N 6235	670292-001
	Ralink WLAN Ralink Ripple3 RT5390F_802.11 b/g/n 1x1 PCIe HMC	670691-001
	Atheros AR9485 802.11b/g/n 1x1 WiFi Adapter	675794-001
(17)	Latch Kit (includes knob, spring, and left and right latches)	686319-001
	Heat sink (includes replacement thermal material)	
(18)	For use in models with discrete graphics	683860-001
	For use in models with UMA graphics	683861-001
(19)	Memory modules	
	4-GB (PC3-12800, 1600-MHz, DDR3)	641369-001
	2-GB (PC3-12800, 1600-MHz, DDR3)	652972-001
(20)	Processor (includes replacement thermal material)	
	Intel Core i7 processor, quad core	
	3612QM, 2.1-GHz processor with 6-MB L3 cache	680647-001
	Intel Core i5 processors, dual core	
	3360M, 2.8-GHz processor with 3-MB L3 cache	681953-001
	3320M, 2.6-GHz processor with 3-MB L3 cache	681952-001
	2450M, 2.5-GHz processor with 3-MB L3 cache	676359-001
	Intel Core i3 processors, dual core	
	3110M, 2.3-GHz processor with 3-MB L3 cache	682417-001
	2370M, 2.4-GHz processor with 3-MB L3 cache	677152-001
	2350M, 2.3-GHz processor with 3-MB L3 cache	653340-001
	Intel Pentium processor, dual core	
	B980, 2.4-GHz, with 2-MB L3 cache	692428-001
	B970, 2.3-GHz, with 2-MB L3 cache	676785-001
	Intel Celeron processor	
	B840, 1.9-GHz, with 2-MB L3 cache	664663-001
(21)	Bottom door	691116-001

Display components



Item	Description	Spare part number
(1)	Display bezel (includes screw covers)	683858-001
(2)	Webcam module	683508-001
	Display Hinge Kit	684239-001
(3)	Display hinge covers (left and right)	
(4)	Display hinges (left and right)	
	Screw covers (not illustrated)	

Plastics Kit



Item	Description	Spare part number
	Plastics Kit	684241-001
(1)	Optical drive protective insert	
(2)	Secure Digital card protective insert	

Mass storage devices



Description	Spare part number
(1) Hard drives	
500-GB, 5400-rpm	683802-001
320-GB, 7200-rpm	634862-001
320-GB, 5400-rpm	645193-001
128-GB solid-state drive	684253-001
Hard Drive Hardware Kit (includes hard drive bracket and screws)	684238-001
(2) Optical drives (include bezel, bracket, and screws)	
DVD±RW Double-Layer Drive	684249-001
Blu-ray ROM DVD±RW SuperMulti DL Drive	684250-001

Miscellaneous parts

Description	Spare part number
Notebook combination lock	591699-001
Cases	
Basic carrying case	455084-001
Professional slim, top load case	592923-001
Nylon case	612757-001
Mice	
Mouse, optical	390632-001
Mouse, optical, travel	434594-001
AC adapters	
65-W AC adapter	693711-001
65-W AC adapter for use in India and the People's Republic of China	693710-001
90-W AC adapter	693712-001
90-W AC adapter for use in India and the People's Republic of China	693713-001
Power cords:	
For use in Australia	490371-011
For use in the People's Republic of China	490371-AA1
For use in Europe, the Middle East, and Africa	490371-021
For use in India	490371-D61
For use in Israel	490371-BB1
For use in Japan	490371-291
For use in South Africa	490371-AR1
For use in South Korea	490371-AD1
For use in Switzerland	490371-111
For use in Taiwan	490371-AB1
For use in Thailand	490371-201
For use in the United Kingdom	490371-031
For use in the United States	490371-001
Rubber Kit (includes bezel screw covers and base enclosure screw plugs)	684246-001
Screw Kit	684247-001

Sequential part number listing

CSR flag designations:

A = Mandatory

B = Optional

C = Service technician recommended

N = Non-user replaceable

Spare part number	CSR flag	Description
390632-001	A	Mouse, optical
434594-001	A	Mouse, optical, travel
455084-001	A	Basic carrying case
490371-001	A	Power cord for use in North America
490371-011	A	Power for cord use in Australia
490371-021	A	Power for cord use in Europe, the Middle East, and Africa
490371-031	A	Power cord for use in the United Kingdom
490371-111	A	Power for cord use in Switzerland
490371-201	A	Power cord for use in Thailand
490371-291	A	Power for cord use in Japan
490371-AA1	A	Power for cord use in the People's Republic of China
490371-AB1	A	Power for cord use in Taiwan
490371-AD1	A	Power for cord use in South Korea
490371-AR1	A	Power for cord use in South Africa
490371-BB1	A	Power cord for use in Israel
490371-D61	A	Power cord for use in India
591699-001	A	Notebook combination lock
592923-001	A	Professional slim, top load case
612757-001	A	Nylon case
634400-001	A	Sierra MC8355 (Gobi3000) HSPA/CDMA
634862-001	A	320-GB, 7200-rpm hard drive, 7 mm
641369-001	A	4-GB memory module (PC3-12800, 1600-MHz, DDR3)
645193-001	A	320-GB, 5400-rpm hard drive, 7 mm
652972-001	A	2-GB memory module (PC3-12800, 1600-MHz, DDR3)
653340-001	N	Intel Core i3 processor, 2350M, 2.3-GHz processor, 3-MB L3 cache (includes thermal material)
655795-001	A	Atheros 9485GN 802.11b/g/n 1x1 WiFi and 3012 Bluetooth 4.0 Combo Adapter

Spare part number	CSR flag	Description
657325-001	A	Broadcom 4313GN 802.11b/g/n 1x1 WiFi and 20702 Bluetooth 4.0 Combo Adapter
664663-001	N	Intel Celeron B840 processor, 1.9-GHz processor, 3-MB L3 cache (includes thermal material)
668969-001	A	Ericsson F5321 HSPA+ with GPS
669831-001	A	6-cell, 51 WHr, 2.55 Ah Li-ion battery
670290-001	A	Intel Centrino Wireless-N 2230 WLAN card
670292-001	A	Intel Centrino Advanced-N 6235 WLAN card
670691-001	A	Ralink WLAN Ralink Ripple3 RT5390F_802.11 b/g/n 1x1 PCIe HMC
675794-001	A	Atheros AR9485 802.11b/g/n 1x1 WiFi Adapter
676359-001	N	Intel Core i5 processor, 2450M, 2.5-GHz, 3-MB L3 cache (includes thermal material)
676785-001	N	Intel Pentium processor, B970, 2.3-GHz, 2-MB L3 cache (includes thermal material)
677152-001	N	Intel Core i3 processor, 2370M, 2.4-GHz, 3-MB L3 cache (includes thermal material)
680647-001	N	Intel Core i7 processor, 3612QM, 2.1-GHz, 6-MB L3 cache (include thermal material)
681952-001	N	Intel Core i5 processor, 3320M, 2.6-GHz, 3-MB L3 cache (include thermal material)
681953-001	N	Intel Core i5 processor, 3360M, 2.8-GHz, 3-MB L3 cache (include thermal material)
682417-001	N	Intel Core i3 processor, 3110M, 2.3-GHz, 3-MB L3 cache (include thermal material)
683508-001	N	Webcam module
683802-001	A	500-GB, 5400-rpm hard drive, 7 mm
683855-001	N	System board for use in models with discrete graphics (includes replacement thermal material)
683856-001	N	System board for use in models with UMA graphics (includes replacement thermal material)
683857-001	N	Base enclosure
683858-001	N	Display bezel (includes screw covers)
683859-001	N	Power connector cable (includes bracket and screws)
683860-001	N	Heat sink for use in models with discrete graphics (includes replacement thermal material)
683861-001	N	Heat sink for use in models with UMA graphics (includes replacement thermal material)
683862-001	N	Fingerprint reader assembly (includes cable)
684238-001	N	Hard Drive Hardware Kit (includes hard drive bracket and screws)
684239-001	N	Display Hinge Kit (includes left and right display hinges, left and right display hinge covers, bezel screw covers, and screws)
684240-001	N	Function board/Power button board (includes cable)
684241-001	N	Plastics Kit (includes optical drive protective insert and Secure Digital card protective insert)
684242-001	N	Speaker assembly
684243-001	N	Top cover for use in models with a fingerprint reader (includes touchpad)
684244-001	N	Top cover for use in models without a fingerprint reader (includes touchpad)
684245-001	N	Audio board (includes cable)

Spare part number	CSR flag	Description
684246-001	N	Rubber Kit (includes bezel screw covers and base enclosure screw plugs)
684247-001	N	Screw Kit
684248-001	N	RTC battery
684249-001	A	DVD±RW Double-Layer Drive (includes bezel, bracket, and screws)
684250-001	A	Blu-ray ROM DVD±RW SuperMulti DL Drive (includes bezel, bracket, and screws)
684251-001	N	Display panel, 33.8-cm (13.3-inch), anti-glare
684252-001	A	Keyboard for use in the United States
684252-031	A	Keyboard for use in the United Kingdom
684252-041	A	Keyboard for use in Germany
684252-051	A	Keyboard for use in France
684252-061	A	Keyboard for use in Italy
684252-071	A	Keyboard for use in Spain
684252-131	A	Keyboard for use in Portugal
684252-141	A	Keyboard for use in Turkey
684252-151	A	Keyboard for use in Greece
684252-171	A	Keyboard for use in Saudi Arabia
684252-211	A	Keyboard for use in Hungary
684252-251	A	Keyboard for use in Russia
684252-261	A	Keyboard for use in Bulgaria
684252-271	A	Keyboard for use in Romania
684252-281	A	Keyboard for use in Thailand
684252-291	A	Keyboard for use in Japan
684252-A41	A	Keyboard for use in Belgium
684252-AB1	A	Keyboard for use in Taiwan
684252-AD1	A	Keyboard for use in South Korea
684252-B31	A	Keyboard for use in the Netherlands and Europe
684252-BA1	A	Keyboard for use in Slovakia
684252-BB1	A	Keyboard for use in Israel
684252-BG1	A	Keyboard for use in Switzerland
684252-D61	A	Keyboard for use in India
684252-DD1	A	Keyboard for use in Iceland
684252-DH1	A	Keyboard for use in the Netherlands
684252-FL1	A	Keyboard for use in the Czech Republic and Slovakia
684252-FP1	A	Keyboard for use in Africa

Spare part number	CSR flag	Description
684253-001	A	128-GB solid-state drive
686319-001	N	Latch Kit (includes knob, spring, and left and right latches)
691116-001	A	Bottom door
692428-001	N	Intel Pentium processor, B980, 2.4-GHz, 2-MB L3 cache (includes thermal material)
693710-001	A	65-W AC adapter for use in India and the People's Republic of China
693711-001	A	65-W AC adapter
693712-001	A	90-W AC adapter
693713-001	A	90-W AC adapter for use in India and the People's Republic of China
696335-001	N	System board for use in Japan in models with UMA graphics

4 Removal and replacement procedures

Preliminary replacement requirements

Tools required

You will need the following tools to complete the removal and replacement procedures:

- Flat-bladed screwdriver
- Phillips P0 and P1 screwdrivers
- Torx T8 screwdriver

Service considerations

The following sections include some of the considerations that you must keep in mind during disassembly and assembly procedures.

 **NOTE:** As you remove each subassembly from the computer, place the subassembly (and all accompanying screws) away from the work area to prevent damage.

Plastic parts

 **CAUTION:** Using excessive force during disassembly and reassembly can damage plastic parts. Use care when handling the plastic parts. Apply pressure only at the points designated in the maintenance instructions.

Cables and connectors

⚠ CAUTION: When servicing the computer, be sure that cables are placed in their proper locations during the reassembly process. Improper cable placement can damage the computer.

Cables must be handled with extreme care to avoid damage. Apply only the tension required to unseat or seat the cables during removal and insertion. Handle cables by the connector whenever possible. In all cases, avoid bending, twisting, or tearing cables. Be sure that cables are routed in such a way that they cannot be caught or snagged by parts being removed or replaced. Handle flex cables with extreme care; these cables tear easily.

Drive handling

⚠ CAUTION: Drives are fragile components that must be handled with care. To prevent damage to the computer, damage to a drive, or loss of information, observe these precautions:

Before removing or inserting a hard drive, shut down the computer. If you are unsure whether the computer is off or in Hibernation, turn the computer on, and then shut it down through the operating system.

Before handling a drive, be sure that you are discharged of static electricity. While handling a drive, avoid touching the connector.

Before removing a diskette drive or optical drive, be sure that a diskette or disc is not in the drive and be sure that the optical drive tray is closed.

Handle drives on surfaces covered with at least one inch of shock-proof foam.

Avoid dropping drives from any height onto any surface.

After removing a hard drive, an optical drive, or a diskette drive, place it in a static-proof bag.

Avoid exposing a hard drive to products that have magnetic fields, such as monitors or speakers.

Avoid exposing a drive to temperature extremes or liquids.

If a drive must be mailed, place the drive in a bubble pack mailer or other suitable form of protective packaging and label the package "FRAGILE."

Grounding guidelines

Electrostatic discharge damage

Electronic components are sensitive to electrostatic discharge (ESD). Circuitry design and structure determine the degree of sensitivity. Networks built into many integrated circuits provide some protection, but in many cases, ESD contains enough power to alter device parameters or melt silicon junctions.

A discharge of static electricity from a finger or other conductor can destroy static-sensitive devices or microcircuitry. Even if the spark is neither felt nor heard, damage may have occurred.

An electronic device exposed to ESD may not be affected at all and can work perfectly throughout a normal cycle. Or the device may function normally for a while, and then degrade in the internal layers, reducing its life expectancy.

CAUTION: To prevent damage to the computer when you are removing or installing internal components, observe these precautions:

Keep components in their electrostatic-safe containers until you are ready to install them.

Use nonmagnetic tools.

Before touching an electronic component, discharge static electricity by using the guidelines described in this section.

Avoid touching pins, leads, and circuitry. Handle electronic components as little as possible.

If you remove a component, place it in an electrostatic-safe container.

The following table shows how humidity affects the electrostatic voltage levels generated by different activities.

CAUTION: A product can be degraded by as little as 700 V.

Typical electrostatic voltage levels			
Event	Relative humidity		
	10%	40%	55%
Walking across carpet	35,000 V	15,000 V	7,500 V
Walking across vinyl floor	12,000 V	5,000 V	3,000 V
Motions of bench worker	6,000 V	800 V	400 V
Removing DIPS from plastic tube	2,000 V	700 V	400 V
Removing DIPS from vinyl tray	11,500 V	4,000 V	2,000 V
Removing DIPS from Styrofoam	14,500 V	5,000 V	3,500 V
Removing bubble pack from PCB	26,500 V	20,000 V	7,000 V
Packing PCBs in foam-lined box	21,000 V	11,000 V	5,000 V

Packaging and transporting guidelines

Follow these grounding guidelines when packaging and transporting equipment:

- To avoid hand contact, transport products in static-safe tubes, bags, or boxes.
- Protect ESD-sensitive parts and assemblies with conductive or approved containers or packaging.
- Keep ESD-sensitive parts in their containers until the parts arrive at static-free workstations.
- Place items on a grounded surface before removing items from their containers.
- Always be properly grounded when touching a component or assembly.
- Store reusable ESD-sensitive parts from assemblies in protective packaging or nonconductive foam.
- Use transporters and conveyors made of antistatic belts and roller bushings. Be sure that mechanized equipment used for moving materials is wired to ground and that proper materials are selected to avoid static charging. When grounding is not possible, use an ionizer to dissipate electric charges.

Workstation guidelines

Follow these grounding workstation guidelines:

- Cover the workstation with approved static-shielding material.
- Use a wrist strap connected to a properly grounded work surface and use properly grounded tools and equipment.
- Use conductive field service tools, such as cutters, screwdrivers, and vacuums.
- When fixtures must directly contact dissipative surfaces, use fixtures made only of static-safe materials.
- Keep the work area free of nonconductive materials, such as ordinary plastic assembly aids and Styrofoam.
- Handle ESD-sensitive components, parts, and assemblies by the case or PCM laminate. Handle these items only at static-free workstations.
- Avoid contact with pins, leads, or circuitry.
- Turn off power and input signals before inserting or removing connectors or test equipment.

Equipment guidelines

Grounding equipment must include either a wrist strap or a foot strap at a grounded workstation.

- When seated, wear a wrist strap connected to a grounded system. Wrist straps are flexible straps with a minimum of one megohm $\pm 10\%$ resistance in the ground cords. To provide proper ground, wear a strap snugly against the skin at all times. On grounded mats with banana-plug connectors, use alligator clips to connect a wrist strap.
- When standing, use foot straps and a grounded floor mat. Foot straps (heel, toe, or boot straps) can be used at standing workstations and are compatible with most types of shoes or boots. On conductive floors or dissipative floor mats, use foot straps on both feet with a minimum of one megohm resistance between the operator and ground. To be effective, the conductive strips must be worn in contact with the skin.

The following grounding equipment is recommended to prevent electrostatic damage:

- Antistatic tape
- Antistatic smocks, aprons, and sleeve protectors
- Conductive bins and other assembly or soldering aids
- Nonconductive foam
- Conductive tabletop workstations with ground cords of one megohm resistance
- Static-dissipative tables or floor mats with hard ties to the ground
- Field service kits
- Static awareness labels
- Material-handling packages
- Nonconductive plastic bags, tubes, or boxes
- Metal tote boxes
- Electrostatic voltage levels and protective materials

The following table lists the shielding protection provided by antistatic bags and floor mats.

Material	Use	Voltage protection level
Antistatic plastic	Bags	1,500 V
Carbon-loaded plastic	Floor mats	7,500 V
Metallized laminate	Floor mats	5,000 V

Component replacement procedures

This chapter provides removal and replacement procedures.

There are as many as 95 screws and screw locks, in 15 different sizes, that must be removed, replaced, or loosened when servicing the computer. Make special note of each screw and screw lock size and location during removal and replacement.

Service tag

When ordering parts or requesting information, provide the computer serial number and model description provided on the service tag.

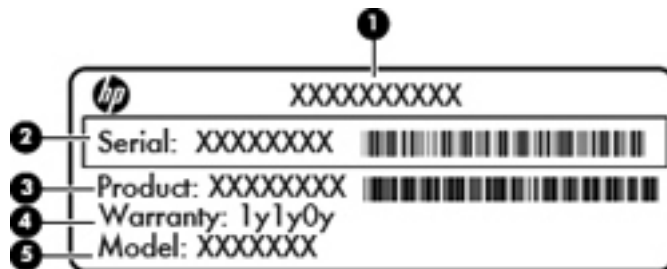

- Product name **(1)**. This is the product name affixed to the front of the computer.
- Serial number (s/n) **(2)**. This is an alphanumeric identifier that is unique to each product.
- Part number/Product number (p/n) **(3)**. This number provides specific information about the product's hardware components. The part number helps a service technician to determine what components and parts are needed.
- Warranty period **(4)**. This number describes the duration (in years) of the warranty period for the computer.
- Model description (select models only) **(5)**. This is the alphanumeric identifier used to locate documents, drivers, and support for the computer.

Battery

Description	Spare part number
6-cell, 51 WHr, 2.55 Ah Li-ion battery	669831-001

Before disassembling the computer, follow these steps:

1. Shut down the computer. If you are unsure whether the computer is off or in Hibernation, turn the computer on, and then shut it down through the operating system.
2. Disconnect all external devices connected to the computer.
3. Disconnect the power from the computer by first unplugging the power cord from the AC outlet, and then unplugging the AC adapter from the computer.

Remove the battery:

1. Position the computer upside-down on a flat surface.
2. Slide the battery release latches (1) to release the battery.

 **NOTE:** You can slide the battery release latches simultaneously or one at a time.

3. Tilt the battery upward (2) to remove it from the battery bay (3).



Install the battery by inserting it into the battery bay until you hear a click.

Using the optional security screw

Use the optional security screw to lock the service door to the bottom of the computer. When not in use the security screw can be stored inside the battery bay.

Remove the battery:

To use the security screw:

1. Remove the battery.
2. Remove the security screw from inside the battery bay (1) and insert it (2) to lock the service door in place.



Bottom door

Description	Spare part number
Bottom door	691116-001

Before disassembling the computer, follow these steps:

1. Shut down the computer. If you are unsure whether the computer is off or in Hibernation, turn the computer on, and then shut it down through the operating system.
2. Disconnect all external devices connected to the computer.
3. Disconnect the power from the computer by first unplugging the power cord from the AC outlet, and then unplugging the AC adapter from the computer.
4. Remove the battery (see [Battery on page 31](#)).

Remove the bottom door:

1. Position the computer upside-down on a flat surface, with the battery bay toward you.
2. With the battery bay toward you, remove the security screw **(1)** (if the security screw is being used). For additional information about the security screw, see [Using the optional security screw on page 32](#).
3. Slide the service door release latches **(2)** to release the service door.

 **NOTE:** You can slide the service door release latches simultaneously or you can slide them one at a time.

4. Slide the service door towards the front of the computer **(3)** and then lift it **(4)** away from the computer.

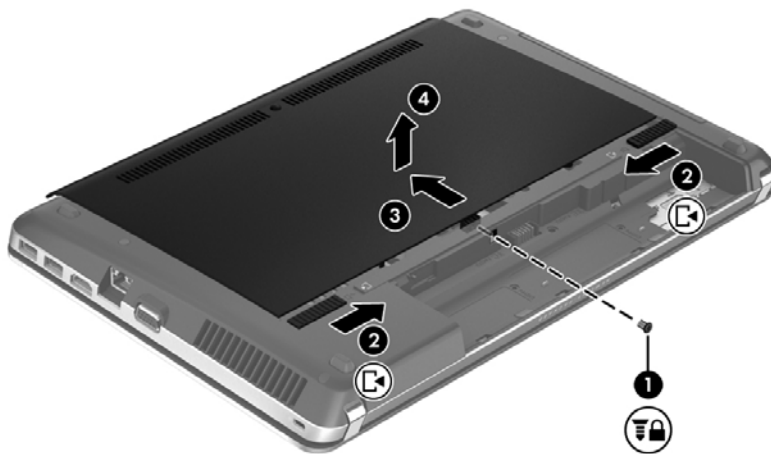

Reverse the removal procedures to install the bottom door.

SIM

 **NOTE:** This section applies only to computer models with WWAN capability.

 **NOTE:** The SIM is provided by the end-user as a security measure for the WWAN module. The SIM should be removed, placed into a static-dissipative container, and then replaced when the computer is reassembled.

Before removing the SIM, follow these steps:

1. Shut down the computer. If you are unsure whether the computer is off or in Hibernation, turn the computer on, and then shut it down through the operating system.
2. Disconnect all external devices connected to the computer.
3. Disconnect the power from the computer by first unplugging the power cord from the AC outlet, and then unplugging the AC adapter from the computer.
4. Remove the battery (see [Battery on page 31](#)).
5. Remove the bottom door (see [Bottom door on page 33](#)).

Remove the SIM:

1. Unlock the SIM holder (1).
2. Rotate the SIM holder upright (2).
3. Remove the SIM (3) from the SIM holder.

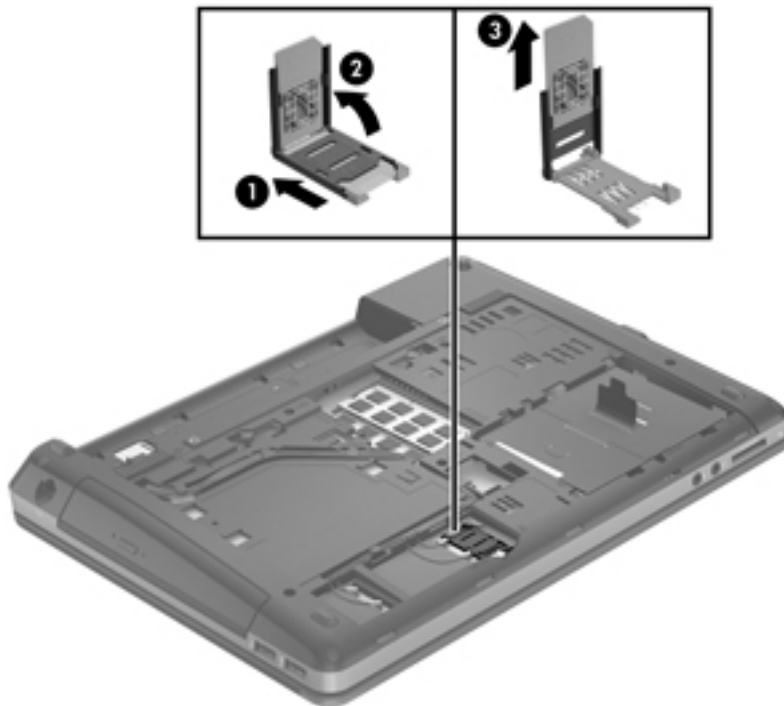

Reverse this procedure to install the SIM.

Optical drive



NOTE: All optical drive spare part kits include an optical drive bezel, bracket, and screws.

Description	Spare part number
DVD±RW Double-Layer Drive	684249-001
Blu-ray ROM DVD±RW SuperMulti DL Drive	684250-001

Before removing the optical drive, follow these steps:

1. Shut down the computer. If you are unsure whether the computer is off or in Hibernation, turn the computer on, and then shut it down through the operating system.
2. Disconnect all external devices connected to the computer.
3. Disconnect the power from the computer by first unplugging the power cord from the AC outlet, and then unplugging the AC adapter from the computer.
4. Remove the battery (see [Battery on page 31](#)).
5. Remove the bottom door (see [Bottom door on page 33](#)).

Remove the optical drive:

1. Position the computer upside-down with the right side toward you.
2. Remove the Phillips PM2.5×6.0 screw **(1)** that secures the optical drive to the computer.
3. Push the optical drive tab **(2)** to release the optical drive from the computer.

4. Remove the optical drive **(3)** from the computer.

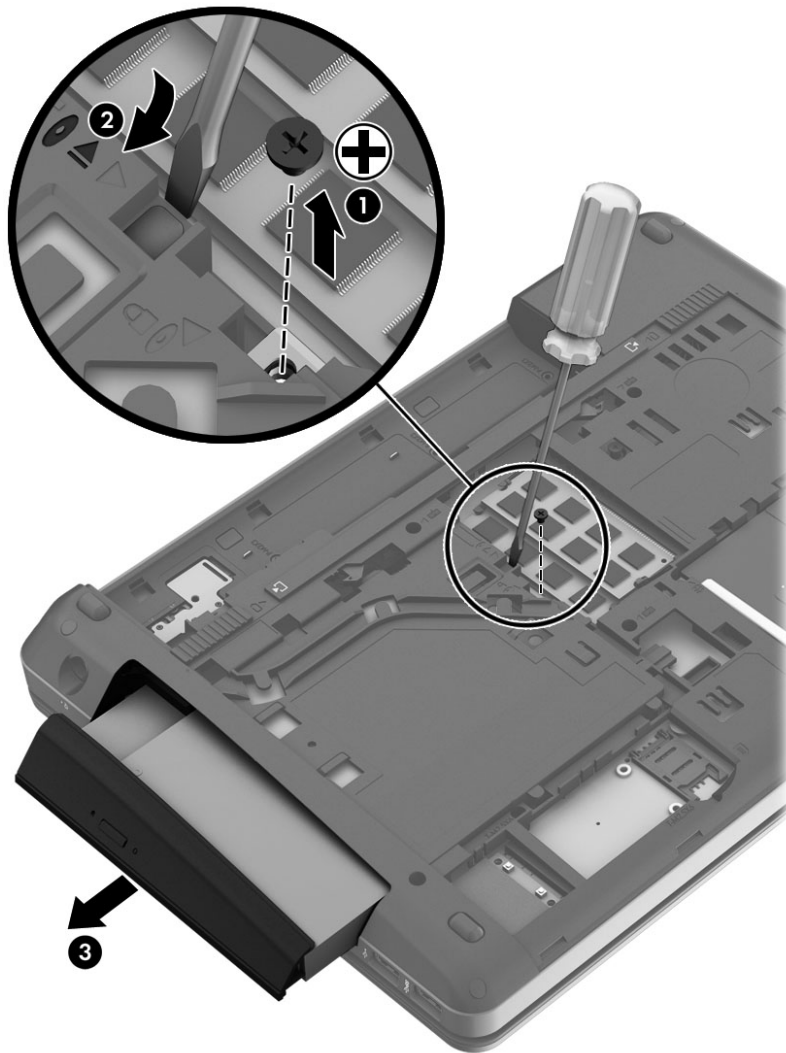

Reverse this procedure to install an optical drive.

Hard drive



NOTE: All hard drive spare part kits include a hard drive bracket and screws.

Description	Spare part number
500-GB, 5400-rpm hard drive, 7 mm	683802-001
320-GB, 7200-rpm hard drive, 7 mm	634862-001
320-GB, 5400-rpm hard drive, 7 mm	645193-001
128-GB solid-state drive	684253-001
Hard Drive Hardware Kit (includes hard drive bracket and screws)	684238-001

Before disassembling the computer, follow these steps:

1. Shut down the computer. If you are unsure whether the computer is off or in Hibernation, turn the computer on, and then shut it down through the operating system.
2. Disconnect all external devices connected to the computer.
3. Disconnect the power from the computer by first unplugging the power cord from the AC outlet, and then unplugging the AC adapter from the computer.
4. Remove the battery (see [Battery on page 31](#)).
5. Remove the bottom door (see [Bottom door on page 33](#)).



NOTE: Instructions for removing the hard drive are imprinted on the service door.

Remove the hard drive:

1. Position the computer upside-down, with the battery bay toward you.
2. Remove the four Phillips PM2.5×2.5 screws **(1)** that secure the hard drive to the computer.

3. Pull the Mylar tab on the hard drive (2) toward the side of the computer to disengage the hard drive from the connector, and then lift the hard drive out of the hard drive bay.

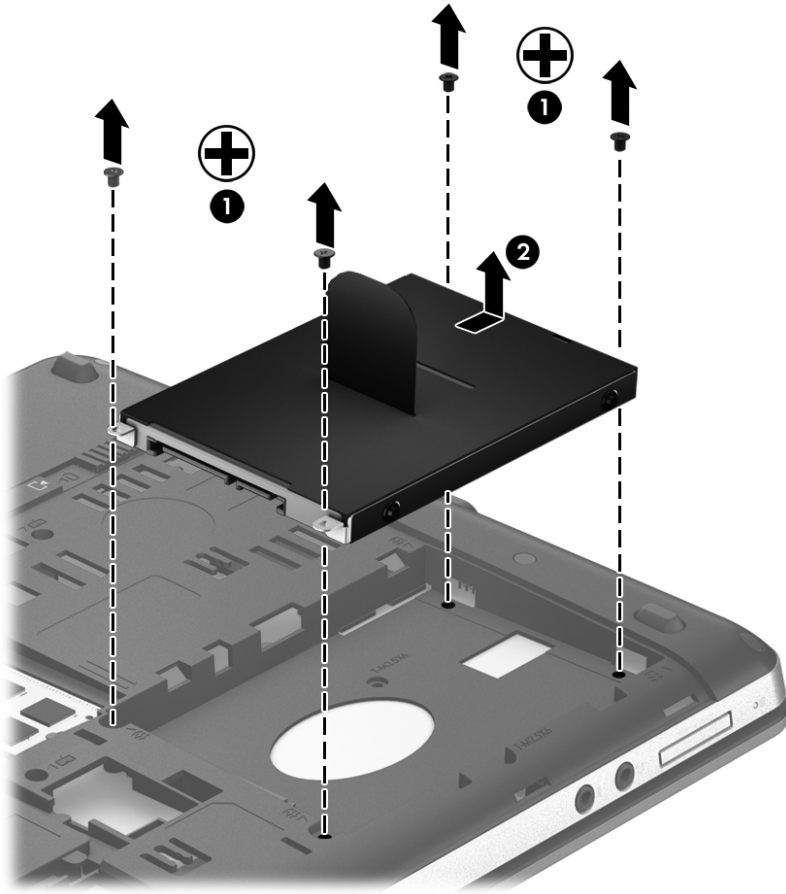

4. If it is necessary to replace the hard drive cover, lift the Mylar tab to unlock it.

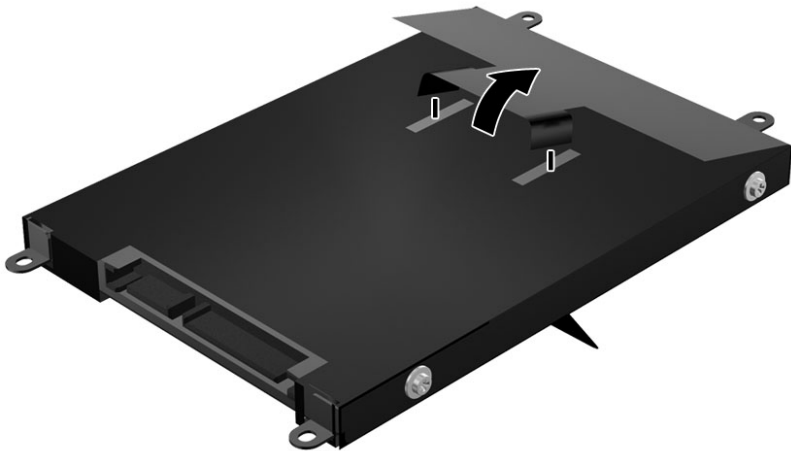

5. Remove the four Phillips PM3.0×3.0 hard drive cover screws (1) that secure the cover to the hard drive.

- Lift the top of the Mylar cover (2) from the drive, and then remove the cover from the hard drive (3).

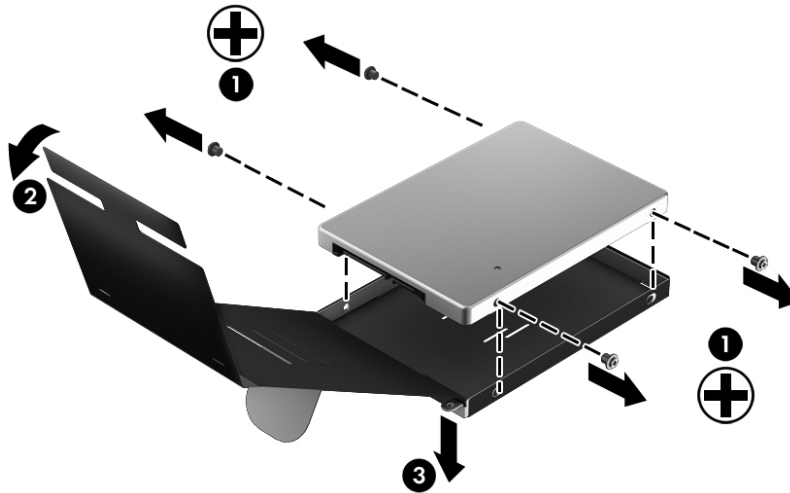

Reverse this procedure to reassemble and install the hard drive.

Memory modules

NOTE: Primary and expansion memory is installed in a stacked configuration in the bottom of the computer.

Description	Spare part number
2-GB (PC3-12800, 1600-MHz, DDR3)	652972-001
4-GB (PC3-12800, 1600-MHz, DDR3)	641369-001

Before removing the memory module, follow these steps:

- Shut down the computer. If you are unsure whether the computer is off or in Hibernation, turn the computer on, and then shut it down through the operating system.
- Disconnect all external devices connected to the computer.
- Disconnect the power from the computer by first unplugging the power cord from the AC outlet, and then unplugging the AC adapter from the computer.
- Remove the battery (see [Battery on page 31](#)).
- Remove the bottom door (see [Bottom door on page 33](#)).

Remove the memory module:

- Position the computer upside-down with the battery bay toward you.
- Spread the retaining tabs (1) on each side of the memory module slot to release the memory module. (The edge of the module opposite the slot rises away from the computer.)

3. Remove the memory module **(2)** by pulling the module away from the slot at an angle.

 **NOTE:** Memory modules are designed with a notch to prevent incorrect insertion into the memory module slot.

 **NOTE:** The computer uses two memory sockets. The top socket houses the expansion memory module and the bottom socket houses the primary memory module. The removal procedure is the same for both memory sockets.

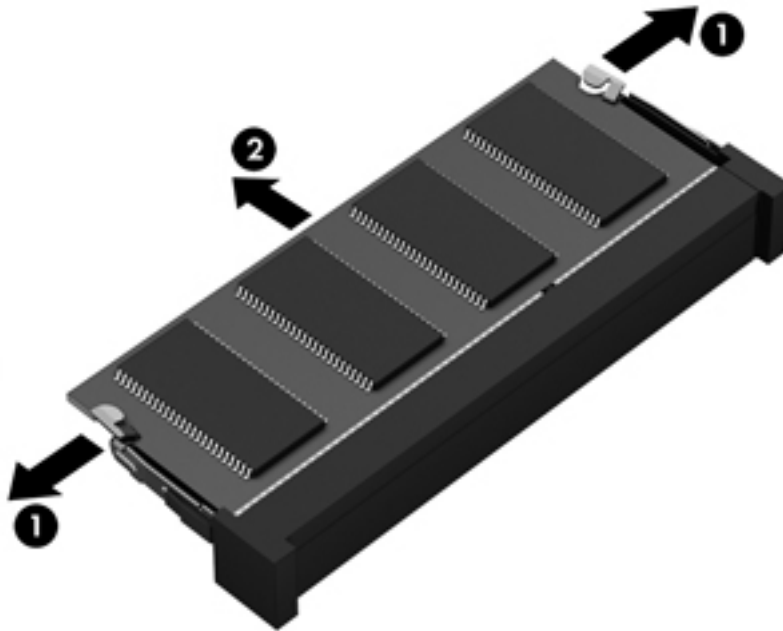

Reverse this procedure to install a memory module.

WWAN module

 **CAUTION:** The WWAN module and the WLAN module are not interchangeable.

Description	Spare part number
Ericsson F5321 HSPA+ with GPS	668969-001
Sierra MC8355 (Gobi3000) HSPA/CDMA	634400-001

Before removing the WWAN module, follow these steps:

1. Shut down the computer. If you are unsure whether the computer is off or in Hibernation, turn the computer on, and then shut it down through the operating system.
2. Disconnect all external devices connected to the computer.
3. Disconnect the power from the computer by first unplugging the power cord from the AC outlet, and then unplugging the AC adapter from the computer.
4. Remove the battery (see [Battery on page 31](#)).
5. Remove the bottom door (see [Bottom door on page 33](#)).

Remove the WWAN module:

1. Position the computer upside-down.
2. Disconnect the WWAN antenna cables **(1)** from the terminals on the WWAN module.



NOTE: The red WWAN antenna cable is connected to the WWAN module “Main” terminal. The blue WWAN antenna cable is connected to the WWAN module “Aux” terminal.

3. Remove the two Phillips PM2.5×3.0 screws **(2)** that secure the WWAN module to the computer. (The edge of the module opposite the slot rises away from the computer.)

4. Remove the WWAN module (3) by pulling the module away from the slot at an angle.



 **NOTE:** WWAN modules are designed with a notch to prevent incorrect insertion.

Figure 4-1 Removing the WWAN module



 **NOTE:** If the WWAN antennas are not connected to the terminals on the WWAN module, the protective sleeves must be installed on the antenna connectors, as shown in the following illustration.

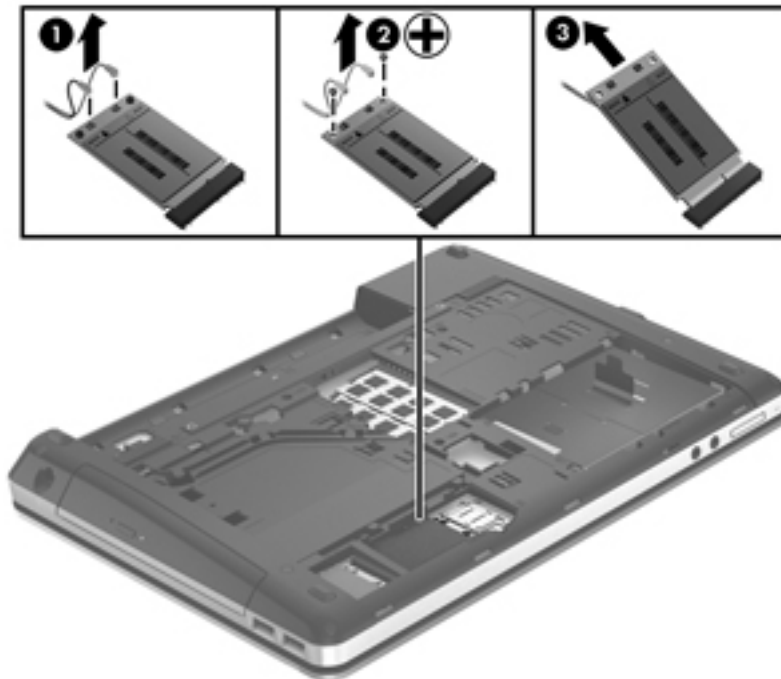

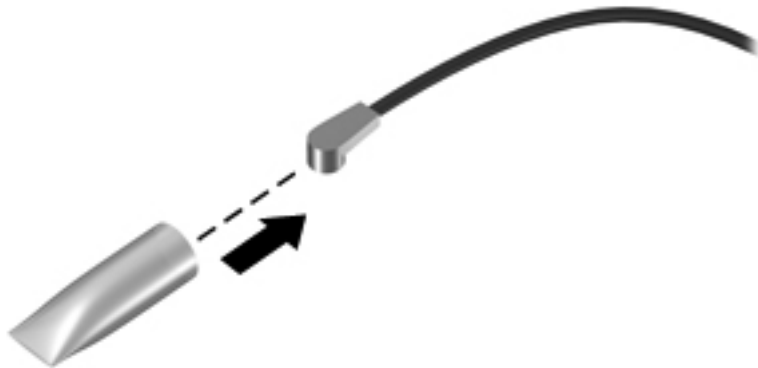
Reverse this procedure to install the WWAN module.

WLAN/Bluetooth combo card

The computer uses a card that provides both WLAN and Bluetooth functionality.

 **CAUTION:** The WLAN module and the WWAN module are not interchangeable.

Description	Spare part number
Atheros 9485GN 802.11b/g/n 1x1 WiFi and 3012 Bluetooth 4.0 Combo Adapter	655795-001
Broadcom 4313GN 802.11b/g/n 1x1 WiFi and 20702 Bluetooth 4.0 Combo Adapter	657325-001
Intel Centrino Wireless-N 2230	670290-001
Intel Centrino Advanced-N 6235	670292-001
Ralink WLAN Ralink Ripple3 RT5390F_802.11 b/g/n 1x1 PCIe HMC	670691-001
Atheros AR9485 802.11b/g/n 1x1 WiFi Adapter	675794-001

Before removing the WLAN module, follow these steps:

1. Shut down the computer. If you are unsure whether the computer is off or in Hibernation, turn the computer on, and then shut it down through the operating system.
2. Disconnect all external devices connected to the computer.
3. Disconnect the power from the computer by first unplugging the power cord from the AC outlet, and then unplugging the AC adapter from the computer.
4. Remove the battery (see [Battery on page 31](#)).
5. Remove the bottom door (see [Bottom door on page 33](#)).

Remove the WLAN module:

1. Position the computer upside-down.
2. Disconnect the WLAN antenna cables **(1)** from the terminals on the WLAN module.

 **NOTE:** The WLAN antenna cable labeled “1” connects to the WLAN module “Main” terminal labeled “1”. The WLAN antenna cable labeled “2” connects to the WLAN module “Aux” terminal labeled “2”. If the computer is equipped with an 802.11a/b/g/n WLAN module, the yellow WLAN antenna cable connects to the middle terminal on the WLAN module.

3. Remove the two Phillips PM2.5×3.0 screws **(2)** that secure the WLAN module to the computer. (The edge of the module opposite the slot rises away from the computer.)

4. Remove the WLAN module (3) by pulling the module away from the slot at an angle.

 **NOTE:** WLAN modules are designed with a notch to prevent incorrect insertion.

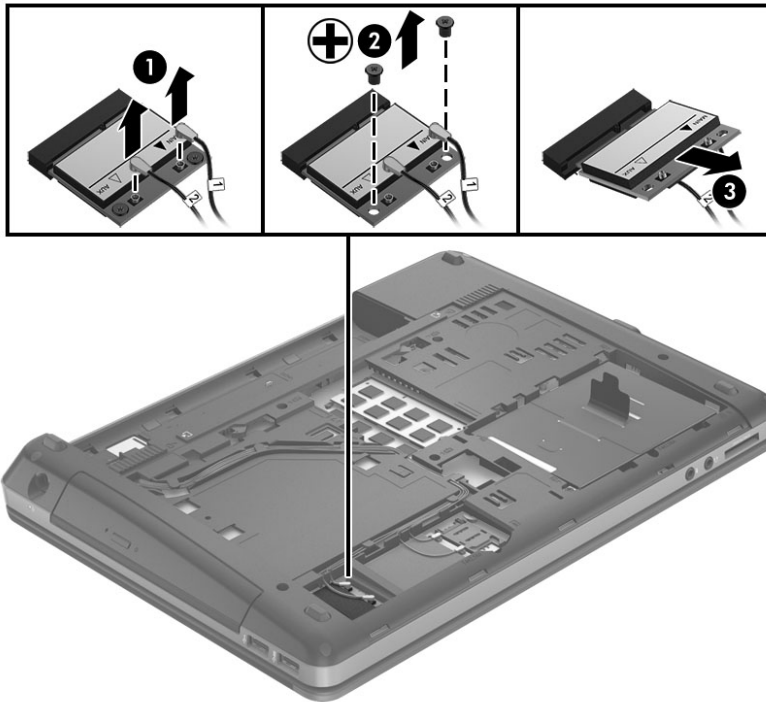

 **NOTE:** If the WLAN antennas are not connected to the terminals on the WLAN module, the protective sleeves must be installed on the antenna connectors, as shown in the following illustration.

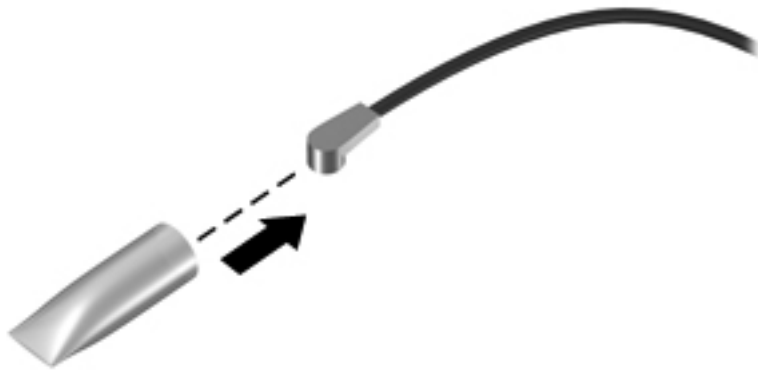

Reverse this procedure to install the WLAN module.

Keyboard



NOTE: For a detailed list of available keyboards, see [Sequential part number listing on page 21](#).

Description	Spare part number
Keyboard	684252-xx1

Before removing the keyboard, follow these steps:

1. Shut down the computer. If you are unsure whether the computer is off or in Hibernation, turn the computer on, and then shut it down through the operating system.
2. Disconnect all external devices connected to the computer.
3. Disconnect the power from the computer by first unplugging the power cord from the AC outlet, and then unplugging the AC adapter from the computer.
4. Remove the battery (see [Battery on page 31](#)).
5. Remove the bottom door (see [Bottom door on page 33](#)).

Remove the keyboard:

1. Position the computer upside-down with the front toward you.
2. Remove the three Phillips PM2.5×6.0 screws that secure the keyboard to the computer.

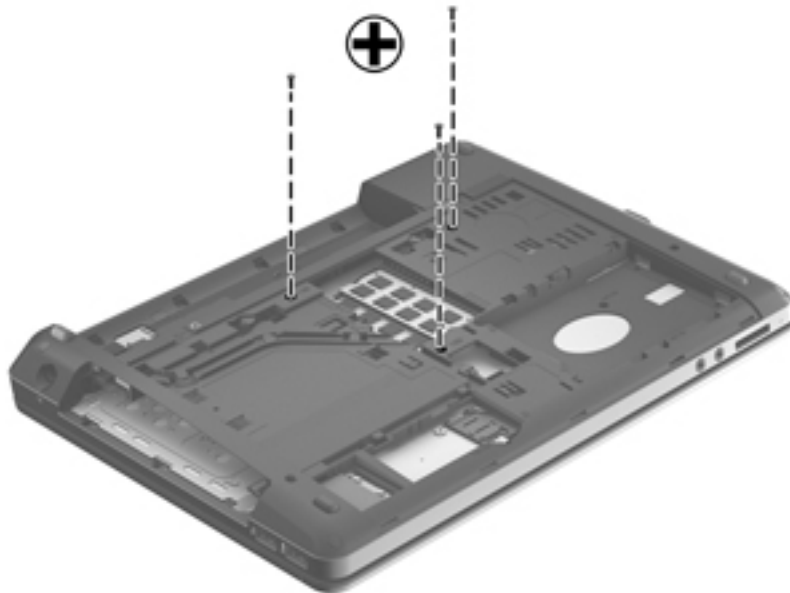

3. Position the computer right-side up with the front toward you.
4. Open the computer as far as possible.
5. Slide the keyboard downward toward the palm rest **(1)**.

6. Lift the top of the keyboard at an angle (2), and then pull the keyboard up to remove it from the palm rest (3).

 **NOTE:** Only pull the keyboard up enough to release it from the computer and flip it over onto the palm rest. Under the keyboard, the cable is connected to the system board.



7. Rotate the keyboard until it rests on the palm rest (1), and then disconnect the keyboard cable by lifting the keyboard connector latch (2), and then disconnecting the keyboard cable from the system board (3).

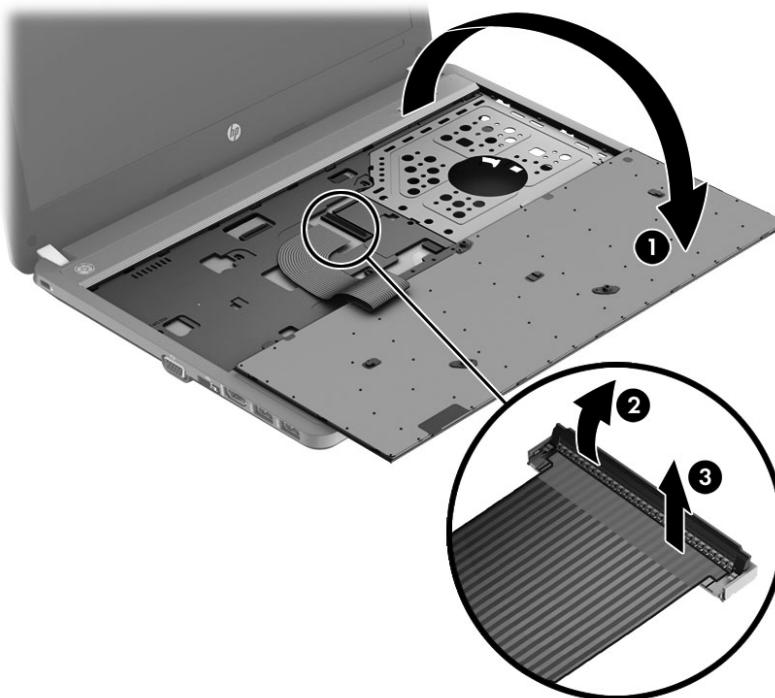

8. Remove the keyboard.

Reverse this procedure to install the keyboard.

Top cover



NOTE: All top cover spare part kits include a touchpad.

Description	Spare part number
Top cover for use in models with a fingerprint reader (includes touchpad)	684243-001
Top cover for use in models without a fingerprint reader (includes touchpad)	684244-001

Before removing the top cover, follow these steps:

1. Shut down the computer. If you are unsure whether the computer is off or in Hibernation, turn the computer on, and then shut it down through the operating system.
2. Disconnect all external devices connected to the computer.
3. Disconnect the power from the computer by first unplugging the power cord from the AC outlet, and then unplugging the AC adapter from the computer.
4. Remove the battery (see [Battery on page 31](#)).
5. Remove the following components:
 - a. Bottom door (see [Bottom door on page 33](#)).
 - b. Hard drive (see [Hard drive on page 37](#))
 - c. Optical drive (see [Optical drive on page 35](#))
 - d. Keyboard (see [Keyboard on page 45](#))

Remove the top cover:

1. Position the computer upside-down with the front toward you.

2. Remove the following covers and screws that secure the top cover to the computer:
 - (1) 4 rubber screw covers
 - (2) 11 Torx T8M2.5×6.0 screws

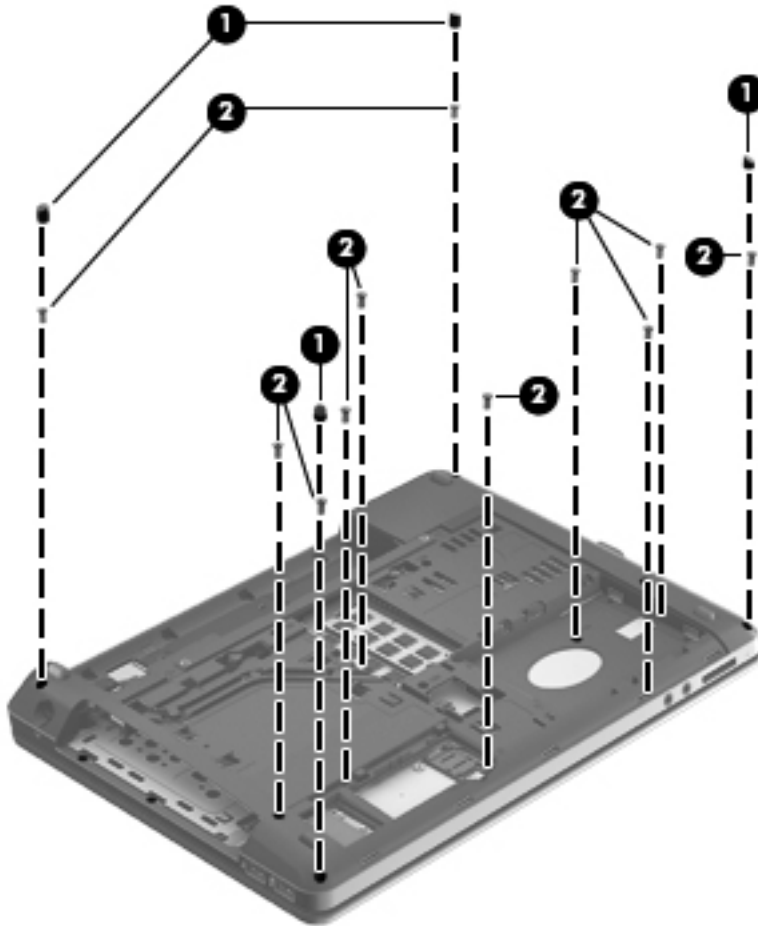

3. Remove the following screws that secure the top cover to the computer:
 - (1) 3 Phillips PM2.0×2.0 screws from the battery bay
 - (2) 3 Phillips PM2.0×2.0 screws from the optical drive bay

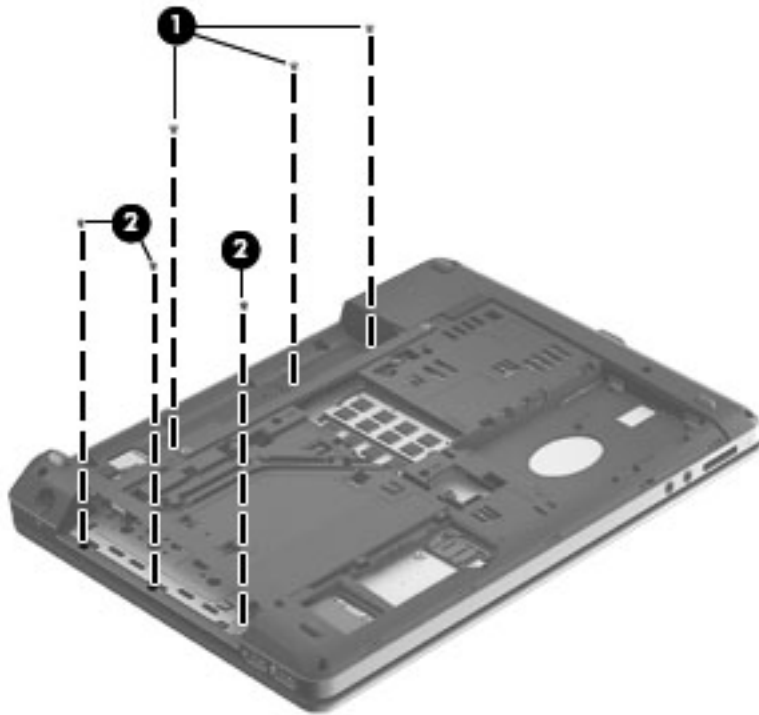

4. Position the computer upright with the front toward you.

5. Disconnect the following cables from the system board:
 - (1) Power button/function board cable
 - (2) Audio board cable
 - (3) Fingerprint reader board cable

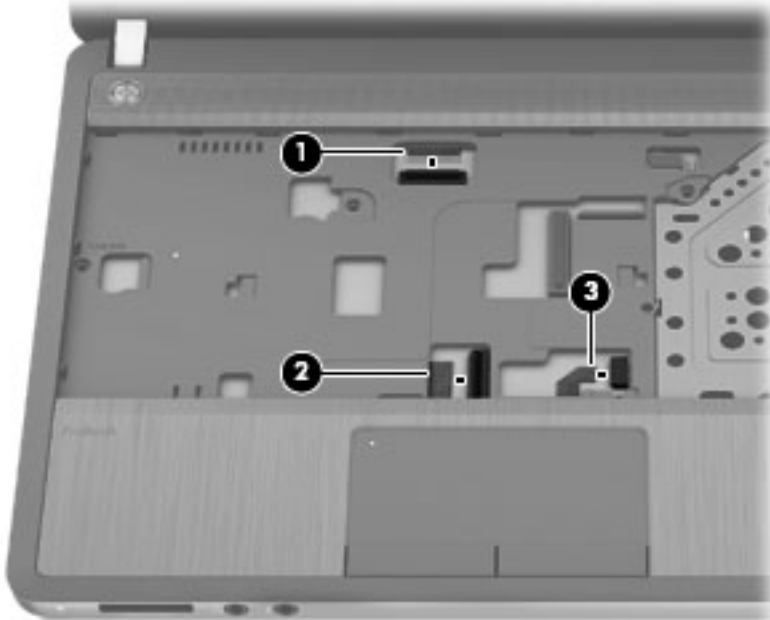

6. Remove the Torx T8M2.5×6.0 screw that secures the top cover to the computer.

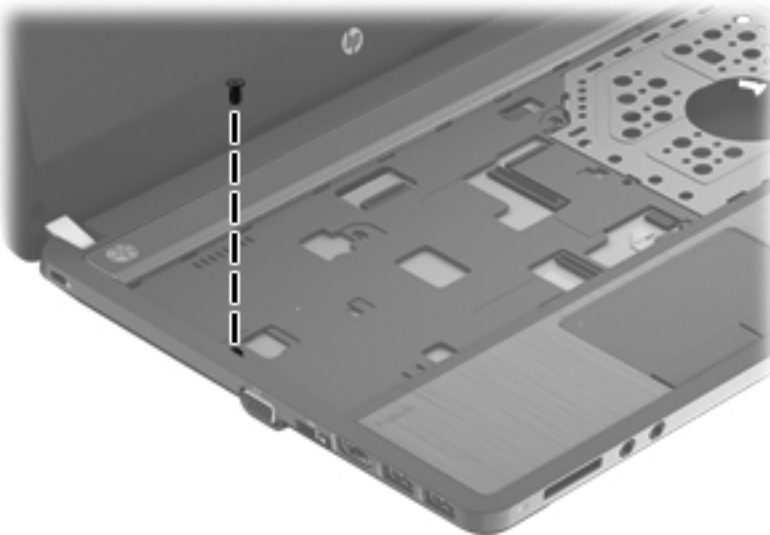

7. Pry up on the top of the top cover (1) to disengage it from the computer, and then remove the top cover from the computer (2).

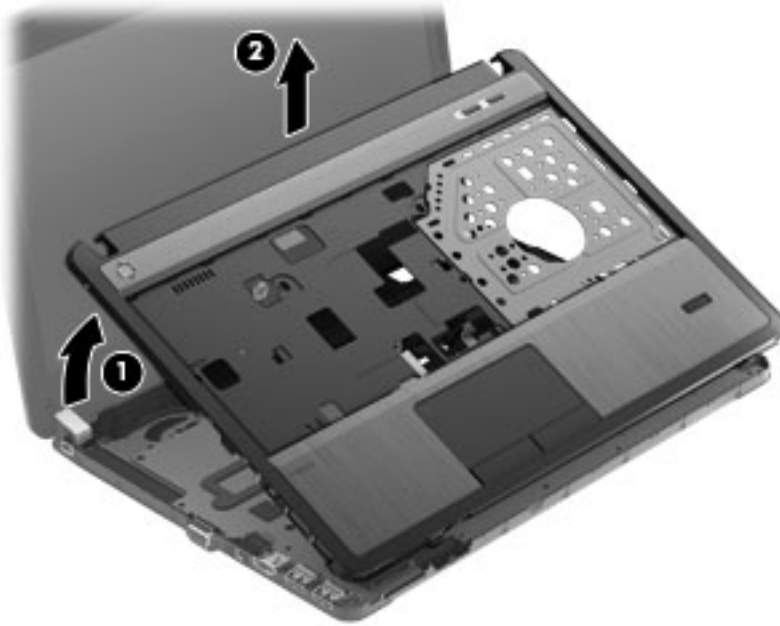

Reverse this procedure to install the top cover.

Fingerprint reader board



NOTE: All fingerprint reader assembly spare part kits include cable, bracket, and screws)

Description	Spare part number
Fingerprint reader board (includes cable, bracket, and screws)	683862-001

Before removing the fingerprint reader board, follow these steps:

1. Shut down the computer. If you are unsure whether the computer is off or in Hibernation, turn the computer on, and then shut it down through the operating system.
2. Disconnect all external devices connected to the computer.
3. Disconnect the power from the computer by first unplugging the power cord from the AC outlet, and then unplugging the AC adapter from the computer.
4. Remove the battery (see [Battery on page 31](#)).
5. Remove the following components:
 - a. Bottom door (see [Bottom door on page 33](#)).
 - b. Keyboard (see [Keyboard on page 45](#))
 - c. Top cover (see [Top cover on page 47](#))

Remove the fingerprint reader board:

1. Position the top cover upside-down.
2. Remove the Phillips PM2.0×3.0 screw **(1)** that secures the fingerprint reader board bracket to the top cover.
3. Slide the bracket toward the edge of the top cover **(2)**, and then lift it off the top cover **(3)**.

4. Remove the reader board and cable assembly from the top cover (4).

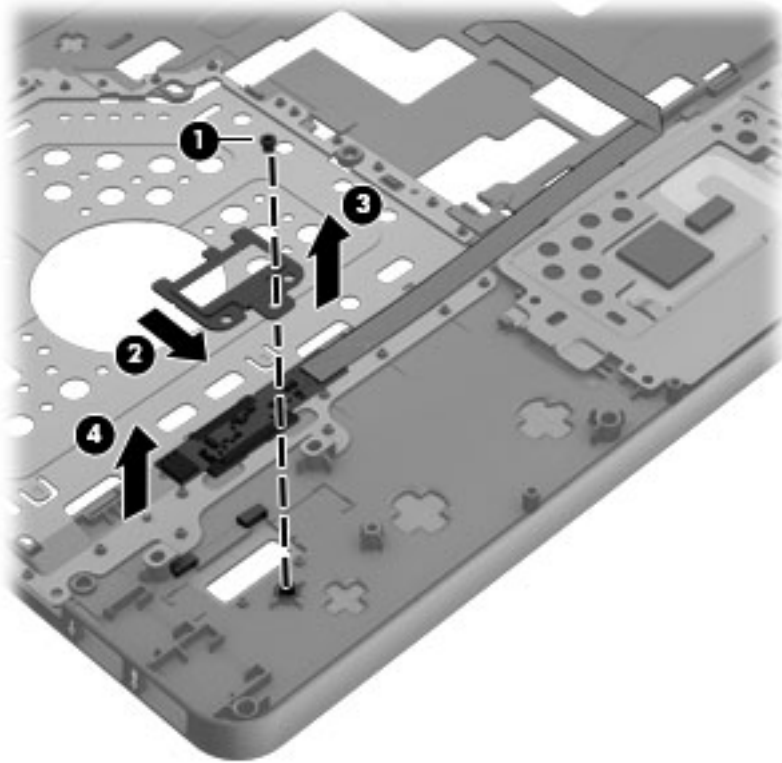

Reverse this procedure to install the fingerprint reader board.

Audio board

Description	Spare part number
Audio board (includes cable)	684245-001

Before removing the audio board, follow these steps:

1. Shut down the computer. If you are unsure whether the computer is off or in Hibernation, turn the computer on, and then shut it down through the operating system.
2. Disconnect all external devices connected to the computer.
3. Disconnect the power from the computer by first unplugging the power cord from the AC outlet, and then unplugging the AC adapter from the computer.
4. Remove the battery (see [Battery on page 31](#)).
5. Remove the following components:
 - a. Bottom door (see [Bottom door on page 33](#)).
 - b. Keyboard (see [Keyboard on page 45](#))
 - c. Top cover (see [Top cover on page 47](#))

Remove the audio board:

1. Position the top cover upside-down.
2. Disconnect the audio board cable **(1)**.
3. Remove the two Phillips PM2.0×3.0 screws **(2)** that secure the audio board to the top cover.

4. Rotate the audio board upward **(3)** and then remove it from the top cover.

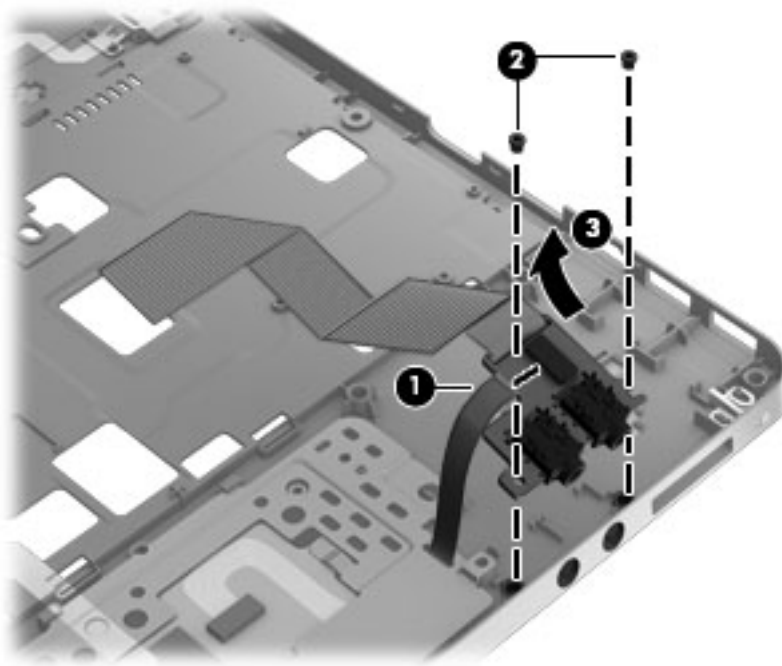

Reverse this procedure to install the audio board.

Function board/Power button board

Description	Spare part number
Function board/Power button board (includes cable)	684240-001

Before removing the function board and power button board, follow these steps:

1. Shut down the computer. If you are unsure whether the computer is off or in Hibernation, turn the computer on, and then shut it down through the operating system.
2. Disconnect all external devices connected to the computer.
3. Disconnect the power from the computer by first unplugging the power cord from the AC outlet, and then unplugging the AC adapter from the computer.
4. Remove the battery (see [Battery on page 31](#)).
5. Remove the following components:
 - a. Bottom door (see [Bottom door on page 33](#)).
 - b. Keyboard (see [Keyboard on page 45](#))
 - c. Top cover (see [Top cover on page 47](#))

Remove the function board/power button board assembly:

1. Position the top cover upside-down.
2. Remove the three Phillips PM2.0×3.0 screws **(1)** that secure the boards to the top cover.



NOTE: The function board is secured with two screws. The power button board is secured with one screw.

3. Remove the function board from the top cover **(2)**.

4. Remove the power button board from the top cover (3).

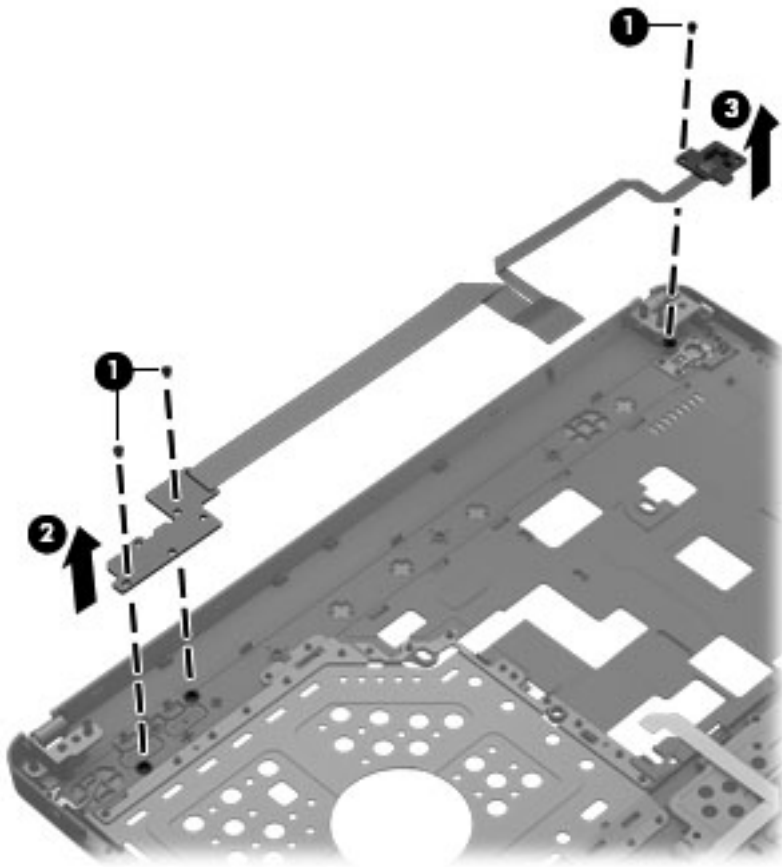

Reverse this procedure to install the function board/power button board.

RTC battery

Description	Spare part number
RTC battery	684248-001

Before removing the RTC battery, follow these steps:

1. Shut down the computer. If you are unsure whether the computer is off or in Hibernation, turn the computer on, and then shut it down through the operating system.
2. Disconnect all external devices connected to the computer.
3. Disconnect the power from the computer by first unplugging the power cord from the AC outlet, and then unplugging the AC adapter from the computer.
4. Remove the battery (see [Battery on page 31](#)).
5. Remove the following components:
 - a. Bottom door (see [Bottom door on page 33](#)).
 - b. Keyboard (see [Keyboard on page 45](#))
 - c. Top cover (see [Top cover on page 47](#))

Remove the RTC battery:

1. Position the computer upright with the front toward you.
2. Use a screwdriver to loosen the battery from the slot.
3. Lift the battery from the system board.

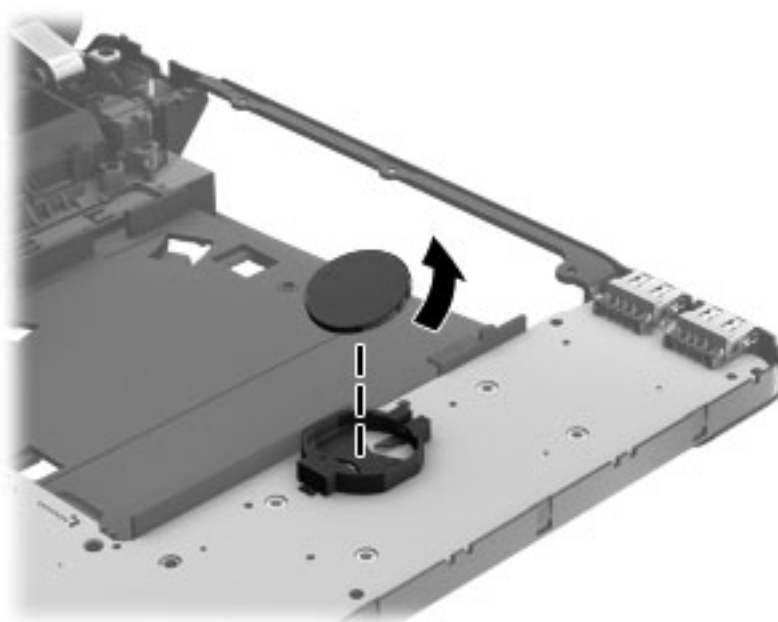

Reverse this procedure to install the RTC battery.

Speaker assembly

Description	Spare part number
Speaker assembly	684242-001

Before removing the speaker assembly, follow these steps:

1. Shut down the computer. If you are unsure whether the computer is off or in Hibernation, turn the computer on, and then shut it down through the operating system.
2. Disconnect all external devices connected to the computer.
3. Disconnect the power from the computer by first unplugging the power cord from the AC outlet, and then unplugging the AC adapter from the computer.
4. Remove the battery (see [Battery on page 31](#)).
5. Remove the following components:
 - a. Bottom door (see [Bottom door on page 33](#)).
 - b. Keyboard (see [Keyboard on page 45](#))
 - c. Top cover (see [Top cover on page 47](#))

Remove the speaker assembly:

1. Position the computer upright with the front toward you.
2. Disconnect the speaker cable from the system board **(1)**.
3. Remove the four Torx T8M2.5×6.0 screws **(2)** that secure the speaker assembly to the computer.
4. Remove the tape **(3)** that secures the speaker cables to the computer.

5. Lift the speakers from the computer (4).

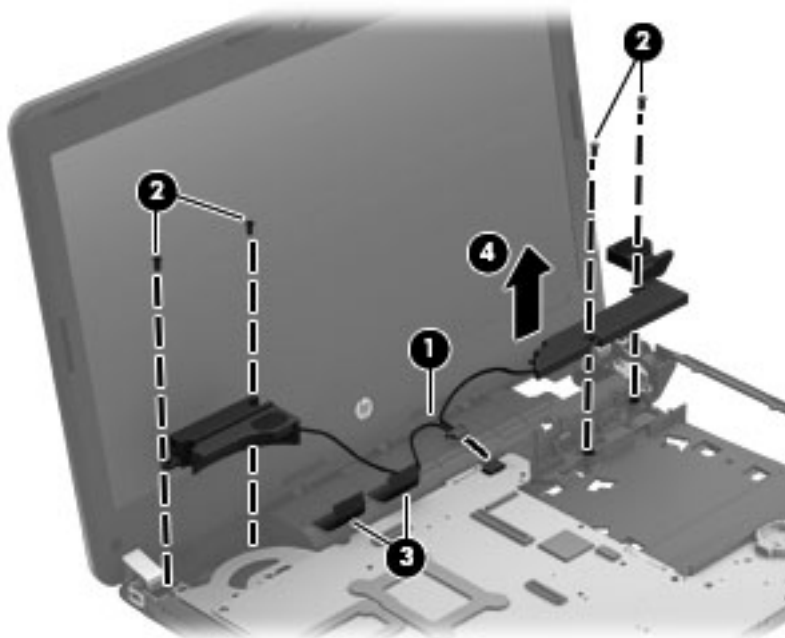

Reverse this procedure to install the speaker assembly.

Latch assembly



NOTE: The Latch Kit includes the latch, knob, and spring.

Description	Spare part number
Latch Kit	686319-001

Before removing the latch assembly, follow these steps:

1. Shut down the computer. If you are unsure whether the computer is off or in Hibernation, turn the computer on, and then shut it down through the operating system.
2. Disconnect all external devices connected to the computer.
3. Disconnect the power from the computer by first unplugging the power cord from the AC outlet, and then unplugging the AC adapter from the computer.
4. Remove the battery (see [Battery on page 31](#)).
5. Remove the following components:
 - a. Bottom door (see [Bottom door on page 33](#))
 - b. Keyboard (see [Keyboard on page 45](#))
 - c. Top cover (see [Top cover on page 47](#))
 - d. Speaker assembly (see [Speaker assembly on page 59](#))

 **NOTE:** The latch assembly includes a small spring. Note the location of the spring.

Remove the latch assembly:

1. Position the computer right-side up, with the front toward you.
2. Detach the spring hook (1) from the tab on the base enclosure (2).
3. Rotate the latch (3) and lift it from the computer.

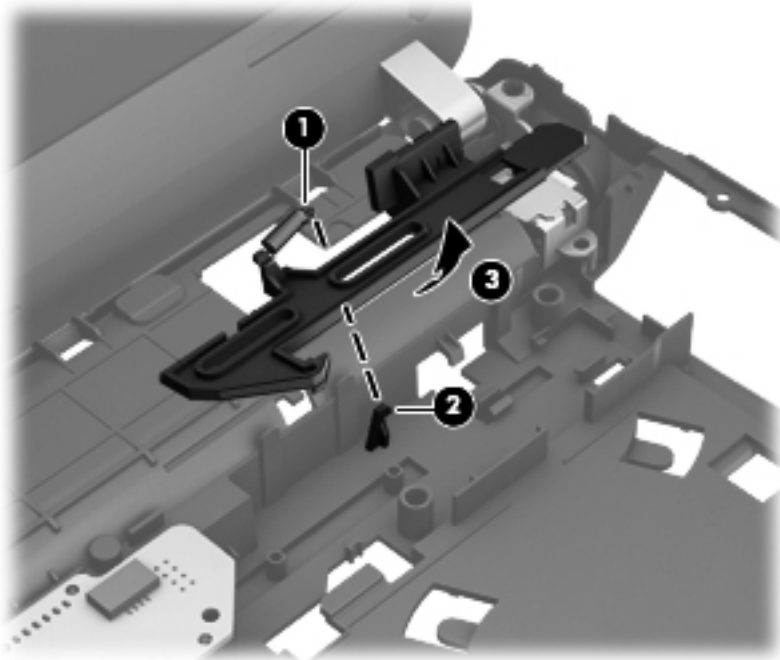

Reverse this procedure to install the latch assembly.

System board

 **NOTE:** All system board spare part kits include replacement thermal material.

Description	Spare part number
System board for use in models with discrete graphics	683855-001
System board for use in models with UMA graphics	683856-001
System board for use in Japan in models with UMA graphics	696335-001

Before removing the system board, follow these steps:

1. Shut down the computer. If you are unsure whether the computer is off or in Hibernation, turn the computer on, and then shut it down through the operating system.
2. Disconnect all external devices connected to the computer.
3. Disconnect the power from the computer by first unplugging the power cord from the AC outlet, and then unplugging the AC adapter from the computer.

4. Remove the battery (see [Battery on page 31](#)).
5. Remove the following components:
 - a. Bottom door (see [Bottom door on page 33](#)).
 - b. Hard drive (see [Hard drive on page 37](#))
 - c. Optical drive (see [Optical drive on page 35](#))
 - d. Keyboard (see [Keyboard on page 45](#))
 - e. Top cover (see [Top cover on page 47](#))

When replacing the system board, be sure to remove the following components from the defective system board and install on the replacement system board:

- SIM card (see [SIM on page 34](#))
- Memory module (see [Memory modules on page 39](#))
- WLAN module (see [WLAN/Bluetooth combo card on page 43](#))
- WWAN module (see [WWAN module on page 41](#))

Remove the system board:

1. Position the computer upright with the front toward you.
2. Disconnect the display cable (1), speaker cable (2), and the power cable (3) from the system board.

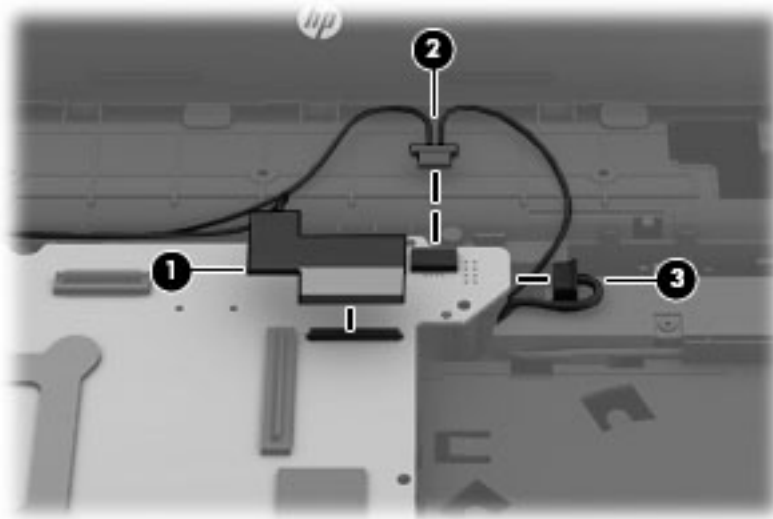

3. Remove the Phillips PM2.5×6.0 screw (1) that secures the system board to the base enclosure.

- Lift the right side of the system board up at an angle (2), and then lift the system board up and to the right to remove it (3).

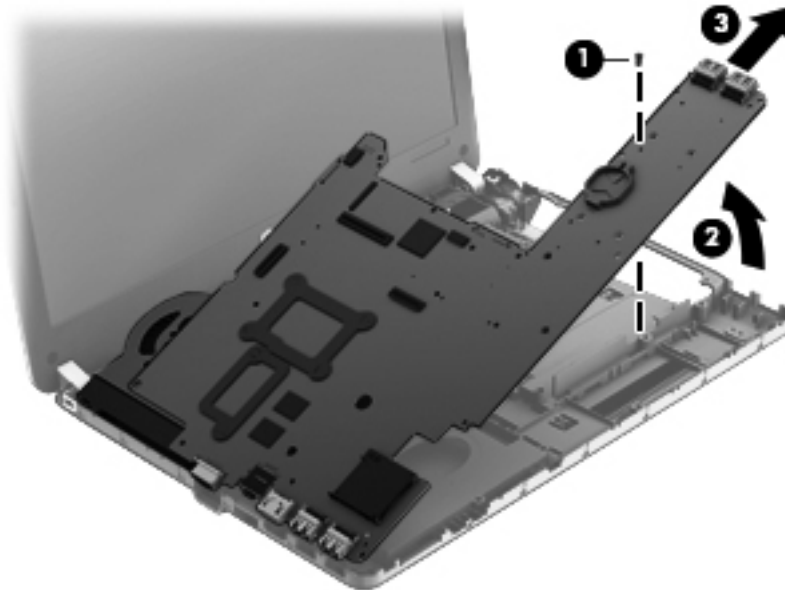

Reverse this procedure to install the system board.

Heat sink



NOTE: The fan and heat sink are combined into one assembly. All fan/heat sink spare part kits contain replacement thermal material.

Description	Spare part number
Heat sink for use in computers with discrete graphics	683860-001
Heat sink for use in computers with UMA graphics	683861-001

Before removing the heat sink, follow these steps:

- Shut down the computer. If you are unsure whether the computer is off or in Hibernation, turn the computer on, and then shut it down through the operating system.
- Disconnect all external devices connected to the computer.
- Disconnect the power from the computer by first unplugging the power cord from the AC outlet, and then unplugging the AC adapter from the computer.
- Remove the battery (see [Battery on page 31](#)).
- Remove the following components:
 - Bottom door (see [Bottom door on page 33](#)).
 - Hard drive (see [Hard drive on page 37](#))
 - Optical drive (see [Optical drive on page 35](#))
 - WLAN module (see [WLAN/Bluetooth combo card on page 43](#))

- e. WWAN module (see [WWAN module on page 41](#))
- f. Keyboard (see [Keyboard on page 45](#))
- g. Top cover (see [Top cover on page 47](#))
- h. System board (see [System board on page 61](#))

Remove the heat sink:

1. Position the system board upside-down with the front toward you.
2. To remove the UMA heat sink, skip to step 6.
3. To remove the discrete heat sink, disconnect the fan cable (1) from the system board.
4. Loosen the six captive Phillips screws (2) that secure the heat sink to the system board.
5. Lift the heat sink off the system board (3).

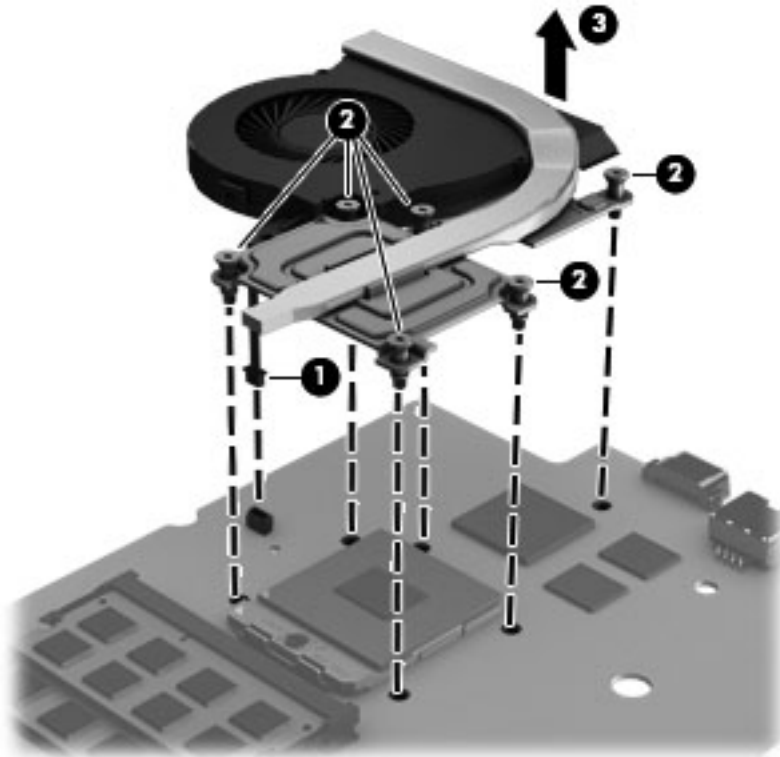

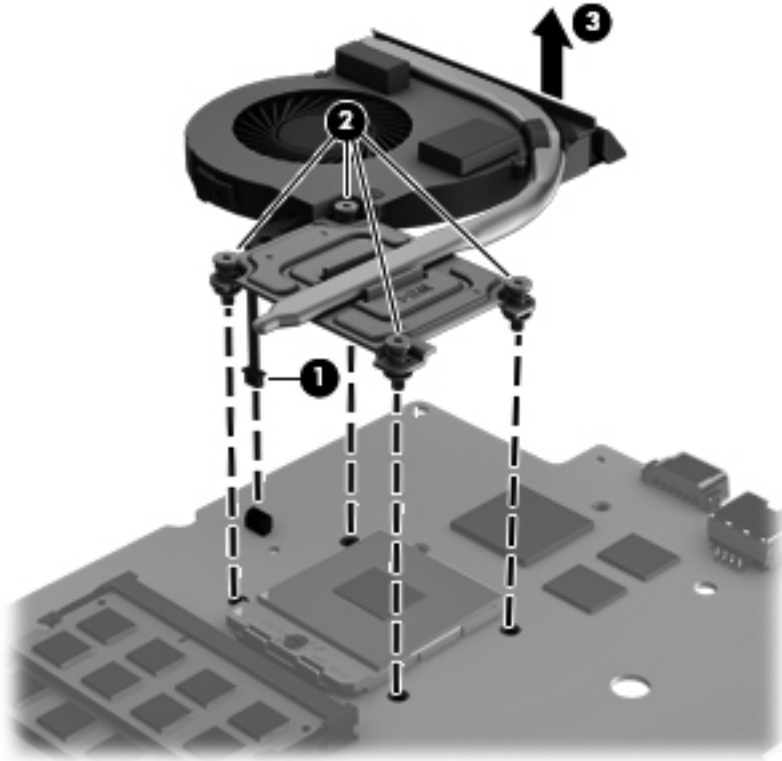

6. To remove the UMA heat sink, disconnect the fan cable (1) from the system board.
7. Loosen the four captive Phillips screws (2) that secure the heat sink to the system board.

- Lift the heat sink off the system board (3).

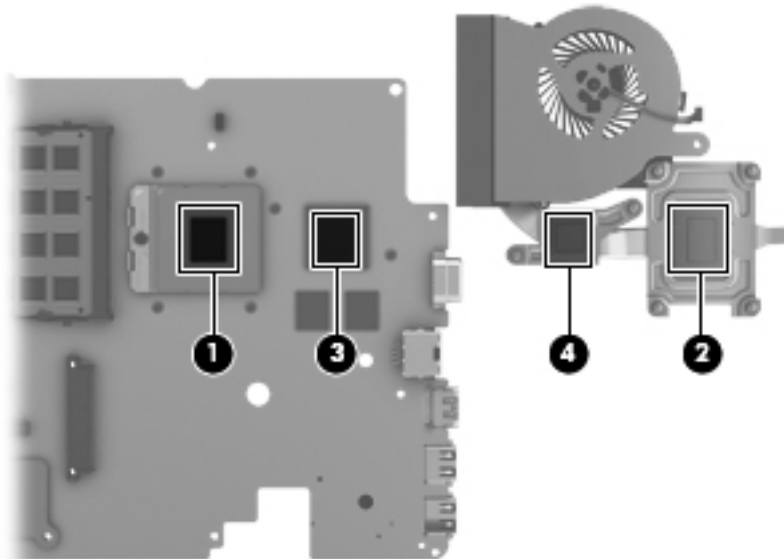

 **NOTE:** For discrete models, thoroughly clean thermal material from the surfaces of the system board components (1)(3) and the heat sink (2)(4) each time you remove the heat sink. All heat sink and processor spare part kits include thermal material.



 **NOTE:** For UMA models, thoroughly clean thermal material from the surface of the system board (1) and heat sink (2) each time you remove the heat sink. All heat sink and processor spare part kits include thermal material.

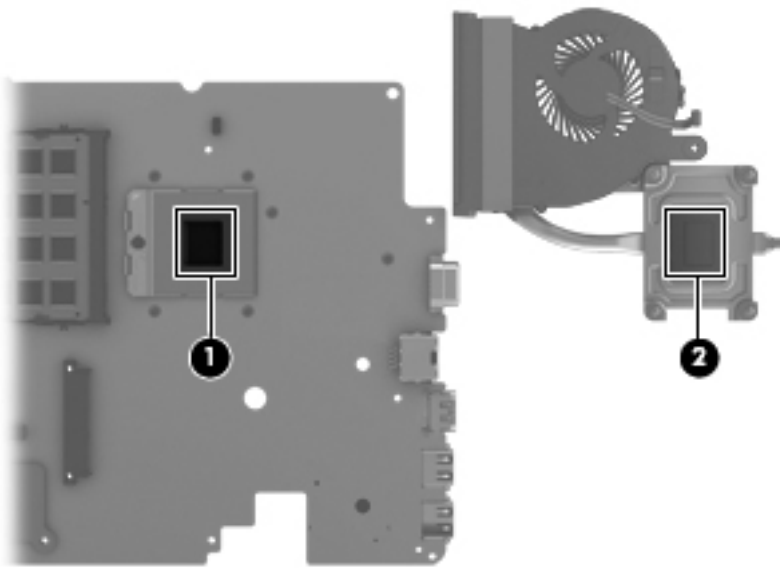

Reverse this procedure to install the heat sink.

NOTE: To properly ventilate the computer, allow at least a 7.6-cm (3-in) clearance on the left side of the computer.

The computer uses an electric fan for ventilation. The fan is controlled by a temperature sensor and is designed to turn on automatically when high temperature conditions exist. These conditions are affected by high external temperatures, system power consumption, power management/battery conservation configurations, battery fast charging, and software requirements. Exhaust air is displaced through the ventilation grill located on the left side of the computer.

Processor

NOTE: All processor spare part kits include replacement thermal material.

Description	Spare part number
Intel Core i7 processor, Quad Core	
3612QM, 2.1-GHz processor with 6-MB L3 cache	680647-001
Intel Core i5 processors, Dual Core	
3360M, 2.8-GHz processor with 3-MB L3 cache	681953-001
3320M, 2.6-GHz processor with 3-MB L3 cache	681952-001
2450M, 2.5-GHz processor with 3-MB L3 cache	676359-001
Intel Core i3 processors, Dual Core	
3110M, 2.3-GHz processor with 3-MB L3 cache	682417-001
2370M, 2.4-GHz processor with 3-MB L3 cache	677152-001
2350M, 2.3-GHz processor with 3-MB L3 cache	653340-001
Intel Pentium processor, Dual Core	
B980, 2.4-GHz, with 2-MB L3 cache	692428-001

Description	Spare part number
B970, 2.3-GHz, with 2-MB L3 cache	676785-001
Intel Celeron processor	
B840, 1.9-GHz, with 2-MB L3 cache	664663-001

Before removing the processor, follow these steps:

1. Shut down the computer. If you are unsure whether the computer is off or in Hibernation, turn the computer on, and then shut it down through the operating system.
2. Disconnect all external devices connected to the computer.
3. Disconnect the power from the computer by first unplugging the power cord from the AC outlet, and then unplugging the AC adapter from the computer.
4. Remove the battery (see [Battery on page 31](#)).
5. Remove the following components:
 - a. Bottom door (see [Bottom door on page 33](#))
 - b. Hard drive (see [Hard drive on page 37](#))
 - c. Optical drive (see [Optical drive on page 35](#))
 - d. WLAN module (see [WLAN/Bluetooth combo card on page 43](#))
 - e. WWAN module (see [WWAN module on page 41](#))
 - f. Keyboard (see [Keyboard on page 45](#))
 - g. Top cover (see [Top cover on page 47](#))
 - h. System board (see [System board on page 61](#))
 - i. Heat sink (see [Heat sink on page 63](#))

Remove the processor:

1. Position the system board upside-down.
2. Use a flat-bladed screwdriver to turn the processor locking screw **(1)** one-half turn counterclockwise until you hear a click.

3. Lift the processor (2) straight up and remove it.

 **NOTE:** The gold triangle (3) on the processor must be aligned with the triangle embossed on the processor slot when you install the processor.

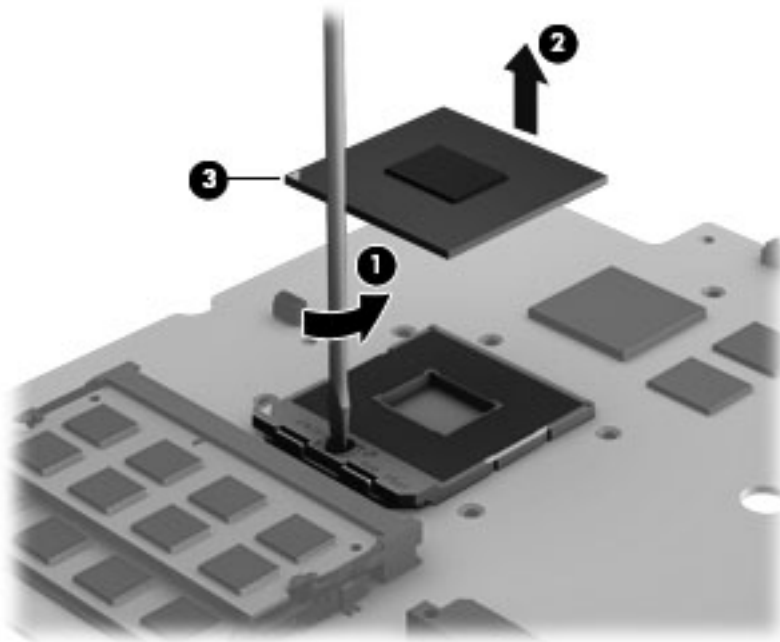

Reverse this procedure to install the processor.

Display assembly

All display assemblies include WLAN antenna transceivers and cables. WWAN models include 2 WWAN antenna transceivers and cables.

Description	Spare part number
Display assembly, 33.8-cm (13.3-inch) HD, anti-glare	684251-001

Before removing the display assembly, follow these steps:

1. Shut down the computer. If you are unsure whether the computer is off or in Hibernation, turn the computer on, and then shut it down through the operating system.
2. Disconnect all external devices connected to the computer.
3. Disconnect the power from the computer by first unplugging the power cord from the AC outlet, and then unplugging the AC adapter from the computer.
4. Remove the battery (see [Battery on page 31](#)).
5. Remove the following components:
 - a. Bottom door (see [Bottom door on page 33](#)).
 - b. WLAN module (see [WLAN/Bluetooth combo card on page 43](#))
 - c. WWAN module (see [WWAN module on page 41](#))
 - d. Keyboard (see [Keyboard on page 45](#))
 - e. Top cover (see [Top cover on page 47](#))
 - f. Speakers (see [Speaker assembly on page 59](#))

Remove the display assembly:

1. Position the computer upside down.
2. Remove the WLAN and WWAN antennas from the routing path **(1)** on the bottom of the computer.

3. Pull the antennas through the hole that leads to the top of the computer (2).

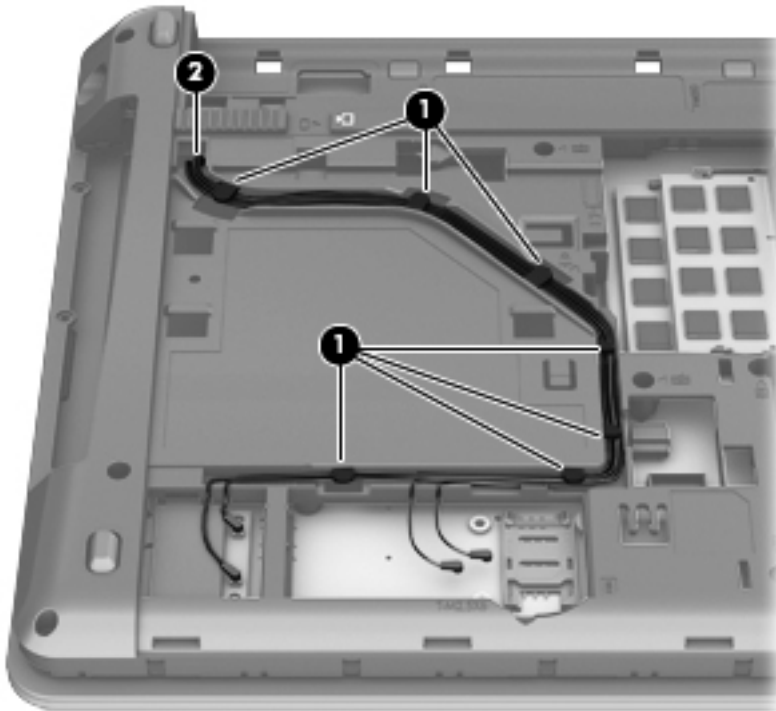

4. Open the computer as far as possible.
5. Disconnect the display cable (1) from the system board and make sure the antenna cables are all pulled through the hole (2) that routes to the bottom of the computer.

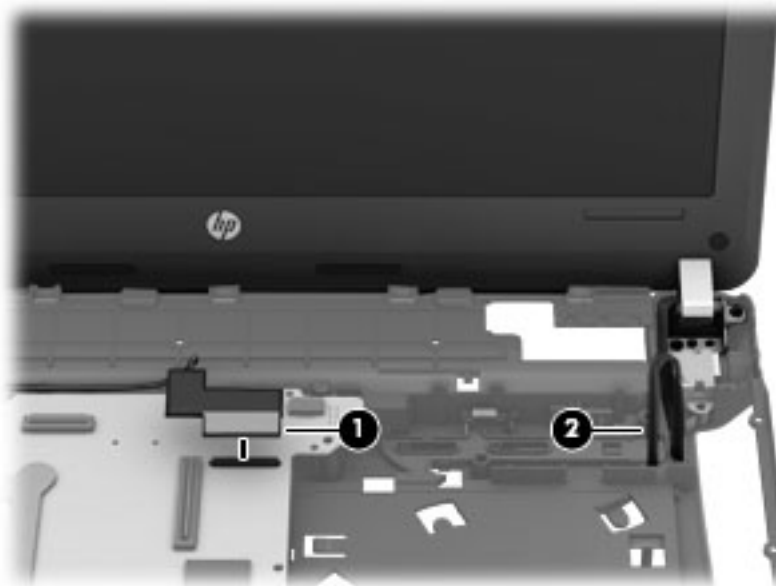

6. Remove the three Torx T8M2.5×6.0 screws (1) that secure the display to the computer.

7. Lift the display assembly straight up and remove it (2).

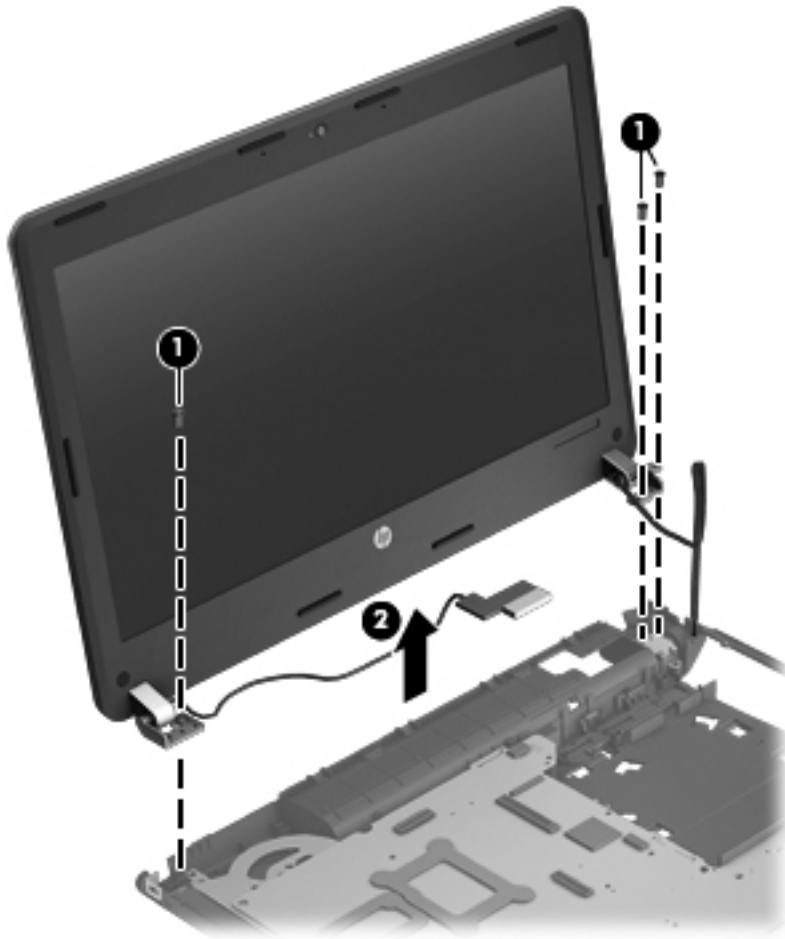

⚠ CAUTION: When installing the display assembly, be sure that the wireless antenna cables are routed and arranged properly.

Failure to properly route the antennas can result in degradation of the computer's WLAN and WWAN performance.

8. If you need to remove the hinge covers from the display hinges, pull the hinges straight up and off the display to remove them.

Display hinge covers are available in the Display Hinge Kit using spare part number 684239-001.



9. To replace the display bezel, remove the two screw covers (1) and the two Phillips PM2.5×4.0 screws (2) from the bottom corners of the display bezel.

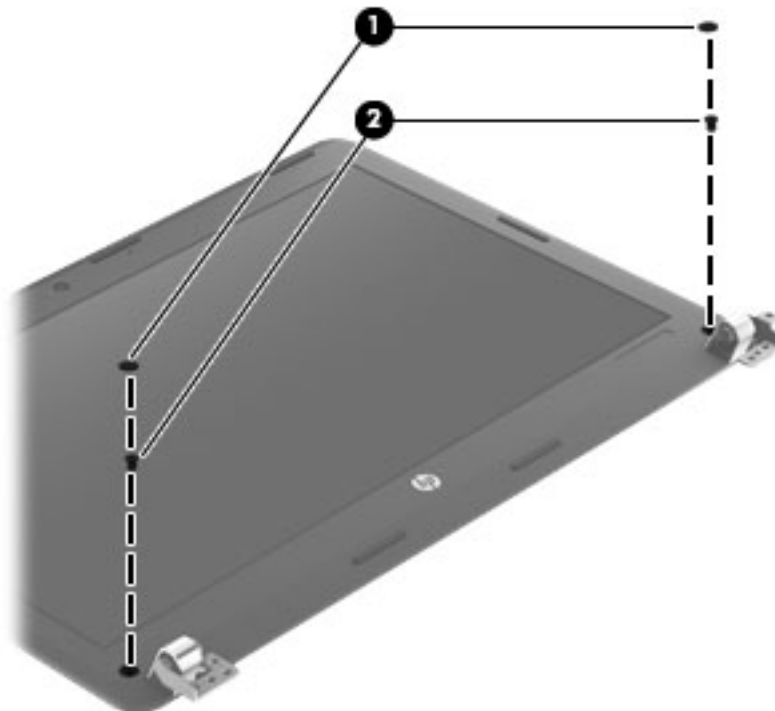

10. Flex the top (1) of the bezel, the inside edges of the left and right sides (2), and then the bottom (3) of the bezel until it disengages from the display enclosure.
11. Remove the display bezel (4).

The bezel is available using spare part number 683858-001.



12. If it is necessary to replace the webcam module from the display enclosure, disconnect the cable from the module (1), and then gently pull the module away from the double-sided tape on the display enclosure (2).

The webcam module is available using spare part number 683508-001.

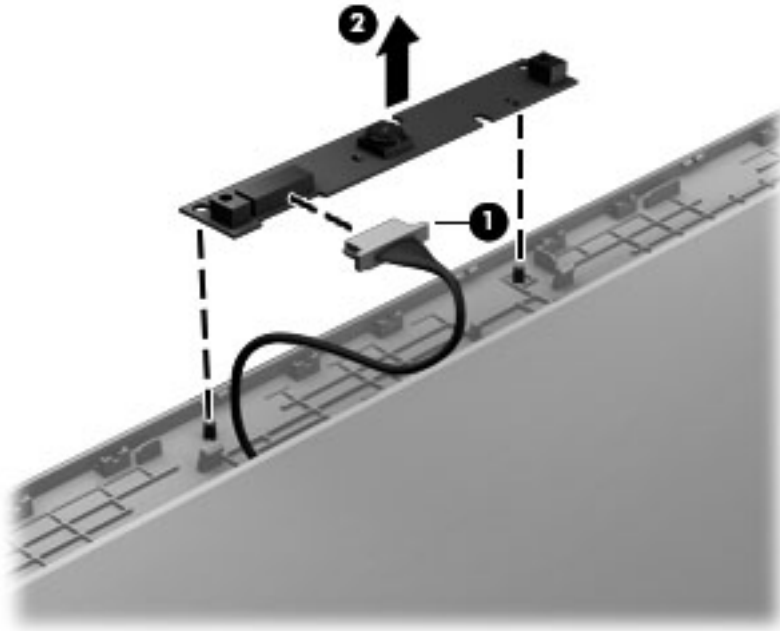

13. If it is necessary to replace the display hinges, remove the six Phillips PM2.5×3.0 screws that secure the display hinges and panel to the display enclosure.

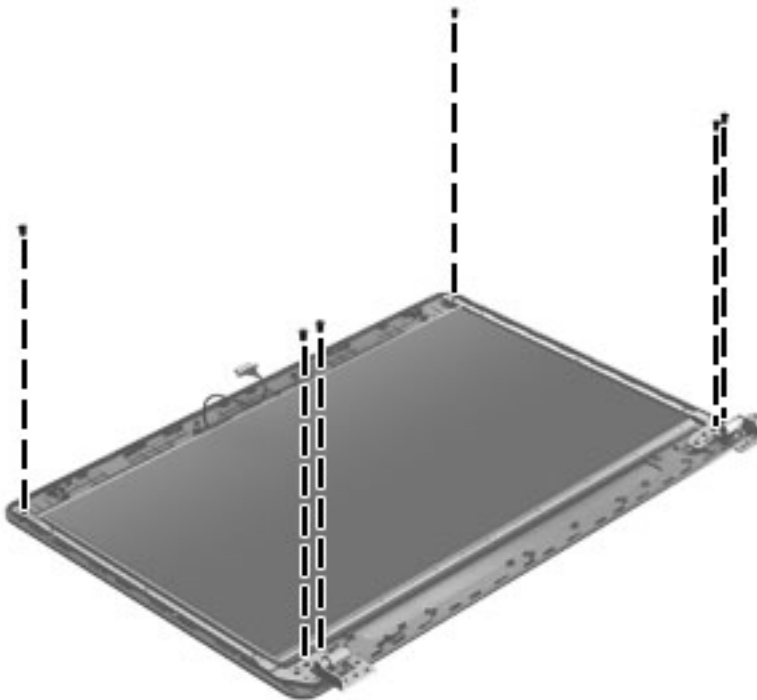

14. Remove the display hinges and panel from the display enclosure.

15. Disconnect the display panel cable by rotating the display enclosure (1), lifting the tape (2) that covers the connector, and disconnecting the cable from the panel (3).



16. Remove the two Phillips PM1.6×1.5 screws (1) that secure each display hinge to the display panel.

17. Remove the display hinges (2).

Display hinges are available in the Display Hinge Kit using spare part number 684239-001.

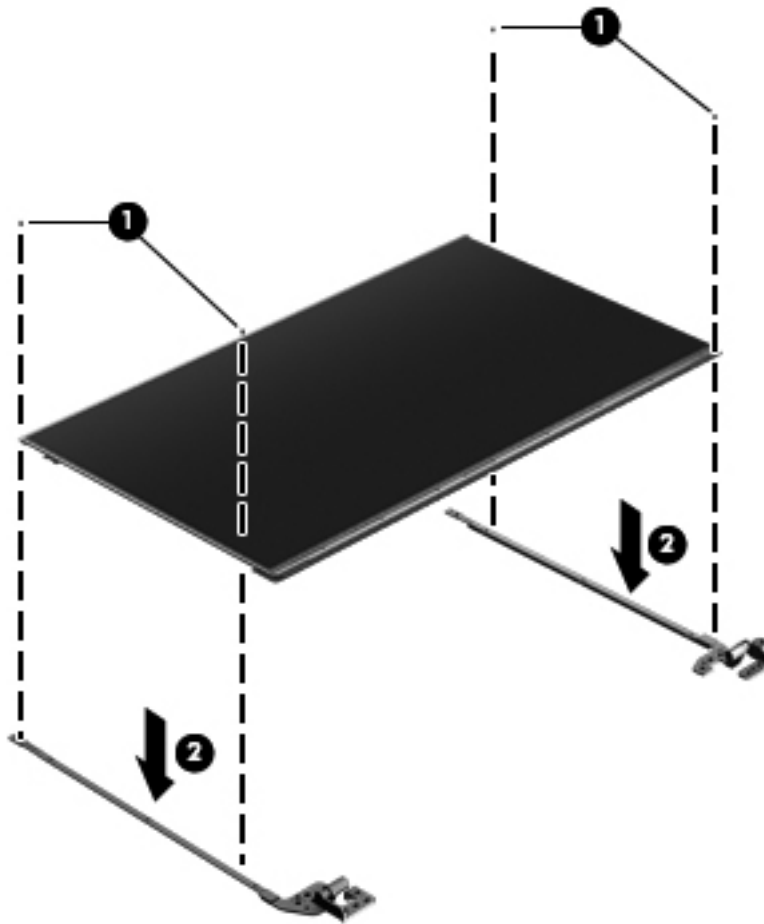

Reverse this procedure to reassemble and install the display assembly.

Power connector

Description	Spare part number
Power connector cable (includes bracket and screws)	683859-001

Before removing the power cable, follow these steps:

1. Shut down the computer. If you are unsure whether the computer is off or in Hibernation, turn the computer on, and then shut it down through the operating system.
2. Disconnect all external devices connected to the computer.
3. Disconnect the power from the computer by first unplugging the power cord from the AC outlet, and then unplugging the AC adapter from the computer.
4. Remove the battery (see [Battery on page 31](#)).
5. Remove the following components:
 - a. Bottom door (see [Bottom door on page 33](#)).
 - b. WLAN module (see [WLAN/Bluetooth combo card on page 43](#))
 - c. WWAN module (see [WWAN module on page 41](#))
 - d. Keyboard (see [Keyboard on page 45](#))
 - e. Top cover (see [Top cover on page 47](#))
 - f. Speakers (see [Speaker assembly on page 59](#))
 - g. Display (see [Display assembly on page 69](#))

Remove the power cable:

1. Position the computer upright with the front toward you.
2. Remove the Phillips PM2.5×4.0 screw **(1)** that secures the power connector bracket to the computer.
3. Lift the bracket **(2)** out of the base enclosure.

4. Remove the power cable assembly from the computer (3).

 **NOTE:** Note the location of the cable routing channel for reassembly.

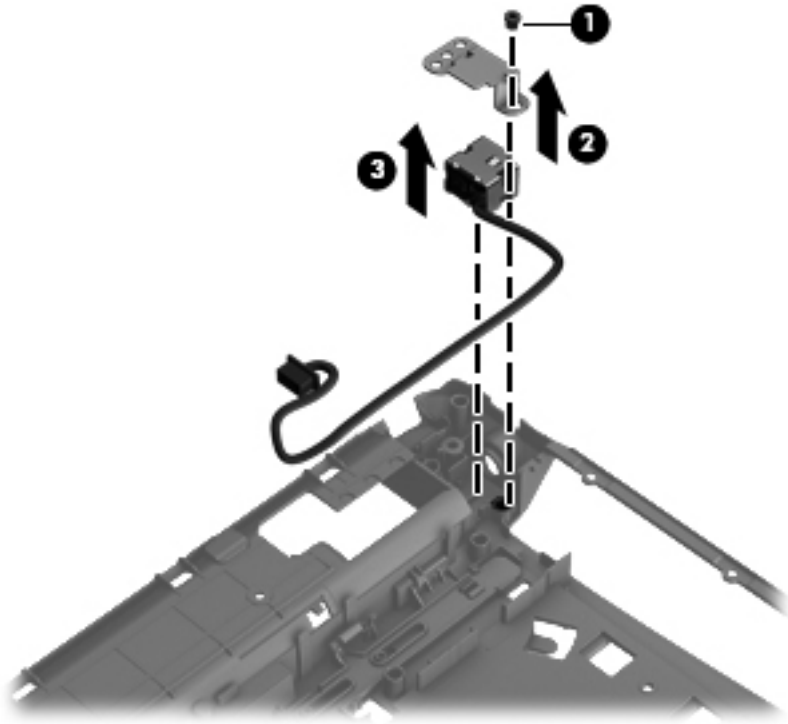

Reverse this procedure to install the power connector cable.

5 Computer Setup (BIOS) and Advanced System Diagnostics

Using Computer Setup

Computer Setup, or Basic Input/Output System (BIOS), controls communication between all the input and output devices on the system (such as disk drives, display, keyboard, mouse, and printer). Computer Setup includes settings for the types of devices installed, the startup sequence of the computer, and the amount of system and extended memory.

 **NOTE:** Use extreme care when making changes in Computer Setup. Errors can prevent the computer from operating properly.

Starting Computer Setup

 **NOTE:** An external keyboard or mouse connected to a USB port can be used with Computer Setup only if USB legacy support is enabled.

To start Computer Setup, follow these steps:

1. Turn on or restart the computer, and then press **esc** while the “Press the ESC key for Startup Menu” message is displayed at the bottom of the screen.
2. Press **f10** to enter Computer Setup.

Navigating and selecting in Computer Setup

To navigate and select in Computer Setup, follow these steps:

1. Turn on or restart the computer, and then press **esc** while the “Press the ESC key for Startup Menu” message is displayed at the bottom of the screen.
 - To select a menu or a menu item, use the **tab** key and the keyboard arrow keys and then press **enter**, or use a pointing device to click the item.
 - To scroll up and down, click the up arrow or the down arrow in the upper-right corner of the screen, or use the up arrow key or the down arrow key.
 - To close open dialog boxes and return to the main Computer Setup screen, press **esc**, and then follow the on-screen instructions.

 **NOTE:** You can use either a pointing device (TouchPad, pointing stick, or USB mouse) or the keyboard to navigate and make selections in Computer Setup.

2. Press **f10** to enter Computer Setup.

To exit Computer Setup menus, choose one of the following methods:

- To exit Computer Setup menus without saving your changes:

Click the **Exit** icon in the lower-left corner of the screen, and then follow the on-screen instructions.

– or –

Use the **tab** key and the arrow keys to select **File > Ignore Changes and Exit**, and then press **enter**.

- To save your changes and exit Computer Setup menus:

Click the **Save** icon in the lower-left corner of the screen, and then follow the on-screen instructions.

– or –

Use the **tab** key and the arrow keys to select **File > Save Changes and Exit**, and then press **enter**.

Your changes go into effect when the computer restarts.

Restoring factory settings in Computer Setup



NOTE: Restoring defaults will not change the hard drive mode.

To return all settings in Computer Setup to the values that were set at the factory, follow these steps:

1. Turn on or restart the computer, and then press **esc** while the “Press the ESC key for Startup Menu” message is displayed at the bottom of the screen.
2. Press **f10** to enter Computer Setup.
3. Use a pointing device or the arrow keys to select **File > Restore Defaults**.
4. Follow the on-screen instructions.
5. To save your changes and exit, click the **Save** icon in the lower-left corner of the screen, and then follow the on-screen instructions.

– or –

Use the arrow keys to select **File > Save Changes and Exit**, and then press **enter**.

Your changes go into effect when the computer restarts.



NOTE: Your password settings and security settings are not changed when you restore the factory settings.

Updating the BIOS

The next sections describe different ways of updating the BIOS.

Downloading *SoftPaqs* to update the BIOS

Most BIOS updates on the HP website are packaged in compressed files called *SoftPaqs*.

To install BIOS updates from the HP website, follow the steps below:

1. Download the *SoftPaq* from the HP website.
2. Click **Run**, and then follow the on-screen instructions to update the BIOS.

 **NOTE:** Some download packages contain a file named Readme.txt, which contains information regarding installing and troubleshooting the file.

BIOS management using system diagnostics

1. Download the *SoftPaq* from the HP website.

 **NOTE:** Verify that the UEFI system diagnostics is installed on your computer (or USB flash drive).

2. Click **Run**, and then click **Cancel** at the Update/USB bootable dialog box.
3. Navigate to the folder located in [c:\swsetup](#) that corresponds to your *SoftPaq* number.
4. Locate the .bin file in the ROMpaq folder (for example, 68CDD.bin) and then copy it to the Hewlett-Packard\BIOS\New\ folder in either the HP_Tools partition of the hard drive, or the USB flash drive.
5. Locate the .sig file in the ROM.cab file and rename it with the same prefix as the .bin file (for example, 68CDD.sig). Copy the renamed file to the Hewlett-Packard\BIOS\New\ folder in either the HP_Tools partition of the hard drive, or the USB flash drive.
6. Restart the computer, and then press **esc** while the “Press the ESC key for Startup Menu” message is displayed at the bottom of the screen.
7. Press **f2** to enter Computer Setup.
8. Click **BIOS Management** from the menu and then select **Update BIOS**.

Using **f10** setup to update the BIOS

1. Download the *SoftPaq* from the HP website.

 **NOTE:** Verify that the UEFI system diagnostics is installed on your computer (or USB flash drive).

2. Click **Run**, and then click **Cancel** at the Update/USB bootable dialog box.
3. Navigate to the folder located in [c:\swsetup](#) that corresponds to your *SoftPaq* number.
4. Locate the .bin file in the ROMpaq folder (for example, 68CDD.bin) and then copy it to the Hewlett-Packard\BIOS\New\ folder in either the HP_Tools partition of the hard drive, or the USB flash drive.

5. Locate the .sig file in the ROM.cab file and rename it with the same prefix as the .bin file (for example, 68CDD.sig). Copy the renamed file to the Hewlett-Packard\BIOS\New\ folder in either the HP_Tools partition of the hard drive, or the USB flash drive.
6. Restart the computer, and then press **esc** while the “Press the ESC key for Startup Menu” message is displayed at the bottom of the screen.
7. Press **f10** to enter Computer Setup.
8. Click **Update System BIOS**, and then click **Accept** to update the BIOS.

Determining the BIOS version

To determine whether available BIOS updates contain later BIOS versions than those currently installed on the computer, you need to know the version of the system BIOS currently installed.

BIOS version information (also known as *ROM date* and *System BIOS*) can be displayed by pressing **fn+esc** (if you are already in Windows) or by using Computer Setup.

1. Start Computer Setup.
2. Use a pointing device or the arrow keys to select **File > System Information**.
3. To exit Computer Setup without saving your changes, click the **Exit** icon in the lower-left corner of the screen, and then follow the on-screen instructions.

– or –

Use the **tab** key and the arrow keys to select **File > Ignore Changes and Exit**, and then press **enter**.

Downloading a BIOS update

 **CAUTION:** To reduce the risk of damage to the computer or an unsuccessful installation, download and install a BIOS update only when the computer is connected to reliable external power using the AC adapter. Do not download or install a BIOS update while the computer is running on battery power, docked in an optional docking device, or connected to an optional power source. During the download and installation, follow these instructions:

Do not disconnect power from the computer by unplugging the power cord from the AC outlet.

Do not shut down the computer or initiate Sleep or Hibernation.

Do not insert, remove, connect, or disconnect any device, cable, or cord.

1. Select **Start > Help and Support > Maintain**.
2. Follow the on-screen instructions to identify your computer and access the BIOS update you want to download.
3. At the download area, follow these steps:
 - a. Identify the BIOS update that is later than the BIOS version currently installed on your computer. Make a note of the date, name, or other identifier. You may need this information to locate the update later, after it has been downloaded to your hard drive.
 - b. Follow the on-screen instructions to download your selection to the hard drive.

Make a note of the path to the location on your hard drive where the BIOS update is downloaded. You will need to access this path when you are ready to install the update.

 **NOTE:** If you connect your computer to a network, consult the network administrator before installing any software updates, especially system BIOS updates.

BIOS installation procedures vary. Follow any instructions that are displayed on the screen after the download is complete. If no instructions are displayed, follow these steps:

1. Open Windows Explorer by selecting **Start > Computer**.
2. Double-click your hard drive designation. The hard drive designation is typically Local Disk (C:).
3. Using the hard drive path you recorded earlier, open the folder on your hard drive that contains the update.
4. Double-click the file that has an .exe extension (for example, *filename.exe*).
The BIOS installation begins.
5. Complete the installation by following the on-screen instructions.

 **NOTE:** After a message on the screen reports a successful installation, you can delete the downloaded file from your hard drive.

BIOS Setup Menu

The tables in this section provide an overview of the BIOS Setup menu options.

Main menu

Select	To do this
System information	<ul style="list-style-type: none">• View and change the system time and date.• View identification information about your computer.• View specification information about the processor, memory size, and system BIOS.

Security menu

Select	To do this
Administrator password	Control access to Setup Utility.
Power-on password	Control access to your computer.

Diagnostics menu

Select	To do this
Primary Hard Disk Self Test	Run a quick or comprehensive self-test on the hard drive.
Memory Test	Run a diagnostic test on the system memory.

Using Advanced System Diagnostics

Advanced System Diagnostics allows you to run diagnostic tests to determine if the computer hardware is functioning properly. The following diagnostic tests are available in Advanced System Diagnostics:

- **Start-up test**—This test analyzes the main computer components that are required to start the computer.
- **Run-in test**—This test repeats the start-up test and checks for intermittent problems that the start-up test does not detect.
- **System Tune-Up**—This group of additional tests checks your computer to make sure that the main components are functioning correctly. System Tune-Up runs longer and more comprehensive tests on memory modules, hard drive SMART attributes, the hard drive surface, the battery (and battery calibration), video memory, and the WLAN module status.
- **Hard disk test**—This test analyzes the physical condition of the hard drive, and then checks all data in every sector of the hard drive. If the test detects a damaged sector, it attempts to move the data to a good sector.
- **Memory test**—This test analyzes the physical condition of the memory modules. If it reports an error, replace the memory modules immediately.
- **Battery test**—This test analyzes the condition of the battery and calibrates the battery if necessary. If the battery fails the test, contact support to report the issue and purchase a replacement battery.

You can view system information and error logs in the Advanced System Diagnostics window.

To start Advanced System Diagnostics:

1. Turn on or restart the computer. While the “Press the ESC key for Startup Menu” message is displayed in the lower-left corner of the screen, press **esc**. When the Startup Menu is displayed, press **f2**.
2. Click the diagnostic test you want to run, and then follow the on-screen instructions.



NOTE: If you need to stop a diagnostics test while it is running, press **esc**.

6 Specifications

Computer specifications

	Metric	U.S.
Dimensions		
Length	22.9 cm	9.0 in
Width	32.6 cm	12.8 in
Height (front to rear)	2.5 to 3.3 cm	1.0 to 1.3 in
Weight (equipped with optical drive, 1 SODIMM, hard drive, WLAN module, 6 cell battery)	2.0 kg	4.5 lbs
Input power		
Operating voltage	19.0 V dc @ 4.74 A – 90 W or 18.5 V dc @ 3.5 A - 65 W	
Operating current	4.74 A or 3.5 A	
Temperature		
Operating (not writing to optical disc)	0°C to 35°C	32°F to 95°F
Operating (writing to optical disc)	5°C to 35°C	41°F to 95°F
Nonoperating	-20°C to 60°C	-4°F to 140°F
Relative humidity		
Operating	10% to 90%	
Nonoperating	5% to 95%	
Maximum altitude (unpressurized)		
Operating (14.7 to 10.1 psia)	-15 m to 3,048 m	50 ft to 10,000 ft
Nonoperating (14.7 to 4.4 psia)	-15 m to 12,192 m	-50 ft to 40,000 ft
Shock		
Operating	125 g, 2 ms, half-sine	
Nonoperating	200 g, 2 ms, half-sine	
Random vibration		
Operating	0.75 g zero-to-peak, 10 Hz to 500 Hz, 0.25 oct/min sweep rate	

	Metric	U.S.
Nonoperating	1.50 g zero-to-peak, 10 Hz to 500 Hz, 0.5 oct/min sweep rate	

NOTE: Applicable product safety standards specify thermal limits for plastic surfaces. The computer operates well within this range of temperatures.

33.8-cm (13.3-in), HD display specifications

	Metric	U.S.
Active diagonal size	33.8-cm	13.3-in
Resolution	1366x768 (HD)	
Active area	293.38x165.02	
PPI	118	
Surface treatment	Anti-glare	
Contrast ratio	300:1 (typical) – Anti-glare	
Response time	16 ms	
Brightness	200 nits (typical)	
Viewing angle	SVA	
Backlight	LED	
Luminance uniformity @ 13 points	1.4 (typ), 1.6 (max)	
Lifetime (1/2 luminance)	12,000 hours	
Color coordinate (white)	(0.313, 0.329)	
Color tolerance (white)	+/- 0.02	
Color tolerance (R, G, B)	+/- 0.03	
Color gamut	45% NTSC @CIE1931	

Hard drive specifications

320-GB*	
Dimensions	
Height	9.5 mm
Width	70 mm
Weight	92 g
Interface type	SATA
Transfer rate	100 MB/sec
Security	ATA security
Seek times (typical read, including setting)	
Single track	1.5 ms
Average	13 ms
Maximum	27 ms
Logical blocks	625,142,448
Disc rotational speed	5400 rpm or 7200 rpm
Operating temperature	5°C to 55°C (41°F to 131°F)
*1 GB = 1 billion bytes when referring to hard drive storage capacity. Actual accessible capacity is less. Actual drive specifications may differ slightly.	
NOTE: Certain restrictions and exclusions apply. Contact technical support for details.	

DVD±RW and CD-RW SuperMulti DL Combo Drive specifications

Applicable disc	Read: CD-DA, CD+(E)G, CD-MIDI, CD-TEXT, CD-ROM, CD-ROM XA, MIXED MODE CD, CD-I, CD-I Bridge (Photo-CD, Video CD), Multisession CD (Photo-CD, CD-EXTRA, Portfolio, CD-R, CD-RW), CD-R, CD-RW, DVD-ROM (DVD-5, DVD-9, DVD-10, DVD-18), DVD-R, DVD-RW, DVD+R, DVD+RW, DVD-RAM	Write: CD-R and CD-RW DVD+R, DVD+RW, DVD-R, DVD-RW, DVD-RAM
Center hole diameter	1.5 cm (0.59 in)	
Disc diameter		
Standard disc	12 cm (4.72 in)	
Mini disc	8 cm (3.15 in)	
Disc thickness	1.2 mm (0.047 in)	
Track pitch	0.74 μm	
Access time	CD	DVD
Random	< 175 ms	< 230 ms
Full stroke	< 285 ms	< 335 ms
Audio output level	Line-out, 0.7 Vrms	
Cache buffer	2 MB	
Data transfer rate		
24X CD-ROM	3,600 KB/sec	
8X DVD-ROM	10,800 KB/sec	
24X CD-R	3,600 KB/sec	
16X CD-RW	2,400 KB/sec	
8X DVD+R	10,800 KB/sec	
4X DVD+RW	5,400 KB/sec	
8X DVD-R	10,800 KB/sec	
4X DVD-RW	5,400 KB/sec	
2.4X DVD+R(9)	2,700 KB/sec	
5X DVD-RAM	6,750 KB/sec	
Transfer mode	Multiword DMA Mode	
Startup time	< 15 seconds	
Stop time	< 6 seconds	

Blu-ray ROM DVD±RW SuperMulti DL Drive

Applicable disc	Read:	Write:		
	CD-DA, CD+(E)G, CD-MIDI, CDTEXT, CD-ROM, CD-ROM XA, MIXED MODE CD, CD-I, CD-I Bridge (Photo-CD, Video CD), Multisession CD (Photo-CD, CD-EXTRA, Portfolio, CD-R, CD-RW), CD-R, CD-RW, DVDROM (DVD-5, DVD-9, DVD-10, DVD-18), DVD-R, DVD-RW, DVD+R, DVD+RW, DVD-RAM, HD-ROM (Single Layer), HD-ROM (Dual Layer), HD DVD-R, HD DVD-R for Dual Layer, HD DVD-RW	CD-R and CD-RW DVD+R, DVD+R(9), DVD+RW, DVD-R, DVD-R(9), DVD-RW, DVD-RAM		
Access time	CD	DVD	HD	
Random	170 ms	170 ms	230 ms	
Cache buffer	8 MB			
Data transfer rate				
24X CD-ROM	3,600 KB/sec			
8X DVD	10,800 KB/sec			
24X CD-R	3,600 KB/sec			
16X CD-RW	2,400 KB/sec			
8X DVD+R	10,800 KB/sec			
4X DVD+RW	5,400 KB/sec			
8X DVD-R	10,800 KB/sec			
4X DVD-RW	5,400 KB/sec			
2.4X DVD+R(9)	2,700 KB/sec			
5X DVD-RAM	6,750 KB/sec			
1X BD-ROM	4,500 KB/sec			
1X BD-R read	4,500 KB/sec			
1X BD-RE read	4,500 KB/sec			
Transfer mode	Multiword DMA Mode			

Specification information in Device Manager

Device Manager allows you to view and control the hardware attached to the computer, as well as provides hardware specification information.

You can also add hardware or modify device configurations using Device Manager.



NOTE: Windows 7 includes the User Account Control feature to improve the security of your computer. You may be prompted for your permission or password for tasks such as installing software, running utilities, or changing Windows settings. Refer to Windows Help and Support for more information.

After you open Device Manager, drill-down to a device and double-click it to access its properties.

To access Device Manager in Windows 7:

1. Select **Start > Computer > System properties**.
2. In the left pane, click **Device Manager**.

To access Device Manager in Windows XP:

1. Select **Start > My Computer**.
2. In the left pane of the System Tasks window, select **View system information**.
3. Select **Hardware tab > Device Manager**.

7 Backup and recovery

To protect your information, use Windows Backup and Restore to back up individual files and folders, back up your entire hard drive (select models only), create system repair discs (select models only) by using the installed optical drive (select models only) or an optional external optical drive, or create system restore points. In case of system failure, you can use the backup files to restore the contents of your computer.

Windows Backup and Restore provides the following options:

- Creating a system repair disc (select models only) by using the installed optical drive (select models only) or an optional external optical drive
- Backing up your information
- Creating a system image (select models only)
- Scheduling automatic backups (select models only)
- Creating system restore points
- Recovering individual files
- Restoring the computer to a previous state
- Recovering information using recovery tools

 **NOTE:** For detailed instructions, perform a search for these topics in Help and Support.

In case of system instability, HP recommends that you print the recovery procedures and save them for later use.

 **NOTE:** Windows includes the User Account Control feature to improve the security of your computer. You may be prompted for your permission or password for tasks such as installing software, running utilities, or changing Windows settings. Refer to Help and Support for more information.

Creating recovery media with HP Recovery Disc Creator

HP Recovery Disc Creator is a software program that offers an alternative way to create recovery media. After you successfully set up the computer, you can create recovery media using HP Recovery Disc Creator. This recovery media performs a system recovery if the hard drive becomes corrupted. A system recovery reinstalls the original operating system and the software programs installed at the factory, and then configures the settings for the programs.

HP Recovery Disc Creator can create two kinds of recovery DVDs as follows:

- **Windows DVD**—Installs the operating system without additional drivers or applications. Choosing this selection creates a DVD that restores the original operating system and the software programs installed at the factory.
- **Driver DVD**—Installs specific drivers and applications only, in the same way that the HP Software Setup utility installs drivers and applications.

Creating recovery media

 **NOTE:** Operating system recovery media can be created only once. Thereafter, the option to create that media will not be available.

1. Select **Start > All Programs > Productivity and Tools > HP Recovery Disc Creator**.
2. Select **Windows disk** or **Driver disk**.
3. From the drop-down menu, select the drive for burning the recovery media.
4. Click the **Create** button to start the burning process.

Backing up your information

Recovery after a system failure is as good as your most recent backup. Immediately after software setup, you should create system repair discs (select models only) using HP Recovery Disc Creator and the installed optical drive (select models only) or an optional external optical drive to back up your system. As you add new software and data files, you should continue to back up your system on a regular basis to maintain a reasonably current backup. The system repair discs (select models only) are used to start up (boot) the computer and repair the operating system in case of system instability or failure. Your initial and subsequent backups allow you to restore your data and settings if a failure occurs.

You can back up your information to an optional external hard drive, a network drive, or discs.

Note the following when backing up:

- Store personal files in the Documents library, and back it up regularly.
- Back up templates that are stored in their associated programs.
- Save customized settings that appear in a window, toolbar, or menu bar by taking a screen shot of your settings. The screen shot can be a time-saver if you have to reset your preferences.
- When backing up to discs, use any of the following types of discs (purchased separately): CD-R, CD-RW, DVD+R, DVD+R DL, DVD-R, DVD-R DL, or DVD±RW. The discs you use will depend on the type of external optical drive you are using.



NOTE: DVDs and DVDs with double-layer (DL) support store more information than CDs, so using them for backup reduces the number of recovery discs required.

- When backing up to discs, number each disc before inserting it into the external drive.

To create a backup using Backup and Restore:



NOTE: Be sure that the computer is connected to AC power before you start the backup process.



NOTE: The backup process may take over an hour, depending on file size and the speed of the computer.

1. Select **Start > All Programs > Maintenance > Backup and Restore**.
2. Follow the on-screen instructions to set up your backup, create a system image (select models only), or create a system repair disc (select models only).

Performing a system recovery

In case of system failure or instability, the computer provides the following tools to recover your files:

- Windows recovery tools: You can use Windows Backup and Restore to recover information you have previously backed up. You can also use Windows Startup Repair to fix problems that might prevent Windows from starting correctly.
- **f11** recovery tools: You can use the **f11** recovery tools to recover your original hard drive image. The image includes the Windows operating system and software programs installed at the factory.

 **NOTE:** If you are unable to boot (start up) your computer and you cannot use the system repair discs you previously created (select models only), you must purchase a Windows 7 operating system DVD to reboot the computer and repair the operating system. For additional information, refer to [Using a Windows 7 operating system DVD \(purchased separately\) on page 96](#).

Using the Windows recovery tools

To recover information you previously backed up:

1. Select **Start > All Programs > Maintenance > Backup and Restore**.
2. Follow the on-screen instructions to recover your system settings, your computer (select models only), or your files.

To recover your information using Startup Repair, follow these steps:

 **CAUTION:** Using Startup Repair completely erases hard drive contents and reformats the hard drive. All files you have created and any software installed on the computer are permanently removed. When reformatting is complete, the recovery process restores the operating system, as well as the drivers, software, and utilities from the backup used for recovery.

1. If possible, back up all personal files.
2. If possible, check for the presence of the Windows partition and the HP Recovery partition.

To check for the Windows partition, select **Start > Computer**.

To check for the HP Recovery partition, click **Start**, right-click **Computer**, click **Manage**, and then click **Disk Management**.

 **NOTE:** If the HP Recovery partition has been deleted, the **f11** restore option will not function. You must recover your operating system and programs using the Windows 7 operating system DVD and the *Driver Recovery* disc (both purchased separately) if the Windows partition and the HP Recovery partition are not listed. For additional information, refer to [Using a Windows 7 operating system DVD \(purchased separately\) on page 96](#).

3. If the Windows partition and the HP Recovery partition are listed, restart the computer, and then press **f8** before the Windows operating system loads.
4. Select **Startup Repair**.
5. Follow the on-screen instructions.

 **NOTE:** For additional information on recovering information using the Windows tools, perform a search for these topics in Help and Support.

Using f11 recovery tools

 **CAUTION:** Using **f11** recovery tools completely erases hard drive contents and reformats the hard drive. All files you have created and any software installed on the computer are permanently removed. The **f11** recovery tool reinstalls the operating system and HP programs and drivers that were installed at the factory. Software not installed at the factory must be reinstalled.

To recover the original hard drive image using **f11**:

1. If possible, back up all personal files.
2. If possible, check for the presence of the HP Recovery partition: click **Start**, right-click **Computer**, click **Manage**, and then click **Disk Management**.

 **NOTE:** If the HP Recovery partition is not listed, you must recover your operating system and programs using the Windows 7 operating system DVD and the *Driver Recovery* disc (both purchased separately). For additional information, refer to [Using a Windows 7 operating system DVD \(purchased separately\) on page 96](#).

3. If the HP Recovery partition is listed, restart the computer, and then press **esc** while the “Press the ESC key for Startup Menu” message is displayed at the bottom of the screen.
4. Press **f11** while the “Press <F11> for recovery” message is displayed on the screen.
5. Follow the on-screen instructions.

Using a Windows 7 operating system DVD (purchased separately)

To order a Windows 7 operating system DVD, go to <http://www.hp.com/support>, select your country or region, and follow the on-screen instructions. You can also order the DVD by calling technical support. For contact information, refer to the *Worldwide Telephone Numbers* booklet included with the computer.

 **CAUTION:** Using a Windows 7 operating system DVD completely erases hard drive contents and reformats the hard drive. All files you have created and any software installed on the computer are permanently removed. When reformatting is complete, the recovery process helps you restore the operating system, as well as drivers, software, and utilities.

To initiate recovery using a Windows 7 operating system DVD:

 **NOTE:** This process takes several minutes.

1. If possible, back up all personal files.
2. Restart the computer, and then insert the Windows 7 operating system DVD into the optical drive before the Windows operating system loads.
3. When prompted, press any keyboard key.
4. Follow the on-screen instructions.
5. Click **Next**.
6. Select **Repair your computer**.
7. Follow the on-screen instructions.

After the repair is completed:

1. Eject the Windows 7 operating system DVD, and then insert the *Driver Recovery* disc.
2. Install the Hardware Enabling Drivers first, and then install Recommended Applications.

8 Power cord set requirements

The wide-range input feature of the computer permits it to operate from any line voltage from 100 to 120 volts ac, or from 220 to 240 volts ac.

The 3-conductor power cord set included with the computer meets the requirements for use in the country or region where the equipment is purchased.

Power cord sets for use in other countries and regions must meet the requirements of the country or region where the computer is used.

Requirements for all countries and regions

The following requirements are applicable to all countries and regions:

- The length of the power cord set must be at least **1.5 m** (5.0 ft) and no more than **2.0 m** (6.5 ft).
- All power cord sets must be approved by an acceptable accredited agency responsible for evaluation in the country or region where the power cord set will be used.
- The power cord sets must have a minimum current capacity of 10 A and a nominal voltage rating of 125 or 250 V ac, as required by the power system of each country or region.
- The appliance coupler must meet the mechanical configuration of an EN 60 320/IEC 320 Standard Sheet C13 connector for mating with the appliance inlet on the back of the computer.

Requirements for specific countries and regions

Country/region	Accredited agency	Applicable note number
Argentina	IRAM	1
Australia	SAA	1
Austria	OVE	1
Belgium	CEBEC	1
Brazil	ABNT	1
Canada	CSA	2
Chile	IMQ	1
Denmark	DEMKO	1
Finland	FIMKO	1
France	UTE	1
Germany	VDE	1
India	ISI	1
Israel	SII	1
Italy	IMQ	1
Japan	JIS	3
The Netherlands	KEMA	1
New Zealand	SANZ	1
Norway	NEMKO	1
The People's Republic of China	CCC	4
Saudi Arabia	SASO	7
Singapore	PSB	1
South Africa	SABS	1
South Korea	KTL	5
Sweden	SEMKO	1
Switzerland	SEV	1
Taiwan	BSMI	6
Thailand	TISI	1
The United Kingdom	ASTA	1

Country/region	Accredited agency	Applicable note number
The United States	UL	2
<ol style="list-style-type: none"> 1. The flexible cord must be Type HO5VV-F, 3-conductor, 0.75mm² conductor size. Power cord set fittings (appliance coupler and wall plug) must bear the certification mark of the agency responsible for evaluation in the country or region where it will be used. 2. The flexible cord must be Type SVT/SJT or equivalent, No. 18 AWG, 3-conductor. The wall plug must be a two-pole grounding type with a NEMA 5-15P (15 A, 125 V ac) or NEMA 6-15P (15 A, 250 V ac) configuration. CSA or C-UL mark. UL file number must be on each element. 3. The appliance coupler, flexible cord, and wall plug must bear a “T” mark and registration number in accordance with the Japanese Dentori Law. The flexible cord must be Type VCTF, 3-conductor, 0.75mm² or 1.25mm² conductor size. The wall plug must be a two-pole grounding type with a Japanese Industrial Standard C8303 (7 A, 125 V ac) configuration. 4. The flexible cord must be Type RVV, 3-conductor, 0.75mm² conductor size. Power cord set fittings (appliance coupler and wall plug) must bear the CCC certification mark. 5. The flexible cord must be Type H05VV-F 3X0.75mm² conductor size. KTL logo and individual approval number must be on each element. Corset approval number and logo must be printed on a flag label. 6. The flexible cord must be Type HVCTF 3X1.25mm² conductor size. Power cord set fittings (appliance coupler, cable, and wall plug) must bear the BSMI certification mark. 7. For 127 V ac, the flexible cord must be Type SVT or SJT 3 x 18 AWG, with plug NEMA 5-15P (15 A, 125 V ac), with UL and CSA or C-UL marks. For 240 V ac, the flexible cord must be Type H05VV-F 3X0.75/1.00mm² conductor size, with plug BS 1363/A with BSI or ASTA marks. 		

9 Recycling

Battery

When a non-rechargeable or rechargeable battery has reached the end of its useful life, do not dispose of the battery in general household waste. Follow the local laws and regulations in your area for battery disposal.

HP encourages customers to recycle used electronic hardware, HP original print cartridges, and rechargeable batteries. For more information about recycling programs, see the HP Web site at <http://www.hp.com/recycle>.

Display

⚠ WARNING! The backlight contains mercury. Exercise caution when removing and handling the backlight to avoid damaging this component and causing exposure to the mercury.

⚠ CAUTION: The procedures in this chapter can result in damage to display components. The only components intended for recycling purposes are the LCD panel and the backlight. When you remove these components, handle them carefully.

📝 NOTE: Materials Disposal. This HP product contains mercury in the backlight in the display assembly that might require special handling at end-of-life. Disposal of mercury may be regulated because of environmental considerations. For disposal or recycling information, contact your local authorities, or see the Electronic Industries Alliance (EIA) Web site at <http://www.eiae.org>.

This section provides disassembly instructions for the display assembly. The display assembly must be disassembled to gain access to the backlight **(1)** and the liquid crystal display (LCD) panel **(2)**.



📝 NOTE: The procedures provided in this chapter are general disassembly instructions. Specific details, such as screw sizes, quantities, and locations, and component shapes and sizes, can vary from one computer model to another.

Perform the following steps to disassemble the display assembly:

1. Remove all screw covers (1) and screws (2) that secure the display bezel to the display assembly.

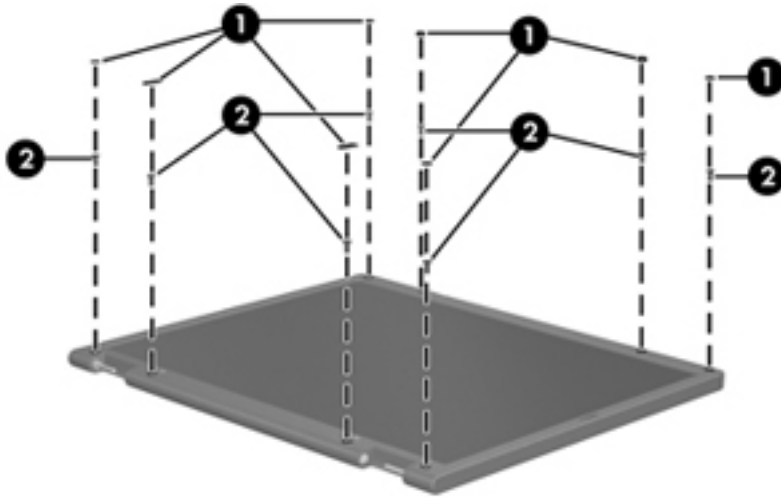

2. Lift up and out on the left and right inside edges (1) and the top and bottom inside edges (2) of the display bezel until the bezel disengages from the display assembly.
3. Remove the display bezel (3).

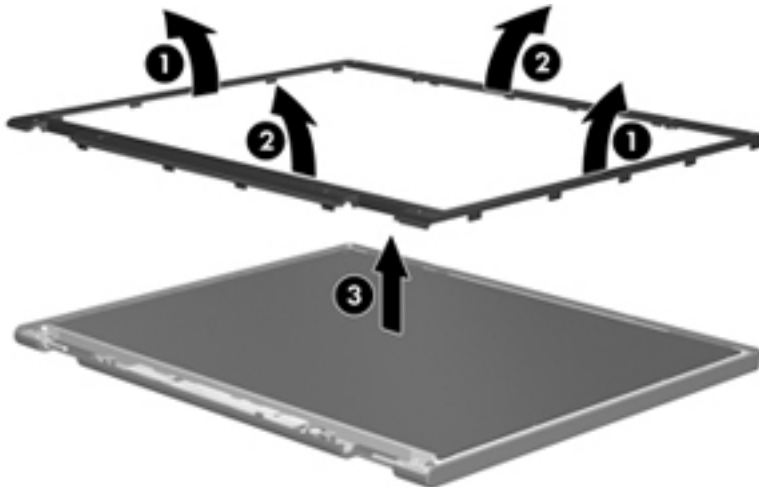

4. Disconnect all display panel cables (1) from the display inverter and remove the inverter (2).

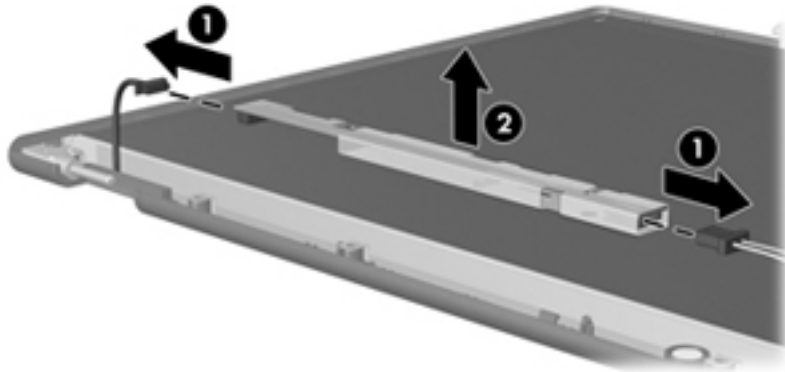

5. Remove all screws (1) that secure the display panel assembly to the display enclosure.
6. Remove the display panel assembly (2) from the display enclosure.

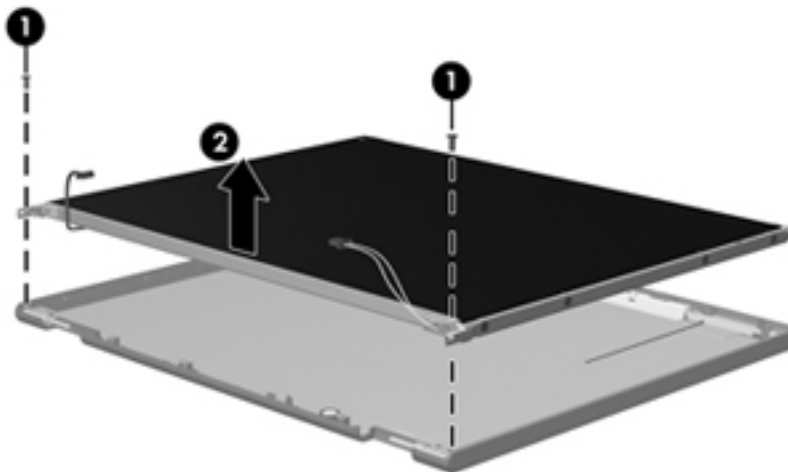

7. Position the display panel assembly upside-down.
8. Remove all screws that secure the display panel frame to the display panel.

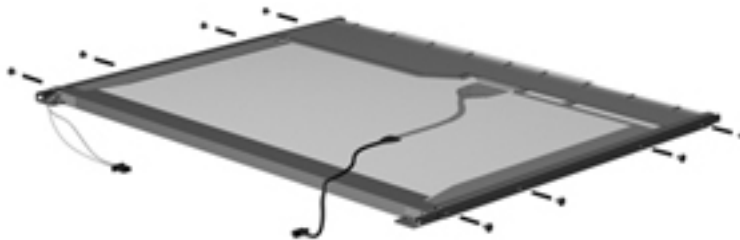

9. Use a sharp-edged tool to cut the tape (1) that secures the sides of the display panel to the display panel frame.

10. Remove the display panel frame (2) from the display panel.

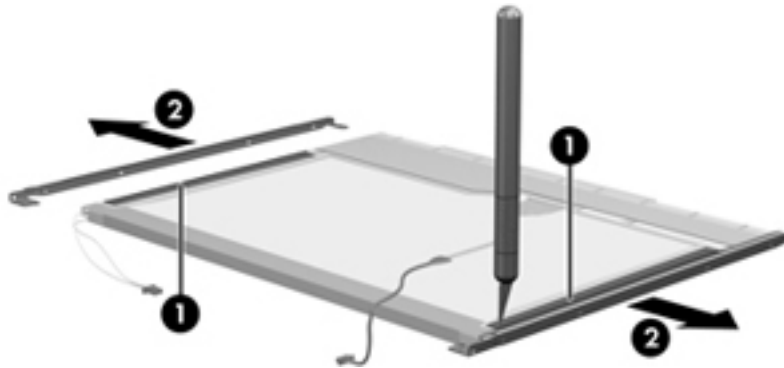

11. Remove the screws (1) that secure the backlight cover to the display panel.
12. Lift the top edge of the backlight cover (2) and swing it outward.

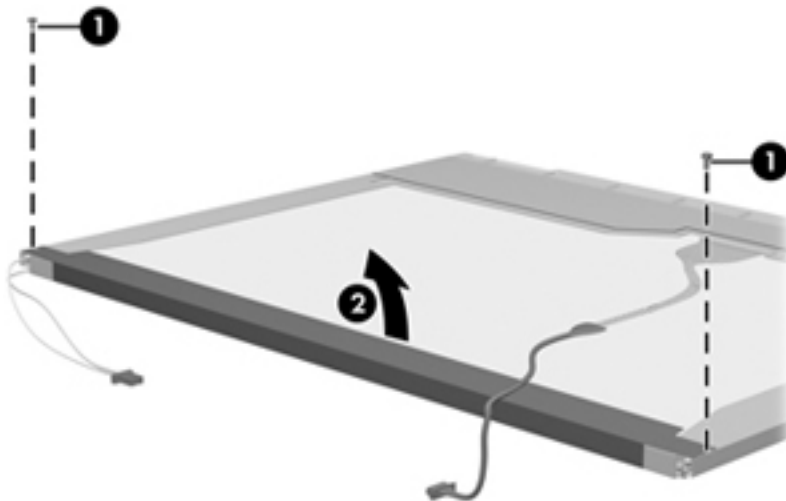

13. Remove the backlight cover.
14. Position the display panel right-side up.

15. Remove the backlight cables (1) from the clip (2) in the display panel.

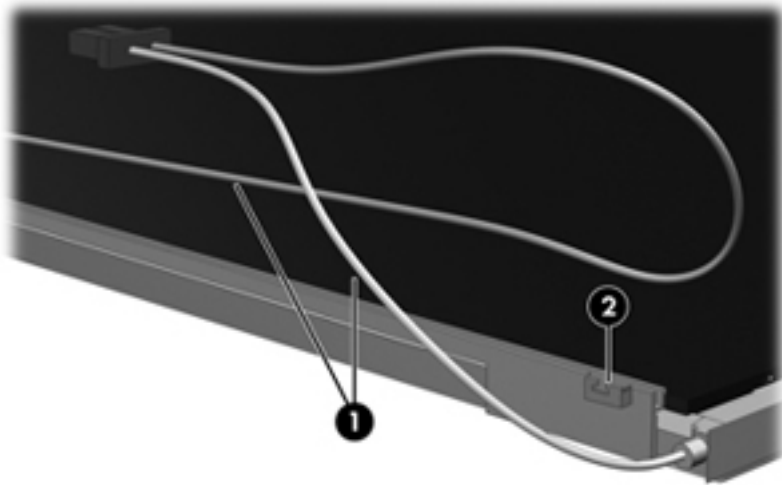

16. Position the display panel upside-down.

⚠ WARNING! The backlight contains mercury. Exercise caution when removing and handling the backlight to avoid damaging this component and causing exposure to the mercury.

17. Remove the backlight frame from the display panel.

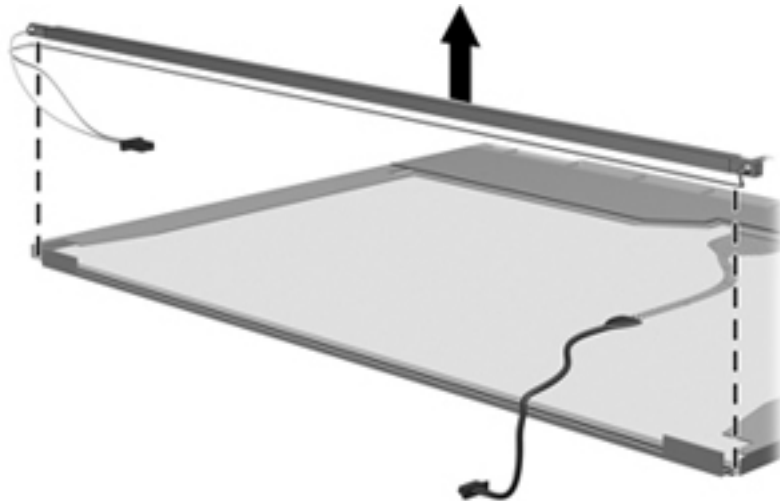

18. Remove the backlight from the backlight frame.

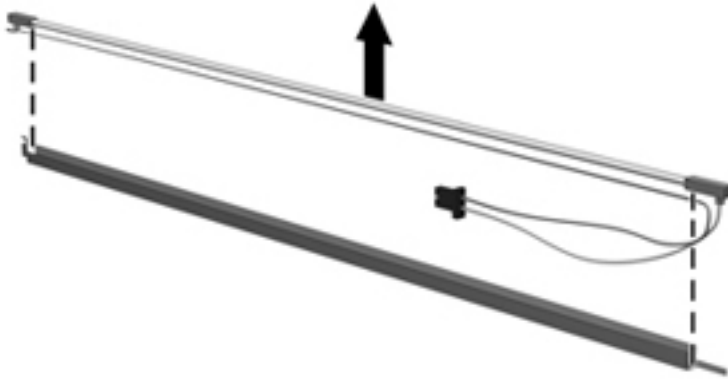

19. Disconnect the display panel cable (1) from the LCD panel.
20. Remove the screws (2) that secure the LCD panel to the display rear panel.
21. Release the LCD panel (3) from the display rear panel.
22. Release the tape (4) that secures the LCD panel to the display rear panel.

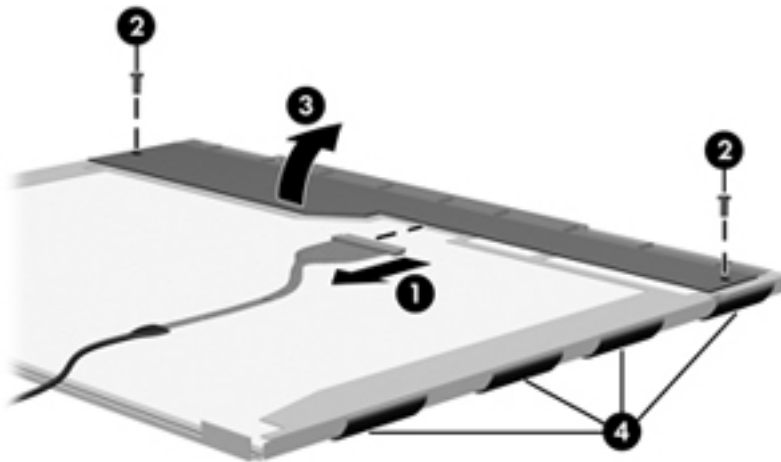

23. Remove the LCD panel.

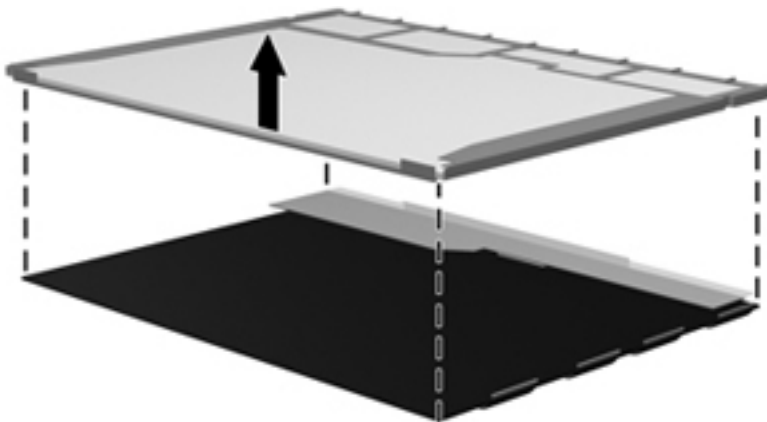

24. Recycle the LCD panel and backlight.

Index

A

- AC adapter light 13
- AC adapter, spare part numbers 20, 24
- advanced system diagnostics 84
- antennas
 - disconnecting 41, 43
- audio board
 - removal 54
 - spare part number 16, 22, 54
- audio, product description 2
- audio-in (microphone) jack 11
- audio-out (headphone) jack 11

B

- Backup and Restore 94
- base enclosure, spare part number 16, 22
- battery
 - removal 31
 - spare part number 16, 22, 31
- BIOS
 - determining version 82
 - downloading an update 83
 - updating 81
- Blu-ray ROM DVD±RW SuperMulti DL Drive
 - specifications 90
- Blu-ray ROM DVD±RW SuperMulti DL Drive, spare part number 16, 19, 23, 35
- Bluetooth card
 - spare part number 43
- bottom door
 - removal 33
 - spare part number 17, 24, 33
- buttons
 - left TouchPad 7
 - optical drive eject 13

- power 9
- right TouchPad 7
- TouchPad on/off 7
- Web browser 10
- wireless 10

C

- cables, service considerations 26
- caps lock light, identifying 8
- case, basic carrying 20, 21
- case, nylon 20, 21
- case, slim top load 20, 21
- chipset, product description 1
- components
 - display 6
 - front 11
 - left side 12
 - right side 13
 - top 7
- Computer Setup
 - navigating and selecting 79
 - restoring factory settings 80
- computer specifications 86
- connectors
 - power 13
- connectors, service considerations 26

D

- diskette drive
 - precautions 26
- display assembly
 - removal 69
 - spare part numbers 69
- display bezel
 - removal 72
 - spare part numbers 18, 22
- display component recycling 101

- display components, spare part numbers 18
- display hinge
 - removal 75
 - spare part number 18, 22, 76
- display panel
 - product description 1
 - spare part number 23
- display specifications 87
- drive light 11
- drives
 - optical 13
 - preventing damage 26
- DVD±RW Double-Layer Drive
 - spare part number 16, 19, 23, 35

E

- electrostatic discharge 27
- embedded numeric keypad,
 - identifying 10
- esc key, identifying 10
- Ethernet, product description 2
- external media cards, product description 3
- external monitor port 12

F

- f11 recovery 96
- fan sink
 - spare part number 63
- fingerprint reader board
 - removal 52
 - spare part number 16, 22, 52
- fingerprint reader, identifying 10
- fn key, identifying 10
- function board/power button board
 - removal 56
 - spare part number 16, 22

function keys
 identifying 10

G

graphics, product description 1
grounding equipment and
 methods 29

H

hard drive
 precautions 26
 product description 2
 removal 37
 spare part numbers 16, 19, 37
 specifications 88
hard drive cover, removal 38
Hard Drive Hardware Kit, spare
 part number 19, 22, 37
hard drive recovery 96
HDMI port, identifying 12
heat sink
 removal 63
 spare part number 17
hinge
 removal 75
 spare part number 22

I

integrated webcam light,
 identifying 6
internal display switch 7
internal microphones, identifying
 6

J

jacks
 audio-in (microphone) 11
 audio-out (headphone) 11
 RJ-45 (network) 12

K

keyboard
 product description 3
 removal 45
 spare part numbers 16, 23, 45
keypad
 embedded numeric 10
keys
 esc 10
 fn 10
 function 10

num lk 11
Windows applications 11
Windows logo 10

L

latch assembly
 removal 60
 spare part number 17, 24, 60
legacy support, USB 79
lights
 AC adapter 13
 caps lock 8
 drive 11
 optical drive 13
 power 8
 TouchPad 8
 Web browser 8
 webcam 6
 wireless 8
lock, combination 20, 21

M

mass storage devices, spare part
 numbers 19
Media Card Reader 11
memory module
 product description 1
 removal 39
 spare part numbers 17, 39
microphone (audio-in) jack
 product description 2
model name 1
mouse, basic carrying 20, 21

N

num lk key, identifying 11

O

operating system, product
 description 3
optical drive
 identifying 13
 precautions 26
 product description 2
 removal 35
 spare part numbers 16, 19, 35
 specifications 89, 90
optical drive eject button 13
optical drive light 13
optical drive protective insert
 illustrated 18

P

packing guidelines 28
plastic parts 25
Plastics Kit, spare part number
 18, 22
pointing device, product
 description 3
ports
 external monitor 12
 HDMI 12
 product description 3
 USB 12, 13
power button board
 replacing 56
 spare part number 56
power button, identifying 9
power connector cable
 removal 77
 spare part number 16, 22, 77
power connector, identifying 13
power cord
 set requirements 98
 spare part numbers 20, 21
power light 8
power requirements, product
 description 3
processor
 product description 1
 removal 66
 spare part numbers 17, 66
product description
 audio 2
 chipset 1
 display panel 1
 Ethernet 2
 external media cards 3
 graphics 1
 hard drives 2
 keyboard 3
 memory module 1
 microphone 2
 operating system 3
 optical drives 2
 pointing devices 3
 ports 3
 power requirements 3
 processors 1
 product name 1
 security 3
 serviceability 5

- webcam 2
- wireless 2
- product name 1

R

- recovery partition 96
- removal/replacement
 - preliminaries 25
 - procedures 30
- restoring the hard drive 96
- RJ-45 (network) jack, identifying 12
- RTC battery
 - removal 58
 - spare part number 16, 23, 58
- Rubber Kit, spare part number 23

S

- Screw Kit, spare part number 20, 23
- Secure Digital card insert, illustrated 18
- security cable slot 12
- security screw
 - removal 32
- security, product description 3
- service considerations 25
- serviceability, product description 5
- setup utility
 - navigating and selecting 79
 - restoring factory settings 80
- SIM, removal 34
- slots
 - security cable 12
- speaker assembly
 - removal 59
 - spare part number 16, 22, 59
- speakers, identifying 9
- specifications
 - Blu-ray ROM DVD±RW SuperMulti DL Drive 90
 - computer 86
 - display 87
 - DVD±RW and CD-RW SuperMulti DL Combo Drive 89
 - hard drive 88
 - optical drive 89, 90
- static-shielding materials 29

- system board
 - removal 61
 - spare part numbers 16, 22, 61
- system repair disc 92
- system restore points 92

T

- thermal material, replacement 65
- tools required 25
- top cover
 - removal 47
 - spare part number 16, 22, 47
- TouchPad
 - buttons 7
- TouchPad light, identifying 8
- TouchPad on/off button 7
- TouchPad zone
 - identifying 7
- transporting guidelines 28

U

- USB legacy support 79
- USB ports, identifying 12, 13

V

- vents, identifying 12

W

- Web browser button, identifying 10
- Web browser light 8
- webcam
 - product description 2
 - webcam light, identifying 6
 - webcam module
 - removal 74
 - spare part number 18, 22
 - webcam, identifying 6
- Windows 7 operating system
 - DVD 96
- Windows applications key, identifying 11
- Windows Backup and Restore 92
- Windows logo key, identifying 10
- wireless antennas
 - disconnecting 41, 43
- wireless antennas, identifying 6
- wireless button, identifying 10
- wireless light 8

- wireless, product description 2
- WLAN antennas, identifying 6
- WLAN/Bluetooth combo card
 - removal 43
 - spare part number 16, 43
- workstation guidelines 28
- WWAN antennas, identifying 6
- WWAN module
 - removal 41
 - spare part number 16, 22, 41

Free Manuals Download Website

<http://myh66.com>

<http://usermanuals.us>

<http://www.somanuals.com>

<http://www.4manuals.cc>

<http://www.manual-lib.com>

<http://www.404manual.com>

<http://www.luxmanual.com>

<http://aubethermostatmanual.com>

Golf course search by state

<http://golfingnear.com>

Email search by domain

<http://emailbydomain.com>

Auto manuals search

<http://auto.somanuals.com>

TV manuals search

<http://tv.somanuals.com>