

HP Notebook

Reference Guide

© Copyright 2011 Hewlett-Packard
Development Company, L.P.

Bluetooth is a trademark owned by its proprietor and used by Hewlett-Packard Company under license. Intel is a trademark of Intel Corporation in the U.S. and other countries. Java is a U.S. trademark of Sun Microsystems, Inc. Microsoft and Windows are U.S. registered trademarks of Microsoft Corporation.

The information contained herein is subject to change without notice. The only warranties for HP products and services are set forth in the express warranty statements accompanying such products and services. Nothing herein should be construed as constituting an additional warranty. HP shall not be liable for technical or editorial errors or omissions contained herein.

Second Edition: March 2011

First Edition: June 2010

Document Part Number: 607195-002

Product notice

This reference guide describes features that are common to most models. Some features may not be available on your computer.

Safety warning notice

 **WARNING!** To reduce the possibility of heat-related injuries or of overheating the computer, do not place the computer directly on your lap or obstruct the computer air vents. Use the computer only on a hard, flat surface. Do not allow another hard surface, such as an adjoining optional printer, or a soft surface, such as pillows or rugs or clothing, to block airflow. Also, do not allow the AC adapter to contact the skin or a soft surface, such as pillows or rugs or clothing, during operation. The computer and the AC adapter comply with the user-accessible surface temperature limits defined by the International Standard for Safety of Information Technology Equipment (IEC 60950).

Table of contents

| | |
|---|-----------|
| 1 Introduction | 1 |
| Finding more information about your new computer | 1 |
| 2 Networking (select models only) | 2 |
| Creating a wireless connection | 2 |
| Identifying wireless and network status icons | 2 |
| Turning wireless devices on or off | 4 |
| Using HP Connection Manager (select models only) | 4 |
| Using operating system controls | 4 |
| Using a WLAN | 5 |
| Connecting to an existing WLAN | 5 |
| Setting up a new WLAN | 6 |
| Protecting your WLAN | 6 |
| Roaming to another network | 6 |
| Using HP Mobile Broadband (select models only) | 7 |
| Inserting a SIM | 7 |
| Removing a SIM | 8 |
| Using GPS (select models only) | 8 |
| Using Bluetooth wireless devices | 8 |
| Bluetooth and Internet Connection Sharing (ICS) | 8 |
| Connecting to a wired network | 9 |
| Using a modem (select models only) | 9 |
| Connecting a modem cable | 9 |
| Connecting a country- or region-specific modem cable adapter | 11 |
| Selecting a location setting | 11 |
| Viewing the current location selection | 11 |
| Adding new locations when traveling | 12 |
| Connecting to a local area network (LAN) (select models only) | 13 |
| 3 Multimedia | 15 |
| Using the media activity controls | 15 |

| | |
|---|-----------|
| Audio | 15 |
| Adjusting the volume | 16 |
| Checking audio functions on the computer | 16 |
| Webcam (select models only) | 18 |
| Video | 19 |
| VGA | 19 |
| HDMI | 20 |
| Configuring audio for HDMI | 20 |
| Intel Wireless Display (select models only) | 21 |
| 4 Power management | 22 |
| Shutting down the computer | 22 |
| Setting power options | 23 |
| Using power-saving states | 23 |
| Initiating and exiting Sleep | 23 |
| Initiating and exiting Hibernation | 23 |
| Using the power meter | 24 |
| Using power plans | 24 |
| Viewing the current power plan | 24 |
| Selecting a different power plan | 24 |
| Customizing power plans | 25 |
| Setting password protection on wakeup | 25 |
| Using Power Assistant (select models only) | 27 |
| Using battery power | 27 |
| Finding additional battery information | 27 |
| Using Battery Check | 28 |
| Displaying the remaining battery charge | 28 |
| Maximizing battery discharge time | 28 |
| Managing low battery levels | 28 |
| Identifying low battery levels | 28 |
| Resolving a low battery level | 29 |
| Resolving a low battery level when external power is available | 29 |
| Resolving a low battery level when a charged battery is available ... | 29 |
| Resolving a low battery level when no power source is available | 29 |
| Resolving a low battery level when the computer cannot exit | |
| Hibernation | 29 |
| Conserving battery power | 29 |
| Storing a battery | 30 |
| Disposing of a used battery | 30 |
| Replacing the battery | 30 |
| Using external AC power | 30 |

| | |
|---|-----------|
| Testing an AC adapter | 32 |
| Switching between graphics modes (select models only) | 32 |
| 5 External cards and devices | 33 |
| Using Media Card Reader cards (select models only) | 33 |
| Inserting a digital card | 33 |
| Removing a digital card | 34 |
| Using PC Cards (select models only) | 34 |
| Configuring a PC Card | 35 |
| Inserting a PC Card | 36 |
| Removing a PC Card | 37 |
| Using ExpressCards (select models only) | 37 |
| Configuring an ExpressCard | 37 |
| Inserting an ExpressCard | 38 |
| Removing an ExpressCard | 39 |
| Using smart cards (select models only) | 39 |
| Inserting a smart card | 40 |
| Removing a smart card | 40 |
| Using a USB device | 40 |
| Connecting a USB device | 41 |
| Removing a USB device | 41 |
| Using 1394 devices (select models only) | 41 |
| Connecting a 1394 device | 42 |
| Removing a 1394 device | 42 |
| Using an eSATA device (select models only) | 42 |
| Connecting an eSATA device | 43 |
| Removing an eSATA device | 43 |
| Using a serial device (select models only) | 44 |
| Using optional external devices | 44 |
| Using optional external drives | 44 |
| Using the expansion port (select models only) | 45 |
| Using the docking connector (select models only) | 45 |
| 6 Drives | 47 |
| Handling drives | 47 |
| Using hard drives | 48 |
| Improving hard drive performance | 48 |
| Using Disk Defragmenter | 48 |
| Using Disk Cleanup | 48 |
| Using HP 3D DriveGuard (select models only) | 49 |
| Identifying HP 3D DriveGuard status | 49 |

| | |
|---|-----------|
| Managing power with a parked hard drive | 49 |
| Using HP 3D DriveGuard software | 50 |
| Using optical drives (select models only) | 50 |
| Identifying the installed optical drive | 50 |
| Inserting an optical disc | 50 |
| Tray load | 50 |
| Slot load | 51 |
| Removing an optical disc | 51 |
| Tray load | 51 |
| When the disc tray opens normally | 52 |
| When the disc tray fails to open normally | 52 |
| Slot load | 53 |
| Sharing optical drives | 54 |
| Using RAID (select models only) | 54 |
| 7 Security | 55 |
| Protecting the computer | 55 |
| Using passwords | 56 |
| Setting passwords in Windows | 56 |
| Setting passwords in Computer Setup | 57 |
| Managing a BIOS administrator password | 57 |
| Entering a BIOS administrator password | 58 |
| Managing a Computer Setup DriveLock password | 58 |
| Setting a DriveLock password | 59 |
| Entering a DriveLock password | 60 |
| Changing a DriveLock password | 60 |
| Removing DriveLock protection | 60 |
| Using Computer Setup Auto DriveLock | 61 |
| Entering an Automatic DriveLock password | 61 |
| Removing Automatic DriveLock protection | 61 |
| Using antivirus software | 63 |
| Using firewall software | 64 |
| Installing critical security updates | 65 |
| Using HP ProtectTools Security Manager (select models only) | 66 |
| Installing an optional security cable | 67 |
| Using the fingerprint reader (select models only) | 68 |
| Locating the fingerprint reader | 68 |
| 8 Maintenance | 69 |
| Cleaning your computer | 70 |
| Cleaning products | 70 |

| | |
|---|-----------|
| Cleaning procedures | 70 |
| Cleaning the display | 70 |
| Cleaning the sides and cover | 70 |
| Cleaning the TouchPad and keyboard | 71 |
| Cleaning a tablet PC pen and pen holder | 71 |
| Updating programs and drivers | 71 |
| Using SoftPaq Download Manager | 72 |
| 9 Computer Setup (BIOS) and System Diagnostics | 73 |
| Using Computer Setup | 73 |
| Starting Computer Setup | 73 |
| Navigating and selecting in Computer Setup | 73 |
| Restoring factory settings in Computer Setup | 74 |
| Updating the BIOS | 75 |
| Determining the BIOS version | 75 |
| Downloading a BIOS update | 75 |
| Using System Diagnostics | 76 |
| 10 MultiBoot | 77 |
| About the boot device order | 77 |
| Enabling boot devices in Computer Setup | 78 |
| Considering boot order changes | 79 |
| Choosing MultiBoot preferences | 80 |
| Setting a new boot order in Computer Setup | 80 |
| Dynamically choosing a boot device using the F9 prompt | 80 |
| Setting a MultiBoot Express prompt | 81 |
| Entering MultiBoot Express preferences | 81 |
| 11 Management | 82 |
| Using Client Management Solutions | 82 |
| Configuring and deploying a software image | 82 |
| Managing and updating software | 83 |
| HP Client Manager for Altiris (select models only) | 83 |
| HP CCM (Client Configuration Manager) (select models only) | 85 |
| HP SSM (System Software Manager) | 85 |
| Using Intel Active Management Technology (select models only) | 86 |
| Enabling the iAMT solution | 87 |
| Using the MEBx setup utility menus | 87 |
| Appendix A Traveling with the computer | 89 |

| | |
|---|-----------|
| Appendix B Troubleshooting resources | 91 |
| Appendix C Electrostatic Discharge | 92 |
| Index | 93 |

1 Introduction

This guide contains general information about HP notebook computers.

 **NOTE:** Some of the features described in this guide may not be available on your computer.

Finding more information about your new computer

The following user guides and reference material are provided with your computer, either in print, on the computer hard drive, or on an optical disc or SD Card:

- *Setup Instructions* poster—Guides you through setting up your computer and turning it on. The poster is included in the box with the computer.

 **NOTE:** Refer to the poster for the location of your user guides and reference material.

- *Getting Started*—Contains information about your computer, including product-specific features, backup and recovery, maintenance, and specifications.
- *Help and Support*—Contains information about the operating system, drivers, troubleshooting tools, and technical support. To access Help and Support, select **Start > Help and Support**. For country- or region-specific support, go to <http://www.hp.com/support>, select your country or region, and follow the on-screen instructions.
- *Safety & Comfort Guide*—Describes proper workstation setup and proper posture, health, and work habits for computer users. It also provides important electrical and mechanical safety information. To access this guide, select **Start > Help and Support > User Guides**. This guide is also available on the Web at <http://www.hp.com/ergo>.
- *Regulatory, Safety and Environmental Notices*—Contains safety and regulatory information, and battery disposal information. To access the notices, select **Start > Help and Support > User Guides**.

2 Networking (select models only)

Your computer supports two types of Internet access:

- **Wireless**—Refer to [Creating a wireless connection on page 2](#).
- **Wired**—Refer to [Connecting to a wired network on page 9](#).

 **NOTE:** You must set up Internet service before you can connect to the Internet.

Creating a wireless connection





Your computer may be equipped with one or more of the following wireless devices:





- Wireless local area network (WLAN) device
- HP Mobile Broadband Module (wireless wide area network (WWAN) device)
- Bluetooth® device

For more information on wireless technology, refer to the information and Web site links provided in Help and Support.







Identifying wireless and network status icons

Windows® 7

| Icon | Name | Description |
|---|---|--|
|  | Wireless (connected) | Indicates that one or more wireless devices are on. |
|  | Wireless (disconnected) | Indicates that all wireless devices are off. |
|  | HP Connection Manager (select models only) | Opens HP Connection Manager, which enables you to create and manage WWAN connections (select models only), and monitor the status of WLAN and Bluetooth connections. |
|  | Wired network (connected) | Indicates that one or more network devices are connected to the network. |

| | | |
|---|-------------------------------------|---|
|  | Network (disabled/ disconnected) | Indicates that all network devices are disabled in Windows Control Panel. |
|  | Network (connected) | Indicates that one or more network devices are connected to a network. |
|  | Network (disconnected) | Indicates that network devices are not connected to a network. |
|  | Network (disabled/ disconnected) | Indicates that no wireless connections are available. |

Windows Vista®

| Icon | Name | Description |
|---|--|--|
|  | Wireless (connected) | Indicates that one or more wireless devices are on. |
|  | Wireless (disconnected) | Indicates that all wireless devices are off. |
|  | HP Connection Manager (select models only) | Opens HP Connection Manager, which enables you to create and manage WWAN connections (select models only), and monitor the status of WLAN and Bluetooth connections. |
|  | Wireless network connection (connected) | Indicates that one or more WLAN devices are connected to a network. |
|  | Wireless network connection (disconnected) | Indicates that one or more WLAN devices are not connected to a network. |
|  | Network status (connected) | Connected to the wired network. |
|  | Network status (disconnected) | Not connected to the wired network. |

Turning wireless devices on or off

You can use the wireless button or HP Connection Manager (select models only) to turn on and turn off wireless devices.

 **NOTE:** A computer may have a wireless button, a wireless switch, or a wireless key on the keyboard. The term wireless button is used throughout this guide to refer to all types of wireless controls. Refer to the *Getting Started* guide for information on identifying the location of the wireless button on your computer.

To turn off wireless devices using HP Connection Manager:

- ▲ Right-click the HP Connection Manager icon in the notification area, at the far right of the taskbar, and then click the power button next to the desired device.

– or –

Select **Start > All Programs > HP > HP Connection Manager**, and then click the power button next to the desired device.

Using HP Connection Manager (select models only)

HP Connection Manager provides a central location for managing your wireless devices, an interface for connecting to the Internet using HP Mobile Broadband, and an interface for sending and receiving SMS (text) messages. HP Connection Manager allows you to manage the following devices:

- Wireless local area network (WLAN)/WiFi
- Wireless wide area network (WWAN)/HP Mobile Broadband
- Bluetooth®

HP Connection Manager provides information and notifications on connection status, power status, SIM details, and SMS messages. Status information and notifications are provided in the notification area, at the far right of the task bar.

To open HP Connection Manager:

- ▲ Click the HP Connection Manager icon in the task bar.

– or –

Click **Start > All Programs > HP > HP Connection Manager**.

For more information, refer to the HP Connection Manager software Help.

Using operating system controls

The Network and Sharing Center allows you to set up a connection or network, connect to a network, manage wireless networks, and diagnose and repair network problems.

To use operating system controls:

- ▲ Select **Start > Control Panel > Network and Internet > Network and Sharing Center**.

For more information, select **Start > Help and Support**.

Using a WLAN

A wireless connection connects the computer to Wi-Fi networks, or WLANs. A WLAN is composed of other computers and accessories that are linked by a wireless router or a wireless access point.

Connecting to an existing WLAN

Windows 7

1. Be sure that the WLAN device is on. (Refer to [Turning wireless devices on or off on page 4](#)).
2. Click the network icon in the notification area, at the far right of the taskbar.
3. Select your WLAN from the list.
4. Click **Connect**.

If the network is a security-enabled WLAN, you are prompted to enter a network security code. Type the code, and then click **OK** to complete the connection.

 **NOTE:** If no WLANs are listed, you may be out of range of a wireless router or access point.

NOTE: If you do not see the WLAN you want to connect to, click **Open Network and Sharing Center**, and then click **Set up a new connection or network**. A list of options is displayed. You can choose to manually search for and connect to a network or to create a new network connection.

Windows Vista

1. Be sure that the WLAN device is on. (Refer to [Turning wireless devices on or off on page 4](#).)
2. Select **Start > Connect to**.
3. Select your WLAN from the list.
 - If the network is unsecured, a warning is displayed. Click **Connect Anyway** to accept the warning and complete the connection.
 - If the network is a security-enabled WLAN, you are prompted to enter a network security code. Type the code, and then click **Connect** to complete the connection.

 **NOTE:** If no WLANs are listed, you may be out of range of a wireless router or access point.

NOTE: If you do not see the WLAN you want to connect to, click **Show all connections**. A list of available networks is displayed. You can choose to connect to an existing network or you can create a new network connection.

After the connection is made, you can place the mouse pointer over the network icon in the notification area, at the far right of the taskbar, to verify the name and status of the connection.

 **NOTE:** The functional range (how far your wireless signals travel) depends on WLAN implementation, router manufacturer, and interference from other electronic devices or structural barriers such as walls and floors.

Setting up a new WLAN

Required equipment:

- A broadband modem (either DSL or cable) (purchased separately) **(1)** and high-speed Internet service purchased from an Internet service provider (ISP)
- A wireless router (purchased separately) **(2)**

 **NOTE:** Some cable modems include a built-in router. Check with your ISP to see if you need a separate router.

- The wireless computer **(3)**

The illustration below shows an example of a wireless network installation that is connected to the Internet.



 **NOTE:** When setting up a wireless connection, be sure that your computer and wireless router are synchronized. To synchronize your computer and wireless router, turn your computer and wireless router off and then back on.

As your network grows, additional wireless and wired computers can be connected to the network to access the Internet.

For help in setting up your WLAN, refer to the information provided by your router manufacturer or your ISP.

Protecting your WLAN

When you set up a WLAN or access an existing WLAN, always enable security features to protect your network from unauthorized access. WLANs in public areas (hotspots) like coffee shops and airports may not provide any security. If you are concerned about the security of your computer in a hotspot, limit your network activities to e-mail that is not confidential and basic Internet surfing.

Wireless radio signals travel outside the network, so other WLAN devices can pick up unprotected signals. You can take the following precautions to protect your WLAN:

- **Firewall**—A firewall checks both data and requests for data that are sent to your network, and discards any suspicious items. Firewalls are available in both software and hardware. Some networks use a combination of both types.
- **Wireless encryption**—Wi-Fi Protected Access (WPA) uses security settings to encrypt and decrypt data transmitted over the network. WPA uses Temporal Key Integrity Protocol (TKIP) to dynamically generate a new key for every packet. It also generates different sets of keys for each computer on the network.

Roaming to another network

When you move your computer within range of another WLAN, Windows attempts to connect to that network. If the attempt is successful, your computer is automatically connected to the new network. If

Windows does not recognize the new network, follow the same procedure you used initially to connect to your WLAN.

Using HP Mobile Broadband (select models only)

HP Mobile Broadband enables your computer to use wireless wide area networks (WWANs) to access the Internet from more places and over larger areas than it can by using WLANs. Using HP Mobile Broadband requires a network service provider, which in most cases is a mobile phone network provider.

When used with mobile network provider service, HP Mobile Broadband gives you the freedom to stay connected to the Internet, send e-mail, or connect to your corporate network whether you are on the road or outside the range of Wi-Fi hotspots.

 **NOTE:** You may need the HP Mobile Broadband Module serial number to activate mobile broadband service. Refer to the *Getting Started* guide for the location of the serial number.

Some mobile network service providers require the use of a subscriber identity module (SIM). A SIM contains basic information about you or your computer, such as a personal identification number (PIN), as well as network information. Some computers include a preinstalled SIM. If the SIM is not preinstalled, it may be included with the HP Mobile Broadband information provided with your computer, or it may be provided separately by the mobile network service provider.

For information on inserting and removing the SIM, refer to [Inserting a SIM on page 7](#) and [Removing a SIM on page 8](#).

For information on HP Mobile Broadband and how to activate service with a preferred mobile network service provider, refer to the HP Mobile Broadband information included with your computer. For additional information, see the HP Web site at <http://www.hp.com/go/mobilebroadband> (U.S. only).

Inserting a SIM

 **NOTE:** To identify the SIM slot location, refer to the *Getting Started* guide.

1. Shut down the computer. If you are not sure whether the computer is off or in Hibernation, turn the computer on by pressing the power button. Then shut down the computer through the operating system.
2. Close the display.
3. Disconnect all external devices connected to the computer.
4. Unplug the power cord from the AC outlet.
5. Remove the battery.
6. Insert the SIM into the SIM slot, and gently press the SIM into the slot until it is firmly seated.

 **CAUTION:** When inserting a SIM, position the card to match the icon next to the SIM slot on the computer. If a SIM is inserted incorrectly, it could damage the SIM and the SIM connector.

To reduce the risk of damage to the connector, use minimal force when inserting a SIM.

7. Replace the battery.

 **NOTE:** HP Mobile Broadband is disabled if the battery is not replaced.

8. Reconnect external power and external devices.
9. Turn on the computer.

Removing a SIM

 **NOTE:** To identify the SIM slot location, refer to the *Getting Started* guide.

1. Shut down the computer. If you are not sure whether the computer is off or in Hibernation, turn the computer on by pressing the power button. Then shut down the computer through the operating system.
2. Close the display.
3. Disconnect all external devices connected to the computer.
4. Unplug the power cord from the AC outlet.
5. Remove the battery.
6. Press in on the SIM, and then remove it from the slot.
7. Replace the battery.
8. Reconnect external power and external devices.
9. Turn on the computer.

Using GPS (select models only)

Your computer may be equipped with a Global Positioning System (GPS). GPS satellites deliver location, speed, and direction information to GPS-equipped systems.

For more information, refer to the HP GPS and Location software Help.

Using Bluetooth wireless devices

A Bluetooth device provides short-range wireless communications that replace the physical cable connections that traditionally link electronic devices such as the following:

- Computers
- Phones
- Imaging devices (cameras and printers)
- Audio devices

Bluetooth devices provide peer-to-peer capability that allows you to set up a personal area network (PAN) of Bluetooth devices. For information on configuring and using Bluetooth devices, refer to the Bluetooth software Help.

Bluetooth and Internet Connection Sharing (ICS)

HP does **not** recommend setting up one computer with Bluetooth as a host and using it as a gateway through which other computers may connect to the Internet. When two or more computers are

connected using Bluetooth, and Internet Connection Sharing (ICS) is enabled on one of the computers, the other computers may not be able to connect to the Internet using the Bluetooth network.

The strength of Bluetooth is in synchronizing information transfers between your computer and wireless devices including cellular phones, printers, cameras, and PDAs. The inability to consistently connect two or more computers to share the Internet through Bluetooth is a limitation of Bluetooth and the Windows operating system.

Connecting to a wired network

Using a modem (select models only)

A modem must be connected to an analog telephone line using a 6-pin, RJ-11 modem cable (purchased separately). In some countries or regions, a specific modem cable adapter is also required. Jacks for digital PBX systems may resemble analog telephone jacks, but they are not compatible with the modem.

⚠ WARNING! To reduce the risk of electric shock, fire, or damage to the equipment, do not plug a modem or telephone cable into the RJ-45 (network) jack.

If the modem cable contains noise suppression circuitry **(1)**, which prevents interference from TV and radio reception, orient the circuitry end of the cable **(2)** toward the computer.



Connecting a modem cable

1. Plug the modem cable into the modem jack **(1)** on the computer.

2. Plug the modem cable into the RJ-11 telephone wall jack (2).

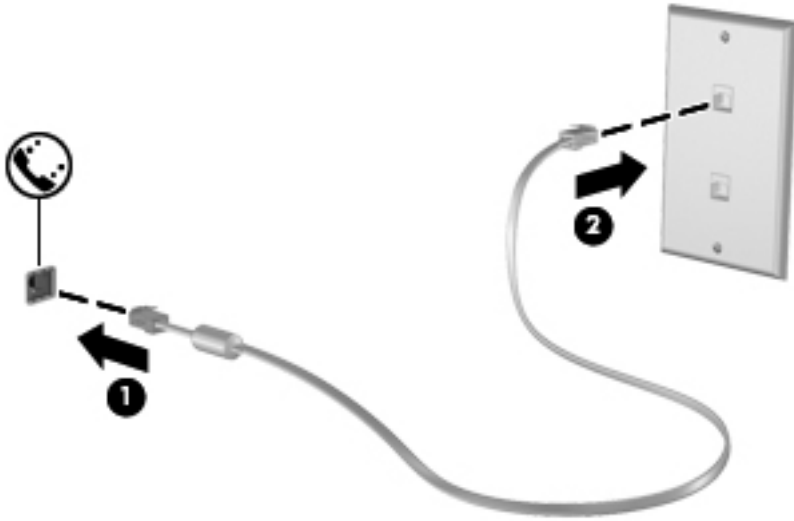

Connecting a country- or region-specific modem cable adapter

Telephone jacks vary by country or region. To use the modem and the modem cable outside the country or region in which you purchased the computer, you must obtain a country- or region-specific modem cable adapter.

To connect the modem to an analog telephone line that does not have an RJ-11 telephone jack, follow these steps:

1. Plug the modem cable into the modem jack **(1)** on the computer.
2. Plug the modem cable into the modem cable adapter **(2)**.
3. Plug the modem cable adapter **(3)** into the telephone wall jack.

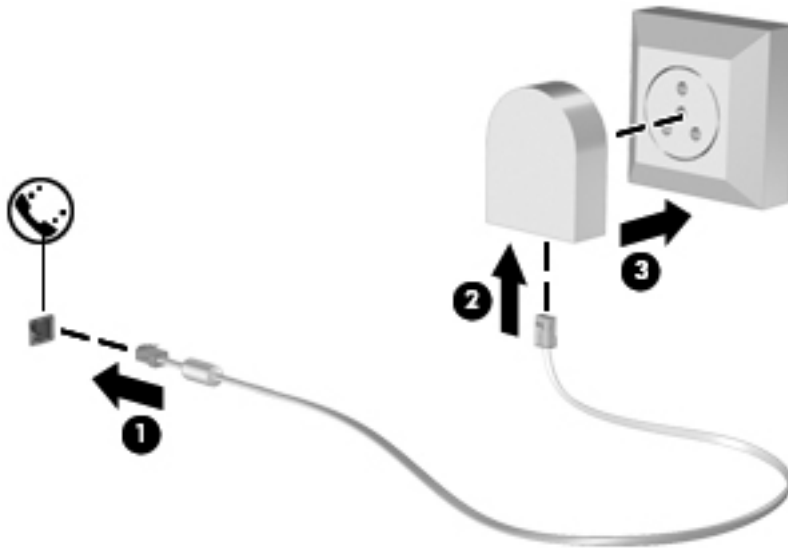

Selecting a location setting

Viewing the current location selection

Windows 7

1. Select **Start > Control Panel**.
2. Click **Clock, Language, and Region**.
3. Click **Region and Language**.
4. Click the **Location** tab to display your location.

Windows Vista

1. Select **Start > Control Panel**.
2. Click **Clock, Language, and Region**.
3. Click **Regional and Language Options**.

Your location is displayed under Location.

Adding new locations when traveling

On a new computer, the only location setting available to the modem is a location setting for the country or region in which you purchased the computer. As you travel to different countries or regions, set the internal modem to a location setting that meets the operating standards of the country or region in which you are using the modem.

As you add new location settings, they are saved by the computer so that you can switch among settings at any time. You can add multiple location settings for any country or region.

CAUTION: To reduce the risk of losing your home country or region settings, do not delete your current modem country or region settings. To enable modem use in other countries or regions while preserving your home country or region configuration, add a new configuration for each location in which you will use the modem.

CAUTION: To reduce the risk of configuring the modem in a way that violates the telecommunications regulations and laws of the country or region you are visiting, select the country or region in which the computer is located. The modem may not function properly if the correct country or region selection is not made.

Windows 7

1. Select **Start > Device and Printers**.
2. Right-click the device that represents your computer, and click **Modem settings**.

 **NOTE:** You must set up an initial (current) location area code before you can view the Dialing Rules tab. If you do not have a location already set up, you are prompted to enter the location when you click Modem settings.

3. Click the **Dialing Rules** tab.
4. Click **New**. The New Location window opens.
5. In the Location name box, type a name (such as `home` or `work`) for the new location setting.
6. Select a country or region from the Country/region list. (If you select a country or region that is not supported by the modem, the country/region selection for USA or UK is displayed.)
7. Enter the area code, a carrier code (if necessary), and the number for an outside line (if necessary).
8. Next to Dial using, click **Tone** or **Pulse**.
9. Click **OK** to save your new location setting.
10. Do one of the following:
 - To set your new location setting as the current location, click **OK**.
 - To select another location setting as the current location setting, select your preference from the settings in the **Location** list, and then click **OK**.

 **NOTE:** You can use the preceding procedure to add location settings for places within your own country or region as well as in other countries or regions. For example, you could add a setting named `work` that includes dialing rules for accessing an outside line.

Windows Vista

1. Select **Start > Control Panel**.
2. Click **Hardware and Sound**.
3. Click **Phone and Modem Options**.
4. Click the **Dialing Rules** tab.
5. Click **New**. The New Location window opens.
6. In the Location name box, type a name (such as `home` or `work`) for the new location setting.
7. Select a country or region from the Country/region list. (If you select a country or region that is not supported by the modem, the country/region selection for USA or UK is displayed.)
8. Enter the area code, a carrier code (if necessary), and the number for an outside line (if necessary).
9. Next to Dial using, click **Tone** or **Pulse**.
10. Click **OK** to save your new location setting.
11. Do one of the following:
 - To set your new location setting as the current location, click **OK**.
 - To select another location setting as the current location setting, select your preference from the settings in the Location list, and then click **OK**.

 **NOTE:** You can use the preceding procedure to add location settings for places within your own country or region as well as in other countries or regions. For example, you could add a setting named `work` that includes dialing rules for accessing an outside line.

Connecting to a local area network (LAN) (select models only)

Connecting to a LAN requires an 8-pin, RJ-45 network cable (purchased separately). If the network cable contains noise suppression circuitry **(1)**, which prevents interference from TV and radio reception, orient the circuitry end of the cable **(2)** toward the computer.



To connect the network cable:

1. Plug the network cable into the network jack **(1)** on the computer.

2. Plug the other end of the network cable into a network wall jack (2).

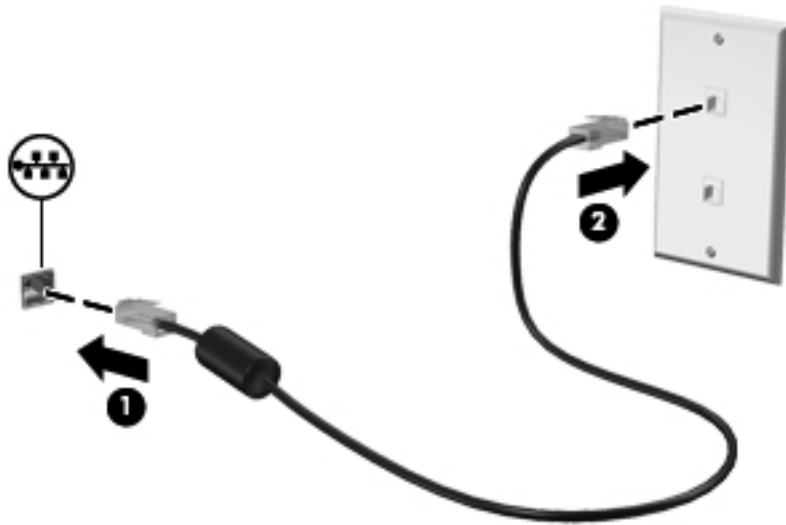

⚠ WARNING! To reduce the risk of electric shock, fire, or damage to the equipment, do not plug a modem cable or telephone cable into an RJ-45 (network) jack.

3 Multimedia

Your computer may include the following:

- Integrated speaker(s)
- Integrated microphone(s)
- Integrated webcam
- Preinstalled multimedia software
- Multimedia buttons or keys

Using the media activity controls

Depending on your computer model, you may have the following media activity controls that allow you to play, pause, fast forward, or rewind a media file:

- Media buttons
- Media hotkeys (specific keys pressed in combination with the [fn](#) key)
- Media keys

Refer to the *Getting Started* guide for information about your computer's media activity controls.

Audio

Your computer provides a variety of audio-related functions:

- Play music.
- Record sound.
- Download music from the Internet.
- Create multimedia presentations.
- Transmit sound and images with instant messaging programs.
- Stream radio programs.
- Create (burn) audio CDs using the installed optical drive (select models only) or on an optional external optical drive (purchased separately).

Adjusting the volume

Depending on your computer model, you can adjust the volume using the following:

- Volume buttons
- Volume hotkeys (specific keys pressed in combination with the **fn** key)
- Volume keys

 **WARNING!** To reduce the risk of personal injury, adjust the volume before putting on headphones, earbuds, or a headset. For additional safety information, refer to the *Regulatory, Safety and Environmental Notices*.

 **NOTE:** Volume can also be controlled through the operating system and some programs.

NOTE: Refer to the *Getting Started* guide for information on what type of volume controls your computer has.

Checking audio functions on the computer

 **NOTE:** For best results when recording, speak directly into the microphone and record sound in a setting free of background noise.

Windows 7

To check the audio functions on your computer, follow these steps:

1. Select **Start > Control Panel > Hardware and Sound > Sound**.
2. When the Sound window opens, click the **Sounds** tab. Under Program Events, select any sound event, such as a beep or alarm, and click the **Test** button.

You should hear sound through the speakers or through connected headphones.

To check the recording functions on your computer, follow these steps:

1. Select **Start > All Programs > Accessories > Sound Recorder**.
2. Click **Start Recording** and speak into the microphone. Save the file to your desktop.
3. Open a multimedia program and play back the sound.

To confirm or change the audio settings on your computer, select **Start > Control Panel > Hardware and Sound > Sound**.

Windows Vista

To check the audio functions on your computer, follow these steps:

1. Select **Start > Control Panel > Hardware and Sound > Sound**.
2. When the Sound window opens, click the **Sounds** tab. Under Program, select any sound event, such as a beep or alarm, and click the **Test** button.

You should hear sound through the speakers or through connected headphones.

To check the recording functions on your computer, follow these steps:

1. Select **Start > All Programs > Accessories > Sound Recorder**.
2. Click **Start Recording** and speak into the microphone. Save the file to your desktop.
3. Open a multimedia program and play back the sound.

To confirm or change the audio settings on your computer, select **Start > Control Panel > Audio**.

Webcam (select models only)

Some computers include an integrated webcam. With the preinstalled software, you can use the webcam to take a photo or record a video. You can preview and save the photo or video recording.

The webcam software enables you to experiment with the following features:

- Capturing and sharing video
- Streaming video with instant message software
- Taking still photos

For information on how to access the webcam, refer to the *Getting Started* guide. For information on using the webcam, select **Start > Help and Support**.

Video

Your computer may have one or more of the following external video ports:

- VGA
- HDMI (High Definition Multimedia Interface)

 **NOTE:** Refer to the *Getting Started* guide for information about your computer's video ports.

VGA

The external monitor port, or VGA port, is an analog display interface that connects an external VGA display device such as an external VGA monitor or a VGA projector to the computer.

- ▲ To connect a VGA display device, connect the device cable to the external monitor port.

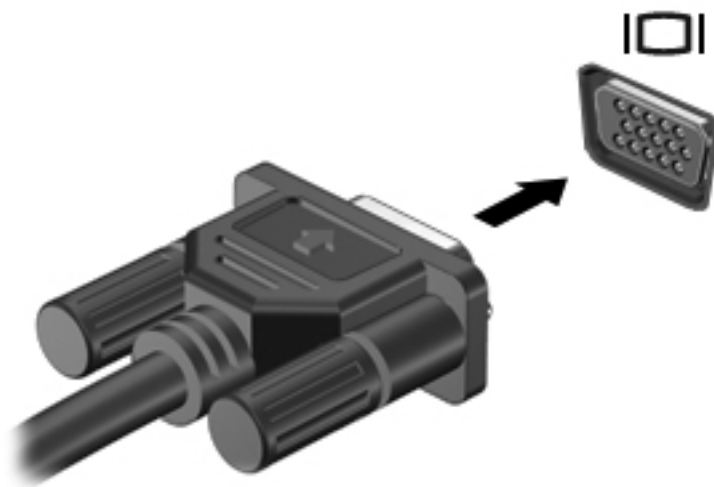

 **NOTE:** For product-specific instructions on switching the screen image, refer to your *Getting Started* guide.

HDMI

The HDMI port connects the computer to an optional video or audio device, such as a high-definition television, or to any compatible digital or audio component.

 **NOTE:** To transmit video signals through the HDMI port, you need an HDMI cable (purchased separately).

One HDMI device can be connected to the HDMI port on the computer. The information displayed on the computer screen can be simultaneously displayed on the HDMI device.

To connect a video or audio device to the HDMI port:

1. Connect one end of the HDMI cable to the HDMI port on the computer.

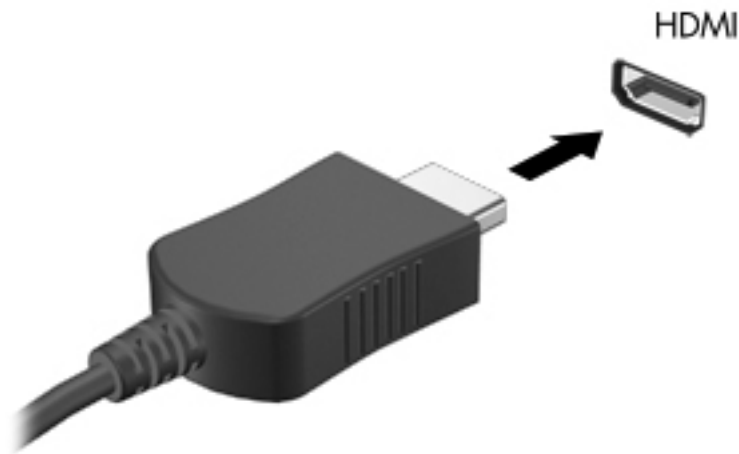

2. Connect the other end of the cable to the video device, and then refer to the device manufacturer's instructions for additional information.

 **NOTE:** For product-specific instructions on switching the screen image, refer to your *Getting Started* guide.

Configuring audio for HDMI

To configure HDMI audio, first connect an audio or video device, such as a high-definition TV, to the HDMI port on your computer. Then configure the default audio playback device as follows:

1. Right-click the **Speakers** icon in the notification area, at the far right of the taskbar, and then click **Playback devices**.
2. On the Playback tab, click either **Digital Output** or **Digital Output Device (HDMI)**.
3. Click **Set Default**, and then click **OK**.

To return audio to the computer speakers, follow these steps:

1. Right-click the **Speakers** icon in the notification area, at the far right of the taskbar, and then click **Playback devices**.
2. On the Playback tab, click **Speakers**.
3. Click **Set Default**, and then click **OK**.

Intel Wireless Display (select models only)

Intel® Wireless Display allows you to share your computer content wirelessly on your TV. To experience wireless display, a wireless TV adapter (purchased separately) is required. Content that asserts output protection, such as DVD and Blu-ray discs, will not play on Intel Wireless Display. For details about using the wireless TV adapter, refer to the manufacturer's instructions.

 **NOTE:** Be sure that wireless is enabled on your computer before using the wireless display.

4 Power management

 **NOTE:** A computer may have a power button or a power switch. The term *power button* is used throughout this guide to refer to both types of power controls.

Shutting down the computer

 **CAUTION:** Unsaved information is lost when the computer shuts down.

The shut down command closes all open programs, including the operating system, and then turns off the display and computer.

Shut down the computer under any of the following conditions:

- When you need to replace the battery or access components inside the computer
- When you are connecting an external hardware device that does not connect to a Universal Serial Bus (USB) port
- When the computer will be unused and disconnected from external power for an extended period

Although you can shut down the computer with the power button, the recommended procedure is to use the Windows shut down command:

 **NOTE:** If the computer is in the Sleep state or in Hibernation, you must first exit Sleep or Hibernation before shutdown is possible.

1. Save your work and close all open programs.
2. **Windows 7**—Select **Start > Shut down**.

Windows Vista—Select **Start**, click the arrow next to the Lock button, and then click **Shut Down**.

 **NOTE:** If you have been registered to a network domain, the button you click is called Shut Down instead of Turn Off Computer.

If the computer is unresponsive and you are unable to use the preceding shutdown procedures, try the following emergency procedures in the sequence provided:

- Press **ctrl+alt+delete**, and then click the **Power** button.
- Press and hold the power button for at least 5 seconds.
- Disconnect the computer from external power and remove the battery.

Setting power options

Using power-saving states

The computer has two power-saving states that are enabled at the factory: Sleep and Hibernation.

When Sleep is initiated, the power lights blink and the screen clears. Your work is saved to memory, letting you exit Sleep faster than exiting Hibernation. If the computer is in the Sleep state for an extended period or if the battery reaches a critical battery level while in the Sleep state, the computer initiates Hibernation.

When Hibernation is initiated, your work is saved to a hibernation file on the hard drive and the computer turns off.

 **CAUTION:** To reduce the risk of possible audio and video degradation, loss of audio or video playback functionality, or loss of information, do not initiate Sleep or Hibernation while reading from or writing to a disc or an external media card.

 **NOTE:** You cannot initiate any type of networking connection or perform any computer functions while the computer is in the Sleep state or in Hibernation.

Initiating and exiting Sleep

The system is set at the factory to initiate Sleep after a period of inactivity when running on battery power or on external power.

Power settings and timeouts can be changed using Power Options in Windows Control Panel.

With the computer on, you can initiate Sleep in any of the following ways:

- Briefly press the power button.
- Close the display.
- **Windows 7**—Select **Start**, click the arrow next to the Shut down button, and then click **Sleep**.
- **Windows Vista**—Select **Start**, click the arrow next to the Lock button, and then click **Sleep**.

To exit Sleep:

- Briefly press the power button.
- If the display is closed, open the display.
- Press a key on the keyboard.
- Tap or swipe the TouchPad.

When the computer exits Sleep, the power lights turn on and your work returns to the screen as it was before you stopped working.

 **NOTE:** If you have set a password to be required on wakeup, you must enter your Windows password before your work will return to the screen.

Initiating and exiting Hibernation

The system is set at the factory to initiate Hibernation after a period of inactivity when running on battery power or on external power, or when the battery reaches a critical battery level.

Power settings and timeouts can be changed in Windows Control Panel.

To initiate Hibernation:

- ▲ **Windows 7**—Select **Start**, click the arrow next to the Shut down button, and then click **Hibernate**.

Windows Vista—Select **Start**, click the arrow next to the Lock button, and then click **Hibernate**.

To exit Hibernation:

- ▲ Briefly press the power button.

The power lights turn on and your work returns to the screen where you stopped working.

 **NOTE:** If you have set a password to be required on wakeup, you must enter your Windows password before your work will return to the screen.

Using the power meter

The power meter is located in the notification area, at the far right of the taskbar. The power meter allows you to quickly access power settings and view the remaining battery charge.

- To display the percentage of remaining battery charge and the current power plan, move the pointer over the power meter icon.
- To access Power Options, or to change the power plan, click the power meter icon and select an item from the list.

Different power meter icons indicate whether the computer is running on battery or external power. The icon also displays a message if the battery has reached a low or critical battery level.

Using power plans

A power plan is a collection of system settings that manages how the computer uses power. Power plans can help you conserve power or maximize performance.

Viewing the current power plan

Use any of the following methods:

- Click the power meter icon in the notification area, at the far right of the taskbar.
- **Windows 7**—Select **Start > Control Panel > System and Security > Power Options**.
- **Windows Vista**—Select **Start > Control Panel > System and Maintenance > Power Options**.

Selecting a different power plan

Use any of the following methods:

- Click the power meter icon in the notification area, and then select a power plan from the list.
- **Windows 7**—Select **Start > Control Panel > System and Security > Power Options**, and then select an item from the list.
Windows Vista—Select **Start > Control Panel > System and Maintenance > Power Options**, and then select an item from the list.

Customizing power plans

Windows 7

1. Click the power meter icon in the notification area, and then click **More power options**.
– or –
Select **Start > Control Panel > System and Security > Power Options**.
2. Select a power plan, and then click **Change plan settings**.
3. Change the settings as needed.
4. To change additional settings, click **Change advanced power settings** and make your changes.

Windows Vista

1. Click the power meter icon in the notification area, and then click **More power options**.
– or –
Select **Start > Control Panel > System and Maintenance > Power Options**.
2. Select a power plan, and then click **Change plan settings**.
3. Change the settings as needed.
4. To change additional settings, click **Change advanced power settings** and make your changes.

Setting password protection on wakeup

To set the computer to prompt for a password when the computer exits Sleep or Hibernation, follow these steps:

Windows 7

1. Select **Start > Control Panel > System and Security > Power Options**.
2. In the left pane, click **Require a password on wakeup**.
3. Click **Change Settings that are currently unavailable**.
4. Click **Require a password (recommended)**.

 **NOTE:** If you need to create a user account password or change your current user account password, click **Create or change your user account password**, and then follow the on-screen instructions. If you do not need to create or change a user account password, go to step 5.

5. Click **Save changes**.

Windows Vista

1. Select **Start > Control Panel > System and Maintenance > Power Options**.
2. In the left pane, click **Require a password on wakeup**.
3. Click **Change Settings that are currently unavailable**.

4. Click **Require a password (recommended)**.
5. Click **Save changes**.

Using Power Assistant (select models only)

Power Assistant allows you to configure system settings to optimize your computer's power consumption and battery charge. Power Assistant provides tools and information to help you make informed decisions on power management:

- Power consumption predictions in hypothetical system configurations
- Predefined power profiles
- Usage details and graphs showing power consumption trends over time

To start Power Assistant when Windows is running:

▲ Select **Start > All Programs > HP > HP Power Assistant**.

– or –

Press **fn+f6** (select models only).

For more information about using, configuring, and managing Power Assistant, refer to the Power Assistant software Help.

Using battery power

 **WARNING!** To reduce potential safety issues, use only the battery provided with the computer, a replacement battery provided by HP, or a compatible battery purchased from HP.

The computer runs on battery power whenever it is not plugged into external AC power. Computer battery life varies, depending on power management settings, running programs, display brightness, external devices connected to the computer, and other factors. Keeping the battery in the computer whenever the computer is plugged into AC power charges the battery and also protects your work in case of a power outage. If the computer contains a charged battery and is running on external AC power, the computer automatically switches to battery power if the AC adapter is disconnected from the computer or an AC power loss occurs.

 **NOTE:** When you disconnect AC power, the display brightness is automatically decreased to save battery life. For information on increasing or decreasing display brightness, refer to the *Getting Started* guide. Select computer models can switch between graphic modes to increase battery life. For more information, refer to [Switching between graphics modes \(select models only\) on page 32](#).

Finding additional battery information

Help and Support provides the following tools and information about the battery:

- Battery Check tool to test battery performance
- Information on calibration, power management, and proper care and storage to maximize battery life
- Information on battery types, specifications, life cycles, and capacity

To access battery information:

▲ Select **Start > Help and Support > Learn > Power Plans: Frequently Asked Questions**.

Using Battery Check

Battery Check in Help and Support provides information on the status of the battery installed in the computer.

To run Battery Check:

1. Connect the AC adapter to the computer.

 **NOTE:** The computer must be connected to external power for Battery Check to work properly.

2. Select **Start > Help and Support > Troubleshoot > Power, Thermal and Mechanical**.
3. Click the **Power** tab, and then click **Battery Check**.

Battery Check examines the battery and its cells to see if they are functioning properly, and then reports the results of the examination.

Displaying the remaining battery charge

- ▲ Move the pointer over the power meter icon in the notification area, at the far right of the taskbar.

Maximizing battery discharge time

Battery discharge time varies depending on the features you use while on battery power. Maximum discharge time gradually decreases as the battery storage capacity naturally degrades.

Tips for maximizing battery discharge time:

- Lower the brightness on the display.
- Remove the battery from the computer when it is not being used or charged.
- Store the battery in a cool, dry location.
- Select the **Power saver** setting in Power Options.

Managing low battery levels

The information in this section describes the alerts and system responses set at the factory. Some low-battery alerts and system responses can be changed using Power Options in Windows Control Panel. Preferences set using Power Options do not affect lights.

Identifying low battery levels

When a battery that is the sole power source for the computer reaches a low or critical battery level, the following behavior occurs:

- The battery light (select models only) indicates a low or critical battery level.

 **NOTE:** For additional information about the battery light, refer to the *Getting Started* guide.

– or –

- The power meter icon in the notification area shows a low or critical battery notification.

 **NOTE:** For additional information about the power meter, refer to [Using the power meter on page 24](#).

The computer takes the following actions for a critical battery level:

- If Hibernation is enabled and the computer is on or in the Sleep state, the computer initiates Hibernation.
- If Hibernation is disabled and the computer is on or in the Sleep state, the computer remains briefly in the Sleep state, and then shuts down and loses any unsaved information.

Resolving a low battery level

Resolving a low battery level when external power is available

- ▲ Connect one of the following devices:
 - AC adapter
 - Optional docking or expansion device
 - Optional power adapter purchased as an accessory from HP

Resolving a low battery level when a charged battery is available

1. Turn off the computer or initiate Hibernation.
2. Replace the discharged battery with a charged battery.
3. Turn on the computer.

Resolving a low battery level when no power source is available

- Initiate Hibernation.
- Save your work and shut down the computer.

Resolving a low battery level when the computer cannot exit Hibernation

When the computer lacks sufficient power to exit Hibernation, follow these steps:

1. Replace the discharged battery with a charged battery, or connect the AC adapter to the computer and to external power.
2. Exit Hibernation by pressing the power button.

Conserving battery power

- Select low power-use settings through Power Options in Windows Control Panel.
- Turn off wireless and LAN connections and exit modem applications when you are not using them.
- Disconnect unused external devices that are not plugged into an external power source.
- Stop, disable, or remove any external media cards that you are not using.

- Decrease screen brightness.
- Before you leave your work, initiate Sleep or Hibernation, or shut down the computer.

Storing a battery

⚠ CAUTION: To reduce the risk of damage to a battery, do not expose it to high temperatures for extended periods of time.

If a computer will be unused and unplugged from external power for more than 2 weeks, remove the battery and store it separately.

To prolong the charge of a stored battery, place it in a cool, dry place.

🔧 NOTE: A stored battery should be checked every 6 months. If the capacity is less than 50 percent, recharge the battery before returning it to storage.

Calibrate a battery before using it if it has been stored for one month or more.

Disposing of a used battery

⚠ WARNING! To reduce the risk of fire or burns, do not disassemble, crush, or puncture; do not short external contacts; do not dispose of in fire or water.

Refer to the *Regulatory, Safety and Environmental Notices* for proper battery disposal.

Replacing the battery

In Windows 7, Battery Check in Help and Support notifies you to replace the battery when an internal cell is not charging properly or when the battery storage capacity has reached a weak condition. If the battery is possibly covered by an HP warranty, instructions include a warranty ID. A message refers you to the HP Web site for more information about ordering a replacement battery.

Using external AC power

🔧 NOTE: For information on connecting to AC power, refer to the *Setup Instructions* poster provided in the computer box.

External AC power is supplied through an approved AC adapter or an optional docking or expansion device.

⚠ WARNING! To reduce potential safety issues, use only the AC adapter provided with the computer, a replacement AC adapter provided by HP, or a compatible AC adapter purchased from HP.

Connect the computer to external AC power under any of the following conditions:

⚠ WARNING! Do not charge the computer battery while you are onboard aircraft.

- When charging or calibrating a battery
- When installing or modifying system software
- When writing information to a CD, a DVD, or a BD (select models only)
- When running Disk Defragmenter
- When performing a backup or recovery

When you connect the computer to external AC power, the following events occur:

- The battery begins to charge.
- If the computer is turned on, the power meter icon in the notification area changes appearance.

When you disconnect external AC power, the following events occur:

- The computer switches to battery power.
- The display brightness is automatically decreased to save battery life.

Testing an AC adapter

Test the AC adapter if the computer exhibits any of the following symptoms when it is connected to AC power:

- The computer does not turn on.
- The display does not turn on.
- The power lights are off.

To test the AC adapter:

1. Shut down the computer.
2. Remove the battery from the computer.
3. Connect the AC adapter to the computer, and then plug it into an AC outlet.
4. Turn on the computer.
 - If the power lights turn *on*, the AC adapter is working properly.
 - If the power lights remain *off*, the AC adapter is not functioning and should be replaced.

Contact HP Customer Support for information on obtaining a replacement AC power adapter.

Switching between graphics modes (select models only)

Select computers are equipped with switchable graphics and have two modes for processing graphics. When you switch from AC power to battery power, the computer can switch from using the high-performance mode to using the power-saving mode to conserve battery life. Similarly, when you switch from battery power to AC power, the computer can switch back to the high-performance mode.

 **NOTE:** In some instances, in order to optimize performance of the computer, the system does not allow you to switch modes, or it may prompt you to switch. It may also be necessary to close all programs before switching.

NOTE: HDMI (select models only) only works in the high-performance mode. If you use the power-saving mode, you can not use HDMI.

When you switch between AC and battery power, you are notified that the computer is about to switch graphics modes. If you prefer, you can choose to continue using the same graphics mode. While the computer switches modes, the screen goes blank for a few seconds. When the switch is complete, a notification appears in the notification area, and the screen image reappears.

 **NOTE:** When select computer models are in slate mode, the screen orientation is reset when you switch between graphics modes.

5 External cards and devices

Using Media Card Reader cards (select models only)

Optional digital cards provide secure data storage and convenient data sharing. These cards are often used with digital media–equipped cameras and PDAs as well as with other computers.

To determine the digital card formats that are supported on your computer, refer to the *Getting Started* guide.

Inserting a digital card

⚠ CAUTION: To reduce the risk of damage to the digital card connectors, use minimal force to insert a digital card.

1. Hold the card label-side up, with the connectors facing the computer.
2. Insert the card into the Media Card Reader, and then press in on the card until it is firmly seated.

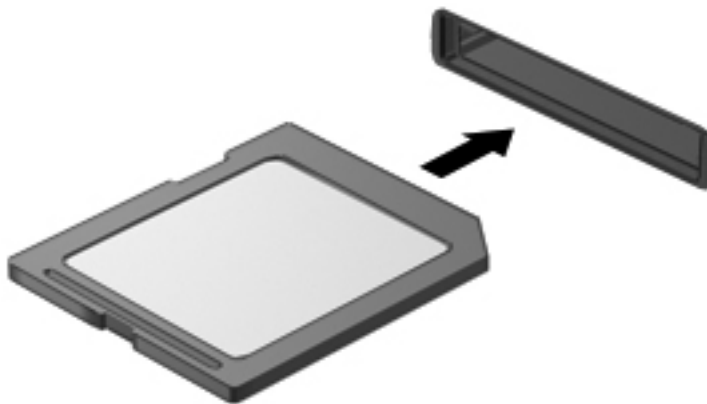

You will hear a sound when the device has been detected, and a menu of options may be displayed.

Removing a digital card

CAUTION: To reduce the risk of loss of data or an unresponsive system, use the following procedure to safely remove the digital card.

1. Save your information and close all programs associated with the digital card.
2. Click the remove hardware icon in the notification area, at the far right of the taskbar. Then follow the on-screen instructions.
3. Either press in on the card **(1)**, and then remove it from the slot **(2)**.

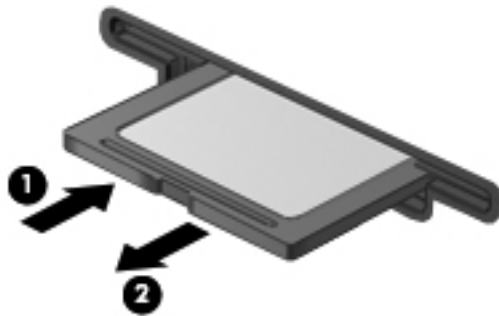

– or –

Pull the card out of the slot.

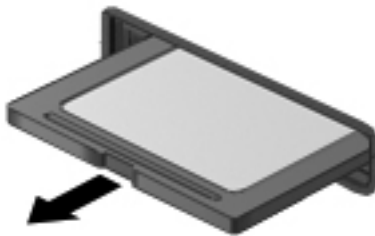

Using PC Cards (select models only)

A PC Card is a credit card-sized accessory designed to conform to the standard specifications of the Personal Computer Memory Card International Association (PCMCIA). The PC Card slot supports the following types of PC Cards:

- 32-bit (CardBus) and 16-bit PC Cards
- Type I and Type II PC Cards

NOTE: Zoomed video PC Cards and 12-V PC Cards are not supported.

Configuring a PC Card

To reduce the risk of loss of support for other PC Cards during configuration, install only the software required for the device. If you are instructed by the PC Card manufacturer to install device drivers:

- Install only the device drivers for your operating system.
- Do not install other software, such as card services, socket services, or enablers, supplied by the PC Card manufacturer.

Inserting a PC Card

CAUTION: To prevent damage to the computer and external media cards, do not insert an ExpressCard into a PC Card slot.

CAUTION: To reduce the risk of damage to the connectors:

Use minimal force when inserting a PC Card.

Do not move or transport the computer when a PC Card is in use.

The PC Card slot may contain a protective insert. The insert must be removed before you can insert a PC Card:

1. Press the PC Card eject button **(1)**.
This action extends the button into position for releasing the insert.
2. Press the PC Card eject button again to release the insert.
3. Pull the insert out of the slot **(2)**.

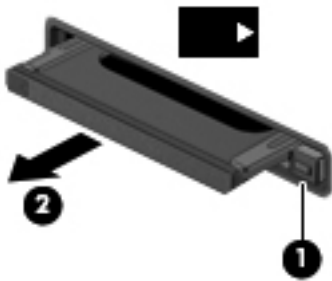

To insert a PC Card:

1. Hold the card label-side up, with the connectors facing the computer.
2. Insert the card into the PC Card slot, and then press in on the card until it is firmly seated.

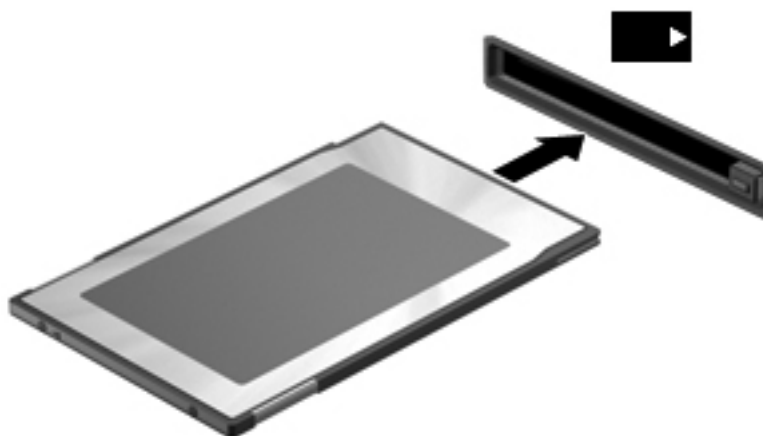

You will hear a sound when the card has been detected, and a menu of available options may be displayed.

NOTE: The first time you connect a PC Card, a message in the notification area lets you know that the device is recognized by the computer.

 **NOTE:** To conserve power, stop or remove a PC Card when it is not in use.

Removing a PC Card

 **CAUTION:** To reduce the risk of loss of data or an unresponsive system, stop a PC Card before removing it.

1. Save your information and close all programs associated with the PC Card.
2. Click the remove hardware icon in the notification area, at the far right of the taskbar, and then follow the on-screen instructions.
3. Release and remove the PC Card:
 - a. Press the PC Card eject button **(1)**.
This action extends the button into position for releasing the PC Card.
 - b. Press the PC Card eject button again to release the PC Card.
 - c. Pull the PC Card **(2)** out of the slot.

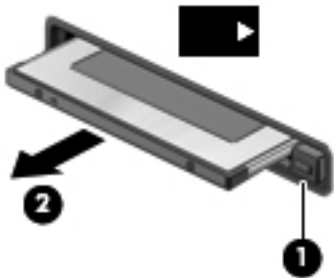

Using ExpressCards (select models only)

An ExpressCard is a high-performance PC Card that is inserted into the ExpressCard slot.

Like standard PC Cards, ExpressCards are designed to conform to the standard specifications of the PCMCIA.

Configuring an ExpressCard

Install only the software required for the card. If you are instructed by the ExpressCard manufacturer to install device drivers:

- Install only the device drivers for your operating system.
- Do not install additional software, such as card services, socket services, or enablers, that are supplied by the ExpressCard manufacturer.

Inserting an ExpressCard

CAUTION: To prevent damage to the computer and external media cards, do not insert a PC Card into an ExpressCard slot.

CAUTION: To reduce the risk of damage to the connectors:

Use minimal force when inserting an ExpressCard.

Do not move or transport the computer when an ExpressCard is in use.

The ExpressCard slot may contain a protective insert. To remove the insert:

1. Press in on the insert **(1)** to unlock it.
2. Pull the insert out of the slot **(2)**.

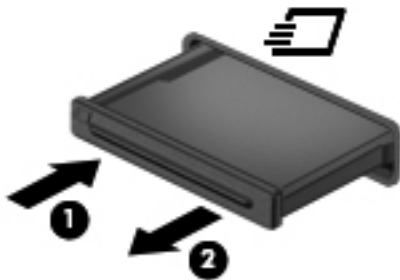

To insert an ExpressCard:

1. Hold the card label-side up, with the connectors facing the computer.
2. Insert the card into the ExpressCard slot, and then press in on the card until it is firmly seated.

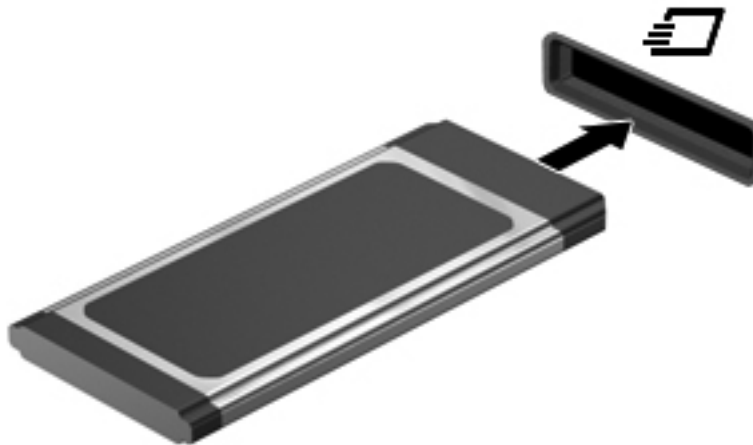

You will hear a sound when the card has been detected, and a menu of options may be displayed.

NOTE: The first time you connect an ExpressCard, a message in the notification area lets you know that the card is recognized by the computer.

NOTE: To conserve power, stop or remove an ExpressCard when it is not in use.

Removing an ExpressCard

CAUTION: To reduce the risk of loss of data or an unresponsive system, use the following procedure to safely remove the ExpressCard.

1. Save your information and close all programs associated with the ExpressCard.
2. Click the remove hardware icon in the notification area, at the far right of the taskbar, and then follow the on-screen instructions.
3. Release and remove the ExpressCard:
 - a. Gently press in on the ExpressCard **(1)** to unlock it.
 - b. Pull the ExpressCard out of the slot **(2)**.

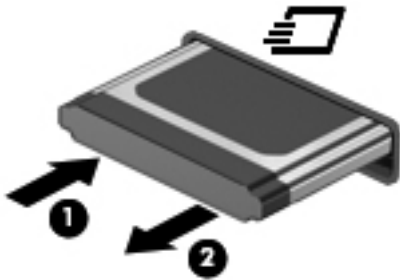

Using smart cards (select models only)

NOTE: The term *smart card* is used throughout this chapter to refer to both smart cards and Java™ Cards.

A smart card is a credit card-sized accessory that carries a microchip containing memory and a microprocessor. Like personal computers, smart cards have an operating system to manage input and output, and they include security features to protect against tampering. Industry-standard smart cards are used with the smart card reader (select models only).

A PIN is needed to gain access to the contents of the microchip. For more information about smart card security features, refer to Help and Support.

Inserting a smart card

1. Hold the card label-side up, and gently slide the card into the smart card reader until the card is seated.

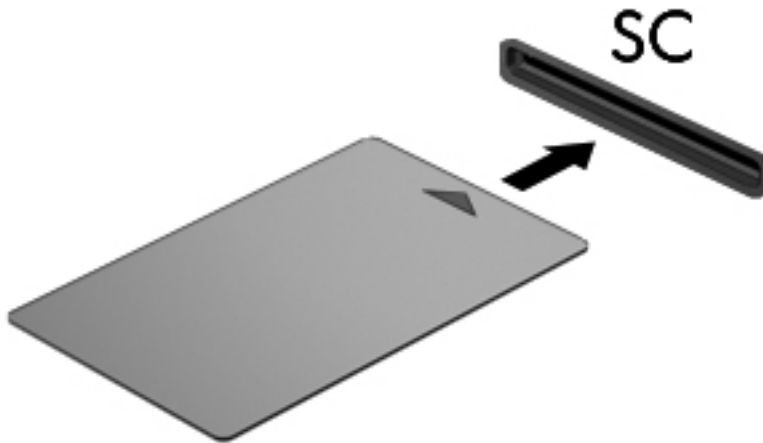

2. Follow the on-screen instructions for logging on to the computer using the smart card PIN.

Removing a smart card

- ▲ Grasp the edge of the smart card, and then pull it out of the smart card reader.



Using a USB device

Universal Serial Bus (USB) is a hardware interface that can be used to connect an optional external device, such as a USB keyboard, mouse, drive, printer, scanner, or hub.

Some USB devices may require additional support software, which is usually included with the device. For more information about device-specific software, refer to the manufacturer's instructions. These instructions may be provided with the software, on disc, or on the manufacturer's Web site.

The computer has at least 1 USB port that supports USB 1.0, 1.1, 2.0, or 3.0 devices. Your computer may also have a powered USB port that provides power to an external device if it is used with a powered USB cable. An optional docking device or USB hub provides additional USB ports that can be used with the computer.

Connecting a USB device

CAUTION: To reduce the risk of damage to a USB connector, use minimal force to connect the device.

- ▲ Connect the USB cable for the device to the USB port.

NOTE: The following illustration may look slightly different on your computer.



You will hear a sound when the device has been detected.

NOTE: The first time you connect a USB device, a message in the notification area lets you know that the device is recognized by the computer.

Removing a USB device

CAUTION: To reduce the risk of damage to a USB connector, do not pull on the cable to remove the USB device.

CAUTION: To reduce the risk of loss of information or an unresponsive system, use the following procedure to safely remove the USB device.

1. To remove a USB device, save your information and close all programs associated with the device.
2. Click the remove hardware icon in the notification area, at the far right of the taskbar, and then follow the on-screen instructions.
3. Remove the device.

Using 1394 devices (select models only)

IEEE 1394 is a hardware interface that connects a high-speed multimedia or data storage device to the computer. Scanners, digital cameras, and digital camcorders often require a 1394 connection.

Some 1394 devices may require additional support software, which is usually included with the device. For more information about device-specific software, refer to the manufacturer's instructions.

The 1394 port also supports IEEE 1394a devices.

Connecting a 1394 device

CAUTION: To reduce the risk of damage to a 1394 port connector, use minimal force to connect the device.

- ▲ To connect a 1394 device to the computer, connect the 1394 cable for the device to the 1394 port.

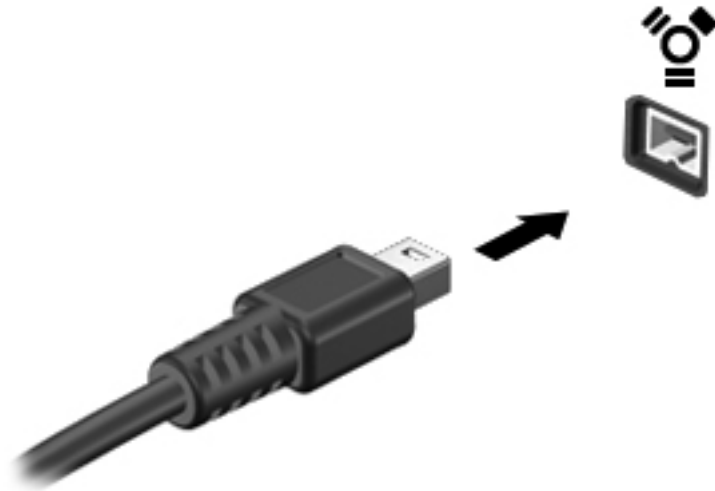

You will hear a sound when the device has been detected.

Removing a 1394 device

CAUTION: To reduce the risk of loss of information or an unresponsive system, stop the 1394 device before removing it.

CAUTION: To reduce the risk of damage to a 1394 connector, do not pull on the cable to remove the 1394 device.

1. To remove a 1394 device, save your information and close all programs associated with the device.
2. Click the remove hardware icon in the notification area, at the far right of the taskbar, and then follow the on-screen instructions.
3. Remove the device.

Using an eSATA device (select models only)

An eSATA port connects an optional high-performance eSATA component, such as an eSATA external hard drive.

Some eSATA devices may require additional support software, which is usually included with the device. For more information about device-specific software, refer to the manufacturer's instructions.

NOTE: The eSATA port also supports an optional USB device.

Connecting an eSATA device

⚠ CAUTION: To reduce the risk of damage to an eSATA port connector, use minimal force to connect the device.

- ▲ To connect an eSATA device to the computer, connect the eSATA cable for the device to the eSATA port.

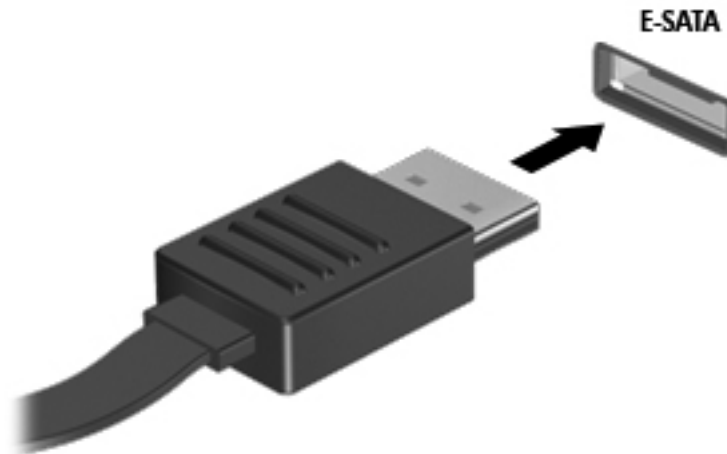

You will hear a sound when the device has been detected.

Removing an eSATA device

⚠ CAUTION: To reduce the risk of damage to an eSATA connector, do not pull on the cable to remove the eSATA device.

CAUTION: To reduce the risk of loss of information or an unresponsive system, use the following procedure to safely remove the device.

1. To remove an eSATA device, save your information and close all programs associated with the device.
2. Click the remove hardware icon in the notification area, at the far right of the taskbar, and then follow the on-screen instructions.
3. Remove the device.

Using a serial device (select models only)

Select computer models include a serial port that connects optional devices such as a serial modem, mouse, or printer.

Some serial devices may require additional support software, which is usually included with the device. For more information about device-specific software, refer to the manufacturer's instructions.

- ▲ To connect a serial device, connect the device cable to the serial port on the computer.

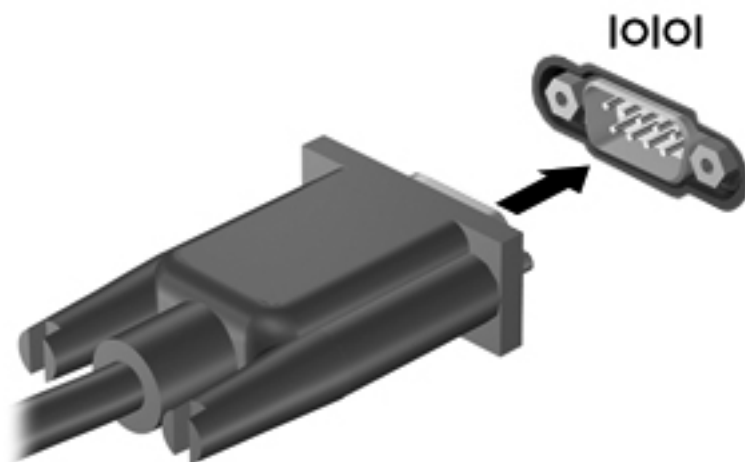

Using optional external devices

 **NOTE:** For more information about required software and drivers, or to learn which computer port to use, refer to the manufacturer's instructions.

To connect an external device to the computer:

 **CAUTION:** To reduce the risk of damage to the equipment when connecting a powered device, be sure that the device is turned off and the AC power cord is unplugged.

1. Connect the device to the computer.
2. If you are connecting a powered device, plug the device power cord into a grounded AC outlet.
3. Turn on the device.

To disconnect an unpowered external device, turn off the device, and then disconnect it from the computer. To disconnect a powered external device, turn off the device, disconnect it from the computer, and then unplug the AC power cord.

Using optional external drives

Removable external drives expand your options for storing and accessing information. A USB drive can be added by connecting the drive to a USB port on the computer.

 **NOTE:** HP external USB optical drives should be connected to the powered USB port on the computer.

USB drives include the following types:

- 1.44-megabyte diskette drive
- Hard drive module
- External optical drive (CD, DVD, and Blu-ray)
- MultiBay device

Using the expansion port (select models only)

The expansion port connects the computer to an optional docking or expansion device, so that additional ports and connectors can be used with the computer.

 **NOTE:** The computer has only one expansion port.



Using the docking connector (select models only)

The docking connector connects the computer to an optional docking device. An optional docking device provides additional ports and connectors that can be used with the computer.

 **NOTE:** The following image may look slightly different than your computer or docking device.

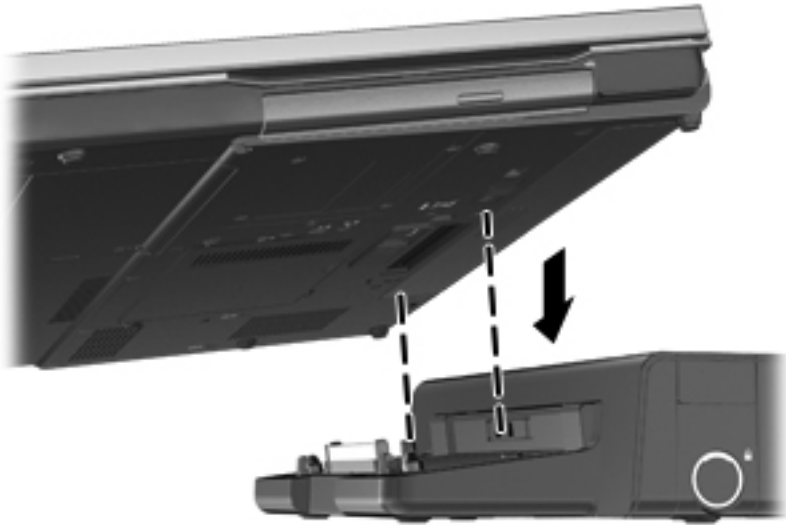

6 Drives

Handling drives

Drives are fragile computer components that must be handled with care. Refer to the following cautions before handling drives. Additional cautions are included with the procedures to which they apply.

Observe these precautions:

- Before you move a computer that is connected to an external hard drive, initiate Sleep and allow the screen to clear, or properly disconnect the external hard drive.
- Before handling a drive, discharge static electricity by touching the unpainted metal surface of the drive.
- Do not touch the connector pins on a removable drive or on the computer.
- Handle a drive carefully; do not drop a drive or place items on it.
- Before removing or inserting a drive, shut down the computer. If you are unsure whether the computer is off, in the Sleep state, or in Hibernation, turn the computer on, and then shut it down through the operating system.
- Do not use excessive force when inserting a drive into a drive bay.
- Do not type on the keyboard or move the computer while an optical drive is writing to a disc. The write process is sensitive to vibration.
- When the battery is the only source of power, be sure that the battery is sufficiently charged before writing to media.
- Avoid exposing a drive to temperature or humidity extremes.
- Avoid exposing a drive to liquids. Do not spray the drive with cleaning products.
- Remove media from a drive before removing the drive from the drive bay, or traveling with, shipping, or storing a drive.
- If a drive must be mailed, place the drive in a bubble-pack mailer or other suitable protective packaging and label the package "FRAGILE."
- Avoid exposing a drive to magnetic fields. Security devices with magnetic fields include airport walk-through devices and security wands. Airport conveyer belts and similar security devices that check carry-on baggage use X-rays instead of magnetism and do not damage drives.

Using hard drives

Improving hard drive performance

Using Disk Defragmenter

As you use the computer, files on the hard drive become fragmented. Disk Defragmenter consolidates the fragmented files and folders on the hard drive so that the system can run more efficiently.

 **NOTE:** It is not necessary to run Disk Defragmenter on solid-state drives.

After you start Disk Defragmenter, it works without supervision. Depending on the size of your hard drive and the number of fragmented files, Disk Defragmenter may take more than an hour to complete. You may want to set it to run during the night or at another time when you do not need access to your computer.

HP recommends defragmenting your hard drive at least once a month. You may set Disk Defragmenter to run on a monthly schedule, but you can defragment your computer manually at any time.

To run Disk Defragmenter:

1. Connect the computer to AC power.
2. Select **Start > All Programs > Accessories > System Tools > Disk Defragmenter**.
3. **Windows 7**—Click **Defragment disk**.

 **NOTE:** Windows includes the User Account Control feature to improve the security of your computer. You may be prompted for your permission or password for tasks such as installing software, running utilities, or changing Windows settings. Refer to Help and Support for more information.

Windows Vista—Click **Defragment now**.

 **NOTE:** Windows includes the User Account Control feature to improve the security of your computer. You may be prompted for your permission or password for tasks such as installing software, running utilities, or changing Windows settings. Refer to Help and Support for more information.

For additional information, access the Disk Defragmenter software Help.

Using Disk Cleanup

Disk Cleanup searches the hard drive for unnecessary files that you can safely delete to free up disk space and help the computer to run more efficiently.

To run Disk Cleanup:

1. Select **Start > All Programs > Accessories > System Tools > Disk Cleanup**.
2. Follow the on-screen instructions.

Using HP 3D DriveGuard (select models only)

HP 3D DriveGuard protects the hard drive by parking the drive and halting data requests under either of the following conditions:

- You drop the computer.
- You move the computer with the display closed while the computer is running on battery power.

A short time after the end of one of these events, HP 3D DriveGuard returns the hard drive to normal operation.

 **NOTE:** Because solid-state drives (SSD) lack moving parts, HP 3D DriveGuard is unnecessary.

NOTE: Hard drives in the primary hard drive bay or in the secondary hard drive bay are protected by HP 3D DriveGuard. Hard drives installed in optional docking devices or connected to USB ports are not protected by HP 3D DriveGuard.

For more information, refer to the HP 3D DriveGuard software Help.

Identifying HP 3D DriveGuard status

The drive light on the computer changes color to show that a drive in the primary hard drive bay or a drive in the secondary hard drive bay (select models only) is parked. To determine whether drives are currently protected or whether a drive is parked, use the icon in the notification area, at the far right of the taskbar:

- If the software is enabled, a green check mark is superimposed over the hard drive icon.
- If the software is disabled, a red X is superimposed over the hard drive icon.
- If the drives are parked, a yellow moon is superimposed over the hard drive icon.

If the icon in the notification area is not enabled, follow these steps to enable it:

1. Select **Start > Control Panel > Hardware and Sound > HP 3D DriveGuard**.

 **NOTE:** If prompted by User Account Control, click **Yes**.

2. On the **Icon in system tray** row, click **Show**.
3. Click **OK**.

Managing power with a parked hard drive

If HP 3D DriveGuard has parked the drive, the computer will behave in the following ways:

- The computer will not shut down.
- The computer will not initiate Sleep or Hibernation, except as described in the following note.

 **NOTE:** If the computer is running on battery power and reaches a critical battery level, HP 3D DriveGuard allows the computer to initiate Hibernation.

- The computer will not activate battery alarms set on the Alarms tab in Power Options.

Before you move the computer, HP recommends that you either shut it down or initiate Sleep or Hibernation.

Using HP 3D DriveGuard software

The HP 3D DriveGuard software enables you to perform the following tasks:

- Enable and disable HP 3D DriveGuard.

 **NOTE:** Depending on your user privileges, you may be unable to enable or disable HP 3D DriveGuard. Privileges for non-administrator users can be changed by members of an administrator group.

- Determine whether a drive in the system is supported.

To open the software and change settings, follow these steps:

1. Double-click the icon in the notification area, at the far right of the taskbar.

– or –

Right-click the icon in the notification area, and then select **Settings**.

2. Click the appropriate button to change settings.
3. Click **OK**.

Using optical drives (select models only)

Optical drives include the following:

- CD
- DVD
- Blu-ray (BD)

Identifying the installed optical drive

- ▲ Select **Start > Computer**.

A list of all the devices installed in your computer, including your optical drive, is displayed.

Inserting an optical disc

Tray load

1. Turn on the computer.
2. Press the release button **(1)** on the drive bezel to release the disc tray.
3. Pull out the tray **(2)**.
4. Hold the disc by the edges to avoid touching the flat surfaces and position the disc label-side up over the tray spindle.

 **NOTE:** If the tray is not fully accessible, tilt the disc carefully to position it over the spindle.

5. Gently press the disc **(3)** down onto the tray spindle until the disc snaps into place.

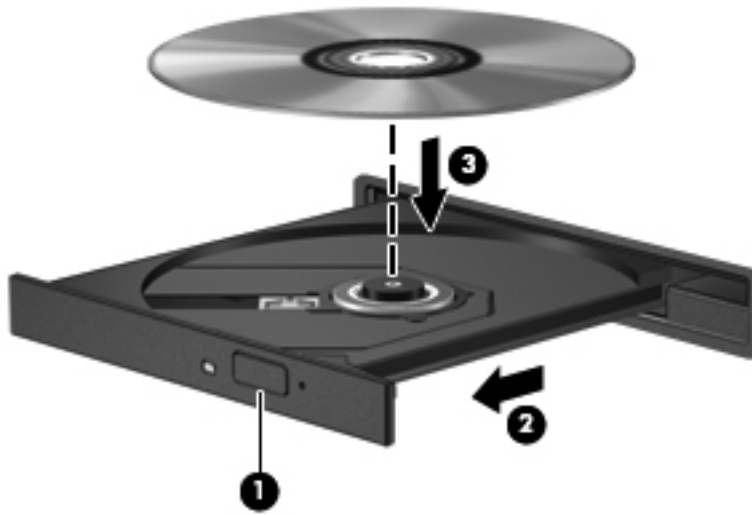

6. Close the disc tray.

 **NOTE:** After you insert a disc, a short pause is normal. If you have not selected a media player, an AutoPlay dialog box opens. It prompts you to select how you want to use the media content.

Slot load

 **CAUTION:** Do not insert **8-cm** optical discs into a slot load optical drive. It may cause damage to the optical drive.

1. Turn on the computer.
2. Hold the disc by the edges to avoid touching the flat surfaces and position the disc label-side up.
3. Gently slide the disc into the slot load optical drive.



Removing an optical disc

Tray load

There are 2 ways to remove a disc, depending on whether the disc tray opens normally or not.

When the disc tray opens normally

1. Press the release button **(1)** on the drive bezel to release the disc tray, and then gently pull out the tray **(2)** until it stops.
2. Remove the disc **(3)** from the tray by gently pressing down on the spindle while lifting the outer edges of the disc. Hold the disc by the edges and avoid touching the flat surfaces.

 **NOTE:** If the tray is not fully accessible, tilt the disc carefully as you remove it.

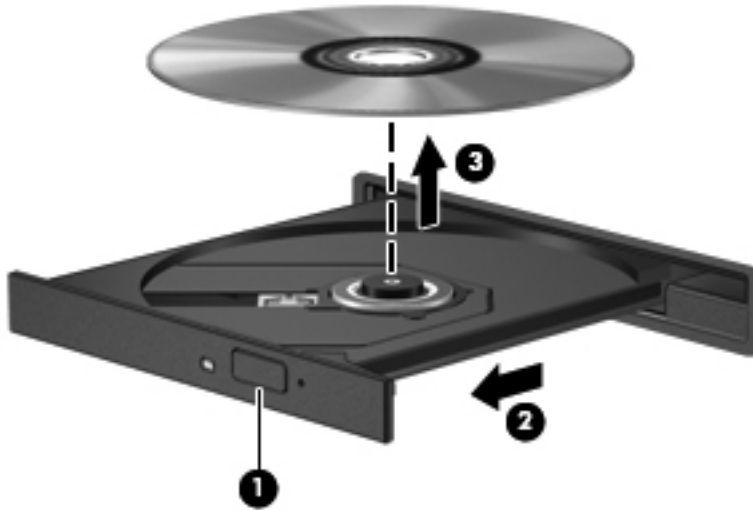

3. Close the disc tray and place the disc in a protective case.

When the disc tray fails to open normally

1. Insert the end of a paper clip **(1)** into the release access in the front bezel of the drive.
2. Press in gently on the paper clip until the tray is released, and then pull out the tray **(2)** until it stops.

3. Remove the disc **(3)** from the tray by gently pressing down on the spindle while lifting the outer edges of the disc. Hold the disc by the edges and avoid touching the flat surfaces.

 **NOTE:** If the tray is not fully accessible, tilt the disc carefully as you remove it.

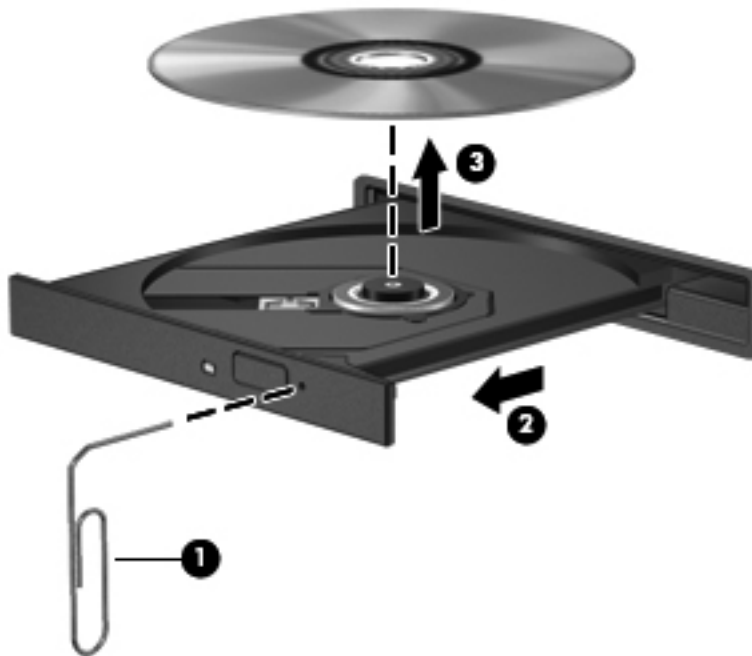

4. Close the disc tray and place the disc in a protective case.

Slot load

1. Press the release button **(1)** next to the drive.
2. Remove the disc **(2)** by holding it by the edges and avoid touching the flat surfaces.



3. Place the disc in a protective case.

Sharing optical drives

Although your computer may not have an integrated optical drive, you can access software and data, and install applications, by sharing an optical drive connected to another computer in your network. Sharing drives is a feature of the Windows operating system that allows a drive on one computer to be accessible to other computers on the same network.

 **NOTE:** You must have a network set up in order to share an optical drive; refer to [Networking \(select models only\) on page 2](#) for additional information on setting up a network.

NOTE: Some discs, such as DVD movies and game discs, may be copy-protected and therefore unusable through DVD or CD drive sharing.

To share an optical drive:

1. From the computer with the optical drive you are sharing, select **Start > Computer**.
2. Right-click the optical drive you want to share, and click **Properties**.
3. Click the Sharing tab, and then click **Advanced Sharing**.
4. Select the **Share this folder** check box.
5. Type a name for the optical drive in the Share name text box.
6. Click **Apply**, and then click **OK**.
7. To view the shared optical drive, select **Start > Control Panel > Network and Internet > Network and Sharing Center**.

Using RAID (select models only)

Redundant Arrays of Independent Disks (RAID) technology allows a computer to use two or more hard disks at the same time. RAID treats multiple drives as one contiguous drive, either through hardware or software settings. If multiple disks are set up to work together in this fashion, they are referred to as a RAID array.

For additional information about RAID, refer to the *RAID User Guide* located in Help and Support or refer to the HP Web site at <http://www.hp.com/support>.

7 Security

Protecting the computer

Standard security features provided by the Windows operating system and the non-Windows Computer Setup can protect your personal settings and data from a variety of risks.

 **NOTE:** Security solutions are designed to act as deterrents. These deterrents may not prevent a product from being mishandled or stolen.

NOTE: Before you send your computer for service, back up and delete confidential files, and remove all password settings.

NOTE: Some features listed in this chapter may not be available on your computer.

NOTE: Your computer supports CompuTrace, which is an online security-based tracking and recovery service available in select regions. If the computer is stolen, CompuTrace can track the computer if the unauthorized user accesses the Internet. You must purchase the software and subscribe to the service in order to use CompuTrace. For information about ordering the CompuTrace software, go to the HP Web site at <http://www.hpshopping.com>.

| Computer risk | Security feature |
|--|--|
| Unauthorized use of the computer | HP ProtectTools Security Manager, in combination with a password, smart card, and/or fingerprint reader. |
| Unauthorized access to Computer Setup (f10) | BIOS administrator password in Computer Setup* |
| Unauthorized access to the contents of a hard drive | DriveLock password in Computer Setup* |
| Unauthorized startup from an optical drive, diskette drive, or internal network adapter | Boot options feature in Computer Setup* |
| Unauthorized access to a Windows user account | HP ProtectTools Security Manager |
| Unauthorized access to data | <ul style="list-style-type: none">• Firewall software• Windows updates• Drive Encryption for HP ProtectTools |
| Unauthorized access to Computer Setup settings and other system identification information | BIOS administrator password in Computer Setup* |
| Unauthorized removal of the computer | Security cable slot (used with an optional security cable) |

*Computer Setup is a preinstalled, ROM-based utility that can be used even when the operating system is not working or will not load. You can use either a pointing device (TouchPad, pointing stick, or USB mouse) or the keyboard to navigate and make selections in Computer Setup.

Using passwords

A password is a group of characters that you choose to secure your computer information. Several types of passwords can be set, depending on how you want to control access to your information. Passwords can be set in Windows or in non-Windows Computer Setup that is preinstalled on the computer.

- Setup and DriveLock passwords are set in Computer Setup and are managed by the system BIOS.
- The embedded security password, which is an HP ProtectTools Security Manager password, can be enabled in Computer Setup to provide BIOS password protection in addition to their normal HP ProtectTools functions. The embedded security password is used with the optional embedded security chip.
- Windows passwords are set only in the Windows operating system.
- If you forget the BIOS administrator password set in Computer Setup, you can use HP SpareKey to access the utility.
- If you forget both the DriveLock user password and the DriveLock master password set in Computer Setup, the hard drive that is protected by the passwords is permanently locked and can no longer be used.

You can use the same password for a Computer Setup feature and for a Windows security feature. You can also use the same password for more than one Computer Setup feature.

Use the following tips for creating and saving passwords:

- When creating passwords, follow requirements set by the program.
- Write down your passwords and store them in a secure place away from the computer.
- Do not store passwords in a file on the computer.

The following tables list commonly used Windows and BIOS administrator passwords and describe their functions.

Setting passwords in Windows

| Password | Function |
|-------------------------|---|
| Administrator password* | Protects access to a Windows administrator-level account. NOTE: This password cannot be used to access Computer Setup contents. |
| User password* | Protects access to a Windows user account. |

*For information about setting a Windows administrator password or a Windows user password, select **Start > Help and Support**.

Setting passwords in Computer Setup

| Password | Function |
|--------------------------------|---|
| BIOS administrator password* | Protects access to Computer Setup. |
| DriveLock master password* | Protects access to the internal hard drive that is protected by DriveLock. It is also used to remove DriveLock protection. This password is set under DriveLock Passwords during the enable process. |
| DriveLock user password* | Protects access to the internal hard drive that is protected by DriveLock, and is set under DriveLock Passwords during the enable process. |
| TPM embedded security password | When enabled as a BIOS administrator password, protects access to the computer contents when the computer turns on, restarts, or exits Hibernation. This password requires the optional embedded security chip to support this security feature. |

*For details about each of these passwords, refer to the following topics.

Managing a BIOS administrator password

To set, change, or delete this password, follow these steps:

Setting a new BIOS administrator password

1. Turn on or restart the computer, and then press **esc** while the “Press the ESC key for Startup Menu” message is displayed at the bottom of the screen.
2. Press **f10** to enter Computer Setup.
3. Use a pointing device or the arrow keys to select **Security > Setup BIOS Administrator Password**, and then press **enter**.
4. When prompted, type a password.
5. When prompted, type the new password again to confirm.
6. To save your changes and exit Computer Setup, click the **Save** icon in the lower-left corner of the screen, and then follow the on-screen instructions.

– or –

Use the arrow keys to select **File > Save Changes and Exit**, and then press **enter**.

Your changes go into effect when the computer restarts.

Changing a BIOS administrator password

1. Turn on or restart the computer, and then press **esc** while the “Press the ESC key for Startup Menu” message is displayed at the bottom of the screen.
2. Press **f10** to enter Computer Setup.
3. Use a pointing device or the arrow keys to select **Security > Change Password**, and then press **enter**.

4. When prompted, type your current password.
5. When prompted, type your new password again to confirm.
6. To save your changes and exit Computer Setup, click the **Save** icon in the lower-left corner of the screen, and then follow the on-screen instructions.

– or –

Use the arrow keys to select **File > Save Changes and Exit**, and then press [enter](#).

Your changes go into effect when the computer restarts.

Deleting a BIOS administrator password

1. Turn on or restart the computer, and then press [esc](#) while the “Press the ESC key for Startup Menu” message is displayed at the bottom of the screen.
2. Press [f10](#) to enter Computer Setup.
3. Use a pointing device or the arrow keys to select **Security > Change Password**, and then press [enter](#).
4. When prompted, type your current password.
5. When prompted for the new password, leave the field empty, and then press [enter](#).
6. Read the warning. To continue, select **YES**.
7. When prompted to type your new password again, leave the field empty, and then press [enter](#).
8. To save your changes and exit Computer Setup, click the **Save** icon in the lower-left corner of the screen, and then follow the on-screen instructions.

– or –

Use the arrow keys to select **File > Save Changes and Exit**, and then press [enter](#).

Your changes go into effect when the computer restarts.

Entering a BIOS administrator password

At the **BIOS administrator password** prompt, type your password (using the same kind of keys you used to set the password), and then press [enter](#). After 3 unsuccessful attempts to enter the BIOS administrator password, you must restart the computer and try again.

Managing a Computer Setup DriveLock password

 **CAUTION:** To prevent the DriveLock-protected hard drive from becoming permanently unusable, record the DriveLock user password and the DriveLock master password in a safe place away from your computer. If you forget both DriveLock passwords, the hard drive will be permanently locked and can no longer be used.

DriveLock protection prevents unauthorized access to the contents of a hard drive. DriveLock can be applied only to the internal hard drive(s) of the computer. After DriveLock protection is applied to a drive, a password must be entered to access the drive. The drive must be inserted into the computer or an advanced port replicator in order for it to be accessed by the DriveLock passwords.

To apply DriveLock protection to an internal hard drive, a user password and a master password must be set in Computer Setup. Note the following considerations about using DriveLock protection:

- After DriveLock protection is applied to a hard drive, the hard drive can be accessed only by entering either the user password or the master password.
- The owner of the user password should be the day-to-day user of the protected hard drive. The owner of the master password may be either a system administrator or the day-to-day user.
- The user password and the master password can be identical.
- You can delete a user password or master password only by removing DriveLock protection from the drive. DriveLock protection can be removed from the drive only with the master password.

Setting a DriveLock password

To set a DriveLock password in Computer Setup, follow these steps:

1. Turn on the computer, and then press **esc** while the “Press the ESC key for Startup Menu” message is displayed at the bottom of the screen.
2. Press **f10** to enter Computer Setup.
3. Use a pointing device or the arrow keys to select **Security > DriveLock Passwords**, and then press **enter**.
4. Use a pointing device to click the hard drive you want to protect.
– or –
Use the arrow keys to select the hard drive you want to protect, and then press **enter**.
5. Read the warning. To continue, select **YES**.
6. When prompted, type a master password, and then press **enter**.
7. When prompted, type the master password again to confirm, and then press **enter**.
8. When prompted, type a user password, and then press **enter**.
9. When prompted, type the user password again to confirm, and then press **enter**.
10. To confirm DriveLock protection on the drive you have selected, type DriveLock in the confirmation field, and then press **enter**.

 **NOTE:** The DriveLock confirmation is case sensitive.

11. To save your changes and exit Computer Setup, click the **Save** icon in the lower-left corner of the screen, and then follow the on-screen instructions.

– or –

Use the arrow keys to select **File > Save Changes and Exit**, and then press **enter**.

Your changes go into effect when the computer restarts.

Entering a DriveLock password

Be sure that the hard drive is inserted into the computer (not into an optional docking device or external MultiBay).

At the DriveLock Password prompt, type your user or master password (using the same kind of keys you used to set the password), and then press [enter](#).

After 2 incorrect attempts to enter the password, you must shut down the computer and try again.

Changing a DriveLock password

To change a DriveLock password in Computer Setup, follow these steps:

1. Turn on the computer, and then press [esc](#) while the “Press the ESC key for Startup Menu” message is displayed at the bottom of the screen.
2. Press [f10](#) to enter Computer Setup.
3. Use a pointing device or the arrow keys to select **Security > DriveLock Password**, and then press [enter](#).
4. Use a pointing device to select an internal hard drive.

– or –

Use the arrow keys to select an internal hard drive, and then press [enter](#).

5. Use a pointing device or the arrow keys to select the password you want to change.
6. When prompted, type your current password, and then press [enter](#).
7. When prompted, type a new password, and then press [enter](#).
8. When prompted, type the new password again to confirm, and then press [enter](#).
9. To save your changes and exit Computer Setup, click the **Save** icon in the lower-left corner of the screen, and then follow the on-screen instructions.

– or –

Use the arrow keys to select **File > Save Changes and Exit**, and then press [enter](#).

Your changes go into effect when the computer restarts.

Removing DriveLock protection

To remove DriveLock protection in Computer Setup, follow these steps:

1. Turn on the computer, and then press [esc](#) while the “Press the ESC key for Startup Menu” message is displayed at the bottom of the screen.
2. Press [f10](#) to enter Computer Setup.
3. Use a pointing device or the arrow keys to select **Security > DriveLock Password**, and then press [enter](#).
4. Use a pointing device or the arrow keys to select an internal hard drive, and then press [enter](#).
5. Use a pointing device or the arrow keys to select **Disable protection**.

6. Type your master password, and then press [enter](#).
7. To save your changes and exit Computer Setup, click the **Save** icon in the lower-left corner of the screen, and then follow the on-screen instructions.

– or –

Use the arrow keys to select **File > Save Changes and Exit**, and then press [enter](#).

Your changes go into effect when the computer restarts.

Using Computer Setup Auto DriveLock

In a multiple-user environment, you can set an Automatic DriveLock password. When the Automatic DriveLock password is enabled, a random user password and a DriveLock master password will be created for you. When any user passes the password credential, the same random user and DriveLock master password will be used to unlock the drive.

 **NOTE:** You must have a BIOS administrator password before you can access the Automatic DriveLock features.

Entering an Automatic DriveLock password

To enable an Automatic DriveLock password in Computer Setup, follow these steps:

1. Turn on or restart the computer, and then press [esc](#) while the “Press the ESC key for Startup Menu” message is displayed at the bottom of the screen.
2. Press [f10](#) to enter Computer Setup.
3. Use a pointing device or the arrow keys to select **Security > Automatic DriveLock**, and then press [enter](#).
4. Use a pointing device or the arrow keys to select an internal hard drive, and then press [enter](#).
5. Read the warning. To continue, select **YES**.
6. To save your changes and exit Computer Setup, click the **Save** icon in the lower-left corner of the screen, and then follow the on-screen instructions.

– or –

Use the arrow keys to select **File > Save Changes and Exit**, and then press [enter](#).

Removing Automatic DriveLock protection

To remove DriveLock protection in Computer Setup, follow these steps:

1. Turn on or restart the computer, and then press [esc](#) while the “Press the ESC key for Startup Menu” message is displayed at the bottom of the screen.
2. Press [f10](#) to enter Computer Setup.
3. Use a pointing device or the arrow keys to select **Security > Automatic DriveLock**, and then press [enter](#).
4. Use a pointing device or the arrow keys to select an internal hard drive, and then press [enter](#).

5. Use a pointing device or the arrow keys to select **Disable protection**.
6. To save your changes and exit Computer Setup, click the **Save** icon in the lower-left corner of the screen, and then follow the on-screen instructions.

– or –

Use the arrow keys to select **File > Save Changes and Exit**, and then press [enter](#).

Using antivirus software

When you use the computer to access e-mail, a network, or the Internet, you potentially expose it to computer viruses. Computer viruses can disable the operating system, programs, or utilities, or cause them to function abnormally.

Antivirus software can detect most viruses, destroy them, and, in most cases, repair any damage they have caused. To provide ongoing protection against newly discovered viruses, antivirus software must be kept up to date.

An antivirus program may be preinstalled on your computer and may include a trial offer. It is strongly recommended that you upgrade the trial offer or purchase the antivirus program of your choice in order to fully protect your computer.

For more information about computer viruses, type `viruses` in the Search box in Help and Support.

Using firewall software

Firewalls are designed to prevent unauthorized access to a system or network. A firewall can be a software program you install on your computer and/or network, or it can be a solution made up of both hardware and software.

There are two types of firewalls to consider:

- Host-based firewalls—Software that protects only the computer it is installed on.
- Network-based firewalls—Installed between your DSL or cable modem and your home network to protect all the computers on the network.

When a firewall is installed on a system, all data sent to and from the system is monitored and compared with a set of user-defined security criteria. Any data that does not meet those criteria is blocked.

Your computer or networking equipment may already have a firewall installed. If not, firewall software solutions are available.

 **NOTE:** Under some circumstances a firewall can block access to Internet games, interfere with printer or file sharing on a network, or block authorized e-mail attachments. To temporarily resolve the problem, disable the firewall, perform the task that you want to perform, and then reenable the firewall. To permanently resolve the problem, reconfigure the firewall.

Installing critical security updates

 **CAUTION:** Microsoft sends out alerts regarding critical updates. To protect the computer from security breaches and computer viruses, install all critical updates from Microsoft as soon as you receive an alert.

Updates to the operating system and other software may have become available after the computer left the factory. To be sure that all available updates are installed on the computer, observe these guidelines:

- Run Windows Update as soon as possible after you set up your computer.
- Run Windows Update monthly thereafter.
- Obtain updates to Windows and other Microsoft programs, as they are released, from the Microsoft Web site and through the updates link in Help and Support.

Using HP ProtectTools Security Manager (select models only)

HP ProtectTools Security Manager software is preinstalled on select computer models. This software can be accessed through Windows Control Panel. It provides security features that help protect against unauthorized access to the computer, networks, and critical data. For more information, refer to the HP ProtectTools online Help.

Installing an optional security cable

 **NOTE:** A security cable is designed to act as a deterrent, but it may not prevent the computer from being mishandled or stolen.

NOTE: The security cable slot on your computer may look slightly different from the illustration in this section. Refer to the *Getting Started* guide for the location of the security cable slot on your computer.

1. Loop the security cable around a secured object.
2. Insert the key (1) into the cable lock (2).
3. Insert the cable lock into the security cable slot on the computer (3), and then lock the cable lock with the key.

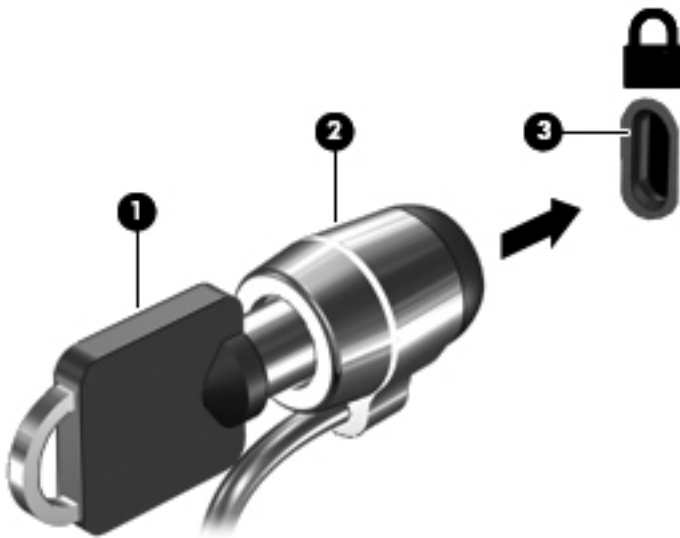

Using the fingerprint reader (select models only)

Integrated fingerprint readers are available on select computer models. In order to use the fingerprint reader, you must set up a user account with a password on the computer. This account allows you to log on to your computer with a swipe of a designated finger. You may also use the fingerprint reader to fill in password fields on Web sites and other programs that require a logon. Refer to the fingerprint software Help for instructions.

After you create your fingerprint identity, you can set up a Single Sign On service that allows you to use your fingerprint scanner to create credentials for any application that requires a user name and password.

Locating the fingerprint reader

The fingerprint reader is a small metallic sensor that is located in one of the following areas of your computer:

- Near the bottom of the TouchPad
- On the right side of the keyboard
- On the upper-right side of the display
- On the left side of the display

Depending on your computer model, the fingerprint reader may be oriented horizontally or vertically. Both orientations require that you swipe your finger perpendicular to the metallic sensor. Refer to the *Getting Started* guide for the location of the fingerprint reader on your computer.

8 Maintenance

Cleaning your computer

Cleaning products

Use the following products to safely clean and disinfect your notebook or tablet PC:

- Dimethyl benzyl ammonium chloride 0.3 percent maximum concentration (For example: germicidal disposable wipes. These wipes come in a variety of brand names.)
- Alcohol-free glass cleaning fluid
- Water with mild soap solution
- Dry microfiber cleaning cloth or a chamois (static-free cloth without oil)
- Static-free cloth wipes

⚠ CAUTION: Avoid the following cleaning products:

Strong solvents, such as alcohol, acetone, ammonium chloride, methylene chloride, and hydrocarbons, which can permanently damage the surface of the notebook or the tablet PC.

Fibrous materials, such as paper towels, which can scratch the notebook or tablet PC. Over time, dirt particles and cleaning agents can get trapped in the scratches.

Cleaning procedures

Follow the procedures in this section to safely clean your notebook or tablet PC.

⚠ WARNING! To prevent electric shock or damage to components, do not attempt to clean your notebook or tablet PC while it is turned on:

Turn off the notebook or tablet PC.

Disconnect external power.

Disconnect all powered external devices.

⚠ CAUTION: Do not spray cleaning agents or liquids directly on any notebook or tablet PC surface. Liquids dripped on the surface can permanently damage internal components.

Cleaning the display

Gently wipe the display using a soft, lint-free cloth moistened with an *alcohol-free* glass cleaner. Be sure that the display is dry before closing the display.

Cleaning the sides and cover

To clean and disinfect the sides and cover, use a soft microfiber cloth or chamois moistened with one of the cleaning solutions listed previously or use an acceptable germicidal disposable wipe.

🔧 NOTE: When cleaning the cover of the notebook, use a circular motion to aid in removing dirt and debris.

Cleaning the TouchPad and keyboard

⚠ CAUTION: When cleaning the TouchPad and keyboard, do not let liquids drip between the keys. This can permanently damage internal components.

- To clean and disinfect the TouchPad and keyboard, use a soft microfiber cloth or chamois moistened with one of the cleaning solutions listed previously or use an acceptable germicidal disposable wipe.
- To prevent keys from sticking and to remove dust, lint, and particles from the keyboard, use a can of compressed air with a straw extension.

⚠ WARNING! To reduce the risk of electric shock or damage to internal components, do not use a vacuum cleaner attachment to clean the keyboard. A vacuum cleaner can deposit household debris on the keyboard surface.

Cleaning a tablet PC pen and pen holder

Using one of the cleaning solutions listed previously, moisten a soft microfiber cloth or chamois or use an acceptable germicidal disposable wipe:

- To clean the pen, rub the pen in an up and down motion to aid in removing dirt and debris.
- To clean the pen holder, use a rotating motion around the opening of the pen holder.

⚠ CAUTION: Do not put any fluid or material other than the pen in the pen holder. The pen holder is not sealed off from some of the internal electronics of the tablet PC.

Updating programs and drivers

HP recommends that you update your programs and drivers on a regular basis with the latest versions. Go to <http://www.hp.com/support> to download the latest versions. You can also register to receive automatic update notifications when they become available.

Using SoftPaq Download Manager

HP SoftPaq Download Manager (SDM) is a tool that provides quick access to SoftPaq information for HP business computers without requiring the SoftPaq number. Using this tool, you can easily search for SoftPaqs, and then download and unpack them.

SoftPaq Download Manager works by reading and downloading, from the HP FTP site, a published database file containing computer model and SoftPaq information. SoftPaq Download Manager allows you to specify one or more computer models to determine which SoftPaqs are available for download.

SoftPaq Download Manager checks the HP FTP site for updates to the database and software. If updates are found, they are downloaded and applied automatically.

SoftPaq Download Manager is available on the HP Web site. To use SoftPaq Download Manager to download SoftPaqs, you must first download and install the program. Go to the HP Web site at <http://www.hp.com/go/sdm>, and follow the instructions to download and install SoftPaq Download Manager.

To download SoftPaqs:

1. Select **Start > All Programs > HP Software Setup > HP SoftPaq Download Manager**.
2. When SoftPaq Download Manager opens for the first time, a window is displayed asking if you want to show only software for the computer you are using or to show the software for all supported models. Select **Show software for all supported models**. If you have used HP SoftPaq Download Manager previously, go to Step 3.
 - a. Select your operating system and language filters in the Configuration Options window. The filters limit the number of options that are listed in the Product Catalog pane. For example, if only Windows 7 Professional is selected in the operating system filter, the only operating system that is displayed in the Product Catalog is Windows 7 Professional.
 - b. To add other operating systems, change the filter settings in the Configuration Options window. Refer to the HP SoftPaq Download Manager software Help for more information.
3. In the left pane, click the plus sign (+) to expand the model list, and then select the model or models of the products you want to update.
4. Click **Find Available SoftPaqs** to download a list of available SoftPaqs for the selected computer.
5. Select from the list of available SoftPaqs, and then click **Download Only** if you have many SoftPaqs to download, because the SoftPaq selection and Internet connection speed determine how long the download process will take.

If you want to download only one or two SoftPaqs and have a high-speed Internet connection, click **Download & Unpack**.

6. Right-click **Install SoftPaq** in the SoftPaq Download Manager software to install the selected SoftPaqs on the computer.

9 Computer Setup (BIOS) and System Diagnostics

Using Computer Setup

Computer Setup, or Basic Input/Output System (BIOS), controls communication between all the input and output devices on the system (such as disk drives, display, keyboard, mouse, and printer). Computer Setup includes settings for the types of devices installed, the startup sequence of the computer, and the amount of system and extended memory.

 **NOTE:** Use extreme care when making changes in Computer Setup. Errors can prevent the computer from operating properly.

Starting Computer Setup

 **NOTE:** An external keyboard or mouse connected to a USB port can be used with Computer Setup only if USB legacy support is enabled.

To start Computer Setup, follow these steps:

1. Turn on or restart the computer, and then press **esc** while the “Press the ESC key for Startup Menu” message is displayed at the bottom of the screen.
2. Press **f10** to enter Computer Setup.

Navigating and selecting in Computer Setup

To navigate and select in Computer Setup, follow these steps:

1. Turn on or restart the computer, and then press **esc** while the “Press the ESC key for Startup Menu” message is displayed at the bottom of the screen.
 - To select a menu or a menu item, use the tab key and the keyboard arrow keys and then press **enter**, or use a pointing device to click the item.
 - To scroll up and down, click the up arrow or the down arrow in the upper-right corner of the screen, or use the up arrow key or the down arrow key.
 - To close open dialog boxes and return to the main Computer Setup screen, press **esc**, and then follow the on-screen instructions.

 **NOTE:** You can use either a pointing device (TouchPad, pointing stick, or USB mouse) or the keyboard to navigate and make selections in Computer Setup.

2. Press **f10** to enter Computer Setup.

To exit Computer Setup menus, choose one of the following methods:

- To exit Computer Setup menus without saving your changes:

Click the **Exit** icon in the lower-left corner of the screen, and then follow the on-screen instructions.

– or –

Use the tab key and the arrow keys to select **File > Ignore Changes and Exit**, and then press [enter](#).

- To save your changes and exit Computer Setup menus:

Click the **Save** icon in the lower-left corner of the screen, and then follow the on-screen instructions.

– or –

Use the tab key and the arrow keys to select **File > Save Changes and Exit**, and then press [enter](#).

Your changes go into effect when the computer restarts.

Restoring factory settings in Computer Setup

 **NOTE:** Restoring defaults will not change the hard drive mode.

To return all settings in Computer Setup to the values that were set at the factory, follow these steps:

1. Turn on or restart the computer, and then press [esc](#) while the “Press the ESC key for Startup Menu” message is displayed at the bottom of the screen.
2. Press [f10](#) to enter Computer Setup.
3. Use a pointing device or the arrow keys to select **File > Restore Defaults**.
4. Follow the on-screen instructions.
5. To save your changes and exit, click the **Save** icon in the lower-left corner of the screen, and then follow the on-screen instructions.

– or –

Use the arrow keys to select **File > Save Changes and Exit**, and then press [enter](#).

Your changes go into effect when the computer restarts.

 **NOTE:** Your password settings and security settings are not changed when you restore the factory settings.

Updating the BIOS

Updated versions of the BIOS may be available on the HP Web site.

Most BIOS updates on the HP Web site are packaged in compressed files called *SoftPaqs*.

Some download packages contain a file named *Readme.txt*, which contains information regarding installing and troubleshooting the file.

Determining the BIOS version

To determine whether available BIOS updates contain later BIOS versions than those currently installed on the computer, you need to know the version of the system BIOS currently installed.

BIOS version information (also known as *ROM date* and *System BIOS*) can be displayed by pressing **fn+esc** (if you are already in Windows) or by using Computer Setup.

1. Start Computer Setup.
2. Use a pointing device or the arrow keys to select **File > System Information**.
3. To exit Computer Setup without saving your changes, click the **Exit** icon in the lower-left corner of the screen, and then follow the on-screen instructions.

– or –

Use the tab key and the arrow keys to select **File > Ignore Changes and Exit**, and then press **enter**.

Downloading a BIOS update

 **CAUTION:** To reduce the risk of damage to the computer or an unsuccessful installation, download and install a BIOS update only when the computer is connected to reliable external power using the AC adapter. Do not download or install a BIOS update while the computer is running on battery power, docked in an optional docking device, or connected to an optional power source. During the download and installation, follow these instructions:

Do not disconnect power from the computer by unplugging the power cord from the AC outlet.

Do not shut down the computer or initiate Sleep or Hibernation.

Do not insert, remove, connect, or disconnect any device, cable, or cord.

1. Select **Start > Help and Support > Maintain**.
2. Follow the on-screen instructions to identify your computer and access the BIOS update you want to download.
3. At the download area, follow these steps:
 - a. Identify the BIOS update that is later than the BIOS version currently installed on your computer. Make a note of the date, name, or other identifier. You may need this information to locate the update later, after it has been downloaded to your hard drive.
 - b. Follow the on-screen instructions to download your selection to the hard drive.

Make a note of the path to the location on your hard drive where the BIOS update is downloaded. You will need to access this path when you are ready to install the update.

 **NOTE:** If you connect your computer to a network, consult the network administrator before installing any software updates, especially system BIOS updates.

BIOS installation procedures vary. Follow any instructions that are displayed on the screen after the download is complete. If no instructions are displayed, follow these steps:

1. Open Windows Explorer by selecting **Start > Computer**.
2. Double-click your hard drive designation. The hard drive designation is typically Local Disk (C:).
3. Using the hard drive path you recorded earlier, open the folder on your hard drive that contains the update.
4. Double-click the file that has an .exe extension (for example, *filename.exe*).

The BIOS installation begins.

5. Complete the installation by following the on-screen instructions.

 **NOTE:** After a message on the screen reports a successful installation, you can delete the downloaded file from your hard drive.

Using System Diagnostics

System Diagnostics allows you to run diagnostic tests to determine if the computer hardware is functioning properly. The following diagnostic tests are available in System Diagnostics:

- **Start-up test**—This test analyzes the main computer components that are required to start the computer.
- **Run-in test**—This test repeats the start-up test and checks for intermittent problems that the start-up test does not detect.
- **Hard disk test**—This test analyzes the physical condition of the hard drive, and then checks all data in every sector of the hard drive. If the test detects a damaged sector, it attempts to move the data to a good sector.
- **Memory test**—This test analyzes the physical condition of the memory modules. If it reports an error, replace the memory modules immediately.
- **Battery test**—This test analyzes the condition of the battery. If the battery fails the test, contact HP Customer Support to report the issue and purchase a replacement battery.

You can also view system information and error logs in the System Diagnostics window.

To start System Diagnostics:

1. Turn on or restart the computer. While the “Press the ESC key for Startup Menu” message is displayed in the lower-left corner of the screen, press **esc**. When the Startup Menu is displayed, press **f2**.
2. Click the diagnostic test you want to run, and then follow the on-screen instructions.

 **NOTE:** If you need to stop a diagnostics test while it is running, press **esc**.

10 MultiBoot

About the boot device order

As the computer starts, the system attempts to boot from enabled boot devices. The MultiBoot utility, which is enabled at the factory, controls the order in which the system selects a boot device. Boot devices can include optical drives, diskette drives, a network interface card (NIC), hard drives, and USB devices. Boot devices contain bootable media or files that the computer needs to start and operate properly.

 **NOTE:** Some boot devices must be enabled in Computer Setup before they can be included in the boot order.

The factory setting is for the computer to select the boot device by searching enabled boot devices and drive bay locations in the following order:

 **NOTE:** Some of the boot devices and drive bay locations listed may not be supported on your computer.

- Notebook upgrade bay
- Optical drive
- Notebook hard drive
- USB diskette drive
- USB CD-ROM
- USB hard drive
- Notebook Ethernet
- Secure Digital (SD) Memory Card
- Docking station upgrade bay
- External SATA drive

You can change the order in which the computer searches for a boot device by changing the boot order in Computer Setup. You can also press **esc** while the “Press the ESC key for Startup Menu” message is displayed at the bottom of the screen, and then press **f9**. Pressing **f9** displays a menu that shows the current boot devices and allows you to select a boot device. Or, you can use MultiBoot Express to set the computer to prompt you for a boot location each time the computer turns on or restarts.

Enabling boot devices in Computer Setup

The computer will boot to a USB device or a NIC device only if the device has first been enabled in Computer Setup.

To start Computer Setup and enable a USB device or a NIC device as a boot device, follow these steps:

1. Turn on or restart the computer, and then press **esc** while the “Press the ESC key for Startup Menu” message is displayed at the bottom of the screen.
2. Press **f10** to enter Computer Setup.
3. To enable bootable media in USB drives or in drives inserted into an optional docking device (select models only), use a pointing device or the arrow keys to select **System Configuration > Device Configurations**. Confirm **USB legacy support** is selected.

 **NOTE:** The USB Port option must be enabled in order to use USB legacy support. It is enabled at the factory. If the port becomes disabled, reenable it by selecting **System Configuration > Port Options**, and then selecting **USB Port**.

– or –

To enable a NIC device, select **System Configuration > Boot Options**, and then select **PXE Internal NIC boot**.

4. To save your changes and exit Computer Setup, click the **Save** icon in the lower-left corner of the screen, and then follow the on-screen instructions.

– or –

Use the arrow keys to select **File > Save Changes and Exit**, and then press **enter**.

Your changes go into effect when the computer restarts.

 **NOTE:** To connect a NIC to a Preboot eXecution Environment (PXE) or Remote Program Load (RPL) server without using MultiBoot, press **esc** while the “Press the ESC key for Startup Menu” message is displayed at the bottom of the screen, and then quickly press **f12**.

Considering boot order changes

Before changing the boot order, note the following considerations:

- When the computer restarts after the boot order has been changed, the computer attempts to start using the new boot order.
- If there is more than one type of boot device, the computer attempts to boot using the first of each type of boot device (except for optical devices). For example, if the computer is connected to an optional docking device (select models only) that contains a hard drive, this hard drive will be shown in the boot order as a USB hard drive. If the system attempts to boot from this USB hard drive and fails, it will not attempt to boot to the hard drive in the hard drive bay. Instead, it will try to boot to the next type of device in the boot order. However, if there are two optical devices, and the first optical device does not boot (either because it does not contain media or the media is not a boot disc), the system will try to boot to the second optical device.
- Changing the boot order also changes the logical drive designations. For example, if you start up from a CD-ROM drive with a disc formatted as drive C, that CD-ROM drive becomes drive C and the hard drive in the hard drive bay becomes drive D.
- The computer will boot from a NIC device only if the device has been enabled in the Built-In Device Options menu of Computer Setup and if booting from the device has been enabled in the Boot Options menu of Computer Setup. Booting from a NIC does not affect logical drive designations because no drive letter is associated with the NIC.
- Drives in an optional docking device (select models only) are treated like external USB devices in the boot order.

Choosing MultiBoot preferences

You can use MultiBoot in the following ways:

- To set a new boot order that the computer uses each time it is turned on, by changing the boot order in Computer Setup.
- To dynamically choose the boot device, by pressing **esc** while the “Press the ESC key for Startup Menu” message is displayed at the bottom of the screen, and then pressing **f9** to enter the Boot Device Options menu.
- To use MultiBoot Express to set variable boot orders. This feature prompts you for a boot device each time the computer is turned on or restarted.

Setting a new boot order in Computer Setup

To start Computer Setup and set a boot device order that the computer uses each time it is turned on or restarted, follow these steps:

1. Turn on or restart the computer, and then press **esc** while the “Press the ESC key for Startup Menu” message is displayed at the bottom of the screen.
2. Press **f10** to enter Computer Setup.
3. Use a pointing device or the arrow keys to select the **Legacy Boot Order** list, and then press **enter**.
4. To move the device up in the boot order, use a pointing device to click the up arrow, or press the **+** key.
– or –
To move the device down in the boot order, use a pointing device to click the down arrow, or press the **-** key.
5. To save your changes and exit Computer Setup, click the **Save** icon in the lower-left corner of the screen, and then follow the on-screen instructions.

– or –

Use the arrow keys to select **File > Save Changes and Exit**, and then press **enter**.

Your changes go into effect when the computer restarts.

Dynamically choosing a boot device using the F9 prompt

To dynamically choose a boot device for the current startup sequence, follow these steps:

1. Open the Select Boot Device menu by turning on or restarting the computer, and then pressing **esc** while the “Press the ESC key for Startup Menu” message is displayed at the bottom of the screen.
2. Press **f9**.
3. Use a pointing device or the arrow keys to select a boot device, and then press **enter**.

Your changes go into effect immediately.

Setting a MultiBoot Express prompt

To start Computer Setup and set the computer to display the MultiBoot startup location menu each time the computer is started or restarted, follow these steps:

1. Turn on or restart the computer, and then press **esc** while the “Press the ESC key for Startup Menu” message is displayed at the bottom of the screen.
2. Press **f10** to enter Computer Setup.
3. Use a pointing device or the arrow keys to select **System Configuration > Boot Options**, and then press **enter**.
4. In the **Multiboot Express Popup Delay (Sec)** field, enter the length of time in seconds that you want the computer to display the startup location menu before it defaults to the current MultiBoot setting. (When 0 is selected, the Express Boot startup location menu is not displayed).
5. To save your changes and exit Computer Setup, click the **Save** icon in the lower-left corner of the screen, and then follow the on-screen instructions.

– or –

Use the arrow keys to select **File > Save Changes and Exit**, and then press **enter**.

Your changes go into effect when the computer restarts.

Entering MultiBoot Express preferences

When the Express Boot menu displays during startup, you have the following choices:

- To specify a boot device from the Express Boot menu, select your preference within the allotted time, and then press **enter**.
- To prevent the computer from defaulting to the current MultiBoot setting, press any key before the allotted time expires. The computer will not start until you select a boot device and press **enter**.
- To allow the computer to start according to the current MultiBoot settings, wait for the allotted time to expire.

11 Management

Using Client Management Solutions

Client Management Solutions software provides standards-based solutions for managing client (user) desktop, workstation, notebook, and tablet computers in a networked environment.

Client management includes the following key capabilities and features:

- Initial software image deployment
- Remote system software installation
- Software management and updates
- ROM updates
- Tracking and security of computer assets (the hardware and software installed on the computer)
- Fault notification and recovery of certain system software and hardware components

 **NOTE:** Support for specific features described in this section may vary, depending on computer model and/or version of management software installed on the computer.

Configuring and deploying a software image

The computer is shipped with a preinstalled system software image. The initial software image is configured during the first-time setup of the computer. After a brief software "unbundling" occurs, the computer is ready to be used.

A customized software image can be deployed (distributed) in one of the following ways:

- Installing additional software applications after unbundling the preinstalled software image
- Using software deployment tools, such as Altiris Deployment Solutions, to replace the preinstalled software with a customized software image
- Using a disk-cloning process to copy the contents from one hard drive to another

The deployment method you use depends on your organization's technology environment and processes.

 **NOTE:** Computer Setup and other system features provide further assistance with configuration management and troubleshooting, power management, and the recovery of system software.

Managing and updating software

HP provides several tools for managing and updating software on client computers:

- HP Client Manager for Altiris (select models only)

 **NOTE:** To download HP Client Manager for Altiris or to obtain more information about HP Client Manager for Altiris, see the HP Web site at <http://www.hp.com>.

- HP CCM (Client Configuration Manager) (select models only)
- HP SSM (System Software Manager)

HP Client Manager for Altiris (select models only)

HP Client Manager for Altiris integrates Intelligent Manageability technology into Altiris software. HP Client Manager for Altiris provides superior hardware management capabilities for HP devices:

- Detailed views of hardware inventory for asset management
- System Checkup monitoring and diagnostics
- Web-accessible reporting of business-critical details such as thermal warnings and memory alerts
- Remote updating of system software such as device drivers and the system BIOS

 **NOTE:** Additional functionality can be added when HP Client Manager for Altiris is used with optional Altiris Solutions software (purchased separately).

When HP Client Manager for Altiris (installed on a client computer) is used with Altiris Solutions software (installed on an administrator computer), HP Client Manager for Altiris provides increased management functionality and centralized hardware management of client devices for the following IT life-cycle areas:

- Inventory and asset management
 - Software license compliance
 - Computer tracking and reporting
 - Computer lease contract information and fixed asset tracking
- System software deployment and migration
 - Windows migration
 - System deployment
 - Personality (personal user settings) migration

- Help desk and problem resolution
 - Management of help desk tickets
 - Remote troubleshooting
 - Remote problem resolution
 - Client disaster recovery
- Software and operations management
 - Ongoing client management
 - HP system software deployment
 - Application self-healing (the ability to identify and repair certain application problems)

Altiris Solutions software provides easy-to-use software distribution capabilities. HP Client Manager for Altiris enables communication with the Altiris Solutions software, which can be used to complete new hardware deployment or personality migration to a new operating system using easy-to-follow wizards. HP Client Manager for Altiris is available for download from the HP Web site.

When Altiris Solutions software is used in conjunction with HP System Software Manager or HP Client Manager for Altiris, administrators can also update the system BIOS and device driver software from a central console.

HP CCM (Client Configuration Manager) (select models only)

HP CCM automates the management of software such as operating systems, programs, software updates, and content and configuration settings to ensure that each computer is maintained in the correct configuration. With these automated management solutions, you can manage software throughout the life cycle of the computer.

CCM enables you to perform the following tasks:

- Collect hardware and software inventory across multiple platforms
- Prepare a software package and conduct impact analysis prior to distribution
- Target individual computers, workgroups, or entire populations of computers for deployment and maintenance of software and content according to policies
- Provision and manage operating systems, applications, and content on distributed computers from any location
- Integrate CCM with help desks and other system management tools for seamless operations
- Leverage a common infrastructure for management of software and content on standard computing devices across any network for all enterprise users
- Scale to meet enterprise needs

HP SSM (System Software Manager)

HP SSM lets you remotely update system-level software on multiple systems simultaneously. When executed on a client computer, SSM detects versions of both hardware and software, and then updates designated software from a central repository, known as a file store. Driver versions that are supported by SSM are denoted with a special icon on the HP driver download Web site and on the *Support Software* CD. To download the SSM utility or to obtain more information on SSM, see the HP Web site at <http://www.hp.com/go/ssm> (English only).

Using Intel Active Management Technology (select models only)

Intel® Active Management Technology (iAMT) allows discovery, repair, and protection of networked computing assets. With iAMT, computers can be managed whether they are on or off. The iAMT solution is available on computers with Intel Centrino® with vPro mobile technology.

Features of iAMT include:

- Hardware inventory information
- Event notification
- Power management
- Remote diagnosis and repair
- Hardware-based isolation and recovery—limit or cut off computer network access if virus-like activity is detected

Enabling the iAMT solution

To configure iAMT settings:

 **NOTE:** The `ctrl+p` prompt is visible only if the AMT Setup Prompt option is enabled in Computer Setup.

1. Turn on or restart the computer.
2. Before Windows starts up, press `ctrl+p`.

 **NOTE:** If you do not press `ctrl+p` at the appropriate time, you must repeat steps 1 and 2 to access the MEBx setup utility.

3. Enter the ME password. The factory setting for the password is *admin*.
The MEBx setup utility opens. Use the arrow keys to navigate.
4. Choose to configure Intel ME, configure iAMT, or change the Intel ME password.
5. When you have made your selections, select **Exit** to close the MEBx setup utility.

Using the MEBx setup utility menus

 **NOTE:** For more information on iAMT, go to the Intel Web site at <http://www.intel.com>, and then search for iAMT.

Intel ME Configuration

| Select | To do this |
|--------------------------------|--|
| Intel ME State Control | Disable/enable the management engine. |
| Intel ME Firmware Local Update | Disable/enable local management of firmware updates. |
| LAN Controller | Disable/enable the integrated network controller. |
| Intel ME Features Control | Disable/enable AMT or none. |
| Intel ME Power Control | Configure the management engine power policies. |

iAMT Configuration

| Select | To do this |
|-------------------------|---|
| Host Name | Assign a host name to the computer. |
| TCP/IP | Disable/enable network interface or DHCP (assigns an IP address if DHCP has been disabled) or change the domain name. |
| Provision Model | Assign enterprise or small business iAMT model. |
| Setup and Configuration | Set options to control remote configuration of AMT. |
| Un-Provision | Reset the AMT configuration to factory defaults. |
| SOL/IDE-R | Disable/enable remote boot control to IDE diskette or CD-ROM and assign a user name and password. |

| Select | To do this |
|------------------------|---|
| Password Policy | Set options to control requirements for the network password and the MEBx password. |
| Secure Firmware Update | Disable/enable or disable updating firmware remotely. |
| Set PRTC | Set the real-time clock. |
| Idle Timeout | Set a time-out value. |

Change Intel ME Password

| Select | To do this |
|--------------------|----------------------|
| Change ME Password | Change the password. |

NOTE: The default password is **admin**.

A Traveling with the computer

For best results, follow these traveling and shipping tips:

- Prepare the computer for traveling or shipping:
 - Back up your information.
 - Remove all discs and all external media cards, such as digital cards.
- ⚠ **CAUTION:** To reduce the risk of damage to the computer, damage to a drive, or loss of information, remove the media from a drive before removing the drive from a drive bay and before shipping, storing, or traveling with a drive.
- Turn off and then disconnect all external devices.
- Shut down the computer.
- Take along a backup of your information. Keep the backup separate from the computer.
- When traveling by air, carry the computer as hand luggage; do not check it in with the rest of your bags.
- ⚠ **CAUTION:** Avoid exposing a drive to magnetic fields. Security devices with magnetic fields include airport walk-through devices and security wands. Airport conveyer belts and similar security devices that check carry-on baggage use X-rays instead of magnetism and do not damage drives.
- In-flight computer use is at the discretion of the airline. If you plan to use the computer during a flight, check with the airline in advance.
- If the computer will be unused and disconnected from external power for more than 2 weeks, remove the battery and store it separately.
- If you are shipping the computer or a drive, use suitable protective packaging and label the package “FRAGILE.”
- If the computer has a wireless device or an HP Mobile Broadband Module installed, such as an 802.11b/g device, a Global System for Mobile Communications (GSM) device, or a General Packet Radio Service (GPRS) device, the use of these devices may be restricted in some environments. Such restrictions may apply onboard aircraft, in hospitals, near explosives, and in

hazardous locations. If you are uncertain of the policy that applies to the use of a particular device, ask for authorization to use it before you turn it on.

- If you are traveling internationally, follow these suggestions:
 - Check the computer-related customs regulations for each country or region on your itinerary.
 - Check the power cord and adapter requirements for each location in which you plan to use the computer. Voltage, frequency, and plug configurations vary.

 **WARNING!** To reduce the risk of electric shock, fire, or damage to the equipment, do not attempt to power the computer with a voltage converter kit sold for appliances.

B Troubleshooting resources

- Access Web site links and additional information about the computer through Help and Support. Select **Start > Help and Support**.

 **NOTE:** Some checkup and repair tools require an Internet connection. HP also provides additional tools that do not require an Internet connection.

- Contact HP Customer Support at <http://www.hp.com/go/contactHP>.

 **NOTE:** For worldwide support, click **Contact HP worldwide** on the left side of the page, or go to http://welcome.hp.com/country/us/en/wwcontact_us.html.

Choose from the following types of support:

- Chat online with an HP technician.

 **NOTE:** When chat is not available in a particular language, it is available in English.

- E-mail HP Customer Support.
- Find HP Customer Support worldwide telephone numbers.
- Locate an HP service center.

C Electrostatic Discharge

Electrostatic discharge is the release of static electricity when two objects come into contact—for example, the shock you receive when you walk across the carpet and touch a metal door knob.

A discharge of static electricity from fingers or other electrostatic conductors may damage electronic components. To prevent damage to the computer, damage to a drive, or loss of information, observe these precautions:

- If removal or installation instructions direct you to unplug the computer, unplug it after being properly grounded and before removing a cover.
- Keep components in their electrostatic-safe containers until you are ready to install them.
- Avoid touching pins, leads, and circuitry. Handle electronic components as little as possible.
- Use nonmagnetic tools.
- Before handling components, discharge static electricity by touching an unpainted metal surface of the component.
- If you remove a component, place it in an electrostatic-safe container.

If you need more information about static electricity or assistance with component removal or installation, contact HP Customer Support.

Index

Symbols/Numerics

- 1394 cable, connecting 42
- 1394 devices
 - connecting 42
 - defined 41
 - removing 42
- 16-bit PC Cards 34
- 32-bit PC Cards 34

A

- AC adapter, testing 32
- administrator password 56
- airport security devices 47
- Altiris Deployment Solutions 82
- antivirus software 63
- audio functions, checking 16
- Automatic DriveLock password
 - entering 61
 - removing 61

B

- battery
 - conserving power 29
 - discharging 28
 - displaying remaining charge 28
 - disposing 30
 - low battery levels 28
 - replacing 30
 - storing 30
- Battery Check 28
- battery information, finding 27
- battery power 27
- battery temperature 30
- BIOS
 - determining version 75
 - downloading an update 75
 - updating 75
- Bluetooth device 2, 8

- boot devices, enabling 78
- buttons
 - media 15
 - power 22
 - volume 16

C

- cables
 - 1394 42
 - eSATA 43
 - USB 41
- CardBus PC Cards 34
- caring for your computer 70
- changing boot order 80
- checking audio functions 16
- cleaning your computer 70
- Computer Setup
 - BIOS administrator password 57
 - DriveLock password 58
 - enabling bootable devices 78
 - navigating and selecting 73
 - restoring factory settings 74
 - setting boot order 80
 - setting MultiBoot Express prompt 81
- computer, traveling 30, 89
- configuring
 - audio for HDMI 20
 - ExpressCards 37
 - PC Cards 35
- connecting to
 - existing wireless network 5
 - wired network 9
- Connection Manager 4
- connector, docking 45
- conservation, power 29
- creating a wireless connection 2
- critical battery level 23, 29

- critical updates, software 65

D

- deployment, software 82
- digital card
 - inserting 33
 - removing 34
 - supported formats 33
- Disk Cleanup software 48
- Disk Defragmenter software 48
- docking connector 45
- drive light 49
- drive media 23
- DriveLock password
 - changing 60
 - description 58
 - entering 60
 - removing 60
 - setting 59
- drivers 35
- drives
 - boot order 77
 - external 44
 - handling 47
 - hard 44
 - optical 45
 - using 48

E

- electrostatic discharge 92
- eSATA cable, connecting 43
- eSATA devices
 - connecting 43
 - defined 42
 - removing 43
- existing wireless network,
 - connecting to 5
- expansion port 45

ExpressCard
 configuring 37
 defined 37
 inserting 38
 removing 39
 removing insert 38
external AC power, using 30
external devices 44
external drive 44
external monitor port 19

F
finding more information 1
fingerprint reader 68
firewall software 6, 64

G
GPS 8
graphics modes, switching 32

H
hard drive
 external 44
 HP 3D DriveGuard 49
HDMI
 configuring audio 20
HDMI port, connecting 20
Hibernation
 exiting 23
 initiated during critical battery level 29
 initiating 23
high-definition devices,
 connecting 20, 21
hotkeys, media 15
HP 3D DriveGuard 49
HP Client Configuration
 Manager 83, 85
HP Client Manager for Altiris 83
HP Connection Manager 4
HP Mobile Broadband Module 7
HP ProtectTools Security
 Manager 66
HP System Software Manager
 83, 85
HP USB Ethernet Adapter,
 connecting 13
hubs 40

I
icons
 network 2
 wireless 2
image, computer 82
Intel Centrino Pro technology 87
Intel Wireless Display 21
Internet connection setup 6

J
Java Card
 defined 39
 inserting 40
 removing 40

K
keys
 media 15
 volume 16

L
legacy support, USB 73
lights
 drive 49
local area network (LAN)
 cable required 13
 connecting cable 13
logical drive designations 79
low battery level 28

M
maintenance
 Disk Cleanup 48
 Disk Defragmenter 48
media activity controls 15
media hotkeys 15
modems
 connecting a modem cable 9
 connecting a modem cable
 adapter 11
 selecting a location setting 11
MultiBoot Express 77, 81

N
network cable, connecting 13
network icon 2
Network Service Boot 78
NIC boot device 77, 78

O
operating system controls 4

optical disc
 inserting 50
 removing 51
optical drive 45
optional external devices, using
 44

P
passwords
 administrator 56
 BIOS administrator 57
 DriveLock 58
 user 56

PC Cards
 configuring 35
 description 34
 inserting 36
 removing 37
 removing insert 36
 software and drivers 35
 supported types 34

ports
 expansion 45
 external monitor 19
 HDMI 20
 Intel Wireless Display 21
 VGA 19

power
 battery 27
 conserving 29
 options 23
Power Assistant 27
power button 22
power meter 24
power plans
 customizing 25
 selecting 24
 viewing current 24
power switch 22
power-saving states 23
protecting your wireless network
 6
PXE server 78

R
RAID 54
readable media 23
roaming to another network 6

S
security, wireless 6

- setting password protection on
 - wakeup 25
- setting power options 23
- setup of WLAN 6
- setup utility
 - navigating and selecting 73
 - restoring factory settings 74
- sharing optical drives 54
- shutdown 22
- SIM
 - inserting 7
 - removing 8
- Sleep
 - exiting 23
 - initiating 23
- slot-load optical drive 51
- smart card
 - defined 39
 - inserting 40
 - removing 40
- SoftPaqs, downloading 72
- software
 - antivirus 63
 - critical updates 65
 - deployment 82
 - Disk Cleanup 48
 - Disk Defragmenter 48
 - firewall 64
 - HP Connection Manager 4
 - recovery 82
 - updates 83
- storing a battery 30
- switch, power 22
- switchable graphics 32

T

- temperature 30
- testing an AC adapter 32
- traveling with the computer 30, 89
- tray-load optical drive 50
- troubleshooting resources 91
- turning off the computer 22
- turning wireless devices on or off 4

U

- unresponsive system 22
- updates, software 83
- USB cable, connecting 41

- USB devices
 - connecting 41
 - description 40
 - removing 41
- USB hubs 40
- USB legacy support 73
- user password 56
- using
 - external AC power 30
 - modem 9
 - power meter 24
 - power plans 24
 - power-saving states 23

V

- VGA port, connecting 19
- video 19
- volume
 - adjusting 16
 - buttons 16
 - keys 16

W

- Web sites
 - HP System Software Manager 85
 - Intel Pro technology for AMT 87
- webcam 18
- wireless
 - icons 2
 - protecting 6
 - set up 6
- wireless connection, creating 2
- wireless devices, turning on or off 4
- wireless encryption 6
- wireless network (WLAN)
 - connecting to existing 5
 - equipment needed 6
 - security 6
- writable media 23
- WWAN device 7

Z

- zoomed video PC Cards 34

Free Manuals Download Website

<http://myh66.com>

<http://usermanuals.us>

<http://www.somanuals.com>

<http://www.4manuals.cc>

<http://www.manual-lib.com>

<http://www.404manual.com>

<http://www.luxmanual.com>

<http://aubethermostatmanual.com>

Golf course search by state

<http://golfingnear.com>

Email search by domain

<http://emailbydomain.com>

Auto manuals search

<http://auto.somanuals.com>

TV manuals search

<http://tv.somanuals.com>