



Allen-Bradley

MicroLogix™ Ethernet Interface (ENI)

(Cat. No. 1761-NET-ENI)

User Manual

**Rockwell
Automation**

Important User Information

Because of the variety of uses for the products described in this publication, those responsible for the application and use of this control equipment must satisfy themselves that all necessary steps have been taken to assure that each application and use meets all performance and safety requirements, including any applicable laws, regulations, codes and standards.

The illustrations, charts, sample programs and layout examples shown in this guide are intended solely for purposes of example. Since there are many variables and requirements associated with any particular installation, Allen-Bradley does not assume responsibility or liability (to include intellectual property liability) for actual use based upon the examples shown in this publication.

Allen-Bradley publication SGI-1.1, *Safety Guidelines for the Application, Installation and Maintenance of Solid-State Control* (available from your local Allen-Bradley office), describes some important differences between solid-state equipment and electromechanical devices that should be taken into consideration when applying products such as those described in this publication.

Reproduction of the contents of this copyrighted publication, in whole or part, without written permission of Rockwell Automation, is prohibited.

Throughout this manual we use notes to make you aware of safety considerations:

ATTENTION



Identifies information about practices or circumstances that can lead to personal injury or death, property damage or economic loss

Attention statements help you to:

- identify a hazard
- avoid a hazard
- recognize the consequences

IMPORTANT

Identifies information that is critical for successful application and understanding of the product.

Allen-Bradley is a trademark of Rockwell Automation

Preface	Who Should Use this Manual	P-1
	Purpose of this Manual	P-1
	Common Techniques Used in this Manual	P-2
	Rockwell Automation Support	P-3
	 Chapter 1	
Product Overview	Ethernet Connection	1-1
	Non-Ethernet Devices	1-1
	Hardware Features	1-2
	Operating Modes	1-4
	Device Compatibility	1-4
	Ethernet Networks	1-5
	 Chapter 2	
Installation and Wiring	European Communities (EC) Directive Compliance	2-1
	Safety Considerations	2-2
	Mounting	2-3
	ENI Port Identification	2-5
	External Power Supply Wiring	2-5
	Ethernet Connections	2-6
	RS-232 Port Connections	2-8
	 Chapter 3	
Operation	Operation Overview	3-1
	Allocation of Ethernet Connections	3-1
	ENI Functional Overview	3-2
	Program Upload/Download and On-Line Sessions	3-2
	 Chapter 4	
ENI Configuration (Node 248 to 254)	Configuration Methods	4-1
	ENI Configuration Utility	4-1
	Controller Messaging	4-5
	Configuring ENI Data Parameters	4-6
	Configuring ENI String Parameters	4-8
	ENI Configuration Parameters	4-10
	 Chapter 5	
Peer-to-Peer Messaging	Messaging Between the ENI and DF1 Devices	5-1
	Message to Configuration Nodes (Nodes 100 to 149)	5-3
	Sending a Message to a Destination Controller (Nodes 0 to 49)	5-4

	Chapter 6	
E-Mail Messages (Node 50 to 99)	Overview	6-1
	Configuring E-Mail	6-2
	Sending an E-Mail Message	6-5
	Chapter 7	
Connecting 1769-L20 CompactLogix Controllers on Ethernet	System Diagram	7-1
	Purpose	7-2
	Scope	7-2
	General Ethernet Information	7-3
	Configuring 1761-NET-ENI #1	7-4
	Configuring 1761-NET-ENI #2	7-6
	Configure RSLINX and Download the Program To the 1769-L20	7-13
	Create MSG Programs for the SLC 5/05 and the 5550 Controllers	7-15
	Configuring an Ethernet Driver in RSLINX	7-21
	Chapter 8	
Troubleshooting	Network Troubleshooting	8-1
	LED Sequence at Power-Up.	8-1
	Troubleshooting Using the LED Indicators	8-2
	Error Codes Generated by the ENI.	8-3
	Message Instruction Error Codes	8-3
	Appendix A	
Specifications	Physical Specifications.	A-1
	Ethernet Specifications	A-1
	MicroLogix Web Site	A-1
	Dimensions.	A-2
	Appendix B	
BOOTP Configuration Method (default)	Using BOOTP	B-2
	Run the Boot Server Utility	B-5
	Glossary	
	Index	

Read this preface to familiarize yourself with the rest of the manual. It provides information concerning:

- who should use this manual
- the purpose of this manual
- related documentation
- conventions used in this manual
- Rockwell Automation support

Who Should Use this Manual

Use this manual if you are responsible for designing, installing, programming, or troubleshooting control systems that use Allen-Bradley Controllers on Ethernet.

You should have a basic understanding of Allen-Bradley programmable controllers and Ethernet networking. You should understand programmable controllers and be able to interpret the ladder logic instructions required to control your application. If you do not, contact your local Allen-Bradley representative for information on available training courses before using this product.

Purpose of this Manual

This manual is a reference guide for the Ethernet Interface (ENI). It describes the procedures you use to install and configure the ENI.

This manual:

- gives you an overview of the ENI
- explains the procedures you need to install and use an ENI

Related Documentation

The following documents contain additional information concerning Rockwell Automation products. To obtain a copy, contact your local Rockwell Automation office or distributor.

For	Read this Document	Document Number
Instructions on installing a 1761-NET-ENI Interface Converter.	Ethernet Interface Installation Instructions	1761-IN006A-MU-P
Information on DF1 open protocol.	DF1 Protocol and Command Set Reference Manual	1770-6.5.16
In-depth information on grounding and wiring Allen-Bradley programmable controllers	Allen-Bradley Programmable Controller Grounding and Wiring Guidelines	1770-4.1
A description of important differences between solid-state programmable controller products and hard-wired electromechanical devices	Application Considerations for Solid-State Controls	SGI-1.1
An article on wire sizes and types for grounding electrical equipment	National Electrical Code - Published by the National Fire Protection Association of Boston, MA.	
A complete listing of current documentation, including ordering instructions. Also indicates whether the documents are available on CD-ROM or in multi-languages.	Allen-Bradley Publication Index	SD499
A glossary of industrial automation terms and abbreviations	Allen-Bradley Industrial Automation Glossary	AG-7.1

Common Techniques Used in this Manual

The following conventions are used throughout this manual:

- Bulleted lists such as this one provide information, not procedural steps.
- Numbered lists provide sequential steps or hierarchical information.
- *Italic* type is used for emphasis.

Rockwell Automation Support

Rockwell Automation offers support services worldwide, with over 75 Sales/Support Offices, 512 authorized Distributors and 260 authorized Systems Integrators located throughout the United States alone, plus Rockwell Automation representatives in every major country in the world.

Local Product Support

Contact your local Rockwell Automation representative for:

- sales and order support
- product technical training
- warranty support
- support service agreements

Technical Product Assistance

If you need to contact Rockwell Automation for technical assistance, please review the *Troubleshooting* information on page 8-1 in this manual first. Then call your local Rockwell Automation representative.

Your Questions or Comments on this Manual

If you find a problem with this manual, or you have any suggestions for how this manual could be made more useful to you, please contact us at the address below:

Rockwell Automation
Control and Information Group
Technical Communication, Dept. A602V
P.O. Box 2086
Milwaukee, WI 53201-2086

or visit our internet page at:

<http://www.rockwellautomation.com>

Product Overview

This chapter gives an overview of the Ethernet Network Interface. The following topics are covered:

- Ethernet Connection
- Non-Ethernet Devices
- Hardware Features
- Operating Modes
- Device Compatibility
- Ethernet Networks

Ethernet Connection

The 1761-NET-ENI provides Ethernet/IP connectivity for all MicroLogix controllers and other DF1 full-duplex devices. The Ethernet Network Interface (ENI) allows you to easily connect a MicroLogix onto new or existing Ethernet networks and upload/download programs, communicate between controllers, and generate e-mail messages via SMTP (simple mail transport protocol).

Ethernet/IP is an industry standard open protocol which provides inter-device compatibility. You can exchange information with other Allen Bradley Ethernet controllers (SLC, PLC, and ControlLogix) in a peer-to-peer relationship, so you do not need any master-type device.

Non-Ethernet Devices

The ENI allows you to connect non-Ethernet Allen-Bradley programmable controllers to Ethernet networks. The ENI uses Ethernet/IP services to allow these controllers to intercommunicate via their native PCCC messaging.

The ENI allows a non-Ethernet controller to initiate a message to another device over Ethernet. The message can be sent to its application master, or to a peer device. These communications are also referred to as “report on exception” messaging.

When the ENI is connected to a programmable controller, the controller can be used for data acquisition (or Supervisory Control and Data Acquisition, SCADA) functions. This SCADA ability allows the controller to function as a smart RTU over Ethernet.

The ENI also supports an SMTP mail service that allows an existing controller to send e-mail messages to any destination connected to the network. The e-mail can be used to initiate the transmission of data or status information.

Hardware Features

Product Drawing

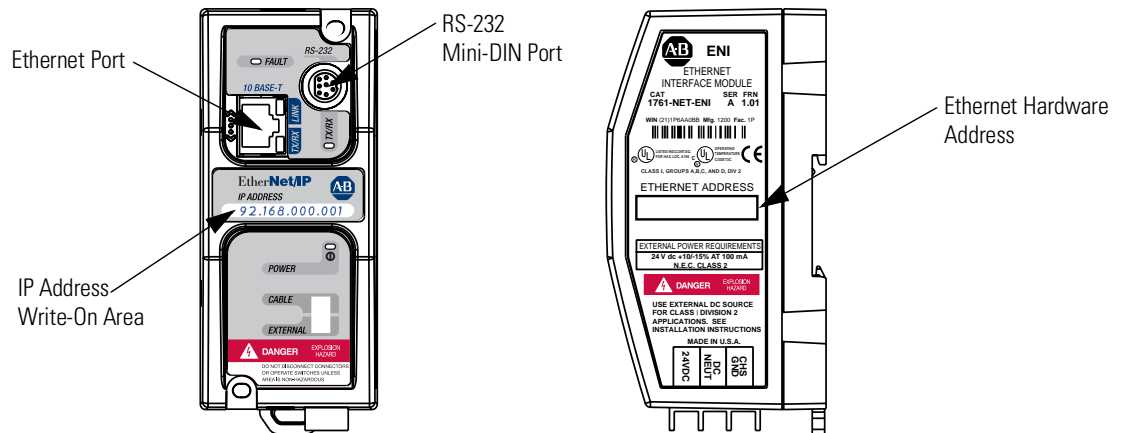

LED Indicators

The ENI has five LED indicators:

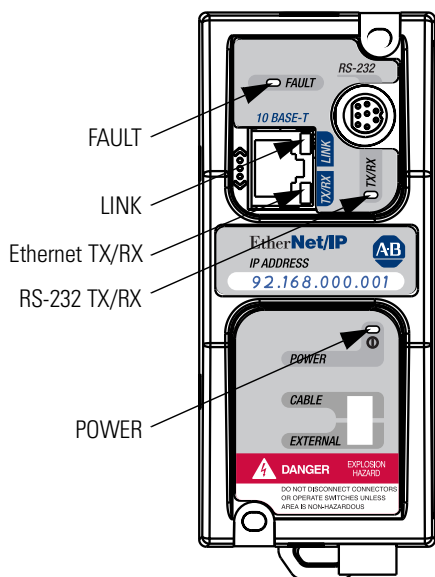

LED	Description	Function	Color
TX/RX	RS-232 data transmission indicator	flashes when the RS-232 port is transmitting or receiving data	green
POWER	module power	lit when module is powered	green
LINK	Ethernet link status	lit when there is a valid physical Ethernet connection	green
TX/RX	Ethernet data transmission indicator	flashes when the Ethernet port is transmitting or receiving data	green
FAULT	fault condition indicator	lit when a fault condition is present	red

For more detailed information on LED operation, see Chapter 8, Troubleshooting.

Default Settings

The ENI's RS-232 port has the following default settings:

Table 1.1 RS-232 Settings

Setting	Default	Other Options
Baud Rate	Autobaud	see table 4.7
Handshaking (hardware, software)	none	none
Data Bits	8	none
Stop Bits	1	none
Parity	none	none

Table 1.2 DF1 Settings

Setting	Default	Other Options
Duplicate Message Detection	Enable	none
Error Detection	CRC, BCC	Auto-detect when Autobaud is true, otherwise CRC
Embedded Response Operation	Auto-Detect, for reception only ⁽¹⁾	none
DLE ACK Timeout	1 second	none
DLE NAK Receive	3 NAK retries	none
DLE ENQ for Response	3 ENQs retries	none
DF1 Node Address	Don't Care	

(1) The ENI receives NAKs and ACKs, but does not generate them.

Operating Modes

Messaging

When the ENI is connected to a programmable controller (and connected to an Ethernet network), the controller can be accessed from other devices on Ethernet, or initiate communications to other Ethernet/IP devices.

E-Mail

The ENI also supports SMTP mail service, that allows a controller to send e-mail messages to any e-mail address on the network. The e-mail can be used to initiate the transmission of data or status information.

Device Compatibility

The ENI is compatible with the following devices and applications:

- All MicroLogix, SLC, and PLC-5 DF1 Full-Duplex capable controllers that have at least one RS-232 port
- Personal Computers using the RSLinx (V2.30.00 and higher) DF1 Full-Duplex Driver
- Other DF1 Full-Duplex compliant products that have at least one RS-232 port, for example, operator interface devices
- RSLinx (V2.30.00 and higher) Ethernet Driver
- CompactLogix

Ethernet Networks

Basic Ethernet Topology

The ENI Ethernet connector conforms to ISO/IEC 8802-3 STD 802.3 and utilizes 10Base-T media. Connections are made directly from the ENI to an Ethernet switch. The network setup is simple and cost effective. Typical network topology is pictured below.

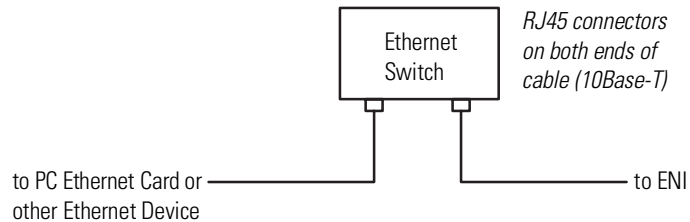

IMPORTANT

The ENI provides a 10Base-T, RJ45 Ethernet connector which connects to standard Ethernet hubs and switches via an 8-wire twisted pair straight-through cable. To access other Ethernet mediums, use 10Base-T media converters or Ethernet switches that can be connected together via fiber, thin-wire, or thick-wire coaxial cables, or any other physical media commercially available with Ethernet switches. See page 2-7 for more cable information.

IMPORTANT

The IP addresses in any of the examples in this manual were arbitrarily assigned and should only be used on an isolated Ethernet network. Contact your system administrator for unique IP addresses if you are connecting your Ethernet devices to your employer's Ethernet network.

Using a Web Browser with the ENI

You can access information about the ENI via your web browser. Simply enter the ENI's TCP/IP address into the address field of your browser.

Installation and Wiring

This chapter covers installation and wiring for the ENI. It is divided into the following sections:

- European Communities (EC) Directive Compliance
- Safety Considerations
- Mounting
- External Power Supply Wiring
- ENI Port Identification
- Ethernet Connections
- RS-232 Port Connections

European Communities (EC) Directive Compliance

This product has the CE mark. It is approved for installation within the European Union and EEA regions. It has been designed and tested to meet the following directives.

EMC Directive

This product is tested to meet the Council Directive 89/336/EC Electromagnetic Compatibility (EMC) by applying the following standards, in whole or in part, documented in a technical construction file:

- EN 50081-2 EMC — Generic Emission Standard, Part 2 — Industrial Environment
- EN 50082-2 EMC — Generic Immunity Standard, Part 2 — Industrial Environment

This product is intended for use in an industrial environment.

Low Voltage Directive

This product is tested to meet Council Directive 73/23/EEC Low Voltage, by applying the safety requirements of EN 61131-2 Programmable Controllers, Part 2 - Equipment Requirements and

Tests. For specific information required by EN 61131-2, see the appropriate sections in this publication, as well as the Allen-Bradley publication Industrial Automation Wiring and Grounding Guidelines For Noise Immunity, publication 1770-4.1.

Open style devices must be provided with environmental and safety protection by proper mounting in enclosures designed for specific application conditions. See NEMA Standards publication 250 and IEC publication 529, as applicable, for explanations of the degrees of protection provided by different types of enclosure.

Safety Considerations

This equipment is suitable for use in Class I, Division 2, Groups A, B, C, D, or non-hazardous locations only. The following WARNING statement applies to use in hazardous locations.

WARNING



Explosion Hazard

- Substitution of components may impair suitability for Class I, Division 2.
- Do not replace components or disconnect equipment unless power has been switched off and the area is known to be non-hazardous.
- Do not connect or disconnect connectors or operate switches while circuit is live unless the area is known to be non-hazardous.
- This product must be installed in an enclosure. All cables connected to the product must remain in the enclosure or be protected by conduit or other means.
- The ENI must be operated from an external power source.
- All wiring must comply with N.E.C. article 501-4(b).

Use only the following communication cables and replacement connectors in Class I Division 2 Hazardous Locations.

Environment Classification	Communication Cable and Connectors	
Class I, Division 2 Hazardous Environment	1761-CBL-PM02 Series C	2707-NC8 Series B
	1761-CBL-HM02 Series C	2707-NC9 Series B
	1761-CBL-AM00 Series C	2707-NC10 Series B
	1761-CBL-AP00 Series C	2707-NC11 Series B

Mounting

The 1761-NET-ENI must be mounted in the vertical position, as shown. *Horizontal mounting is not recommended due to thermal considerations.* Allow 50 mm (2 in.) of space on all sides for adequate ventilation. See page A-1 for operating temperature specification.

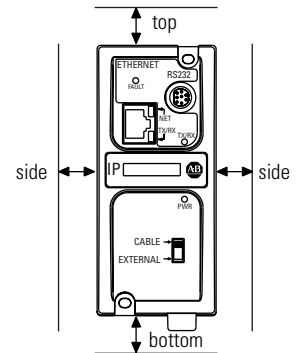
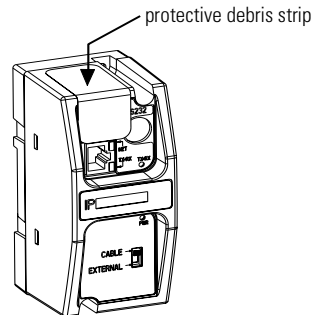

ATTENTION



Do not remove the protective debris strip until after all the equipment in the panel is mounted and wiring is complete. Once wiring is complete, remove protective debris strip. Failure to remove strip before operating can cause overheating.

DIN Rail Mounting

Installation

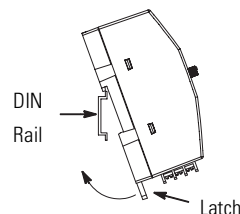

1. Mount your DIN rail.
2. Snap the DIN rail latch into the closed position.
3. Hook the top slot over the DIN rail.
4. While pressing the unit against the rail, snap the unit into position.

Removal

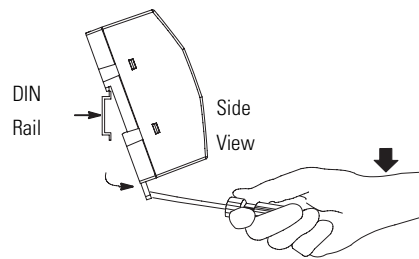

1. Place a screwdriver in the DIN rail latch at the bottom of the unit.
2. Holding the unit, pry downward on the latch until the unit is released from the DIN rail.

Panel Mounting

Template

See Appendix A for panel mounting template.

Installation

ATTENTION



Be careful of metal chips when drilling mounting holes for your equipment within the enclosure or panel. Drilled fragments that fall into the equipment could cause damage. Do not drill holes above mounted equipment if the protective debris strip has been removed.

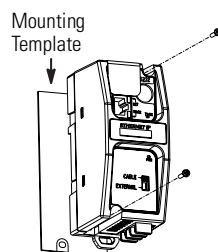

1. Remove the mounting template from the back of this document.
2. Secure the template to the mounting surface.
3. Drill holes through the template.
4. Remove the mounting template.
5. Mount the unit.

ENI Port Identification

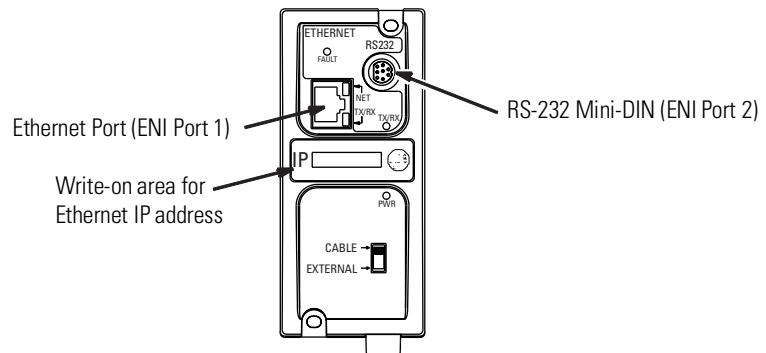

External Power Supply Wiring

WARNING



EXPLOSION HAZARD - In Class I Division 2 applications, an external, Class 2 power supply must be used. The DC Power Source selector switch on the ENI must be set to EXTERNAL before connecting the power supply to the ENI.

IMPORTANT

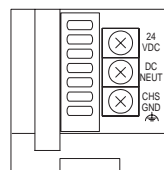

Bottom View

- In non-hazardous locations, external power is not required. Some devices (such as a MicroLogix controller) provide power to the ENI via a cable connected to ENI port 2. Be sure to set the DC power source selector switch to match your particular configuration, CABLE or EXTERNAL.
- Always connect the CHS GND (chassis ground) terminal to the nearest earth ground. This connection must be made whether or not an external 24V dc supply is used.

Ethernet Connections

Ethernet 8-Pin 10Base-T Connector (Port 1)

The Ethernet connector is an RJ45, 10Base-T connector. The pin-out for the connector is shown below:

Pin	Pin Name
1	Tx+
2	Tx-
3	Rx+
4	not used by 10Base-T
5	not used by 10Base-T
6	Rx-
7	not used by 10Base-T
8	not used by 10Base-T

When to use straight-through and cross-over cable:

- ENI Ethernet port to 10Base-T Ethernet switch cables utilize a straight-through pin-out (1-1, 2-2, 3-3, 6-6).
- Direct point-to-point 10Base-T cables connecting the ENI Ethernet port directly to another ENI Ethernet port (or a computer 10Base-T port) require a cross-over pin-out (1-3, 2-6, 3-1, 6-2).

Ethernet Cables

Shielded and non-shielded twisted-pair 10Base-T cables with RJ45 connectors are supported. The maximum cable length between an ENI Ethernet port and a 10Base-T port on an Ethernet switch (without repeaters or fiber) is 100 meters (323 feet). However, in an industrial application, the cable length should be kept to a minimum.

With media converters or Ethernet switches, you can also connect to the following media:

- fiber optic
- broadband
- thick-wire coaxial cable (10Base-5)
- thin-wire coaxial cable (10Base-2)

Maintain ENI Connections

The unshielded twisted pair (UTP) patch cable on a switch should be labeled and treated as dedicated. Be careful when moving any cables, as port identity may be effected. If you are using a switch and must move the ENI to a new port for any reason, power-cycle the ENI. The power cycle forces a new Address Resolution Protocol (ARP) sequence which should immediately associate the ENI's IP address with the port it is connected to.

You should also discourage any field personal from treating the ports of a switch as "all the same". This helps to prevent any problems with network communications being effected by moving cables.

RS-232 Port Connections

RS-232 Connector

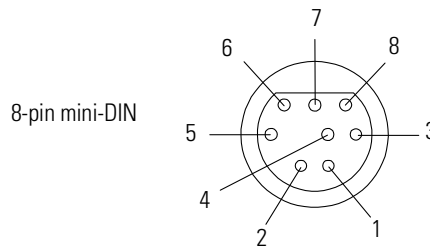

Table 2.1 RS-232 Connector Pin Assignments

Pin	Port 2
1	24V dc
2	ground (GND)
3	no connection
4	ENI input data, RxD
5	no connection
6	no connection
7	ENI output data, TxD
8	ground (GND)

RS-232 Cables

Port 2 of the ENI is an 8-pin mini-DIN RS-232 port that provides connection to DF1 compatible RS-232 devices. The table below describes the RS-232 compatible cables.

ENI Connected to:	Catalog Number	Use Cable
MicroLogix (all series)	1761-CBL-AM00 1761-CBL-HM02	Mini DIN to Mini DIN 45 cm (17.7 in) 2m (6.5 ft.)
SLC 5/03, SLC 5/04, or SLC 5/05 Channel 0	1761-CBL-AP00 1761-CBL-PM02	Mini DIN to D-Shell 45 cm (17.7 in) 2m (6.5 ft.)
PLC-5	1761-CBL-AP00 1761-CBL-PM02	Mini DIN to D-Shell 45 cm (17.7 in) 2m (6.5 ft.)

See page 2-2 for the list of cables that can be used in a hazardous environment.

Operation

This chapter describes ENI operation. The following information is included:

- Operation Overview
- Allocation of Ethernet Connections
- ENI Functional Overview
- Program Upload/Download and On-Line Sessions

Operation Overview

Ethernet is the protocol used to transport TCP/IP messages. On top of TCP, Ethernet/IP is the open protocol used by the ENI. Ethernet/IP allows devices to exchange information (data); or to upload, download, and edit logic programs over Ethernet.

To communicate between devices, Ethernet/IP uses a “connection” model. Connections are dedicated paths across Ethernet between devices.

Allocation of Ethernet Connections

The ENI supports a maximum of 6 connections, allowing simultaneous communication with up to 6 other devices or applications. The connections are dedicated as follows:

Number of Connections	Dedicated to:
2	outgoing messages
2	incoming messages
2	either incoming or outgoing messages

TIP



For peer connections, no more than one connection per destination node is established. If multiple MSG instructions use the same destination node, they use the same connection.

ENI Functional Overview

The ENI provides Ethernet/IP connectivity for RS-232 devices that use DF1 full-duplex protocol. DF1 full-duplex is an open, point-to-point protocol used in any Allen-Bradley controller with an RS-232 port, and in many other devices. DF1 full-duplex supports up to 256 nodes. The ENI uses these nodes for different functions.

The ENI uses a memory (node) map to provide access to the different functions you can perform. Each function uses a different group of node addresses. The following table illustrates the ENI functions by groups of node numbers:

ENI Function	Node Group	Node Function	Valid Data Type	For More Information
Message Routing	Node 100 to 149	Configure Route Address	Integer	see chapter 5
	Node 0 to 49	Route DF1 MSG to IP at Configured Route Address	Integer	see chapter 5
E-Mail	Node 150 to 199	Configure SMTP e-mail address	String	see chapter 6
	Node 50 to 99	Send e-mail message to configured SMTP e-mail address	String	see chapter 6
ENI Configuration	Node 248 to 254	ENI Configuration Registers	Integer or String depending on parameter	see chapter 4

Program Upload/Download and On-Line Sessions

The ENI allows you to connect from your PC to controllers over Ethernet. The following procedure can be used when the computer has a connection directly onto Ethernet (PCI card, PCMCIA interface, built in TCP/IP port, etc.) and the ENI is plugged into the computer's RS-232 (COMM) port.

RSLinx on Ethernet (PC Connected to Ethernet)

IMPORTANT

You must use RSLinx version 2.30.00 or newer to connect with the 1761-NET-ENI.

Follow these steps to configure RSLinx for Ethernet operation.

1. Open RSLinx and open the driver configuration dialog.

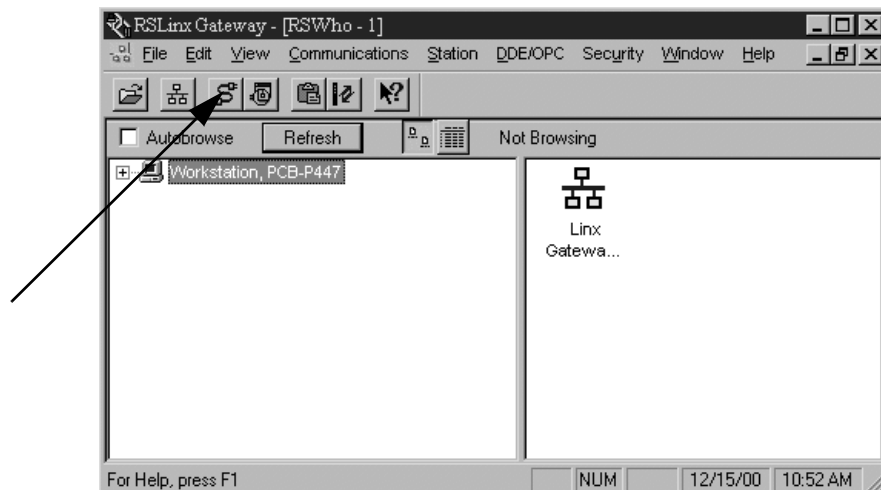

2. The “Configure Dialog” will open, select Ethernet devices from the available drivers, and then click “OK” to load the driver into RSLinx.

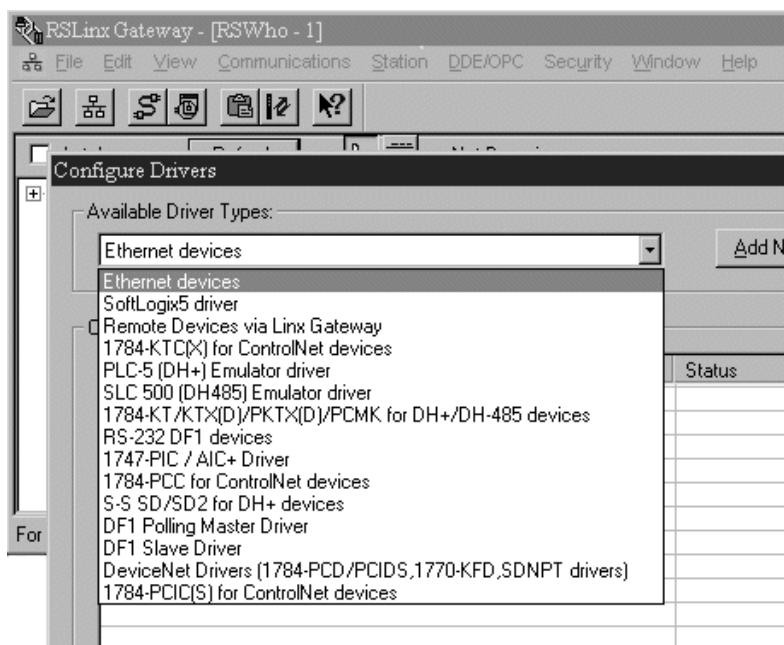

Once the Ethernet driver is loaded, either highlight and select “Configure” or simply double click on the Ethernet driver.

At that point the station mapping screen will appear as illustrated here. Double click on the row below “**Host Name**”, and enter the TCP/IP addresses that match the devices on your network that you will need access to.

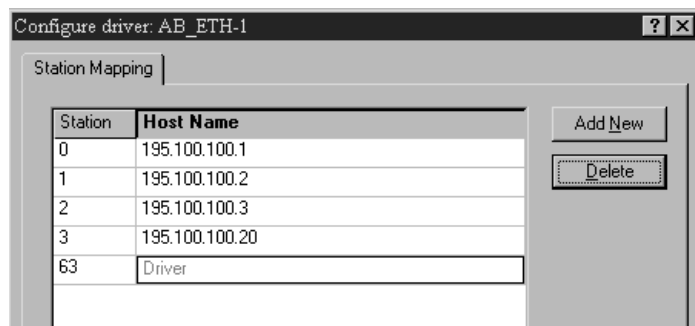

When you are done entering the stations, click OK to close the station mapping window.

- Open the AB_ETH-1 tree on your computer, autobrowse should be running and any active device that you have configured should be shown on the screen as illustrated below.

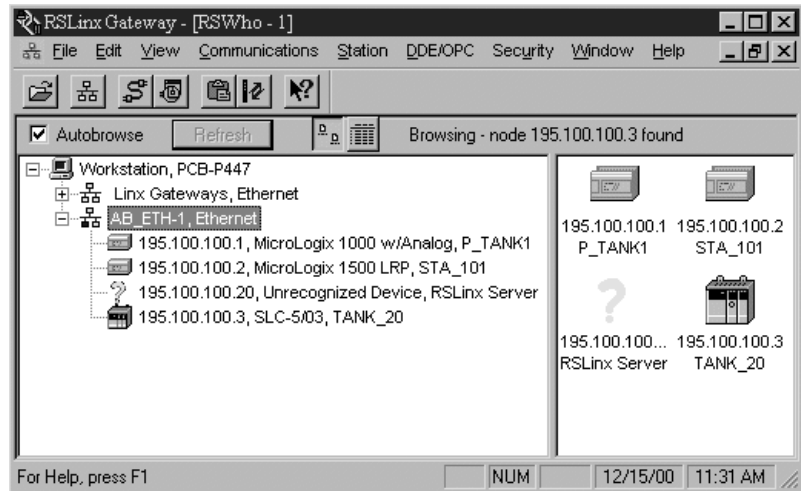

RSLogix 500

- Open RSLogix 500 and select "Comms"

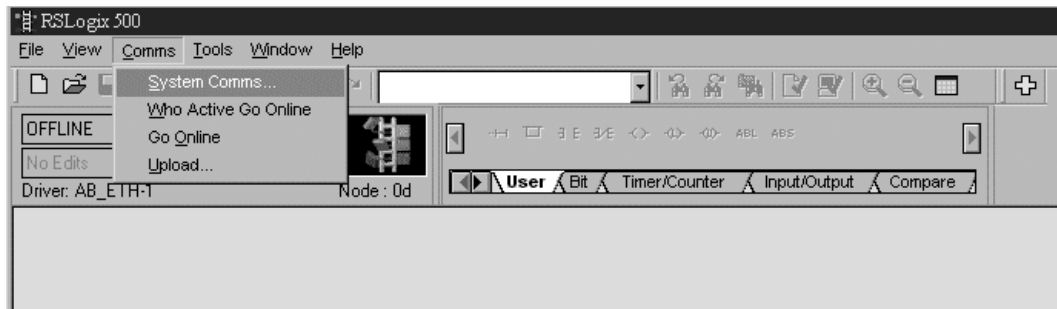

2. Select “AB_ETH-1, Ethernet.

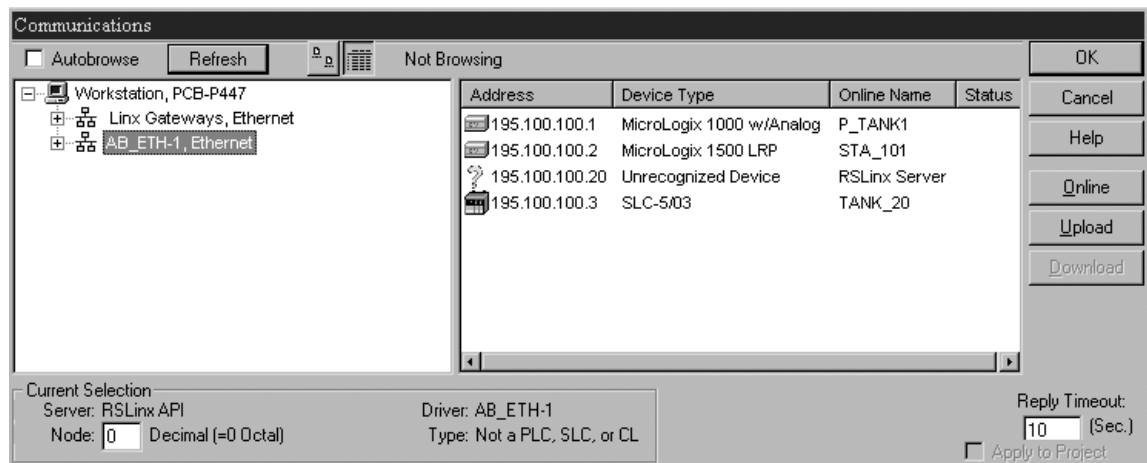

3. Either expand the tree (select the + in the box, or select the device from the table to the right. From this point, you can then either go online or perform an upload or download.

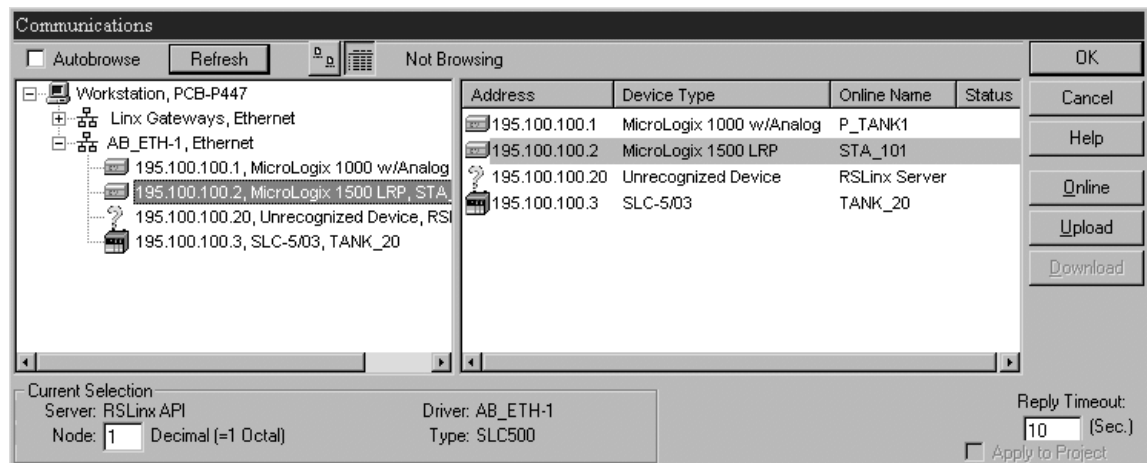

ENI Configuration (Node 248 to 254)

This chapter describes configuration methods and parameters. It is arranged as follows:

- Configuration Methods
- ENI Configuration Utility
- Controller Messaging
- Configuring ENI Data Parameters
- Configuring ENI String Parameters
- ENI Configuration Parameters

Configuration Methods

The ENI's IP information can be entered using either:

- the ENI Configuration Utility
- a write message from the Allen-Bradley controller to node address 250
- the BOOTP Utility over Ethernet (BOOTP configuration is described in Appendix B of this manual)

ENI Configuration Utility

The ENI Configuration Utility is free software designed for configuring the ENI. It is available from <http://www.ab.com/micrologix>.

TIP

When using the ENI Configuration Utility, be sure to use a 1761-CBL-PM02 Series C cable between the ENI and the computer.

COM Port Settings

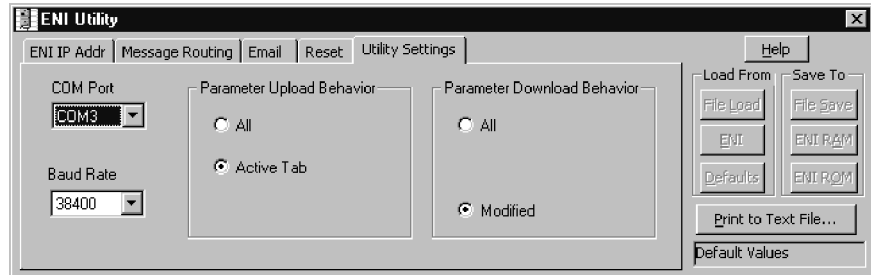

Use the Utility Settings screen to set the following:

- COM Port - The PC's RS-232 port that the communications cable is plugged into.
- Baud Rate - Select a baud rate or choose Autobaud. See page 4-15 for more information.
- Parameter Upload Behavior and Parameter Download Behavior - This setting controls which parameters will be saved or loaded when you use the Load From or Save To buttons.

RS-232 Baud Rate and TCP/IP Parameters

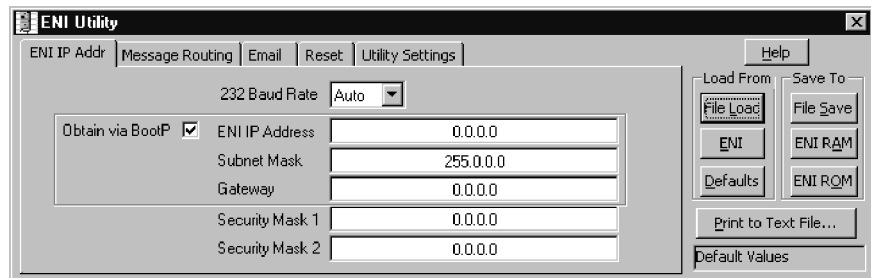

Use the ENI IP Addr screen to set the following:

- 232 Baud Rate - Select a baud rate or choose Autobaud. See page 4-15 for more information.
- TCP/IP Parameters - See page 4-12 for more information on valid addresses.

TIP

If you want to obtain the TCP/IP information via BOOTP, you must do that separately from the ENI Configuration Utility. See Appendix B.

Save to ENI RAM or ENI ROM

You must save the configurations you have set. Click ENI RAM for temporary setups or ENI ROM to permanently save your settings. If you do not save the settings, they will revert to “out-of-box” on the next power-up.

E-Mail Settings

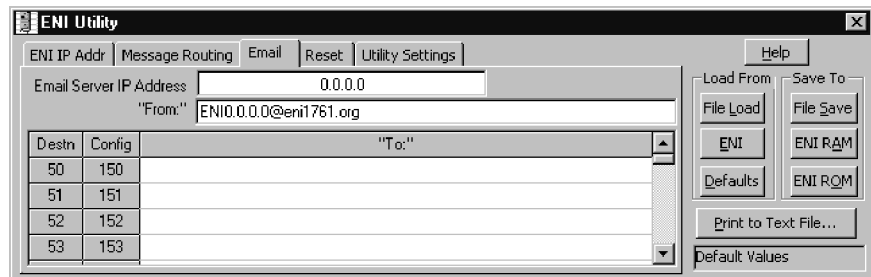

Use the Email screen to fill in the information for e-mail messages. E-mail servers are described on page 4-15. See chapter 6 for information on the “To” and “From” strings.

Message Routing

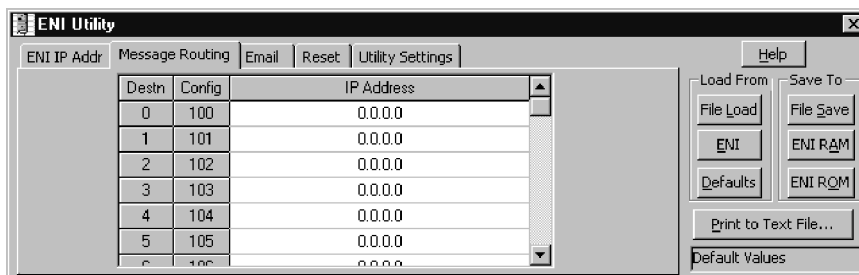

Use the Message Routing screen to fill in the destination addresses for DF1 messaging. Message routing is described in chapter 5.

Reset

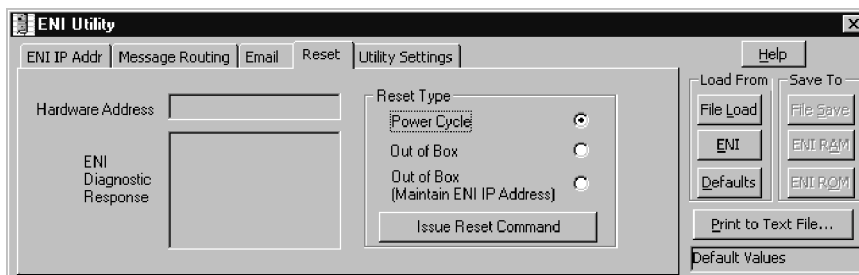

Use the Reset screen to issue reset commands and to set the type of behavior that will occur at reset. The reset behavior options are described on page 4-11.

Controller Messaging

When using this method, a write message is used to configure the TCP/IP configuration parameters. A CIF write message is initiated to the controller. CIF stands for Common Interface File and is supported by all Allen-Bradley programmable controllers that have an RS-232 port.

The first item to configure is the ENI's IP address on your network. See the following section, Configuring ENI Data Parameters, for that configuration procedure.

IMPORTANT

The IP addresses in any of the examples in this manual were arbitrarily assigned and should only be used on an isolated Ethernet network. Contact your system administrator for unique IP addresses if you are connecting your Ethernet devices to your employer's Ethernet network.

The configuration parameters are described in more detail later in this chapter.

Configuring ENI Data Parameters

This example illustrates how to configure the ENI's TCP/IP address (Node 250).



This procedure can also be used for any parameter that requires integer numbers (nodes 50 to 150, 250, 251, 252 and 253).

1. Create an integer data file. Inside the file arrange your TCP/IP data in groups of 4 words (as illustrated in file N50 below).

Offset	0	1	2	3	4	5	6	7	8	9
N50:0	195	100	100	0	0	195	100	100	1	0
N50:10	195	100	100	2	0	195	100	100	3	0
N50:20	195	100	100	4	0	195	100	100	5	0
N50:30	0	0	0	0	0	0	0	0	0	0

Below the table, there are input fields for 'N50:49', 'Symbol', and 'Desc'. A 'Radix' dropdown is set to 'Decimal' and 'Columns' is set to '10'. Buttons for 'Properties', 'Usage', and 'Help' are visible at the bottom.

2. Create your message logic using whatever conditional instructions you may need. In this example, bit B3:0/8 is used to condition the message instruction and message file 10, element 1 is used to manage the message session.

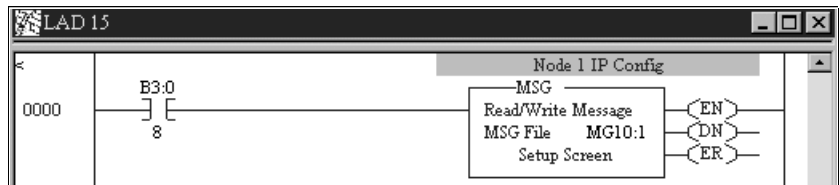

- Open the message instruction and enter the appropriate variables. The variables are described in Table 4.1.

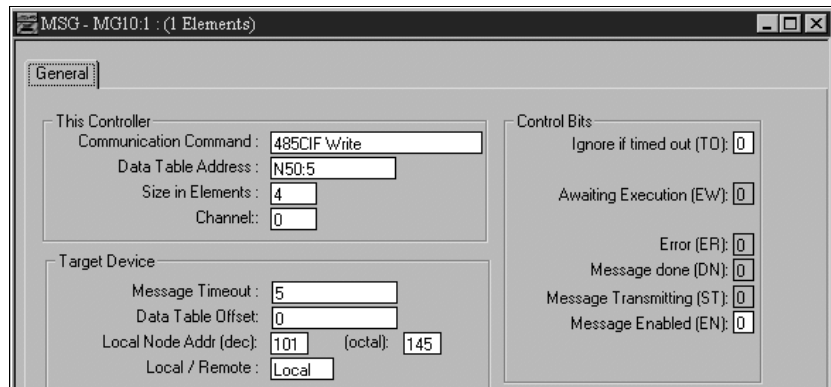

Table 4.1 Message Instruction Variables for Configuring ENI Data Parameters

Variable	Setting
This Controller Parameters:	
Communication Command	For the ENI configuration, this must be set to: <ul style="list-style-type: none"> • 485CIF for MicroLogix and SLC • an unprotected write command for CompactLogix and PLC-5
Data Table Address	In this example we are using integer file 50, element 5 (instruction starts at N50:5).
Size in Elements	For all ENI TCP/IP data configuration, always set this to 4 (4 words).
Channel	The RS-232 communication channel that is connected to the ENI, typically 0 or 1.
Target Device Parameters:	
Message Timeout	Leave this value at the default.
Data Table Offset	Always 0.
Local Node Addr (dec).	This is the destination node address, in this example it is 101.
Local/Remote	Always Local.

- With the controller in Run, initiate the message. The new TCP/IP information is transmitted to the ENI.

ATTENTION



At this point, the new configuration has NOT been saved to permanent memory. See Node 248 information on page 4-11 for instructions.

Configuring ENI String Parameters

Configuring the ENI E-Mail From String

This example illustrates configuring the ENI E-mail From String (Node 249). To configure the E-mail From String, initiate a message with a string element as the data.

EXAMPLE

Node 249 - E-Mail From String

Node 249 holds the ASCII string that will be sent with any e-mail message initiated by the ENI. To configure the E-mail From String, initiate a message with a string element as the data. To do this, follow the procedure below.

TIP

This procedure can also be used for any parameter that requires string data (nodes 150 to 199 and 249).



1. Create a valid string file element as illustrated below. This example has data file 25 configured for string elements. In File ST25, element 0 has a valid e-mail from string, Station_0@My_Company.com.

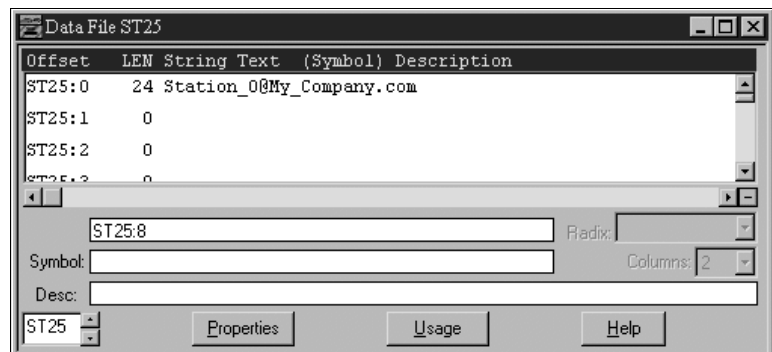

2. Create your message logic using whatever conditional instructions you may need. This example uses bit B3:0/7 to condition the MSG instruction and message file 10, element 16 to manage the message session.

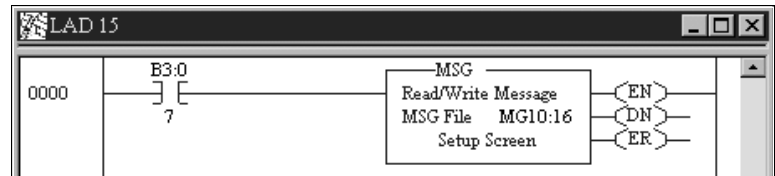

3. Open the message instruction and enter the appropriate variables. The variables are described in Table 4.2.

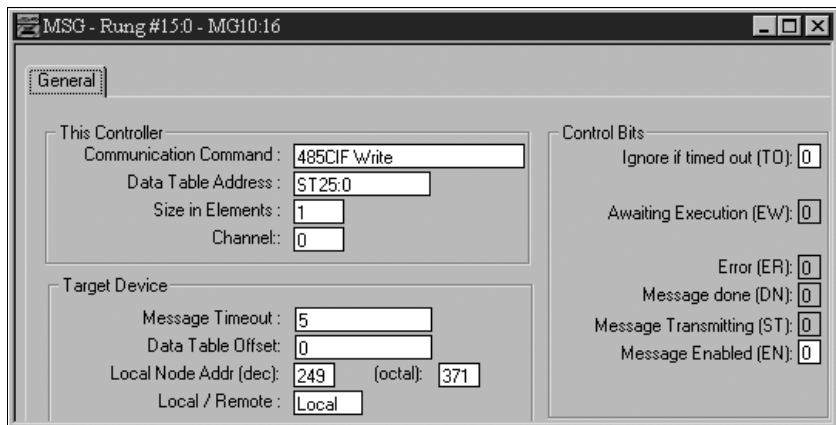

Table 4.2 Message Instruction Variables for Configuring ENI String Parameters

Variable	Setting
This Controller Parameters:	
Communication Command	For the ENI configuration, this must be set to: <ul style="list-style-type: none"> • 485CIF for MicroLogix and SLC • an unprotected write command for CompactLogix and PLC-5
Data Table Address	In this example we are using string file 25, element 0 (ST25:0)
Size in Elements	For all ENI parameters that require a string configuration, always set this to 1.
Channel	The RS-232 communication channel that is connected to the ENI, typically 0 or 1.
Target Device Parameters:	
Message Timeout	Leave this value at the default.
Data Table Offset	Always 0.
Local Node Addr (dec).	This is the destination node address, in this example it is 249.
Local/Remote	Always Local.

ENI Configuration Parameters

The following table shows the functions that nodes 248 to 255 perform and their default values. Descriptions of each function can be found following the table.

Node	Function	Data Type	Number of Elements	Options	Default
248	Save/Reset ⁽¹⁾	Integer	1	0 = save configuration to flash 1 = simple reset 2 = reset to factory defaults 3 = conditional reset	n/a
249	From String	ASCII String	1	ENI Identifier	ENI0.0.0.0@eni1761.org ⁽²⁾
250	TCP/IP Configuration	Integers	4, 8, 12, 16, or 20	TCP/IP Parameters	000.000.000.000
251	E-Mail Server	Integers	4	E-Mail Server Address	000.000.000.000
252	BOOTP Configuration	Integer	1	0 = BOOTP configuration 1 = soft configuration	0
253	Baud Rate ⁽³⁾	Integer	1	See page 4-16.	Autobaud enabled ⁽⁴⁾
254	Ethernet Hardware Address	ASCII String	1	Factory Value	Factory Value - Read Only (see nameplate on unit)
255	Reserved				

(1) See page 4-11 for more information on Save/Reset.

(2) The ENI address, "0.0.0.0" will be replaced by the IP address assigned to the ENI. For example, the string may be ENI191.225.181.52@eni1761.org. If the ENI does not have an assigned IP address, the string will be read as ENI0.0.0.0@eni1761.org.

(3) Changes to the Baud Rate take effect when the ENI power is cycled, or the configuration is saved to flash.

(4) Autodetect of CRC/BCC also occurs when autobaud is selected.

These parameters are described in more detail in the following sections.

Node 248 - Save/Reset Function

Depending on the value of the Save/Reset option, the ENI performs the following operations when receiving a PCCC Unprotected Write message of one element (integer) to Node 248.

Value of Save/Reset	ENI Operation		
0	<p>The ENI immediately stops all normal operations and saves the configuration to non-volatile memory.</p> <table border="1"> <tr> <td>IMPORTANT</td> <td>The ENI may take up to 60 seconds to complete this save operation. The configuration is not permanently saved until the Save command is sent.</td> </tr> </table>	IMPORTANT	The ENI may take up to 60 seconds to complete this save operation. The configuration is not permanently saved until the Save command is sent.
IMPORTANT	The ENI may take up to 60 seconds to complete this save operation. The configuration is not permanently saved until the Save command is sent.		
1	The ENI immediately stops all normal operations and performs a soft reset.		
2	The ENI immediately stops all normal operations, performs a soft reset, and returns all parameters to their "out-of-box" settings.		
3	The ENI immediately stops all normal operations, performs a soft reset, and returns all parameters to their "out-of-box" settings (except for the IP address, Subnet Mask, Gateway ID, and Security Mask).		

Node 249 - From String

Node 249 holds the ASCII string that is sent with any e-mail message initiated by the ENI. Criteria for a valid E-mail From String include:

- The From String remains at the default value unless changed by the user. See page 4-10 for default information.
- The From String must contain an "@" symbol.
- The From String cannot contain any spaces or special ASCII characters.
- The maximum length of the From String is 64 characters. Any additional characters are ignored.
- The From String is sent from a String Table consisting of 84 characters.
- To configure the From String, initiate a message with a string element as the data. The message instruction procedure is shown on page 4-8.

Node 250 - TCP/IP Configuration

This procedure describes configuration for the TCP/IP parameters. The TCP/IP parameters are configured by sending a message instruction to the ENI (or by using the ENI Configuration Utility).

1. Configure a 485CIF write message in the Allen-Bradley controller.

IMPORTANT

Only PLC2 type or 485CIF read/write messages can be used to configure the ENI.

2. Set the destination (target) node to 250. Using node address 250 directs this message to the TCP/IP configuration function.
3. The local integer file must be set up for at least 4 integer locations. The first 4 words define the IP address and are required. All remaining variables are optional.

The table below describes the TCP/IP functions that can be configured. The sections following the table describe the functions in more detail.

Table 4.3 TCP/IP Configuration Parameters

Function ⁽¹⁾	Data Type	Length	Notes
IP Address	Integer	4 words	Format aaa.bbb.ccc.ddd. The ENI verifies the first/highest octet of any IP as follows: <ul style="list-style-type: none"> • The first octet is between 1 and 223 and not equal to 127 or 169 • The first octet is 0, and the entire IP is 0.0.0.0 • otherwise the IP address is treated as an error <p><i>For example, 0.168.0.75 is an error, or 127.0.0.0 is an error.</i></p>
Subnet Mask	Integer	4 words	If not sent, the default mask is derived from the class of the IP address as shown in Table 4-13.
Gateway	Integer	4 words	Only needed if a Gateway is present on the Subnet. The default is 000.000.000.000.
Security Mask 1	Integer	4 words	If not present, the default is no security mask 000.000.000.000.
Security Mask 2			

(1) The IP address must be configured. All other functions are optional.

Subnet Mask

A subnet mask is used to interpret IP addresses when the network is divided into subnets. If your network is not divided into subnets, then leave the subnet mask at the default or allow the ENI Configuration Utility to assign a default.

The subnet mask defaults to auto-detect mode “out-of-box”. As long as the subnet mask is not manually set, the auto-detect mode follows the rules as shown below:

Table 4.4 Subnet Mask Auto-Detect Operation

When the IP Address is set to:	And the Subnet Mask is in auto-detect: The Subnet Mask is set to:
Out of Box: 0.0.0.0	Switch-on auto-detect
Class A address	255.0.0.0
Class B address	255.255.0.0
Class C address	255.255.255.0

Subnet Mask Auto-Detect Rules:

- Reading the subnet mask when the IP address is 0.0.0.0 returns a value of 0.0.0.0.
- When you manually configure the subnet mask, auto-detect is switched off and the configured mask is used.
- The ENI validates the configured subnet mask and if:
 - The first octet is not equal to 255, the ENI returns status 0x10 and reverts to the previous mask, or
 - The first octet is 255, but the remaining mask is not proper, the ENI returns status 0x10 and reverts to the previous mask.
- The definition of “proper” is that the mask must be a contiguous series of 1’s with no zeroes in between (i.e. 255.0.0.0 or 255.224.0.0 or 255.192.0.0 are valid, but 255.160.0.0 is not).

Security Mask

The Security Mask, when configured, allows you to restrict controller access to sources with IP addresses that are within some prescribed range. For example, if you wanted to restrict all message sources to be from within a company’s allocated IP address range, a Security Mask could be configured that would block any IP address outside that range. This only applies to messages to the controller. Web page access, for example, is not restricted.

The security masks default value is 0.0.0.0 out-of-box, which is defined as “accept all register session requests”. A Security Mask of 255.255.255.255 is also defined as “accept all register session requests”.

TIP

The security mask acts as a filter on the source IP address such that any mask octet set to the value of 255 becomes “don’t care” octets in the source IP address and all other fields must match exactly.

The follow examples illustrate the behavior of the security masks:

Table 4.5 Security Mask Behavior

Example Condition		Security Mask Behavior
If a security mask is set to 192.168.15.255	and an IP address 203.129.75. 23 attempts to message into the controller	The packet is rejected because 203.129.75 does not equal 192.168.15 (the 4 th octet, 23, is “don’t care”).
	and an IP address 192.168.15.76 attempts to message into the controller	The packet is processed because the upper 3 octets match (the 4 th octet is still “don’t care”).
If a security mask is set to 192.168.255.76		All source IPs that equal 192.168.xxx.76 are accepted because 255 is “don’t care”.

You can use one or two security masks. If you wish to use only one security mask, use Security Mask 1 because it takes precedence over Security Mask 2 (for example, if Security Mask 1 is accepted, Security Mask 2 is not evaluated). Details of the relationship between the two masks are shown in the following table.

Table 4.6 Using Security Mask 1 and Security Mask 2

Example Condition	Security Mask Behavior
Security masks 1 and 2 are evaluated using the following logic:	
If the security mask 1 filter results in an “Accept” decision	security mask 2 is not evaluated and the register session request is processed.
If the security mask 1 filter results in a “Deny” decision	security mask 2 is evaluated as follows: <ul style="list-style-type: none"> • If the security mask 2 filter results in an “Accept” decision, the register session request is processed • If the security mask 2 filter results in a “Deny” decision, the register session request is not replied to and the socket is closed.

Node 251 - E-Mail Server

The TCP/IP address stored in this location defines the mail server. The ENI sends all e-mail requests to this server, which then sends the e-mail message to the destination.

Node 252 - BOOTP Configuration

The ENI allows the BOOTP request to be disabled by clearing the BOOTP Enable parameter in the channel Configuration File. BOOTP Enable behaves as follows:

- 0 = BOOTP configuration
- 1 = soft configuration

When BOOTP Enable is disabled, the ENI will wait for a manual configuration.

The BOOTP enable/disable setting is only evaluated on power-up. Changes to the BOOTP configuration will not take effect until the next power cycle.

IMPORTANT

If BOOTP is disabled, or no BOOTP server exists on the network, you must use a soft configuration method to enter or change the IP address for each ENI. See page 4-1 for more information.

See Appendix B for information on using BOOTP.

Node 253 - Baud Rate

The first time the ENI is powered-up (out-of-the-box), it is set to Autobaud so that it can synchronize to the attached controller. The baud rate can be changed by sending a message to address 253 with one of the configuration values shown in the table below. Changes to the baud rate take effect when the ENI power is cycled or when a Save configuration to flash command (write to node 248) is received. The configuration value is sent as a 2-byte integer (1 element from an integer file).

The ENI also performs a CRC/BCC check when autobaud is operational. It reads a test PCCC_Diagnostic Status Request to determine if CRC or BCC is being used and adjusts to it.

Table 4.7 ENI Baud Rate Options

Configuration Value (Integer)	Baud Rate
0x0000	Autobaud Enabled
0x0001	1200
0x0002	2400
0x0003	4800
0x0004	9600
0x0005	19.2K
0x0006	38.4K ⁽¹⁾
0x0007	57.6K ⁽¹⁾
8 to 65535	Autobaud Enabled

(1) All CompactLogix devices must be configured to use two stop bits when communicating with the ENI at 38.4K.

IMPORTANT

The ENI cannot Autobaud to 57.6K to synchronize to the attached controller. You must manually set the baud rate to 57.6K. If the controller's baud rate is from 1200 to 38.4K, and the ENI is configured for Autobaud, the ENI will synchronize with the controller's baud rate.

Autodetect of CRC/BCC occurs when autobaud is selected. CRC is used when a fixed baud rate is selected.

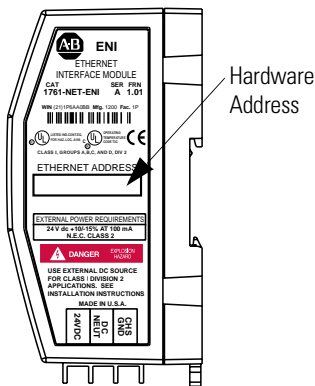

Node 254 - Ethernet Hardware Address

You will find the hardware address on a label affixed to the ENI as shown to the left. The hardware address can also be read from node address 254.

Peer-to-Peer Messaging

This chapter describes messaging between the ENI and DF1 devices. The following topics are covered:

- Messaging Between the ENI and DF1 Devices
- Message to Configuration Nodes (Nodes 100 to 149)
- Sending a Message to a Destination Controller (Nodes 0 to 49)

Messaging Between the ENI and DF1 Devices

The ENI can route a DF1 message received from the attached controller to a compatible destination TCP/IP device.

This is accomplished by using DF1 node addresses 0 through 49. ENI Node addresses 100 through 149 store TCP/IP destination addresses. When the ENI receives a write message to nodes 100 to 149, it stores the TCP/IP destination address in the corresponding map register.

To configure the destination TCP/IP addresses, you can use either the ENI Configuration Utility, or you can send a 485CIF message to each node as described in this section.

The table below illustrates the relationship between messages and their corresponding configuration addresses.

Table 5.1 Message Routing

ENI receives read or write PCCC message to	ENI TCP/IP route configuration	Message forwarded to destination node TCP/IP address
Node 0	Node100	111.222.233.200 (stored at Node 100)
Node 1	Node101	111.222.233.201 (stored at Node 101)

IMPORTANT

When the ENI receives a PCCC write message to a configuration node address (100 through 149), it closes any open communications currently active on that connection and reconfigures the IP address to match the new configuration.

If the received data matches the current configuration, the ENI closes any open communications with the destination device.

If the ENI receives a PCCC read message to any of its configuration addresses (nodes 100 to 149), the ENI responds with the current configuration of that node/address.

Using the configuration shown in Table 5-2; if the controller initiates a read or write message to node 0, the ENI forwards the request to the TCP/IP address at Node 100 (111.222.233.200).

Message to Configuration Nodes (Nodes 100 to 149)

When the ENI receives a message to Node Address 0 to 49, it looks up the TCP/IP address associated with the address at Nodes 100 to 149. The ENI preserves the original DF1 address when sending back a reply.

The following table illustrates the relationship between configuration addresses and their corresponding messaging address.

Table 5.2 Peer-to-Peer Message Routing

Node Number ⁽¹⁾	Function	Node Number	Routing Table	Data Type
0	DF1 Route 0 MSG	100	Route 0 Address	Integer (4 words)
1	DF1 Route 1 MSG	101	Route 1 Address	Integer (4 words)
2	DF1 Route 2 MSG	102	Route 2 Address	Integer (4 words)
3	DF1 Route 3 MSG	103	Route 3 Address	Integer (4 words)
↓	↓	↓	↓	↓
49	DF1 Route 49 MSG	149	Route 149 Address	Integer (4 words)

(1) See IMPORTANT note below about assigning Nodes to various devices.

IMPORTANT

In the ENI, node addresses 45 through 49 are dedicated for sending messages to 1756-ENET/ControlLogix controllers. When sending messages to a 1756-ENET/ControlLogix controller, the controller **MUST** be in slot 0 of the ControlLogix chassis for the message to be delivered to it.

Node addresses 0 through 44 are to be used for all other Ethernet devices, such as other 1769-L20 controllers connected to ENI modules and SLC 5/05 controllers.

To configure the route address (nodes 100 to 149), write a 485CIF message with 4 integer data words. An example is shown in the next section of this chapter.

Sending a Message to a Destination Controller (Nodes 0 to 49)

The ENI uses a pair of node addresses to send data messages over TCP/IP. For data, two sets of addresses are used as illustrated in the table below. Node numbers 100 to 149 are used to define or store the actual TCP/IP address, and nodes 0 to 49 are used to send the data to the destination.

Table 5.3 DF1 Message Routing

ENI Node ⁽¹⁾	Function	ENI Node	Function
0	Route DF1 MSG to IP@address 100	100	Route 0 Address
1	Route DF1 MSG to IP@address 101	101	Route 1 Address
2	Route DF1 MSG to IP@address 102	102	Route 2 Address
3	Route DF1 MSG to IP@address 103	103	Route 3 Address
↓	↓	↓	↓
48	Route DF1 MSG to IP@address 148	148	Route 48 Address
49	Route DF1 MSG to IP@address 149	149	Route 49 Address

(1) See IMPORTANT note below about assigning Nodes to various devices.

IMPORTANT

In the ENI, node addresses 45 through 49 are dedicated for sending messages to 1756-ENET/ControlLogix controllers. When sending messages to a 1756-ENET/ControlLogix controller, the controller **MUST** be in slot 0 of the ControlLogix chassis for the message to be delivered to it.

Node addresses 0 through 44 are to be used for all other Ethernet devices, such as other 1769-L20 controllers connected to ENI modules and SLC 5/05 controllers.

The procedure to send configuration data (nodes 100 to 149), or data (nodes 0 to 49) is exactly the same as discussed previously in “Configuring ENI Data Parameters” on page 4-6.

Open the message instruction and enter the appropriate variables. The variables are described in Table 5.4.

Table 5.4 Message Instruction Variables for Sending a Message to a Destination Controller

Variable	Setting
This Controller Parameters:	
Communication Command	Use any command supported by your controller.
Data Table Address	Use any valid file.
Size in Elements	For all ENI data configuration, always set this to 4 (4 words).
Channel	The RS-232 communication channel that is connected to the ENI, typically 0 or 1.
Target Device Parameters:	
Message Timeout	Leave this value at the default.
Data Table Offset	Always 0.
Local Node Addr (dec).	The destination node address, Nodes 0 to 49.
Local/Remote	Always Local.

E-Mail Messages (Node 50 to 99)

This chapter describes using the ENI's e-mail feature. The following topics are included:

- Overview
- Configuring E-Mail
- Sending an E-Mail Message

Overview

The ENI is capable of transmitting e-mail messages generated by the attached controller. This provides an extremely versatile mechanism to report alarms, status, and other data-related functions.

To send an e-mail message, the controller generates a write message, with a string element as the data, to a node number that correlates to the e-mail destination address. ENI e-mail behavior in a system is described by the following diagram.

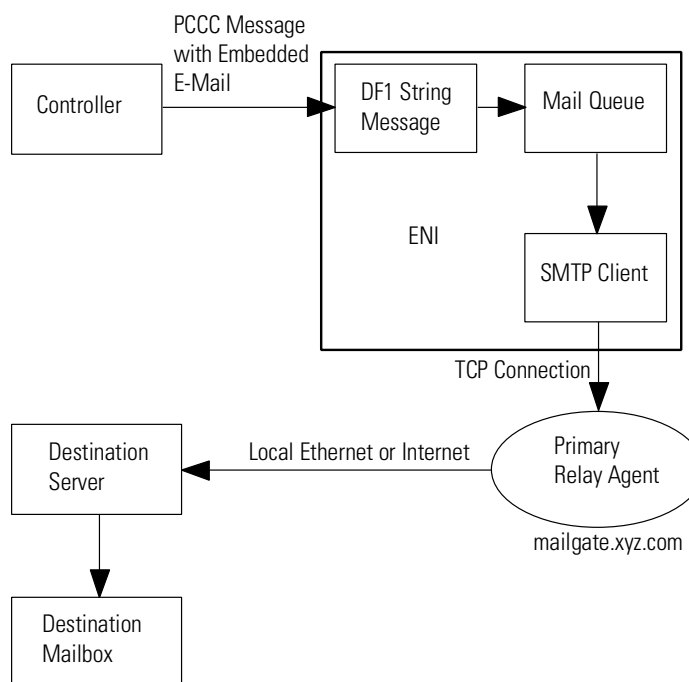

Configuring E-Mail

SMTP E-Mail Address

To configure the e-mail function, two parameters must be configured:

- SMTP mail server IP address - configured by sending a write message to node 251 (e-mail server). See page 4-15 for more information.

IMPORTANT

The ENI only accepts the configuration in the form of 4 elements (words) from an Integer file.

- A “From” String - configure by sending a write message to node 249 (from string). The string element text can be stored in a String File as shown below. The string element text (ASCII characters) contains the verbatim “from” string. See page 4-8 for more information.

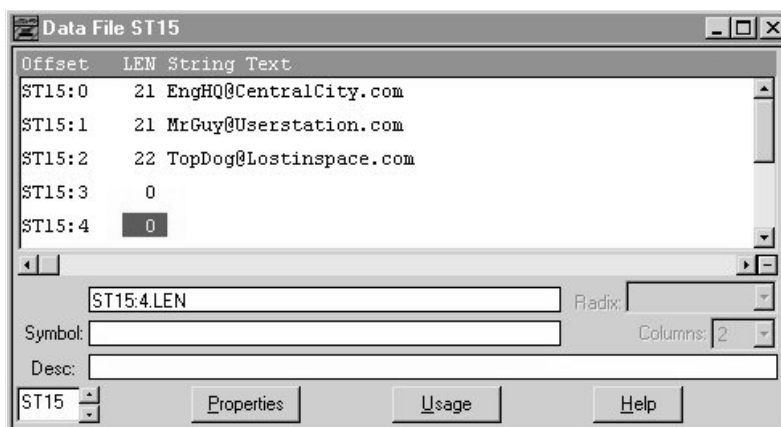

Destination Addresses

The ENI stores e-mail addresses; it does not store the e-mail messages. To store a destination address, write a message to a specific node number (nodes 150 to 199). The message data must be a string element that contains a valid e-mail ASCII text string address, as illustrated in ST15:0 through ST15:5 in the example below.

Offset	LEN	String	Text
ST15:0	0		
ST15:1	0		
ST15:2	23	scadagroup@rockwell.com	
ST15:3	28	process_support@rockwell.com	
ST15:4	29	PLC_tech_support@rockwell.com	
ST15:5	25	Eng_support@mycompany.com	
ST15:6	0		
ST15:7	50	Alarm, Station 7, Tank3 High Pressure, [I1:3.2]psi	
ST15:8	50	Alarm, Station 7, Tank2 High Pressure, [I1:3.1]psi	
ST15:9	40	Alarm, Station 7, Low Flowrate in Tube 1	

IMPORTANT

Remember the following when setting up destination addresses:

- The ENI can store up to 50 e-mail addresses.
- E-mail addresses can be up to 45 characters long, exceeding this will result in an error.
- The e-mail address must contain an “@” character.
- E-mail addresses cannot contain any spaces or any other special ASCII characters other than the “@” character.

Message Text

To send the actual e-mail message, the controller generates a write message, with a string element as the data (see ST15:7 to ST15:9 in the example above) to a node number (50 to 99) that correlates to the e-mail address (150 to 199).

The following table shows the relationship between the e-mail message and the e-mail address. The maximum size of the message is 1 string element of 84 bytes.

E-Mail Message	E-Mail Address Configuration	Description
Node 50	Node 150	The data within the message is sent to Node 50 and forwarded to the e-mail address stored at Node 150.
Node 51	Node 151	The data within the message is sent to Node 51 and forwarded to the e-mail address stored at Node 151.
Node 52	Node 152	The data within the message is sent to Node 52 and forwarded to the e-mail address stored at Node 152.
↓	↓	↓
Node 98	Node 198	The data within the message is sent to Node 98 and forwarded to the e-mail address stored at Node 198.
Node 99	Node 199	The data within the message is sent to Node 99 and forwarded to the e-mail address stored at Node 199.

IMPORTANT

The ENI does not support non-printable ASCII characters and may exhibit unpredictable behavior when these characters are used in an e-mail message. Avoid using non-printable ASCII characters such as Carriage Return, Line Feed, Tabs, etc.

Message Fields (to, from, subject)

The ENI includes the “to”, “from”, and “subject” fields in the body of the message.

The default “from” text is ENI0.0.0.0@eni1761.org. This can be changed in the ENI configuration, Node 249. See page 6-2 or Chapter 4.

The standard format of the “subject” line is:

Subject: 1761ENI.MSG(*plus the first 32 characters of text*)

For example, if the message text was “The quick brown fox jumped over the lazy dog’s back”, the “subject” line would read:

Subject 1761ENI.MSG(The quick brown fox jumped over)

Sending an E-Mail Message

The ENI uses a pair of node addresses to send e-mail or data messages over TCP/IP. To send e-mail, two sets of addresses are used as illustrated in the table below. Node numbers 150 to 199 are used to define or store the actual e-mail address, and nodes 50 to 99 are used to send the string element to the e-mail recipient.

E-Mail				
Node #	SMTP		Node #	String file data
50	e-mail message		150	e-mail Address
51	"		151	"
52	"		152	"
	"			"
99			199	ASCII String

TIP



The procedure to send configuration strings (nodes 150 to 199), or message strings (nodes 50 to 99) is exactly the same as discussed, "Configuring ENI String Parameters" on page 4-8.

1. Start by configuring a MSG instruction.

The screenshot shows the configuration window for a MSG instruction. The fields are as follows:

- This Controller:**
 - Communication Command: 485CIF Write
 - Data Table Address: ST15.5
 - Size in Elements: 1
 - Channel: 0
- Target Device:**
 - Message Timeout: 5
 - Data Table Offset: 0
 - Local Node Addr (dec): 50 (octal): 62
 - Local / Remote: Local
- Control Bits:**
 - Ignore if timed out (TO): 0
 - Awaiting Execution (EW): 0
 - Error (ER): 0
 - Message done (DN): 0
 - Message Transmitting (ST): 0
 - Message Enabled (EN): 0
- Error:**
 - Error Code(Hex): 0

2. Open the message instruction and enter the appropriate variables. The variables are described in Table 6.1.

Table 6.1 Message Instruction Variables for Sending an E-Mail Message

Variable	Setting
This Controller Parameters:	
Communication Command	Use any command supported by your controller.
Data Table Address	Any valid string, such as ST25:21 as shown below.
Size in Elements	1
Channel	The RS-232 communication channel that is connected to the ENI, typically 0 or 1.
Target Device Parameters:	
Message Timeout	Leave this value at the default.
Data Table Offset	Always 0.
Local Node Addr (dec).	This is the destination node address. Nodes 50 to 99 send e-mail messages.
Local/Remote	Always Local.

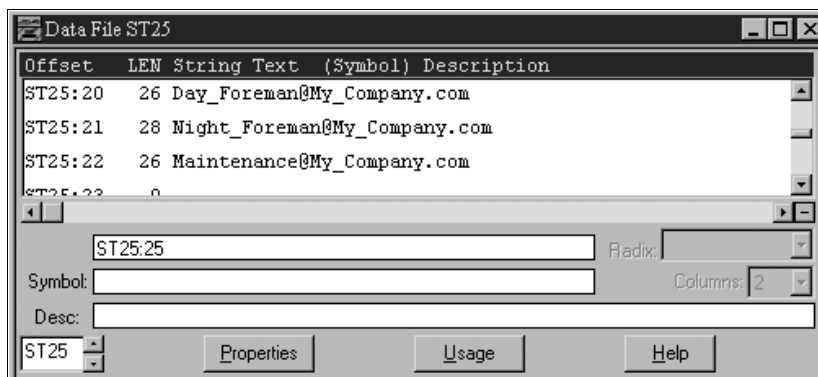

Connecting 1769-L20 CompactLogix Controllers on Ethernet

The chapter contains an example of using the ENI on an Ethernet network. It is arranged as follows:

- System Diagram
- Purpose
- Scope
- General Ethernet Information
- Configuring 1761-NET-ENI #1
- Configuring 1761-NET-ENI #2
- Configure RSLINX and Download The Program To The 1769-L20
- Create MSG Programs for the SLC 5/05 and the 5550 Controllers
- Configuring an Ethernet Driver in RSLINX

System Diagram

Figure 7.1 Example Network

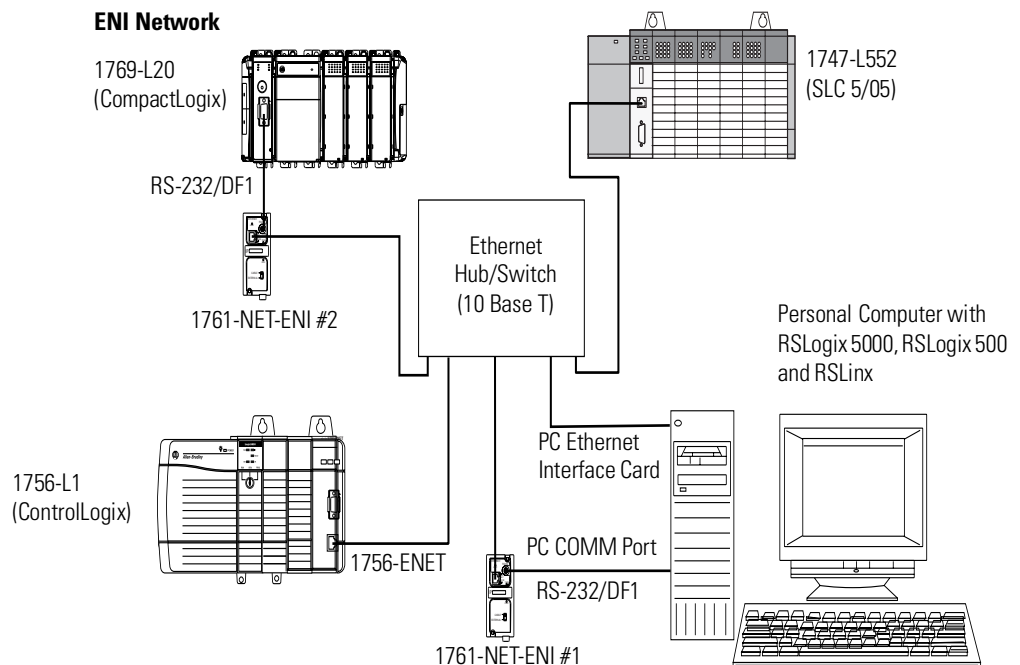

The computer must include the following software:

- RSLOGIX5000, version 7.00 or later
- RSLINX, version 2.30.00 or later
- RSLOGIX500
- ENI Configuration Tool

The 1769-L20 controller must contain firmware 7.17 or later.

The Ethernet Interface Card in the computer is used to connect directly to the SLC 5/05 controller (channel 1) and to the 5550 controller via the 1756-ENET card. The computer COMM Port is used to connect to the 1769-L20 controller via the 1761-NET-ENI modules and an Ethernet hub/switch.

Purpose

Provide Ethernet connectivity for 1769-L20 CompactLogix controllers via the RS-232 serial port and the 1761-NET-ENI module.

Scope

Connecting 1769-L20 controllers on Ethernet requires one 1761-NET-ENI per L20 controller. The ENI converts RS-232 hardware connections and DF1 full-duplex protocol to Ethernet, TCP/IP.

The ENI must be configured with IP addresses assigned to node numbers 0 to 49. The Destination Node Address in DF1 messages is then used by the ENI to route the message to the proper device on Ethernet.

This application example will show how to configure the ENI module and how to send messages from the 1769-L20 controller to the other Controllers on Ethernet. This example will also show how to initiate messages from the Ethernet controllers to the L20 controller. Messages sent to the ENI module's IP address will be delivered to the serial port of the L20 controller.

TIP



In the ENI, node addresses 45 through 49 are dedicated for 1756-ENET/ControlLogix controllers. Node addresses 0 through 44 are to be used for all other Ethernet devices, such as other 1769-L20 controllers connected to ENI modules and SLC 5/05 controllers.

General Ethernet Information

Each Ethernet device requires a unique IP address. If your Ethernet network is isolated from the company-wide network, any valid IP addresses may be used. If your Ethernet hub is connected to a larger Ethernet network, contact your System Administrator for unique IP addresses. For this example, the following IP addresses will be assigned to the various Ethernet devices on our network:

Table 7.1 Example Network IP Addresses

IP Address	Device
131.200.50.92	SLC 5/05 controller
131.200.50.93	1756-ENET
131.200.50.94	1761-NET-ENI #2 (1769-L20 controller)
131.200.50.95	1761-NET-ENI #1 (computer COMM port)
131.200.50.96	computer's Ethernet card

The subnet mask for each Ethernet device is then, 255.255.0.0.

IMPORTANT

The RS-232/DF1 interface between the L20 controller and its ENI module, and between the computer (RSLOGIX5000/RSLINX) and its ENI module, should use 38400 baud. This will allow fast upload/download of programs.

When using 38400 baud, the number of Stop Bits in RSLINX and in the L20 controller must be set to 2.

Rungs 0 and 1, shown in Figure 7.2, of the 1769-L20 controller's ladder program show an example of throttling two message (MSG) instructions. In this case, sending a MSG to the SLC 5/05, and then when it's Done, initiating a MSG to the 1756-ENET/5550 controller and so on. The two MSG Instructions will toggle, with only one outstanding MSG at a time.

This is recommended for the 1769-L20 controller to keep the amount of user memory needed for incoming and outgoing messages to a minimum. Each message requires approximately 1.1K bytes of user memory, allocated when the message is to be sent or received. If two messages were enabled at the same time, 2.2K bytes of user memory would need to be available.

Figure 7.2 Throttling Message Instructions

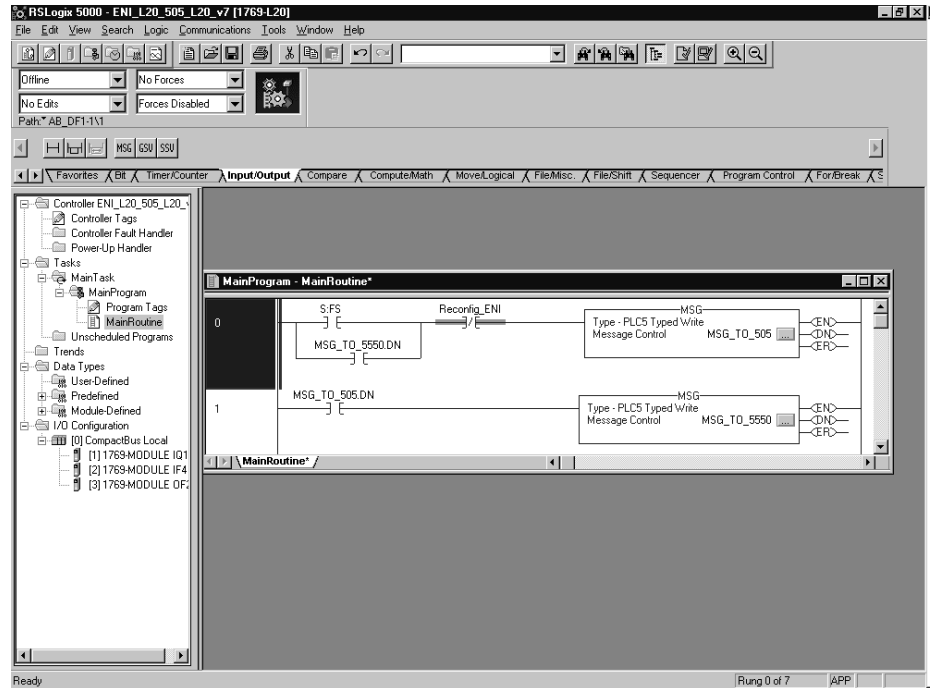

Configuring 1761-NET-ENI #1

Refer to Chapter 4 of this manual for information on how to obtain the free ENI Configuration Software Tool.

The first task is to configure the ENI module that will be connected to the computer. This is ENI #1 per Figure 7.1. A 1761-CBL-PMO2 serial cable is used to connect a computer serial communication port to the RS-232 mini-din serial port on the ENI. The ENI Configuration Tool will be used to configure this ENI. Double click the “eniutiCE.exe” icon on your desktop to start the ENI configuration tool. The following screen should appear:

Figure 7.3 ENI Configuration Tool ENI IP Addr Screen

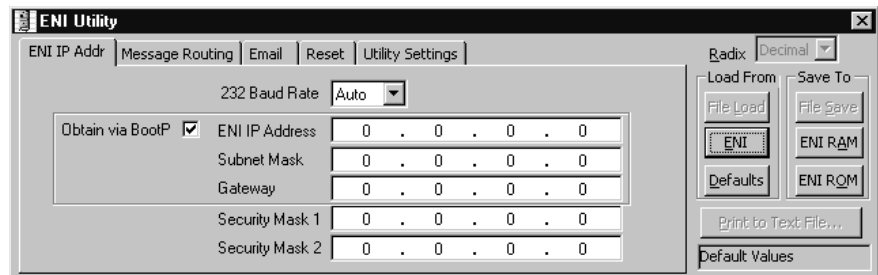

For this example, we will be using 38400 baud on all serial connections. We will also assign IP addresses to all Ethernet products rather than using BOOTP.

Two tabs in the ENI software tool must be modified for the purposes of this example, the “ENI IP Addr” tab and the “Message Routing” tab. The IP address for the ENI connected to the 1769-L20 controller (ENI #2) is the only address we need to add to the ENI #1 Message Routing table. The other two Ethernet devices are accessed by the computer via the computer’s Ethernet card. Make the two ENI #1 tabs look like the following:

Figure 7.4 ENI #1 Configuration - ENI IP Addr Screen

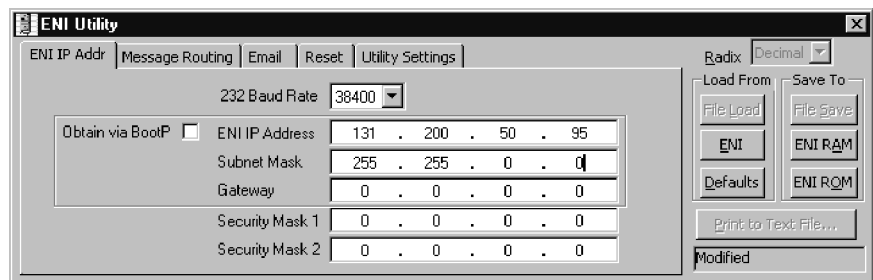
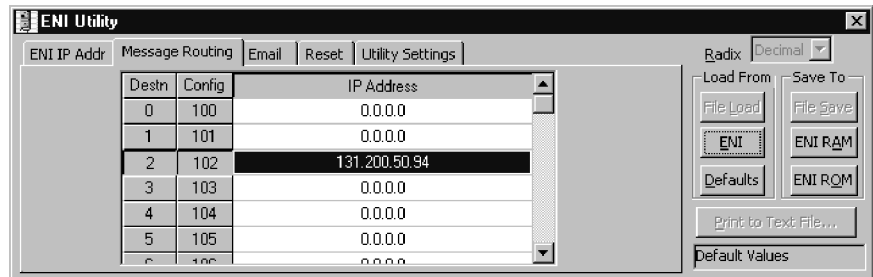
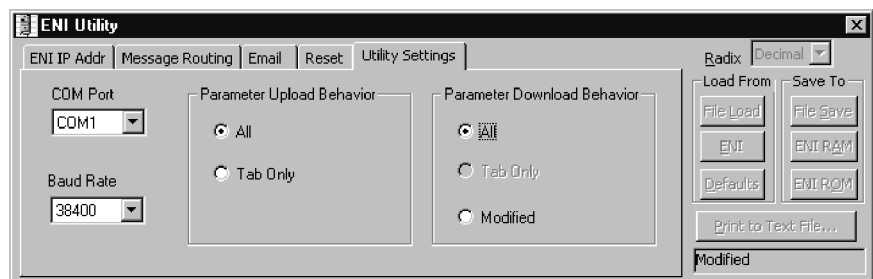

Figure 7.5 ENI #1 Configuration - Message Routing Screen



Before we download our configuration to ENI #1, we must configure the “Utility Settings” tab in the ENI configuration tool. Make this tab look like the following.

Figure 7.6 ENI #1 Configuration - Utility Settings Screen



Then, connect the serial cable between your computer and ENI #1 and click on the ENI IP Addr tab. From this tab, under the “Save To” column, click the ENI ROM button. This will download your configuration parameters to ENI #1 and save it to non-volatile memory.

Configuring 1761-NET-ENI #2

ENI #2 is connected to the L20 controller. This ENI must be configured with its own IP address (131.200.50.94 for this example) and we must add the IP addresses of the SLC 5/05 controller and the 1756-ENET/5550 controller to its Message Routing table. The Message Routing table allows for up to 50 IP addresses to be linked to DF1 destination node addresses, for the following purposes:

Table 7.2 Message Routing

Nodes	Function
Nodes 0 to 44	When sending messages to any Ethernet device, other than ControlLogix, that supports the same command set as the 1769-L20 controller, i.e. SLC 5/05, PLC-5E and other ENI modules. We will use the PLC-5 Typed Write commands for this example. CIP commands are not supported by the ENI.
Nodes 45 to 49	When sending messages to a 1756-ENET/ControlLogix Controller, the controller MUST be in slot 0 of the ControlLogix chassis for the message to be delivered to it.

At this point we could merely configure ENI #2 as we did ENI #1. Or, we could use the method outlined in Chapter 5 to configure ENI #2. This method sends configuration Messages from the L20 controller via the DF1 link. If for any reason this ENI would need to be replaced, it could then be easily and quickly configured via messages from the L20 controller. A ladder program to accomplish this is as follows:

Figure 7.7 ENI #2 Configuration - RSLogix 5000 Ladder Program

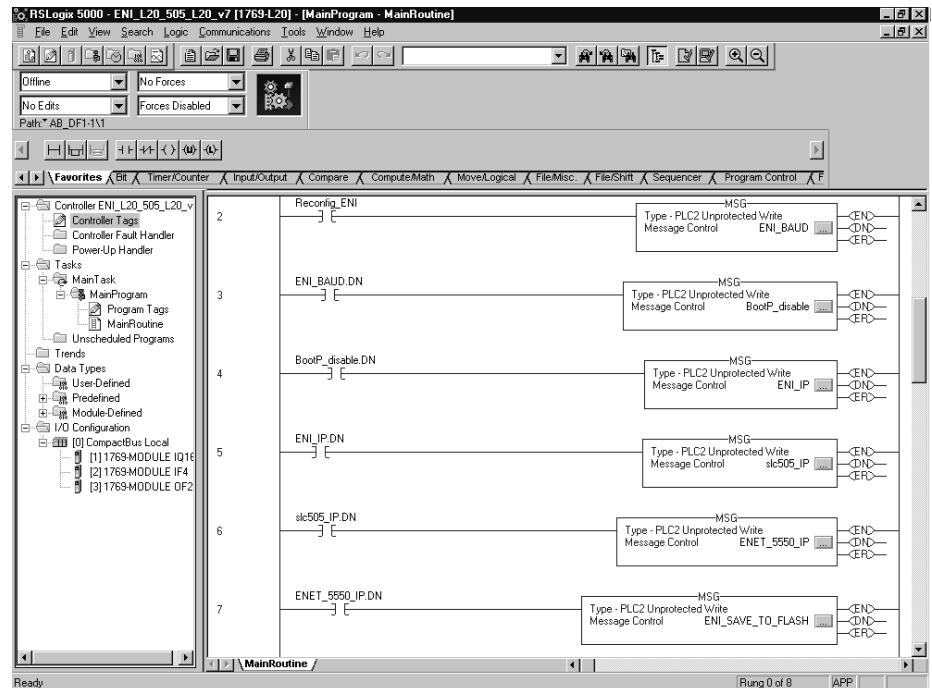

The above ladder rungs, 2 through 7 and the rungs, 0 and 1 shown earlier in this application example, make up the ladder program for the L20 controller. Details of each MSG Instruction will follow.

In the above program, Rung 2 initiates the string of configuration messages with input instruction “Reconfig_ENI”. This could be an alias to an input connected to a pushbutton for example, for quick configuration of the ENI module.

The 5 rungs used to configure ENI #2 are defined as follows:

Table 7.3 ENI #2 Configuration - Rung Descriptions

Rung	Function
Rung 2	This rung initiates the process and configures the ENI module's Serial port for 38400 Baud.
Rung 3	This rung is initiated by the Done bit of the previous MSG and it disables BOOTP.
Rung 4	This rung configures the ENI with its own IP address.
Rung 5	This rung adds the IP address of the SLC 5/05 controller to the ENI module's Message Routing table at DF1 node 1. This means that any message sent by the -L20 controller with a DF1 destination address of 1, will be sent to the SLC 5/05 controller on Ethernet.
Rung 6	This rung adds the IP address of the 1756-ENET module to the ENI module's Message Routing table at DF1 node 45. This means that any message sent by the -L20 controller with a DF1 destination address of 45, will be sent to the 5550 controller in slot 0, via the 1756-ENET module on Ethernet.
Rung 7	This rung instructs the ENI module to save the configuration data sent to it in non-volatile memory.

The following table contains the information needed to send messages to the ENI to configure it for this example. For a complete list of ENI configurable features, please refer to Chapters 4 and 5.

Table 7.4 ENI #2 Configuration - Message Instructions Parameters

Configuration Node Number	Configuration Function	Data Type	Message Node Number	Message Length (bytes)	Message Function
101	Configure Route 1 Address	Integers	1	8	Route DF1 MSG to IP at Address 1
145	Configure Route 45 Address	Integers	45	8	Route DF1 MSG to IP at Address 2
248	Save/Reset	Integer	N/A	2	0 = save configuration to flash
250	TCP/IP Config.	Integer	N/A	8	Assign an IP Address to the ENI
252	BOOTP	Integer	N/A	2	1 = disable BOOTP
253	Baud Rate	Integer	N/A	2	6 = 38400 Baud

For this example, as mentioned earlier, we will assign the following IP addresses to the devices on Ethernet:

Table 7.5 Example IP Addresses for Ethernet Devices

Device	Node Address (for L20 MSG)	IP Address
SLC-5/05	1	131.200.50.92
1756-ENET	45	131.200.50.93
1761-NET-ENI #2	N/A	131.200.50.94
1761-NET-ENI #1	N/A	131.200.50.95
Computer Ethernet Card	N/A	131.200.50.96

IMPORTANT

The IP addresses in Table 2 were arbitrarily assigned for this demonstration and should only be used on an isolated Ethernet network as in this example. Contact your system administrator for unique IP addresses if you are connecting your Ethernet devices to your companies Ethernet network.

The Message Instructions for the L20 controller, Rungs 2 through 7, used to configure the ENI module, must be “PLC2 Unprotected Write” Message Type. The “Destination Element” can be any valid PLC2 command value. “010” is used in this example because it is the first available valid value. This parameter is not used by the ENI, but must be a valid value for RSLOGIX5000 to accept it.

An example of the MSG Configuration tab and the Communication tab for the MSG Instruction used to configure the IP address for the ENI (Rung 4) are as follows:

Figure 7.8 ENI #2 Configuration - Message Configuration Tab

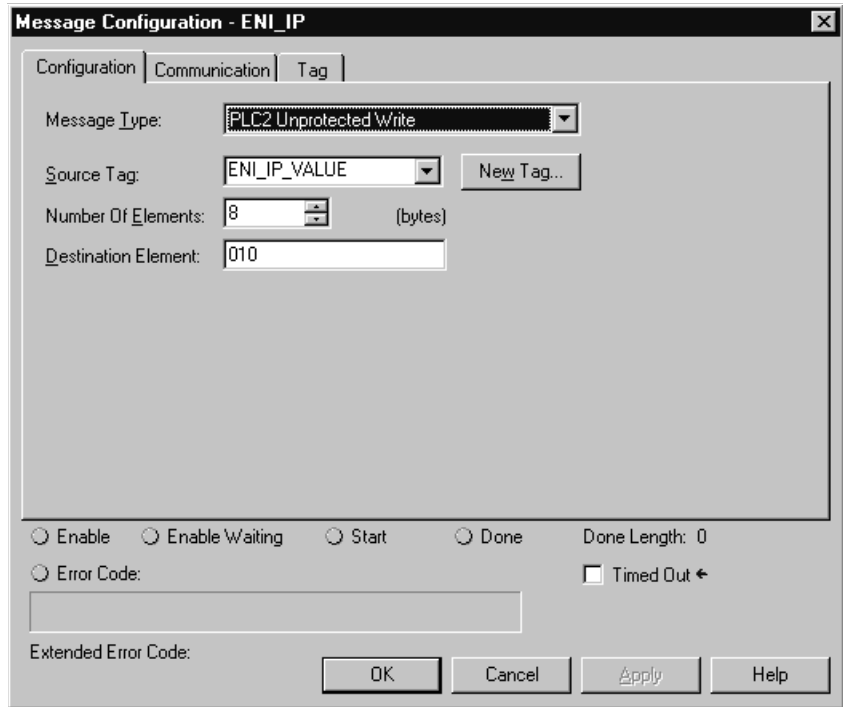
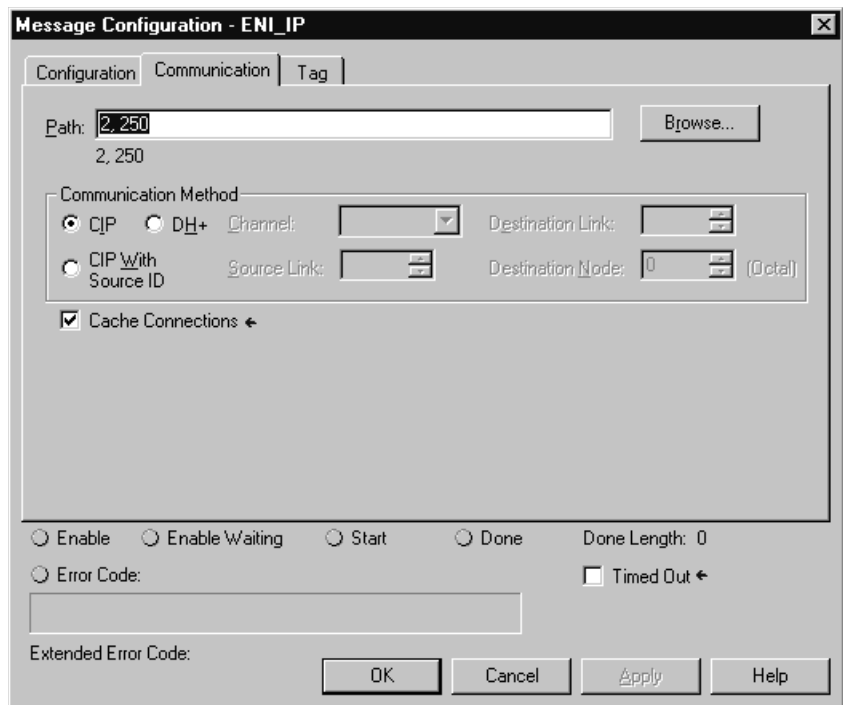

Figure 7.9 ENI #2 Configuration - Message Communication Tab



Note that the MSG length is 8 bytes or 4 integer words. These 4 words contain the IP address for ENI #2 and are stored in tag ENI_IP_VALUE, which is a tag address containing 4 integer words. This is shown in

the L20 controller's tag database shown below. On the MSG Instruction's Communication tab above, the path is "2,250", where the 2 represents the L20 controllers serial port and the 250 tells the ENI module that the 4 words of data contain its IP address.

Figure 7.10 L20 Controller's Tags

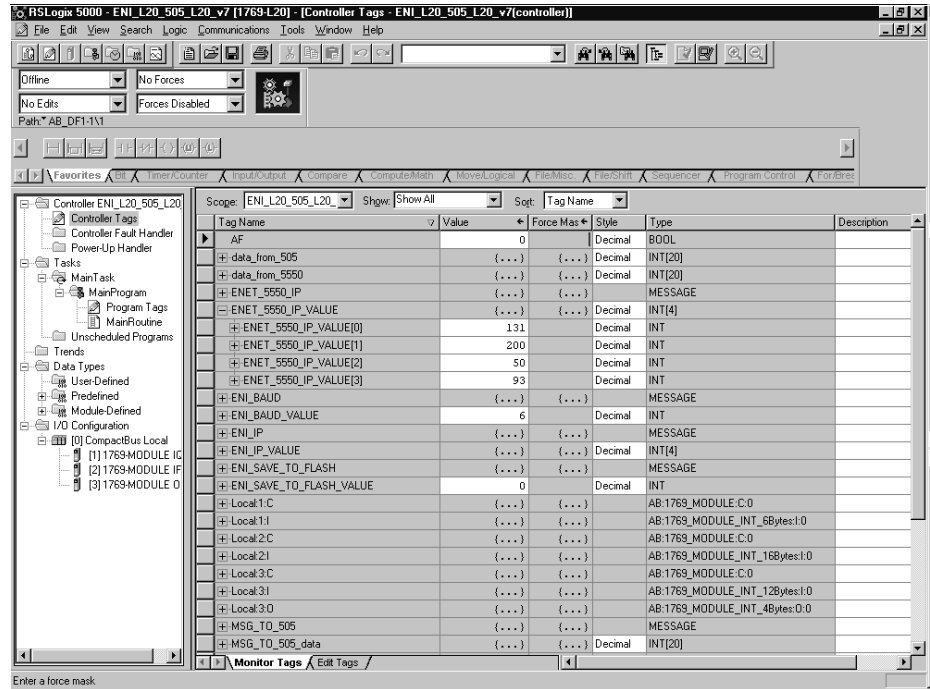

Per Table 7.4, The MSGs in Rungs 2, 3 and 7 are 2 bytes or 1 integer word in length. Their Paths are "2,253", "2,252" and "2,248" respectively; where 253 represents Baud Rate, 252 represents BOOTP Enable/Disable, and 248 represents the Save function.

The single integer data value for these messages is shown in Table 7.4. "0" is the value for the Save MSG data tag (ENI_SAVE_TO_FLASH_VALUE), which instructs the ENI to save its configuration to non-volatile memory. "6" is the value for the Baud Rate MSG data tag (ENI_BAUD_VALUE) which instructs the ENI to begin communicating on its RS-232 port at 38400 Baud. "1" is the value to disable BOOTP (BootP_disable_value).

Per Table 7.4, The MSGs in Rungs 5 and 6 assign IP addresses to node numbers in the ENI module's Message Routing Table. These two MSG Instructions are the same as the MSG Instruction in Rung 3, except the paths are 2,101 and 2,145 and the data tags have different names; this time containing the IP addresses of the SLC 5/05 and 1756-ENET module.

Enter your 1769-L20 ladder program per Rungs 0 through 7 as shown and described above. Be sure to enter your IP addresses for ENI #2, the SLC 5/05, and the 1756-ENET into the proper tags in the controller's tag database. Before saving your program, enter the Controller Properties window by clicking on the Edit pull-down menu and select Controller Properties. Click on the System Protocol tab and change Error Detection from BCC to CRC and the Baud Rate from 19200 to 38400. Click APPLY, then OK. The ENI modules use CRC Error Detection.

If you do not change this parameter in your -L20 controller, it will not be able to communicate with the ENI. The Baud Rate of 38400 is being used to increase the upload/download speed.

Finally, since Logix controllers do not use the structured data table addressing scheme used by PLC and SLC controllers, we must map file numbers used in the commands sent to any Logix controller to tag names within them. For example, a MSG sent by an SLC 5/05 controller to the L20 controller uses a PLC-5 Typed Write command. The target data table address used is N12:0. This file 12 must be mapped to a valid tag name in the L20. Since the MSG is 20 integer words in length, a tag in the L20 controller called "Data_From_505" was created as a 20 integer word tag.

While offline in the L20 controller project, click on the Logic pull-down menu and select "Map PLC/SLC Messages". The following screen appears:

Figure 7.11 File Mapping in RSLogix 5000

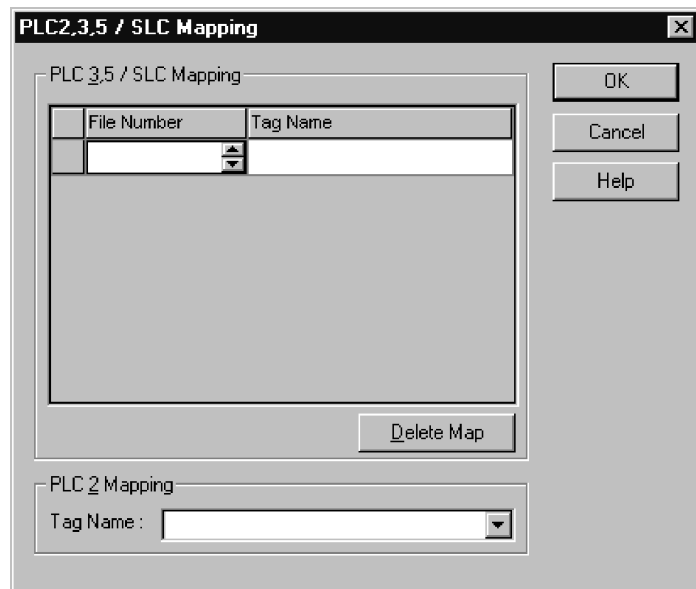

In the File Number column enter 12. Under the Tag Name, click on the right side in the white box to reveal your Controller Tags and select the tag name you created for this purpose (“Data_From_505” for this example). More than one entry may be mapped. When finished, your Map PLC/SLC screen for the L20 controller should look like the following:

Figure 7.12 File Mapping for the L20 Controller in RSLogix 5000

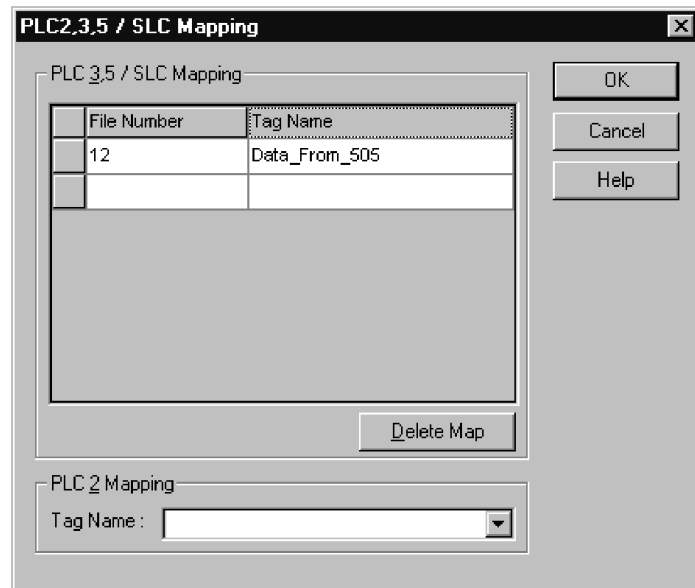

Save your program.

Configure RSLINX and Download The Program To The 1769-L20

The ladder program written for the L20 controller is downloaded to the controller via the two ENI modules. A full-duplex DF1 driver must be configured in RSLINX to initiate the download to ENI #1.

Start RSLINX. From the “Communication” pull down menu, select “Configure Drivers”. From the Configure Driver screen, click on the arrow next to the “Available Drivers Box” to reveal all RSLINX drivers. Click on “RS232 DF1 devices”, then click on “Add New”. Click OK to the “AB_DF1-1” driver name that appears. The “Configure RS232 DF1 Devices” screen appears. Modify the DF1 parameters on this screen to look like the following:

Figure 7.13 Modify DF1 Parameters Using RSLinx



It is very important that the “Station Number” match the “Destn” number in ENI #1, assigned to the IP address for ENI #2. In this example, we arbitrarily used Destn address 2 to represent IP address 131.200.50.94, which is the IP address of ENI #2.

DO NOT click on the “Auto Configure” button on this screen.

When you have properly modified the parameters on this screen, click OK. Then close the Configure Drivers screen.

Open the WHO Active screen by clicking on the Communications pull-down menu and select Who Active. If your system is properly connected, you should be able to click on the + sign left of the AB_DF1-1 driver you created and the CompactLogix controller should appear beneath the driver. Minimize, but do not close RSLINX.

Start RSLOGIX5000. Open the 1769-L20 program created earlier. Click on the Communications pull-down menu and select Who Active. From the Who Active screen. Click on the + sign left of “AB_DF1-1, DF1”. The CompactLogix controller should appear. Single-click on it to highlight it, then click Download. Your program should download to the controller. You should be online with the controller when the download is complete. The software will soon time out, placing your computer in the offline mode. At this point, if you are still online, you may click on the Communications pull down menu and select offline. Online monitoring of the -L20 controller via two ENI modules is not supported at this time.

Create MSG Programs for the SLC 5/05 and the 5550 Controllers

We must now create MSG ladder programs for our other two controllers on Ethernet. The following is the MSG ladder program for the SLC 5/05 controller, developed with RSLOGIX500. Following the ladder program are four additional screens showing the two tabs for each MSG Instruction. Before saving your program, be sure to configure Channel 1 with its IP address, subnet mask and disable BOOTP. Then, save your program.

Figure 7.14 SLC 5/05 Controller Ladder Program

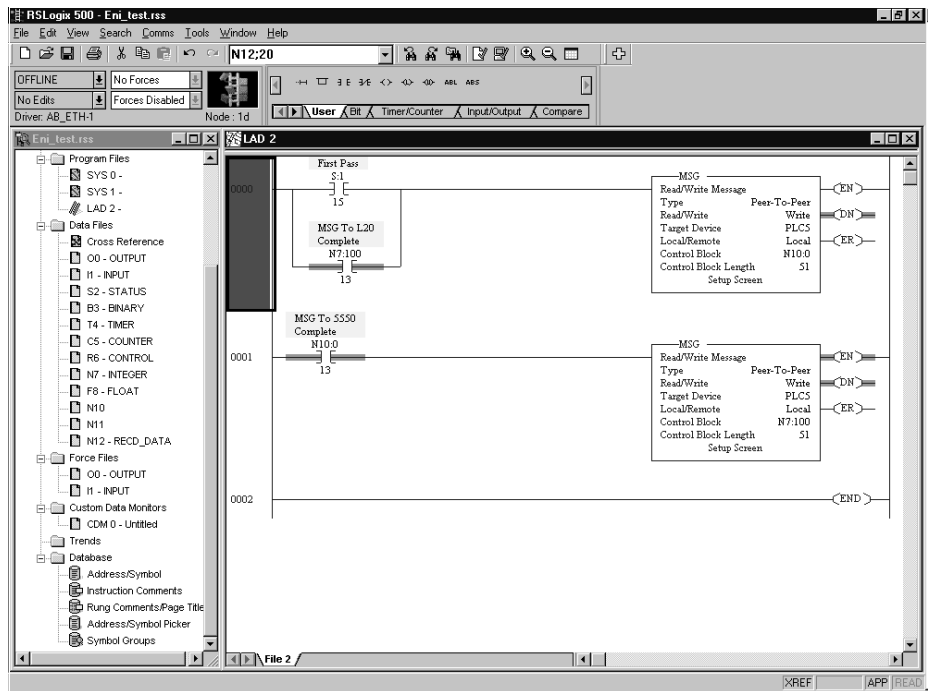

Figure 7.15 SLC 5/05 Rung 0 MSG “General” Tab

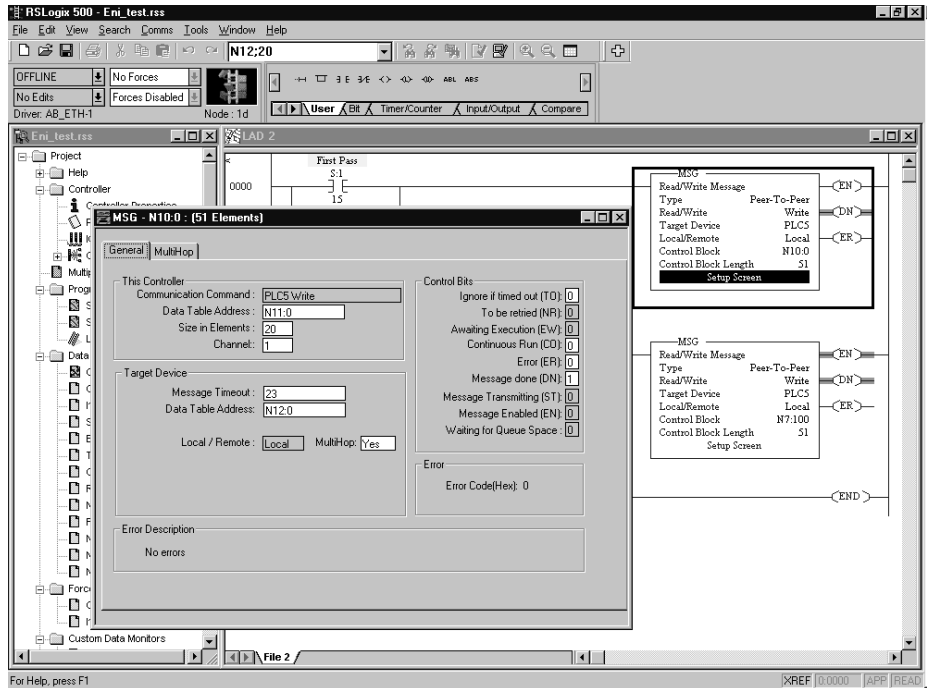

Figure 7.16 SLC 5/05 Rung 0 MSG “MultiHop” Tab

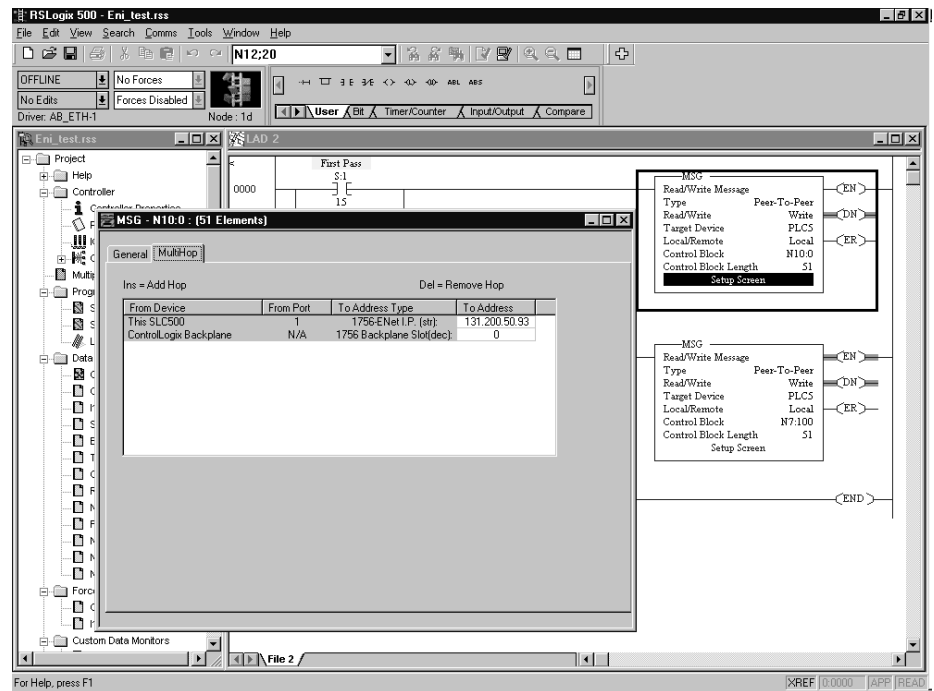

Figure 7.17 SLC 5/05 Rung 1 MSG “General” Tab

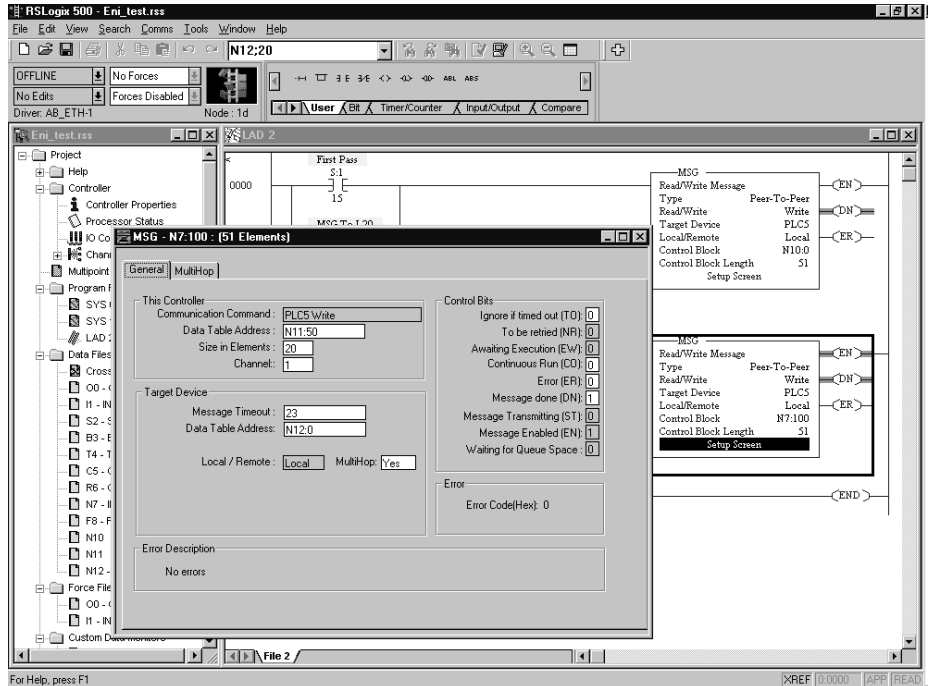
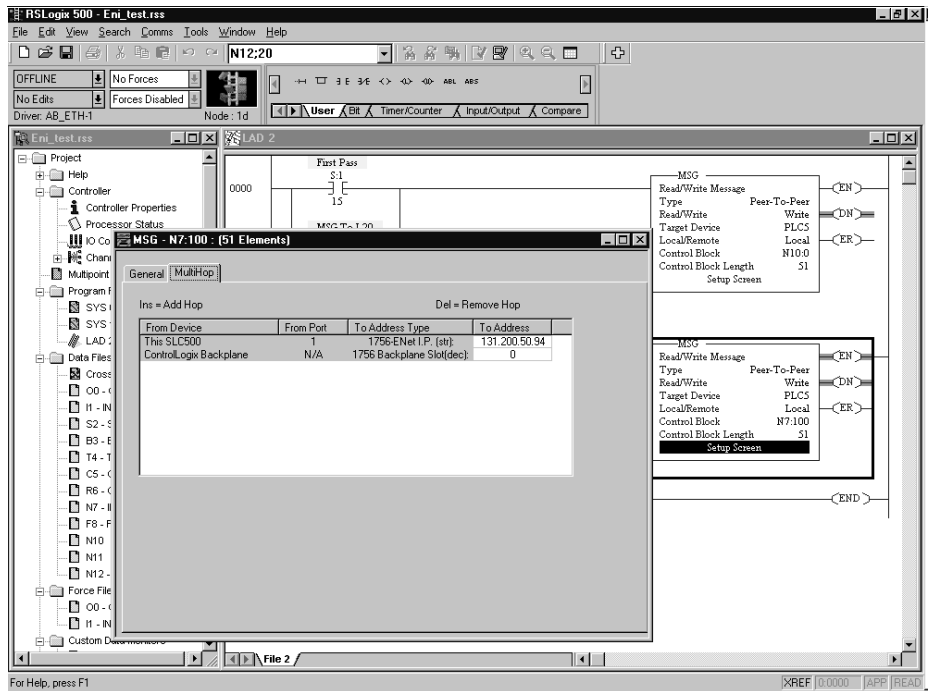

Figure 7.18 SLC 5/05 Rung 1 MSG “MultiHop” Tab



The following is the MSG ladder program for the 5550 controller, developed with RSLOGIX5000. Following the ladder program are four additional screens showing the two tabs for each MSG Instruction. As part of your program, you must configure your 1756-ENET module with the proper IP address.

Figure 7.19 ControlLogix 5550 Controller Ladder Program

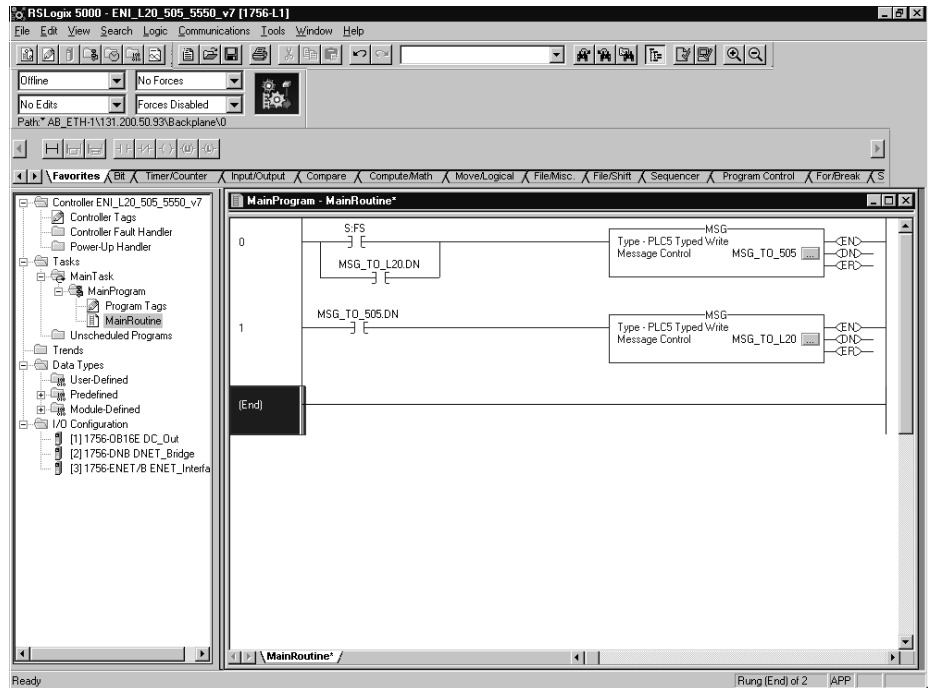

Figure 7.20 ControlLogix 5550 Rung 0 Message Configuration Tab

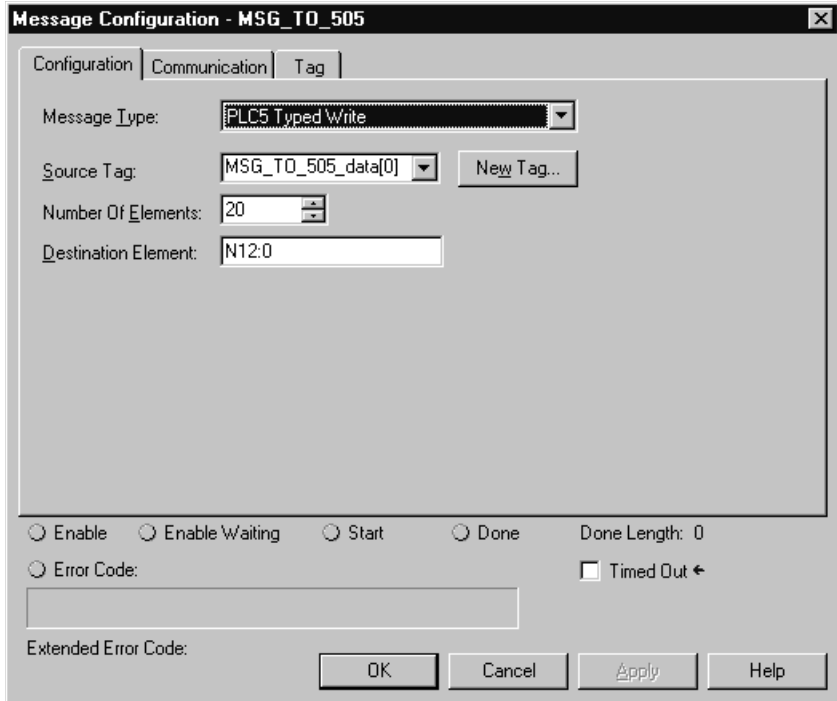

Figure 7.21 ControlLogix 5550 Rung 0 Message Communication Tab

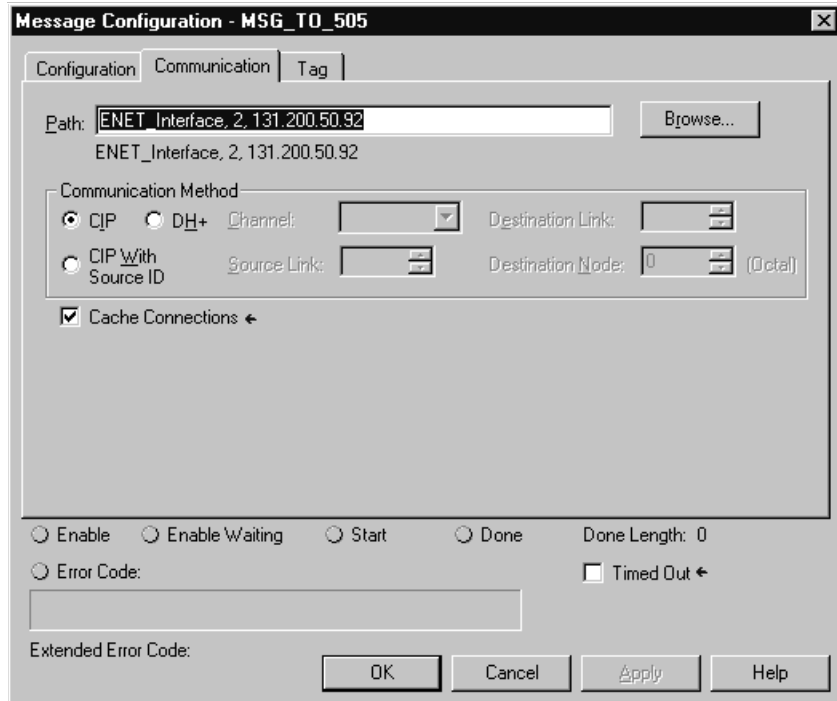

Figure 7.22 ControlLogix 5550 Rung 1 Message Configuration Tab

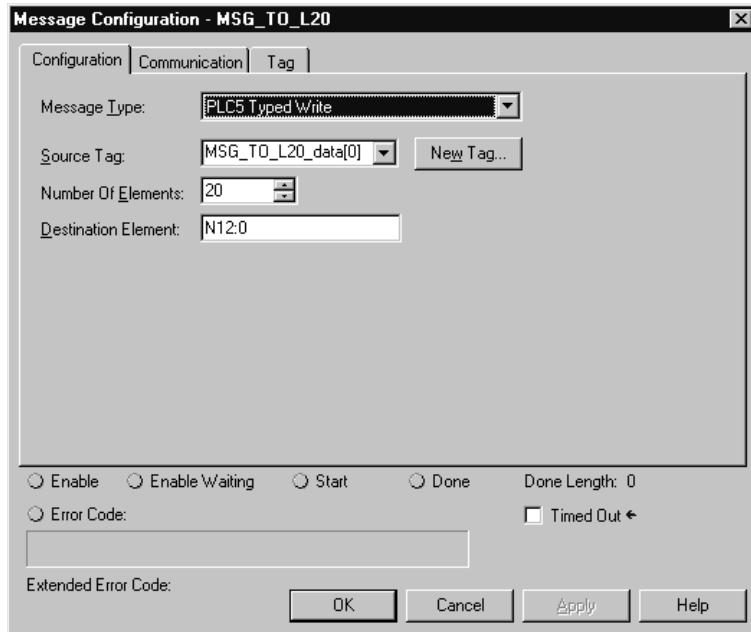
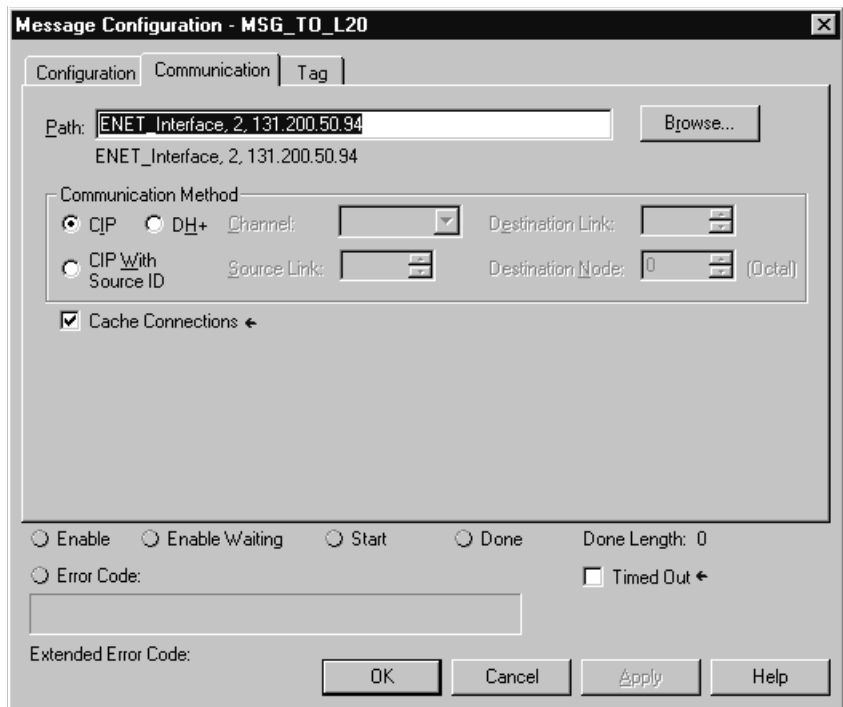

Figure 7.23 ControlLogix 5550 Rung 1 Message Communication Tab



The 1761-NET-ENI modules do not support CIP commands. Therefore, all commands between controllers used in this application example are PLC_5 Typed Write commands. These commands require a PLC-5 type address to send the data to the receiving controller. Such

addresses do not exist in Logix controllers, so they must be mapped to existing tags in these controllers.

From the Logic pull down menu, select “Map PLC/SLC Messages”. Your mapped table for your 5550 program should look like the following:

Figure 7.24 File Mapping for the ControlLogix 5550 Controller in RSLogix 5000

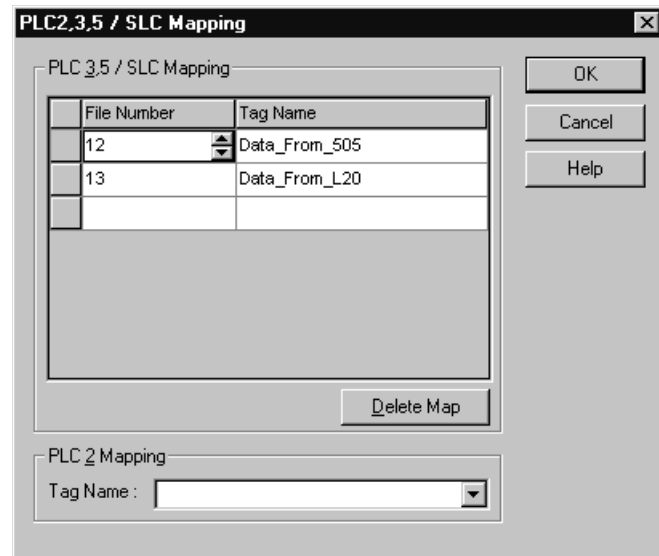

Save your program.

Configuring an Ethernet Driver in RSLINX

In order to download your programs to the SLC 5/05 controller and to the 5550 controller via Ethernet, we must configure an Ethernet driver in RSLINX.

In RSLINX, click on the Communications pull-down menu and select Configure Drivers. Click on the arrow associated with the Available Driver Types box. Select Ethernet Devices, then click Add New.

Modify this screen to include the IP addresses of the SLC 5/05 and the 1756-ENET as shown below:

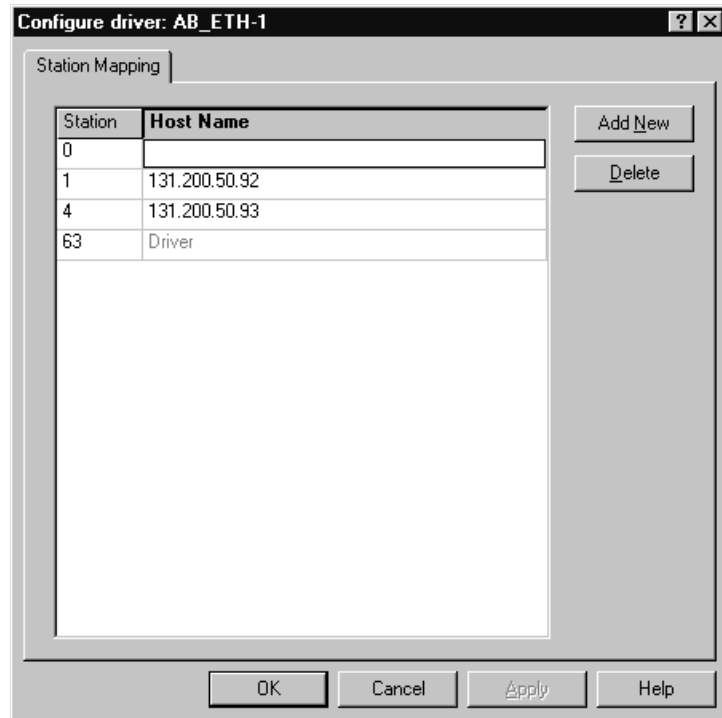
Figure 7.25 Configure Ethernet Driver Using RSLinx

From the RSLOGIX500 programming software, you should now be able to download your SLC 5/05 program. Then, from the RSLOGIX5000 software you should now be able to download your 5550 controller program.

Once all programs are downloaded to their respective controllers, place each controller into the RUN mode and a MSG from each controller will be sent to each of the other controllers. Each controller will only send one MSG at any given time. Go online with the SLC 5/05 and 5550 controllers to verify the successful completion of their Messages.

IMPORTANT

You cannot go online with the -L20 controller at this time, but you can verify that the -L20 messages are completing successfully by looking at the destination in the two other controllers where the -L20 is writing data. Verify that the data is being received.

Troubleshooting

This chapter covers the following Troubleshooting topics:

- Network Troubleshooting
- LED Sequence at Power-Up
- Troubleshooting Using the LED Indicators
- Error Codes Generated by the ENI
- Message Instruction Error Codes

Network Troubleshooting

Maintain ENI Connections

The UTP (unshielded twisted pair) patch cable on a switch should be labeled and treated as dedicated. Be careful when moving any cables, as port identity may be effected. If you must move the ENI to a new port for any reason, power-cycle the ENI. The power cycle forces a new ARP (address resolution protocol) request to be sent which should immediately associate the ENI's IP address with the port it is connected to.

You should also discourage any field personal from treating the ports of a switch as “all the same”. This helps to prevent any problems with network communications being effected by moving cables.

LED Sequence at Power-Up

The following LED test is performed at power-up.

LED	Power-Up Sequence
Ethernet TX/RX, Link and FAULT	1. on solid for 2 seconds
FAULT	2. flashes for 4 seconds
Ethernet TX/RX and FAULT	3. on solid for 1/4 second
All LEDs	4. off, unless an error condition exists (see troubleshooting table on page 8-2)

Troubleshooting Using the LED Indicators

The ENI status LEDs provide a mechanism to determine the current status of the ENI if a programming device is not present or available. The LED behavior is described in the following table.

LED	Description	Color	State	Indicates
RS-232 TX/RX	RS-232 data transmission indicator	green	flashing	data is being transmitted or received over the RS-232 port
			off	no RS-232 traffic
POWER	module power	green	on	module is powered
			off	module may not be powered
LINK	Ethernet link status	green	on	the module detects a valid Ethernet connection
			off	the module does not detect a valid Ethernet connection
Ethernet TX/RX	Ethernet data transmission indicator	green	flashing steady	During normal operation (Fault LED is off) the Ethernet port is transmitting or receiving NetLinx packets. For example, if you use "Ping" or "Telnet", the Ethernet TX/RX LED will not flash.
			flash sequence	When the Fault LED is <i>on steady</i> , the Ethernet TX/RX LED flashes the following error codes: <ul style="list-style-type: none"> • ROM Error - 1 flash, then off • RAM Error - 2 flashes, then off • Net Controller Error - 3 flashes, then off • EEPROM error: 4 flashes, then off • Duplicate IP: 5 flashes, then off When the FAULT LED is <i>flashing</i> , the Ethernet TX/RX LED flashes the following error codes: <ul style="list-style-type: none"> • Faulty Network Connection: 4 flashes, then off • ENI Not Configured: 5 flashes, then off • Unspecified Fault: off
			off	no Ethernet traffic
FAULT	fault condition indicator	red	on	lit when a fault condition is present, possible causes <ul style="list-style-type: none"> • ROM Checksum Error • RAM Test Error • Network Controller Error • EEPROM Checksum Error • Duplicate IP (see Ethernet TX/RX LED behavior above for error codes)
			flashing	one of the following: <ul style="list-style-type: none"> • faulty network connection • ENI does not have a valid IP address
			off	hardware is functioning normally

Error Codes Generated by the ENI

This table shows the error codes that may be generated by the ENI. A full listing of error codes that may be generated by the Message Instruction is shown below.

Error Code	Description of Error Condition
10H	Target node cannot respond because of incorrect command parameters or unsupported command. Possible causes: <ul style="list-style-type: none"> • The data size of the message is invalid. • The data format is incorrect for any of the supported PCCC messages. • Register parameters are not formatted correctly, or there is not enough data provided. • RS-232 configuration packet data is not the correct size. • The Node Address is invalid or out-of-range. • The distant ENI, controller, or device may not be responding. • There may be a break in the connection between the ENI devices or controllers. • BOOTP/DF1 parameter is invalid.
30H	PCCC Description: Remote station host is not there, disconnected, or shutdown.
D0H	One of the following: <ul style="list-style-type: none"> • No IP address configured for the network or ENI not configured for Node Address used. • Bad command - unsolicited message error. • Bad address - unsolicited message error. • No privilege - unsolicited message error.

Message Instruction Error Codes

When the controller detects an error during the transfer of message data, the controller sets the ER bit and enters an error code that you can monitor from your programming software.

Error Code	Description of Error Condition
02H	Target node is busy. NAK No Memory retries by link layer exhausted.
03H	Target node cannot respond because message is too large.
04H	Target node cannot respond because it does not understand the command parameters OR the control block may have been inadvertently modified.
05H	Local processor is off-line (possible duplicate node situation).
06H	Target node cannot respond because requested function is not available.
07H	Target node does not respond.
08H	Target node cannot respond.
09H	Local modem connection has been lost.
0BH	Target node does not accept this type of MSG instruction.
0CH	Received a master link reset (one possible source is from the DF1 master).
10H	Target node cannot respond because of incorrect command parameters or unsupported command.
12H	Local channel configuration protocol error exists.
13H	Local MSG configuration error in the Remote MSG parameters.

Error Code	Description of Error Condition
15H	Local channel configuration parameter error exists.
16H	Target or Local Bridge address is higher than the maximum node address.
17H	Local service is not supported.
18H	Broadcast is not supported.
21H	Bad MSG file parameter for building message.
30H	PCCC Description: Remote station host is not there, disconnected, or shutdown.
37H	Message timed out in local processor.
39H	Local communication channel reconfigured while MSG active.
3AH	STS in the reply from target is invalid.
40H	PCCC Description: Host could not complete function due to hardware fault.
45H	MSG reply cannot be processed. Either Insufficient data in MSG read reply or bad network address parameter.
50H	Target node is out of memory.
60H	Target node cannot respond because file is protected.
70H	PCCC Description: Processor is in Program Mode.
80H	PCCC Description: Compatibility mode file missing or communication zone problem.
90H	PCCC Description: Remote station cannot buffer command.
B0H	PCCC Description: Remote station problem due to download.
C0H	PCCC Description: Cannot execute command due to active IPBs.
D0H	One of the following: No IP address configured for the network or ENI not configured for Node Address used. Bad command - unsolicited message error. Bad address - unsolicited message error. No privilege - unsolicited message error.
D1H	Maximum connections used - no connections available.
D2H	Invalid internet address or host name.
D3H	No such host / Cannot communicate with the name server.
D4H	Connection not completed before user-specified timeout.
D5H	Connection timed out by the network.
D7H	Connection refused by destination host.
D8H	Connection was broken.
D9H	Reply not received before user-specified timeout.
DAH	No network buffer space available.
E1H	PCCC Description: Illegal Address Format, a field has an illegal value.
E2H	PCCC Description: Illegal Address format, not enough fields specified.
E3H	PCCC Description: Illegal Address format, too many fields specified.
E4H	PCCC Description: Illegal Address, symbol not found.
E5H	PCCC Description: Illegal Address Format, symbol is 0 or greater than the maximum number of characters support by this device.

Error Code	Description of Error Condition
E6H	PCCC Description: Illegal Address, address does not exist, or does not point to something usable by this command.
E7H	Target node cannot respond because length requested is too large.
E8H	PCCC Description: Cannot complete request, situation changed (file size, for example) during multi-packet operation.
E9H	PCCC Description: Data or file is too large. Memory unavailable.
EAH	PCCC Description: Request is too large; transaction size plus word address is too large.
EBH	Target node cannot respond because target node denies access.
ECH	Target node cannot respond because requested function is currently unavailable.
EDH	PCCC Description: Resource is already available; condition already exists.
EEH	PCCC Description: Command cannot be executed.
EFH	PCCC Description: Overflow; histogram overflow.
F0H	PCCC Description: No access.
F1H	Local processor detects illegal target file type.
F2H	PCCC Description: Invalid parameter; invalid data in search or command block.
F3H	PCCC Description: Address reference exists to deleted area.
F4H	PCCC Description: Command execution failure for unknown reason; PLC-3 histogram overflow.
F5H	PCCC Description: Data conversion error.
F6H	PCCC Description: The scanner is not able to communicate with a 1771 rack adapter. This could be due to the scanner not scanning, the selected adapter not being scanned, the adapter not responding, or an invalid request of a "DCM BT (block transfer)".
F7H	PCCC Description: The adapter is not able to communicate with a module.
F8H	PCCC Description: The 1771 module response was not valid size, checksum, etc.
F9H	PCCC Description: Duplicated Label.
FAH	Target node cannot respond because another node is file owner (has sole file access).
FBH	Target node cannot respond because another node is program owner (has sole access to all files).
FCH	PCCC Description: Disk file is write protected or otherwise inaccessible (off-line only).
FDH	PCCC Description: Disk file is being used by another application; update not performed (off-line only).
FFH	Local communication channel is shut down.

TIP

For 1770-6.5.16 DF1 Protocol and Command Set Reference Manual users: The MSG error code reflects the STS field of the reply to your MSG instruction.

- Codes E0 to EF represent EXT STS codes 0 to F.
- Codes F0 to FC represent EXT STS codes 10 to 1C.

Specifications

Physical Specifications

Description	ENI Specification
24V dc Power Source Requirement	20.4 to 26.4V dc
24V dc Current Draw	50 mA typical, 100 mA maximum
Maximum Inrush Current	200 mA
Internal Isolation	500V ac for one minute
Vibration	operating: 10 to 500 Hz, 5.0g, 0.030 in. peak-to-peak, 2 hour each axis
Shock	operating: 30g, ± 3 times each axis non-operating: 35g (DIN Rail Mount) 50g (Panel Mount), ± 3 times each axis
Operating Ambient Temperature	0°C to +55°C (+32°F to +131°F)
Storage Temperature	-40°C to +85°C (-40°F to +175°F)
Humidity	5% to 95% relative humidity (non-condensing)
Agency Certification	<ul style="list-style-type: none"> • UL 1604 • C-UL C22.2 No. 213 • Class I Division 2 Groups A,B,C,D • CE compliant for all applicable directives
<i>Radiated and Conducted Emissions:</i>	<i>EN 50081-2, Class A</i> <i>The module has passed testing at the following levels:</i>
<ul style="list-style-type: none"> • ESD Immunity (EN 1000-4-2) 	<ul style="list-style-type: none"> • 4 kV contact, 8 kV air, 4 kV indirect
<ul style="list-style-type: none"> • Radiated Immunity (EN 1000-4-3) 	<ul style="list-style-type: none"> • 10V/m, 80 to 1000 MHz, 80% amplitude modulation, and 900 MHz keyed carrier
<ul style="list-style-type: none"> • Fast Transient Burst (EN 1000-4-4) 	<ul style="list-style-type: none"> • Power supply: 2 kV, 5 kHz • RS-232 and Ethernet: 1kV, 5 kHz
<ul style="list-style-type: none"> • Surge Immunity (EN 1000-4-5) 	<ul style="list-style-type: none"> • Power Supply: 500V • Ethernet (unshielded cable): 2 kV • RS-232 and Ethernet (shielded cable): 1 kV galvanic gun
<ul style="list-style-type: none"> • Conducted Immunity (EN 1000-4-6) 	<ul style="list-style-type: none"> • Power Supply: 10V, 0.15 to 80 MHz • RS-232 and Ethernet (unshielded cable): 3V, 0.15 to 80 MHz • RS-232 and Ethernet (shielded cable): 10V, 0.15 to 80 MHz

Ethernet Specifications

Communication Rate: 10 Mbps

Connector: 10Base-T

MicroLogix Web Site

Visit <http://www.ab.com/micrologix> for more information on MicroLogix products. You can find a variety of application information and White Papers covering specific technical topics.

Dimensions

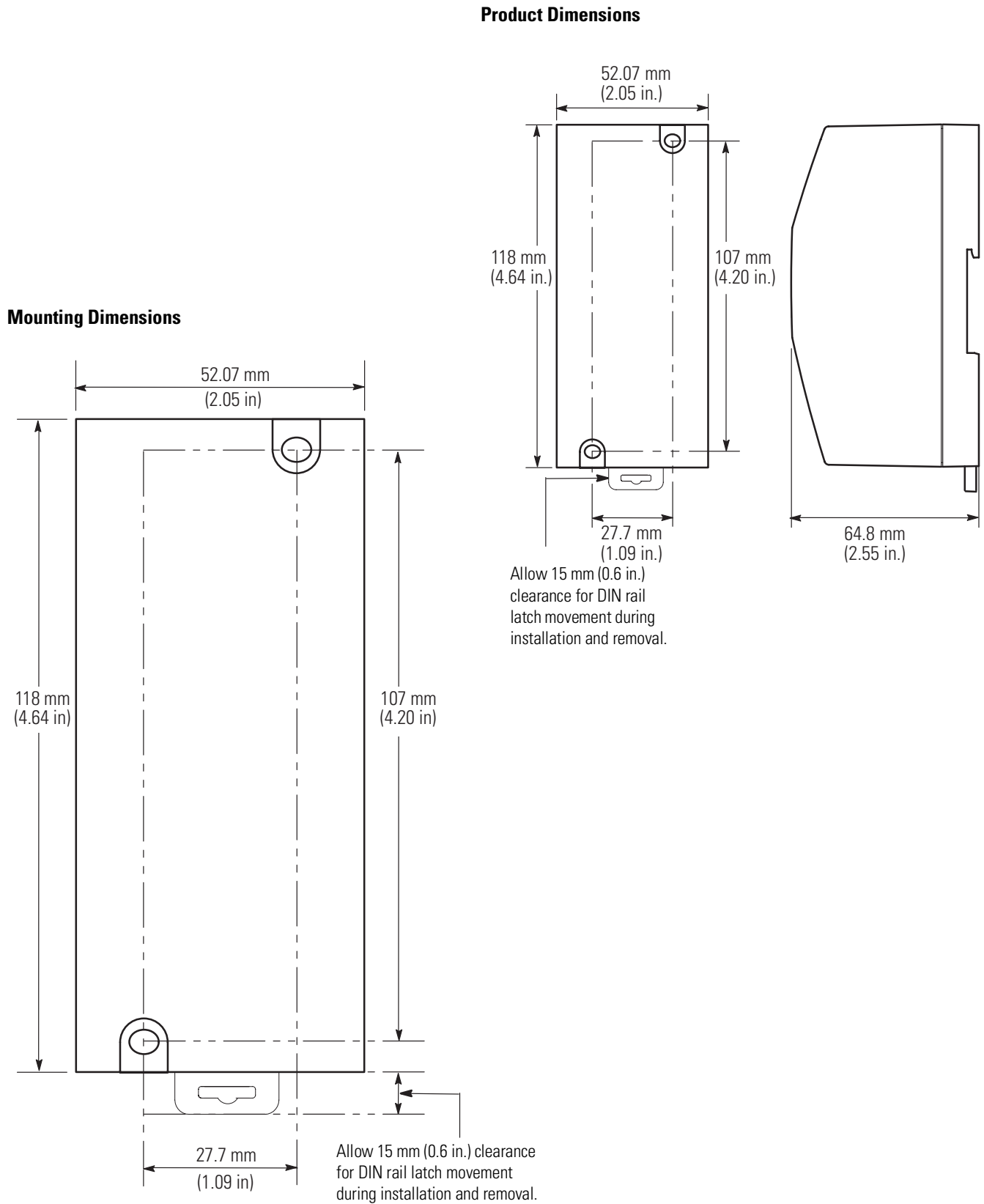

BOOTP Configuration Method (default)

BOOTP (Bootstrap protocol) is a low-level protocol that provides configuration information to other nodes on a TCP/IP network with DOS, Microsoft Windows, Windows NT, Windows 9x, VMS, and HP-UNIX platforms. BOOTP configuration files let you automatically assign IP addresses to the ENI. You can also set Subnet Masks and Gateway addresses using BOOTP.

To use BOOTP, a BOOTP Server must exist on the local Ethernet Subnet. The server is a computer that has BOOTP Server software installed and running which reads a text file containing network information for individual nodes on the network.

TIP

If you do not have BOOTP Server capabilities on your network, and you want to dynamically configure the ENI, you can obtain the BOOTP software by contacting your local Rockwell Automation representative.

When the ENI receives a configuration message via BOOTP, it uses the data within the message to configure its TCP/IP parameters.

Table 2.1 TCP/IP Parameters

Function	Format	Notes
IP Address	Integer	This is a unique IP Address for the ENI. Format is aaa.bbb.ccc.ddd. Default is 000.000.000.000.
Subnet Mask	optional ⁽¹⁾	If not sent, the default mask is derived from the class of the IP address. See page 4-13 for more information on the subnet mask.
Gateway	optional ⁽¹⁾	Only needed if a Gateway is present on the Subnet. Default is 000.000.000.
Security Mask 1	Zero	The default is no security mask 000.000.000.000. See page 4-13 for more information on the Security Mask.
Security Mask 2		

⁽¹⁾ Depending upon whether your BOOTP server allows these optional fields to be included, you might not be able to configure these parameters using the BOOTPTAB file. If that is the case, configure them using the soft configuration method. See page 4-1 for more information. If you do not need to define a Subnet Mask or Gateway, simply ignore these parameters.

When BOOTP is enabled, the following events occur at power-up:

- The ENI broadcasts a BOOTP-request message containing its hardware address over the local network or subnet.
- The BOOTP server compares the hardware address with the addresses in its look-up table in the BOOTPTAB file.
- The BOOTP server sends a message back to the ENI with the IP address and other network information that corresponds to the hardware address it received.

With all hardware and IP addresses in one location, you can easily change IP addresses in the BOOTP configuration file if your network needs change.

The ENI allows the BOOTP request to be disabled by clearing the BOOTP Enable parameter. See Node 252 - BOOTP Configuration on page 4-15.

Using BOOTP

The optional BOOTP Server file contains DOS-based and Windows-based BOOTP server utilities. Both provide BOOTP services for the ENI. Regardless of the platform you are using, you must:

- install the boot-server utility
- edit the boot-server configuration file
- run the boot-server utility

IMPORTANT

Do not use the BOOTP utility disk if you already have INTERCHANGE software installed. Instead, use the boot-server capabilities that came with your INTERCHANGE software.

Install the BOOTP Server

To install the DOS BOOTP server:

1. Unzip the software to a known directory.
2. Change to that directory.
3. Type **install**, and press **[Enter]**.
4. The software is installed in C:\ABIC\BIN. If you are using DOS, put this directory in the path statement of your AUTOEXEC.BAT file.

Edit the BOOTP Configuration File

The boot-server configuration file, `BOOTPTAB`, is located in the `C:\ABIC\BIN` directory. `BOOTPTAB` is an ASCII file that looks like:

```
#Legend:gw -- gateways
#ha -- hardware address
#ht -- hardware type(1)
#ip -- host IP address
#sm -- subnet mask
#vm -- BOOTP vendor extensions format(2)
#tc -- template host
#Default string for each type of Ethernet client
defaults5E: ht=1:vm=rfc1048
#Entries for SLC 5/05 processors:
sigma1: tc=defaults5E:ip=12.34.56.1:ha=0000BC1D1234
sigma2: tc=defaults5E:ip=12.34.56.2:ha=0000BC1D5678
sigma3: tc=defaults5E:ip=12.34.56.3:ha=0000BC1D9012
```

This file contains the information needed to boot the ENI.

You must edit the `BOOTPTAB` file to include the name, IP address, and hardware address for each ENI you want the server to boot. To edit this file:

1. Open the `BOOTPTAB` file using a text editor such as Notepad or Wordpad.

The file contains text that look like this:

```
#Default string for each type of Ethernet
client
defaults5E: ht=1:vm=rfc1048
```

These are the default parameters for the ENI and must always precede the client lines in the `BOOTPTAB` file.

The file also contains a line that looks like this:

```
#Entries for SLC 5/05 processors:
sigma1:tc=defaults5E:ip=12.34.56.1:ha=0000BC1D
1234
```

The “#” character defines the line as information, not configuration data.

IMPORTANT

Use the `sigma1` line as the configuration template for the ENI.

(1) 1 = 10 MB Ethernet

(2) Use rfc 1048.

2. Make one copy of the configuration template for each ENI in your system.
3. Edit each copy of the template as follows:
 - a. Replace “sigma1” with the name of the ENI. Use only letters and numbers; do not use underscores.
 - b. Replace “12.34.56.1” with the IP address to be assigned to the ENI.
 - c. Replace “ha=0000BC1D1234” with the ENI’s hardware address. Use only hexadecimal digits (0-9, A-F); do not use the hyphens that separate the numbers.
4. Save, close, and make a backup copy of this file.

Example BOOTPTAB File

In this example there are three SLC 5/05 processors and an HP 9000 programming terminal. The names and hardware addresses are device specific:

Device	Name	IP Address	Hardware Address
SLC 5/05	sigma1	12.34.56.100	00-BC-1D-12-34
SLC 5/05	sigma2	12.34.56.200	00-BC-1D-56-78
SLC 5/05	sigma3	12.34.56.300	00-BC-1D-90-12

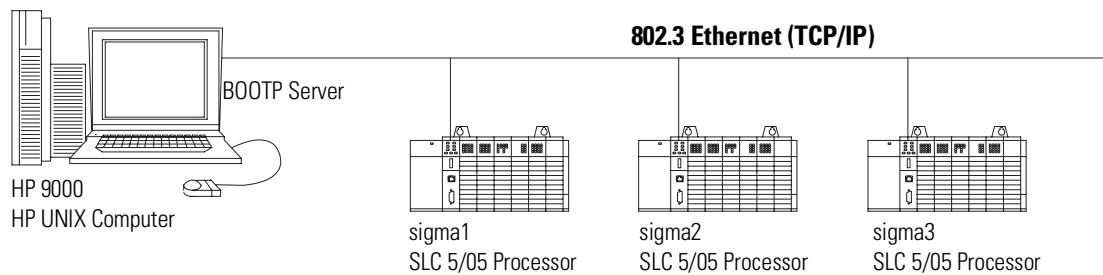

Based on this configuration, the BOOTPTAB file looks like:

```
#Legend:gw -- gateways
#ha -- hardware address
#ht -- hardware type(1)
#ip -- host IP address
#sm -- subnet mask
#vm -- BOOTP vendor extensions format(2)
#tc -- template host
#Default string for each type of Ethernet client
defaults5E: ht=1:vm=rfc1048
#Entries for SLC 5/05 processors:
sigma1: tc=defaults5E:ip=12.34.56.1:ha=0000BC1D1234
sigma2: tc=defaults5E:ip=12.34.56.2:ha=0000BC1D5678
sigma3: tc=defaults5E:ip=12.34.56.3:ha=0000BC1D9012
```

Run the Boot Server Utility

You can run either the DOS-based utility or the Windows-based BOOTP utility, but not both.

If you have BOOTP enabled and the message BOOTP response not received appears, check the cabling connections and the BOOTP server system.

If you're using this platform	then invoke this executable	from the	See page
DOS-based	DTLBOOTD.EXE	DOS command line (specify optional parameters if necessary)	B-6
Windows	DTLBOOTW.EXE	Windows Program Manager	B-6

Both utilities are located in the C:\ABIC\BIN directory and use the information contained in the BOOTPTAB file.

Be sure to place the BOOTPTAB file in the directory from which you are running the BOOTP utility. If this file is not found in that directory, the utility will try to find the file in the directory specified by the environment variable ABIC_CONFIG.

(1) 1 = 10 MB Ethernet

(2) Use rfc 1048.

Running the DOS-Based Utility

To run the boot-server utility, `DTLBOOTD.EXE`, follow these steps:

1. At the DOS prompt, type:

```
DTLBOOTD [-D] [-T <timeout>] [-B <numboots>] [-F <numfiles>]
[configfile] [logfile]
```

Parameter	Description
-D	provide additional information for debug purposes.
-T <timeout>	exit after <timeout> seconds of inactivity.
-B <numboots>	exit after answering <numboots> number of boot requests.
-F <numfiles>	exit after answering <numfiles> number of file requests.
configfile	name of the boot server configuration file to use. The default configuration file is %ABIC_CONFIG%\BOOTPTAB.
logfile	name of the log file to use. The default log file is %ABIC_CONFIG%\DTLBOOTD.LOG.

Once you invoke the utility, it runs until the specified exit parameter is satisfied. Exit any time by pressing **[Esc]**.

2. Apply power to all ENIs. At power-up, each ENI broadcasts a BOOTP request (if BOOTP was enabled). The Ethernet boot server compares the hardware address with those listed in the `BOOTPTAB` file and responds by sending the corresponding IP address and other configuration data to the client via a BOOTP reply.

Running the Windows-Based Utility

To run the boot-server utility, `DTLBOOTW.EXE`, follow these steps:

1. Start Microsoft Windows[®], if it is not already running.
2. Start the utility. It will run until you terminate it by closing the `DTLBOOTW.EXE` window and exiting from Windows.
3. Apply power to all ENIs. At power-up, each ENI broadcasts a BOOTP request. The Ethernet boot server compares the hardware address with those listed in the `BOOTPTAB` file and responds by sending the corresponding IP address and other configuration data to the client via a BOOTP reply.

ASA (Advanced System Architecture)

Autobaud

A feature that allows a communications port to automatically synchronize to the device or network that it is attached to. This feature typically minimizes the amount of configuration required, and also makes it easier to replace devices.

Auto BCC/CRC

Sends a test message during autobaud to detect which Error Detecting setting to use, BCC or CRC. This will not occur for fixed baud rate settings. The ENI uses CRC for fixed baud rates.

Baud Rate

The speed of communication between devices on a network. All devices must communicate at the same baud rate. For example, the DH-485 network devices default to 19,200 baud.

CIP (Control and Information Protocol)

DNI (DeviceNet Network Interface)

Allen-Bradley catalog number 1761-NET-DNI. The DNI allows you to connect DF1 devices to DeviceNet networks.

DF1 Full-Duplex

DF1 is a standard (open) point-to-point communication protocol. Virtually all Allen-Bradley controllers (PLC-3, PLC-5, SLC, MicroLogix) that have an RS-232 communications port support DF1.

DF1 Protocol

A peer-to-peer link-layer protocol that combines features of ANSI X3.28-1976 specification subcategories D1 (data transparency) and F1 (two-way simultaneous transmission with embedded responses).

ENI (Ethernet Network Interface)

Allen-Bradley catalog number 1761-NET-ENI. The ENI allows you to connect DF1 devices to Ethernet networks.

Ethernet Network

A local area network with a baseband communication rate of 10M bits per second.

Full-duplex

A high-performance protocol that allows simultaneous two-way data transmission. For point-to-point applications only.

IP (Internet Protocol)

IP specifies the format of packets and the addressing scheme. Most networks combine IP with a higher-level protocol called Transport Control Protocol (TCP), which establishes a virtual connection between a destination and a source.

IP by itself is something like the postal system. It allows you to address a package and drop it in the system, but there's no direct link between you and the recipient. TCP/IP, on the other hand, establishes a connection between two hosts so that they can send messages back and forth for a period of time.

IP Address

A 32-bit address assigned to hosts that want to participate in a TCP/IP internet. IP addresses are the abstraction of physical hardware addresses, with a network and host partition which makes routing efficient.

NetLinx Services

The NetLinx services occur over the well-known port 0xAF12 and define a connection protocol that exists after a TCP/IP connection is established. It also defines a set of services and packet formats to support the protocol. Also implied by this protocol is that the end devices have implemented some portion of the ASA CIP addressing architecture.

Network

A series of stations (nodes) connected by some type of communication medium. A network may be made up of a single link or multiple links.

Node

Also called a station. An address or software location on the network.

MTA (Mail Transfer Agent)

The software function responsible for delivering outgoing mail to its final destination.

PCCC (Programmable Controller Communications Commands)

RS-232

An EIA standard that specifies electrical, mechanical, and functional characteristics for serial binary communication circuits.

Security Mask

The Security Mask, when configured, allows you to restrict incoming TCP/IP and/or UDP messages to have source IP addresses that are within some prescribed range. For example, if you wanted to restrict all message sources to be from within a company's allocated IP address range, a Security Mask could be configured that would block any IP address outside that range.

SMTP (Simple Mail Transfer Protocol)

This protocol defines the interface and commands with the Mail Transfer Agent and defines how the ENI will deliver the outgoing mail.

Single-Hop/ Multi-Hop

Term that refers to how many "different" networks a message must traverse to reach its destination. For the ENI, a single-hop message is one whose source and destination nodes are both TCP/IP end points.

TCP (Transmission Control Protocol)

TCP is one of the main protocols in TCP/IP networks. Whereas the IP protocol deals only with packets, TCP enables two hosts to establish a connection and exchange streams of data. TCP guarantees delivery of data and also guarantees that packets will be delivered in the same order in which they were sent.

TCP/IP (Transmission Control Protocol/Internet Protocol)

The suite of communications protocols used to connect hosts on the Internet. TCP/IP uses several protocols, the two main ones being TCP and IP. TCP/IP is built into the UNIX operating system and is used by the Internet, making it the de facto standard for transmitting data over networks. Even network operating systems that have their own protocols, such as Netware, also support TCP/IP.

UCMM (Unconnected Message Manager)

The UCMM is an object defined in the CIP protocol. This object is responsible for handling connection requests and unconnected message traffic.

UTP (Unshielded Twisted Pair)

The type of cable used in 10BaseT systems.

A**Allen-Bradley**

contacting for assistance P-3
support P-3

ASA

definition G-1

Auto BCC/CRC

definition G-1

Autobaud

definition G-1
restrictions 4-16

B**Baud Rate**

configuring 4-15
definition G-1

BOOTP

edit configuration file B-3
example B-4
IP address B-4

BOOTP Configuration 4-15, B-1**Boot-Server Host** B-2**C****Cables** 2-2, 2-6, 2-7, 2-8**CE Mark** 2-1**CIP**

definition G-1

Common Techniques Used in this Manual P-2**Compatibility** 1-4**Configuration** 4-1

BOOTP 4-15
controller messaging 4-5
e-mail 6-2
list of parameters 4-10
via BOOTP B-1
via message instruction 5-3

Configuration Utility 4-1**Configuring**

BOOTP host B-2

Connections

allocation of Ethernet connections 3-1
Ethernet switch 2-7

Contacting Allen-Bradley for Assistance P-3**D****DF1 Full-Duplex**

definition G-1
messaging 5-1

DF1 Protocol

default settings 1-3
definition G-1

Dimensions A-2**DNI**

definition G-1

DOS Host

for BOOTP B-2

E**E-Mail Message Fields** 6-4**E-Mail Messages** 6-1**E-Mail Server** 4-15**E-Mail, sending a message** 6-5**EMC Directive** 2-1**ENI**

configuration 4-1
definition G-1
functional overview 3-2
LED indicators 1-2
operating modes 1-4
operation 3-1
overview 1-1
port identification 2-5
product drawing 1-2

ENI Configuration Utility 4-1**Error Codes** 8-3**Ethernet Connections** 2-6**Ethernet Hardware Address** 4-16**Ethernet Network**

connections 1-5
definition G-1
ENI connection 1-1
example 7-1
non-Ethernet devices 1-1

Ethernet Port 1-2**Example**

BOOTP B-4
using the CompactLogix serial port to connect to an
Ethernet network 7-1

Explosion Hazard 2-2

F

- Fault LED** 1-2
- From String** 4-11, 6-2
- Full-Duplex**
 - definition G-2

G

- Grounding** 2-5

H

- Hardware Address** 1-2, 4-16
- Hardware Features** 1-2
- Hazardous Location** 2-2

I

- Installation and Wiring** 2-1
- Integer Files** 4-6
- IP**
 - definition G-2

- IP Address**
 - assigning 1-5
 - definition G-2
 - ENI write-on area 1-2

L

- LED Indicators** 1-2
- LED Sequence at Power-Up** 8-1
- Link LED** 1-2
- Low Voltage Directive** 2-1

M

- Manuals, Related** P-2
- Memory Map** 3-2
- Messaging** 4-5, 5-1
- Mounting** 2-3
 - dimensions A-2

MTA

- definition G-2

N

- Netlinx Services**
 - definition G-2
- Network**
 - definition G-2
- Node**
 - definition G-2

O

- Operating Modes** 1-4
- Operation** 3-1

P

- PCCC**
 - definition G-3
- Peer Connections** 3-1
- Peer-to-Peer Messaging** 5-1
- Power LED** 1-2
- Power Supply Wiring** 2-5
- Product Overview** 1-1
- Program Upload/Download** 3-2
- Publications, Related** P-2
- Purpose of this Manual** P-1

R

- Related Publications** P-2
- RS-232**
 - cables 2-8
 - connector 2-8
 - default settings 1-3
 - definition G-3
 - ENI port 1-2
 - pin assignments 2-8
- RSLinx** 3-2

S

- Safety Considerations** 2-2
- Save/Reset** 4-11
- Security Mask** 4-13
 - definition G-3
- Single-Hop**
 - definition G-3
- SMTP**
 - definition G-3
- SMTP E-Mail Address** 6-2
- Specifications** A-1
- String Files** 4-8
- Subnet Mask** 4-13

T

- TCP**
 - definition G-3
- TCP/IP**
 - configuration 4-12
 - definition G-3
- Troubleshooting**
 - contacting Allen-Bradley for assistance P-3
 - maintain ENI connections 2-7
 - procedure 8-1
- TX/RX LED** 1-2

U

- UCMM**
 - definition G-3
- Upload/Download** 3-2
- UTP**
 - definition G-4

W

- Web Browser** 1-5
- Wiring** 2-1

Reach us now at www.rockwellautomation.com

Wherever you need us, Rockwell Automation brings together leading brands in industrial automation including Allen-Bradley controls, Reliance Electric power transmission products, Dodge mechanical power transmission components, and Rockwell Software. Rockwell Automation's unique, flexible approach to helping customers achieve a competitive advantage is supported by thousands of authorized partners, distributors and system integrators around the world.

Americas Headquarters, 1201 South Second Street, Milwaukee, WI 53204, USA, Tel: (1) 414 382-2000, Fax: (1) 414 382-4444

European Headquarters SA/NV, avenue Herrmann Debroux, 46, 1160 Brussels, Belgium, Tel: (32) 2 663 06 00, Fax: (32) 2 663 06 40

Asia Pacific Headquarters, 27/F Citicorp Centre, 18 Whitfield Road, Causeway Bay, Hong Kong, Tel: (852) 2887 4788, Fax: (852) 2508 1846

Publication 1761-UM006A-EN-P - February 2001

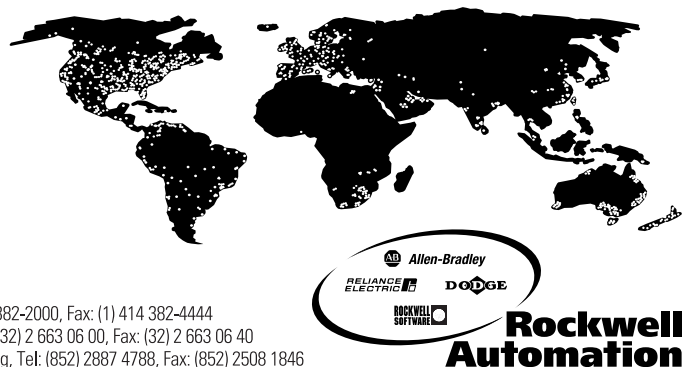

Free Manuals Download Website

<http://myh66.com>

<http://usermanuals.us>

<http://www.somanuals.com>

<http://www.4manuals.cc>

<http://www.manual-lib.com>

<http://www.404manual.com>

<http://www.luxmanual.com>

<http://aubethermostatmanual.com>

Golf course search by state

<http://golfingnear.com>

Email search by domain

<http://emailbydomain.com>

Auto manuals search

<http://auto.somanuals.com>

TV manuals search

<http://tv.somanuals.com>