

HP

8753ET/ES**Network Analyzers**

HP 8753ET and 8753ES Network Analyzers 30 kHz to 3 or 6 GHz

This document describes the performance and features of the following products:

HP 8753ES S-parameter vector network analyzer
HP 8753ES Option 011 vector network analyzer without test set
HP 8753ET Transmission/reflection vector network analyzer

For more information about these analyzers, please see the following documents:

HP 8753ET and 8753ES Network Analyzers Brochure
HP 8753ET and 8753ES Network Analyzers Configuration Guide

HP literature number
5968-5159E
5968-5158E

Table of contents

Definitions and test conditions	3
System performance summaries	4
Specifications and characteristics	10
Measurement throughput summary	21
Options	21
Test set specifications for Option 011	22
Accessories	24

Definitions and test conditions

Specifications describe the instrument's warranted performance after a half-hour warm-up and over the temperature range of $25\text{ }^{\circ}\text{C} \pm 5\text{ }^{\circ}\text{C}$, unless otherwise stated. Specifications for frequencies above 3 GHz do not apply to instruments with Option 075 (75-ohm impedance).

Supplemental characteristics are typical but non-warranted performance parameters. These are denoted as "typical," "nominal," or "approximate."

The measurement uncertainty curves and measurement port characteristics given for HP 8753ES systems also apply to the HP 8753ES with Options 006 and 011 and the HP 85047A test set (50-ohm), or the HP 8753ES Option 011 with an HP 85046B test set (75-ohm).

Dynamic range

System dynamic range is calculated as the difference between the receiver noise floor and the lesser of either the source maximum output or the receiver maximum input level. System dynamic range applies to transmission measurements only, since reflection measurements are limited by directivity.

Noise floor is specified as the mean of the noise trace over frequency. Noise floor is measured with the test ports terminated in loads, full two-port error correction for the HP 8753ES and enhanced-response error correction for the HP 8753ET (with 16 averages used during isolation), 10 Hz IF bandwidth (BW), maximum test port power, and no averaging during the measurement.

Measurement uncertainty

Measurement uncertainty curves utilize a Root Sum Square (RSS) model for the contribution of random errors such as noise, typical connector repeatabilities, and test set switching; this is combined with a worst-case model for the contributions of dynamic accuracy and residual systematic errors.

Curves show the worst-case magnitude and phase uncertainty for reflection and transmission measurements, after a full two-port error correction for the HP 8753ES and enhanced-response error correction for the HP 8753ET (including isolation with an averaging factor of 16) using the specified cal kit, with 10 Hz IF bandwidth (BW) and no averaging.

Measurement port characteristics

Characteristics show the residual system uncertainties for uncorrected performance and after accuracy enhancement using full two-port error correction for the HP 8753ES and enhanced-response error correction for the HP 8753ET. These characteristics apply for an environmental temperature of $25 \pm 5\text{ }^{\circ}\text{C}$, with less than $1\text{ }^{\circ}\text{C}$ deviation from the calibration temperature. HP 8753ET Option 004 may degrade transmission source match as much as 2 dB, resulting in up to 0.05 dB additional uncertainty in transmission tracking.

Corrected performance indicates residual error after calibration. It is determined by the quality of calibration standards, system repeatability, stability, and noise.

Uncorrected performance indicates intrinsic errors without calibration correction applied. This is related to the ultimate stability of a calibration.

System performance summaries

HP 8753ES (50-ohm systems)

7-mm test ports

Configuration

Network analyzer	HP 8753ES
	Standard and Option 006
Calibration kit	HP 85031B
Test-port cables	HP 11857D

System dynamic range

30 kHz to 50 kHz	70 dB ¹
50 kHz to 300 kHz	90 dB ¹
300 kHz to 16 MHz	100 dB
16 MHz to 3 GHz	110 dB
Option 014	108 dB
3 GHz to 6 GHz	105 dB
Option 014	103 dB

Reflection uncertainty

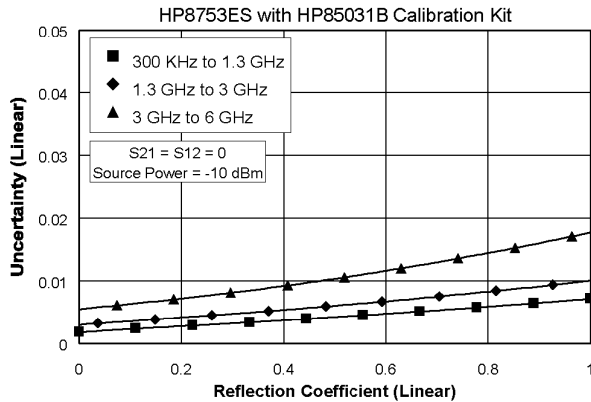

Magnitude

Measurement port characteristics

	Frequency range				
	Corrected	30 kHz-300 kHz ²	300 kHz-1.3 GHz	1.3 GHz-3 GHz	3 GHz- 6 GHz
Directivity	55 dB	55 dB	51 dB	46 dB	
Source match	55 dB	51 dB	49 dB	43 dB	
Load match	55 dB	55 dB	51 dB	46 dB	
Reflection tracking	±(0.001 dB +0.02 dB/°C)	±(0.001 dB +0.01 dB/°C)	±(0.005 dB +0.02 dB/°C)	±(0.020 dB +0.03 dB/°C)	
Transmission tracking	±(0.008 dB +0.02 dB/°C)	±(0.006 dB +0.01 dB/°C)	±(0.009 dB +0.02 dB/°C)	±(0.021 dB +0.03 dB/°C)	
Uncorrected					
Directivity	20 dB*	35 dB	30 dB	25 dB	
Source match	18 dB**	16 dB	16 dB	14 dB	
Load match	18 dB**	18 dB	16 dB	14 dB	
Reflection tracking	±2.5 dB	±1 dB	±1 dB	±1.5 dB	
Transmission tracking	±2.5 dB	±1 dB	±1 dB	±1.5 dB	
Crosstalk	90 dB***	100 dB	100 dB	90 dB	

*15 dB, 30 kHz to 50 kHz

**10 dB, 30 kHz to 50 kHz

***60dB, 30 kHz to 50 kHz

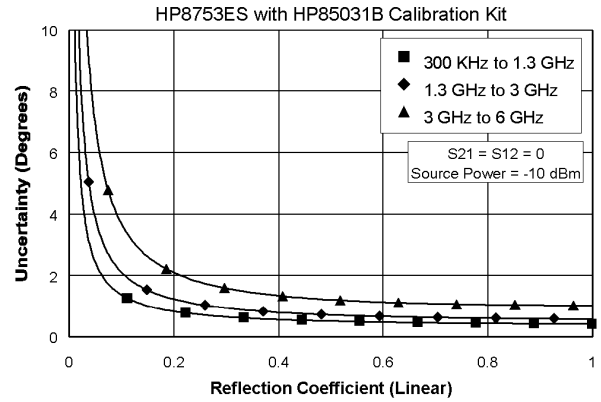

Phase

Transmission uncertainty

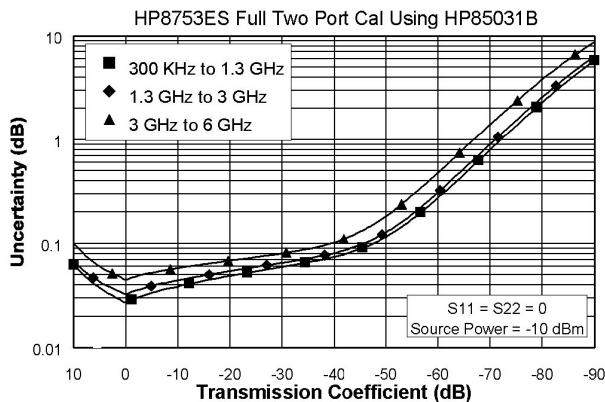

Magnitude

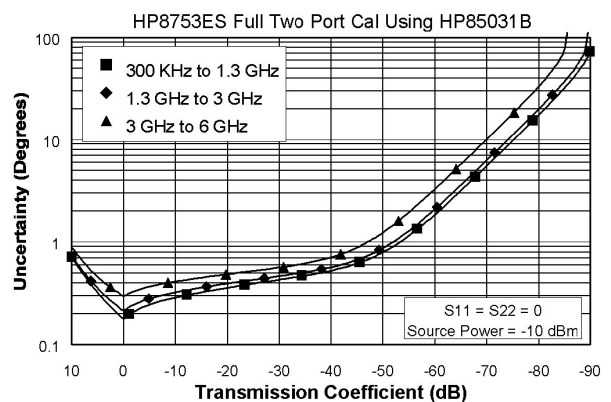

Phase

1. Typical below 300 kHz.
2. Typical performance.

System performance summaries

HP 8753ES (50-ohm systems)

Type-N test ports

Configuration

Network analyzer	HP 8753ES
	Standard and Option 006
Calibration kit	HP 85032B
Test-port cables	HP 11857D

System dynamic range

30 kHz to 50 kHz	70 dB ¹
50 kHz to 300 kHz	90 dB ¹
300 kHz to 16 MHz	100 dB
16 MHz to 3 GHz	110 dB
Option 014	108 dB
3 GHz to 6 GHz	105 dB
Option 014	103 dB

Reflection uncertainty

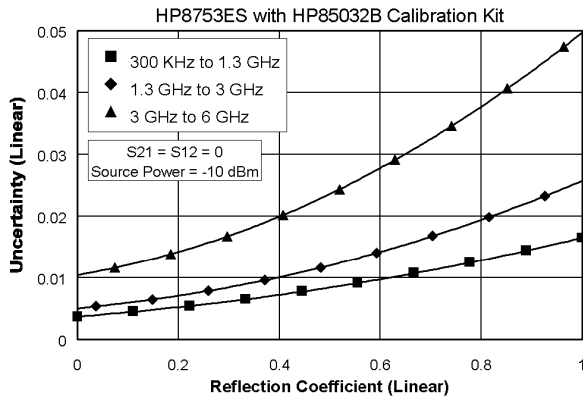

Magnitude

Measurement port characteristics

Corrected	Frequency range			
	30 kHz-300 kHz ²	300 kHz-1.3 GHz	1.3 GHz-3 GHz	3 GHz-6 GHz
Directivity	50 dB	50 dB	47 dB	40 dB
Source match	49 dB	42 dB	36 dB	31 dB
Load match	50 dB	50 dB	47 dB	40 dB
Reflection tracking	±(0.005 dB +0.02 dB/°C)	±(0.009 dB +0.01 dB/°C)	±(0.019 dB +0.02 dB/°C)	±(0.070 dB +0.03 dB/°C)
Transmission tracking	±(0.014 dB +0.02 dB/°C)	±(0.013 dB +0.01 dB/°C)	±(0.026 dB +0.02 dB/°C)	±(0.065 dB +0.03 dB/°C)

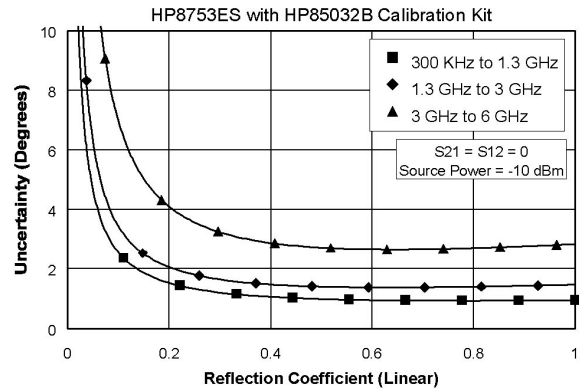

Phase

Transmission uncertainty

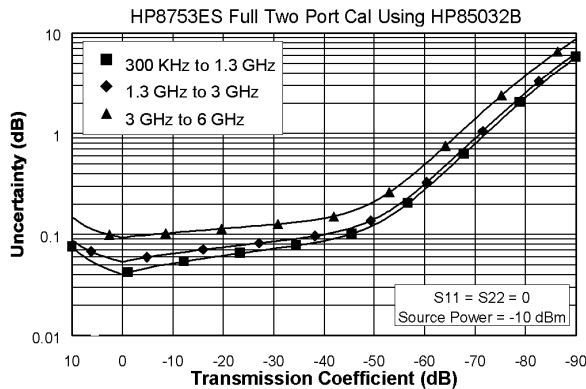

Magnitude

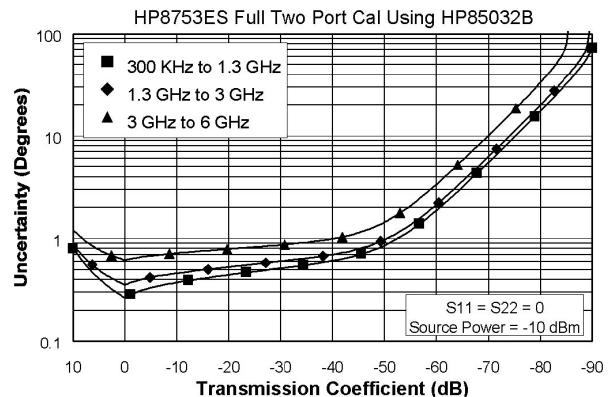

Phase

1. Typical below 300 kHz.
2. Typical performance.

System performance summaries

HP 8753ES (50-ohm systems)

3.5-mm test ports

Configuration

Network analyzer	HP 8753ES
	Standard and Option 006
Calibration kit	HP 85033D
Test-port cables	HP 11857D

System dynamic range

30 kHz to 50 kHz	70 dB ¹
50 kHz to 300 kHz	90 dB ¹
300 kHz to 16 MHz	100 dB
16 MHz to 3 GHz	110 dB
Option 014	108 dB
3 GHz to 6 GHz	105 dB
Option 014	103 dB

Measurement port characteristics

Corrected	Frequency range			
	30 kHz-300 kHz ²	300 kHz-1.3 GHz	1.3 GHz-3 GHz	3 GHz-6 GHz
Directivity	49 dB	46 dB	44 dB	38 dB
Source match	49 dB	44 dB	41 dB	37 dB
Load match	49 dB	46 dB	44 dB	38 dB
Reflection tracking	±(0.010 dB +0.02/°C)	±(0.005 dB +0.01/°C)	±(0.007 dB +0.02/°C)	±(0.009 dB +0.03/°C)
Transmission tracking	±(0.016 dB +0.02/°C)	±(0.014 dB +0.01/°C)	±(0.022 dB +0.02/°C)	±(0.048 dB +0.03/°C)

Reflection uncertainty

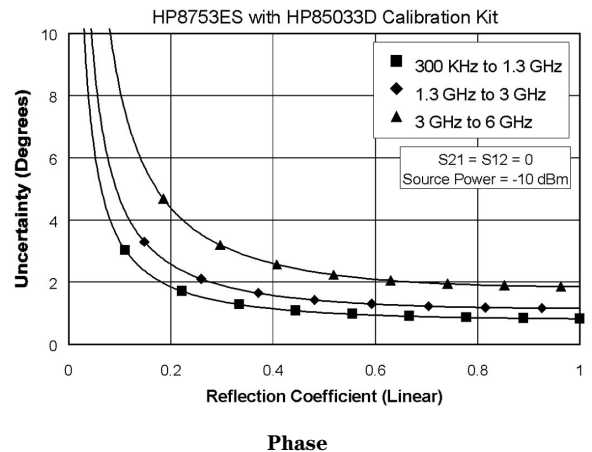
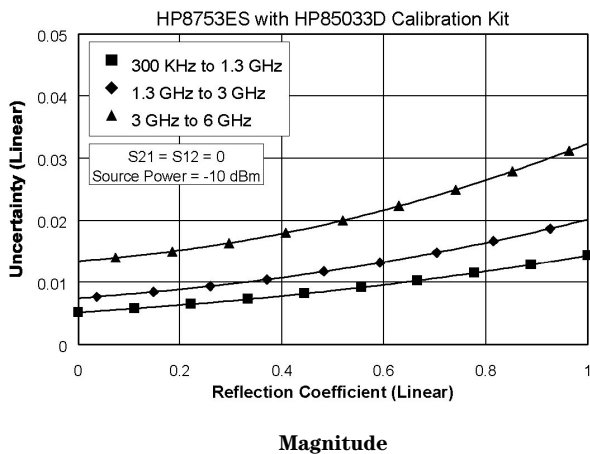

Transmission uncertainty

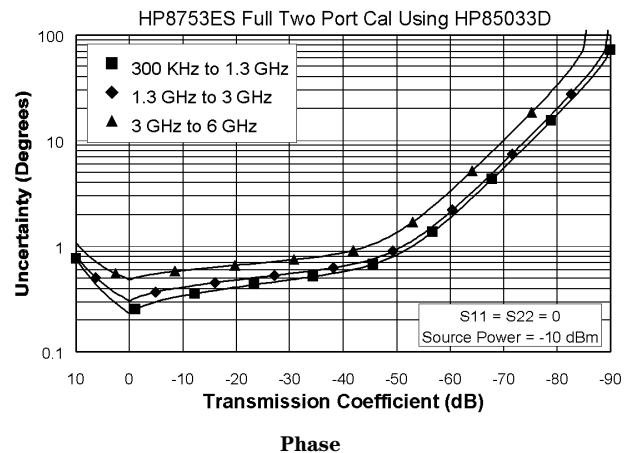
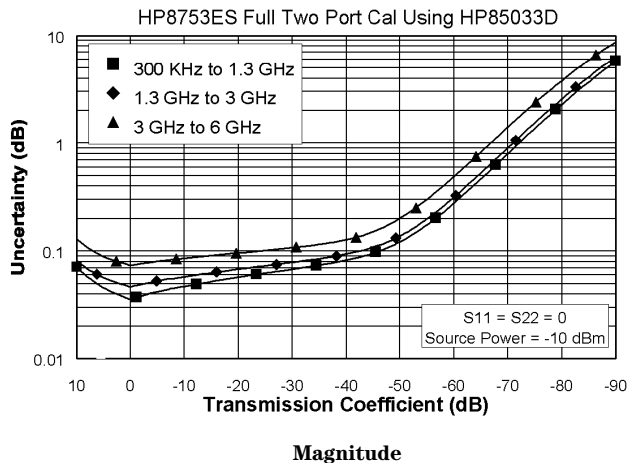

1. Typical below 300 kHz.
2. Typical performance.

System performance summaries

HP 8753ES (75-ohm systems)

Type-N test ports

Configuration

Network analyzer HP 8753ES Option 075
 Calibration kit HP 85036B
 Test-port cables HP 11857B

System dynamic range

30 kHz to 50 kHz 68 dB¹
 50 kHz to 300 kHz 90 dB¹
 300 kHz to 16 MHz 96 dB
 16 MHz to 3 GHz 106 dB

Measurement port characteristics

	Frequency range		
Corrected	30 kHz - 300 kHz ²	300 kHz - 1.3 GHz	1.3 GHz - 3 GHz
Directivity	48 dB	48 dB	43 dB
Source match	47 dB	41 dB	35 dB
Load match	48 dB	48 dB	43 dB
Reflection tracking	±(0.004 dB +0.02 dB/°C)	±(0.010 dB +0.01 dB/°C)	±(0.019 dB +0.02 dB/°C)
Transmission tracking	±0.018 dB +0.02 dB/°C)	±(0.016 dB +0.01 dB/°C)	±(0.033 dB +0.02 dB/°C)
Uncorrected ²	30 kHz - 300 kHz	300 kHz - 1.3 GHz	1.3 GHz - 3 GHz
Directivity	20 dB*	35 dB	30 dB
Source match	16 dB**	16 dB	16 dB
Load match	15 dB**	18 dB	16 dB
Reflection tracking	±2.5 dB	±1 dB	±1 dB
Transmission tracking	±2.5 dB	±1 dB	±1 dB
Crosstalk	90 dB***	100 dB	100 dB

* 15 dB, 30 to 50 kHz **10 dB, 30 to 50 kHz *** 60 dB, 30 to 50 kHz

Reflection uncertainty

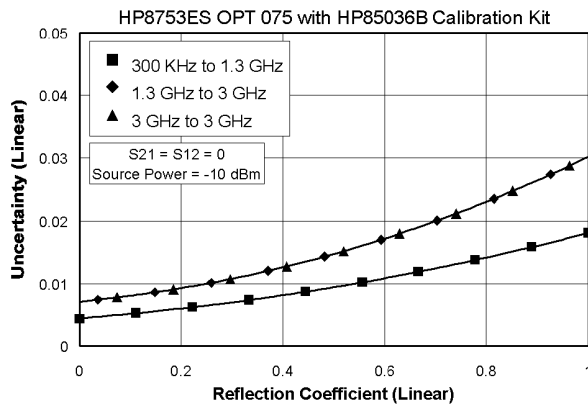

Magnitude

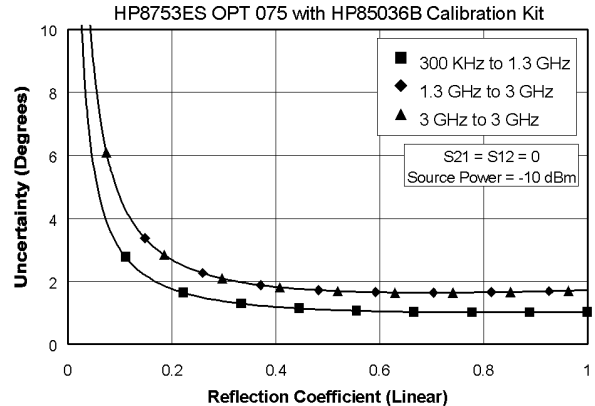

Phase

Transmission uncertainty

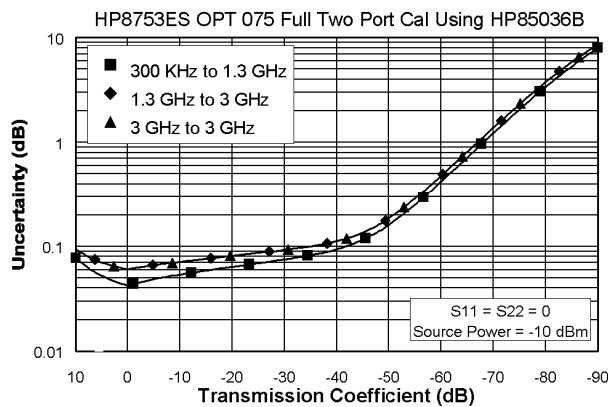

Magnitude

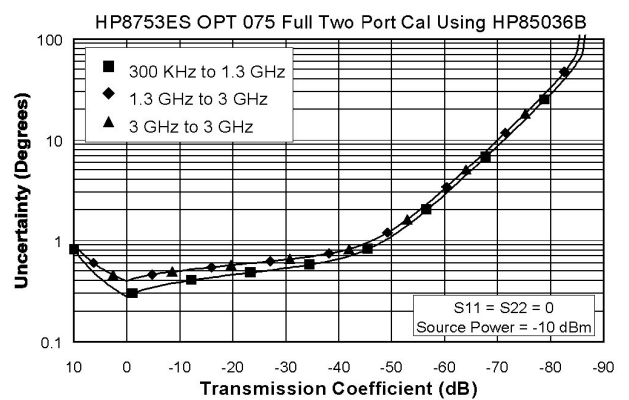

Phase

1. Typical below 300 kHz.
2. Typical performance.

System performance summaries

HP 8753ES (75-ohm systems)

Type-F test ports

Configuration

Network analyzer	HP 8753E Option 075
Calibration kit	HP 85039B
Test-port cables	HP 11857B

System dynamic range

30 kHz to 50 kHz	68 dB ¹
50 kHz to 300 kHz	90 dB ¹
300 kHz to 16 MHz	96 dB
16 MHz to 3 GHz	106 dB

Measurement port characteristics

Data is shown for a Type-F female reflection port and a Type-F male transmission port.

Corrected ²	Frequency range		
	30 kHz-300 kHz	300 kHz-1.3 GHz	1.3 GHz-3 GHz
Directivity	45 dB	45 dB	40 dB
Source match	40 dB	40 dB	30 dB
Load match	45 dB	45 dB	40 dB
Reflection tracking	±(0.060 dB +0.02 dB/°C)	±(0.060 dB +0.01 dB/°C)	±(0.024 dB +0.02 dB/°C)
Transmission tracking	±(0.033 dB +0.02 dB/°C)	±(0.019 dB +0.01 dB/°C)	±(0.057 dB +0.02 dB/°C)

Reflection uncertainty

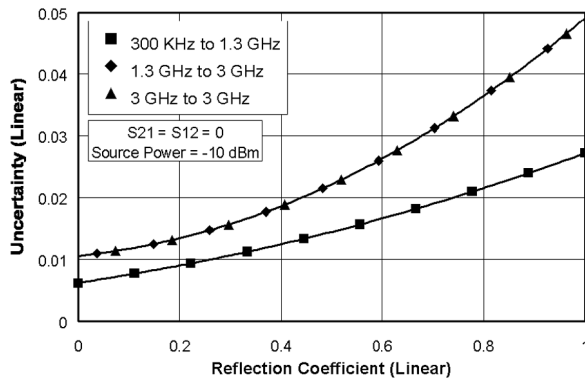

Magnitude

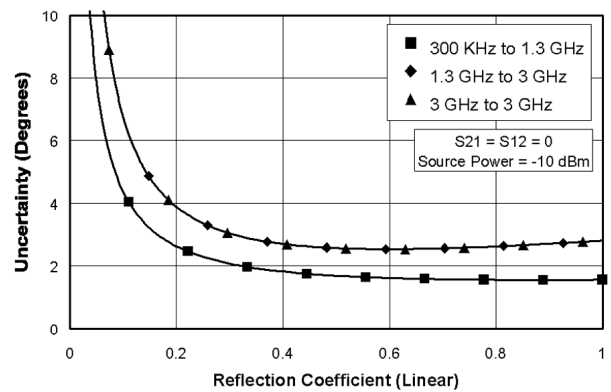

Phase

Transmission uncertainty

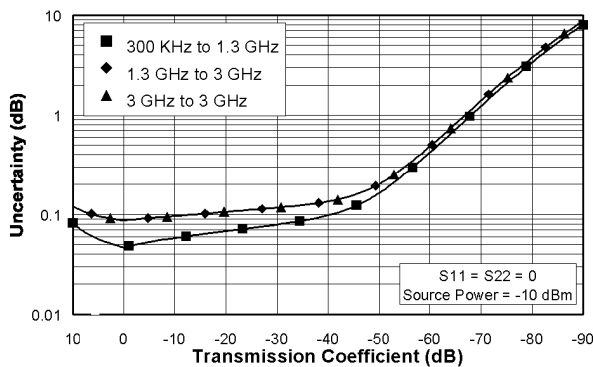

Magnitude

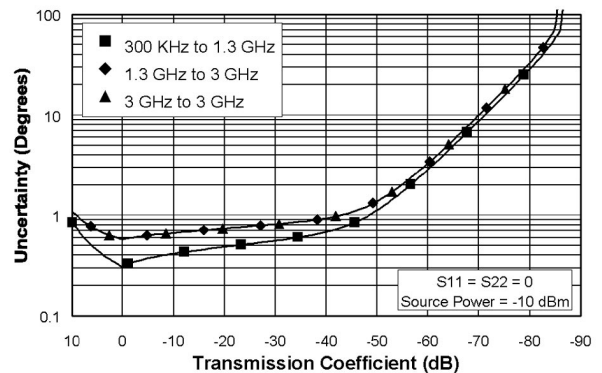

Phase

1. Typical below 300 kHz.
2. Typical performance.

System performance summaries HP 8753ET (50-ohm systems) Type-N test ports

Configuration

Network analyzer	HP 8753ET Standard, Option 006 or Option 004
Calibration kit	HP 85032B
Test port cable	HP part number 8120-4781

System dynamic range

300 kHz to 16 MHz	100 dB
16 MHz to 3 GHz	110 dB
3 GHz to 6 GHz	105 dB

Measurement port characteristics

	Frequency range		
	300 kHz-1.3 GHz	1.3 GHz-3.0 GHz	3.0 GHz-6.0 GHz
Uncorrected			
Directivity	30 dB	24 dB	19 dB
Source match ⁴	25 dB	20 dB	14 dB
Load match	24 dB	19 dB	16 dB
Reflection tracking	±1.0 dB	±1.0 dB	±2.0 dB
Transmission tracking	±1.5 dB	±1.5 dB	±2.5 dB
Crosstalk	100 dB	100 dB	90 dB

	Frequency range (continued)		
	Corrected 300 kHz-1.3 GHz	1.3 GHz-3.0 GHz	3.0 GHz-6.0 GHz
Reflection measurements¹			
Directivity	50 dB	47 dB	40 dB
Source match	42 dB	36 dB	31 dB
Load match			
One-port cal	24 dB	19 dB	16 dB
Enhanced reflection cal	24 dB	19 dB	16 dB
Reflection tracking	±(0.009 dB +0.01 dB/°C)	±(0.019 dB +0.02 dB/°C)	±(0.07 dB +0.03 dB/°C)
Transmission measurements²			
Source match			
Enhanced-response cal	42 dB	36 dB	31 dB
Response-only cal ³	25 dB	20 dB	14 dB
Transmission tracking			
Enhanced-response cal	±(0.006 dB +0.01 dB/°C)	±(0.018 dB +0.02 dB/°C)	±(0.054 dB +0.03 dB/°C)
Response-only cal	±(0.033 dB +0.01 dB/°C)	±(0.1 dB +0.02 dB/°C)	±(0.27 dB +0.03 dB/°C)

Transmission uncertainty: (enhanced-response calibration)

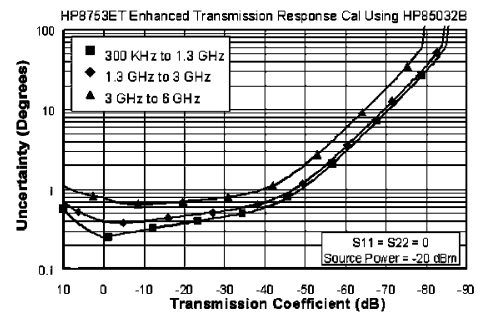
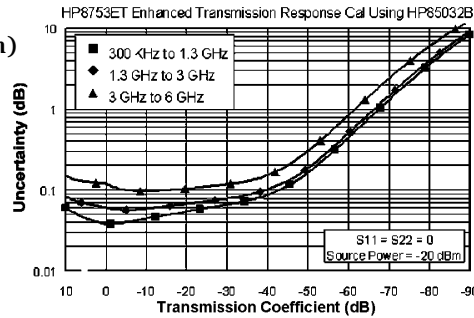

Transmission uncertainty: (response calibration)

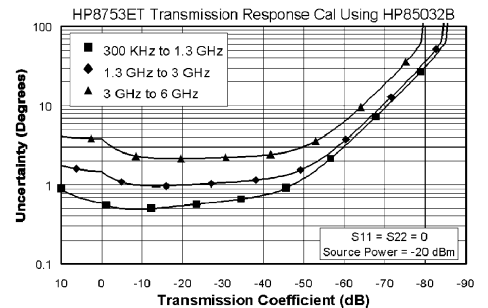
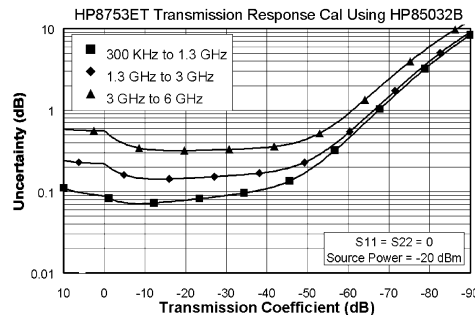

Reflection uncertainty (one-port calibration)

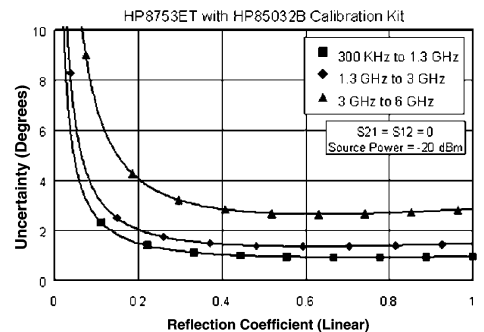
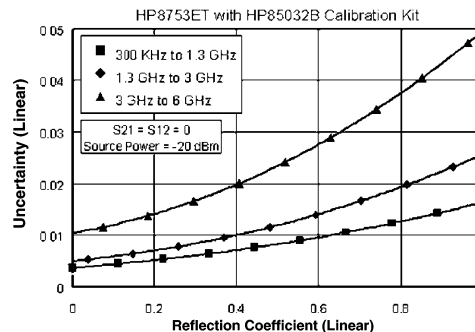

- One-port or enhanced-response calibration.
- Enhanced-response or response-only calibration.
- 2 dB less with Option 004.
- Option 004 may degrade uncorrected source match as much as 2 dB.

HP 8753ES specifications

Test-port output characteristics⁷

Frequency characteristics

Range	30 kHz to 3 GHz
Option 006	30 kHz to 6 GHz
Resolution	1 Hz
Stability⁹	±7.5 ppm (0° to 55 °C) ±3 ppm/year
Accuracy	±10 ppm at 25 °C ± 5 °C
Option 1D5	±0.05 ppm (0° to 55 °C), ±0.5 ppm/year

Power range²	-85 to +10 dBm
Option 075/014	-85 to +8 dBm

Power sweep range 25 dB (typically 31 dB)

Resolution 0.01 dB

Level accuracy^{1,2,5} ±1.0 dB

Level linearity^{1,2,5} -15 dBm to +5 dBm ±0.2 dB
5 dBm to 10 dBm⁶ ±0.5 dB

Impedance⁹	50 Ω (nominal)
30 kHz to 3 GHz	>16 dB RL (<1.38 SWR)
3 GHz to 6 GHz	>14 dB RL (<1.50 SWR)
Option 075	75 Ω (nominal)
30 kHz to 3 GHz	>16 dB RL (<1.38 SWR)

Spectral purity

2nd harmonic³	<-40 dBc at 0 dBm ⁹ <-50 dBc at -10 dBm ⁹
Option 002	<-25 dBc at 10 dBm ⁶

3rd harmonic⁴	<-40 dBc at 0 dBm ⁹ <-50 dBc at -10 dBm ⁹
Option 002	<-25 dBc at 10 dBm ⁶

Nonharmonic spurious⁹

Mixer related	<-30 dBc at 10 dBm ⁶ <-55 dBc at -10 dBm
----------------------	--

Test port input characteristics

Frequency range	30 kHz to 3 GHz
Option 006	30 kHz to 6 GHz

Average noise level^{2,8}

<3 GHz	<-82 dBm (3 kHz BW)
<3 GHz	<-102 dBm (10 Hz BW)
<3 GHz	<-110 dBm (10 Hz BW) typical
3 to 6 GHz	<-77 dBm (3 kHz BW)
3 to 6 GHz	<-97 dBm (10 Hz BW)
3 to 6 GHz	<-105 dBm (10 Hz BW) typical

Maximum input level 10 dBm

Damage level 26 dBm or 35 VDC

Impedance	50 Ω (nominal)
Option 075	75 Ω (nominal)

Frequency response^{2,5}

300 kHz to 3 GHz	±1.0 dB
3 GHz to 6 GHz	±2.0 dB

Internally generated harmonics (Option 002)

2nd harmonic³	<-15 dBc at +8 dBm <-30 dBc at 0 dBm ⁹ <-45 dBc at -15 dBm ⁹
3rd harmonic⁴	<-30 dBc at +8 dBm <-50 dBc at 0 dBm ⁹ <-50 dBc at -15 dBm ⁹

Harmonic measurement accuracy¹⁰

300 kHz to 3 GHz	±1.5 dB
3 GHz to 6 GHz	±3 dB (Option 006)

Harmonic measurement dynamic range

-40 dBc (output = -10 dBm, input = <-15 dBm)⁹

Frequency offset mode¹¹

Frequency range	300 kHz to 3 GHz
Option 006	300 kHz to 6 GHz

R-channel input requirements

Power level	
300 kHz to 3 GHz	0 to -35 dBm
3 GHz to 6 GHz	0 to -30 dBm

LO spectral purity (typical)

Maximum spurious input	<-25 dBc
Residual FM	<20 kHz

LO frequency accuracy⁹

±1 MHz at nominal frequency

1. Relative to 0 dBm output power.

2. Typical below 300 kHz.

3. 16 MHz to 3 GHz.

4. 16 MHz to 2 GHz.

5. Typical from 2 to 3 GHz for instruments with Option 075.

6. +8 dBm maximum with Option 075, or Option 014.

7. Test performed on port 1 only.

8. Instruments with Option 075 are degraded 2 dB.

9. Typical performance.

10. 25° ±5° C.

11. The HP 8753ES source characteristics and measurement accuracy in this mode are dependent on the stability of the external LO source. The RF source tracks the LO to maintain a stable IF signal at the R-channel receiver input. Degradation in accuracy is negligible when using an HP 8642A/B, 8656B, or E4432B RF signal generator as the LO source.

Test port input characteristics (continued)

External source mode ¹	(CW time sweep only)
Frequency range	300 kHz to 6 GHz
R-channel input requirements (typical)	
Power level	0 to -25 dBm
Spectral purity	
Maximum	<-30 dBc
spurious input	
Residual FM	<20 kHz
Typical settling time	500 ms (automatic)
	50 ms (manual)
Frequency readout accuracy	0.1% (automatic)
Input frequency accuracy requirement ²	
Manual	-0.5 to 5 MHz
Accuracy	(see magnitude and phase characteristics)

Magnitude characteristics

Dynamic accuracy (10 Hz IF BW)

Magnitude (300 kHz to 3GHz)

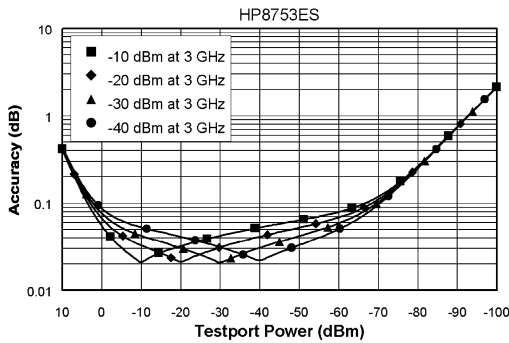

Magnitude (3 to 6GHz)

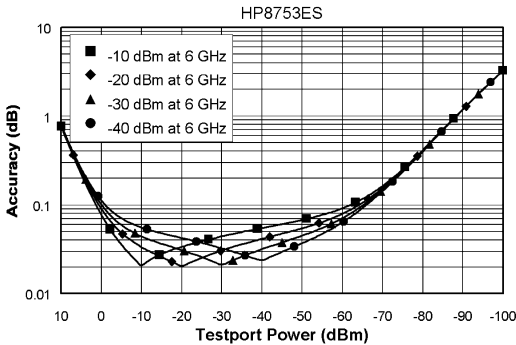

Display resolution 0.001 dB/division

Marker resolution³ 0.001 dB

Trace noise

(+5 dBm at test-port, ratio measurement, 3 kHz BW)
 300 kHz to 3 GHz < 0.006 dB rms
 3 GHz to 6 GHz < 0.010 dB rms

Reference level

Range	±500 dB
Resolution	0.001 dB
Stability ²	
30 kHz to 3 GHz	0.02 dB/°C
3 GHz to 6 GHz	0.04 dB/°C

Phase characteristics

Dynamic accuracy (10 Hz IF BW)
Range ±180°

Phase (300 kHz to 3GHz)

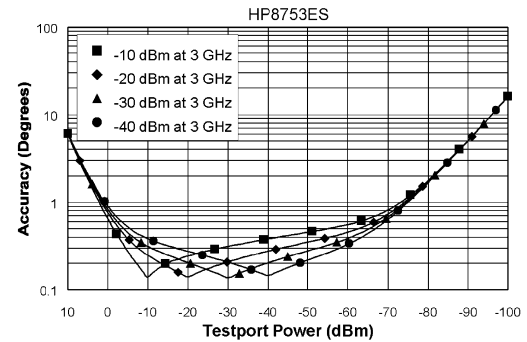

Phase (3 to 6GHz)

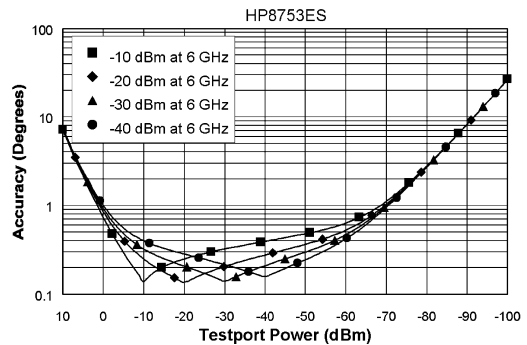

Display resolution 0.01°/division

Marker resolution³ 0.01°

Trace noise

(+5 dBm at test-port, ratio measurement, 3 kHz BW)
 300 kHz to 3 GHz < 0.038° rms
 3 GHz to 6 GHz < 0.070° rms

Reference level

Range	-180° to +180°
Resolution	0.01°
Stability	
30 kHz to 3 GHz	0.05°/°C
3 GHz to 6 GHz	0.20°/°C

Polar characteristics

Range 10 x 10⁻¹² to 1000 units
 full scale
Reference ±500 units

1. See the HP 8753ES descriptions and options for a functional description. Measurement accuracy is dependent on the stability of the input signal.
2. Typical performance.
3. Marker resolution for magnitude; phase and delay is dependent upon measured value. Resolution is limited to five digits.

HP 8753ES Option 011 specifications

Test port output characteristics

Frequency characteristics

Range	300 kHz to 3 GHz
Option 006	30 kHz to 6 GHz
Resolution	1 Hz
Stability	typically ± 7.5 ppm 0° to 55°C typically ± 3 ppm/year
Option 1D5	typically ± 0.05 ppm 0° to 55°C typically ± 0.5 ppm/year

Accuracy ± 10 ppm at $25^\circ\text{C} \pm 5^\circ\text{C}$

Power range -5 to +20 dBm
Option 006 -5 to +18 dBm

Resolution 0.01 dB

Level accuracy^{1,2} ± 1.0 dB

Level linearity^{1,2,5} ± 0.25 dB, -5 to +15 dBm
 ± 0.5 dB, +15 to +20 dBm

Impedance 50 Ω nominal
300 kHz to 3 GHz² > 16 dB RL (< 1.38 SWR)
300 kHz to 6 GHz > 14 dB RL (< 1.50 SWR)

Spectral purity

2nd harmonic³ < -40 dBc at +10 dBm⁶
 < -50 dBc at 0 dBm⁶
Option 002 < -25 dBc at max power

3rd harmonic⁴ < -40 dBc at +10 dBm⁶
 < -50 dBc at 0 dBm⁶
Option 002 < -25 dBc at max power

Nonharmonic spurious⁶

Mixer related < -30 dBc at max power
 < -55 dBc at -10 dBm

Test port input characteristics Option 011

Frequency range 300 kHz to 3 GHz
Option 006 30 kHz to 6 GHz

Average noise level²

50 kHz to 3 GHz	< -90 dBm (3 kHz BW)
50 kHz to 3 GHz	< -110 dBm (10 Hz BW)
50 kHz to 3 GHz	< -120 dBm (10 Hz BW) typical
3 to 6 GHz	< -85 dBm (3 kHz BW)
3 to 6 GHz	< -105 dBm (10 Hz BW)
3 to 6 GHz	< -115 dBm (10 Hz BW) typical

Maximum input level 0 dBm

Damage level 20 dBm or 25 VDC

Impedance: 50 ohms nominal
300 kHz to 2 MHz ≥ 20 dB RL
2 MHz to 1.3 GHz ≥ 24 dB RL
1.3 GHz to 3 GHz ≥ 19 dB RL
Option 006
3 GHz to 6 GHz ≥ 15 dB RL⁶

Frequency response

300 kHz to 3 GHz	± 1.0 dB,
3 GHz to 6 GHz	± 2.0 dB

Harmonics (Option 002)

2nd harmonic³ < -15 dBc at 0 dBm
 < -30 dBc at -10 dBm⁶
 < -45 dBc at -30 dBm⁶
3rd harmonic⁴ < -30 dBc at 0 dBm
 < -50 dBc at -10 dBm⁶
 < -50 dBc at -30 dBm⁶

Harmonic measurement accuracy

16 MHz to 3 GHz ± 1.5 dB
3 GHz to 6 GHz Option 006 ± 3 dB

Harmonic measurement dynamic range

-40 dBc⁶ (output = -10 dBm,
input < -15 dBm)

1. +10 dBm output power for the HP 8753ES Option 011.

2. Typical below 300 kHz.

3. 16 MHz to 3 GHz.

4. 16 MHz to 2 GHz.

5. For HP 8753ES Option 011 and Option 006, linearity is specified for the ranges of -5 to +13 dBm and +13 to +18 dBm.

6. Typical performance.

HP 8753ES Option 011 specifications

Test port input characteristics (continued)

Frequency offset mode³

Frequency range	300 kHz to 3 GHz
Option 006	300 kHz to 6 GHz

R-channel input requirements

Power level

300 kHz to 3 GHz	0 to -35 dBm
3 GHz to 6 GHz	0 to -30 dBm

LO spectral purity

Maximum spurious input	<-25 dBc
-------------------------------	----------

Residual FM	<20 kHz
--------------------	---------

LO frequency accuracy	±1 MHz at nominal frequency
------------------------------	-----------------------------

External source mode⁴ (CW time sweep only)

Frequency range	300 kHz to 6 GHz
------------------------	------------------

R-channel input requirements¹

Power level	0 to -25 dBm
--------------------	--------------

Spectral purity

Maximum spurious input	<-30 dBc
------------------------	----------

Residual FM	<20 kHz
--------------------	---------

Typical settling time¹	500 ms (automatic) 50 ms (manual)
--	--------------------------------------

Input frequency accuracy requirement¹

Manual:	-0.5 to 5 MHz
----------------	---------------

Display resolution	0.001 dB/division
---------------------------	-------------------

Marker resolution⁵	0.001 dB
--------------------------------------	----------

Trace noise

(+5 dBm at test-port, ratio measurement, 3 kHz BW)

Magnitude

300 kHz to 3 GHz	< 0.006 dB rms
3 GHz to 6 GHz	< 0.010 dB rms

Phase

300 kHz to 3 GHz	< 0.038° rms
3 GHz to 6 GHz	< 0.070° rms

Reference level

Range	±500 dB
--------------	---------

Resolution	0.001 dB
-------------------	----------

Stability²

30 kHz to 3 GHz	0.02 dB/°C
-----------------	------------

3 GHz to 6 GHz	0.04 dB/°C
----------------	------------

Range	±180°
--------------	-------

Display resolution	0.01°/division
---------------------------	----------------

Marker resolution⁵	0.01°
--------------------------------------	-------

Trace noise²

30 kHz to 3 GHz	< 0.038° rms
-----------------	--------------

3 GHz to 6 GHz	< 0.070° rms
----------------	--------------

(+5 dBm at test port, ratio measurement, 3 kHz BW)

Reference level

Range	-180° to +180°
--------------	----------------

Resolution	0.01°
-------------------	-------

Stability

30 kHz to 3 GHz	0.05°/°C
-----------------	----------

3 GHz to 6 GHz	0.20°/°C
----------------	----------

Polar characteristics

Range	10 x 10 ⁻¹² to 1000 units full scale
--------------	---

Reference	±500 units
------------------	------------

1. Typical performance.

2. Typical below 300 kHz.

3. The HP 8753ES source characteristics and measurement accuracy in this mode are dependent on the stability of the external LO source. The RF source tracks the LO to maintain a stable IF signal at the R-channel receiver input. Degradation in accuracy is negligible when using an HP 8642A/B, 8656B, or E4432B RF signal generator as the LO source.

4. See the HP 8753ES descriptions and options for a functional description. Measurement accuracy is dependent on the stability of the input signal.

5. Marker resolution for magnitude, phase and delay is dependent upon measured value. Resolution is limited to five digits.

HP 8753ET specifications

Test-port output characteristics

Frequency characteristics

Range	300 kHz to 3 GHz
Option 006	300 kHz to 6 GHz
Resolution	1 Hz
Stability⁴	±7.5 ppm (0° to 55 °C)
Option 1D5	±3 ppm/year ±0.05 ppm (0° to 55 °C) ±0.5 ppm/year

Accuracy	±10 ppm at 25 °C ±5 °C
Power range:	-20 to +5 dBm -85 to +10 dBm (with Option 004)

Resolution 0.01 dB

Level accuracy¹ ±1.0 dB

Level linearity¹

Standard	
-20 to -15 dBm	±0.5 dB
-15 to 0 dBm	±0.2 dB
0 to +5 dBm	±0.5 dB

Option 004	
-15 to +5 dBm	±0.2 dB
+5 to +10 dBm	±0.5 dB

Impedance	50 Ω (nominal)
300 kHz to 3 GHz	>18 dB RL (< 1.28 SWR)
3 GHz to 6 GHz	> 14 dB RL (<1.50 SWR)

Spectral purity

2nd harmonic²	<-40 dBc at 0 dBm ⁴ <-50 dBc at -10 dBm ⁴
Option 002	<-25 dBc at maximum output power
3rd harmonic³	<-40 dBc at 0 dBm <-50 dBc at -10 dBm
Option 002	<-25 dBc at maximum output power

Nonharmonic spurious

Mixer related	<-30 dBc at +10 dBm <-55 dBc at -10 dBm
----------------------	--

Test port input characteristics

Frequency range	300 kHz to 3 GHz
Option 006	300 kHz to 6 GHz
Average noise level	
300 kHz to 3 GHz	<-90 dBm (3 kHz BW)
300 kHz to 3 GHz	<-110 dBm (10 Hz BW)
300 kHz to 3 GHz	<-120 dBm (10 Hz BW) typical
3 GHz to 6 GHz	<-85 dBm (3 kHz BW)
3 GHz to 6 GHz	<-105 dBm (10 Hz BW)
3 GHz to 6 GHz	<-114 dBm (10 Hz BW) typical

Maximum input level	+10 dBm reflection port 0 dBm transmission port
Damage level	>+26 dBm or 35 VDC
Impedance	50 Ω (nominal)

Frequency response⁵	
300 kHz to 3 GHz	±1.0 dB
3 GHz to 6 GHz	±2.0 dB

Harmonics (Option 002)

2nd harmonic²	<-15 dBc at +8 dBm <-30 dBc at 0 dBm ⁴ <-45 dBc at -15 dBm ⁴
3rd harmonic³	<-30 dBc at +8 dBm <-50 dBc at 0 dBm ⁴ <-50 dBc at -15 dBm ⁴

Harmonic measurement accuracy⁵

300 kHz to 3 GHz	±1.5 dB
3 GHz to 6 GHz	±3 dB (Option 006)

Harmonic measurement dynamic range⁴

-40 dBc	(output = -10 dBm, input = <-15 dBm)
---------	---

Frequency offset mode⁶

Frequency range	300 kHz to 3 GHz
Option 006	300 kHz to 6 GHz

R-channel input requirements

Power level	
300 kHz to 3 GHz	0 to -35 dBm
3 GHz to 6 GHz	0 to -30 dBm

LO Spectral purity

Maximum spurious input	<-25 dBc
Residual FM	<20 kHz

LO frequency accuracy⁶ ±1 MHz at nominal frequency

1. Relative to -5 dBm output power for the HP 8753ET; -10 dBm output power for HP 8753ET with Option 004.

2. 16 MHz to 3 GHz.

3. 16 MHz to 2 GHz.

4. Typical performance.

5. 25° C ±5° C.

6. The HP 8753ET source characteristics and measurement accuracy in this mode are dependent on the stability of the external LO source. The RF source tracks the LO to maintain a stable IF signal at the R-channel receiver input. Degradation in accuracy is negligible when using an HP 8642A/B, 8656B, or E4432B RF signal generator as the LO source.

HP 8753ET specifications

Test-port input characteristics (continued)

External source mode¹ (CW time sweep only)

Frequency range 300 kHz to 6 GHz

R-channel input requirements²

Power level 0 to -25 dBm

Spectral purity

Maximum spurious <-30 dBc

input

Residual FM <20 kHz

Typical settling time 500 ms (automatic)

50 ms (manual)

Frequency readout 0.1% (automatic)

accuracy²

Input frequency accuracy requirement²

Manual: -0.5 to 5 MHz

Accuracy (See magnitude and phase characteristics)

Magnitude characteristics

Dynamic accuracy (10 Hz IF BW)

Magnitude (300 kHz to 3 GHz)

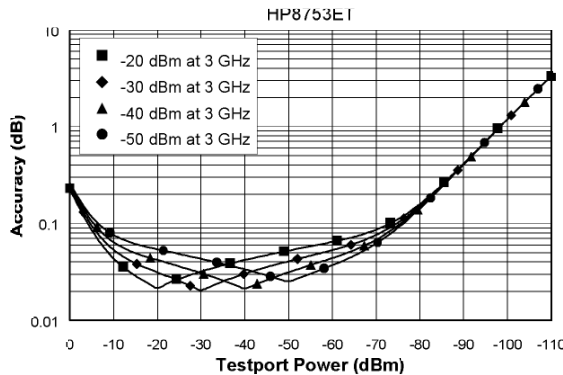

Magnitude (3 to 6 GHz)

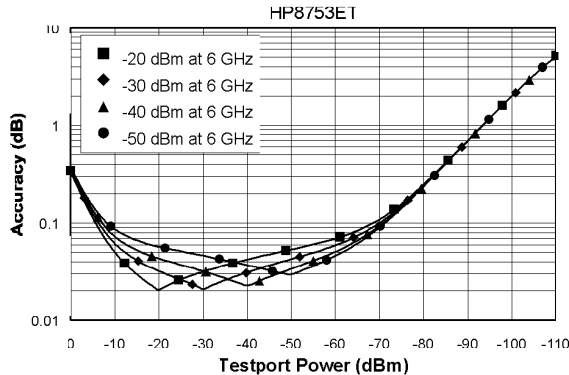

Display resolution 0.001 dB/division

Marker resolution³ 0.001 dB

Trace noise

(0 dBm at transmission port or +5 dBm at reflection port, ratio measurement, 3 kHz BW)

300 kHz to 3 GHz < 0.006 dB rms

3 GHz to 6 GHz < 0.010 dB rms

Reference level

Range ± 500 dB

Phase (300 kHz to 3 GHz)

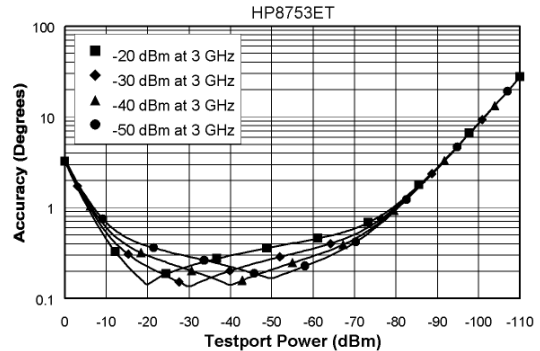

Phase (3 to 6 GHz)

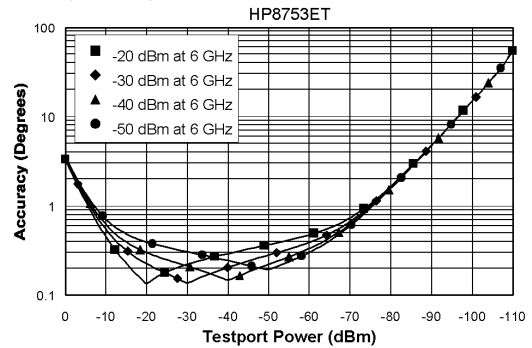

Resolution 0.001 dB

Stability²

300 kHz to 3 GHz 0.02 dB/1 °C

3 GHz to 6 GHz 0.04 dB/1 °C

Phase characteristics

Dynamic accuracy (10 Hz IF BW)

Range $\pm 180^\circ$

Display resolution 0.01°/division

Marker resolution³ 0.01°

Trace noise

(0 dBm at transmission port or +5 dBm at reflection port, ratio measurement, 3 kHz BW)

300 kHz to 3 GHz < 0.038° rms

3 GHz to 6 GHz < 0.070° rms

Reference level

Range -180° to $+180^\circ$

Resolution 0.01°

Stability

30 kHz to 3 GHz 0.05°/°C

3 GHz to 6 GHz 0.20°/°C

Polar characteristics

Range 10×10^{-12} to 1000 units full scale

Reference ± 500 units

1. See the HP 8753ET/ES descriptions and options for a functional description. Measurement accuracy is dependent on the stability of the input signal.

2. Typical performance.

3. Marker resolution for magnitude, phase and delay is dependent upon measured value. Resolution is limited to five digits.

HP 8753ET/ES supplemental characteristics

Measurement

Number of display channels

Four display channels available.

Number of measurement channels

Two primary and two auxiliary measurement channels available.

Measurement parameters

HP 8753ET: Reflection, transmission, A, B, R, A/R, B/R, A/B. Conversion to impedance or admittance.

HP 8753ES: S11, S21, S12, S22, A, B, R, A/R, B/R, A/B. Conversion to impedance or admittance.

Formats

Cartesian: log/linear magnitude, phase, group delay, SWR, real and imaginary.

Smith chart: with log/linear amplitude and phase, R + jX, G + jB, or real/imaginary markers.

Polar: with linear/log amplitude, phase, or real and imaginary markers.

Data markers

Each display channel has five independent markers that can be displayed simultaneously. Twenty independent markers can be displayed in 4-channel display mode when markers are uncoupled.

Marker functions

Markers can be used in various functions: Marker search (Mkr to max, Mkr to min, Mkr to target), Mkr bandwidth with user-defined target values, Mkr to start, Mkr to stop, Mkr to center, Mkr to span, Mkr to reference, Mkr to delay, and trace statistics (average value, standard deviation, and peak-to-peak deviation of the data trace between two markers). The tracking function enables continuous update of marker search values on each sweep.

Group delay characteristics

Aperture: selectable

Maximum aperture: 20% of frequency span

Minimum aperture: (freq. span) / (number of points + 1)

Range

The maximum delay is limited to measuring no more than 180° of phase change within the minimum aperture. Range = 1 / (2 x minimum aperture)

Accuracy

The following graph shows group-delay accuracy at 1.3 GHz with type-N full two-port calibration and 10-Hz IF bandwidth. Insertion loss is assumed to be < 2 dB and electrical length to be ten meters.

Group Delay (Typical)

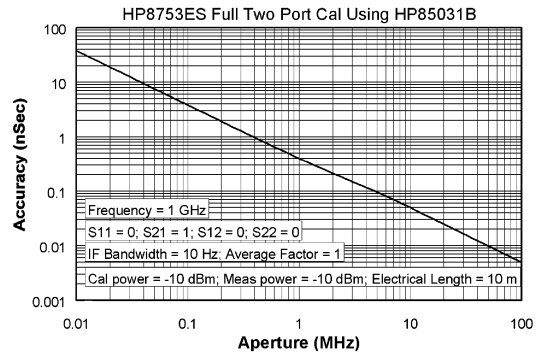

Source control

Sweep limits

Set start/stop or center/span of the stimulus parameter (frequency, power, time) directly through the source control keys and the control knob, the step keys or the data entry keyboard.

Sweep type

Set a linear or logarithmic sweep, an arbitrarily defined frequency list, a power sweep or a CW (single frequency) type of sweep.

Measured number of points per sweep

Linear frequency: choose 3, 11, 26, 51, 101, 201, 401, 801, or 1601 points.

Fast swept list

Define up to 30 different sub-sweep frequency ranges in any combination of CW, center/span, or start-stop sweep modes. Set test-port power levels and IF bandwidth independently for each segment.

Sweep modes

Set a coupled channel sweep (same stimulus conditions on both channels) or an uncoupled channel sweep.

Chop/alternate

Select whether to alternately or simultaneously (chop) measure channels when in dual-channel mode. Chop mode is faster, while alternate mode optimizes dynamic range.

Sweep time

Set sweep time in seconds, minutes or hours.

Automatic sweep time

Select auto sweep time by entering zero seconds sweep time. The analyzer will sweep at the minimum sweep time for any subsequently selected stimulus conditions. Auto sweep time is the default condition.

HP 8753ET/ES supplemental characteristics (continued)

Sweep trigger

Set to either continuous, single, group sweep, or external trigger. Set external trigger to take a complete sweep or to measure individual points in a frequency, power or list sweep.

Power

Set source power from -20 to +5 dBm for the HP 8753ET¹ or from -85 to +10 dBm for the HP 8753ES². Power slope can be set in dBm/GHz.

Power meter calibration

Select continuous leveling or use a correction table to modify source power. The correction table is created with an initial single sweep. Make single or multiple power meter readings at each frequency.

Data accuracy enhancement

Measurement calibration

Measurement calibration significantly reduces measurement uncertainty due to errors caused by system directivity, source and load match, tracking, and crosstalk. Full two-port calibration removes all the systematic errors to obtain the most accurate measurements.

Calibration types available

• Frequency response

Simultaneous magnitude and phase correction of frequency response errors for either reflection or transmission measurements.

• Response and isolation

Compensates for frequency response and directivity (reflection) or frequency response and crosstalk errors.

• Enhanced response calibration

Corrects for frequency response and source match for transmission measurements, and provides one-port calibration for reflection measurements.

• One-port calibration

Uses test set port 1 or port 2 to correct for directivity, frequency response and source match errors.

• Two-port calibration

Compensates for directivity, source match, reflection frequency response, load match, transmission frequency response and crosstalk for an S-parameter test set. Crosstalk calibration can be omitted. Available on HP 8753ES analyzers.

• TRL*/LRM* calibration

Compensates for directivity, reflection and transmission frequency response, and crosstalk in both the forward and reverse directions. Especially suitable for calibrating non-coaxial environments, such as in test fixtures. TRL*/LRM* is a special implementation of TRL/LRM calibration, modified for the three-sampler receiver in the HP 8753ES. Available on HP 8753ES analyzers.

Interpolated error correction

With any type of accuracy enhancement applied, interpolated mode recalculates the error coefficients when the test frequencies are changed. The number of points can be increased or decreased and the start/stop frequencies can be changed, but the resulting frequency span must be a subset of the original calibration frequency span. System performance is not specified for measurements with interpolated error correction applied.

Velocity factor

Enters the velocity factor to calculate equivalent electrical length.

Reference plane extension

Redefine the plane-of-measurement reference to other than port 1 or port 2 of the HP 8753ET and 8753ES.

Select default calibration kit

Select from a list of standard calibration kits or choose a user-defined kit.

Data averaging

IF bandwidth:

The IF bandwidth is selectable from 6 kHz to 10 Hz

Weighted sweep-to-sweep averaging:

Averages vector data on each successive sweep.

Trace smoothing

Computes the moving average of adjacent data points. Smoothing aperture defines the trace width (number of points) to be averaged, and ranges from 0.25% to 20% of the trace width.

Display control

Display formats

Single-channel, dual-channel overlay (both traces on one graticule), dual-channel split (each trace on separate graticules), three-channel split (each trace on separate graticules), three-channel overlay (three traces on one graticule), quad-channel overlay (four traces on one graticule), quad-channel split (each trace on separate graticules).

1. -85 to +5 dBm with Option 004.

2. +8 dBm maximum with Option 075 or 014.

HP 8753ET/ES supplemental characteristics (continued)

Trace functions

Display data

Display current measurement data, memory data, or current measurement with measurement and memory data simultaneously.

Trace math

Vector division or subtraction of current linear measurement values and memory data.

Display annotations

Start/stop, center/span, or CW frequency, source level, scale/div, reference level, marker data, softkey functions, warning and caution messages, trace identification, and pass/fail indication.

Autoscale

Automatically selects scale resolution and reference value to center the trace.

Electrical delay

Offset measured phase or group delay by a defined amount of electrical delay, in seconds.

Frequency blanking

Blank out all frequency information on the display. Requires an instrument preset to re-enable frequency information on the display.

Title

Add custom titles (49 characters maximum) to the display.

Adjust display

Customize the color and brightness of the data traces, memory traces, reference lines, graticules, text, and warning messages. Default colors can be recalled along with one set of user-defined display values.

Storage

Instrument state

Up to 31 instrument states can be stored internally or recalled via the SAVE/RECALL menu. Instrument states include all control settings, active limit lines, active list frequency tables, memory trace data, active calibration coefficients, and custom display titles. Storage is in nonvolatile memory.

Test sequences

Six measurement sequences can be stored or recalled via the sequencing menu. Sequences may also be recalled from Preset menu. Sequence register 6 is part of nonvolatile storage and is not erased during a power cycle. If sequence 6 is titled AUTO, it will be executed when power is turned on.

Disk drive

Data, instrument states, user graphics, data plots and test sequences can be stored on internal floppy disk in MS-DOS® or Hewlett-Packard's standard LIF formats.

Data hardcopy

Data plotting

Hardcopy plots are automatically produced with HP-GL compatible digital plotters. The HP 8753ET/ES provides Centronics, RS-232C, and GP-IB interfaces.

Data listings

Printouts of instrument data are directly produced with a printer such as the HP DeskJet or LaserJet. Select black & white or color print. For a list of compatible printers, consult our printer-compatibility guide Web page at <http://www.hp.com/go/pcg>

Configure plots

Configure plots completely from the network analyzer by defining pen color and line type for data, text markers, graticules, and memory traces.

Functions

Plot trace(s), graticule(s), marker(s), or text including operating and system parameters.

Quadrants

Plot entire display in one of four different quadrants of the plotter paper.

System capabilities

Limit lines

Define test limit lines that appear on the display for go/no go testing. Lines may be any combination of horizontal, sloping lines, or discrete data points. Limit-test TTL output available for external control or indication.

External source mode

The receiver (input R) detects and phase-locks to any externally generated CW signal. Receiver inputs A and B will measure this same frequency for comparison or tracking measurements.

Automatic

The input signal frequency is counted and displayed.

Manual

Measures the input signal closest to the frequency specified by the user (within +0.5 to +5 MHz).

Tuned receiver

Tunes the receiver for a synthesized CW input signal at a precisely specified frequency. The time bases of the external RF source or sources must be tied to the external reference input (rear panel BNC). The built-in RF source is not used.

HP 8753ET/ES supplemental characteristics (continued)

Frequency offset on/off

Sets the RF source to be swept at a fixed offset frequency above the receiver as required in a swept RF/IF, fixed LO, mixer test.

Service menu

Select the desired service test, service diagnostic, service or verification mode.

Test sequences

Description

Create, edit, save or recall a series of front-panel keystrokes to automate a measurement. Test sequences may contain basic stimulus and measurement functions (frequency, power, parameter, format, scale) advanced operations (time domain, limit testing, display marker values) and basic logical branching (IF limit test fails DO sequence 5 or GOSUB).

Storage

Test sequences can be stored internally to a disk drive and can be loaded from a computer over the GP-IB interface. Sequence 6 is saved in nonvolatile storage and can be used as an autostart routine when titled AUTO.

General purpose input/output

Read or write bits to the output port to control external devices such as part handlers. Eight output and five input TTL lines are available on the parallel port.

Other functions

PAUSE/continue, wait, title sequence, print sequence, duplicate sequence, pause and select.

Time-domain (Option 010)

With the time-domain option, data from transmission or reflection measurements in the frequency domain are converted to the time domain using a Fourier transformation technique (chirp Z) and presented on the display. The time-domain response shows the measured parameter value versus time. Markers may also be displayed in electrical length (or physical length if the relative propagation velocity is entered).

Time stimulus modes

Two types of time excitation stimulus waveforms can be simulated during the transformations, a step and an impulse.

• Low-pass step

This stimulus, similar to a traditional time-domain reflectometer (TDR) stimulus waveform, is used to measure low-pass devices. The frequency-domain data should extend from DC (extrapolated value) to a higher value.

• Low-pass impulse

This stimulus is also used to measure low-pass devices.

• Bandpass impulse

The bandpass impulse stimulates a pulsed RF signal (with an impulse envelope) and is used to measure the time-domain response of band-limited devices.

Windows

The windowing function can be used to modify (filter) the frequency-domain data and thereby reduce overshoot and ringing in the time-domain response. Three types of windows are available: minimum, normal, and maximum.

Gating

The gating function can be used to selectively remove reflection or transmission time-domain responses. In converting back to the frequency-domain the effects of the responses outside the gate are removed.

Remote programming

Interface

HP-IB interface operates to IEEE 488-1978 and IEC 625 standards and IEEE 728-1982 recommended practices.

Addressing

The GP-IB address can be verified or set from the front panel via the local menu and can range from 0 to 30 decimal (factory set at 16).

Pass control

Allows the HP 8753ET/ES to request control of the GP-IB (when an active controller is present) whenever it needs to output to a plotter or printer.

System controller

Lets an HP 8753ET/ES become a controller on the GP-IB to directly control a plotter or a printer.

Talker/listener

Lets the HP 8753ET/ES become an GP-IB talker/listener when an external controller is present.

Transfer formats

Binary (internal 48-bit floating-point complex format)
ASCII 32- or 64-bit IEEE 754 floating-point format

User-accessible graphics

Using a subset of HP Graphics Language (HP-GL), vector or text graphics may be written on the HP 8753ET/ES via GP-IB. Up to 5 kbytes of data can be stored at one time (4 bytes per vector, 2 bytes per character).

Interface function codes

SH1, AH1, T6, TE0, L4, LE0, SR1, RL1, PP0, DC1, DT0, C1, C2, C3, C10, E2

General characteristics

Front panel connectors

HP 8753ES test ports (without Option 011)

Connector type	7 mm, precision
Impedance	50 ohms (nominal)

HP 8753ES Option 011 test ports

Connector type	Type-N female
Impedance	50 ohms (nominal)

HP 8753ES Option 075 test ports

Connector type	Type-N female
Impedance	75 ohms (nominal)

HP 8753ET test ports

Connector type	Type-N female
Impedance	50 ohms (nominal)

Probe power	+15V \pm 2% 400 mA (combined load for both probe connections) -12.6V \pm 5.5% 300 mA (combined load for both probe connections)
-------------	--

Rear-panel connectors

External reference frequency input (EXT REF INPUT)

Frequency	1, 2, 5, and 10 MHz (\pm 200 Hz at 10 MHz)
Level	-10 dBm to +20 dBm, (typical)
Impedance	50 ohms
Connector	BNC (f)

High-stability frequency reference output (Option 1D5)

Frequency	10.0000 MHz
Frequency stability (0 °C to 55 °C)	\pm 0.05 ppm
Daily aging rate (after 30 days)	$<3 \times 10^{-9}$ /day
Yearly aging rate	0.5 ppm/year
Output	0 dBm minimum
Nominal output impedance	50 Ω Connector BNC (f)

External auxiliary input (AUX INPUT)

Input voltage limits	-10V to +10V
----------------------	--------------

External AM input (EXT AM)

\pm 1 volt into a 5 k Ω resistor, 1 kHz maximum, resulting in approximately 8 dB/volt amplitude modulation. BNC (f) connector.

External trigger (EXT TRIGGER)

Triggers on a negative TTL transition or contact closure to ground. BNC (f) connector.

Test sequence output (TEST SEQ)

By default, this connector outputs a TTL end-of-sweep signal. It can also be programmed by the user in a test sequence to output a user-defined TTL signal. BNC (f) connector.

Limit test output (LIMIT TEST)

This connector outputs a TTL signal of the limit test results. Pass: TTL high. Fail: TTL low. BNC (f) connector.

Test-port bias input (BIAS CONNECT) (HP 8753ES only)

Maximum voltage	+30 VDC
Maximum current (no degradation in RF specs)	\pm 200 mA
Maximum current	\pm 1 A
Connector	BNC (f)

VGA video output (EXT MON)

This connector drives external VGA monitors.

GP-IB

This connector allows communications with compatible devices including external controllers, printers, plotters, disk drives, and power meters.

Parallel port

This 25-pin female connector is used with parallel peripherals. It can also be used as a general purpose I/O port.

RS-232C

This 9-pin male connector is used with serial peripherals.

DIN keyboard

This mini-DIN connector is used for adding an IBM PC-AT compatible keyboard.

Test set interconnect

This connector is used to connect an HP 8753ES Option 011 to the HP 85046A/B or 85047A test set. HP 8753ES analyzers without Option 011 can use signal levels on this connector for sequencing or general purpose I/O applications.

Internal memory

Typical data retention time with 3V, 1.2 Ah battery:

At 25 °C	11904 days (32.6 years)
At 40 °C	1244 days (3.4 years)
At 70 °C	250 days (0.68 year)

Line power

48 Hz to 66 Hz
115V nominal (90V to 132V) or 230V nominal (198V to 264V).
280 VA max.

1. F_{\max} is the upper frequency limit of the associated test set.
2. Degrees, specified as deviation from linear phase.

Environmental characteristics

General conditions

RFI and EMI susceptibility: defined by VDE 0730, CISPR Publication 11, and FCC Class B Standards.

ESD (electrostatic discharge): must be eliminated by use of static-safe work procedures and an anti-static bench mat. The flexible rubber keypad protects key contacts from dust, but the environment should be as dust-free as possible for optimal reliability.

Operating conditions

Temperature (unless otherwise noted)	0° to 55 °C
Humidity	5% to 95% at 40 °C (non-condensing)
Altitude	0 to 4500 meters (15,000 feet)

Non-operating storage conditions

Temperature	-40 °C to +70 °C
Humidity	0 to 90% relative at +65 °C (non-condensing)
Altitude	0 to 15,240 meters (50,000 feet)

Weight (HP 8753ET/ES)

Net	21 kg (46 lb)
Shipping	35 kg (77 lb)

Cabinet dimensions (HP 8753ET/ES)

(These dimensions exclude front and rear panel protrusions.)

222 mm H x 425 mm W x 457 mm D
(8.75 in x 16.75 in x 18.0 in)

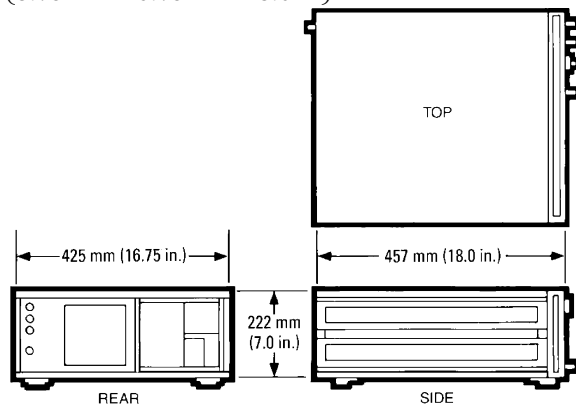

HP 8753ET/ES physical dimensions

Measurement throughput summary

The following table shows typical measurement times in milliseconds.

Measurement	Typical time for completion (msec)			
	Number of Points			
	51	201	401	1601
Start=1 GHz, Span=10 MHz, IFBW=6 kHz				
Uncorrected, 1-port calibration: ¹	32	70	121	423
Two-port calibration: ²	62	139	240	848
Start=30 kHz, Stop=3 GHz, IFBW=6 kHz				
Uncorrected, 1-port calibration ¹	202	270	304	615
Two-port calibration ²	402	540	607	1237
Start=30 kHz, Stop=6 GHz, IFBW=6 kHz				
Uncorrected, 1-port calibration ¹	310	380	415	658
Two-port calibration ²	618	757	829	1315
Time domain (increase over uncorrected sweep time)³				
Conversion	12	42	86	378
Gating	14	40	80	349
GP-IB data transfer⁴				
Internal binary	10	16	21	58
ASCII	35	112	214	831
IEEE 754 floating point format				
32-bit	11	19	28	83
64-bit	13	26	42	141

Options

Harmonic measurements (Option 002)

Measures amplifier 2nd and 3rd harmonics on a swept-frequency basis for fundamental signals above 16 MHz.

Dynamic range (source at +10 dBm, receiver <+30 dBm) +40 dBc (minimum)
Accuracy⁵ ±1 dB (< 6 GHz)

Step attenuator (Option 004)

Provides source output power range from -85 to +10 dBm for HP 8753ET model.

6 GHz operation (Option 006)

With Option 006, performance is extended to 6 GHz. When external source, tuned receiver or harmonic mode is used, the receiver is capable of measuring signals up to 6 GHz.

Time domain (Option 010)

Transforms data from the frequency domain to the time domain using a Fourier transformation technique.

High-stability frequency reference (Option 1D5)

This option adds an ovenized 10-MHz frequency reference output. It is connected to the external reference input on the rear panel. See the "General Characteristics" section for below specifications.

- One-port calibration, with a 6 kHz IF bandwidth. Includes system retrace time, but does not include bandwidth time. Time-domain gating is assumed off.
- Same as footnote 1, but for an S21 measurement with full two-port calibration. Includes RF switching time.
- Option 010 only, gating off.
- Measured with an HP Omnibook 7100 266 MHz Pentium® II computer.
- Does not include error from the HP 8753T/ES source and receiver harmonics.

Test set specifications for Option 011

HP 85046A/B S-parameter test sets

The HP 85046A/B S-parameter test sets provide the capability to measure reflection and transmission characteristics (including S-parameters) of two-port devices in either direction with a single connection. The test sets are controlled from the HP 8753ES Option 011 and include a programmable step attenuator. The frequency range of the HP 85046A 50-ohm test set is 300 kHz to 3 GHz. The HP 85046A has precision 7-mm connectors. The frequency range of the HP 85046B 75-ohm test set is 300 kHz to 2 GHz. The HP 85046B has 75-ohm type-N(f) connectors. Both connectors can be adapted to other interfaces with the appropriate precision adapters.

HP 85046A/B Specifications

Note: Specifications that apply only to the HP 85046 are indicated in parentheses.

Impedance	50 ohm (75 ohm)
Frequency range	300 kHz to 3 GHz (300 kHz to 2 GHz)
Directivity	35 dB to 1.3 GHz 30 dB to F_{\max}^1
Typical tracking	
Transmission magnitude, phase²	
0.3 MHz to 2.0 MHz	± 1.5 dB, $\pm 20^\circ$
2.0 MHz to F_{\max}	± 1.5 dB, $\pm 10^\circ$
Reflection magnitude, phase²	
0.3 MHz to 2.0 MHz	± 1.5 dB, $\pm 25^\circ$
2.0 MHz to F_{\max}	± 1.5 dB, $\pm 10^\circ$
Effective source match	
0.3 MHz to 2.0 MHz	14 dB
2.0 MHz to 1.3 GHz	20 dB (17 dB)
1.3 GHz to F_{\max}	16 dB

Nominal insertion loss

Input to test port	14 dB + 0.5 dB/GHz (19.5 dB + 1 dB/GHz)
Input to incident	18 dB + 1.5 dB/GHz (18 dB + 1.5 dB/GHz)
Port 1, 2 to A, B	6.5 dB + 1.0 dB/GHz (12 dB + 0.5 dB/GHz)

Test set switch/repeatability

± 0.03 dB; ± 0.01 dB³

Max. operating level

+20 dBm

Damage level

+30 dBm

RF attenuator range

70 dB, 10 dB steps

DC bias range

± 30 VDC, 200 mA⁴
500 mA max

DC bias connectors

50 ohm BNC (f)

Includes

four 190 mm (7.5 in) type-N cables and test set interconnect cable.

Dimensions

90 mm H x 432 mm W x 553 mm D

Weight

9.1 kg (20 lb)

A standard HP 85046A/B test set contains a solid-state transfer switch, which allows continuous switching of power from port 1 to port 2 for full two-port error correction. Option 009 replaces the transfer switch with a mechanical switch. This provides about 1.5 dB more power at the test port, but does not allow continuous switching, so the user must initiate updates of all four S-parameters for full two-port error correction. Also, the mechanical switch has relays that will wear out faster than the solid-state switch. Approximate lifetime of the mechanical switch is 1 million cycles.

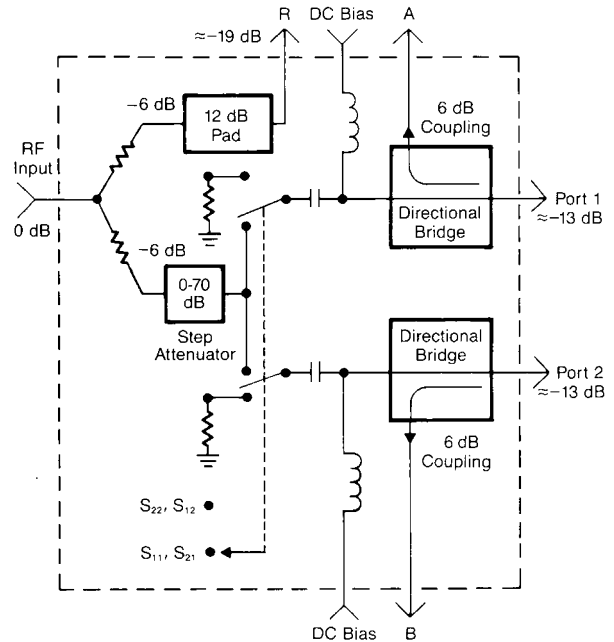

HP 85046A schematic

1. F_{\max} is the upper frequency limit of the associated test set.
2. Degrees, specified as deviation from linear phase.
3. Typical performance.
4. Some degradation of RF specifications may occur.

HP 85047A S-parameter test set

The HP 85047A S-parameter test set provides the capability to simultaneously measure the reflection and transmission characteristics of two-port devices in either direction with a single connection. This test set includes a frequency doubler that can be switched in by an HP 8753B/C Option 006 to measure 3 MHz to 6 GHz in a single sweep or switched out to measure 300 kHz to 3 GHz in a single sweep. The HP 8753ES Option 011 does not use the frequency doubler, so the full 300 kHz to 6 GHz range is available. This test set exhibits <5 dB insertion loss between the RF input and the test ports for as high as 15 dBm at the test port, and also includes a programmable step attenuator. There are two rear panel BNC outputs. One provides a TTL signal which indicates the result of a limit test. The second TTL output is controlled from the HP 8753ES test sequence function.

Specifications

Impedance	50 ohms
Frequency range	300 kHz to 3 GHz and 3 GHz to 6 GHz (HP 8753B/C); 300 kHz to 6 GHz (HP 8753D/E/ES Opt. 006)

Directivity¹	
300 kHz to 1.3 GHz	35 dB ²
1.3 GHz to 3 GHz	30 dB
3 GHz to 6 GHz	25 dB

Typical tracking¹	
Transmission magnitude, phase³	
300 kHz to 3 GHz	± 1.5 dB, $\pm 10^\circ$
3 GHz to 6 GHz	$+0.5$, -2.5 dB, $\pm 20^\circ$

Reflection magnitude, phase³	
300 kHz to 3 GHz	± 1.5 dB, $\pm 10^\circ$
3 GHz to 6 GHz	± 1.5 dB, $\pm 20^\circ$

Source match¹	
300 kHz to 1.3 GHz	20 dB
1.3 GHz to 3 GHz	16 dB
3 GHz to 6 GHz	14 dB

Normal insertion loss	
Input to port 1,2	
300 kHz to 3 GHz	4.0 dB +0.8 dB/GHz
3 GHz to 6 GHz	17.5 dB +0.8 dB/GHz

Input to R	
300 kHz to 3 GHz	19 dB +0.5 dB/GHz
3 GHz to 6 GHz	34 dB +0.5 dB/GHz

Port 1,2 to A,B 16 dB

Typical Isolation⁴	
300 kHz to 3 GHz	100 dB
3 GHz to 6 GHz	90 dB

Test port switch repeatability	± 0.03 dB; ± 0.01 dB ⁴
---------------------------------------	---

Maximum operating level	+20 dBm
Damage level	+30 dBm
RF attenuator range	70 dB (10 dB steps)
DC bias range	± 30 VDC, 200 mA, no degradation in RF specs, 1A max.

RF connectors	
Port 1,2	7 mm precision
All others	50 ohm type-N(f)
Dimensions	90 mm H x 432 mm W x 553 mm D
Weight	10 kg (22 lb)

A standard HP 85047A test set contains a solid-state transfer switch, which allows continuous switching of power from port 1 to port 2 for full two-port error correction. Option 009 replaces the transfer switch with a mechanical switch. This provides about 2.5 to 3.5 dB more power at the test port, but does not allow continuous switching, so the user must initiate updates of all four S-parameters for full two-port error correction. Also, the mechanical switch has relays that will wear out faster than the solid-state switch. Approximate lifetime of the mechanical switch is 1 million cycles.

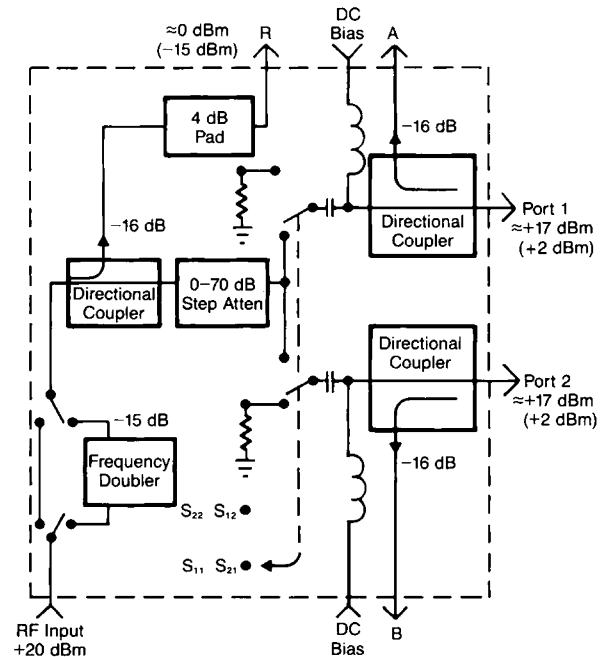

HP 85047A schematic

1. This can be greatly improved with accuracy enhancement.
 2. Some degradation at environmental extremes below 600 kHz.
 3. Degrees, specified as deviation from linear phase.
 4. Typical performance.

Accessories

Calibration kits

Vector accuracy enhancement procedures require that the systematic errors of the measurement system be characterized by measuring known devices (standards) on the system over the frequency range of interest. Return loss specifications or typical values are provided where available for the terminations and adapters.

HP 85031B 7-mm calibration kit

Contains precision 7-mm standards used to calibrate the HP 8753ES for measurement of devices with precision 7-mm connectors.

Includes	HP part number
7 mm short/open circuit	85031-60001
7 mm 50-ohm terminations (two each)	00909-60008
Specifications for terminations	
DC to 5 GHz	RL ≥ 52 dB
5 to 6 GHz	RL ≥ 46 dB

HP 85032B 50-ohm type-N calibration kit

Contains precision 50-ohm type-N standards used to calibrate the HP 8753ET/ES and 50-ohm test sets for measurement of devices with 50-ohm type-N connectors. Precision phase-matched 7-mm to type-N adapters are included for accurate measurements of non-insertable devices. Option 001 deletes the 7-mm to type-N adapters, which are not needed with the HP 8753ET.

Includes	HP part number
N-male 50-ohm termination	00909-60009
N-female 50-ohm termination	00909-60010
N-male short circuit	85032-60008
N-female short circuit	85032-60009
N-female open circuit	85032-60012
N-male open circuit	85032-60007
7-mm to N-male adapter (two each)	85054-60009
7-mm to N-female adapter (two each)	85054-60001
Specifications for terminations:	
DC to 3 GHz	RL ≥ 49 dB
2 to 3 GHz	RL ≥ 46 dB
3 to 6 GHz	RL ≥ 40 dB
Typical adapter characteristics:	
DC to 6 GHz	RL ≥ 30 dB

HP 85033D 3.5-mm calibration kit

Contains a set of precision 3.5-mm standards to calibrate the HP 8753ES and 50-ohm test sets for the measurement of devices with precision 3.5-mm and SMA connectors. Precision phase-matched 7-mm to 3.5-mm adapters are included for accurate measurements of non-insertable devices. Option 001 deletes the 7-mm to type-N adapters.

Includes	HP part number
3.5-mm-male 50-ohm termination	85033-60009
3.5-mm-female 50-ohm termination	85033-60010
3.5-mm-female short	85033-60014
3.5-mm-male short	85033-60013
3.5-mm-female open	85033-60012
3.5-mm-male open	85033-60011
7-mm to 3.5-mm female adapter (two)	1250-1747
7-mm to 3.5-mm male adapter (two)	1250-1746
Specifications for terminations:	
DC to 1.3 GHz	RL ≥ 46 dB
1.3 to 3 GHz	RL ≥ 44 dB
3 to 6 GHz	RL ≥ 38 dB
Typical adapter characteristics:	
DC to 6 GHz	RL ≥ 34 dB

HP 85036B 75-ohm type-N calibration kit

Contains a set of precision 75-ohm type-N standards to calibrate the HP 8753ES with a 75-ohm test set for measurement of devices with 75-ohm type-N connectors. Precision phase-matched adapters are included for accurate measurements of non-insertable devices.

Includes	HP part number
N-male 75-ohm termination	00909-60019
N-female 75-ohm termination	00909-60020
N-female 75-ohm short	85036-60011
N-male 75-ohm short	85036-60012
N-female open	85032-20001
N-male open	85032-60007
N-male to N-male 75-ohm adapter	85036-60013
N-female to N-female 75-ohm adapter	85036-60014
N-male to N-female 75-ohm adapter	85036-60015
Specifications for terminations:	
DC to 2 GHz	RL ≥ 46 dB
2 to 3 GHz	RL ≥ 40 dB

HP 85038 family of calibration kits

The HP 85038A calibration kit contains open circuits, short circuits, and terminations with both male and female 7-16 connectors. More economical versions of this kit are available: the HP 85038M contains only male devices, and the HP 85038F provides only female devices (see following table). Each kit contains a floppy disk with the calibration kit definition for use with HP 8712, 8714, 8753, 8719, 8720, 8722, and 8510C network analyzers.

Contents of 7-16 Calibration Kits

Description	HP Part Number	HP 85038A	HP 85038M	HP 85038F
Open circuit, female	85038-80002	X		X
Open circuit, male	85038-80003	X	X	
Short circuit, female	85038-80004	X		X
Short circuit, male	85038-80005	X	X	
Termination, female	85038-80006	X		X
Termination, male	85038-80007	X	X	
7-16 adapter, female-to-female	11906-80016			X
7-16 adapter, male-to-male	11906-80015		X	
Calibration kit data disk	85038-10001	X	X	X
Torque wrench	8710-2175	X		
Open-end wrench	8710-2174	X		

Specifications

Frequency coverage	dc to 7.5 GHz (usable to 8 GHz)
Nominal impedance	50 ohms
Open circuits	Reflection phase ± 1 degree from nominal
Short circuits	Reflection phase ±1 degree from nominal
Terminations:	Return loss > 40 dB
7-16 to 7-16 adapters	Return loss > 40 dB (VSWR < 1.02)
7-16 to 50 ohm type-N adapters	Return loss > 36 dB (VSWR < 1.03)
7-16 to 7-mm adapters	Return loss > 38 dB (VSWR < 1.025)
7-16 to 3.5-mm adapters	Return loss > 34 dB (VSWR < 1.04)

HP 11906 family of adapter kits

The HP 11906 family consists of four adapter kits:

HP 11906A 7-16 to 7-16 adapter kit

Description	Quantity	HP Part Number
7-16 male-to-male adapter	1	11906-80015
7-16 female-to-female adapter	1	11906-80016
7-16 male-to-female adapter	2	11906-80017

HP 11906B 7-16 to 50-Ohm type-N adapter kit

Description	Quantity	HP Part Number
Type-N male to 7-16 male adapter	1	11906-80007
Type-N female to 7-16 female adapter	1	11906-80008
Type-N female to 7-16 male adapter	1	11906-80009
Type-N male to 7-16 female adapter	1	11906-80010

HP 11906C 7-16 to 7-mm adapter kit

Description	Quantity	HP Part Number
7-mm to 7-16 male adapter	2	11906-80012
7-mm to 7-16 female adapter	2	11906-80013

HP 11906D 7-16 to 3.5-mm adapter kit

Description	Quantity	HP Part Number
3.5-mm male to 7-16 male adapter	1	11906-80002
3.5-mm male to 7-16 female adapter	1	11906-80005
3.5-mm female to 7-16 male adapter	1	11906-80004
3.5-mm female to 7-16 female adapter	1	11906-80003

HP 85039B type-F calibration kit

Contains a set of 75-ohm type-F standards to calibrate the HP 8753ES with a 75-ohm test set for the measurement of devices with type-F connectors.

Includes HP part number

F-male 75-ohm termination	85039-60007
F-female 75-ohm termination	85039-60004
Specifications for termination	
DC to 1 GHz	RL ≥ 45 dB
1 to 3 GHz	RL ≥ 38 dB
F-male 75-ohm short	85039-60008
F-female 75-ohm short	85039-60003
F-male 75-ohm open	85039-60009
F-female 75-ohm open	85039-60005
F-female to F-female 75-ohm adapter	85039-60002
F-male to F-male 75-ohm adapter	85039-60006
Typical type-F adapter characteristics	
DC to 1 GHz	RL ≥ 40 dB
1 to 3 GHz	RL ≥ 32 dB
F-female to N-male 75-ohm adapter	85039-60013
F-male to N-female 75-ohm adapter	85039-60011
Typical type-F to type-N adapter characteristics	
DC to 1 GHz	RL ≥ 38 dB
1 to 3 GHz	RL ≥ 32 dB

Verification kits

Measuring known devices other than the standards used in calibration is an easy way to verify the proper operation of an HP 8753ES measurement system. HP offers verification kits which include devices, with data, for verifying the error-corrected measurements of an HP 8753ES and 50-ohm test sets.

HP 85029B 7-mm verification kit

Contains a set of precision 7-mm devices, with data traceable to NIST* for verifying the calibrated performance of an HP 8753E measurement system. The HP 85031B 7-mm calibration kit is required for complete verification.

Test-port return cables

Hewlett-Packard offers high-quality RF cables to connect the HP 8753ET/ES and test sets to devices under test. These cables offer excellent RF shielding for high-dynamic-range measurements.

HP 11851B 50-ohm type-N RF cable kit

Recommended for use with the HP 11850C/D three-way power splitters. Kit includes three phase-matched 610-mm (24-in.) cables and one 860-mm (34-in.) cable.

Return loss	> 24 dB to 3 GHz
Phase tracking	$\pm 4^\circ$ at 1.3 GHz

HP 8120-5639 50-ohm type-N RF cable

A 50-ohm type-N test port cable (both connectors are type-N male).

Return loss	> 30dB to 6 GHz
-------------	-----------------

HP 11857B 75-ohm type-N test port return cables

A pair of 610-mm (24-in.) test port return cables for use with the HP 8753ES or HP 85046B 75-ohm S-parameter test set.

Return loss	> 24 dB to 2 GHz
Phase tracking	$\pm 2^\circ$ at 1.3 GHz

HP 11857D 7-mm test-port return cables

A pair of 610-mm (24-in.) test port return cables for use with the HP 8753ES with the HP 85046A and 85047A S-parameter test sets. These cables can be used with connector types other than 7-mm with the appropriate precision adapters.

Return loss	> 24 dB to 3 GHz
	> 20 dB to 6 GHz
Phase tracking	$\pm 2^\circ$ at 1.3 GHz

HP 11857F type-F test-port return cables

Type-F test port cable set (75-ohm). Includes one cable with type-N(male) to type-F(male) connectors and one cable with type-N(male) to type-F(female) connectors.

HP 11850C/D three-way power splitters

	HP 11850C	HP 11850D
Impedance	50 ohms	75 ohms
Frequency range	DC to 3 GHz	DC to 2 GHz
Tracking	± 25 dB, $\pm 3^\circ$	± 2 dB, $\pm 2.5^\circ$
Equivalent source match	30 dB at 1.3 GHz	30 dB at 1.3 GHz
(ratio or leveling)	20 dB at 3 GHz	20 dB at 2 GHz
Nominal insertion loss	9.5 dB + 1 dB/GHz	7.8 dB
Input port match		
DC to 1.3 GHz	20 dB	20 dB
1.3 GHz to F_{\max}	10 dB	10 dB
Maximum operating level	+20 dB	+20 dB
Damage level	+30 dB	+30 dB
RF connectors		
RF input	50-ohm type-N (f)	50-ohm type-N(f)
All others	50-ohm type-N (f)	75-ohm type-N(f)
Includes	Three HP 11852B 50-to 75-ohm minimum-loss pads	
Recommended accessories	HP 11851B RF cable kit	

HP 11667A 50-ohm power splitter

Frequency range	DC to 18 GHz
Typical insertion loss	6 dB
Equivalent source match	
DC to 4 GHz	26 dB
4 GHz to 8 GHz	21 dB
8 GHz to 18 GHz	17 dB
Tracking	
(between output arms)	
DC to 4 GHz	± 15 dB
4 GHz to 8 GHz	± 2 dB
8 GHz to 18 GHz	± 25 dB
Maximum operating level	± 27 dBm
Connectors	50-ohm type-N (f)
Option 001	
RF input	type-N (m)
Outputs	type-N (f)
Option 002	
RF input	type-N (f) on RF
Outputs	precision 7-mm
Dimensions	46 mm H x 52 mm W x 19 mm D (1.8 x 2.0 x 0.7 in)
Recommended accessories	HP 11851B RF cable kit

HP 11852B 50-ohm to 75-ohm minimum loss pad

Frequency range	DC to 3.0 GHz
Nominal insertion loss	5.7 dB
Return loss	
300 kHz to 2 GHz	32 dB
2 GHz to 3 GHz	27 dB
Maximum input power	250 mW (+24 dBm)

HP 11852B 50-ohm to 75-ohm minimum loss pad (continued)

Connectors	50-ohm type-N (f) to 75-ohm type-N (m) standard Option 004, 50-ohm type-N (m) to 75-ohm type-N (f)
Dimensions	14-mm D x 70-mm L (0.56 in x 2.75 in)
Weight	Net 0.1 kg (0.316 lb)

50-ohm accessory kits

The HP 11853A 50-ohm type-N and the HP 11854A 50-ohm BNC accessory kits provide the RF components generally required when using either the HP 85046A, 85047A or 11850C with the HP 8753ES Option 011 when measuring devices having 50-ohm type-N or BNC connectors. These kits are supplied with a storage case.

HP 11853A 50-ohm type-N accessory kit

Includes	HP part number
Type-N (f) short	HP 11511A
Type-N (m) short	HP 11512A
Type-N (m) to N (m) adapter	1250-1475
Type-N (f) to N (f) adapter	1250-1472

HP 11854A 50-ohm BNC accessory kit

Includes	HP part number
Type-N (m) to BNC female adapter	1250-1476
Type-N (m) to BNC male adapter	1250-1473
Type-N (f) to BNC male adapter	1250-1477
Type-N (f) to BNC female adapter	1250-1474
BNC (m) short	1250-0929

75-ohm accessory kits

The HP 11855A 75-ohm type-N and the HP 11856A 75-ohm BNC accessory kits provide the RF components generally required when using either the HP 85046B or the HP 11850D power splitter with the HP 8753ES Option 011 when measuring devices having 75-ohm type-N or BNC connectors. These kits are supplied with a storage case.

HP 11855A 75-ohm type-N accessory kit

Includes	HP part number
Type-N (f) short	1250-1531
Type-N (m) short	1250-1530
Type-N (m) to N (m) adapter	1250-1528
Type-N (f) to N (f) adapter	1250-1529
Type-N (m) termination	1250-1532

HP 11856A 75-ohm BNC accessory kit

Includes	HP part number
Type-N (m) to BNC (f) adapter	1250-1535
Type-N (m) to BNC (m) adapter	1250-1533
Type-N (f) to BNC (m) adapter	1250-1534
Type-N (f) to BNC (f) adapter	1250-1536
BNC (m) short	1250-0929
BNC (m) termination	11652-60010

RF limiter

Externally attaches to one or both ports of the analyzer. Provides protection against potential high-power transients from external devices.

Specifications

HP 11930A 7-mm RF limiter

Frequency range	DC to 6 GHz
Nominal insertion loss	
DC to 3 GHz	1.0 dB
3 GHz to 6 GHz	1.5 dB

Return loss

DC to 3 GHz	22 dB
3 GHz to 6 GHz	20 dB

Maximum input power

3W

Maximum DC

30 V, 350 mA

HP 11930B 50-ohm type-N RF limiter²

Frequency range 5 MHz to 6 GHz

Nominal insertion loss

5 MHz to 3 GHz	1.0 dB ¹
3 GHz to 6 GHz	1.5 dB

Return loss

5 MHz to 3 GHz	21 dB ¹
3 GHz to 6 GHz	17 dB

Maximum input power

3W

HP 85024A high-frequency probe

Two probes may be powered directly from the front panel of the HP 8753ET/ES. Refer to technical specifications, HP literature #5954-8393, for more information.

Specifications

Input capacitance (at 500 MHz)	<0.7 pF (nominal)
Input resistance	1 Megohm (nominal)
Bandwidth	300 kHz to 3 GHz
Gain (at 500 MHz)	0 dB \pm 1 dB
Frequency response	
300 kHz to 1 GHz	\pm 1 dB
1 GHz to 3 GHz	+2, -3 dB
Input voltage for < 1 dB compression	0.3 V

Supplement characteristics

Noise figure

<100 MHz	< 50 dB
100 MHz to 3 GHz	< 25 dB

Includes

	HP part/model number
Type-N (m) adapter	HP 11880A
10:1 divider	HP 11881A
Spare 12 mil probes	85024-20012
2.5-inch ground lead	01223-61302
Hook tip	HP 10229
Spanner tip	5060-0549
Probe tip nut driver	8710-1806

1. Return loss and insertion loss limited below 16 MHz by series capacitor.
2. Internal bias tees cannot be used with this limiter.

HP 8347A RF amplifier



The HP 8347A RF amplifier delivers increased power across a 300 kHz to 3 GHz frequency range.

The HP 8347A provides leveled output power without using an external coupler and detector, since these parts are built-in. The external ALC can be directly connected to the external AM input on the HP 8753ET/ES. This capability is especially useful for achieving high dynamic range measurements at faster sweep rates.

Specifications

Frequency	100 kHz to 3 GHz
Gain	25 dB minimum
Output power (leveled)	+5 dBm to +20 dBm (adjustable)
Maximum output power	24 dBm (typical)
Leveled power flatness	±1.5 dB
Impedance	50 ohms nominal
SWR	
Input	2.2:1 max
Output	1.6:1 (ALC on)
Spectral purity	
Harmonics	-20 dBc at dBm
Third-order intercept	+30 dBm (nominal)
Typical noise figure	
100 MHz to 3 GHz	13.5 dB
RF connectors	Type-N female
Dimensions	102-mm H x 213-mm W x 297-mm D (4.0 in x 8.4 in x 11.7 in)
Weight	net 3.5 kg (7.7 lb)

For more information about Hewlett-Packard test and measurement products, applications, services, and for a current sales office listing, visit our web site, <http://www.hp.com/go/tmdir>. You can also contact one of the following centers and ask for a test and measurement sales representative.

United States:

Hewlett-Packard Company
Test and Measurement Call Center
P.O. Box 4026
Englewood, CO 80155-4026
1 800 452 4844

Canada:

Hewlett-Packard Canada Ltd.
5150 Spectrum Way
Mississauga, Ontario L4W 5G1
(905) 206 4725

Europe:

Hewlett-Packard
European Marketing Centre
P.O. Box 999
1180 AZ Amstelveen
The Netherlands
(31 20) 547 9900

Japan:

Hewlett-Packard Japan Ltd.
Measurement Assistance Center
9-1, Takakura-Cho, Hachioji-Shi,
Tokyo 192, Japan
Tel: (81) 426-56-7832
Fax: (81) 426-56-7840

Latin America:

Hewlett-Packard
Latin American Region Headquarters
5200 Blue Lagoon Drive, 9th Floor
Miami, Florida 33126, U.S.A.
(305) 267 4245/4220

Australia/New Zealand:

Hewlett-Packard Australia Ltd.
31-41 Joseph Street
Blackburn, Victoria 3130, Australia
1 800 629 485

Asia Pacific:

Hewlett-Packard Asia Pacific Ltd
19/F Cityplaza One
1111 King's Road
Taikoo Shing, Hong Kong
tel: 852-2599-7777
fax: 852-2506-9285

Data Subject to Change

Copyright © 1999

Hewlett-Packard Company

Printed in U.S.A. 8/99

5968-5160E

Free Manuals Download Website

<http://myh66.com>

<http://usermanuals.us>

<http://www.somanuals.com>

<http://www.4manuals.cc>

<http://www.manual-lib.com>

<http://www.404manual.com>

<http://www.luxmanual.com>

<http://aubethermostatmanual.com>

Golf course search by state

<http://golfingnear.com>

Email search by domain

<http://emailbydomain.com>

Auto manuals search

<http://auto.somanuals.com>

TV manuals search

<http://tv.somanuals.com>