

# **Installation and Quick Start Guide**

## **HP 8753D Option 011 Network Analyzer**



**HP Part No. 08753-90303**  
**Printed in USA September 1994**

**Notice.**

The information contained in this document is subject to change without notice.

Hewlett-Packard makes no warranty of any kind with regard to this material, including but not limited to, the implied warranties of merchantability and fitness for a particular purpose. Hewlett-Packard shall not be liable for errors contained herein or for incidental or consequential damages in connection with the furnishing, performance, or use of this material.

© Copyright Hewlett-Packard Company 1994

All Rights Reserved. Reproduction, adaptation, or translation without prior written permission is prohibited, except as allowed under the copyright laws.

1400 Fountaingrove Parkway, Santa Rosa, CA 95403-1799, USA

---

## Certification

Hewlett-Packard Company certifies that this product met its published specifications at the time of shipment from the factory. Hewlett-Packard further certifies that its calibration measurements are traceable to the United States National Institute of Standards and Technology, to the extent allowed by the Institute's calibration facility, and to the calibration facilities of other International Standards Organization members.

## Regulatory Information

The regulatory information is in the *HP 8753D Option 011 Network Analyzer User's Guide*.

---

## Warranty

This Hewlett-Packard instrument product is warranted against defects in material and workmanship for a period of one year from date of shipment. During the warranty period, Hewlett-Packard Company will, at its option, either repair or replace products which prove to be defective.

For warranty service or repair, this product must be returned to a service facility designated by Hewlett-Packard. Buyer shall prepay shipping charges to Hewlett-Packard and Hewlett-Packard shall pay shipping charges to return the product to Buyer. However, Buyer shall pay all shipping charges, duties, and taxes for products returned to Hewlett-Packard from another country.

Hewlett-Packard warrants that its software and firmware designated by Hewlett-Packard for use with an instrument will execute its programming instructions when properly installed on that instrument. Hewlett-Packard does not warrant that the operation of the instrument, or software, or firmware will be uninterrupted or error-free.

### LIMITATION OF WARRANTY

The foregoing warranty shall not apply to defects resulting from improper or inadequate maintenance by Buyer, Buyer-supplied software or interfacing, unauthorized modification or misuse, operation outside of the environmental specifications for the product, or improper site preparation or maintenance.

NO OTHER WARRANTY IS EXPRESSED OR IMPLIED. HEWLETT-PACKARD SPECIFICALLY DISCLAIMS THE IMPLIED WARRANTIES OF MERCHANTABILITY AND FITNESS FOR A PARTICULAR PURPOSE.

### EXCLUSIVE REMEDIES

THE REMEDIES PROVIDED HEREIN ARE BUYER'S SOLE AND EXCLUSIVE REMEDIES. HEWLETT-PACKARD SHALL NOT BE LIABLE FOR ANY DIRECT, INDIRECT, SPECIAL, INCIDENTAL, OR CONSEQUENTIAL DAMAGES, WHETHER BASED ON CONTRACT, TORT, OR ANY OTHER LEGAL THEORY.

---

## Assistance

*Product maintenance agreements and other customer assistance agreements are available for Hewlett-Packard products. For any assistance, contact your nearest Hewlett-Packard Sales and Service Office.*

---

## Safety Notes

The following safety notes are used throughout this manual. Familiarize yourself with each of the notes and its meaning before operating this instrument.

---

**Warning**      **Warning denotes a hazard. It calls attention to a procedure which, if not correctly performed or adhered to, could result in injury or loss of life. Do not proceed beyond a warning note until the indicated conditions are fully understood and met.**

---

---

**Caution**      **Caution denotes a hazard. It calls attention to a procedure that, if not correctly performed or adhered to, would result in damage to or destruction of the instrument. Do not proceed beyond a caution sign until the indicated conditions are fully understood and met.**

---

---

## General Safety Considerations

---

**Warning**      **For continued protection against fire hazard replace line fuse only with same type and rating (3A/250V). The use of other fuses or material is prohibited.**

---

---

**Warning**      **This is a Safety Class I product (provided with a protective earthing ground incorporated in the power cord). The mains plug shall only be inserted in a socket outlet provided with a protective earth contact. Any interruption of the protective conductor, inside or outside the instrument, is likely to make the instrument dangerous. Intentional interruption is prohibited.**

---

---

**Caution**      **Ventilation Requirements:** When installing the instrument in a cabinet, the convection into and out of the instrument must not be restricted. The ambient temperature (outside the cabinet) must be less than the maximum operating temperature of the instrument by 4 °C for every 100 watts dissipated in the cabinet. If the total power dissipated in the cabinet is greater than 800 watts, then forced convection must be used.

---

---

## How to Use This Guide

### This guide uses the following conventions:

- Front-Panel Key** This represents a key physically located on the instrument.
- Softkey** This indicates a "softkey," a key whose label is determined by the instrument's firmware.
- Screen Text** This indicates text displayed on the instrument's screen.

## HP 8753D Option 011 Network Analyzer Documentation Map

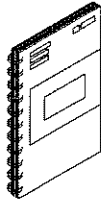

The **Installation and Quick Start Guide** familiarizes you with the HP 8753D Option 011 network analyzer's front and rear panels, electrical and environmental operating requirements, as well as procedures for installing, configuring, and verifying the operation of the HP 8753D Option 011.

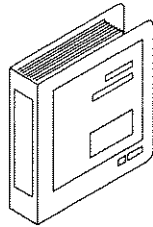

The **User's Guide** shows how to make measurements, explains commonly-used features, and tells you how to get the most performance from your analyzer.



The **Quick Reference Guide** provides a summary of all available user features.

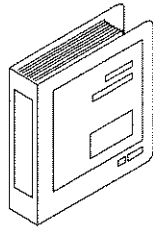

The **Programmer's Guide** provides programming information including: an HP-IB command reference, an HP-IB programming reference, as well as programming examples.

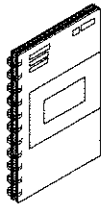

The **System Verification and Test Guide** provides the system verification and performance tests and the Performance Test Record for your HP 8753D Option 011 network analyzer.

# Contents





---

## 1. Installing Your Analyzer

|   |      |
|---|------|
| STEP 1. Verify the Shipment . . . . .   | 1-2  |
| STEP 2. Familiarize Yourself with the HP 8753D Option 011 Front and Rear Panels             | 1-4  |
| HP 8753D Option 011 Front Panel . . . . .   | 1-4  |
| HP 8753D Option 011 Rear Panel . . . . .  | 1-5  |
| STEP 3. Meet Electrical and Environmental Requirements . . . . .                            | 1-6  |
| STEP 4. Configure the Analyzer . . . . .  | 1-8  |
| To Configure an Option 011 Analyzer with S-Parameter Test Set . . . . .                     | 1-9  |
| To Configure an Option 011 Analyzer with a Transmission/Reflection (T/R) Test Set . . . . . | 1-10 |
| To Configure an Analyzer that has High Stability Frequency Reference (Option 1D5) . . . . . | 1-10 |
| To Configure an Analyzer with Printers or Plotters . . . . .                                | 1-11 |
| To Configure the Analyzer with Cabinet Flange Kits . . . . .                                | 1-16 |
| To Attach Handles to the Analyzer (Standard) . . . . .                                      | 1-17 |
| To Attach the Cabinet Flanges to an Analyzer (Option 1CM) . . . . .                         | 1-18 |
| To Attach Cabinet Flanges and Front Handles to an Analyzer (Option 1CP) . . . . .           | 1-19 |
| STEP 5. Verify the Analyzer Operation . . . . .   | 1-20 |
| To View the Installed Options . . . . .   | 1-21 |
| To Initiate the Analyzer Self-Test . . . . .  | 1-22 |
| To Run the Operator's Check . . . . .   | 1-23 |
| To Test the Transmission Mode . . . . .   | 1-24 |
| To Test the Transmission Mode's Load Match . . . . .  | 1-25 |
| STEP 6. To Backup to the EEPROM Disk . . . . .  | 1-26 |
| Description . . . . .   | 1-26 |
| Equipment . . . . .   | 1-26 |
| EEPROM Backup Disk Procedure . . . . .  | 1-26 |

## 2. Quick Start: Learning How to Make Measurements

|   |      |
|---|------|
| The HP 8753D Option 011 - At a Glance . . . . .                                 | 2-2  |
| Measurement Procedure . . . . .   | 2-4  |
| Step 1. Choose measurement parameters with your test device connected . . . . . | 2-4  |
| Step 2. Make a measurement calibration . . . . .                                | 2-4  |
| Step 3. Measure the device . . . . .  | 2-4  |
| Step 4. Output measurement results . . . . .                                    | 2-4  |
| Learning to Make Transmission Measurements . . . . .                            | 2-5  |
| Step 1. Choose the measurement parameters with the device connected . . . . .   | 2-5  |
| Step 2. Make a measurement calibration . . . . .                                | 2-6  |
| Step 3. Measure the device . . . . .  | 2-7  |
| Step 4. Output measurement results . . . . .                                    | 2-7  |
| Measuring Other Aspects of Insertion Loss with Marker Functions . . . . .       | 2-8  |
| Learning to Make Reflection Measurements . . . . .                              | 2-12 |
| Step 1. Choose the measurement parameters with the device connected . . . . .   | 2-13 |
| Step 2. Make a measurement calibration . . . . .                                | 2-14 |
| Step 3. Measure the device . . . . .  | 2-15 |
| Step 4. Output measurement results . . . . .                                    | 2-15 |

|  |      |
|--|------|
| Measuring Other Reflection Characteristics . . . . .   | 2-16 |
| If You Encounter a Problem . . . . .   | 2-21 |
| Power-up problems . . . . .  | 2-21 |
| If the HP 8753D Option 011 display does not light: . . . . .   | 2-21 |
| If the display lights, but the ventilation fan does not start: . . . . .   | 2-22 |
| Data Entry Problems . . . . .  | 2-22 |
| If the data entry controls (keypad, knob,  ,  ,  ,  keys) do not respond: . . . . . | 2-22 |
| If the parameter you are trying to enter is not accepted by the analyzer: . . . . .  | 2-22 |
| No RF Output . . . . .   | 2-22 |
| If there is no RF signal at either PORT 1 or PORT 2 connector: . . . . .   | 2-22 |

**Index**



## Figures

---

|   |      |
|---|------|
| 2-1. The HP 8753D Option 011 Front Panel Features . . . . .                     | 2-2  |
| 2-2. Device Connections for a Transmission Measurement . . . . .                | 2-5  |
| 2-3. Connections for a "Thru" Calibration Standard . . . . .                    | 2-6  |
| 2-4. Example Measurement of Insertion Loss . . . . .                            | 2-7  |
| 2-5. Example Measurement of 3 dB Bandwidth . . . . .                            | 2-8  |
| 2-6. Example Measurement of Out-of-Band Rejection . . . . .                     | 2-9  |
| 2-7. Example Measurement of Passband Flatness or Ripple . . . . .               | 2-10 |
| 2-8. Connections for Reflection Measurements . . . . .                          | 2-13 |
| 2-9. Connections for an $S_{11}$ 1-Port Measurement Calibration . . . . .       | 2-14 |
| 2-10. Example Return Loss Measurement Trace . . . . .                           | 2-15 |
| 2-11. Example Measurement Title . . . . .                                       | 2-16 |
| 2-12. Example Reflection Coefficient Measurement Trace . . . . .                | 2-17 |
| 2-13. Example Standing-Wave-Ratio Measurement Trace . . . . .                   | 2-17 |
| 2-14. Example $S_{11}$ Measurement Trace in Polar Format with Markers . . . . . | 2-19 |
| 2-15. Example Impedance Measurement Trace . . . . .                             | 2-20 |
| 2-16. Example Admittance Measurement Trace . . . . .                            | 2-20 |
| 2-17. Line Fuse Removal and Replacement . . . . .                               | 2-21 |

## Tables

---

|  |      |
|--|------|
| 2-1. Hewlett-Packard Sales and Service Offices . . . . . | 2-24 |
|--|------|



## Installing Your Analyzer

---

This chapter shows you how to install your analyzer and confirm the correct operation, by following the steps below:

1. Verify the shipment.
2. Familiarize yourself with the HP 8753D Option 011 front and rear panels.
3. Meet electrical and environmental requirements.
4. Configure the analyzer.
  - standard configuration
  - option 1D5 configuration - high stability frequency reference
  - printer or plotter configuration
  - rack-mount configuration
5. Verify the analyzer operation.
  - self-test
  - installed options
  - operator's check
  - transmission mode
  - reflection mode
6. Backup the EEPROM disk

## STEP 1. Verify the Shipment

1. Unpack the contents of all the shipping containers. **WARNING:** The HP 8753D Option 011 weighs approximately 73 pounds (33 kilograms). Use correct lifting techniques.

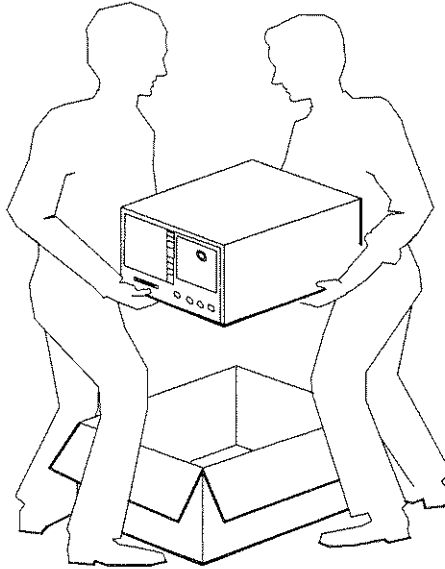

dg61do

2. Carefully inspect the analyzer to ensure that it was not damaged during shipment.

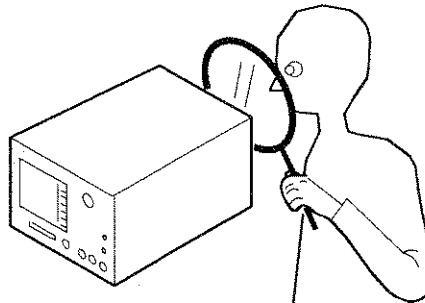

dg62do

### Note

If your analyzer was damaged during shipment, contact your nearest Hewlett-Packard office or sales representative. A list of HP sales and service offices is provided at the end of this guide.

**3. Verify that all the accessories have been included with the analyzer.**

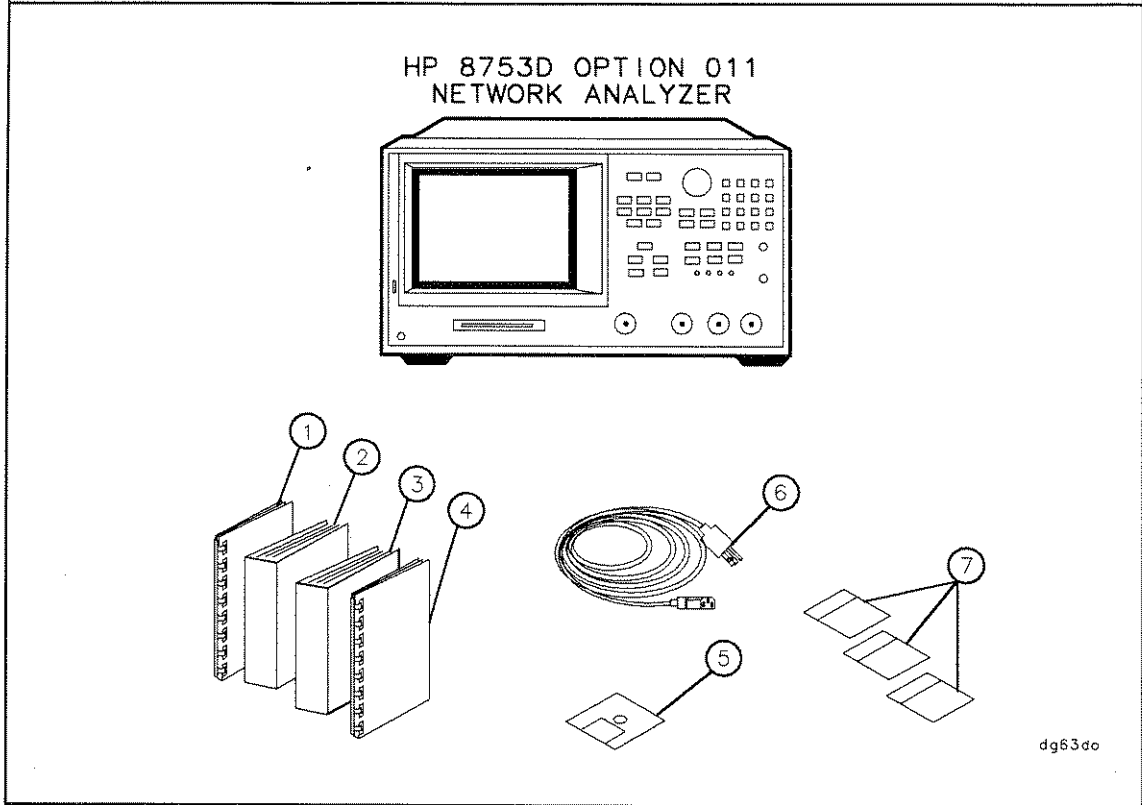

| Received | Part Number       | Item Number | Description                                    |
|----------|-------------------|-------------|--|
|          | 08753-90303       | 1           | Installation and Quick Start Guide             |
|          | 08753-90304       | 2           | User's Guide                                   |
|          | 08753-90305       | 2a          | User's Quick Reference Guide                   |
|          | 08753-90256       | 3           | Programming Guide                              |
|          | 08753-90308       | 4           | System Verification and Test Guide             |
|          | 08753-10013       | 5           | EEPROM Backup Disk                             |
|          | unique to country | 6           | AC power cable                                 |
|          | 5062-3978         | 7           | Rack Flange Kit (option 1CM only)              |
|          | 5062-4073         | 7           | Rack Flange Kit with Handles (option 1CP only) |
|          | 5062-3991         | 7           | Front Handle Kit (standard)                    |

## STEP 2. Familiarize Yourself with the HP 8753D Option 011 Front and Rear Panels

### HP 8753D Option 011 Front Panel

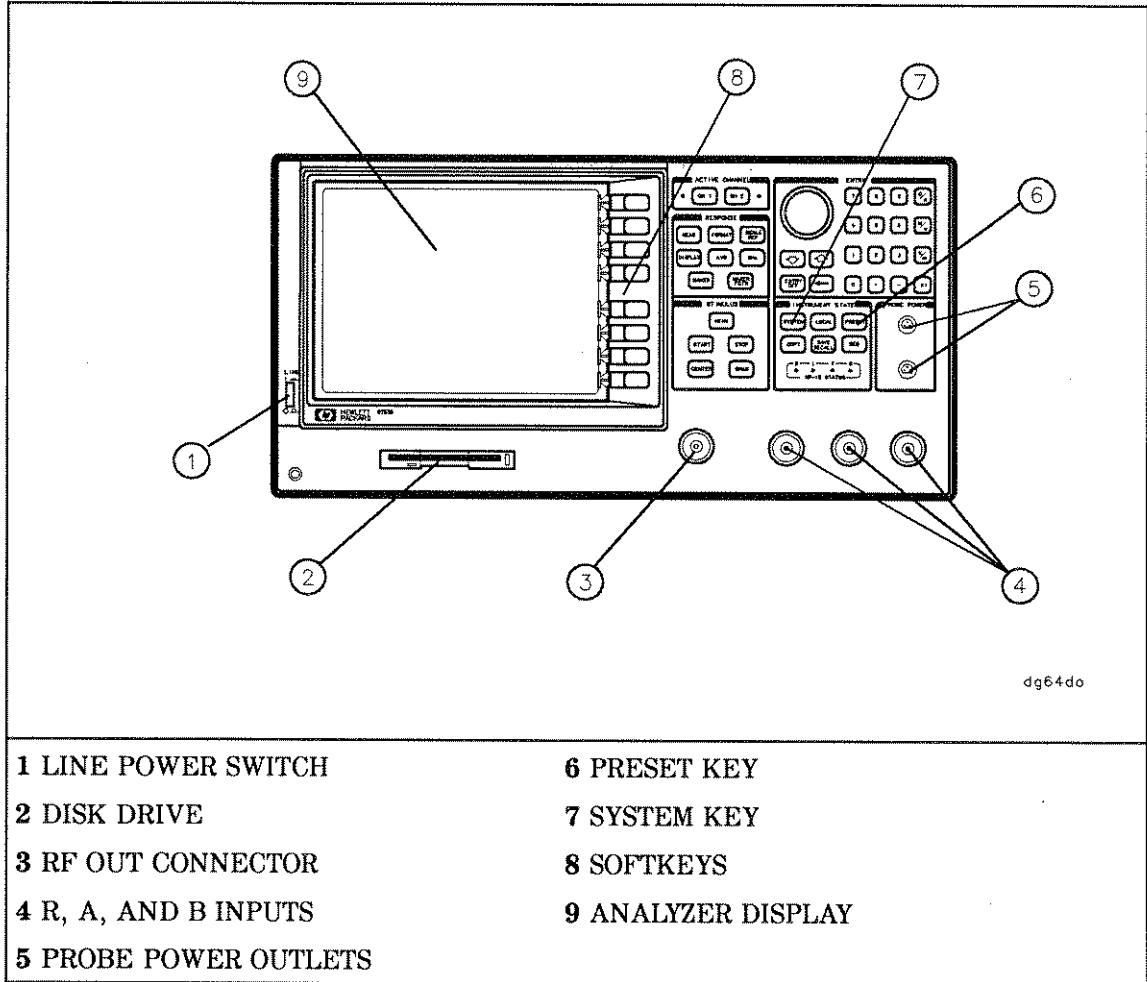

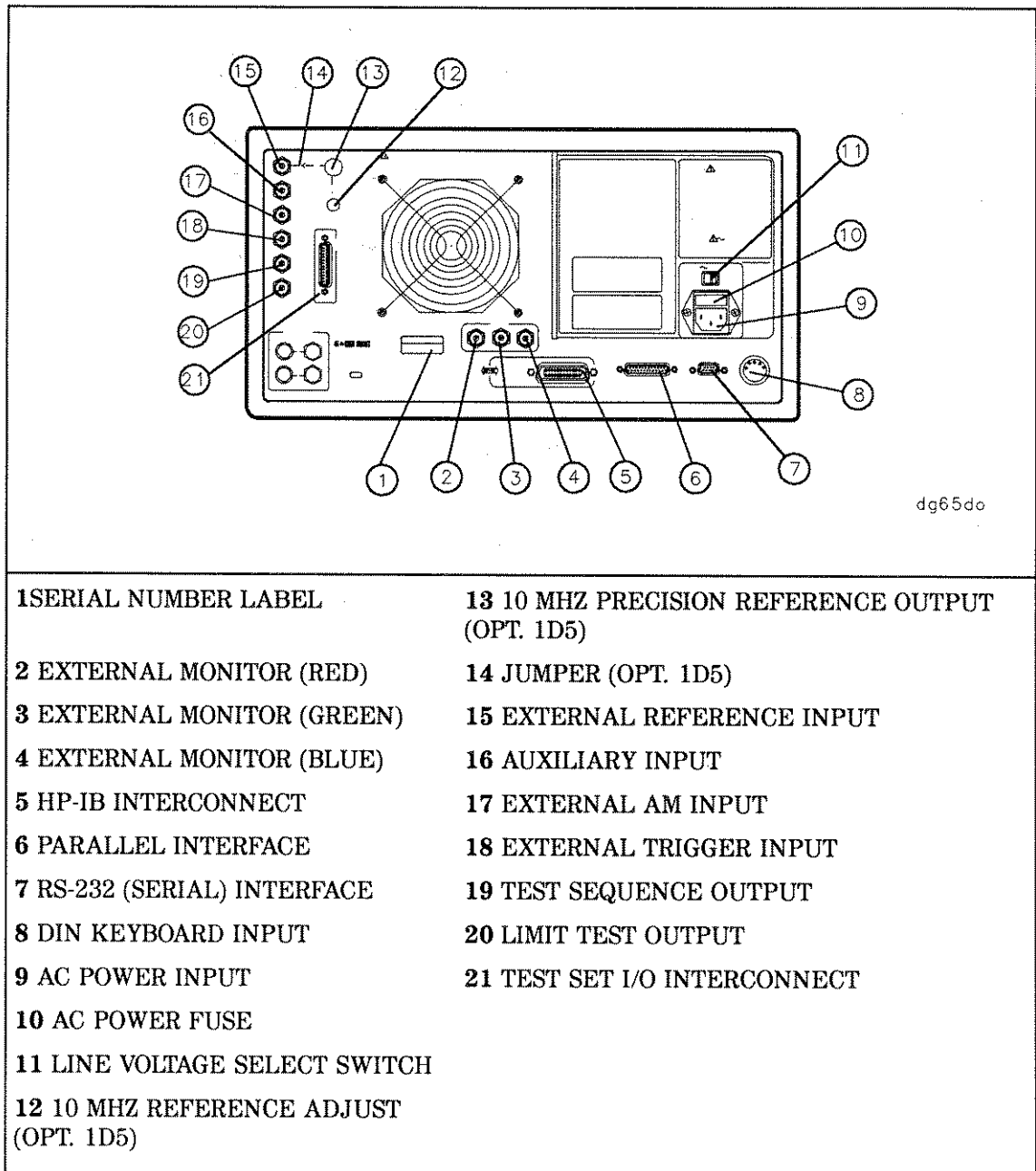

## HP 8753D Option 011 Rear Panel

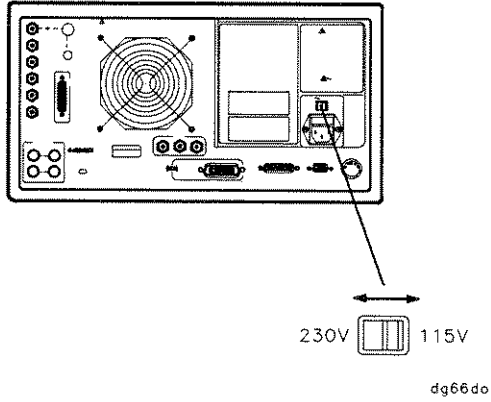

|  |  |
|--|--|
| <b>1</b> SERIAL NUMBER LABEL                 | <b>13</b> 10 MHZ PRECISION REFERENCE OUTPUT (OPT. 1D5) |
| <b>2</b> EXTERNAL MONITOR (RED)              | <b>14</b> JUMPER (OPT. 1D5)                            |
| <b>3</b> EXTERNAL MONITOR (GREEN)            | <b>15</b> EXTERNAL REFERENCE INPUT                     |
| <b>4</b> EXTERNAL MONITOR (BLUE)             | <b>16</b> AUXILIARY INPUT                              |
| <b>5</b> HP-IB INTERCONNECT                  | <b>17</b> EXTERNAL AM INPUT                            |
| <b>6</b> PARALLEL INTERFACE                  | <b>18</b> EXTERNAL TRIGGER INPUT                       |
| <b>7</b> RS-232 (SERIAL) INTERFACE           | <b>19</b> TEST SEQUENCE OUTPUT                         |
| <b>8</b> DIN KEYBOARD INPUT                  | <b>20</b> LIMIT TEST OUTPUT                            |
| <b>9</b> AC POWER INPUT                      | <b>21</b> TEST SET I/O INTERCONNECT                    |
| <b>10</b> AC POWER FUSE                      |  |
| <b>11</b> LINE VOLTAGE SELECT SWITCH         |  |
| <b>12</b> 10 MHZ REFERENCE ADJUST (OPT. 1D5) |  |

## STEP 3. Meet Electrical and Environmental Requirements

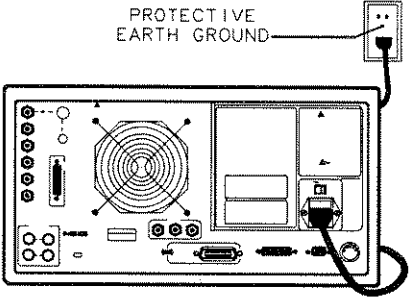
|  |  |
|--|--|
| <p>1. Set the line-voltage selector to the position that corresponds to the AC power source.</p>   | <p>2. Ensure the available AC power source meets the following requirements:</p>   |
|  <p style="text-align: center;">230V  115V</p> <p style="text-align: right;">dg66do</p>  | <ul style="list-style-type: none"> <li>■ 90 - 132 VAC</li> <li>■ 50 - 60 Hz / 400 Hz (single phase)</li> </ul> <p style="text-align: center;">OR</p> <ul style="list-style-type: none"> <li>■ 198 - 264 VAC</li> <li>■ 50 - 60 Hz (single phase)</li> </ul> <p>The analyzer power consumption is 280 VA max.</p>             |
| <p>3. Ensure the operating environment meets the following requirements:</p>   | <p>4. Verify that the power cable is not damaged, and that the power-source outlet provides a protective earth contact.</p>  |
| <ul style="list-style-type: none"> <li>■ 0 to 55°C</li> <li>■ &lt; 95% relative humidity at 40°C (non-condensing)</li> <li>■ &lt; 15,000 feet (≈4,500 meters) altitude</li> </ul> <p>Some HP 8753D Option 011 performance parameters are specified for 25°C ±5°C. Refer to the <i>HP 8753D Option 011 Network Analyzer User's Guide</i> for information on the environmental compatibility of warranted performance.</p> |  <p style="text-align: right;">dg67do</p> <p><b>WARNING:</b> Any interruption of the protective (grounding) conductor or disconnection of the protective earth terminal, can result in personal injury or may damage the instrument.</p> |



5. Ensure there are at least six inches of clearance between the sides and back of either the stand-alone analyzer or the system cabinet.

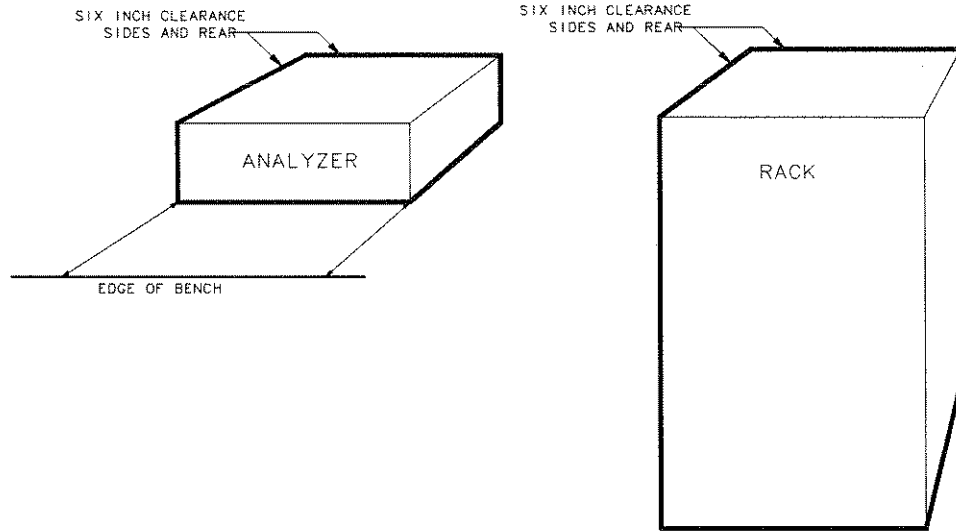

qg68d

**CAUTION:** The environmental temperature must be 4°C less than the maximum operating temperature of the analyzer for every 100 watts dissipated in the cabinet. If the total power dissipated in the cabinet is >800 watts, then you must provide forced convection.

6. Set up a static-safe workstation. Electrostatic discharge (ESD) can damage or destroy electronic components.

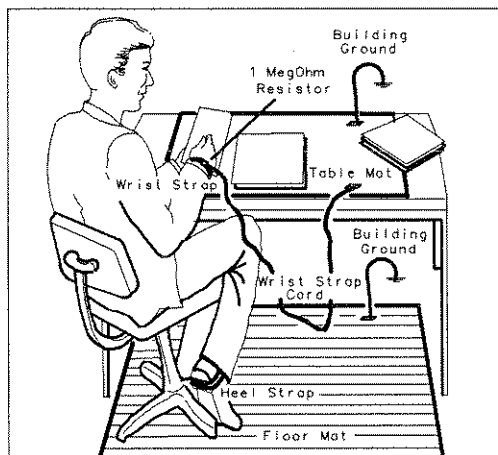

qg653d

- static-control table mat and earth ground wire: HP P/N 9300-0797
- wrist-strap cord: HP P/N 9300-0980
- wrist-strap: HP P/N 9300-1367
- heel-straps: HP P/N 9300-1308
- floor mat: not available through Hewlett-Packard

---

## **STEP 4. Configure the Analyzer**

This step shows you how to set up your particular analyzer configuration.

- standard configuration
- option 1D5 configuration - high stability frequency reference
- printer or plotter configuration
- cabinet rack-mount configuration

## To Configure an Option 011 Analyzer with S-Parameter Test Set

1. Connect Type-N cables and test set interconnect cable as shown. These cables are supplied with the test set.

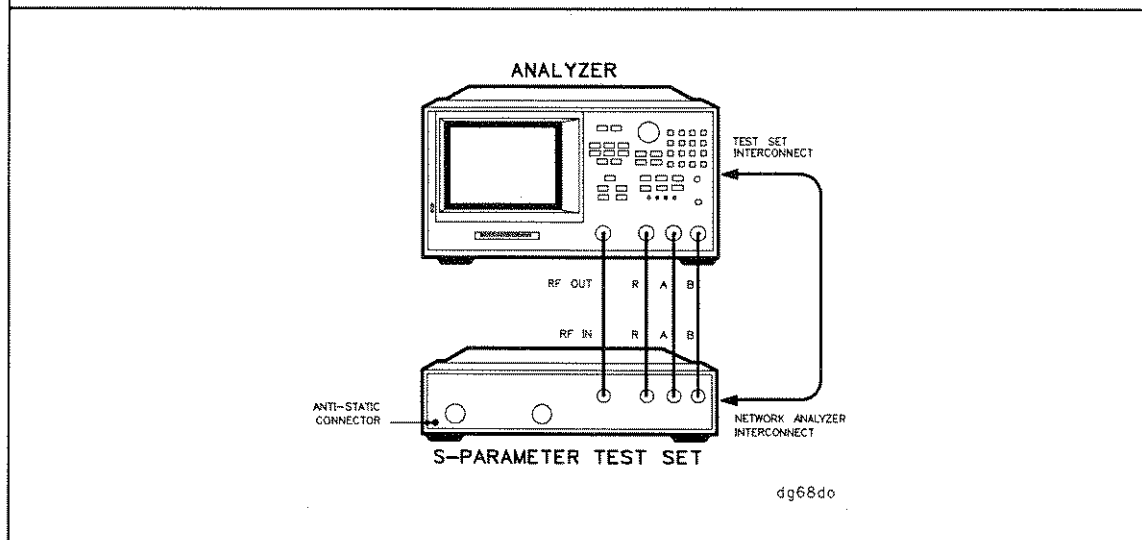

2. Connect 7 mm cables and optional adapter(s) if you are using other connector types.

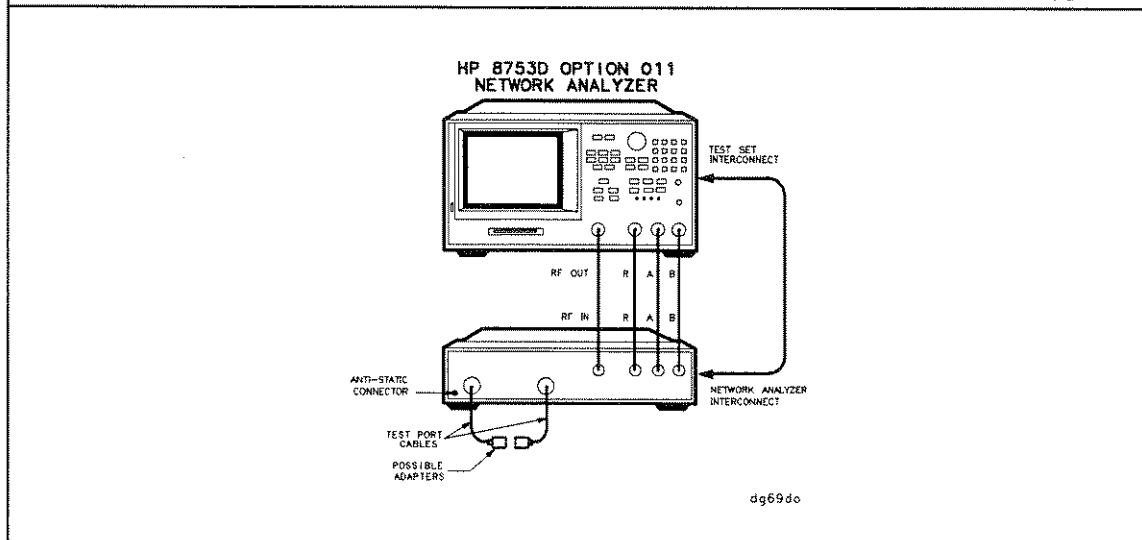

## To Configure an Option 011 Analyzer with a Transmission/Reflection (T/R) Test Set

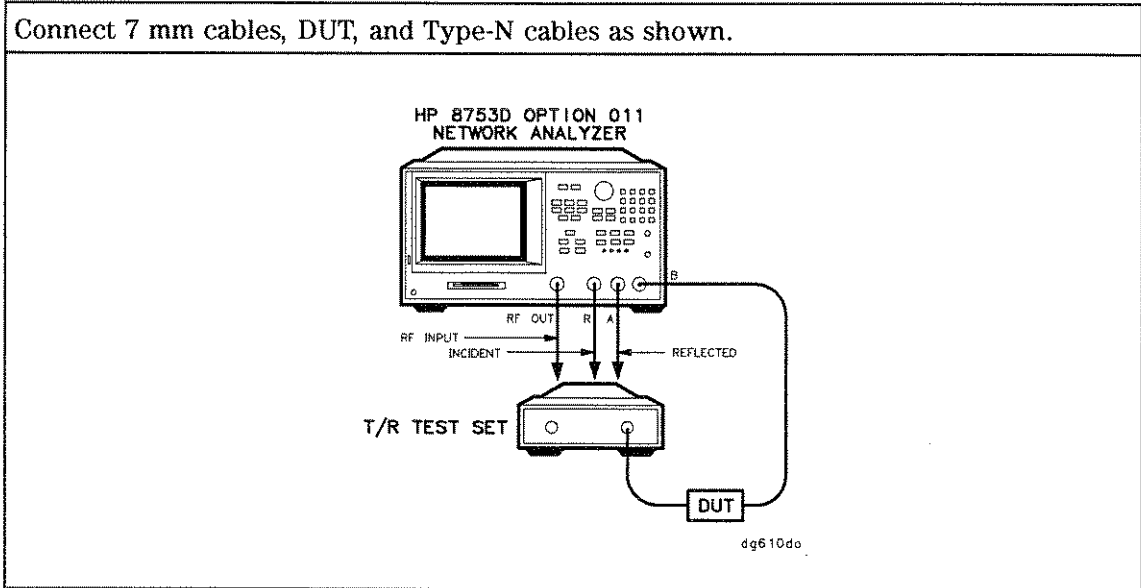

## To Configure an Analyzer that has High Stability Frequency Reference (Option 1D5)

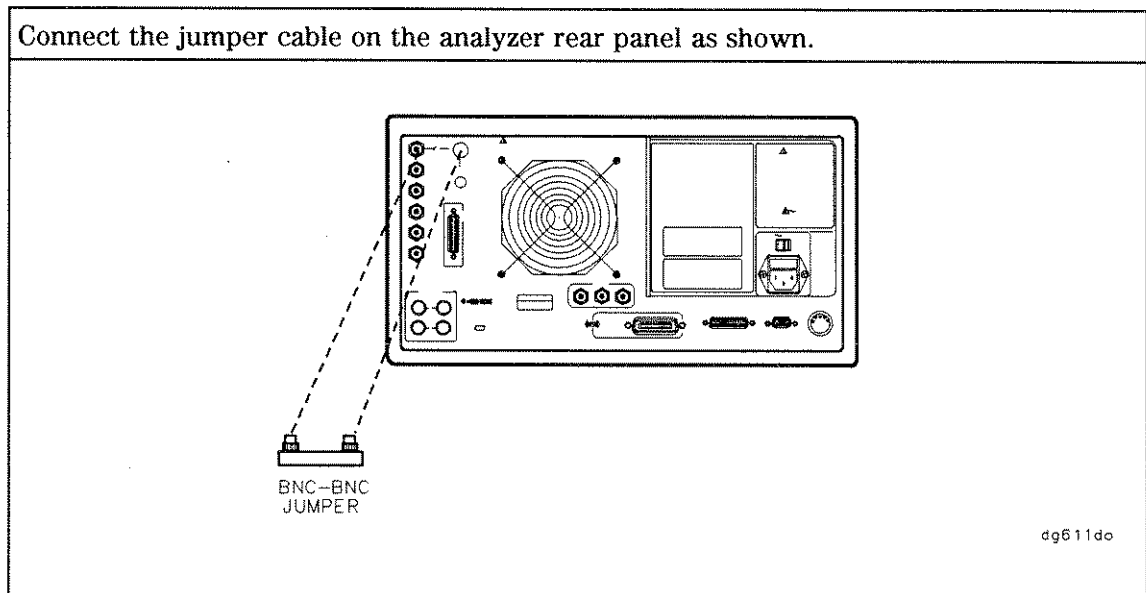

## To Configure an Analyzer with Printers or Plotters

1. Connect your printer or plotter to the corresponding interface.

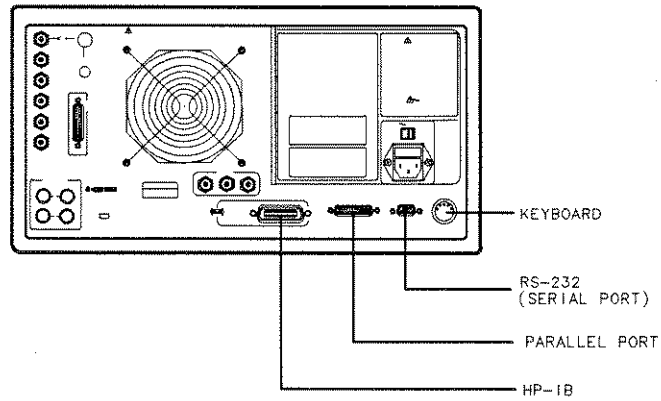

dg612do

2. If you are using the parallel interface, press **LOCAL** and **PARALLEL** until your choice of [GPIO] or [COPY] appears.

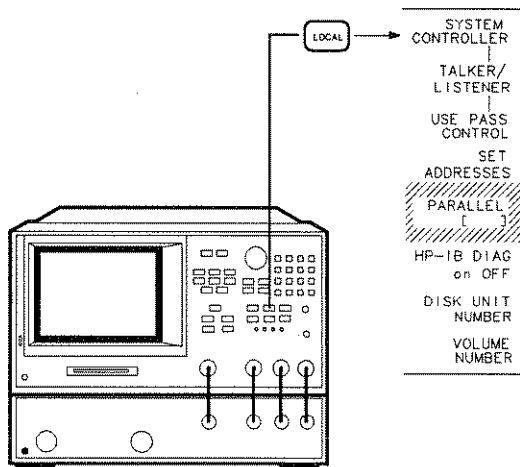

dg613do

- If you choose [COPY], the parallel port is dedicated for normal copy device use (printers or plotters).
- If you choose [GPIO], the parallel port is dedicated for general purpose I/O. The HP 8753D Option 011 controls the data input or output, through the sequencing capability of the analyzer.

3. Press **SET ADDRESSES** and then choose either **PRINTER PORT** or **PLOTTER PORT**, depending on your hardcopy device. Or, if you are plotting your files to disk, press **SET ADDRESSES PLOTTER PORT DISK**.

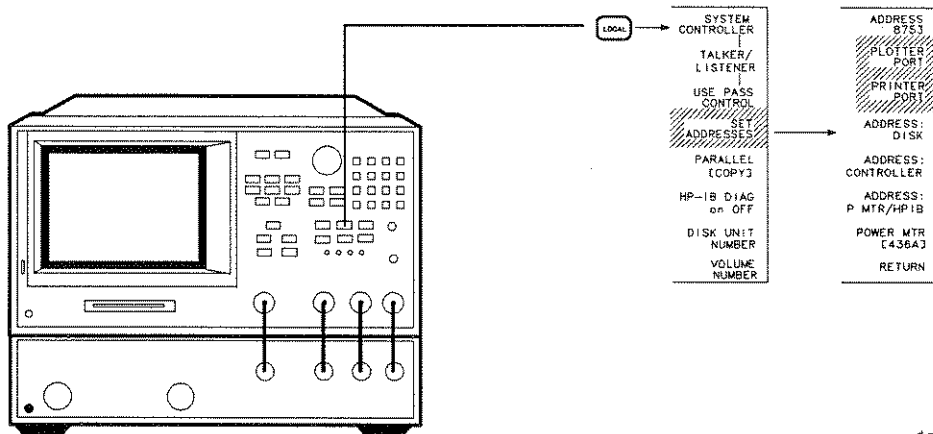

dg614do

4. Press the key that corresponds to your printer or plotter interface: **HP-IB**, **PARALLEL** (parallel port), **SERIAL** (serial port). **NOTE:** The plotter menu is shown as an example. It will only appear if you select **PLOTTER PORT**. Similar interface choices will appear if you select **PRINTER PORT**.

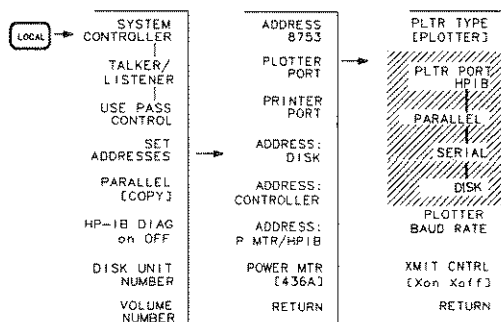

dg615do

- If you select **HP-IB**, the HP-IB address is active so you can then set the address of your printer or plotter.
- If you have already selected the **PARALLEL [COPY]** choice for the parallel-port configuration, you must also select **PARALLEL** in this menu in order to generate a hardcopy.

5. If you will be using the serial port, adjust the analyzer's baud rate until it is equal to the baud rate set on the peripheral by pressing **BAUD RATE** and the **↑** and **↓** front panel keys. **NOTE:** The plotter menu is shown as an example. It will only appear if you select **PLOTTER PORT**.

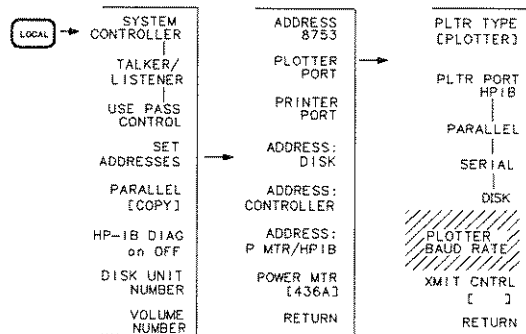

You can set the analyzer to the following rates:

- 1200
- 2400
- 4800
- 9600
- 19200

dg616do

6. Also if you will be using the serial port, you must set the transmission control, **XMIT CNTRL** (handshaking protocol) to either **Xon/Xoff** or **DTR/DSR** (equal to the transmission control set on the peripheral). **NOTE:** Transmission control for plotters is set programmatically. The plotter menu is shown as an example. It will only appear if you select **PLOTTER PORT**.

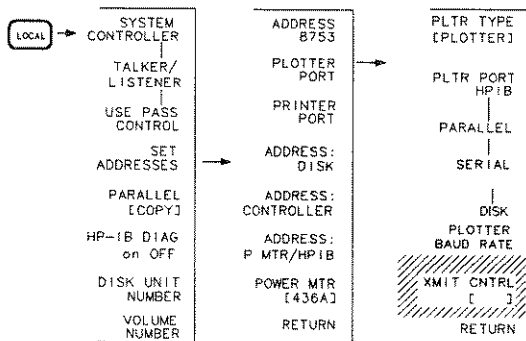

- **Xon/Xoff** sets transmission on/transmission off (software handshake).
- **DTR/DSR** sets data terminal ready/data set ready (hardware handshake).

qg616d

7. If you will be using a plotter, select **PLTR TYPE** and keep pressing the key until the choice you want appears.

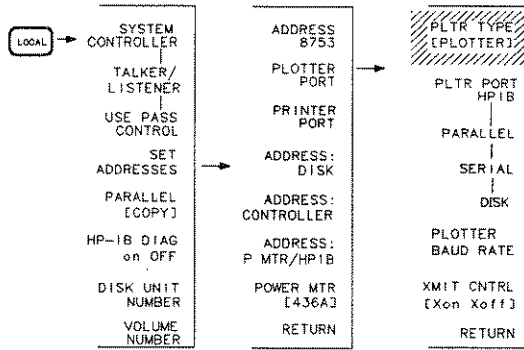

dg617do

- Choose **PLOTTER** for a pen plotter such as the HP 7440A, 7470A, 7475A, or 7550B.
- Choose **HPGL PRT** for a PCL5 compatible printer, which supports HP-GL/2, such as the:
  - LaserJet III
  - LaserJet 4
  - DeskJet 1200C

8. If you will be using a printer, press **PRNTR TYPE** until your printer choice appears.

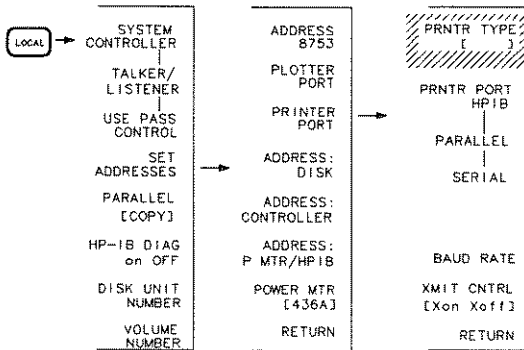

qg619d

- Choose your printer type from these HP printers.
  - THINKJET**
  - DESKJET**
  - LASERJET**
  - PAINTJET**
- Choose **EPSON-P2** for Epson-compatible printers (ESC/P2 printer control language).



9. Press **SYSTEM** **SET CLOCK** to begin setting and activating the time stamp feature so the analyzer places the time and date on your hardcopies and disk directories.

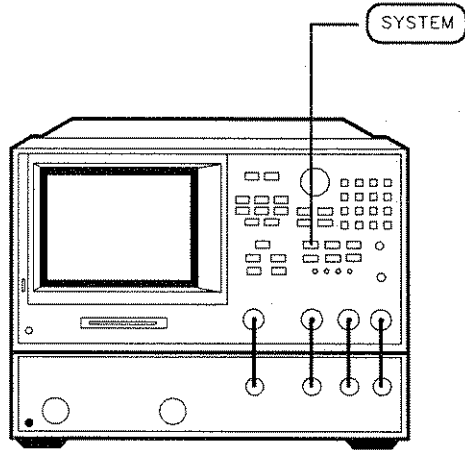

dg618do

10. Press each of the following softkeys to set the date and time.

- TIME STAMP ON off
- ROUND SECONDS
- SET MINUTES — *Select Next Closest Minute*
- SET HOUR — *Select a Number for 24 Hour Clock (0-24)*
- SET DAY — *Select a Number for Calendar Date (1-31)*
- SET MONTH — *Select a Number for Calendar Month (1-12)*
- SET YEAR — *Select a Four Digit Number for Year*
- RETURN

qg621d

11. Press **ROUND SECONDS** when the time is exactly as you have set it.

22 NOV 1994 14:55:00

- TIME STAMP ON off
- ROUND SECONDS — *Press to Synchronize Time*
- SET MINUTES
- SET HOUR
- SET DAY
- SET MONTH
- SET YEAR
- RETURN

qg622d

12. Press **TIME STAMP** so that ON is displayed on the softkey label. Then press **RETURN**.

- TIME STAMP ON off — *Press to Activate Time Stamp*
- ROUND SECONDS
- SET MINUTES
- SET HOUR
- SET DAY
- SET MONTH
- SET YEAR
- RETURN — *Press when Finished*

qg623d

## **To Configure the Analyzer with Cabinet Flange Kits**

There are three kits available for the analyzer:

- instrument front handles kit (standard HP part number 5062-3990)
- cabinet flange kit without front handles (option 1CM HP part number 5062-3978)
- cabinet flange kit with front handles (option 1CP HP part number 5062-4072)

## To Attach Handles to the Analyzer (Standard)

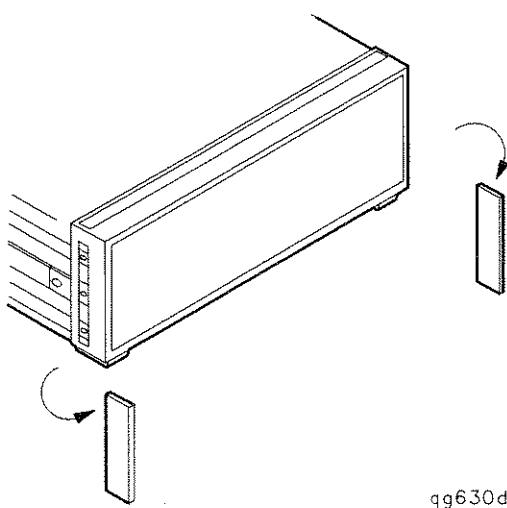
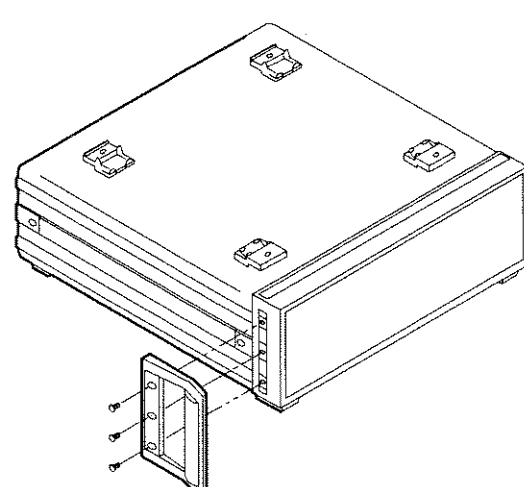
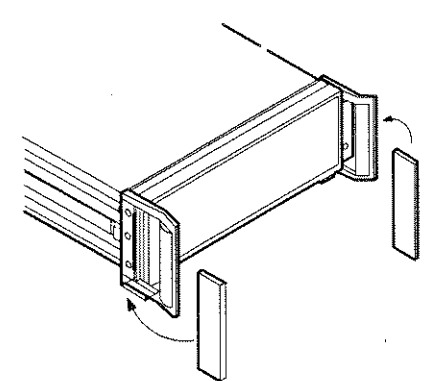
|   |  |
|---|--|
| <p>1. Ensure that the front handles kit is complete. <b>NOTE:</b> If any items are damaged or missing from the kit, contact the nearest HP sales and service office to order a replacement kit. Items within the kit (handles, flanges, screws, etc.) are not individually available.</p> | <p>2. Remove the side trim strips.</p>   |
| <ul style="list-style-type: none"><li>■ (2) front handles</li><li>■ (6) screws</li><li>■ (2) trim strips</li></ul>  |  <p>qq630d</p>  |
| <p>3. Attach the handles to the sides of the front panel, using three screws for each handle.</p>   | <p>4. Place the new trim strip over the screws on the handles.</p>   |
|  <p>qq631d</p>   |  <p>qq632d</p> <p><b>WARNING:</b> If an instrument handle is damaged, you should replace it immediately. Damaged handles can break while you are moving or lifting the instrument and cause personal injury or damage to the instrument.</p> |

## To Attach the Cabinet Flanges to an Analyzer (Option 1CM)

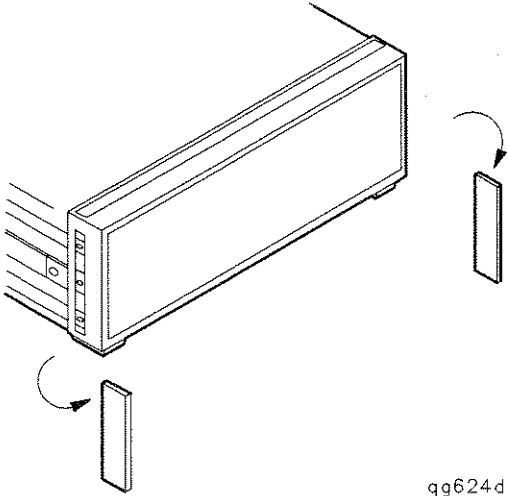
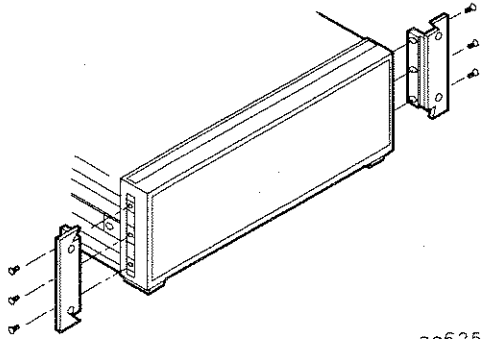
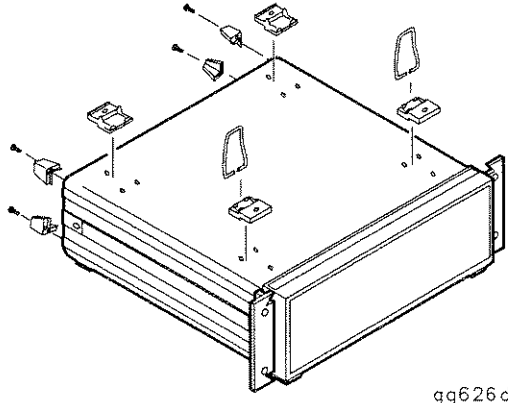
|  |   |
|--|---|
| <p>1. Ensure that the cabinet flange kit is complete.</p>  | <p>2. Remove side trim strips.</p>  |
| <ul style="list-style-type: none"><li>■ (2) cabinet mount flanges</li><li>■ (6) screws</li></ul>         |  <p>qg624-d</p>   |
| <p>3. Attach the cabinet flanges to the sides of the front panel using three screws for each flange.</p> | <p>4. Remove the feet and the tilt stands before cabinet mounting the instrument.</p>               |
|  <p>qg625-d</p>       |  <p>qg626-d</p> |

## To Attach Cabinet Flanges and Front Handles to an Analyzer (Option 1CP)

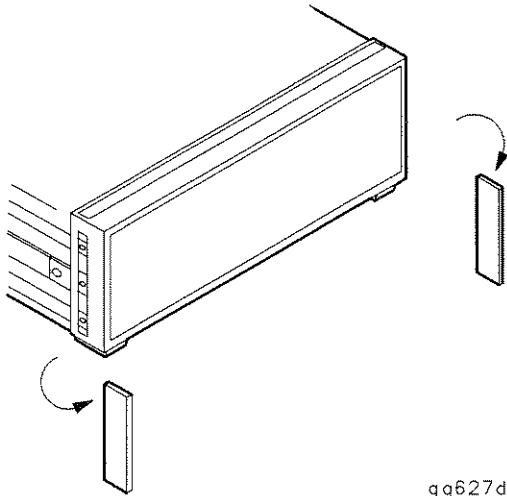
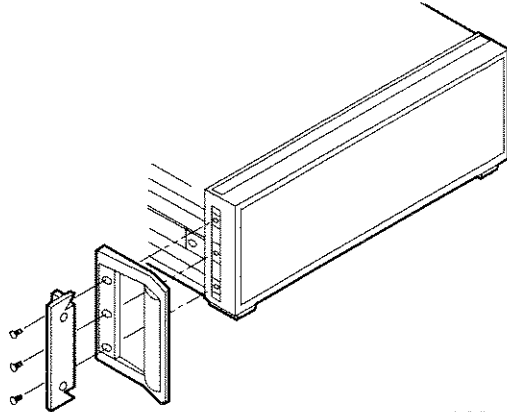
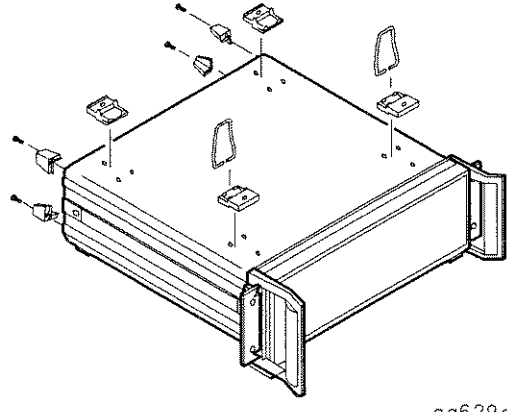
|  |   |
|--|---|
| <p>1. Ensure that the cabinet flange kit with handles is complete.</p> <ul style="list-style-type: none"> <li>■ (2) cabinet mount flanges</li> <li>■ (2) front handles</li> <li>■ (8) screws</li> </ul>  | <p>2. Remove the side trim strips.</p>  <p style="text-align: right;">qq627d</p>  |
| <p>3. Attach the cabinet mount flanges and the handles to the sides of the front panel, using four screws per side. (Attach the flanges to the outside of the handles.)</p>  <p style="text-align: right;">qq628d</p> <p><b>WARNING:</b> If an instrument handle is damaged, you should replace it immediately.</p> | <p>4. Remove the feet and the tilt stands before cabinet mounting the instrument.</p>  <p style="text-align: right;">qq629d</p> |

---

## STEP 5. Verify the Analyzer Operation

This series of procedures shows you how to check your analyzer for correct operation.

- viewing installed options
- initiating the analyzer self-test
- running operator's check
- testing transmission mode
- testing reflection mode

---

### Note

The HP 8753D Option 011 has an on-site warranty, where available. If the HP 8753D Option 011 should fail any of the following checks, call your local HP sales and service office. A customer engineer will be dispatched to service your instrument on-site. If for some reason a customer engineer is not available in your area, send the analyzer to the nearest HP service center for repair, including a description of any failed test and any error message. Ship the analyzer, using the original or comparable anti-static packaging materials. A table listing of Hewlett-Packard sales and service offices is provided at the end of this guide.

---

## To View the Installed Options

1. Switch on the AC power supplied to the analyzer, or cycle the AC power, using the LINE button.

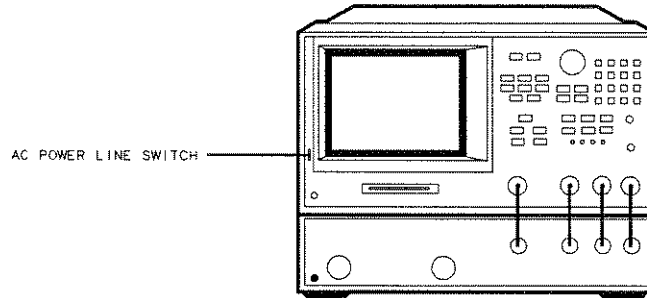

dg519do

2. Locate the serial number and configuration options. Compare them to the shipment documents.

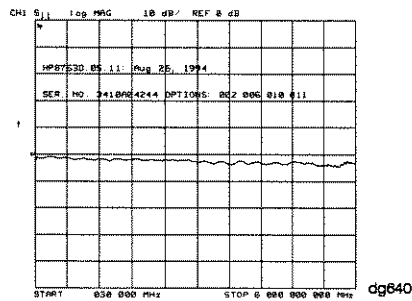

## To Initiate the Analyzer Self-Test

1. Switch on the AC power supplied to the analyzer, and press **PRESET**.

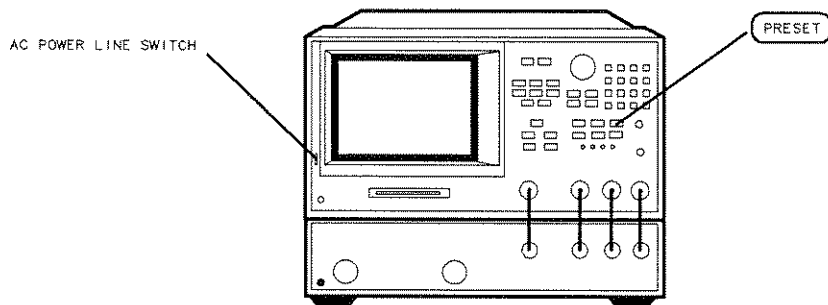

qg634d

2. Watch for the following indications that the analyzer is operating correctly:

MESSAGES APPEAR IN SEQUENCE:

INITIALIZING INSTRUMENT, PLEASE WAIT  
SELF TEST PASSED

ILLUMINATES DURING AND  
AFTER PRESET

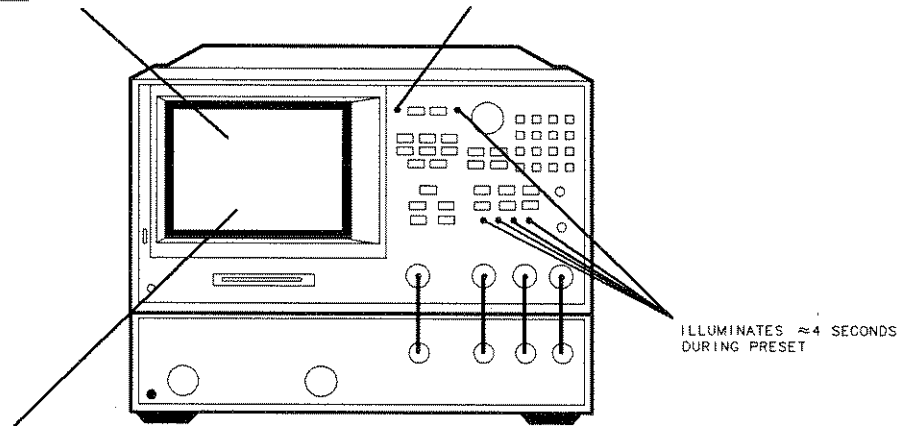

PARAMETERS APPEAR AFTER PRESET:

- CH1,  $S_{11}$ , log MAG, 10dB, REF 0dB
- START 300kHz, STOP 3GHz (or start 30 kHz, stop 6GHz FOR OPTION 006)

dg621do

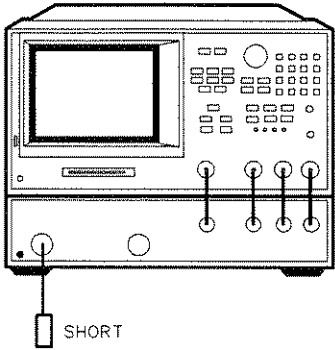
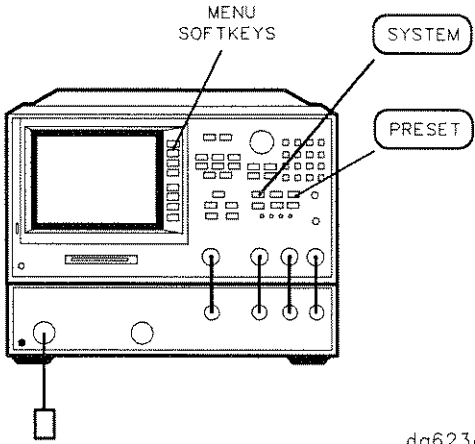
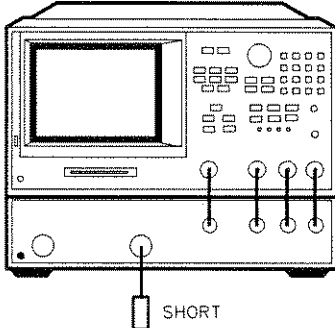
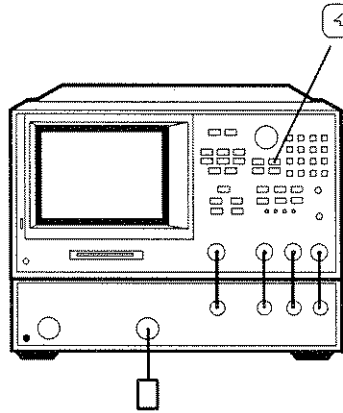

## To Run the Operator's Check

|  |   |
|--|---|
| <p>1. Connect the equipment as shown.</p>  | <p>2. Press <b>PRESET</b> <b>SYSTEM</b> <b>SERVICE MENU</b> <b>TESTS</b> <b>EXTERNAL TESTS</b> <b>EXECUTE TEST</b>.</p> |
|  <p>dg622do</p>   |  <p>dg623do</p>                       |
| <p>3. Follow the prompts shown on the analyzer display and then press <b>CONTINUE</b>.</p>         | <p>4. Press <b>EXECUTE TEST</b>, follow the prompts shown on the analyzer display, and then press <b>CONTINUE</b>.</p>  |
|  <p>dg624do</p> |  <p>dg625do</p>                     |

## To Test the Transmission Mode

1. Connect the equipment as shown and press **PRESET**. **NOTE:** The test port return cable should have low-loss characteristics to avoid a degradation in frequency response at higher frequencies.

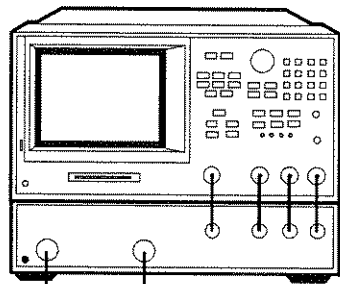

TEST PORT  
RETURN CABLE

dg626do

2. To check the forward transmission mode for channel 2, press **CH 2**.

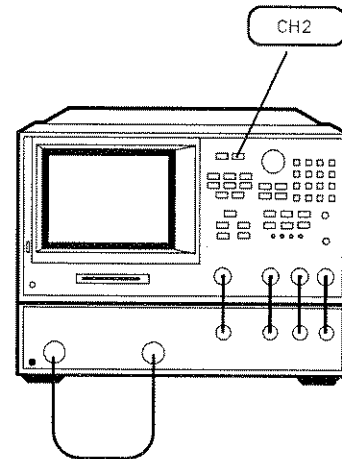

dg627do

3. Look at the measurement trace displayed on the analyzer. It should be similar to the trace below. **NOTE:** The analyzer display shown below and to the right is an HP 8753D Option 011 option 006 display (30 kHz to 6 GHz span).

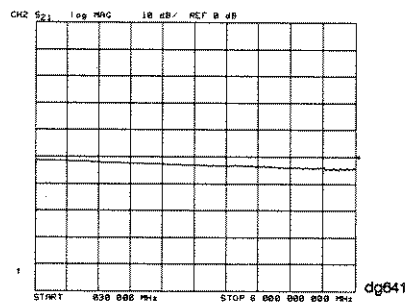

dg641

4. To check the reverse transmission mode for channel 2, press **MEAS**. **Trans: REV S12 (A/R)**. The measurement trace should be similar to the trace below.

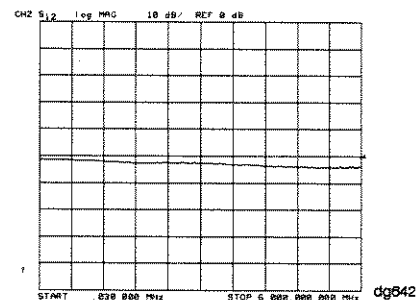

dg642

## To Test the Transmission Mode's Load Match

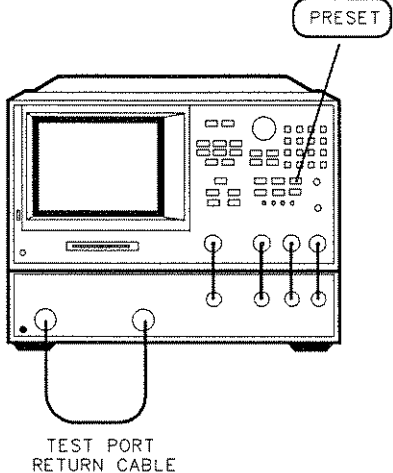
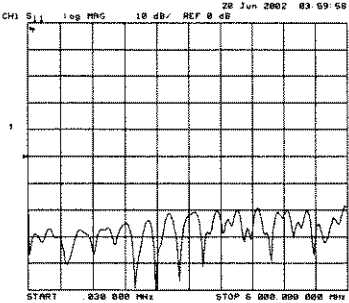
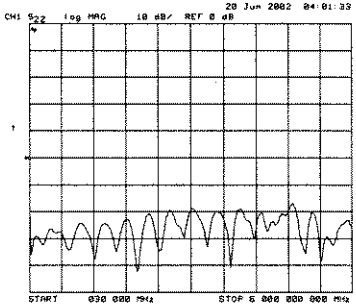
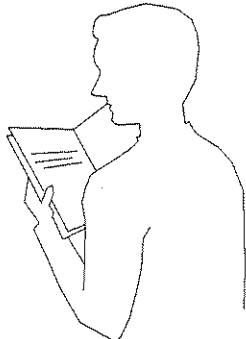
|  |   |
|--|---|
| <p>1. Connect the equipment as shown and press <b>PRESET</b>.</p>  | <p>2. Look at the measurement trace displayed on the analyzer. It should be similar to the trace below.</p>   |
|  <p>TEST PORT RETURN CABLE</p> <p>dg628do</p>   |  <p>CH1 S11 log MAG 10 dB/ REF 0 dB<br/>20 Jun 2002 03:09:58<br/>START 030 000 MHz STOP 6 000 000 MHz</p> |
| <p>3. To check the reverse reflection mode for channel 1, press <b>MEAS</b> <b>Ref1: REV S22 (B/R)</b>. The measurement trace should be similar to the trace shown below.</p>                | <p>4. If you are ready to start making measurements, continue with the next chapter "Quick Start: Learning How to Make Measurements".</p>   |
|  <p>CH1 S22 log MAG 10 dB/ REF 0 dB<br/>20 Jun 2002 04:01:33<br/>START 030 000 MHz STOP 6 000 000 MHz</p> |  <p>qq646d</p>   |

---

## STEP 6. To Backup to the EEPROM Disk

### Description

Correction constants are stored in EEPROM on the A9 controller assembly. The advantage of having an EEPROM backup disk is its capacity to store all the correction-constant data to a new or repaired A9 assembly without having to rerun the correction-constant procedures. The HP 8753D Option 011 network analyzer is shipped from the factory with an EEPROM backup disk which is unique to each instrument. It is prudent to make a second EEPROM backup disk that can be used in case of failure or damage to the original backup disk.

### Equipment

3.5-inch disk ..... HP 92192A (box of 10)

### EEPROM Backup Disk Procedure

1. Insert a 3.5-inch disk into the HP 8753D Option 011 disk drive.
2. Press **PRESET** so that the preset state is stored.
3. If the disk is not formatted, press **SAVE/RECALL** **FILE UTILITIES** **FORMAT DISK**.
  - To format a LIF disk, select **FORMAT:LIF** (The supplied EEPROM backup disk is LIF. The analyzer does not support LIF-HFS format.)
  - To format a DOS disk, select **FORMAT:DOS**Press **FORMAT INT DISK** and answer **YES** at the query.
4. Press **SYSTEM** **SERVICE MENU** **SERVICE MODES** **MORE** **STORE EEPR ON** **SAVE/RECALL** **SELECT DISK** **INTERNAL DISK** **RETURN** **SAVE STATE** to store the correction-constants data onto floppy disk.

---

**Note** A default file "FILE0" is created. The file name appears in the upper left-hand corner of the display. The file type "ISTATE(E)" describes the file as an instrument-state with EEPROM backup.

---

5. Press **FILE UTILITIES** **RENAME FILE** **ERASE TITLE**. Use the RPG and the **SELECT LETTER** softkey to rename the file "FILE0" to "N12345" where 12345 represents the last 5 digits of the instrument's serial number. (The first character in the file name must be a letter.) When finished, press **DONE**.
6. Label the disk with the serial number of the instrument and the words "EEPROM Backup Disk".

---

**Note** Whenever the HP 8753D Option 011 network analyzer is returned to Hewlett-Packard for servicing and/or calibration, the EEPROM backup disk should be returned with the analyzer. This will significantly reduce the instrument repair time.

---

The EEPROM backup disk procedure is now complete.

## Quick Start: Learning How to Make Measurements

---

The information and procedures in this chapter teach you how to make measurements with your analyzer.

- analyzer front panel operation
- general steps for making measurements
  - step 1. selecting measurement parameters
  - step 2. making a measurement calibration
  - step 3. measuring a device
  - step 4. outputting measurement results
- transmission measurements
  - transmission measurement calibration
  - insertion loss
  - save/recall
  - 3 dB bandwidth
  - out-of-band rejection
  - ripple or flatness
- reflection measurements
  - reflection measurement calibration
  - return loss
  - print output
  - reflection coefficient
  - standing wave ratio (SWR)
  - $S_{11}$  and  $S_{22}$  in polar format
  - impedance
  - admittance

## The HP 8753D Option 011 - At a Glance

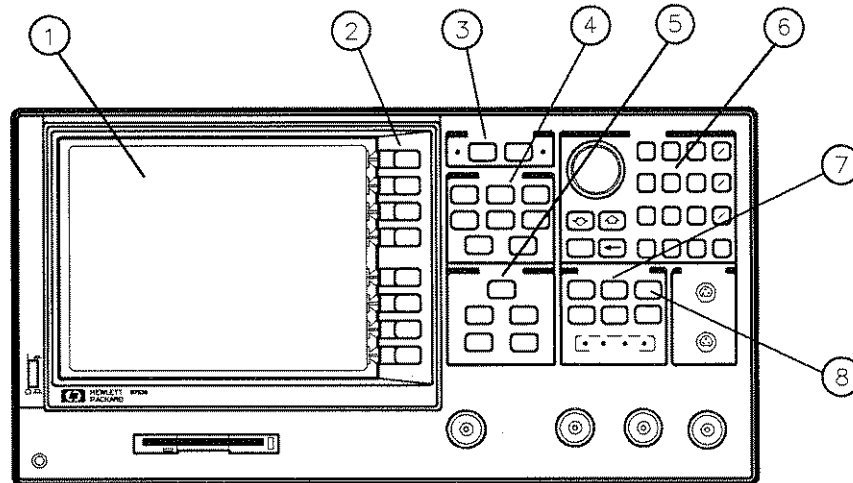

dg629do

Figure 2-1. The HP 8753D Option 011 Front Panel Features

- 1 - The analyzer display** shows the measurement trace, softkey labels, and the values of the current measurement parameters.
- 2 - The softkeys** allow you to make choices from the "menus" that are shown on the analyzer display. The menus list the possible choices for a particular function.
- 3 - The channel keys** allow you to choose which channel is active, and the measurement parameters for that channel. You can select many of the measurement and display functions independently for each measurement channel. To modify the measurement parameters of a particular channel, first select channel one or two, and then make the desired measurement choices. Notice that the light next to the current active channel's key is illuminated.
- 4 - The response keys** allow you to control the analyzer's receiver. The top three keys allow you to choose the measurement parameter (Press: **MEAS** for softkey/measurement options such as **Refl: FWD S11 (A/R)**, **Trans: FWD S21 (B/R)**, **Trans: REV S12 (A/R)**, etc.), presentation format (amplitude or phase versus frequency, Smith chart, polar coordinates, and so on), and scale and reference values for a full screen display.
- The lower five keys in this section enhance the usability of the measured data. The displayed traces may be overlaid, manipulated with math function keys, averaged,

### 2-2 Quick Start: Learning How to Make Measurements

normalized, or read out at specific points along the trace with up to four independent markers per channel.

#### 5 - The stimulus keys

allow you to define an appropriate source output signal for the device under test. Source frequency may be swept over any portion of the range 300 kHz to 3 GHz (or 30 kHz to 6 GHz with option 006), at powers between +20 (+18 for option 006) and -5 dBm. The stimulus keys also allow you to control the start and stop times in the (optional) time domain mode. The choices for sweep time and resolution, linear versus logarithmic sweep, power sweep, number of points, and others are also selected here.

#### 6 - The numeric keypad

allows you to enter a numeric value for a chosen parameter, for example frequency or amplitude. Use the keys to the right of the digit keys to terminate the data entry with the appropriate units. Use  $\overline{G/n}$  (Giga/nano),  $\overline{M/\mu}$  (Mega/micro),  $\overline{k/m}$  (kilo/milli), and  $\overline{x1}$  (basic units: dB, dBm, degree, second) as applicable. You can also use the knob for making continuous adjustments to parameter values, while the  $\overline{\uparrow}$  and  $\overline{\downarrow}$  keys allow you to change values in steps.

#### 7 - The instrument state keys

allow you to control several functions, including instrument preset, save/recall, printer or plotter control, time domain transform (optional), test sequencing, and built-in diagnostic tests.

#### 8 - The PRESET key

sets the analyzer to either a predetermined, "factory" or user-defined preset condition. See the "Preset State and Memory Allocation" portion of the *HP 8753D Option 011 Network Analyzer User's Guide* for the conditions at preset.

---

## Measurement Procedure

This generic measurement procedure is used throughout the guide to illustrate the use of the HP 8753D Option 011.

### Step 1. Choose measurement parameters with your test device connected

- Press the **PRESET** key to return the analyzer to a known state.
- Connect your test device to the analyzer.
- Choose the settings that are appropriate for the intended measurement.
  - measurement type
  - frequencies
  - number of points
  - power
  - measurement trace format
- Make adjustments to the parameters while viewing the device response.

### Step 2. Make a measurement calibration

Press the **CAL** key to begin to make a measurement calibration using a known set of standards (a calibration kit). A measurement calibration establishes a magnitude and phase reference for the test setup and reduces the effects of systematic measurement errors.

### Step 3. Measure the device

- Reconnect the device under test.
- Use the markers to identify various device response values.

### Step 4. Output measurement results

- Store the measurement file to a disk.
- Generate a hardcopy with a printer or plotter.



## Learning to Make Transmission Measurements

This example procedure shows you how to measure the transmission response of a bandpass filter. The measurement parameters listed are unique to this particular test device.

For further measurement examples, refer to the "Optimizing Measurement Results" chapter in the *HP 8753D Option 011 Network Analyzer User's Guide*.

### Step 1. Choose the measurement parameters with the device connected

1. Connect your test device to the S-parameter test set and analyzer combination as shown in Figure 2-2.

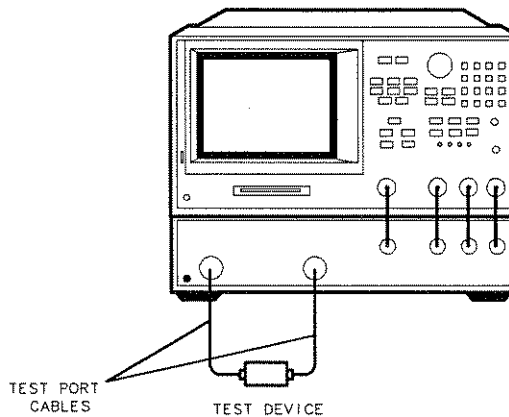

dg630do

Figure 2-2. Device Connections for a Transmission Measurement

2. Press **PRESET** and choose the following measurement settings:
3. **MEAS** **Trans: FWD S21 (B/R)**
4. **CENTER** **125** **M/μ** (Change to match the center frequency of your device.)
5. **SPAN** **125** **M/μ** (Change to match the bandwidth of your device.)
6. **MENU** **POWER** **5** **x1** **RETURN** **↑**
7. **SCALE REF** **AUTO SCALE**
8. Look at the device response to determine if these are the parameters that you want for your device measurement. For example, if the trace is noisy you may want to increase the input power, reduce the IF bandwidth, or add averaging. Or, to better see an area of interest you may want to change the test frequencies.

## Step 2. Make a measurement calibration

1. Connect a "thru" between the measurement cables, as shown in Figure 2-3. Include all the adapters that you will use in your device measurement.

If noise reduction techniques are needed for the measurement, the instrument's settings (reduced IF BW, and/or averaging) should be done prior to any calibration.

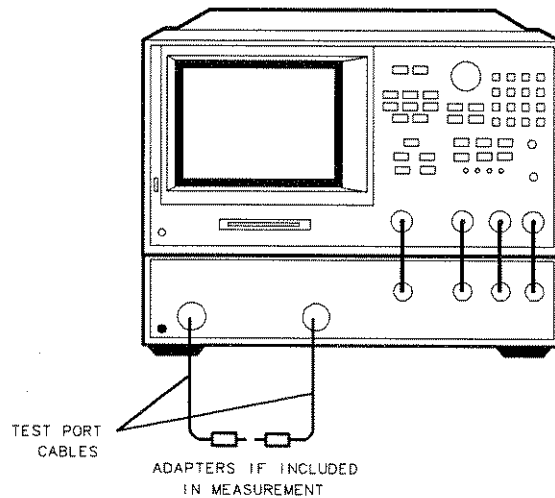

dg631do

Figure 2-3. Connections for a "Thru" Calibration Standard

2. Press the following keys to make a transmission response calibration:

**CAL** **CALIBRATE MENU** **RESPONSE** **THRU**

3. After the analyzer takes a measurement sweep, press:

**DONE** **RESPONSE**

4. To save the measurement calibration, press:

**SAVE/RECALL** **SELECT DISK**

5. Next, choose from the following options (selection determines where saved state will be stored):

- Choose **INTERNAL MEMORY** if you want to save the calibration results to the analyzer's memory.
- Choose **INTERNAL DISK** if you want to save the calibration results to the disk that is in the analyzer's internal disk drive.
- Choose **EXTERNAL DISK** if you want to save the calibration results to the disk that is in an external disk drive that is configured to the analyzer.

6. Press **RETURN** **SAVE STATE** to save the measurement calibration.

## 2-6 Quick Start: Learning How to Make Measurements

## Note

Example procedures for all types of measurement calibrations are located in the "Making Measurements" chapter in the *HP 8753D Option 011 Network Analyzer User's Guide*. For information on the analyzer operation during a measurement calibration, refer to the "Application and Operation Concepts" chapter in the User's Guide.

### Step 3. Measure the device

1. Connect your test device as in Figure 2-2. Use adapters where appropriate.
2. Press **SCALE REF** **AUTO SCALE** to reposition the measurement trace for the best view.
3. Press **MARKER** and turn the front panel knob to place the marker at a frequency of interest. Read the device's insertion loss to 0.0001 dB resolution as shown in Figure 2-4.

The analyzer shows the frequency of the marker location in the active entry area (upper-left corner of display). The analyzer also shows the amplitude and frequency of the marker location in the top-right corner of the display.

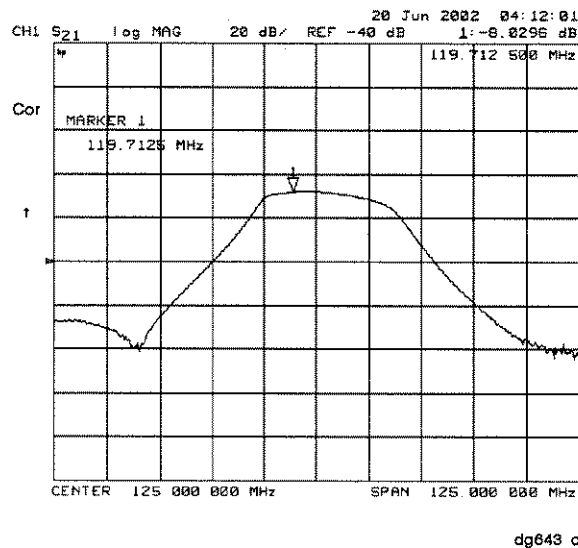

Figure 2-4. Example Measurement of Insertion Loss

### Step 4. Output measurement results

In this example procedure you are shown how to output (store) measurement results to a disk.

For more information on creating a hardcopy of the measurement results, refer to the "Printing, Plotting, or Saving Measurement Results" chapter in the *HP 8753D Option 011 Network Analyzer User's Guide*.

1. Insert a DOS- or LIF-formatted disk into the analyzer disk drive. The analyzer does not support LIF-HFS (hierarchy file system).
2. To output the measurement results to a disk, press:

**SAVE/RECALL** **SELECT DISK**. The following selection determines where saved state will be stored.

- Choose **INTERNAL DISK** if you want the analyzer to show the catalog for the contents of the disk that is in the analyzer's internal disk drive.

- Choose **EXTERNAL DISK** if you want the analyzer to show the catalog for the contents of a disk that is in an external disk drive that is configured to the analyzer.
3. Press **RETURN DEFINE DISK-SAVE**
- Choose **DATA ARRAY ON** if you want to store the error-corrected data on disk with the instrument state.
  - Choose **RAW ARRAY ON** if you want to store the raw data (ratioed and averaged but no error correction) on disk with the instrument state.
  - Choose **FORMAT ARY ON** if you want to store the formatted data on disk with the instrument state.
  - Choose **GRAPHICS ON** if you want to store user graphics on disk with the instrument state.
  - Choose **DATA ONLY ON** if you want to only store the measurement data of the device under test. The analyzer will not store the instrument state and measurement calibration; therefore, the saved data cannot be retrieved into the analyzer.
  - Choose **SAVE USING BINARY** if you want to store data in a binary format.
  - Choose **SAVE USING ASCII** if you want to store data in an ASCII format to be read on a computer at a later time.
4. Press **RETURN SAVE STATE** and the analyzer saves the file with a default title.

### Measuring Other Aspects of Insertion Loss with Marker Functions

Using the analyzer marker functions, you can derive several important filter parameters from the measurement trace that is shown on the analyzer display.

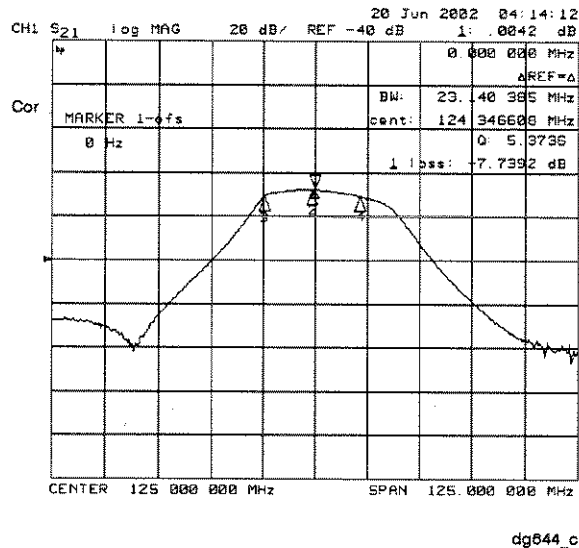

Figure 2-5. Example Measurement of 3 dB Bandwidth

3 dB Bandwidth.

2-8 Quick Start:  
Learning How to  
Make Measurements

The analyzer can calculate your test device bandwidth between two equal power levels. In this example procedure, the analyzer calculates the  $-3$  dB bandwidth relative to the center frequency of the filter.

1. Press **MARKER** and turn the front panel knob to move the marker to the center frequency position of the filter passband.
  - You can also position the marker by entering a frequency location: for example, press **125** **M/μ**.

2. Press **MKR ZERO** to zero the delta marker magnitude and frequency (this sets the delta marker reference). The  $-3$  dB points will be relative to this marker.

The softkey label changes to **MKR ZERO Δ REF=Δ** to show you that the delta reference point is the small  $\Delta$  symbol.

3. Press **MARKER FCTN** **MKR SEARCH** to enter the marker search mode.
4. Press **WIDTHS ON**.

The analyzer calculates the  $-3$  dB bandwidth, the center frequency and the Q (Quality Factor) of the test device and lists the results in the upper-right corner of the display. Markers 3 and 4 indicate the location of the  $-3$  dB points, as shown in Figure 2-5.

5. Press **WIDTH VALUE** and enter **−** **6** **×**.

The analyzer now calculates the bandwidth between  $-6$  dB power levels.

6. Press **MARKER** **all OFF** when you are finished with this measurement.

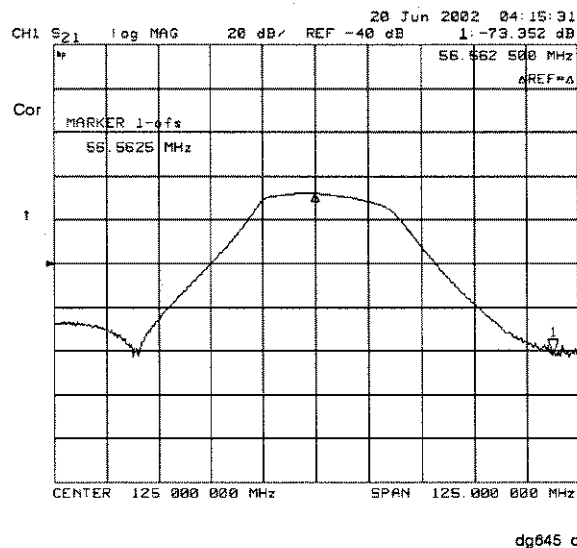

Figure 2-6. Example Measurement of Out-of-Band Rejection

### Out-of-Band Rejection.

1. Press **MARKER 1**. The marker appears where you placed it during the bandwidth measurement.
2. Press **MKR ZERO** **MARKER FCTN** **MKR SEARCH** **SEARCH: MIN**.

The marker automatically searches for the minimum point on the trace. The frequency and amplitude of this point, relative to the delta symbol in the center of the filter passband,

appear in the upper-right corner of the display. This value is the difference between the maximum power in the passband and the maximum power in the rejection band, that is, one of the peaks in the rejection band.

**Note** You can use the marker search mode to search the trace for the maximum point or for any target value. The target value can be an absolute level (for example,  $-3$  dBm) or a level relative to the location of the small delta symbol (for example:  $-3$  dB from the center of the passband).

3. If your measurement needs some noise reduction, you could reduce the IF bandwidth or add averaging.

- To reduce the IF bandwidth, press **AVG** **IF BW** **↓**.
- To add averaging, press **AVG** **AVERAGING ON**.

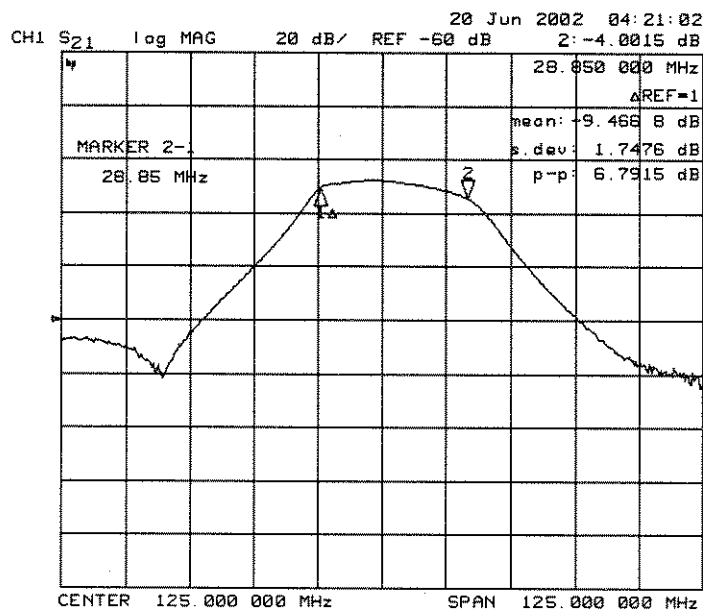

Figure 2-7. Example Measurement of Passband Flatness or Ripple

### Passband Flatness or Ripple.

Passband flatness (or ripple) is the variation in insertion loss over a specified portion of the passband.

Continue with the following steps to measure passband flatness or ripple.

1. Press **MARKER** and turn the front panel knob to move marker 1 to the left edge of the passband.
2. Press **ΔMODE MENU** **Δ REF=1** to change the marker 1 position to the delta reference point.
3. Press **MARKER 2** and turn the front panel knob to move marker 2 to the right edge of the passband.
4. Press **MARKER FCTN** **STATS ON**.

When  $\Delta$  markers are on, the analyzer calculates the mean, standard deviation, and peak-to-peak variation between the  $\Delta$  REF marker and the active marker, and lists the

### 2-10 Quick Start: Learning How to Make Measurements

results in the upper-right corner of the display. The passband ripple is automatically shown as the peak-to-peak variation between the markers.



---

## Learning to Make Reflection Measurements

This example procedure shows you how to measure the reflection response of a bandpass filter. The measurement parameter values listed are unique to this particular test device.

For further measurement examples, refer to the "Making Measurements" chapter in the *HP 8753D Option 011 Network Analyzer User's Guide*.

---

**Note** Reflection measurements monitor only one port of a test device. When a test device has more than one port, you must ensure that the unused port(s) are terminated in their characteristic impedance (for example, 50Ω or 75Ω). If you do not terminate unused ports, reflections from these ports will cause measurement errors.

You can connect an unused device port to the unused analyzer test port, to act as a termination. For example: when you are measuring  $S_{11}$  or  $S_{22}$ , you can connect an unused device port to the analyzer's PORT 2 or PORT 1, respectively.

---

The signal reflected from the device under test is measured as a ratio of the reflected energy versus the incident energy. It can be expressed as reflection coefficient, return loss, or standing-wave-ratio (SWR). These measurements are mathematically defined as follows:

**reflection coefficient ( $\Gamma$ )** = reflected voltage / incident voltage  
=  $S_{11}$  or  $S_{22}$  (magnitude and phase)

**return loss (dB)** =  $-20 \log(\rho)$      $\rho = |\Gamma|$

**standing-wave-ratio (SWR)** = V maximum / V minimum  
=  $(1 + \rho) / (1 - \rho)$



## Step 1. Choose the measurement parameters with the device connected

**Note** For purposes of explanation, a 125 MHz bandpass filter was used as the test device throughout this section.

1. Connect your test device to the S-parameter and analyzer combination as shown in Figure 2-8.

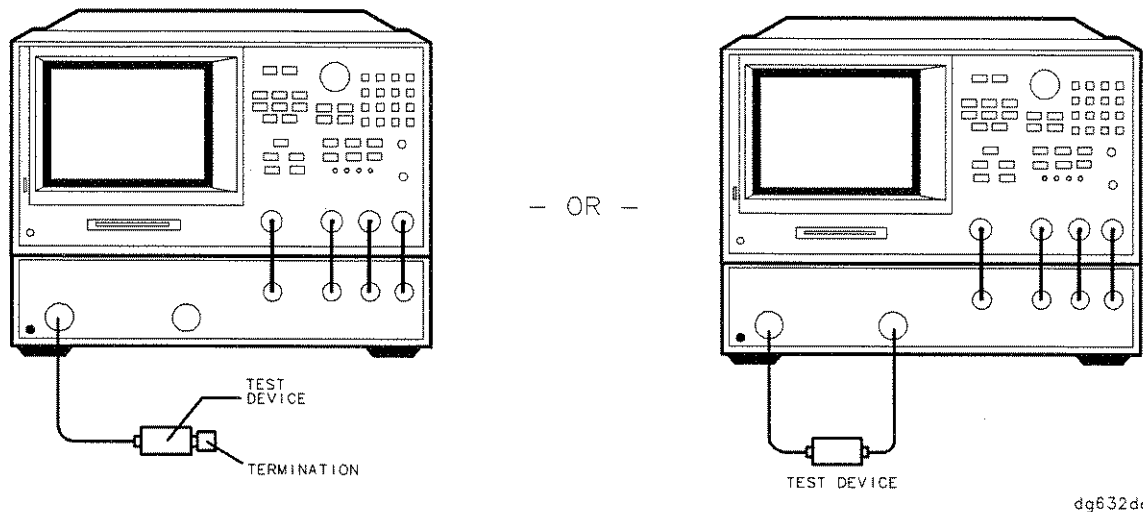

**Figure 2-8. Connections for Reflection Measurements**

2. Press **PRESET** and choose the following measurement parameters:

**MEAS** Refl:FWD S11 (A/R)

**CENTER** 125 **M/μ**

**SPAN** 100 **M/μ**

**MENU** **POWER** 5 **x1** **RETURN** **↑**

**SCALE REF** **AUTO SCALE**

**Note** If you press **START** and **STOP**, the analyzer will show the frequencies at the beginning and end of the frequency span that you have set up around the center frequency. This is also another method you could use to set the analyzer's measurement frequencies.

3. Look at the device response to determine if these are the measurement parameters that you want. For example, if the trace is noisy you may want to increase the input power, reduce the IF bandwidth, or add averaging. Or, to better see an area of interest you may want to change the test frequencies.

## Step 2. Make a measurement calibration

Follow these instructions to make an  $S_{11}$  1-port calibration:

1. Select the calibration kit for your device under test. Press **CAL** **CAL KITS**. Choose the calibration kit for your test device by pressing the corresponding softkey. For example, if the connectors of the calibration kit devices are Type-N 50 $\Omega$  connectors, press **N 50 $\Omega$** .
2. Press **RETURN** **CALIBRATE MENU** **S11 1-PORT**.
3. Follow the prompts shown on the analyzer display to connect and measure an open, short, and load on PORT 1.

Any choice of male/female in the calibration process should always be made for the sex that represents the test port. For example, if the test port had a male, Type-N connector, you would connect the female, Type-N calibration device. But when you follow the prompts on the analyzer to measure a short calibration standard, you would select **SHORT (M)**, or the sex that represents the test port.

---

**Caution** To ensure an accurate measurement calibration, you must connect the calibration standards to the adapters or cables that you will include in the actual device measurement.

---

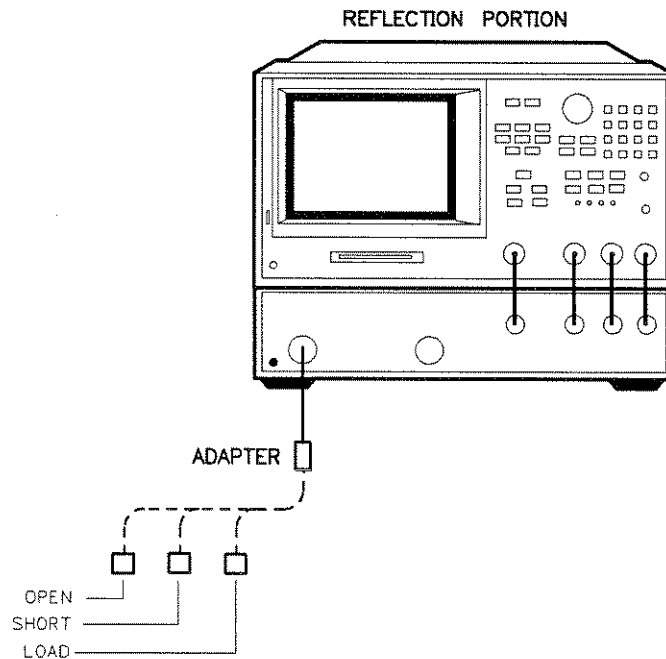

dg633do

**Figure 2-9. Connections for an  $S_{11}$  1-Port Measurement Calibration**

4. Press **DONE 1-PORT CAL** after measuring the three standards.
5. Press **SAVE/RECALL**.
6. Press **SAVE STATE** to complete the process.

**2-14 Quick Start:**  
**Learning How to**  
**Make Measurements**

### Step 3. Measure the device

#### Measuring Return Loss.

1. Connect your device to PORT 1.
2. Terminate any unused port on your device. You can do this by either connecting a load to the device's unused port, or by connecting the device's unused port to PORT 2 on the HP 8753D.
3. Press **SCALE REF** **AUTO SCALE** to reposition the trace.
4. Press **MARKER** to read the return loss from the analyzer display as shown in Figure 2-10.

The device response indicates that the filter and the analyzer impedances are well matched within the frequency range of the filter passband. That is, the reflected signal is smaller within the filter passband than outside the passband.

In terms of return loss, the value within the passband is larger than outside the passband. A large value for return loss corresponds to a small reflected signal just as a large value for insertion loss corresponds to a small transmitted signal.

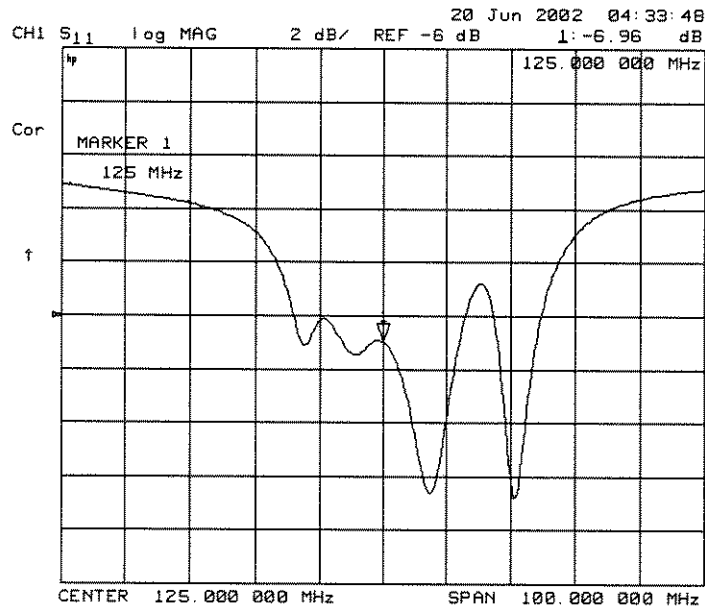

Figure 2-10. Example Return Loss Measurement Trace

### Step 4. Output measurement results

This step in the procedure shows you how to output the measurement results to a printer.

For in-depth information on creating a hardcopy of the measurement results, refer to the "Printing, Plotting, or Saving Measurement Results" chapter in the *HP 8753D Option 011 Network Analyzer User's Guide*.

1. Connect a printer to the analyzer as described in the "Installing Your Analyzer" chapter.
2. Press **DISPLAY** **MORE** **TITLE** and then create a title for the measurement, as shown in Figure 2-11:
  - Use an optional DIN keyboard to type the title, or
  - Use the front panel knob and the softkey menu to select each letter of the title.

3. Press **DONE** when you finish creating the measurement title. The title appears on the upper-left corner of the analyzer display.
4. Press **LOCAL SYSTEM CONTROLLER** to set up the analyzer as the controller. If you are using an HP-IB printer, ensure that there is not another controller on the bus. (Note that this step is not required when using parallel or serial printers.)
5. Press **COPY PRINT MONOCHROME** to create a black-and-white hardcopy.

---

**Note** If you encounter a problem when printing a hardcopy, refer to "To Configure an Analyzer with Printers or Plotters" in the "Installing your Analyzer" chapter.

---

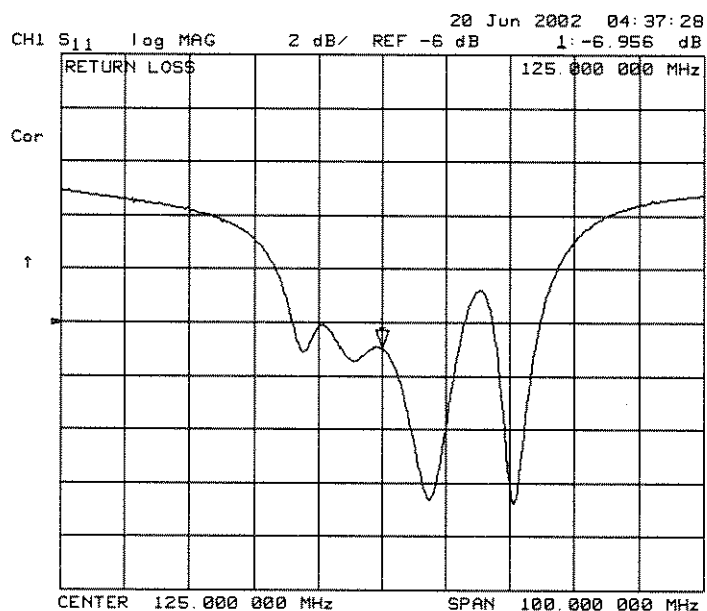

**Figure 2-11. Example Measurement Title**

## Measuring Other Reflection Characteristics

You can derive several important filter parameters from the measurement shown on the analyzer display. The following set of procedures is a continuation of the previous reflection measurement procedure.

### Measuring Reflection Coefficient.

1. Press **FORMAT LIN MAG SCALE REF AUTO SCALE** so the analyzer shows the same data in terms of reflection coefficient, as shown in Figure 2-12.

The units "mU" displayed on the analyzer are "milli-units," where "units" or "U" is used to indicate that the parameter is unitless (as opposed to log or linear). For example, 200 mUnits = 0.2.

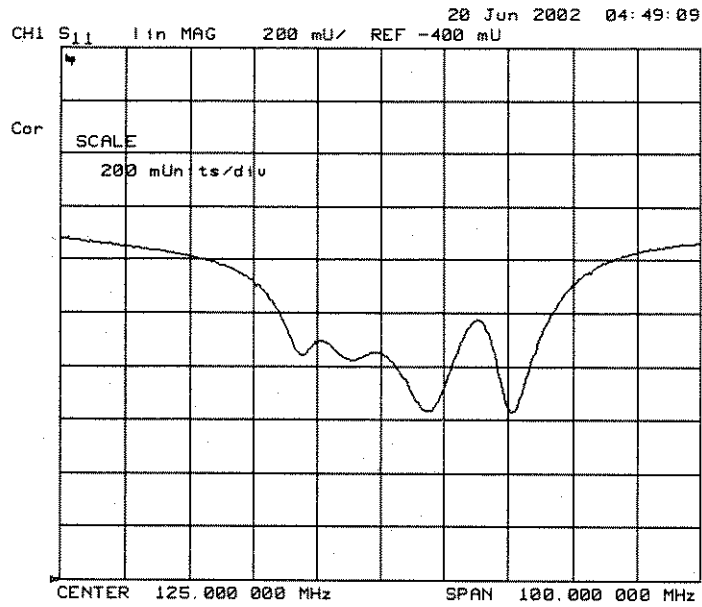

Figure 2-12. Example Reflection Coefficient Measurement Trace

### Measuring Standing Wave Ratio.

Press **FORMAT** **SWR** so the analyzer shows the same data in terms of standing-wave-ratio (SWR), as shown in Figure 2-13.

Now the analyzer shows the measurement data in the unitless measure of SWR where SWR = 1 (perfect match) at the bottom of the display.

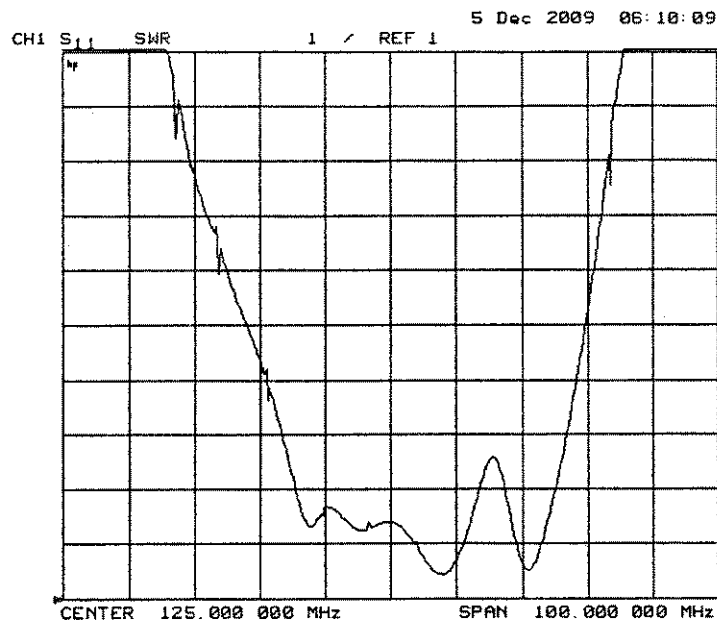

Figure 2-13. Example Standing-Wave-Ratio Measurement Trace

## Measuring $S_{11}$ and $S_{22}$ in a Polar Format.

$S_{11}$  is a measurement parameter used to measure the reflection coefficient of the test device input, where  $S_{22}$  is a measurement parameter used to measure the reflection coefficient of the test device output. In both instances, all the unused ports must be terminated.

1. Press **FORMAT** **POLAR**.
2. Press **SCALE REF** **AUTO SCALE** to reposition the trace, as shown in Figure 2-14.

The analyzer shows the results of an  $S_{11}$  measurement with each point on the polar trace corresponding to a particular value of both magnitude and phase. The center of the circle represents a coefficient ( $\Gamma$ ) of 0, (that is, a perfect match or no reflected signal). The outermost circumference of the scale shown in Figure 2-14 represents  $\rho = 2.00$ , or 200% reflection. The phase angle is read directly from this display. The 3 O'clock position corresponds to zero phase angle, (that is, the reflected signal is at the same phase as the incident signal). Phase differences of  $90^\circ$ ,  $180^\circ$ , and  $-90^\circ$  correspond to the 12 O'clock, 9 O'clock, and 6 O'clock positions on the polar display, respectively.

3. Press **MARKER** **MARKER MODE MENU** **POLAR MKR MENU**.
4. Turn the front panel knob to position the marker at any desired point on the trace, then read the frequency, linear magnitude and phase in the upper right hand corner of the display, as shown in Figure 2-14.
  - Choose **LIN MKR** if you want the analyzer to show the linear magnitude and the phase of the marker.
  - Choose **LOG MKR** if you want the analyzer to show the logarithmic magnitude and the phase of the active marker. This is useful as a fast method of obtaining a reading of the log-magnitude value without changing to log-magnitude format.
  - Choose **Re/Im MKR** if you want the analyzer to show the values of the marker as a real and imaginary pair.

---

**Note** You can also enter the frequency of interest, from either the attached keyboard or the numeric keyboard, and read the magnitude and phase at that point.

---

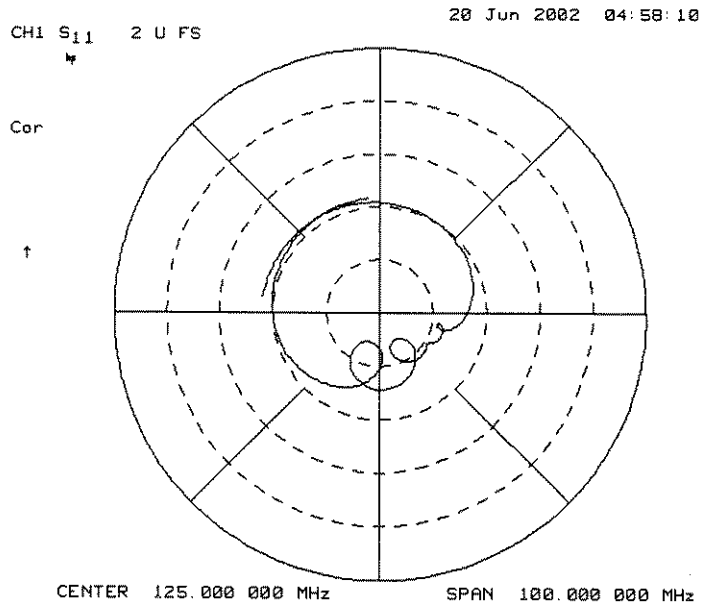

**Figure 2-14.**  
**Example S<sub>11</sub> Measurement Trace in Polar Format with Markers**

### Measuring Impedance.

The amount of power reflected from a device is directly related to the impedance of the device and the measuring system. Each value of the reflection coefficient ( $\Gamma$ ) uniquely defines a device impedance;  $\Gamma = 0$  only occurs when the device and analyzer impedance are exactly the same. The reflection coefficient for a short circuit is:  $\Gamma = 1 \angle 180^\circ$ . Every other value for  $\Gamma$  also corresponds uniquely to a complex device impedance, according to the equation:

$$Z_L = [(1 + \Gamma) / (1 - \Gamma)] \times Z_0$$

where  $Z_L$  is your test device impedance and  $Z_0$  is the measuring system's characteristic impedance (50 $\Omega$  or 75 $\Omega$ ).

1. Press **FORMAT** **SMITH CHART**.
2. Press **MARKER** **MARKER MODE MENU** **SMITH MKR MENU** and turn the front panel knob to read the resistive and reactive components of the complex impedance at any point along the trace, as shown in Figure 2-15. This is the default Smith chart marker.

The marker annotation tells that the complex impedance is capacitive in the bottom half of the Smith chart display and is inductive in the top half of the display.

- Choose **LIN MKR** if you want the analyzer to show the linear magnitude and the phase of the reflection coefficient at the marker.
- Choose **LOG MKR** if you want the analyzer to show the logarithmic magnitude and the phase of the reflection coefficient at the active marker. This is useful as a fast method of obtaining a reading of the log magnitude value without changing to log magnitude format.
- Choose **Re/Im MKR** if you want the analyzer to show the values of the reflection coefficient at the marker as a real and imaginary pair.
- Choose **R+jX MKR** to show the real and imaginary parts of the device impedance at the marker. Also shown is the equivalent series inductance or capacitance (the series resistance and reactance, in ohms).

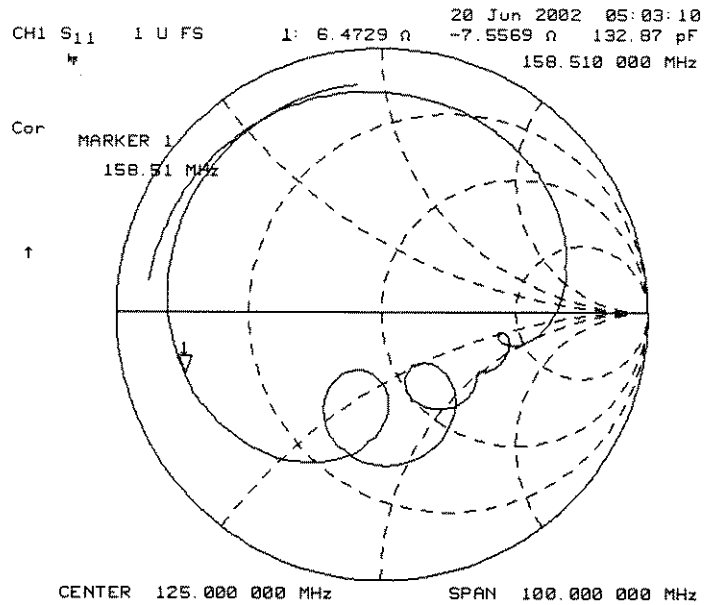
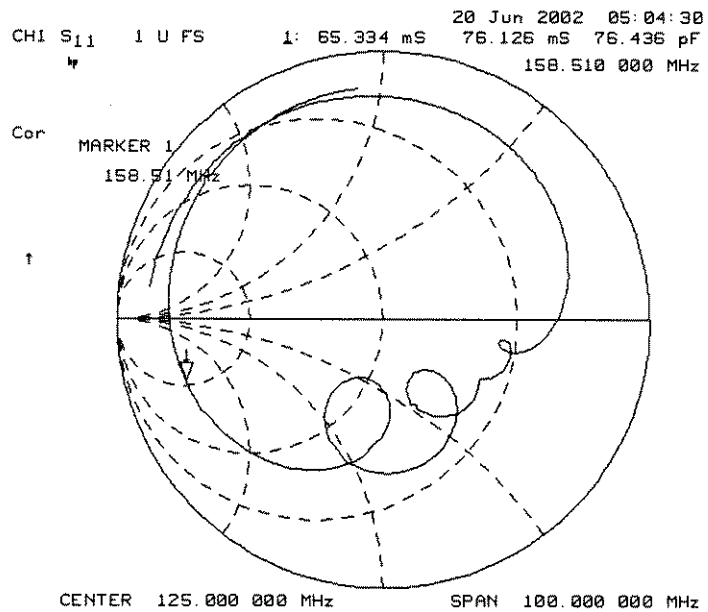

**Figure 2-15. Example Impedance Measurement Trace**

**Measuring Admittance.**

To change the display to an inverse Smith chart graticule and the marker information to read admittance, press **G+jB MKR**.

As shown in Figure 2-16, the marker reads admittance data in the form  $G+jB$ , where  $G$  is conductance and  $B$  is susceptance, both measured in units of Siemens (equivalent to mhos: the inverse of ohms). Also shown is the equivalent parallel capacitance or inductance.



**Figure 2-16. Example Admittance Measurement Trace**



---

## If You Encounter a Problem

If you have difficulty when installing or using the HP 8753D Option 011, check the following list of commonly encountered problems and troubleshooting procedures. If the problem that you encounter is not in the following list, refer to additional sections entitled "If You Have Problems" in the *HP 8753D Option 011 Network Analyzer User's Guide*.

### Power-up problems

#### If the HP 8753D Option 011 display does not light:

- Check that the power cord is fully seated in both the main power receptacle and the analyzer power module.
- Check that the AC line voltage selector switch is in the appropriate position (230V/115V) for your available power supply.
- Check that the analyzer AC line fuse is not open.

---

**Warning** For continued protection against fire hazard, replace the fuse with the same type and rating.

---

Refer to Figure 2-17 to remove the fuse from the power module. You can use a continuity light or an ohmmeter to check the fuse. An ohmmeter should read very close to zero ohms if the fuse is good. The 3A, 250V fuse is HP part number 2110-0780.

- Contact the nearest Hewlett-Packard office for service, if necessary. A list of Hewlett-Packard sales and service offices is provided at the end of this guide.

---

**Warning** The power cord is connected to internal capacitors that may remain live for 10 seconds after you disconnect the cord from the power supply.

---

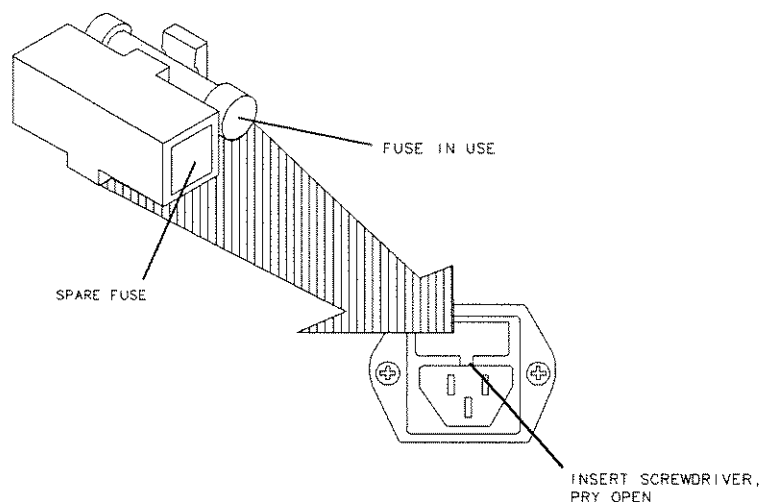





qg652d

**Figure 2-17. Line Fuse Removal and Replacement**

**If the display lights, but the ventilation fan does not start:**

- Check that the fan is not obstructed. To check the fan, follow these steps:
  1. Switch the LINE power to the off position.
  2. Check that the fan blades are not jammed.
- Contact the nearest Hewlett-Packard office for service, if necessary. A list of Hewlett-Packard sales and service offices is provided at the end of this guide.

**Data Entry Problems**

**If the data entry controls (keypad, knob, , , ,  keys) do not respond:**

- Check that the ENTRY OFF function is not enabled.

The ENTRY OFF function is enabled after you press the **ENTRY OFF** key. To return to normal entry mode, press any function key that has a numeric parameter associated with it. For example, **START**.
- Check that none of the keys are stuck.
- Check that the selected function key accepts data.

For example, **SCALE REF** accepts data, but **SYSTEM** does not.
- Check that the analyzer's "R" HP-IB STATUS light is not illuminated.

If the analyzer's "R" HP-IB STATUS light is illuminated, a test sequence may be running, or a connected computer controller may be sending commands or instructions to, or receiving data from, the analyzer. Press **LOCAL** if you want to return to LOCAL control.

**If the parameter you are trying to enter is not accepted by the analyzer:**

- Ensure that you are not attempting to set the parameter greater than or less than its limit. Refer to the *HP 8753D Option 011 Network Analyzer User's Guide* for the parameter limits.

**No RF Output**

**If there is no RF signal at either PORT 1 or PORT 2 connector:**

This procedure only applies if a test set is being used.

- Verify proper connection of the RF cables between the analyzer and the test, (especially RF OUT on the analyzer to RF IN on the test set, and R in on the analyzer to R out on the test set.
- Check that the signal at the test ports is switched on.
  - Press **MENU** **POWER** **POWER TRIP** on **OFF** until OFF appears on the **POWER TRIP** softkey label.
- If you are applying external modulation (AM) to the analyzer, check the external modulating signal or external gate/trigger signals for problems.

---

**Caution** If the error message:

CAUTION: OVERLOAD ON INPUT X, POWER REDUCED

appears on the HP 8753D Option 011 display, too much source power is being applied at the input. In such a case, the input power will need to be reduced before the source power will remain on.

---

- Look for phase-lock error messages and then contact your nearest Hewlett-Packard office for service. A list of Hewlett-Packard Sales and Service offices is provided at the end of this guide.
- 

**Note** The HP 8753D Option 011 must have a connection from the source output to the analyzer "R" input. The power at the "R" channel must be between 0 dBm and -30 dBm. If the "R" channel is not connected, a "NO IF FOUND" message will appear.

---

**Table 2-1. Hewlett-Packard Sales and Service Offices**

| US FIELD OPERATIONS  |  |   |
|--|--|---|
| <p><b>Headquarters</b><br/>Hewlett-Packard Company<br/>19320 Pruneridge Avenue<br/>Cupertino, CA 95014, USA<br/>(800) 752-0900</p>                           | <p><b>California, Northern</b><br/>Hewlett-Packard Co.<br/>301 E. Evelyn<br/>Mountain View, CA 94041<br/>(415) 694-2000</p>  | <p><b>California, Southern</b><br/>Hewlett-Packard Co.<br/>1421 South Manhattan Ave.<br/>Fullerton, CA 92631<br/>(714) 999-6700</p>                                     |
| <p><b>Colorado</b><br/>Hewlett-Packard Co.<br/>24 Inverness Place, East<br/>Englewood, CO 80112<br/>(303) 649-5000</p>                                       | <p><b>Georgia</b><br/>Hewlett-Packard Co.<br/>2000 South Park Place<br/>Atlanta, GA 30339<br/>(404) 955-1500</p>   | <p><b>Illinois</b><br/>Hewlett-Packard Co.<br/>5201 Tollview Drive<br/>Rolling Meadows, IL 60008<br/>(708) 255-9800</p>   |
| <p><b>New Jersey</b><br/>Hewlett-Packard Co.<br/>150 Green Pond Road<br/>Rockaway, NJ 07866<br/>(201)627-6400</p>  | <p><b>Texas</b><br/>Hewlett-Packard Co.<br/>930 E. Campbell Rd.<br/>Richardson, TX 75081<br/>(214) 231-6101</p>  |   |
| EUROPEAN FIELD OPERATIONS  |  |   |
| <p><b>Headquarters</b><br/>Hewlett-Packard S.A.<br/>150, Route du Nant-d'Avril<br/>1217 Meyrin 2/Geneva<br/>Switzerland<br/>(41 22) 780.8111</p>             | <p><b>France</b><br/>Hewlett-Packard France<br/>1 Avenue Du Canada<br/>Zone D'Activite De Courtaboeuf<br/>F-91947 Les Ulis Cedex<br/>France<br/>(33 1) 69 82 60 60</p> | <p><b>Germany</b><br/>Hewlett-Packard GmbH<br/>Hewlett-Packard Strasse<br/>6380 Bad Homburg v.d.H<br/>Germany<br/>(49 6172) 16-0</p>                                    |
| <p><b>Great Britain</b><br/>Hewlett-Packard Ltd<br/>Eskdale Road, Winnersh Triangle<br/>Wokingham, Berkshire RF11 5DZ<br/>England<br/>(44 734) 696622</p>    |  |   |
| INTERCON FIELD OPERATIONS  |  |   |
| <p><b>Headquarters</b><br/>Hewlett-Packard Company<br/>3495 Deer Creek Rd.<br/>Palo Alto, California 94304-1316<br/>(415) 857-5027</p>                       | <p><b>Australia</b><br/>Hewlett-Packard Australia Ltd.<br/>31-41 Joseph Street<br/>Blackburn, Victoria 3130<br/>(61 3) 895-2895</p>                                    | <p><b>Canada</b><br/>Hewlett-Packard (Canada) Ltd.<br/>17500 South Service Road<br/>Trans-Canada Highway<br/>Kirkland, Quebec H9J 2X8<br/>Canada<br/>(514) 697-4232</p> |
| <p><b>China</b><br/>China Hewlett-Packard Co.<br/>38 Bei San Huan X1 Road<br/>Shuang Yu Shu<br/>Hai Dian District<br/>Beijing, China<br/>(86 1) 256-6888</p> | <p><b>Japan</b><br/>Yokogawa-Hewlett-Packard Ltd.<br/>1-27-15 Yabe, Sagamihara<br/>Kanagawa 229, Japan<br/>(81 427) 59-1311</p>  | <p><b>Singapore</b><br/>Hewlett-Packard Singapore (Pte.) Ltd<br/>1150 Depot Road<br/>Singapore 0410<br/>(65) 273-7388</p>   |
| <p><b>Taiwan</b><br/>Hewlett-Packard Taiwan<br/>8th Floor, H-P Building<br/>337 Fu Hsing North Road<br/>Taipei, Taiwan<br/>(886 2) 712-0404</p>              |  |   |

# Index

---

## A

- analyzer configuration, 1-8–19
  - analyzers with option 1D5, 1-10
  - attaching cabinet flanges, 1-18
  - attaching cabinet flanges and handles, 1-19
  - attaching handles, 1-17
  - S-parameter test set, 1-9
  - T/R test set, 1-10
  - with cabinet flange kits, 1-16
  - with plotters, 1-11
  - with printers, 1-11

## C

- certification, iii
- clock, setting, 1-15
- contents of shipment, 1-2–3
  - accessories included, 1-2
  - adapters included, 1-2
  - cables included, 1-2
  - documentation included, 1-2
- correction constants, 1-26

## D

- definitions, 2-12
  - return loss (dB), 2-12
  - return loss ( $\Gamma$ ), 2-12
  - standing-wave-ratio (SWR), 2-12

## E

- EEPROM backup disk, 1-26
- electrical requirements, 1-6–7
- environmental requirements, 1-6–7

## F

- front- and rear-panel features, 1-4–5
- front panel, 1-4
- front-panel features, 2-2
  - channel keys, 2-2
  - display, 2-2
  - instrument state keys, 2-3
  - numeric keypad, 2-3
  - PRESET key, 2-3
  - response softkeys, 2-2
  - softkeys, 2-2
  - stimulus softkeys, 2-3

## I

- installation, 1-1

## M

- making measurements, 2-1–20
- manual conventions, v
- measurement procedure, 2-4
- measurement sequence
  - choosing measurement parameters, 2-4
  - making a measurement calibration, 2-4
  - measuring a device, 2-4
  - outputting measurement results, 2-4

## O

- operation, 1-20–25
  - checking reflection mode, 1-25
  - checking transmission mode, 1-24
  - installed options, 1-21
  - operator's check, 1-23
  - self-test, 1-22

## P

- plotter configuration, 1-11–14
- polar format, 2-18
- printer configuration, 1-11–14
- problems, data entry, 2-22
  - controls do not respond, 2-22
  - parameters not accepted, 2-22
- problems, power-up, 2-21–22
  - display does not light, 2-21
  - display lights, but fan does not start, 2-21
- problems, RF output, 2-22
  - no RF signal at either PORT 1 or PORT 2, 2-22

## R

- rear panel, 1-5
- reflection measurements, 2-12–20
  - admittance, 2-20
  - choosing the measurement parameters, 2-13
  - impedance, 2-19
  - making a measurement calibration, 2-13
  - measuring a device, 2-14
  - measuring return loss, 2-15

outputting measurement results, 2-15  
reflection coefficient, 2-16  
 $S_{11}$  and  $S_{22}$  in polar format, 2-18  
standing wave ratio, 2-17  
regulatory information, iii

## **S**

safety considerations, general, iv  
safety notes, iv  
smith chart, 2-19  
static-safe workstation, 1-7

## **T**

transmission measurements, 2-5-11  
3 dB bandwidth, 2-8

choosing the measurement parameters,  
2-5

making a measurement calibration, 2-5  
measuring insertion loss with marker  
functions, 2-8

measuring the device, 2-7

out-of-band rejection, 2-9

outputting the measurement results, 2-7

passband flatness, 2-10

passband ripple, 2-10

troubleshooting, 2-21-23

## **W**

warranty, iii

## Free Manuals Download Website

<http://myh66.com>

<http://usermanuals.us>

<http://www.somanuals.com>

<http://www.4manuals.cc>

<http://www.manual-lib.com>

<http://www.404manual.com>

<http://www.luxmanual.com>

<http://aubethermostatmanual.com>

Golf course search by state

<http://golfingnear.com>

Email search by domain

<http://emailbydomain.com>

Auto manuals search

<http://auto.somanuals.com>

TV manuals search

<http://tv.somanuals.com>