

Maintenance & Service Guide

HP 500B and 505B Microtower Business PC

Compaq 500B and 505B Microtower Business PC

Compaq 510B and 515B Microtower Business PC

© Copyright 2009, 2010 Hewlett-Packard Development Company, L.P. The information contained herein is subject to change without notice.

Microsoft and Windows are trademarks of Microsoft Corporation in the U.S. and other countries.

The only warranties for HP products and services are set forth in the express warranty statements accompanying such products and services. Nothing herein should be construed as constituting an additional warranty. HP shall not be liable for technical or editorial errors or omissions contained herein.

This document contains proprietary information that is protected by copyright. No part of this document may be photocopied, reproduced, or translated to another language without the prior written consent of Hewlett-Packard Company.

HP 500B and 505B Microtower Business PC

Compaq 500B and 505B Microtower Business PC

Compaq 510B and 515B Microtower Business PC

Third Edition (August 2010)

Second Edition (May 2010)

First Edition (September 2009)

Document Part Number: 591882-003

About This Book



-  **WARNING!** Text set off in this manner indicates that failure to follow directions could result in bodily harm or loss of life.
 -  **CAUTION:** Text set off in this manner indicates that failure to follow directions could result in damage to equipment or loss of information.
 -  **NOTE:** Text set off in this manner provides important supplemental information.
-

Table of contents

1 Product Description	1
Chassis Designations	1
HP 500B/505B	1
Compaq 500B/505B, Compaq 510B/515B	2
Product Description	3
2 Removal and Replacement Procedures Microtower (MT) Chassis	4
Preparation for Disassembly	4
Access Panel	5
Front Bezel	7
Memory	9
DDR3-SDRAM DIMMs	9
Populating DIMM Sockets	10
Installing Memory Modules	11
Expansion Cards	13
Cable Management	21
Cable Connections	21
Drives	23
Installing Additional Drives	23
System Board Drive Connections	24
Removing an Optical Drive	25
Replacing an Optical Drive	27
Removing a Hard Drive	28
Replacing a Hard Drive	31
Front I/O and USB Panel Housing Assembly	33
Power Switch/LED Assembly	34
System Fan	35
Heat sink assembly (Intel) — Model 500B/510B	36
Heat sink assembly (AMD) — Model 505B/515B	37
Processor (Intel) — Model 500B/510B	38
Processor (AMD) — Model 505B/515B	40
Power Supply	41
System Board	47
Battery	48

Type 1 Battery Holder	49
Type 2 Battery Holder	50
Type 3 Battery Holder	50

Appendix A Computer (F10) Setup 52

Model 500B/510B — Computer Setup (F10) Utilities	52
Using Computer Setup (F10) Utilities	52
Computer Setup—Main	53
Computer Setup—Advanced	54
Computer Setup—Power	55
Computer Setup—Boot	57
Computer Setup—Exit	58
Model 505B/515B — Computer Setup (F10) Utilities	58
Using Computer Setup (F10) Utilities	59
Computer Setup—Main	59
Computer Setup—Advanced	60
Computer Setup—Power	61
Computer Setup—Boot	63
Computer Setup—Exit	64

Appendix B Diagnostics 65

Interpreting Diagnostic Beep Codes	65
LED Codes	66
Accessing HP Insight Diagnostics	67
Testing Memory Modules	67
POST Error/Warning Messages	68
Power Button/Power Button LED	69
Using the Setup Utility	69
BIOS Updates	70
Clearing CMOS	70

Appendix C Troubleshooting Without Diagnostics 72

Safety and Comfort	72
Before You Call for Technical Support	72
Helpful Hints	73
Solving General Problems	74
Solving Power Problems	75
Solving Hard Drive Problems	76
Solving Media Card Reader Problems	77
Solving Display Problems	78
Solving Audio Problems	79
Solving Keyboard and Mouse Problems	79
Solving Network Problems	80

Solving Memory Problems	81
Solving CD-ROM and DVD Problems	82
Solving Front Panel Component Problems	83
Appendix D Connector Pin Assignments	84
4-Pin Power (for CPU)	84
Ethernet BNC	84
USB	84
Microphone	85
Headphone	85
Line-in Audio	85
Line-out Audio	85
Monitor	86
24-Pin Power	86
PCI Express	87
PCI Express	88
Appendix E Routine Care and Disassembly Preparation	90
Electrostatic Discharge Information	90
Generating Static	90
Preventing Electrostatic Damage to Equipment	91
Personal Grounding Methods and Equipment	91
Grounding the Work Area	92
Recommended Materials and Equipment	92
Operating Guidelines	93
Routine Care	94
General Cleaning Safety Precautions	94
Cleaning the Computer Case	94
Cleaning the Keyboard	94
Cleaning the Monitor	95
Cleaning the Mouse	95
Service Considerations	95
Power Supply Fan	95
Tools and Software Requirements	96
Screws	96
Cables and Connectors	96
Hard Drives	96
Lithium Coin Cell Battery	97
Appendix F Serial ATA (SATA) Drive Guidelines and Features	98
SATA Hard Drives	98
SATA Hard Drive Cables	98
SATA Data Cable	98

SMART ATA Drives	99
Hard Drive Capacities	99
Appendix G Power Cord Set Requirements	100
General Requirements	100
Japanese Power Cord Requirements	100
Country-Specific Requirements	101
Appendix H Specifications	102
Index	104

1 Product Description

Chassis Designations

The following subsection illustrates the various chassis designs.

HP 500B/505B

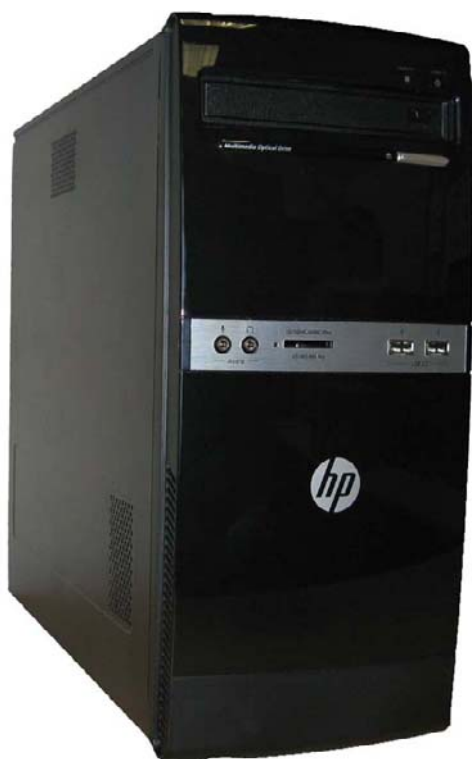

 **NOTE:** Card reader not included on all models.

Compaq 500B/505B, Compaq 510B/515B



Product Description

HP 500B, Compaq 500B, and Compaq 510B are based on Intel PCA and processor technology, whereas the Compaq 505B MT, Compaq 505B, and Compaq 515B are based on AMD technology. The following list provides notable features of the PCs.

HP 500B, Compaq 500B, and Compaq 510B features:

- Intel Core 2 Duo processors
- Intel G41/ICH7 Express chipset
- Intel GMA X4500 integrated graphics controller

Compaq 505B, Compaq 505B/515B features:

- AMD AM3 Athlon II and Phenom II processors
- nVidia MCP61P
- nVidia GeForce 6150SE integrated graphics controller

Both PCs feature:

- Support for up to 4GB of DDR3 SDRAM in two dual-channel DIMM slots
- One PCI-E x16, two PCI-E x1, one PCI expansion slot
- 300W passive Power Factor Correction (PFC) and non-PFC power supply
- Six USB 2.0 ports
- Realtek 10/100 Mbps Ethernet controller
- Integrated 5.1 channel audio
- Support for HP Kensington MicroSaver cable lock
- Windows 7 logo compliance

2 Removal and Replacement Procedures Microtower (MT) Chassis

Adherence to the procedures and precautions described in this chapter is essential for proper service. After completing all necessary removal and replacement procedures, run the Diagnostics utility to verify that all components operate properly.

 **NOTE:** Not all features listed in this guide are available on all computers.

Preparation for Disassembly

1. Close any open software applications.
2. Exit the operating system.
3. Remove any media from the computer.
4. Turn off the computer and any peripheral devices that are connected to it.

△ **CAUTION:** Turn off the computer before disconnecting any cables.

CAUTION: Regardless of the power-on state, voltage is always present on the system board as long as the system is plugged into an active AC outlet. In some systems the cooling fan is on even when the computer is in the “Standby,” or “Suspend” modes. The power cord should always be disconnected before servicing a unit.

5. Disconnect the power cord from the electrical outlet and then from the computer.
6. Disconnect all peripheral device cables from the computer.

 **NOTE:** During disassembly, label each cable as you remove it, noting its position and routing. Keep all screws with the components removed.

△ **CAUTION:** The screws used in the computer are of different thread sizes and lengths; using the wrong screw in an component may damage the component or the computer.

Access Panel

 **NOTE:** Access panel appearance may vary.

1. Prepare the computer for disassembly ([Preparation for Disassembly on page 4](#)).
2. Remove the side cover by loosening the screw that connects the cover to the computer.

Figure 2-1 Removing the Computer Access Panel



3. Grasp the handle on the side cover and pull towards the back of the computer. Slide the cover about 2.4 cm (1 inch) to remove it.

 **NOTE:** You may want to lay the computer on its side to install internal parts. Be sure the side with the access panel is facing up.

Figure 2-2 Removing the Computer Access Panel



4. Remove the side panel by lifting it away from the computer.

Figure 2-3 Removing the Computer Access Panel



To replace the access panel, reverse the removal steps.

Front Bezel

 **NOTE:** Front bezel appearance may vary.

1. Prepare the computer for disassembly ([Preparation for Disassembly on page 4](#)).
2. Remove the access panel ([Access Panel on page 5](#)).
3. Pull each of the three side tabs that secure the front bezel to the computer, to release the front bezel.

Figure 2-4 Removing the Front Bezel



4. Swing the front bezel out to remove from the computer.

Figure 2-5 Removing the Front Bezel



 **NOTE:** The appearance of the front bezel may vary.

To reinstall the front bezel, reverse the removal procedure.

Memory

The computer comes with double data rate 3 synchronous dynamic random access memory (DDR3-SDRAM) dual inline memory modules (DIMMs).

DDR3-SDRAM DIMMs

The memory sockets on the system board can be populated with up to two industry-standard DIMMs. These memory sockets are populated with at least one preinstalled DIMM. To achieve the maximum memory support, you can populate the system board with up to 4 GB of memory configured in a high-performing dual channel mode.

For proper system operation, the DDR3-SDRAM DIMMs must be:

- industry-standard 240-pin
- unbuffered PC3-10600, 1333 MHz-compliant
- 1.5 volt DDR3-SDRAM DIMMs

The DDR3-SDRAM DIMMs must also:

- support CAS latency 9 DDR3 1333 Mhz (9-9-9 timing)
- contain the mandatory JEDEC SPD information

In addition, the computer supports:

- 512Mbit, 1Gbit, and 2Gbit non-ECC memory technologies
- single-sided and double-sided DIMMs
- DIMMs constructed with x8 and x16 DDR devices; DIMMs constructed with x4 SDRAM are not supported

 **NOTE:** The system will not operate properly if you install unsupported DIMMs.

Populating DIMM Sockets

There are two DIMM sockets on the system board.

Figure 2-6 DIMM Socket Locations — 500B/510B

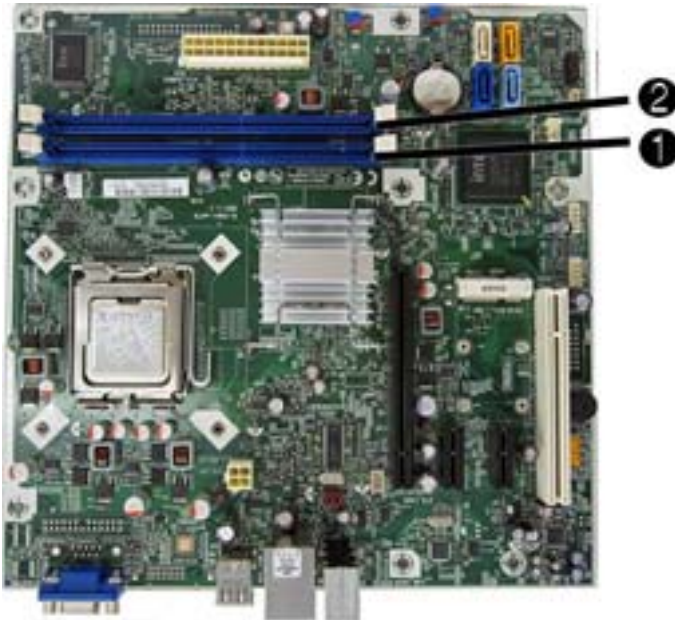

Figure 2-7 DIMM Socket Locations — 505B/515B

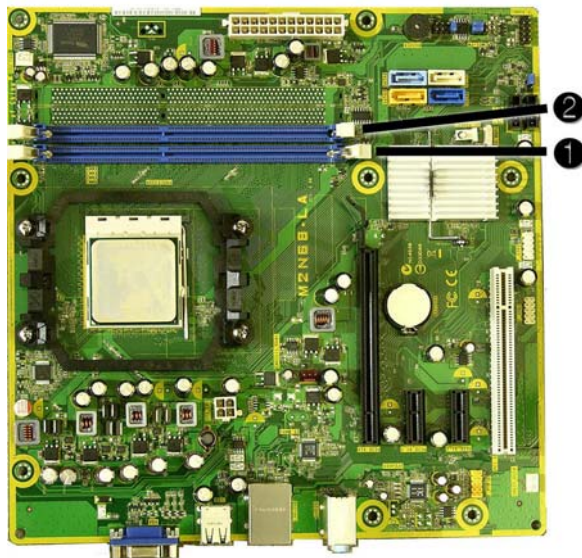

Table 2-1 DIMM Socket Locations

Item	Description	Socket Color
1	DIMM1 socket, Channel A (populate first)	Blue
2	DIMM2 socket, Channel A	Blue

NOTE: A DIMM must occupy the DIMM1 socket.

Installing Memory Modules

- △ **CAUTION:** You must disconnect the power cord and wait approximately 30 seconds for the power to drain before adding or removing memory modules. Regardless of the power-on state, voltage is always supplied to the memory modules as long as the computer is plugged into an active AC outlet. Adding or removing memory modules while voltage is present may cause irreparable damage to the memory modules or system board.

The memory module sockets have gold-plated metal contacts. When upgrading the memory, it is important to use memory modules with gold-plated metal contacts to prevent corrosion and/or oxidation resulting from having incompatible metals in contact with each other.

Static electricity can damage the electronic components of the computer or optional cards. Before beginning these procedures, ensure that you are discharged of static electricity by briefly touching a grounded metal object.

When handling a memory module, be careful not to touch any of the contacts. Doing so may damage the module.

1. Prepare the computer for disassembly ([Preparation for Disassembly on page 4](#)).
2. Remove the access panel ([Access Panel on page 5](#)).
3. Locate the memory module sockets on the system board (500B shown).

- △ **WARNING!** To reduce risk of personal injury from hot surfaces, allow the internal system components to cool before touching.

Figure 2-8 DIMM locations (500B shown)



4. Open both latches of the memory module socket (1), and insert the memory module into the socket (2).

Figure 2-9 Installing a DIMM

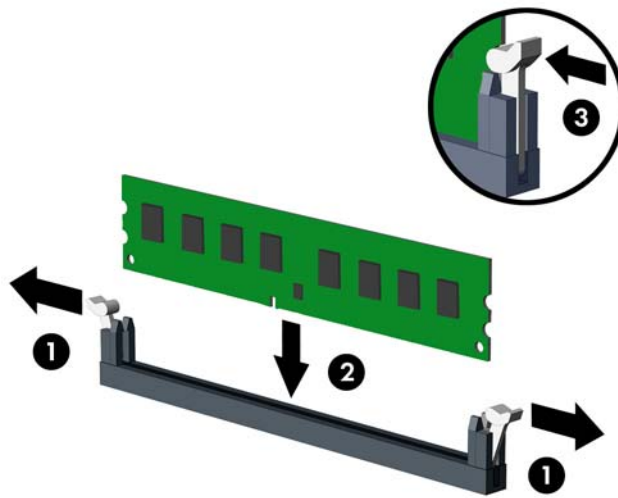

 **NOTE:** A memory module can be installed in only one way. Match the notch on the module with the tab on the memory socket.

5. Push the DIMM module down firmly into the socket, ensuring that the module is fully inserted and properly seated. The DIMM must be pushed all the way down into the socket and sit evenly in the socket to avoid memory corruption. Make sure the latches are in the closed position (3).
6. Repeat steps 4 and 5 to install any additional modules.
7. Replace the computer access panel.
8. Reconnect the power cord and any external devices, then turn on the computer. The computer should automatically recognize the additional memory when you turn on the computer.
9. Lock any security devices that were disengaged when the access panel was removed.

Expansion Cards

The computer has one PCI expansion slot, two PCI Express x1 expansion slots, and one PCI Express x16 expansion slot. The expansion slots accommodate full-height or half-height expansion cards.

Figure 2-10 Expansion Slot Locations — 500B/510B



Figure 2-11 Expansion Slot Locations — 505B/515B

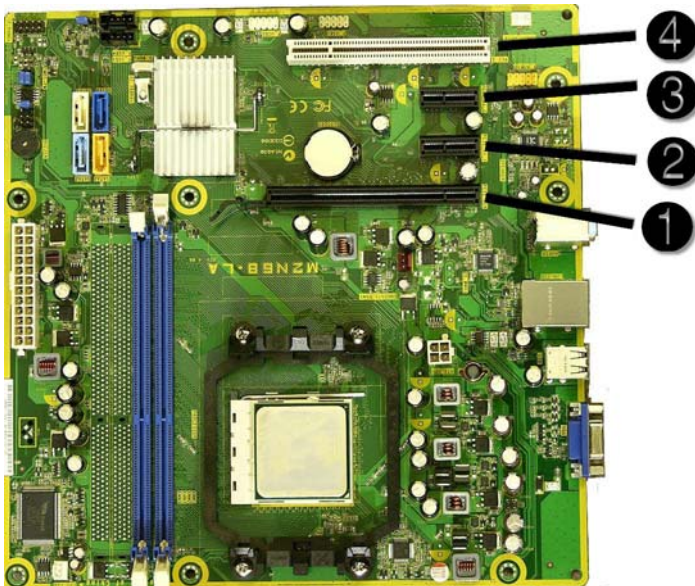



Table 2-2 Expansion Slot Locations

Item	Description
1	PCI Express x16 expansion slot

Table 2-2 Expansion Slot Locations (continued)

Item	Description
2	PCI Express x1 expansion slot
3	PCI Express x1 expansion slot
4	PCI expansion slot

 **NOTE:** You can install a PCI Express x1, x4, x8, or x16 expansion card in the PCI Express x16 expansion slot.

To remove, replace, or add an expansion card:

1. Prepare the computer for disassembly ([Preparation for Disassembly on page 4](#)).
2. Remove the access panel ([Access Panel on page 5](#)).
3. Locate the add-in cards at the back of the computer.

Figure 2-12 Locating the expansion card slots



4. On the back of the computer, remove the screw from the bracket cover for the add-in cards.

Figure 2-13 Opening the slot cover lock



5. Remove the bracket cover.

Figure 2-14 Removing the bracket cover

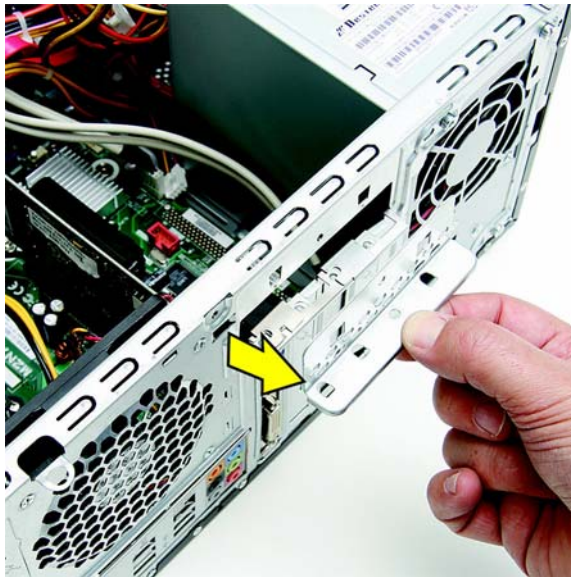

6. If you are removing a graphics card, press on the latch to release it.

Figure 2-15 Press the latch to release the graphics card

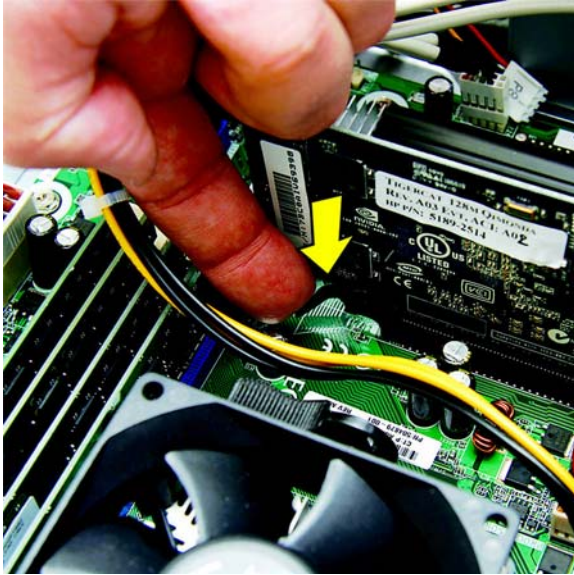

7. Remove the graphics card from the card slot.

 **NOTE:** If you are removing a PCI Express x16 card, pull the retention arm on the back of the expansion socket away from the card and carefully rock the card back and forth until the connectors pull free from the socket. Be sure not to scrape the card against the other components.

Figure 2-16 Removing the graphics card from the slot



8. For other add-in cards, move the card back and forth gently to free it from the card slot in the computer.

Figure 2-17 Rocking the card to Remove

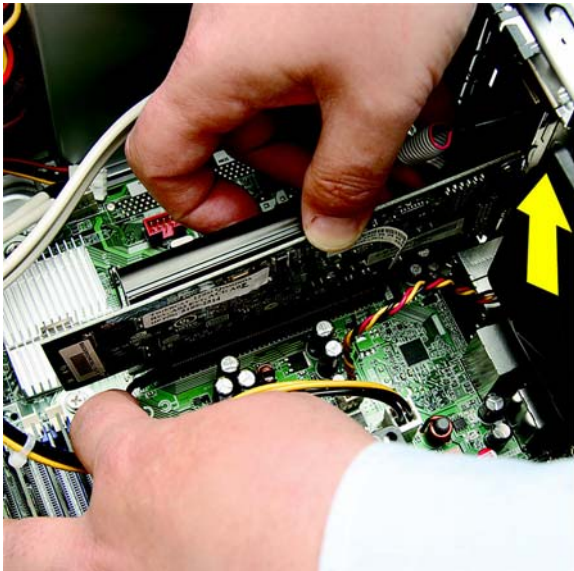

9. Lift the card out of the computer.

Figure 2-18 Lifting the card from the computer



10. If present, remove any cables connected to the add-in card.

Figure 2-19 Removing cables from the card

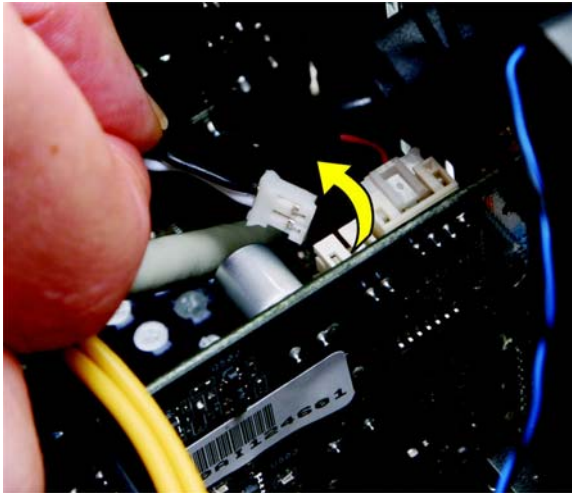

11. Store the removed card in anti-static packaging.
12. If you are not installing a new expansion card, install an expansion slot cover to close the open slot.

△ **CAUTION:** After removing an expansion card, you must replace it with a new card or expansion slot cover for proper cooling of internal components during operation.

13. To install a new expansion card, hold the card just above the expansion socket on the system board then move the card toward the rear of the chassis so that the bottom of the bracket on the card slides into the small slot on the chassis. Press the card straight down into the expansion socket on the system board.

Figure 2-20 Installing an expansion card

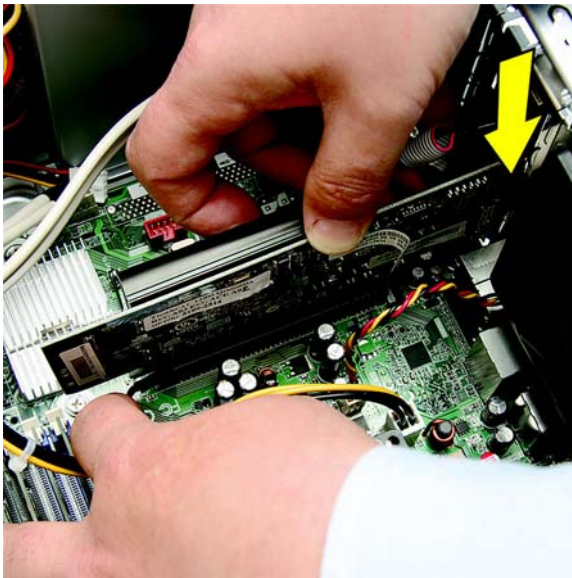

📄 **NOTE:** When installing an expansion card, press firmly on the card so that the whole connector seats properly in the expansion card slot.

14. If you are replacing a graphics card, verify that the latch in the computer snaps back into place.

Figure 2-21 Replacing a graphics card



15. Press straight down until the card is fully seated in the card slot.

Figure 2-22 Seating the card

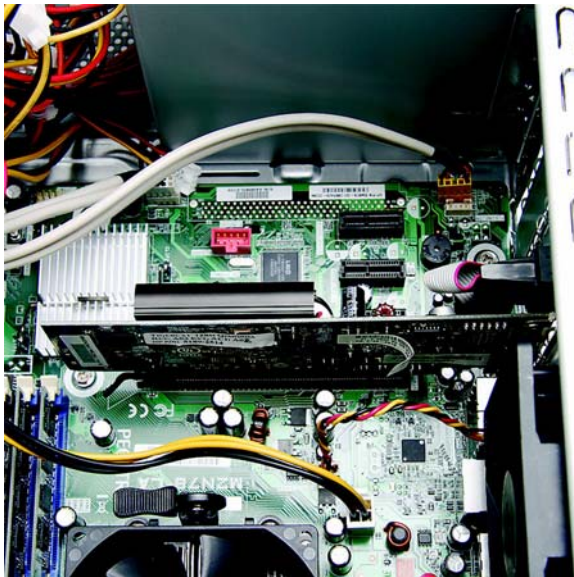

16. Replace the bracket cover on the back of the computer.

Figure 2-23 Replacing the bracket cover

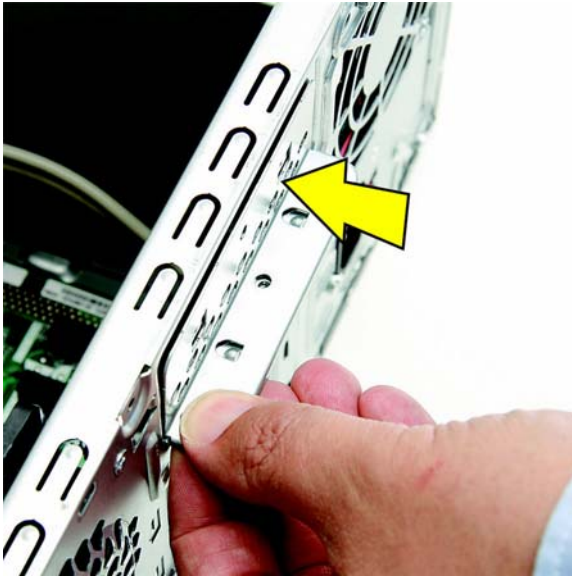

17. Replace the screw to secure the bracket to the back of the computer.

Figure 2-24 Replacing the bracket screw



18. Connect external cables to the installed card, if needed. Connect internal cables to the system board, if needed.
19. Reconfigure the computer, if necessary. Refer to the *Computer Setup (F10) Utility Guide* for instructions on using Computer Setup.

Cable Management

Always follow good cable management practices when working inside the computer.

- Keep cables away from major heat sources like the heatsink.
- Do not jam cables on top of expansion cards or memory modules. Printed circuit cards like these are not designed to take excessive pressure on them.
- Some flat ribbon cables come prefolded. Never change the folds on these cables.
- Never bend a SATA data cable tighter than a 30 mm (1.18 in) radius.
- Never crease a SATA data cable.
- Do not rely on components like the drive cage, power supply, or computer cover to push cables down into the chassis. Always position the cables to lay properly by themselves.

When removing the power supply power cable from the connector on the system board, always follow these steps:

1. Squeeze on the top of the retaining latch attached to the cable end of the connector **(1)**.
2. Grasp the cable end of the connector and pull it straight up **(2)**.

△ **CAUTION:** Always pull the connector - NEVER pull on the cable. Pulling on the cable could damage the cable and result in a failed power supply.

Cable Connections

System board connectors are color-coded to make it easier to find the proper connection.

Table 2-3 Cable connections — 500B/510B

Connector Name	Connector Color	Description
ATX_POWER	white	power supply, 24-pin
ATX_12V	white	power supply, 4-pin
SYS_FAN1	brown	chassis fan
CPU_FAN	white	heat sink fan
F_PANEL	black	front power button/LED
F_USB1	white	front I/O USB cable
F_AUDIO	yellow	front I/O audio
SATA1	dark blue	hard drive
SATA2	white	optical drive
PCI2	white	PCI expansion slot
PCIE1X	black	PCIe x1 expansion slot

Table 2-3 Cable connections — 500B/510B (continued)

Connector Name	Connector Color	Description
PCIE1X1	black	PCIe x1 expansion slot
PCIE16X	black	PCIe x16 expansion slot

Table 2-4 Cable connections — 505B/515B

Connector Name	Connector Color	Description
ATXPOWER	white	power supply, 24-pin
ATXCPU	white	power supply, 4-pin
CHASSIS_FAN1	brown	chassis fan
CPU FAN	white	heat sink fan
F_PANEL	black	front power button/LED
F_USB2	white	front I/O USB cable
F_AUDIO	yellow	front I/O audio
SATA0	dark blue	hard drive
SATA1	white	optical drive
PCI1	white	PCI expansion slot
PCIE_X1_1	black	PCIe x1 expansion slot
PCIE_X1_2	black	PCIe x1 expansion slot
PCIE X16	black	PCIe x16 expansion slot

Drives

The computer supports one optical drive and one hard drive.

This section describes the procedure for replacing or upgrading the drives. A Torx T-15 screwdriver is needed to remove and install the guide screws on a drive.

Installing Additional Drives

When installing additional drives, follow these guidelines:

- Connect the primary SATA hard drive to the dark blue primary SATA connector on the system board labeled SATA1 for model 500B/510B, SATA0 for model 505B/515B.
- Connect the SATA optical drive to the white SATA connector on the system board labeled SATA2 on model 500B/510B, SATA1 for model 505B/515B.

△ **CAUTION:** To prevent loss of work and damage to the computer or drive:

If you are inserting or removing a drive, shut down the operating system properly, turn off the computer, and unplug the power cord. Do not remove a drive while the computer is on or in standby mode.

Before handling a drive, ensure that you are discharged of static electricity. While handling a drive, avoid touching the connector.

Handle a drive carefully; do not drop it.

Do not use excessive force when inserting a drive.

Avoid exposing a hard drive to liquids, temperature extremes, or products that have magnetic fields such as monitors or speakers.

If a drive must be mailed, place the drive in a bubble-pack mailer or other protective packaging and label the package "Fragile: Handle With Care."

System Board Drive Connections

Refer to the following illustration and table to identify the system board drive connectors.

Figure 2-25 System Board Drive Connections — 500B/510B



Figure 2-26 System Board Drive Connections — 505B/515B

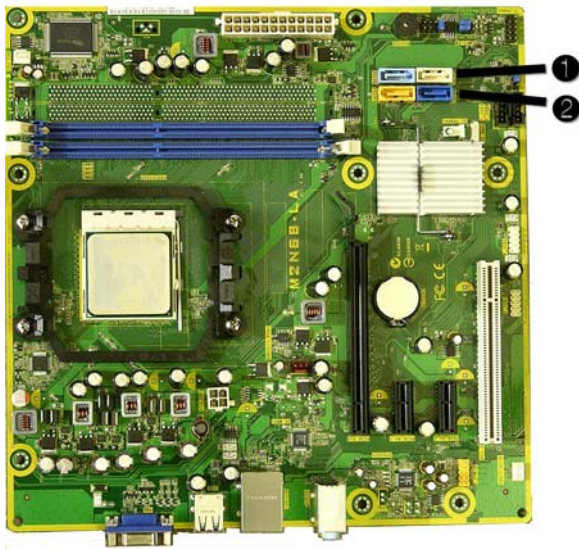

Table 2-5 System Board Drive Connections

No.	System Board Label — 500B/510B	System Board Label — 505B/515B	Color
1	SATA1	SATA0	dark blue
2	SATA2	SATA1	white

Removing an Optical Drive

- △ **CAUTION:** All removable media should be taken out of a drive before removing the drive from the computer.

To remove an optical drive:

1. Prepare the computer for disassembly ([Preparation for Disassembly on page 4](#)).
2. Remove the access panel ([Access Panel on page 5](#)).
3. Remove the front bezel ([Front Bezel on page 7](#)).
4. Disconnect the power cable (1) and data cable (2) from the rear of the optical drive.

Figure 2-27 Disconnecting the power and data cables

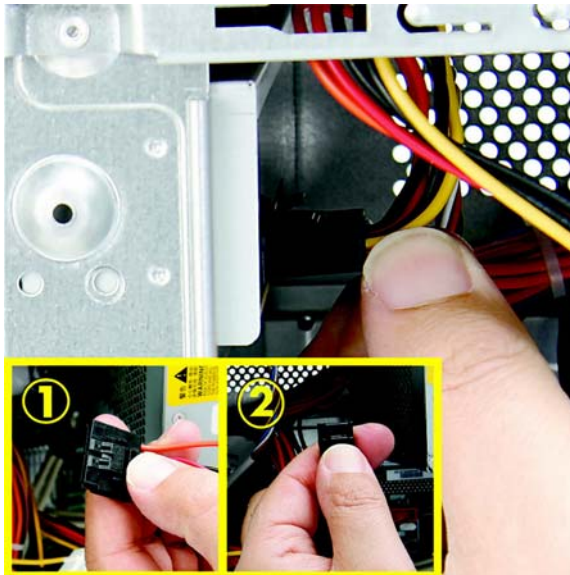

5. Remove the screws that fasten the disc drive in the computer.

Figure 2-28 Removing the optical drive screws



6. Push the drive slightly forward.

Figure 2-29 Push the drive forward



7. Pull the disc drive out through the front of the computer.

Figure 2-30 Pull the drive from the computer



 **NOTE:** To install an optical drive, refer to [Replacing an Optical Drive on page 27](#).

Replacing an Optical Drive

To install an optical drive:

1. Prepare the computer for disassembly ([Preparation for Disassembly on page 4](#)).
2. Remove the access panel ([Access Panel on page 5](#)).
3. Remove the front bezel ([Front Bezel on page 7](#)).
4. If the new drive has screws installed on the sides of the drive, remove the screws before inserting the drive into the chassis.
5. Push the replacement disc drive partially into the drive bay in the computer.

Figure 2-31 Installing the optical drive

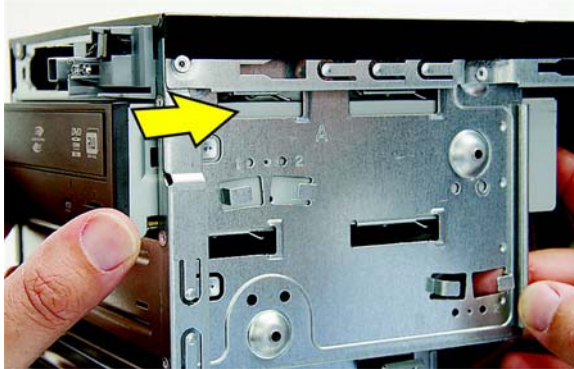

6. Connect the power cable (1) and data cable (2) to the rear of the optical drive.

Figure 2-32 Connecting the power and data cables



7. Align the disc drive screw holes with the drive bay holes (marked "2").

Figure 2-33 Aligning the holes

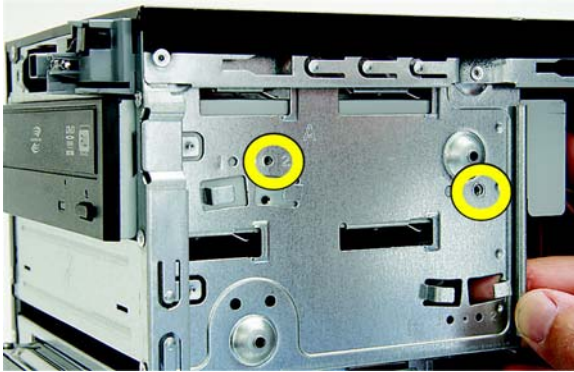

8. Replace the drive screws.

Figure 2-34 Replacing the screws

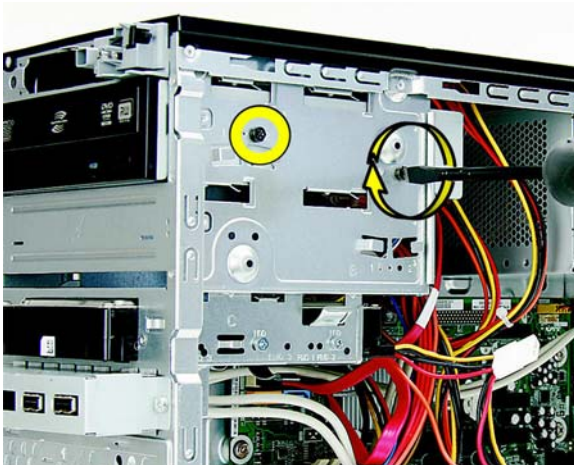

9. Replace the front bezel, access panel, and reconnect all cables.
10. Lock any security devices that were disengaged when the access panel was removed.

The system automatically recognizes the drive and reconfigures the computer.

Removing a Hard Drive

 **NOTE:** Before you remove the old hard drive, be sure to back up the data from the old hard drive so that you can transfer the data to the new hard drive. Also, if you are replacing the primary hard drive, make sure you have created a Recovery Disc Set to restore the operating system, software drivers, and any software applications that were preinstalled on the computer. If you do not have this CD set, select **Start > HP Backup and Recovery** and create it now.

1. Prepare the computer for disassembly ([Preparation for Disassembly on page 4](#)).
2. Remove the access panel ([Access Panel on page 5](#)).
3. Remove the front bezel ([Front Bezel on page 7](#)).

4. Locate the external drive bay at the front of the computer, below the optical drive bays.

Figure 2-35 Locating the hard drive



5. Disconnect the power (1) and data (2) cables by squeezing the latch on the connector and pulling to remove.

Figure 2-36 Disconnecting the hard drive cables

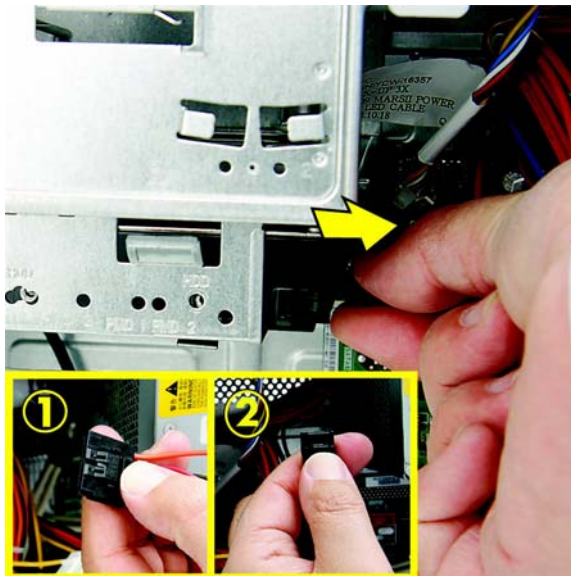

6. Remove the two screws that secure the hard disk drive to the computer.

Figure 2-37 Removing the hard drive screws

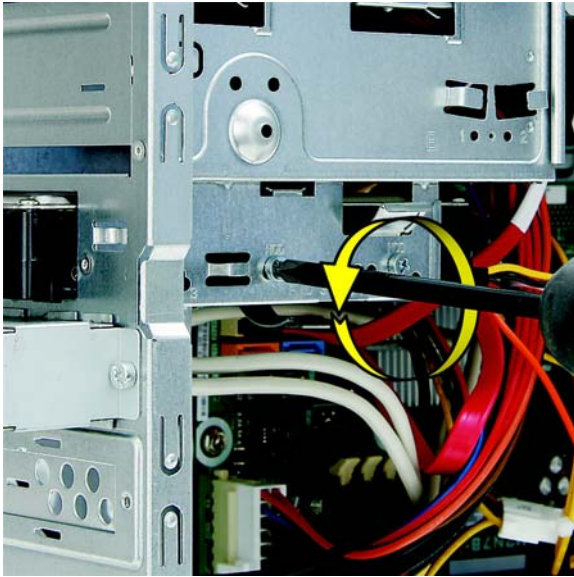

7. Pull the hard drive out of the front of the computer.

Figure 2-38 Pulling the hard drive from the computer

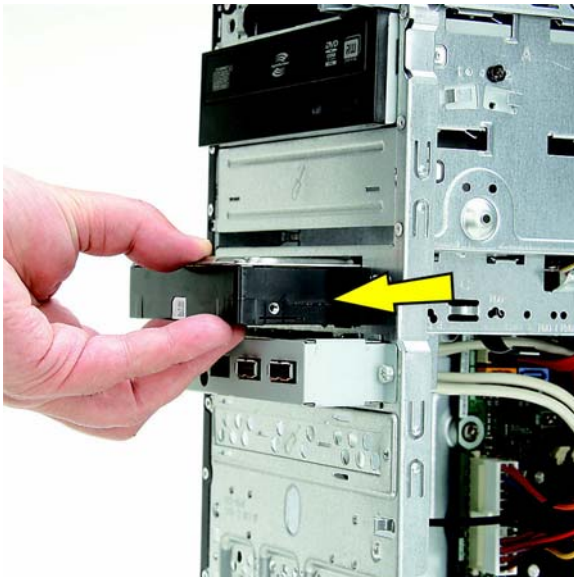

 **NOTE:** To install a hard drive, refer to [Replacing a Hard Drive on page 31](#).

Replacing a Hard Drive

1. Follow the steps in [Removing a Hard Drive on page 28](#) to remove the hard drive.
2. Slide the replacement hard disk drive into the bay.

 **NOTE:** If you are replacing an old drive with a new drive, use the four retainer screws from the old drive to install the new drive.

Figure 2-39 Installing the hard drive



3. Align the screw holes on the side of the hard drive with the holes marked “HDD” on the bay.

Figure 2-40 Align the screw holes

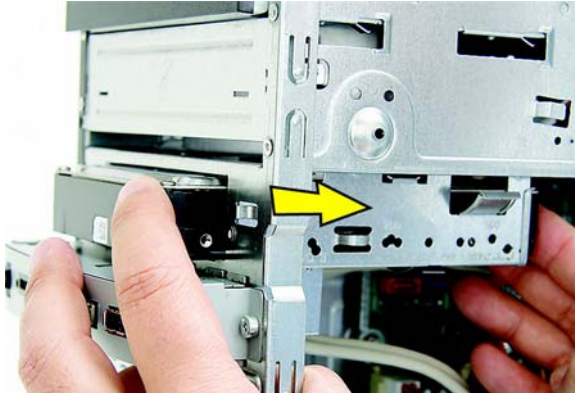
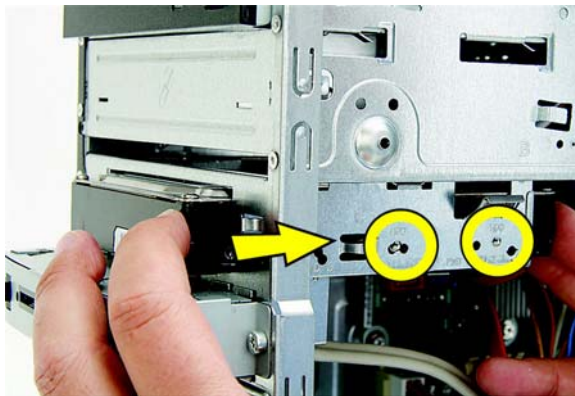

 **CAUTION:** Never crease or bend a SATA data cable tighter than a 30 mm (1.18 in) radius. A sharp bend can break the internal wires.

4. Attach the two screws to secure the hard disk drive to the bay.

Figure 2-41 Replacing the screws that secure the hard drive

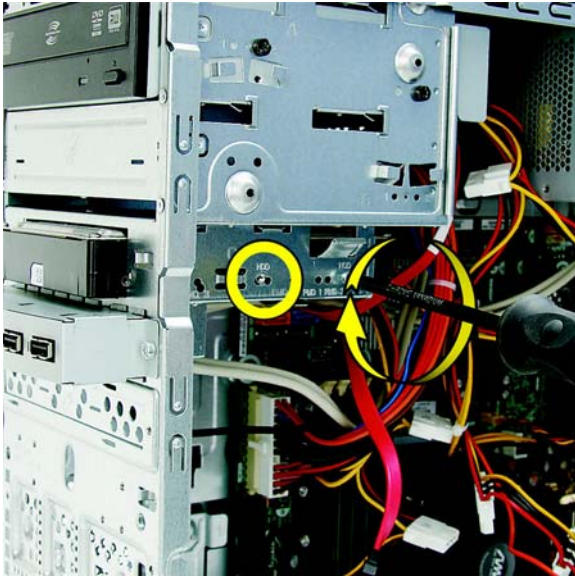

5. Attach the power and data connectors to the back of the drive.

Figure 2-42 Attaching the connectors



6. Replace the front bezel, computer access panel, and all cables.
7. Lock any security devices that were disengaged when the access panel was removed.

Front I/O and USB Panel Housing Assembly

1. Prepare the computer for disassembly ([Preparation for Disassembly on page 4](#)).
2. Remove the access panel ([Access Panel on page 5](#))
3. Lay the computer on its side with the front facing toward you.
4. Remove the front bezel ([Front Bezel on page 7](#)).
5. Unplug the four cables that connect the assembly to the system board.
6. Remove the screw **(1)** that secures the housing to the chassis, slide the housing up **(2)**, and then pull the assembly away from the chassis while guiding the cables through the hole in the chassis.

Figure 2-43 Removing the front I/O assembly

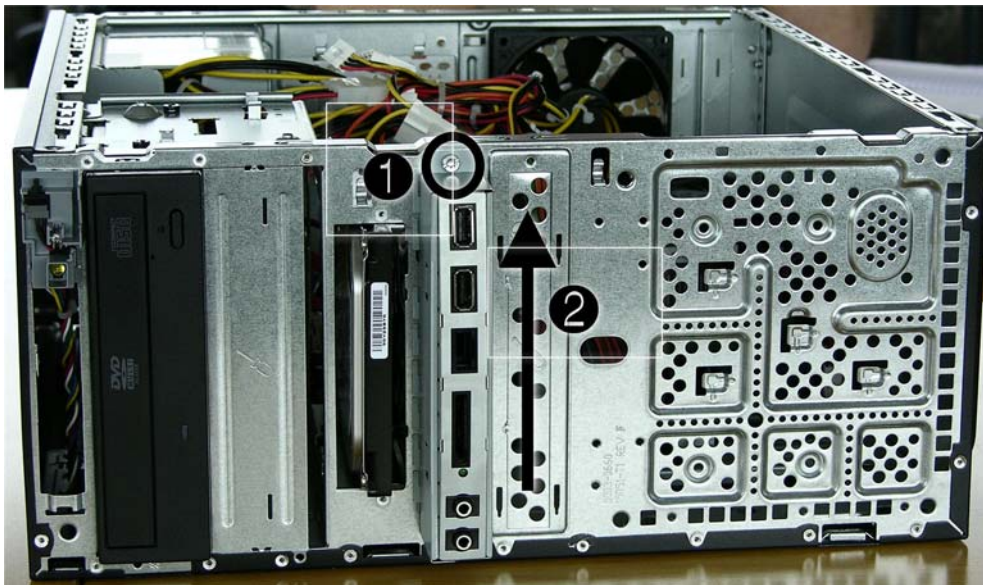

To install the housing assembly, reverse the removal procedures.

Power Switch/LED Assembly

1. Prepare the computer for disassembly ([Preparation for Disassembly on page 4](#)).
2. Remove the access panel ([Access Panel on page 5](#)).
3. Lay the computer on its side with the front facing toward you.
4. Remove the front bezel ([Front Bezel on page 7](#)).
5. Remove the optical drive ([Removing an Optical Drive on page 25](#)).
6. Disconnect the braided cables from the system board.
7. Remove the cable from the clips in the optical drive cage.
8. Press the tabs near the bottom on both sides of the switch holder (1) to disengage it from the chassis, rotate the bottom of the switch upward (2), and then pull it away from the chassis while guiding the wires through the hole in the chassis.

Figure 2-44 Removing the power switch

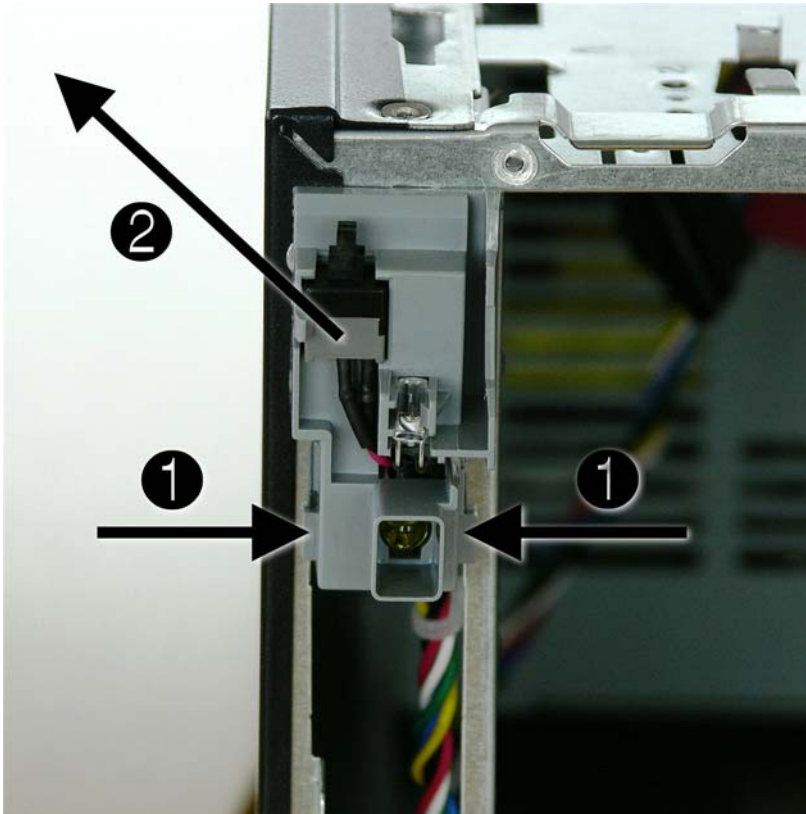

To install the power switch/LED assembly, reverse the removal procedures.

System Fan

1. Prepare the computer for disassembly ([Preparation for Disassembly on page 4](#)).
2. Remove the access panel ([Access Panel on page 5](#)).
3. Lay the computer on its side with the rear facing toward you.
4. Disconnect the cable that connects the system fan to the system board.
5. Remove the four Phillips screws that secure the fan to the chassis, rotate the top of the fan forward, and then remove the fan from the chassis.

Figure 2-45 Removing the system fan



To install the fan, reverse the removal procedures.

Heat sink assembly (Intel) — Model 500B/510B

 **NOTE:** Heat sink appearance may vary.

1. Prepare the computer for disassembly ([Preparation for Disassembly on page 4](#)).
2. Remove the access panel ([Access Panel on page 5](#)).
3. Lay the computer on its side with the rear facing toward you.
4. Disconnect the heat sink fan control cable from the system board (1).
5. Remove the four torx screws (2) that secure the heat sink to the system board.

Figure 2-46 Removing the heat sink

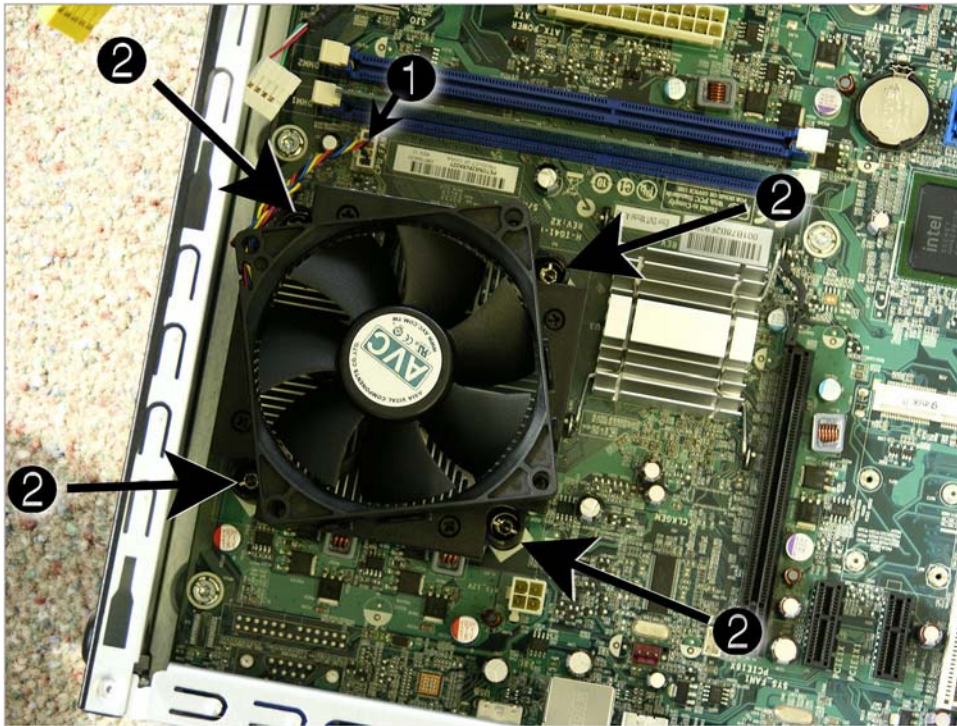

6. Lift the heat sink from the processor and set it on its side to keep from contaminating the work area with thermal grease.

 **CAUTION:** Heat sink retaining screws should be tightened in diagonally opposite pairs (as in an X) to evenly seat the heat sink to the processor. This is especially important as the pins on the socket are very fragile and any damage to them may require replacing the system board.

When reinstalling an existing heat sink, make sure that its bottom has been cleaned with an alcohol wipe and fresh thermal grease has been applied to the top of the processor. New heatsinks come from the factory with fresh thermal grease already applied.

Heat sink assembly (AMD) — Model 505B/515B

1. Prepare the computer for disassembly ([Preparation for Disassembly on page 4](#)).
2. Remove the access panel ([Access Panel on page 5](#)).
3. Lay the computer on its side with the rear facing toward you.
4. Disconnect the heat sink fan control cable from the system board.
5. Lift the lever (1) that secures the heat sink latch to the heat sink bracket attached to the system board.
6. After loosening the lever, press downward on the lever to release the square clip (2) from the tab on the heat sink bracket.
7. Use the lever to maneuver the square clip on the opposite side on the heat sink (3) free from the tab on the heat sink bracket.
8. Lift the heat sink from the processor and set it on its side to keep from contaminating the work area with thermal grease.

Figure 2-47 Removing the heat sink

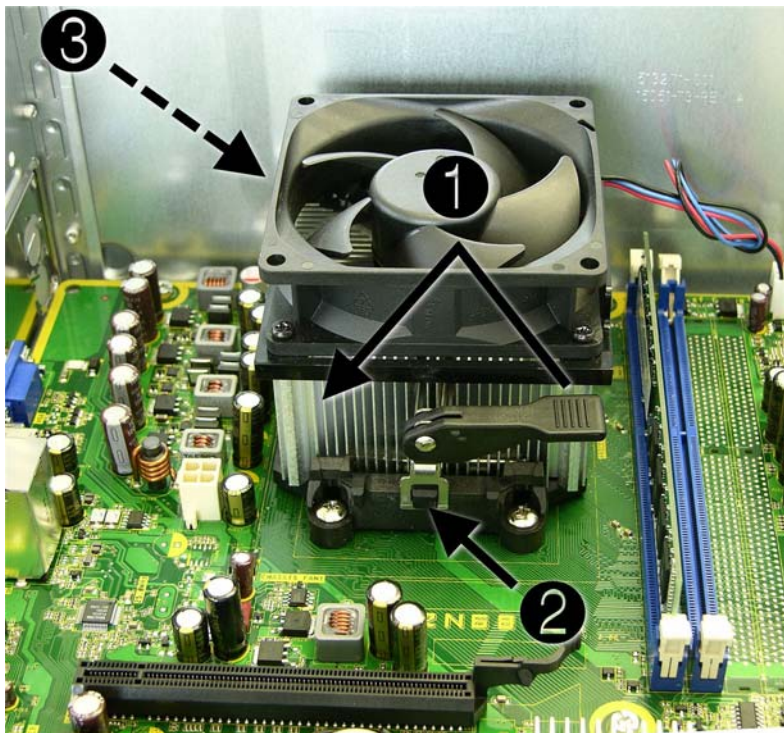

△ **CAUTION:** Heat sink retaining screws should be tightened in diagonally opposite pairs (as in an X) to evenly seat the heat sink to the processor. This is especially important as the pins on the socket are very fragile and any damage to them may require replacing the system board.

When reinstalling an existing heat sink, make sure that its bottom has been cleaned with an alcohol wipe and fresh thermal grease has been applied to the top of the processor. New heatsinks come from the factory with fresh thermal grease already applied.

Processor (Intel) — Model 500B/510B

1. Prepare the computer for disassembly ([Preparation for Disassembly on page 4](#)).
2. Remove the access panel ([Access Panel on page 5](#)).
3. Lay the computer on its side with the rear facing toward you.
4. Disconnect the heatsink control cable from the system board and remove the heatsink [Heat sink assembly \(Intel\) — Model 500B/510B on page 36](#)).
5. Rotate the locking lever to its full open position **(1)**.
6. Raise and rotate the microprocessor retainer to its full open position **(2)**
7. Carefully lift the processor from the socket **(3)**.

△ **CAUTION:** Do NOT handle the pins in the processor socket. These pins are very fragile and handling them could cause irreparable damage. Once pins are damaged it may be necessary to replace the system board.

CAUTION: The heatsink must be installed within 24 hours of installing the processor to prevent damage to the processor's solder connections.

Figure 2-48 Removing an Intel processor

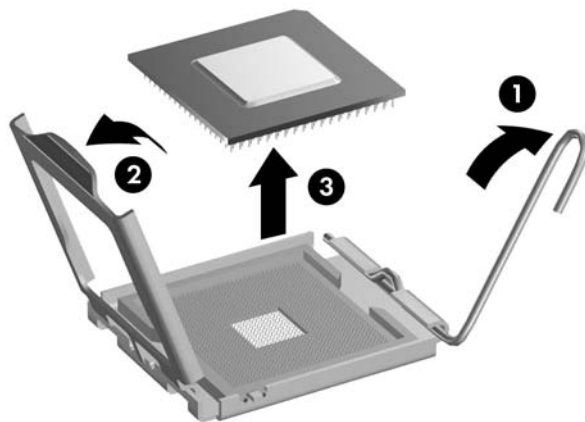

To install a new processor:

1. Place the processor in its socket and close the retainer.
2. Secure the locking lever.

If reusing the existing heat sink, go to step 3.

If using a new heat sink, go to step 6.

3. If reusing the existing heat sink, clean the bottom of the heat sink with the alcohol pad provided in the spares kit.

4. Apply the thermal grease provided in the spares kit to the top of the processor and install the heat sink atop the processor.
5. Go to step 7.
6. If using a new heat sink, remove the protective covering from the bottom of the heat sink and place it in position atop the processor.
7. Secure the heat sink to the system board and system board tray with the 4 captive screws and attach the heat sink control cable to the system board.

△ **CAUTION:** Heat sink retaining screws should be tightened in diagonally opposite pairs (as in an X) to evenly seat the heat sink on the processor. This is especially important as the pins on the socket are very fragile and any damage to them may require replacing the system board.

📄 **NOTE:** After installing a new processor onto the system board, always update the system ROM to ensure that the latest version of the BIOS is being used on the computer. The latest system ROM BIOS can be found on the Web at: <http://h18000.www1.hp.com/support/files>.

Processor (AMD) — Model 505B/515B

1. Prepare the computer for disassembly ([Preparation for Disassembly on page 4](#)).
2. Remove the access panel ([Access Panel on page 5](#)).
3. Disconnect the heatsink control cable from the system board and remove the heatsink [Heat sink assembly \(AMD\) — Model 505B/515B on page 37](#)).
4. Rotate the locking lever to its full open position **(1)**.
5. Carefully lift the processor from the socket **(2)**.

△ **CAUTION:** Do NOT handle the pins in the processor socket. These pins are very fragile and handling them could cause irreparable damage. Once pins are damaged it may be necessary to replace the system board.

The heat sink must be installed within 24 hours of installing the processor to prevent damage to the processor's solder connections.

Figure 2-49 Removing an AMD processor

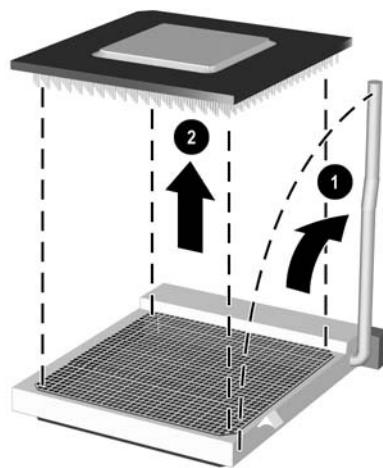

To install a new processor:

1. Place the processor in its socket and close the retainer.
2. Secure the locking lever.

If reusing the existing heat sink, go to step 3.

If using a new heat sink, go to step 5.

3. If reusing the existing heat sink, apply the thermal grease provided in the spares kit to the top of the processor.
4. Clean the bottom of the heat sink with the provided alcohol pad and place it atop the processor.

5. If using a new heat sink, remove the protective covering from the bottom of the heat sink and place it in position atop the processor.
6. Secure the heat sink to the system board and system board tray with the four captive screws and attach the heat sink control cable to the system board.

△ **CAUTION:** heat sink retaining screws should be tightened in diagonally opposite pairs (as in an X) to evenly seat the heat sink on the processor. This is especially important as the pins on the socket are very fragile and any damage to them may require replacing the system board.

 **NOTE:** After installing a new processor onto the system board, always update the system ROM to ensure that the latest version of the BIOS is being used on the computer. The latest system BIOS can be found on the Web at: <http://h18000.www1.hp.com/support/files>.

Power Supply

 **NOTE:** Power supply appearance may vary.

△ **WARNING!** Voltage is always present on the system board when the computer is plugged into an active AC outlet. To avoid possible personal injury and damage to the equipment the power cord should be disconnected from the computer and/or the AC outlet before opening the computer.

 **NOTE:** When installing a new power supply, be sure to set the red switch to the setting (230 V or 115 V) appropriate for the country in which the computer is used. Spare power supplies normally arrive set for 230 V.

1. Prepare the computer for disassembly ([Preparation for Disassembly on page 4](#)).
2. Remove the access panel ([Access Panel on page 5](#)).
3. Lay the computer on its side with the rear facing toward you.
4. Disconnect all power cables from the mass storage devices and from the system board.
5. Place the computer on its side.

6. Locate the power supply at the top of the computer.

Figure 2-50 Locating the power supply



NOTE: Noting the location, type and orientation of the power connectors is extremely important. Failure to correctly restore all power connectors appropriately will prevent the computer or components from working successfully.

NOTE: The location of the power connectors on the motherboard may vary from the ones shown below.

7. Trace the power supply cables to the system components:
 - Optical disc drives (**A**)
 - Hard disk drives (**B**)
 - Motherboard main power (**C**)
 - Motherboard fan (**D**)

Figure 2-51 Power supply connections

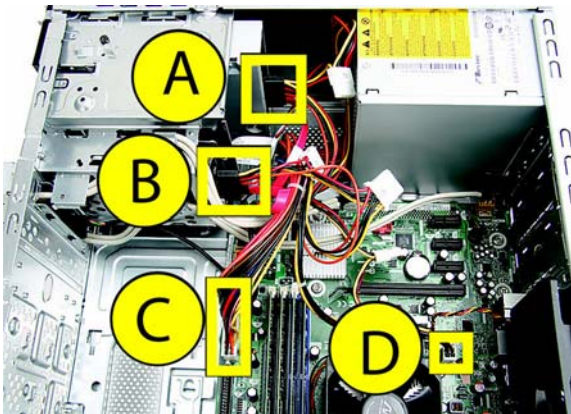

8. Disconnect the power cable from the optical disc and hard disk drives by squeezing the latch (1) on the connectors and pulling to remove.

Figure 2-52 Disconnecting the power cable

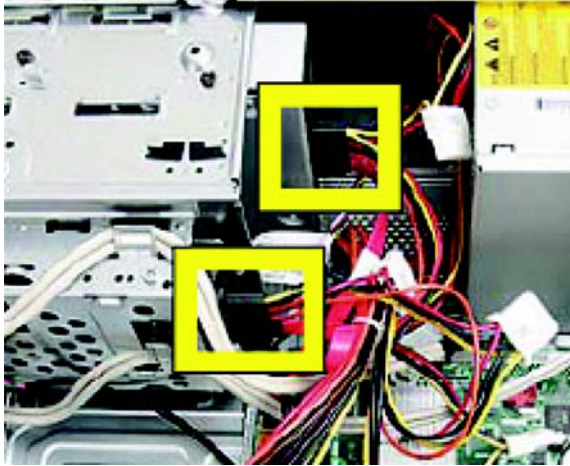

9. The motherboard power connector has a latch that must be pressed to detach the connector from the motherboard.

Figure 2-53 Disconnecting the main system board power connector

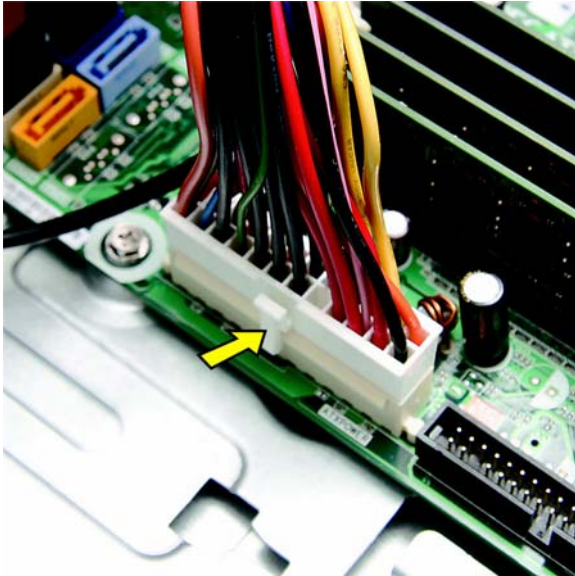

Some connectors may have latches that must be pressed to remove them.

Figure 2-54 Connector Latches

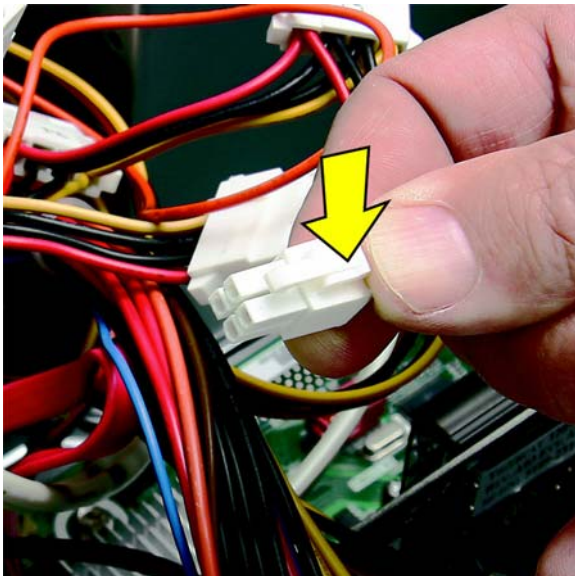

10. Disconnect all other power connectors from the motherboard.

Figure 2-55 Disconnecting power connectors

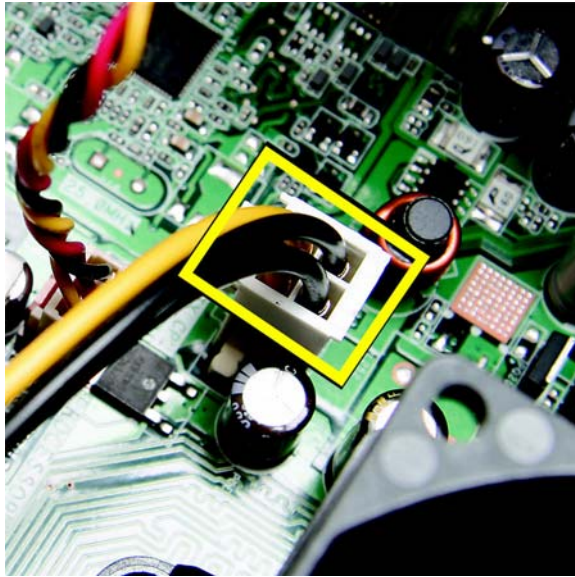

11. Remove the four screws that connect the power supply to the computer. The images below illustrate possible power supply screw locations.

Figure 2-56 Removing the power supply screws

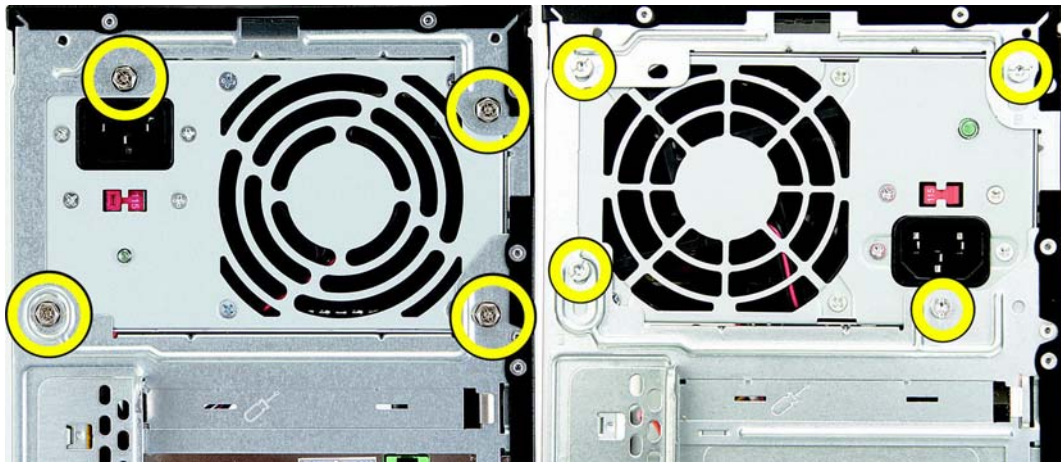

12. Use a screwdriver to press the latch at the bottom of the power supply to release it.

Figure 2-57 Pressing the power supply latch



13. Pull the power supply back and tilt it out of the computer.

Figure 2-58 Removing the power supply from the computer



To install the power supply, reverse the removal procedure. Note that there is a latch, a guide, and a ledge on the computer that help secure the power supply.

Figure 2-59 Power supply securing features

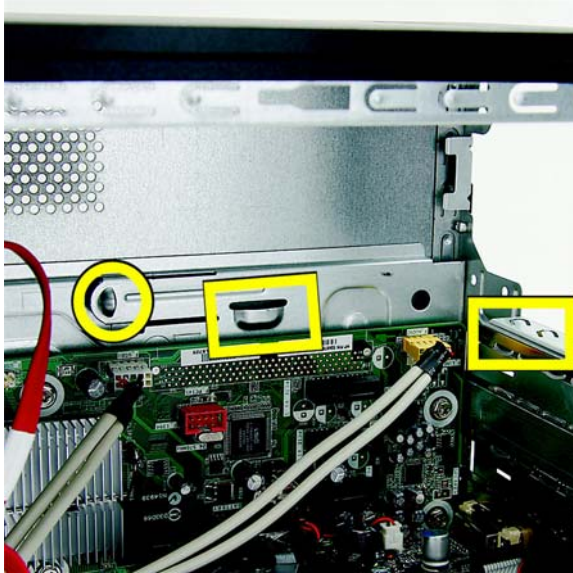

System Board

When replacing the system board, be sure that the following components are removed from the defective system board and installed on the replacement system board:

- Memory modules
- Processor
- Expansion modules

To remove the system board:

1. Prepare the computer for disassembly ([Preparation for Disassembly on page 4](#)).
2. Remove the access panel ([Access Panel on page 5](#)).
3. Lay the computer on its side with the rear facing toward you.
4. Remove the front bezel ([Front Bezel on page 7](#)).
5. Remove an expansion cards ([Expansion Cards on page 13](#)).
6. Disconnect the power, and data cables from the back of all installed drives.
7. Disconnect all cables from the system board.
8. Remove the eight screws that secure the system board to the chassis.

- Slide the system board toward the front of the chassis, and then lift it up and out of the chassis.



 **NOTE:** The system board in the computer may look slightly different from the one shown here.

Figure 2-60 Removing the system board — model 500B shown



To install the system board, reverse the removal procedure.

 **NOTE:** When replacing the system board, you must also change the chassis serial number in the BIOS.

NOTE: After installing a new system board, always update the system ROM to ensure that the latest version of the BIOS is being used on the computer. The latest system ROM BIOS can be found at: <http://h18000.www1.hp.com/support/files>.

Battery

The battery that comes with your computer provides power to the real-time clock and has a lifetime of about three years. When replacing the battery, use a battery equivalent to the battery originally installed on the computer. The computer comes with a 3-volt lithium coin cell battery.

 **NOTE:** The lifetime of the lithium battery can be extended by plugging the computer into a live AC wall socket. The lithium battery is only used when the computer is NOT connected to AC power.

⚠ **WARNING!** This computer contains an internal lithium manganese dioxide battery. There is a risk of fire and burns if the battery is not handled properly. To reduce the risk of personal injury:

- Do not attempt to recharge the battery.
- Do not expose to temperatures higher than 60°C (140°F)
- Do not disassemble, crush, puncture, short external contacts, or dispose of in fire or water.
- Replace the battery only with the HP/Compaq spare designated for this product.

⚠ **CAUTION:** Before replacing the battery, it is important to back up the computer CMOS settings. When the battery is removed or replaced, the CMOS settings will be cleared. Refer to the *Troubleshooting Guide* for information on backing up the CMOS settings.

📄 **NOTE:** Batteries, battery packs, and accumulators should not be disposed of together with the general household waste. In order to forward them to recycling or proper disposal, please use the public collection system or return them to HP, its authorized partners, or its agents.

⚠ **CAUTION:** Static electricity can damage the electronic components of the computer or optional equipment. Before beginning these procedures, ensure that you are discharged of static electricity by briefly touching a grounded metal object.

1. Prepare the computer for disassembly ([Preparation for Disassembly on page 4](#)).
2. Remove the access panel ([Access Panel on page 5](#)).

📄 **NOTE:** It may be necessary to remove an expansion card to gain access to the battery.

3. Locate the battery and battery holder on the system board.

Type 1 Battery Holder

1. Lift the battery out of its holder.

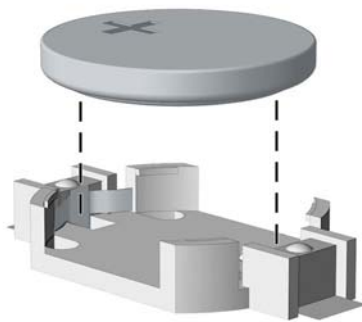

2. Slide the replacement battery into position, positive side up.
3. The battery holder automatically secures the battery in the proper position.
4. Replace the computer access panel.

5. Plug in the computer and turn on power to the computer.
6. Reset the date and time, your passwords, and any special system setups, using Computer Setup. Refer to the *Computer Setup (F10) Utility Guide*.

Type 2 Battery Holder

1. To release the battery from its holder, squeeze the metal clamp that extends above one edge of the battery. When the battery pops up, lift it out (1).
2. To insert the new battery, slide one edge of the replacement battery under the holder's lip with the positive side up (2). Push the other edge down until the clamp snaps over the other edge of the battery.

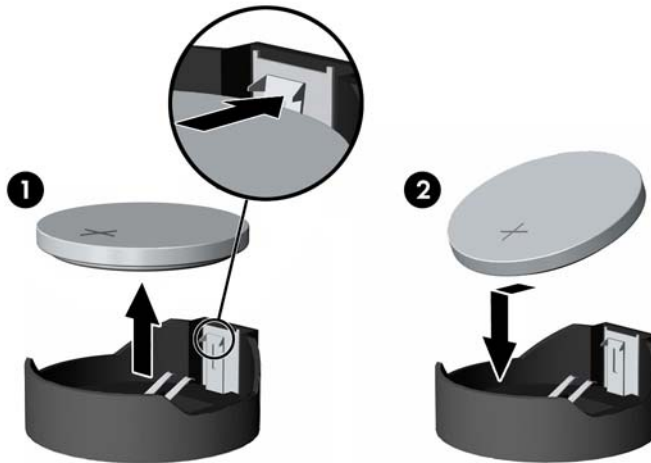

3. Replace the computer access panel.
4. Plug in the computer and turn on power to the computer.
5. Reset the date and time, your passwords, and any special system setups, using Computer Setup. Refer to the *Computer Setup (F10) Utility Guide*.

Type 3 Battery Holder

1. Pull back on the clip (1) that holds the battery in place, then remove the battery (2).

2. Insert the new battery and position the clip back in place.

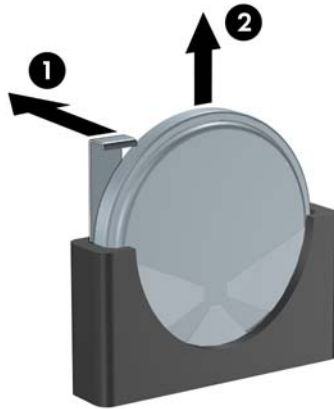

3. Replace the computer access panel.
4. Plug in the computer and turn on power to the computer.
5. Reset the date and time, your passwords, and any special system setups, using Computer Setup. Refer to the *Computer Setup (F10) Utility Guide*.

A Computer (F10) Setup

Model 500B/510B — Computer Setup (F10) Utilities

Use Computer Setup (F10) Utility to do the following:

- Change factory default settings.
- Set the system date and time.
- Set, view, change, or verify the system configuration, including settings for graphics, audio, storage, communications, and input devices.
- View settings for processor and memory.
- Modify the boot order of bootable devices such as hard drives, diskette drives, optical drives, or USB flash media devices.
- Restrict a device from booting the unit.
- Run hard drive self-tests.
- Establish a supervisor password that controls access to Computer Setup (F10) Utility and the settings described in this section.
- Enable or disable removable media boot ability.

Using Computer Setup (F10) Utilities

Computer Setup can be accessed only by turning the computer on or restarting the system. To access the Computer Setup Utilities menu, complete the following steps:

1. Turn on or restart the computer.
2. As soon as the computer is turned on, press **F10** when the monitor light turns green to enter Computer Setup.

 **NOTE:** If you do not press **F10** at the appropriate time, you must restart the computer and again press **F10** when the monitor light turns green to access the utility.

3. The Computer Setup Utility screen is divided into menu headings and actions.

Five menu headings appear on the Computer Setup Utility screen:

- Main
- Advanced
- Power
- Boot
- Exit

Use the arrow keys to select the appropriate heading, then press **Enter**. Use the arrow (up and down) keys to select the option you want, then press **Enter**. To return to the previous screen, press **Esc**.

△ **CAUTION:** Do NOT turn the computer power OFF while the ROM is saving the Computer Setup (F10) changes because the CMOS could become corrupted. It is safe to turn off the computer only after exiting the F10 Setup screen.

Computer Setup—Main

 **NOTE:** Support for specific Computer Setup options may vary depending on the hardware configuration.

Table A-1 Computer Setup—Main

Option	Description
System Time	Allows you to set system time.
System Date	Allows you to set system date.
Language	Allows you to select language.
Floppy Diskette A:	Allows you to set drive A to: <ul style="list-style-type: none">• Disabled• 1.44 MB 3.5"• Not Installed

Table A-1 Computer Setup—Main (continued)

1st Drive	For each, allows you to:
2nd Drive	<ul style="list-style-type: none">• Port Configuration - set the ability to configure ports to:
3rd Drive	<ul style="list-style-type: none">◦ Enabled
4th Drive	<ul style="list-style-type: none">◦ Disabled
	<ul style="list-style-type: none">• (view only)<ul style="list-style-type: none">◦ Capacity (Size - HDD only)◦ Transfer Mode• Smart Support - run HDD self-test for selected channel:<ul style="list-style-type: none">◦ SMART Status Check◦ SMART Short Self-Test◦ SMART Extended Self-Test
System Information	(view only) <ul style="list-style-type: none">• Installed Memory• Memory Bank 1• Memory Bank 2• BIOS Revision• Core Version• Model Number• Serial Number• Product Number• Asset Tag

Computer Setup—Advanced

 **NOTE:** Support for specific Computer Setup options may vary depending on the hardware configuration.

 **WARNING!** Setting items on this menu to incorrect values may cause your system to malfunction.

Table A-2 Computer Setup—Advanced

Option	Description
CPU Type	(view only)
CPU Speed	(view only)
Cache RAM	(view only)

Table A-2 Computer Setup—Advanced (continued)

Primary Video Adapter	Allows you to select the boot display device when more than 2 video options are offered by the system: <ul style="list-style-type: none">• PCI• PCI-Ex16
Onboard Video Memory Size	<ul style="list-style-type: none">• 32 MB• 64 MB• 128 MB
SATA Controller	Allows you to disable/enable the SATA Controller.
USB Ports	Allows you to disable/enable the USB ports.
Onboard LAN	Allows you to disable/enable onboard LAN controller.
Onboard LAN Boot ROM	Allows you to disable/enable the boot ROM of the onboard LAN chip.
Supervisor Password	Shows whether the supervisor password is enabled or disabled (view only).
User Password	Shows whether the user password is enabled or disabled (view only).
Change Supervisor Password	Allows you to change the supervisor password.
Onboard Audio	Allows you to set the onboard audio to: <ul style="list-style-type: none">• Auto• Disabled• Enabled
Microphone Input	Allows you to set disable/enable microphone input.

Computer Setup—Power

 **NOTE:** Support for specific Computer Setup options may vary depending on the hardware configuration.

Table A-3 Computer Setup—Power

Option	Description
After AC Power Failure	Allows you to select system restart behavior after power loss: <ul style="list-style-type: none">• Stay Off• Power On• Auto

Table A-3 Computer Setup—Power (continued)

XD	Disables/enables XD (eXecute Disable) bit. NOTE: The XD bit is a technology used in to separate areas of memory for use by either storage of processor instructions or code or for storage of data. Memory designated with the NX attribute may only be used for storing data. Processor instructions should not reside and cannot be executed there. This technology is used to prevent buffer overflow attacks – malicious software that takes over computers by inserting code into another program's data storage area and running that code.
S5 Maximum Power Savings	Disables/enables the S5 power setting. Enabling this setting enables the EuP Lot6 power specification of 1 Watt in S5 mode. This setting disable various system board components to reduce power consumption.

Computer Setup—Boot

 **NOTE:** Support for specific Computer Setup options may vary depending on the hardware configuration.

Table A-4 Computer Setup—Boot

Option	Description
Boot-time Diagnostic Screen	Disables/enables POST diagnostic messages display.
ESC: Boot Menu	Enables/disables the ability to press the Esc key to access the boot menu during boot.
F9: Diagnostics	Enables/disables the ability to press the F9 key to access the Diagnostics menu during boot.
F10: Setup	Enables/disables the ability to press the F10 key to access the Setup menu during boot.
F11: Recovery	Enables/disables the ability to press the F11 key to access the recovery menu during boot.
F12: Boot from LAN	Enables/disables the ability to press the F12 key to boot from LAN.
Boot Device Priority	<p>Allows you to specify which device groups will boot first, second, third, and fourth or to disable any of the four:</p> <ul style="list-style-type: none">• 1st Boot Device• 2nd Boot Device• 3rd Boot Device• 4th Boot Device <p>Options for each boot device include:</p> <ul style="list-style-type: none">• CD-ROM Group• Hard Drive Group• Floppy Group• Network Boot Group <p>NOTE: MS-DOS drive lettering assignments may not apply after a non-MS-DOS operating system has started.</p>
CD-ROM Group Boot Priority	Specifies boot device priority within CD/DVD drives.
Hard Drive Group Boot Priority	Specifies boot device priority within hard drives.
Floppy Group Boot Priority	Specifies boot device priority within removable devices.
Network Group Boot Priority	Specifies boot device priority within bootable network devices.

Computer Setup—Exit

 **NOTE:** Support for specific Computer Setup options may vary depending on the hardware configuration.

Table A-5 Computer Setup—Exit

Option	Description
Exit Saving Changes	Press Enter to exit saving changes.
Exit Discarding Changes	Press Enter to exit discarding changes.
Load Setup Defaults	Press Enter to load setup defaults.
Discard Changes	Press Enter to discard changes.
Save Changes	Press Enter to save changes.

Model 505B/515B — Computer Setup (F10) Utilities

Use Computer Setup (F10) Utility to do the following:

- Change factory default settings.
- Set the system date and time.
- Set, view, change, or verify the system configuration, including settings for graphics, audio, storage, communications, and input devices.
- View settings for processor and memory.
- Modify the boot order of bootable devices such as hard drives, diskette drives, optical drives, or USB flash media devices.
- Restrict a device from booting the unit.
- Run hard drive self-tests.
- Establish a supervisor password that controls access to Computer Setup (F10) Utility and the settings described in this section.
- Enable or disable removable media boot ability.

Using Computer Setup (F10) Utilities

Computer Setup can be accessed only by turning the computer on or restarting the system. To access the Computer Setup Utilities menu, complete the following steps:

1. Turn on or restart the computer.
2. As soon as the computer is turned on, press **F10** when the monitor light turns green to enter Computer Setup.

 **NOTE:** If you do not press **F10** at the appropriate time, you must restart the computer and again press **F10** when the monitor light turns green to access the utility.

3. The Computer Setup Utility screen is divided into menu headings and actions.

Five menu headings appear on the Computer Setup Utility screen:

- Main
- Advanced
- Power
- Boot
- Exit

Use the arrow keys to select the appropriate heading, then press **Enter**. Use the arrow (up and down) keys to select the option you want, then press **Enter**. To return to the previous screen, press **Esc**.

 **CAUTION:** Do NOT turn the computer power OFF while the ROM is saving the Computer Setup (F10) changes because the CMOS could become corrupted. It is safe to turn off the computer only after exiting the F10 Setup screen.

Computer Setup—Main

 **NOTE:** Support for specific Computer Setup options may vary depending on the hardware configuration.

Table A-6 Computer Setup—Main

Option	Description
System Time	Allows you to set system time.
System Date	Allows you to set system date.
Language	Allows you to select language.
Floppy Diskette A:	Allows you to set drive A to: <ul style="list-style-type: none">• Disabled• 1.44 MB 3.5"• Not Installed

Table A-6 Computer Setup—Main (continued)

1st Drive	For each, allows you to:
2nd Drive	<ul style="list-style-type: none">• Port Configuration - set the ability to configure ports to:
3rd Drive	<ul style="list-style-type: none">◦ Enabled
4th Drive	<ul style="list-style-type: none">◦ Disabled
	<ul style="list-style-type: none">• (view only)<ul style="list-style-type: none">◦ Capacity (Size - HDD only)◦ Transfer Mode• Smart Support - run HDD self-test for selected channel:<ul style="list-style-type: none">◦ SMART Status Check◦ SMART Short Self-Test◦ SMART Extended Self-Test
System Information	(view only) <ul style="list-style-type: none">• Installed Memory• Memory Bank 1• Memory Bank 2• BIOS Revision• Core Version• Model Number• Product Number• Asset Tag (press Enter to change)

Computer Setup—Advanced

 **NOTE:** Support for specific Computer Setup options may vary depending on the hardware configuration.

 **WARNING!** Setting items on this menu to incorrect values may cause your system to malfunction.

Table A-7 Computer Setup—Advanced

Option	Description
CPU Type	(view only)
CPU Speed	(view only)
Cache RAM (L2)	(view only)
Cache RAM (L3)	(view only)

Table A-7 Computer Setup—Advanced (continued)

Primary Video Adapter	Allows you to select the boot display device when more than 2 video options are offered by the system: <ul style="list-style-type: none"> • PCI • PCI-E x1 • PCI-E x16 • Onboard
Onboard LAN	Allows you to disable/enable onboard LAN controller.
Onboard LAN Boot ROM	Allows you to disable/enable the boot ROM of the onboard LAN chip.
Onboard Audio	Allows you to set the onboard audio to: <ul style="list-style-type: none"> • Auto • Disabled • Enabled
Supervisor Password	Shows whether the supervisor password is enabled or disabled (view only).
User Password	Allows you to change the user password.
USB Ports	Lists USB ports 1-10, what is connected to the port, and allows you to enable/disable each port.
Change Supervisor Password	Allows you to change supervisor password.

Computer Setup—Power

 **NOTE:** Support for specific Computer Setup options may vary depending on the hardware configuration.

Table A-8 Computer Setup—Power

Option	Description
After AC Power Failure	Allows you to select system restart behavior after power loss: <ul style="list-style-type: none"> • Auto • Power On • Stay Off
NX (No Execute)	Disables/enables NX bit.
Virtualization Technology	Allows you to enable/disable Virtualization Technology (VT). VT enables a CPU feature to run multiple simultaneous virtual machines allowing specialized software to run in full isolation of each other.

Table A-8 Computer Setup—Power (continued)

S5 Maximum Power Savings	Disables/enables the S5 power setting. Enabling this setting enables the EuP Lot6 power specification of 1 Watt in S5 mode. This setting disable various system board components to reduce power consumption.
WOL in S5	Allows you to view whether WOL is disabled or enabled in S5 (view only).

Computer Setup—Boot

 **NOTE:** Support for specific Computer Setup options may vary depending on the hardware configuration.

Table A-9 Computer Setup—Boot

Option	Description
Boot-time Diagnostic Screen	Disables/enables POST diagnostic messages display.
Boot Device Priority	<p>Allows you to specify which device groups will boot first, second, third, and fourth or to disable any of the four:</p> <ul style="list-style-type: none">• 1st Boot Device• 2nd Boot Device• 3rd Boot Device• 4th Boot Device <p>Options for each boot device include:</p> <ul style="list-style-type: none">• CD-ROM Group• Hard Drive Group• Floppy Group• Network Boot Group <p>NOTE: MS-DOS drive lettering assignments may not apply after a non-MS-DOS operating system has started.</p>
ESC: Boot Menu	Enables/disables the ability to press the Esc key to access the boot menu during boot.
F9: Diagnostics	Enables/disables the ability to press the F9 key to access the Diagnostics menu during boot.
F10: Setup	Enables/disables the ability to press the F10 key to access the Setup menu during boot.
F11: Recovery	Enables/disables the ability to press the F11 key to access the recovery menu during boot.
F12: Boot from LAN	Enables/disables the ability to press the F12 key to boot from LAN.
Floppy Group Boot Priority	Specifies boot device priority within removable devices.
CD-ROM Group Boot Priority	Specifies boot device priority within CD/DVD drives.
Hard Drive Group Boot Priority	Specifies boot device priority within hard drives.
Network Group Boot Priority	Specifies boot device priority within bootable network devices.

Computer Setup—Exit

 **NOTE:** Support for specific Computer Setup options may vary depending on the hardware configuration.

Table A-10 Computer Setup—Exit

Option	Description
Exit Saving Changes	Press Enter to exit saving changes.
Exit Discarding Changes	Press Enter to exit discarding changes.
Load Setup Defaults	Press Enter to load setup defaults.
Discard Changes	Press Enter to discard changes.
Save Changes	Press Enter to save changes.

B Diagnostics

Interpreting Diagnostic Beep Codes

The Power-On Self-Test (POST) is a series of diagnostic tests that runs automatically when the computer is powered on. If the POST detects an error, this causes an audible beep code to sound. The POST beep codes are not necessarily accompanied by an associated, visible error code or text message.

The following table shows the POST beep codes, their meanings, and the recommended actions for solving the problem.

⚠ WARNING! When the computer is plugged into an AC power source, voltage is always applied to the system board. To reduce the risk of personal injury from electrical shock and/or hot surfaces, be sure to disconnect the power cord from the wall outlet and allow the internal system components to cool before touching.

Table B-1 Diagnostic Beep Codes

Beeps	Diagnosis	Recommended action
1 short beep, 1 long beep, 3 second pause	Bad memory or memory configuration error.	Check that the memory modules have been installed correctly and that proper modules are used.
2 short beeps, 1 long beep, 3 second pause	No graphics card installed or graphics card initialization failed.	For systems with a graphics card: <ol style="list-style-type: none">1. Reseat the graphics card. Power on the system.2. Replace the graphics card.3. Replace the system board. For systems with integrated graphics, replace the system board.
3 short beeps, 1 long beep, 3 second pause	CPU configuration error or invalid CPU detected before graphics card initialized.	<ol style="list-style-type: none">1. Upgrade the BIOS to proper version.2. Change the processor.
1 short beep, 1 second pause	No legacy floppy drive or optical drive found	<ol style="list-style-type: none">1. Check cable connections.2. Run the Setup utility and ensure the device port is enabled.
2 short beeps, 3 second pause	No floppy diskette or CD found	<ol style="list-style-type: none">1. Check the type of drive you are using and use the correct media type.2. Replace the diskette or CD with a new one.

Table B-1 Diagnostic Beep Codes (continued)

Beeps	Diagnosis	Recommended action
3 short beeps, 3 second pause	Flashing not ready (missing utility or BIOS image file, etc.)	Upgrade the BIOS to proper version.
4 short beeps, 3 second pause	Flashing operation has failed (checksum error, corrupted image, etc.)	<ol style="list-style-type: none"> 1. Verify the correct ROM. 2. Flash the ROM if needed. 3. If an expansion board was recently added, remove it to see if the problem remains. 4. Clear CMOS. 5. If the message disappears, there may be a problem with the expansion card. 6. Replace the system board.
5 short beeps, 3 second pause	BIOS recovery was successful	No action required.

LED Codes

The following table describes the LED states for the PCs.

LED	State	LED Status
Power LED Indicator	System on (normal operation)	Steady green
	Suspend to RAM	Blinks green every 2 seconds
	Computer off	LED not on
Drive LED Indicator	Normal hard drive activity	Green drive LED is flashing

Accessing HP Insight Diagnostics

The HP Insight Diagnostics utility can be used to view information about the hardware configuration of the computer. It can also perform hardware diagnostic testing on the computer and its subsystems, which provides information for troubleshooting.

HP Insight Diagnostics runs from the recovery discs. To access HP Insight Diagnostics, the user must first create a set of recovery discs from the recovery image on their hard drive. Then they can access HP Insight Diagnostics by booting from the recovery disc that contains the utility.

To create a set of recovery discs, users need to perform the following steps.

1. Click **Start > HP Backup and Recovery > HP Backup and Recovery Manager**.
2. Click **Next** to open the Backup and Recovery Wizard.
3. Select **Create** to create a set of recovery discs, and then click Next.
4. Follow the wizard instructions to create a Recovery Disc Set.
5. Use Windows Explorer to search the Recovery Disc Set for the CD in the /Hpdiags directory.
6. Insert the CD into the optical drive on the computer.
7. Restart the computer and the system will boot to the CD.
8. Click the appropriate language and click **Next**.
9. Click **Agree** in the End User License Agreement page. The utility launches with the **Survey** tab displayed.

Testing Memory Modules

A faulty memory module or socket can lead to memory errors, operating system crashes, or frequent system lock-ups. Memory problems can be caused by overheating, problems with the power supply, or corrosion between the memory module and socket that weakens the electrical connection.

HP System Diagnostics allows the user to run tests on the system's hard drive, memory, and CPU. The diagnostic tool can check DIMMs to find out whether they are improperly configured, incorrectly installed, or defective.

To access HP Diagnostic Tools, the user presses the F9 button when booting the PC.

If HP Diagnostic Tools or POST beep codes indicate a memory error, check the following common memory issues before assuming that the DIMM is faulty.

Reason	Result	Remedy
Improperly configured	The user did not follow the proper configuration rules and might have the wrong part for the system.	Check the part number and make sure that the DIMMs are compatible with the system.

Improperly installed	The DIMM is not seated properly or a DIMM socket is bad or unusable.	Open the computer casing and reseal the DIMM. If this does not work, try different sockets. Check that no debris or corrosion is in the socket.
Defective	If the above remedies do not solve the DIMM issue, the DIMM could be defective.	Replace the DIMM.

POST Error/Warning Messages

Once the display becomes available, the BIOS should classify all errors detected during POST into 3 categories and handle them as specified below:

- Critical errors requiring system shutdown (e.g. CPU fan fault):
Clear the screen, display the corresponding error message, pause for a while as specified and then turn the system off.
- Serious errors requiring user's attention and response (e.g. SMART error during POST):
Display the corresponding error message, wait for the user's input and then proceed as selected.
- Alerts/warnings requiring user's attention (e.g. CMOS checksum error -> defaults loading):
Display the corresponding message and pause for a while as specified. If the message includes an option for a keystroke from the user and the user responds with the key input, proceed as selected. Otherwise, continue the POST process.

When there are multiple errors happened during POST, apply the following guideline:

- If multiple errors include at least one critical error, the system will shut down immediately after handling the first critical error.
- If multiple errors do not include a critical error, handle all serious errors first, one by one, and then proceed to alerts/warnings. For example, if the BIOS detected a SMART error (serious error), a floppy diskette failure (serious error) and a CMOS checksum error (alert/warning) during POST, the BIOS will handle them as follows:

For SKUs including an OS=MSV or an OS=LX in the SMBIOS Type 11 data,

1. Handle the first serious error, SMART error, as follows:

Display "xxx: Hard disk failure is imminent ... Press **F10** for Setup, **F2** to Continue". If the user selects **F10**, proceed to Setup. However, if the user selects **F2**, the BIOS should proceed to step 2 below.

2. Handle the second serious error, floppy diskette failure, as follows:

Display "Floppy diskette failure ... Press **F10** for Setup, **F2** to Continue". If the user selects **F10**, proceed to Setup. However, if the user selects **F2**, the BIOS should proceed to step 3 below.

3. Handle the alert/warning message, CMOS checksum error, as follows:

Display "Default BIOS settings have been loaded... Press **F10** for Setup, **F2** to Continue". If the user selects **F10**, proceed to Setup. However, if the user selects **F2**, the BIOS should proceed to step 2 below.

For all other SKUs,

Use **F1** instead of **F10** in the above handling.

 **NOTE:** If a device fails to respond while the BIOS tries to configure the device during POST, the BIOS must not make the system look as if it locked up by having an infinite loop or waiting for too long. Instead, the BIOS must time out after a reasonable amount of time (the time varies with the device) and skip to the next process.

NOTE: Unless specified in this document as above, the BIOS should not stop the POST process with any POST diagnostic screen and/or error message to draw user's attention. For example, HP does not consider replacing a hard drive or CPU as an error condition.

Power Button/Power Button LED

The power button is under the BIOS control during POST, in BIOS Setup and after booting to a non-ACPI OS. The BIOS must respond immediately when the power button is pressed in these environments. For the ACPI-compliant OS such as Windows, the BIOS must pass the power button information to the OS via the ACPI table as specified in the ACPI spec.

If a platform offers a dual-color-based power button LED, the BIOS will program the power button LED to alternate the color between the On (ACPI S0) state and the Stand-by (S3) state. In doing so, the LED should not blink, but stay constant. Check with the corresponding platform manager for the default colors in the On and Stand-by states. The color of the power button LED in the Hibernate state (ACPI S4) is the same as in the S5 state.

To find out if the system's power button LED is dual-color capable, check the SMBIOS Type 11 data structure. If the SMBIOS Type 11 data structure contains the string DLED (NOT case-sensitive), the system supports the dual-color power button LED and therefore, the BIOS support as described above is required.

Using the Setup Utility

The BIOS Setup Utility is accessed by pressing the **F10** button during startup. The BIOS Setup Utility allows you to:

- Change factory default settings
- Set the system date and time
- Set, view, change, or verify the system configuration—including settings for graphics, audio, storage, communications, and input devices
- View processor and memory settings
- Modify the boot order of bootable devices—such as hard drives, diskette drives, optical drives, or USB media

- Run tests on the hard drive
- Establish a supervisor password that controls access to the Setup Utility

BIOS Updates

HP periodically releases system BIOS updates, which are available from the HP website. These updates often contain fixes for known issues in the BIOS.

To find out whether a PC needs a BIOS update, compare the current BIOS version number against the latest version available for download. To determine the current BIOS version, you should perform the following steps:

1. Click **Start > Shut Down**.
2. Select **Restart**, and then click **OK**.
3. When the first screen displays, press **F10** to enter Setup. The BIOS revision number is listed on the main menu.
4. Write down the current BIOS version.
5. Exit Setup by pressing **Esc**, selecting **Yes**, and pressing **Enter**.

Clearing CMOS

The CLEAR CMOS jumper allows you to clear the Real Time Clock (RTC) RAM in CMOS. You can clear the CMOS memory of date, time, and system setup parameters by erasing the CMOS RTC RAM data. The onboard button cell battery powers the RAM data in CMOS, which include system setup information such as system passwords.

To erase the RTC RAM:

⚠ WARNING! Except when using this function, do not remove the jumper cap from the default position or else there may be a system boot failure.

1. Turn off the computer and disconnect the power cord.
2. Remove the RTC battery.
3. Disconnect the keyboard, monitor, and any other external devices that are connected to the computer.
4. Remove the access panel.
5. Locate the CMOS jumper header on the motherboard, as follows:
 - On model 500B/510B it is labeled E18.
 - On model 505B/515B it is labeled CLEAR CMOS.

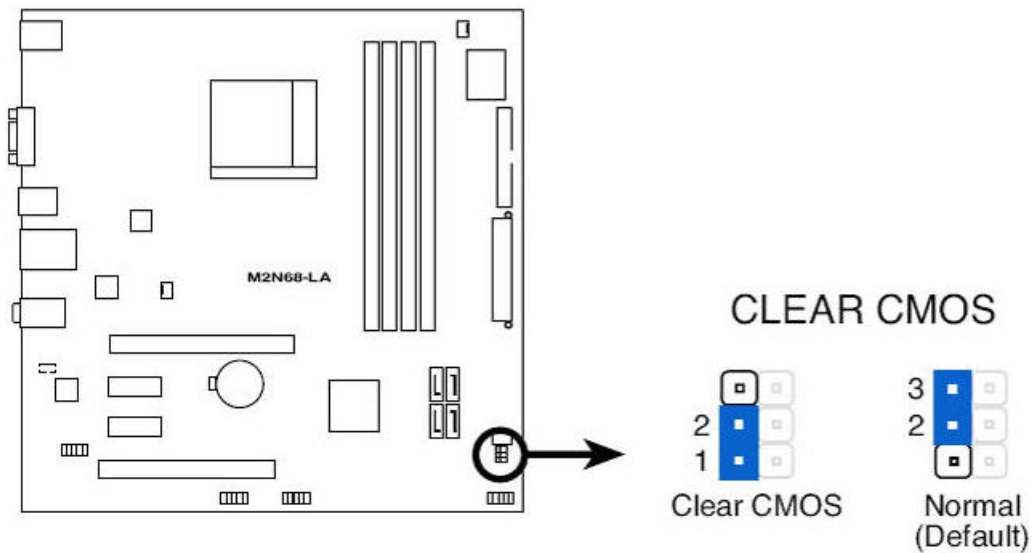

6. Remove the jumper from pins 2-3 pins and put it on pins 1-2 to clear CMOS. Keep the cap on pins 1-2 for 5 to 10 seconds.
7. Replace the jumper on pins 2-3.
8. Reinstall the battery.
9. Replace the access panel, external equipment, and reconnect the power cord.
10. Turn on the computer.
11. Hold down the **F1** key during boot and enter BIOS setup to re-enter data.

C Troubleshooting Without Diagnostics

This chapter provides information on how to identify and correct minor problems, such as hard drive, optical drive, graphics, audio, memory, and software problems. If you encounter problems with the computer, refer to the tables in this chapter for probable causes and recommended solutions.

 **NOTE:** For information on specific error messages that may appear on the screen during Power-On Self-Test (POST) at startup, refer to Appendix A, [Diagnostics on page 65](#).

Safety and Comfort

 **WARNING!** Misuse of the computer or failure to establish a safe and comfortable work environment may result in discomfort or serious injury. Refer to the *Safety & Comfort Guide* at <http://www.hp.com/ergo> for more information on choosing a workspace and creating a safe and comfortable work environment. This equipment has been tested and found to comply with the limits for a Class B digital device, pursuant to Part 15 of the FCC Rules. For more information, refer to the *Safety & Regulatory Information* guide.

Before You Call for Technical Support

If you are having problems with the computer, try the appropriate solutions below to try to isolate the exact problem before calling for technical support.

- Run the HP diagnostic tool.
- Run the hard drive self-test in Computer Setup. Refer to the *Computer Setup (F10) Utility Guide* for more information.
- If the screen is blank, plug the monitor into a different video port on the computer if one is available. Or, replace the monitor with a monitor that you know is functioning properly.
- If you are working on a network, plug another computer with a different cable into the network connection. There may be a problem with the network plug or cable.
- If you recently added new hardware, remove the hardware and see if the computer functions properly.
- If you recently installed new software, uninstall the software and see if the computer functions properly.
- Boot the computer to the Safe Mode to see if it will boot without all of the drivers loaded. When booting the operating system, use “Last Known Configuration.”

- Refer to the comprehensive online technical support at <http://www.hp.com/support>.
- Refer to [Helpful Hints on page 73](#) in this guide.

To assist you in resolving problems online, HP Instant Support Professional Edition provides you with self-solve diagnostics. If you need to contact HP support, use HP Instant Support Professional Edition's online chat feature. Access HP Instant Support Professional Edition at: <http://www.hp.com/go/ispe>.

Access the Business Support Center (BSC) at <http://www.hp.com/go/bizsupport> for the latest online support information, software and drivers, proactive notification, and worldwide community of peers and HP experts.

If it becomes necessary to call for technical assistance, be prepared to do the following to ensure that your service call is handled properly:

- Be in front of your computer when you call.
- Write down the computer serial number, product ID number, and monitor serial number before calling.
- Spend time troubleshooting the problem with the service technician.
- Remove any hardware that was recently added to your system.
- Remove any software that was recently installed.

 **NOTE:** For sales information and warranty upgrades (Care Packs), call your local authorized service provider or dealer.

Helpful Hints

If you encounter problems with the computer, monitor, or software, see the following list of general suggestions before taking further action:

- Check that the computer and monitor are plugged into a working electrical outlet.
- Check that the computer is turned on and the green power light is on.
- Check that the monitor is turned on and the green monitor light is on.
- Turn up the brightness and contrast controls of the monitor if the monitor is dim.
- Press and hold any key. If the system beeps, then the keyboard should be operating correctly.
- Check all cable connections for loose connections or incorrect connections.
- Wake the computer by pressing any key on the keyboard or pressing the power button. If the system remains in suspend mode, shut down the computer by pressing and holding the power button for at least four seconds then press the power button again to restart the computer. If the system will not shut down, unplug the power cord, wait a few seconds, then plug it in again. The computer will restart if it is set to automatic start after power loss in Computer Setup as soon as power is restored. If it does not restart, press the power button to start the computer.

- Be sure that all the needed device drivers have been installed. For example, if you are using a printer, you need a driver for that model printer.
- Remove all bootable media (DVD or USB device) from the system before turning it on.
- If you have installed an operating system other than the factory-installed operating system, check to be sure that it is supported on the system.
- If the system has multiple video sources (embedded, PCI, or PCI-Express adapters) installed (embedded video on some models only) and a single monitor, the monitor must be plugged into the monitor connector on the source selected as the primary VGA adapter. During boot, the other monitor connectors are disabled and if the monitor is connected into these ports, the monitor will not function. You can select which source will be the default VGA source in Computer Setup.

△ **CAUTION:** When the computer is plugged into an AC power source, there is always voltage applied to the system board. You must disconnect the power cord from the power source before opening the computer to prevent system board or component damage.

Solving General Problems

You may be able to easily resolve the general problems described in this section. If a problem persists and you are unable to resolve it yourself or if you feel uncomfortable about performing the operation, contact an authorized dealer or reseller.

△ **WARNING!** When the computer is plugged into an AC power source, voltage is always applied to the system board. To reduce the risk of personal injury from electrical shock and/or hot surfaces, be sure to disconnect the power cord from the wall outlet and allow the internal system components to cool before touching.

Computer appears locked up and will not turn off when the power button is pressed.

Cause	Solution
Software control of the power switch is not functional.	<ol style="list-style-type: none"> 1. Press and hold the power button for at least four seconds until the computer turns off. 2. Disconnect the power cord from the electrical outlet.

Computer date and time display is incorrect.

Cause	Solution
RTC (real-time clock) battery may need to be replaced.	First, reset the date and time under Control Panel (Computer Setup can also be used to update the RTC date and time). If the problem persists, replace the RTC battery.
NOTE: Connecting the computer to a live AC outlet prolongs the life of the RTC battery.	

Poor performance is experienced.

Cause	Solution
Processor is hot.	<ol style="list-style-type: none">1. Make sure airflow to the computer is not blocked. Leave a 10.2-cm (4-inch) clearance on all vented sides of the computer and above the monitor to permit the required airflow.2. Make sure fans are connected and working properly (some fans only operate when needed).3. Make sure the processor heat sink is installed properly.
Hard drive is full.	Transfer data from the hard drive to create more space on the hard drive. Run the windows disk-cleanup utility to clear some space on the hard drive. Uninstall applications that are not being used.
Low on memory.	Add more memory.
Too many applications running.	<ol style="list-style-type: none">1. Close unnecessary applications to free up memory.2. Add more memory. Some applications run in the background and can be closed by right-clicking on their corresponding icons in the task tray.

The computer is beeping and will not start.

Cause	Solution
A hardware error has occurred during POST and the computer is beeping a code.	See POST Error/Warning Messages on page 68 to interpret the error code.

Solving Power Problems

Common causes and solutions for power problems are listed in the following table.

The computer will not turn on.

Cause	Solution
Cables to the external power source are unplugged.	Check that the cables connecting the computer to the external power source are plugged in properly, and that the wall outlet is active.
The voltage selector switch on the rear of the computer chassis (some models) is not switched to the correct line voltage (115V or 230V).	Select the proper AC voltage using the selector switch.
A defective PCI card has been installed.	Remove any expansion board that was just installed.

The computer will not turn on.

Cause	Solution
Drive data or power supply cables might not be properly connected.	Reseat drive data and power supply cables.
The unit temperature might have exceeded safe limits, or the fan might be blocked.	The computer is in an exceedingly hot environment. Let it cool down and check that the computer air vents are not blocked, and that the internal fan is running.

Solving Hard Drive Problems

Drive not found (identified).

Cause	Solution
Cable could be loose.	Check cable connections.
The system may not have automatically recognized a newly installed device.	<ul style="list-style-type: none">• Boot and press F10 to launch the HP Setup Utility.• Select Device Configuration from the Storage menu, and determine whether the device is listed. <p>If the device is not listed, the cable connection might be loose or the drive might be faulty.</p>
The drive's SATA controller is disabled in HP Setup.	Reconnect the power cable and ensure that all four pins are connected.
Drive responds slowly after initial power up.	Run Computer Setup and increase the POST Delay in Advanced > Power-On Options .

Nonsystem disk/NTLDR missing message.

Cause	Solution
The system is trying to start from the hard drive but the hard drive may have been damaged.	Try to reboot the computer from another bootable device, such as a diskette or USB disk-on-key. If the operating system boots from the new device, either the hard drive is defective or the boot block is corrupted.
System files missing or not properly installed.	<ol style="list-style-type: none">1. Insert a bootable media device into the drive and restart the computer.2. Verify that the hard drive is partitioned and formatted.3. Install system files for the appropriate operating system, if necessary.
Hard drive boot has been disabled in Computer Setup.	Run the Computer Setup utility and enable the hard drive entry in the Storage > Boot Order list.

Solving Media Card Reader Problems

 **NOTE:** It is possible that the driver your memory card uses has become corrupted or is not functioning correctly. From time to time new drivers and firmware are released to address issues. New firmware for your memory card reader might be available that would resolve the particular issue you are having. Make sure that you are using the latest driver and firmware, periodically check for new releases of this software on the HP Software Download Web page.

The memory card reader does not appear in My Computer or Windows Explorer.

Cause	Solution
You are using an adapter for a type of memory card not supported by the reader.	Refer to the manufacturer of the adapter for help. Make sure the memory card is one of the supported types: CompactFlash (1, 2, and Microdrive), Memory Stick, MultiMedia, Secure Digital, or SmartMedia memory cards.
The memory card is faulty.	Try a different memory card of the same type in the same slot. If the other memory card works, the card reader is good and the original memory card should be replaced.
Media Center is not detecting the memory card.	Remove the memory card, maximize the Media Center window, and re-insert the memory card.
The memory card reader is not responding.	Turn off the computer, disconnect the power cord, and press the power button on the front of the computer for 5 seconds. Reconnect power and turn on the computer to test the reader.
The USB port is not responding.	Insert a USB device into an open USB port to test the USB. If the device works properly, go to the next step. If the USB device also fails, there is a problem with the USB port. See the USB troubleshooting guide for help in this matter.
The internal memory card reader pin is bent.	Shine a flashlight into the empty card slots. Check whether any pins inside are bent. Disconnect the computer from power and straighten the bent pins with the end of a mechanical pencil. If a pin has bent to the point where it is touching another pin, replace the memory card reader or have the computer serviced.

Memory card appears in My Computer, but errors occur when writing or reading.

Cause	Solution
The memory card is faulty.	Try a different memory card of the same type in the same slot. If the different memory card works, the card reader is good and the original memory card should be replaced.
Write protect click has been set to Disable.	Check that the switch is set to Write Enabled before attempting to write data to it.
Data has exceeded the memory card size.	Check that the amount of data you attempted to store has not exceeded the capacity of the card.
Dirt or material is closing a hole or spoiling a metal contact.	Clean the contacts with a lint-free cloth and small amounts of isopropyl alcohol. Replace the memory card if necessary.

Memory card appears in My Computer, but errors occur when writing or reading.

Cause	Solution
You are using an adapter for a type of memory card not supported by the reader.	Consult the manufacturer of the adapter for help. Be sure that the memory card is one of the supported types: CompactFlash (1, 2, and Microdrive), Memory Stick, MultiMedia, Secure Digital, or SmartMedia memory cards.
The memory card is not properly inserted.	Make sure that the memory card is fully inserted into the slot.
The internal memory card reader pin is bent.	Shine a flashlight into the empty card slots. Check whether any pins inside are bent. Disconnect the computer from power and straighten the bent pins with the end of a mechanical pencil. If a pin has bent to the point where it is touching another pin, replace the memory card reader or have the computer serviced.

Solving Display Problems

If you encounter display problems, see the documentation that came with the monitor and to the common causes and solutions listed in the following table.

Blank screen (no video).

Cause	Solution
Monitor is not turned on and the monitor light is not on.	Turn on the monitor and check that the monitor light is on.
Bad monitor.	Try a different monitor.
The cable connections are not correct.	Check the cable connection from the monitor to the computer and to the electrical outlet.
You may have a screen blanking utility installed or energy saver features are enabled.	Press any key or click the mouse button and, if set, type your password.
You are using a fixed-sync monitor and it will not sync at the resolution chosen.	Be sure that the monitor can accept the same horizontal scan rate as the resolution chosen.
Computer is in Standby mode.	Press the power button to resume from Standby mode. CAUTION: When attempting to resume from standby mode, do not hold down the power button for more than four seconds. Otherwise, the computer will shut down and you will lose any unsaved data.
Monitor cable is plugged into the wrong connector. If another video port is available, connect the monitor to that port and reboot the system.	Check that the monitor is plugged into an active connector on the rear of the computer.

The picture is broken up, rolls, jitters, or flashes.

Cause	Solution
The monitor connections may be incomplete or the monitor may be incorrectly adjusted.	Restore the monitor settings to factory default.

High pitched noise coming from inside a flat panel monitor.

Cause	Solution
Brightness and/or contrast settings are too high.	Lower brightness and/or contrast settings.

Solving Audio Problems

If the computer has audio features and you encounter audio problems, see the common causes and solutions listed in the following table.

Sound cuts in and out.

Cause	Solution
Processor resources are being used by other open applications.	Shut down all processor-intensive applications or cut down the number of applications running.

No sound.

Cause	Solution
Volume has been muted or lowered.	Double-click the speaker icon on the taskbar, and clear the Mute All check box or adjust the volume level.
External speakers are not turned on.	Turn on the external speakers.
External speakers are plugged into the wrong audio jack.	Check the sound card documentation for proper speaker connection.
A device, such as headphones, is connected to the line-out jack.	Turn on and use headphones or external speakers—only connect to one device at a time.

Solving Keyboard and Mouse Problems

If you encounter keyboard or mouse problems, see the documentation that came with the equipment and to the common causes and solutions listed in the following table.

Keyboard commands and typing are not recognized by the computer.

Cause	Solution
Keyboard connector is not properly connected.	Replace the keyboard.

Computer will not respond to a USB keyboard or mouse.

Cause	Solution
The keyboard or mouse is not connected to the computer.	Make sure that the keyboard and mouse cables are connected to the computer.

No response from the USB keyboard and mouse during running of application.

Cause	Solution
The application has stopped responding.	Restart the computer.

Mouse does not respond to movement or is too slow.

Cause	Solution
Mouse connector is not properly plugged into the back of the computer.	Shut down the computer if it still does not respond.
Mouse may be faulty.	Replace mouse.

Solving Network Problems

Some common causes and solutions for network problems are listed in the following table. These guidelines do not discuss the process of debugging the network cabling.

Network driver does not detect network controller.

Cause	Solution
Network controller is disabled.	Run the HP Setup Utility and enable the network controller.
Incorrect network driver.	Check the network controller documentation for the correct driver or obtain the latest driver from the manufacturer's Web site.

Network status link light is not working or never flashes.

NOTE: The network status light is supposed to flash when there is network activity.

Cause	Solution
No active network is detected.	Check cabling and network equipment for proper connection.
Network controller is not set up properly.	Use the network control application to verify that the device is working properly.

Diagnostics reports a failure.

Cause	Solution
The cable is not securely connected.	Ensure that the cable is securely attached to the network connector and that the other end of the cable is securely attached to the correct device.
There is a problem with the cable or a device at the other end of the cable.	Ensure that the cable and device at the other end are operating correctly.

Diagnostics reports a failure.

Cause	Solution
Network controller interrupt is shared with an expansion board.	Under the Computer Setup Advanced menu, change the resource settings for the board. Check that they are different from those of the network controller.
The network controller is defective.	Disable the integrated network controller from the setup utility and install a new network interface card.

Network controller stops working without apparent cause.

Cause	Solution
The files containing the network drivers are corrupted.	Reinstall the network drivers.
The cable is not securely connected.	Ensure that the cable is securely attached to the network connector and that the other end of the cable is securely attached to the correct device.
The network is temporarily unavailable.	Contact the network administrator to find out the status of the network.

Cannot connect to network server when attempting Remote System Installation.

Cause	Solution
The network controller is not configured properly.	Verify that the computer is properly connected to the network, that a DHCP Server is present, and that the Remote System Installation Server contains drivers for the network controller.

Solving Memory Problems

If you encounter memory problems, some common causes and solutions are listed in the following table.

System will not boot or does not function properly after installing additional memory modules.

Cause	Solution
Memory module is not the correct type or speed grade for the system or the new memory module is not seated properly.	Replace module with the correct industry-standard device for the computer. Do not mix ECC and non-ECC memory modules.
The memory module is not correctly seated.	Open the casing and reseat the DIMM.

Memory count during POST is wrong.

Cause	Solution
The memory modules may not be installed correctly.	Check that the memory modules have been installed correctly and that proper modules are used.
One of the memory modules might be faulty.	<ol style="list-style-type: none">1. Find out which module is faulty by booting with each module individually.2. Replace the faulty memory module.

Insufficient memory error during operation.

Cause	Solution
The system does not have enough memory to run the software.	Check the software requirements and upgrade to an adequate amount.

Solving CD-ROM and DVD Problems

If you encounter CD-ROM or DVD problems, see the common causes and solutions listed in the following table or to the documentation that came with the optional device.

System will not boot from DVD drive.

Cause	Solution
DVD boot is not enabled in the BIOS Setup Utility.	Run the BIOS Setup Utility, select Device Options from the Storage menu and enable removable media boot. Verify the boot order and check that the DVD drives are listed in the boot order.

DVD device not detected or driver is not loaded.

Cause	Solution
Drive is not connected properly or not properly configured.	<ol style="list-style-type: none">1. Power off the PC.2. Reconnect the power and data cables to the drive.3. Reboot the PC4. Reinstall the correct (new or updated) device driver.

An optical drive cannot read a CD or DVD disc.

Cause	Solution
The disc is upside down or not seated properly.	Reinsert the disc with the label facing up and verify that the disc is securely snapped down on the spindle.

An optical drive cannot read a CD or DVD disc.

Cause	Solution
CD or DVD disc is dirty.	Clean the disc.
Windows does not detect the DVD-ROM drive.	<ol style="list-style-type: none">1. Use Device Manager to remove or uninstall the device.2. Restart the computer and let Windows detect the device.
The disc is damaged or corrupted.	Obtain a replacement disk.

Cannot eject a disc.

Cause	Solution
The disc is not properly seated in the drive.	Shut down the computer and insert a thin metal rod into the emergency eject hole and push firmly. Slowly pull the tray out from the drive until the tray is fully extended, then remove the disc.

Solving Front Panel Component Problems

If you encounter problems with devices connected to the front panel, refer to the common causes and solutions listed in the following table.

A USB device is not recognized by the computer.

Cause	Solution
The device does not have power.	If the USB device requires AC power, be sure one end is connected to the device and one end is connected to a live outlet.

The headphone or microphone is not working.

Cause	Solution
The cable from the device to the computer is faulty.	Replace the cable.
The correct driver is not installed.	Reinstall the driver and restart the computer.

D Connector Pin Assignments

This appendix contains the pin assignments for many computer and workstation connectors. Some of these connectors may not be used on the product being serviced.

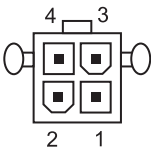

4-Pin Power (for CPU)

Connector and Icon	Pin	Signal
	1	GND
	2	GND
	3	+12V CPU
	4	-12V CPU

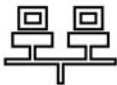
Ethernet BNC

Connector and Icon	Pin	Signal
 	1	Data
	2	Ground

USB

Connector and Icon	Pin	Signal
 	1	+5 VDC
	2	- Data
	3	+ Data
	4	Ground

Microphone

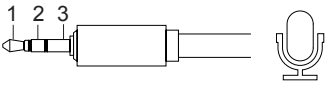
Connector and Icon (1/8" miniphone)	Pin	Signal
	1 (Tip)	Audio_left
	2 (Ring)	Audio_Right
	3 (Shield)	Ground

Headphone

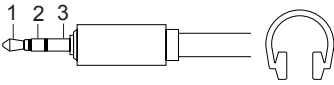
Connector and Icon (1/8" miniphone)	Pin	Signal
	1 (Tip)	Audio_left
	2 (Ring)	Power_Right
	3 (Shield)	Ground

Line-in Audio

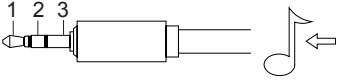
Connector and Icon (1/8" miniphone)	Pin	Signal
	1 (Tip)	Audio_In_Left
	2 (Ring)	Audio_In_Right
	3 (Shield)	Ground

Line-out Audio

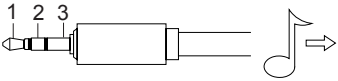
Connector and Icon (1/8" miniphone)	Pin	Signal
	1 (Tip)	Audio_Out_Left
	2 (Ring)	Audio_Out_Right
	3 (Shield)	Ground

Monitor

Connector and Icon

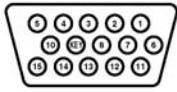

Pin	Signal	Pin	Signal
1	Red Analog	9	+5V (fused)
2	Green Analog	10	Ground
3	Blue Analog	11	Not used
4	Not used	12	DDC Serial Data
5	Ground	13	Horizontal Sync
6	Ground	14	Vertical Sync
7	Ground	15	DDC Serial Clock
8	Ground		

24-Pin Power

Connector

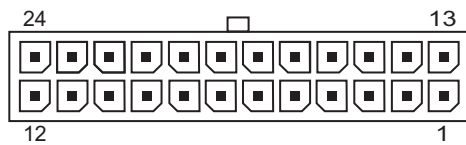

Front

Pin	Signal	Pin	Signal	Pin	Signal	Pin	Signal
1	+3.3V	7	GND	13	+3.3V	19	GND
2	+3.3V	8	POK	14	-12V	20	open
3	GND	9	+5 Vaux	15	GND	21	+5V
4	+5V	10	+12V	16	PSON	22	+5V
5	GND	11	+12V	17	GND	23	+5V
6	+5V	12	+3.3V	18	GND	24	GND

PCI Express

x1, x4, x8, and x16 PCI Express Connector



Pin A

Pin	Signal	Pin	Signal	Pin	Signal	Pin	Signal	Pin	Signal
1	PRSNT1	6	JTAG3	11	PERST#	16	PERp0	21	PERp1
2	+12V	7	JTAG4	12	GND	17	PERn0	22	PERn1
3	+12V	8	JTAG5	13	REFCLK+	18	GND	23	GND
4	GND	9	+3.3V	14	REFCLK-	19	RSVD	24	GND
5	JTAG2	10	+3.3V	15	GND	20	GND	25	PERp2
26	PERn(2)	31	GND	36	PERn4	41	GND	46	GND
27	GND	32	RSVD	37	GND	42	GND	47	PERp7
28	GND	33	RSVD	38	GND	43	PERp6	48	PERn7
29	PERp3	34	GND	39	PERp5	44	PERn6	49	GND
30	PERn3	35	PERp4	40	PERn5	45	GND	50	RSVD
51	GND	56	PERp9	61	PERn10	66	GND	71	GND
52	PERp8	57	PERn9	62	GND	67	GND	72	PERp13
53	PERn8	58	GND	63	GND	68	PERp12	73	PERn13
54	GND	59	GND	64	PERp11	69	PERn12	74	GND
55	GND	60	PERp10	65	PERn11	70	GND	75	GND

76	PERp14	81	PERn15
77	PERn14	82	GND
78	GND		
79	GND		
80	PERp15		

Pin B information is on the next page

NOTE: x1 PCI Express uses pins 1-18

x4 PCI Express uses pins 1-32

x8 PCI Express uses pins 1-49

x16 PCI Express uses pins 1-8

PCI Express

x1, x4, x8, and x16 PCI Express Connector

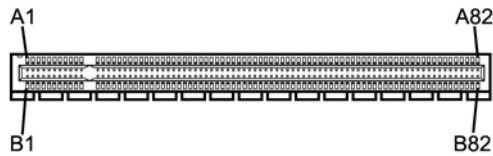

Pin B

Pin	Signal	Pin	Signal	Pin	Signal	Pin	Signal	Pin	Signal
1	+12V	6	SMDAT	11	WAKE#	16	GND	21	GND
2	+12V	7	GND	12	RSVD	17	GND	22	GND
3	RSVD	8	+3.3 V	13	GND	18	PETp1	23	PETp2
4	GND	9	JTAG1	14	PETp0	19	PETn1	24	PETn2
5	SMCLK	10	3.3vAux	15	PETn0	20		25	GND
26	GND	31	PRSNT2#	36	GND	41	PETp6	46	PETn7
27	PETp3	32	GND	37	PETp5	42	PRTn6	47	GND
28	PETn3	33	PETp4	38	PETn5	43	GND	48	PRSNT2#
29	GND	34	PETn4	39	GND	44	GND	49	GND
30	RSVD	35	GND	40	GND	45	PETp7	50	PETp8

51	PETn8	56	GND	61	GND	66	PETp12	71	PETn13
52	GND	57	GND	62	PETp11	67	PETn12	72	GND
53	GND	58	PETp10	63	PETn11	68	GND	73	GND
54	PETp9	59	PETn10	64	GND	69	GND	74	PETp14
55	PETn9	60	GND	65	GND	70	PETp13	75	PETn14

76	GND	81	PRSNT2#
77	GND	82	RSVD
78	PETp15		
79	PETn15		
80	GND		

Pin B information is on the next page

NOTE: x1 PCI Express uses pins 1-18

x4 PCI Express uses pins 1-32

x8 PCI Express uses pins 1-49

x16 PCI Express uses pins 1-8

E Routine Care and Disassembly Preparation

This chapter provides general service information for the computer. Adherence to the procedures and precautions described in this chapter is essential for proper service.

- △ **CAUTION:** When the computer is plugged into an AC power source, voltage is always applied to the system board. You must disconnect the power cord from the power source before opening the computer to prevent system board or component damage.

Electrostatic Discharge Information

A sudden discharge of static electricity from your finger or other conductor can destroy static-sensitive devices or microcircuitry. Often the spark is neither felt nor heard, but damage occurs. An electronic device exposed to electrostatic discharge (ESD) may not appear to be affected at all and can work perfectly throughout a normal cycle. The device may function normally for a while, but it has been degraded in the internal layers, reducing its life expectancy.

Networks built into many integrated circuits provide some protection, but in many cases, the discharge contains enough power to alter device parameters or melt silicon junctions.

Generating Static

The following table shows that:

- Different activities generate different amounts of static electricity.
- Static electricity increases as humidity decreases.

Event	Relative Humidity		
	55%	40%	10%
Walking across carpet	7,500 V	15,000 V	35,000 V
Walking across vinyl floor	3,000 V	5,000 V	12,000 V
Motions of bench worker	400 V	800 V	6,000 V
Removing DIPs* from plastic tube	400 V	700 V	2,000 V

Removing DIPs* from vinyl tray	2,000 V	4,000 V	11,500 V
Removing DIPs* from Styrofoam	3,500 V	5,000 V	14,500 V
Removing bubble pack from PCB	7,000 V	20,000 V	26,500 V
Packing PCBs in foam-lined box	5,000 V	11,000 V	21,000 V

*These are then multi-packaged inside plastic tubes, trays, or Styrofoam.

 **NOTE:** 700 volts can degrade a product.

Preventing Electrostatic Damage to Equipment

Many electronic components are sensitive to ESD. Circuitry design and structure determine the degree of sensitivity. The following packaging and grounding precautions are necessary to prevent damage to electric components and accessories.

- To avoid hand contact, transport products in static-safe containers such as tubes, bags, or boxes.
- Protect all electrostatic parts and assemblies with conductive or approved containers or packaging.
- Keep electrostatic sensitive parts in their containers until they arrive at static-free stations.
- Place items on a grounded surface before removing them from their container.
- Always be properly grounded when touching a sensitive component or assembly.
- Avoid contact with pins, leads, or circuitry.
- Place reusable electrostatic-sensitive parts from assemblies in protective packaging or conductive foam.

Personal Grounding Methods and Equipment

Use the following equipment to prevent static electricity damage to equipment:

- **Wrist straps** are flexible straps with a maximum of one-megohm \pm 10% resistance in the ground cords. To provide proper ground, a strap must be worn snug against bare skin. The ground cord must be connected and fit snugly into the banana plug connector on the grounding mat or workstation.
- **Heel straps/Toe straps/Boot straps** can be used at standing workstations and are compatible with most types of shoes or boots. On conductive floors or dissipative floor mats, use them on both feet with a maximum of one-megohm \pm 10% resistance between the operator and ground.

Static Shielding Protection Levels

Method	Voltage
Antistatic plastic	1,500
Carbon-loaded plastic	7,500
Metallized laminate	15,000

Grounding the Work Area

To prevent static damage at the work area, use the following precautions:

- Cover the work surface with approved static-dissipative material. Provide a wrist strap connected to the work surface and properly grounded tools and equipment.
- Use static-dissipative mats, foot straps, or air ionizers to give added protection.
- Handle electrostatic sensitive components, parts, and assemblies by the case or PCB laminate. Handle them only at static-free work areas.
- Turn off power and input signals before inserting and removing connectors or test equipment.
- Use fixtures made of static-safe materials when fixtures must directly contact dissipative surfaces.
- Keep work area free of nonconductive materials such as ordinary plastic assembly aids and Styrofoam.
- Use field service tools, such as cutters, screwdrivers, and vacuums, that are conductive.

Recommended Materials and Equipment

Materials and equipment that are recommended for use in preventing static electricity include:

- Antistatic tape
- Antistatic smocks, aprons, or sleeve protectors
- Conductive bins and other assembly or soldering aids
- Conductive foam
- Conductive tabletop workstations with ground cord of one-megohm +/- 10% resistance
- Static-dissipative table or floor mats with hard tie to ground
- Field service kits
- Static awareness labels
- Wrist straps and footwear straps providing one-megohm +/- 10% resistance
- Material handling packages
- Conductive plastic bags
- Conductive plastic tubes

- Conductive tote boxes
- Opaque shielding bags
- Transparent metallized shielding bags
- Transparent shielding tubes

Operating Guidelines

To prevent overheating and to help prolong the life of the computer:

- Keep the computer away from excessive moisture, direct sunlight, and extremes of heat and cold.
- Operate the computer on a sturdy, level surface. Leave a 10.2-cm (4-inch) clearance on all vented sides of the computer and above the monitor to permit the required airflow.
- Never restrict the airflow into the computer by blocking any vents or air intakes. Do not place the keyboard, with the keyboard feet down, directly against the front of the desktop unit as this also restricts airflow.
- Occasionally clean the air vents on all vented sides of the computer. Lint, dust, and other foreign matter can block the vents and limit the airflow. Be sure to unplug the computer before cleaning the air vents.
- Never operate the computer with the cover or side panel removed.
- Do not stack computers on top of each other or place computers so near each other that they are subject to each other's re-circulated or preheated air.
- If the computer is to be operated within a separate enclosure, intake and exhaust ventilation must be provided on the enclosure, and the same operating guidelines listed above will still apply.
- Keep liquids away from the computer and keyboard.
- Never cover the ventilation slots on the monitor with any type of material.
- Install or enable power management functions of the operating system or other software, including sleep states.

Routine Care

General Cleaning Safety Precautions

1. Never use solvents or flammable solutions to clean the computer.
2. Never immerse any parts in water or cleaning solutions; apply any liquids to a clean cloth and then use the cloth on the component.
3. Always unplug the computer when cleaning with liquids or damp cloths.
4. Always unplug the computer before cleaning the keyboard, mouse, or air vents.
5. Disconnect the keyboard before cleaning it.
6. Wear safety glasses equipped with side shields when cleaning the keyboard.

Cleaning the Computer Case

Follow all safety precautions in [General Cleaning Safety Precautions on page 94](#) before cleaning the computer.

To clean the computer case, follow the procedures described below:

- To remove light stains or dirt, use plain water with a clean, lint-free cloth or swab.
- For stronger stains, use a mild dishwashing liquid diluted with water. Rinse well by wiping it with a cloth or swab dampened with clear water.
- For stubborn stains, use isopropyl (rubbing) alcohol. No rinsing is needed as the alcohol will evaporate quickly and not leave a residue.
- After cleaning, always wipe the unit with a clean, lint-free cloth.
- Occasionally clean the air vents on the computer. Lint and other foreign matter can block the vents and limit the airflow.

Cleaning the Keyboard

Follow all safety precautions in [General Cleaning Safety Precautions on page 94](#) before cleaning the keyboard.

To clean the tops of the keys or the keyboard body, follow the procedures described in [Cleaning the Computer Case on page 94](#).

When cleaning debris from under the keys, review all rules in [General Cleaning Safety Precautions on page 94](#) before following these procedures:

△ **CAUTION:** Use safety glasses equipped with side shields before attempting to clean debris from under the keys.

- Visible debris underneath or between the keys may be removed by vacuuming or shaking.
- Canned, pressurized air may be used to clean debris from under the keys. Caution should be used as too much air pressure can dislodge lubricants applied under the wide keys.
- If you remove a key, use a specially designed key puller to prevent damage to the keys. This tool is available through many electronic supply outlets.

△ **CAUTION:** Never remove a wide leveled key (like the space bar) from the keyboard. If these keys are improperly removed or installed, the keyboard may not function properly.

- Cleaning under a key may be done with a swab moistened with isopropyl alcohol and squeezed out. Be careful not to wipe away lubricants necessary for proper key functions. Use tweezers to remove any fibers or dirt in confined areas. Allow the parts to air dry before reassembly.

Cleaning the Monitor

- Wipe the monitor screen with a clean cloth moistened with water or with a towelette designed for cleaning monitors. Do not use sprays or aerosols directly on the screen; the liquid may seep into the housing and damage a component. Never use solvents or flammable liquids on the monitor.
- To clean the monitor body follow the procedures in [Cleaning the Computer Case on page 94](#).

Cleaning the Mouse

Before cleaning the mouse, ensure that the power to the computer is turned off.

- Clean the mouse ball by first removing the retaining plate and the ball from the housing. Pull out any debris from the ball socket and wipe the ball with a clean, dry cloth before reassembly.
- To clean the mouse body, follow the procedures in [Cleaning the Computer Case on page 94](#).

Service Considerations

Listed below are some of the considerations that you should keep in mind during the disassembly and assembly of the computer.

Power Supply Fan

The power supply fan is a variable-speed fan based on the temperature in the power supply.

△ **CAUTION:** The cooling fan is always on when the computer is in the “On” mode. The cooling fan is off when the computer is in “Standby,” “Suspend,” or “Off” modes.

You must disconnect the power cord from the power source before opening the computer to prevent system board or component damage.

Tools and Software Requirements

To service the computer, you need the following:

- Torx T-15 screwdriver (HP screwdriver with bits, PN 161946-001)
- Torx T-15 screwdriver with small diameter shank (for certain front bezel removal)
- Flat-bladed screwdriver (may sometimes be used in place of the Torx screwdriver)
- Phillips #2 screwdriver
- Diagnostics software
- HP tamper-resistant T-15 wrench (Smart Cover FailSafe Key, PN 166527-001) or HP tamper-resistant bits (Smart Cover FailSafe Key, PN 166527-002)

Screws

The screws used in the computer are not interchangeable. They may have standard or metric threads and may be of different lengths. If an incorrect screw is used during the reassembly process, it can damage the unit. HP strongly recommends that all screws removed during disassembly be kept with the part that was removed, then returned to their proper locations.

△ **CAUTION:** Metric screws have a black finish. U.S. screws have a silver finish and are used on hard drives only.

CAUTION: As each subassembly is removed from the computer, it should be placed away from the work area to prevent damage.

Cables and Connectors

Most cables used throughout the unit are flat, flexible cables. These cables must be handled with care to avoid damage. Apply only the tension required to seat or unseat the cables during insertion or removal from the connector. Handle cables by the connector whenever possible. In all cases, avoid bending or twisting the cables, and ensure that the cables are routed in such a way that they cannot be caught or snagged by parts being removed or replaced.

△ **CAUTION:** When servicing this computer, ensure that cables are placed in their proper location during the reassembly process. Improper cable placement can damage the computer.

Hard Drives

Handle hard drives as delicate, precision components, avoiding all physical shock and vibration. This applies to failed drives as well as replacement spares.

- If a drive must be mailed, place the drive in a bubble-pack mailer or other suitable protective packaging and label the package "Fragile: Handle With Care."
- Do not remove hard drives from the shipping package for storage. Keep hard drives in their protective packaging until they are actually mounted in the CPU.
- Avoid dropping drives from any height onto any surface.

- If you are inserting or removing a hard drive, turn off the computer. Do not remove a hard drive while the computer is on or in standby mode.
- Before handling a drive, ensure that you are discharged of static electricity. While handling a drive, avoid touching the connector. For more information about preventing electrostatic damage, refer to [Electrostatic Discharge Information on page 90](#)
- Do not use excessive force when inserting a drive.
- Avoid exposing a hard drive to liquids, temperature extremes, or products that have magnetic fields such as monitors or speakers.

Lithium Coin Cell Battery

The battery that comes with the computer provides power to the real-time clock and has a minimum lifetime of about three years.

See the appropriate removal and replacement chapter for the chassis you are working on in this guide for instructions on the replacement procedures.

 **WARNING!** This computer contains a lithium battery. There is a risk of fire and chemical burn if the battery is handled improperly. Do not disassemble, crush, puncture, short external contacts, dispose in water or fire, or expose it to temperatures higher than 140°F (60°C). Do not attempt to recharge the battery.

 **NOTE:** Batteries, battery packs, and accumulators should not be disposed of together with the general household waste. In order to forward them to recycling or proper disposal, please use the public collection system or return them to HP, their authorized partners, or their agents.

F Serial ATA (SATA) Drive Guidelines and Features

 **NOTE:** HP only supports the use of SATA hard drives on these models of computer. No Parallel ATA (PATA) drives are supported.

SATA Hard Drives

Serial ATA Hard Drive Characteristics	
Number of pins/conductors in data cable	7/7
Number of pins in power cable	15
Maximum data cable length	39.37 in (100 cm)
Data interface voltage differential	400-700 mV
Drive voltages	3.3 V, 5 V, 12 V
Jumpers for configuring drive	N/A
Data transfer rate	3.0 Gb/s

SATA Hard Drive Cables

SATA Data Cable

Always use an HP approved SATA 3.0 Gb/s cable as it is fully backwards compatible with the SATA 1.5 Gb/s drives.

Current HP desktop products ship with SATA 3.0 Gb/s hard drives.

SATA data cables are susceptible to damage if overflexed. Never crease a SATA data cable and never bend it tighter than a 30 mm (1.18 in) radius.

The SATA data cable is a thin, 7-pin cable designed to transmit data for only a single drive.

SMART ATA Drives

The Self Monitoring Analysis and Recording Technology (SMART) ATA drives for the HP Personal Computers have built-in drive failure prediction that warns the user or network administrator of an impending failure or crash of the hard drive. The SMART drive tracks fault prediction and failure indication parameters such as reallocated sector count, spin retry count, and calibration retry count. If the drive determines that a failure is imminent, it generates a fault alert.

Hard Drive Capacities

The combination of the file system and the operating system used in the computer determines the maximum usable size of a drive partition. A drive partition is the largest segment of a drive that may be properly accessed by the operating system. A single hard drive may therefore be subdivided into a number of unique drive partitions in order to make use of all of its space.

Because of the differences in the way that drive sizes are calculated, the size reported by the operating system may differ from that marked on the hard drive or listed in the computer specification. Drive size calculations by drive manufacturers are bytes to the base 10 while calculations by Microsoft are bytes to the base 2.

Drive/Partition Capacity Limits				
File System	Controller Type	Operating System	Maximum Size	
			Partition	Drive
FAT 32	ATA	Windows 2000/XP/Vista	32 GB	2 TB
NTFS	ATA	Windows 2000/XP/Vista	2 TB	2 TB

G Power Cord Set Requirements

The power supplies on some computers have external power switches. The voltage select switch feature on the computer permits it to operate from any line voltage between 100-120 or 220-240 volts AC. Power supplies on those computers that do not have external power switches are equipped with internal switches that sense the incoming voltage and automatically switch to the proper voltage.

The power cord set received with the computer meets the requirements for use in the country where you purchased the equipment.

Power cord sets for use in other countries must meet the requirements of the country where you use the computer.

General Requirements

The requirements listed below are applicable to all countries:

1. The power cord must be approved by an acceptable accredited agency responsible for evaluation in the country where the power cord set will be installed.
2. The power cord set must have a minimum current capacity of 10A (7A Japan only) and a nominal voltage rating of 125 or 250 volts AC, as required by each country's power system.
3. The diameter of the wire must be a minimum of 0.75 mm₂ or 18AWG, and the length of the cord must be between 1.8 m (6 feet) and 3.6 m (12 feet).

The power cord should be routed so that it is not likely to be walked on or pinched by items placed upon it or against it. Particular attention should be paid to the plug, electrical outlet, and the point where the cord exits from the product.

⚠ **WARNING!** Do not operate this product with a damaged power cord set. If the power cord set is damaged in any manner, replace it immediately.

Japanese Power Cord Requirements

For use in Japan, use only the power cord received with this product.

⚠ **CAUTION:** Do not use the power cord received with this product on any other products.

Country-Specific Requirements

Additional requirements specific to a country are shown in parentheses and explained below.

Country	Accrediting Agency	Country	Accrediting Agency
Australia (1)	EANSW	Italy (1)	IMQ
Austria (1)	OVE	Japan (3)	METI
Belgium (1)	CEBC	Norway (1)	NEMKO
Canada (2)	CSA	Sweden (1)	SEMKO
Denmark (1)	DEMKO	Switzerland (1)	SEV
Finland (1)	SETI	United Kingdom (1)	BSI
France (1)	UTE	United States (2)	UL
Germany (1)	VDE		

1. The flexible cord must be Type HO5VV-F, 3-conductor, 0.75mm² conductor size. Power cord set fittings (appliance coupler and wall plug) must bear the certification mark of the agency responsible for evaluation in the country where it will be used.
2. The flexible cord must be Type SVT or equivalent, No. 18 AWG, 3-conductor. The wall plug must be a two-pole grounding type with a NEMA 5-15P (15A, 125V) or NEMA 6-15P (15A, 250V) configuration.
3. Appliance coupler, flexible cord, and wall plug must bear a "T" mark and registration number in accordance with the Japanese Dentori Law. Flexible cord must be Type VCT or VCTF, 3-conductor, 0.75 mm² conductor size. Wall plug must be a two-pole grounding type with a Japanese Industrial Standard C8303 (7A, 125V) configuration.

H Specifications

Table H-1 Specifications

Temperature Range		
Operating	50° to 95°F	10° to 35°C
Nonoperating	-22° to 140°F	-30° to 60°C
Relative Humidity (noncondensing)		
Operating	10-90%	10-90%
Nonoperating (38.7°C max wet bulb)	5-95%	5-95%
Maximum Altitude (unpressurized)		
Operating	10,000 ft	3048 m
Nonoperating	30,000 ft	9144 m
NOTE: Operating temperature is derated 1.0° C per 300 m (1000 ft) to 3000 m (10,000 ft) above sea level; no direct sustained sunlight. Maximum rate of change is 10° C/Hr. The upper limit may be limited by the type and number of options installed.		
Shock	The level of shock the product can withstand with no damage being incurred is 35 G peak input acceleration during an 11-millisecond trapezoidal shock pulse.	
Vibration	Random vibration (0.25 G nominal):	
Operating	<ul style="list-style-type: none"> • 5 Hz at 0.00025 G²/Hz • 10 Hz at 0.01 G²/Hz • 100 Hz at 0.01 G²/Hz 	
Non-operating	<ul style="list-style-type: none"> • 300Hz at 0.00001 G²/Hz <p>5 Hz to 500 Hz (0.2 G nominal)</p>	
NOTE: Listed are the levels of vibration the product can withstand with no damage being incurred. The values represent a flat random vibration input acceleration profile across the given frequency range.		

Table H-1 Specifications (continued)

Acoustic noise	LWAd = 43 dB	LWAd = 55 dB
	Desktop average LpAm = 32 dBA	Desktop average LpAm = 44 dBA

NOTE: Listed are the declared A-weighted sound power levels (LWAd) and declared average desktop seated operator position A-weighted sound pressure levels (LpAm) when the product is operating in a 23°C (73.4°F) ambient environment.

NOTE: Noise emissions were measured in accordance with ISO 7779 (ECMA 74) and declared in accordance with ISO 9296 (ECMA 109).

Index

Symbols/Numerics

24-pin power pin assignments 86
4-pin power pin assignments 84

A

access panel
 removal and replacement 5
audible codes 65
audio problems 79

B

battery
 disposal 97
 removal and replacement 48
beep codes 65
BIOS DIMM test 67
BIOS updates 70

C

cable connections 21
cable management 21
cable pinouts
 SATA data 98
cautions
 AC power 90
 cables 96
 cooling fan 95
 electrostatic discharge 90
 keyboard cleaning 95
 keyboard keys 95
CD-ROM or DVD problems 82
chassis, illustrated 1
cleaning
 computer 94
 mouse 95
 safety precautions 94
computer cleaning 94
connecting drive cables 23
connections
 system board 21

connector pin assignments 84
country power cord set
 requirements 101
Customer Support 72

D

diagnostics 65
DIMM test 67
disassembly preparation 4
drive connectors 24
drives
 connecting cables 23
 installing 23
 removal and replacement 23

E

electrostatic discharge (ESD)
 preventing damage 91
error codes
 beeps 65
 LEDs 66
ethernet
 BNC pin assignments 84
expansion card sockets 13
expansion slot cover
 replacing 18

F

fan
 power supply 95
 removal and replacement 35
front bezel
 removal and replacement 7
front I/O device
 removal and replacement 33
front panel problems 83

G

general problems 74
grounding methods 91

H

hard drive
 installing 31
 proper handling 96
 removing 28
 SATA characteristics 98
hard drive problems 76
headphone pin assignments 85
heat sink
 removal and
 replacement 36, 37
helpful hints 73
HP Insight Diagnostics 67

I

installing
 drive cables 23
 hard drive 31
 optical drive 27

K

keyboard
 cleaning 94
keyboard problems 79

L

LED codes 66
line-in audio pin assignments 85
line-out audio pin
 assignments 85

M

Media Card Reader problems 77
memory
 populating sockets 10
 removal and replacement 9
 specifications 9
memory problems 81
memory test 67
microphone pin assignments 85

- monitor
 - pin assignments 86
- monitor problems 78
- mouse
 - cleaning 95
- mouse problems 79
- MT
 - processor removal and replacement 40
- N**
- network problems 80
- O**
- operating guidelines 93
- optical drive
 - installing 27
 - removing 25
- optical drive problems 82
- overheating, prevention 93
- P**
- PCI Express card 13
- PCI Express pin assignments 87
- POST error messages 68
- power cord set requirements
 - country specific 101
- power problems 75
- power supply
 - fan 95
 - removal and replacement 41
- power switch/LED
 - removal and replacement 34
- preparation for disassembly 4
- problems
 - audio 79
 - CD-ROM or DVD 82
 - front panel 83
 - general 74
 - hard drive 76
 - keyboard 79
 - Media Card Reader 77
 - memory 81
 - monitor 78
 - mouse 79
 - network 80
 - power 75
- processor
 - MT removal and replacement 40
 - removal and replacement 38

- R**
- removal and replacement
 - access panel 5
 - battery 48
 - drives 23
 - fan 35
 - front bezel 7
 - front I/O device 33
 - heat sink 36, 37
 - memory 9
 - MT processor 40
 - power supply 41
 - power switch 34
 - processor 38
 - system board 47
- removing
 - hard drive 28
 - optical drive 25
- S**
- safety and comfort 72
- safety precautions
 - cleaning 94
- SATA
 - connectors on system board 98
 - data cable pinouts 98
 - hard drive characteristics 98
- screws, correct size 96
- SDRAM (synchronous dynamic random access memory) 9
- service considerations 95
- software
 - servicing computer 96
- spare part number
 - tamper-resistant wrench 96
 - Torx T-15 screwdriver 96
- specifications
 - computer 102
 - memory 9
- static electricity 90
- system board
 - removal and replacement 47
 - SATA connectors 98
- system board drive connections 24

- T**
- tamper-proof screws
 - tool 96

- temperature control 93
- tools, servicing 96
- Torx T15 screwdriver 96

- U**
- updating BIOS 70
- USB pin assignments 84

- V**
- ventilation, proper 93

Free Manuals Download Website

<http://myh66.com>

<http://usermanuals.us>

<http://www.somanuals.com>

<http://www.4manuals.cc>

<http://www.manual-lib.com>

<http://www.404manual.com>

<http://www.luxmanual.com>

<http://aubethermostatmanual.com>

Golf course search by state

<http://golfingnear.com>

Email search by domain

<http://emailbydomain.com>

Auto manuals search

<http://auto.somanuals.com>

TV manuals search

<http://tv.somanuals.com>