

# 1

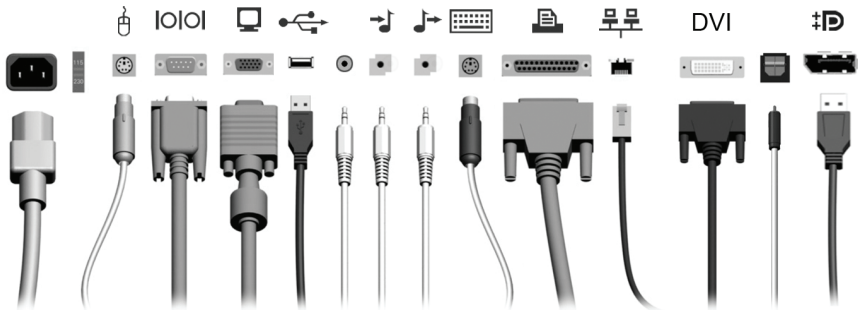

# 2



# 3

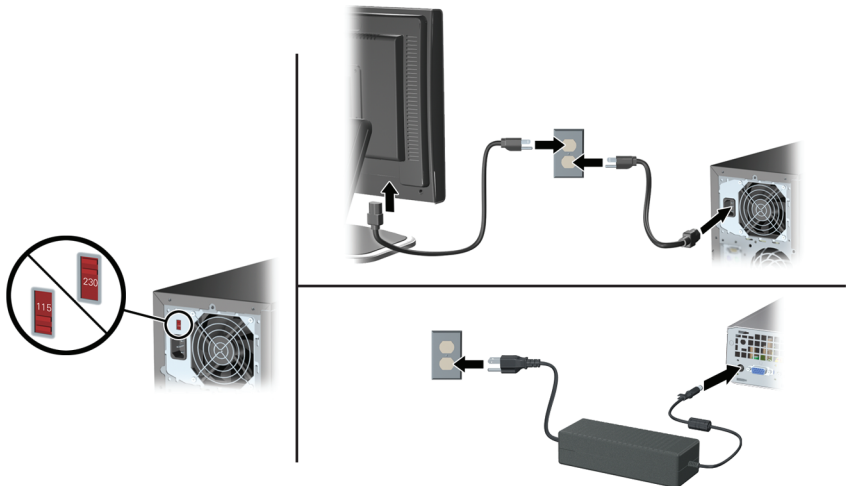

4

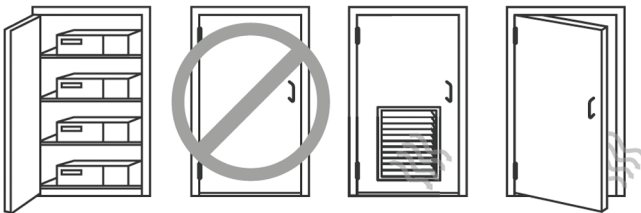
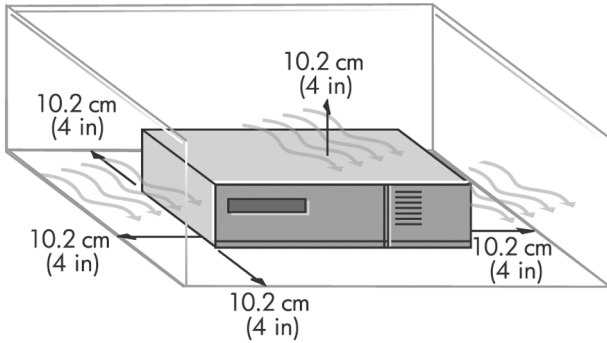

# Quick Setup & Getting Started

HP Business PCs and Personal  
Workstations

© Copyright 2009 Hewlett-Packard Development Company, L.P. The information contained herein is subject to change without notice.

Microsoft, Windows, Windows Vista, and Windows 7 are either trademarks or registered trademarks of Microsoft Corporation in the United States and/or other countries.

The only warranties for HP products and services are set forth in the express warranty statements accompanying such products and services. Nothing herein should be construed as constituting an additional warranty. HP shall not be liable for technical or editorial errors or omissions contained herein.

This document contains proprietary information that is protected by copyright. No part of this document may be photocopied, reproduced, or translated to another language without the prior written consent of Hewlett-Packard Company.

Quick Setup & Getting Started



HP Business PCs and Personal Workstations

Second Edition (November 2009)

Document Part Number: 581003-002

## About This Book

---

-  **WARNING!** Text set off in this manner indicates that failure to follow directions could result in bodily harm or loss of life.
  -  **CAUTION:** Text set off in this manner indicates that failure to follow directions could result in damage to equipment or loss of information.
  -  **NOTE:** Text set off in this manner provides important supplemental information.
- 

### Accessing User Guides and HP Diagnostics (Windows systems)

The menu and books are displayed in the language chosen during initial system setup or as specified later in the Windows Regional Settings. If the Regional Settings do not match one of the supported languages, the menu and books are displayed in English.

To access HP user guides:

- ▲ Select **Start > All Programs > HP User Manuals**.

To access Hewlett-Packard Vision Diagnostics:

- ▲ Refer to *Accessing Hewlett-Packard Vision Diagnostics* in this guide.

To access the *Safety and Comfort Guide*:

- ▲ Select **Start > All Programs > HP Safety and Comfort Guide**.

### Accessing User Guides (Linux systems)

Locate the desktop icon labeled HP User Manuals and double-click. Select the folder for your language. Select the guide you wish to access.

### How to Check Warranty and Support Entitlement

Your warranty is available on the hard drive (some models). To access your warranty:

- ▲ Select **Start > All Programs > Warranty**

You may check your warranty entitlement by entering your product model number and serial number at:

<http://www.hp.com/support/warranty-lookuptool>

HP Care Pack Services registration can be checked at:

<http://www.hp.com/go/lookuptool/>



---

# Table of contents

## Quick Setup & Getting Started

Installing and Customizing the Software .....	1
Installing the Windows Operating System .....	1
Downloading Microsoft Windows Updates .....	1
Installing or Upgrading Device Drivers (Windows systems) .....	2
Customizing the Monitor Display (Windows systems) .....	2
Launching Windows XP from Windows 7 .....	2
Accessing Disk Image (ISO) Files .....	2
Setting up Red Hat Enterprise Linux (HP Workstations only) .....	3
Installing with the HP Driver CD .....	3
Installing and Customizing Red Hat-enabled Workstations .....	3
Verifying Hardware Compatibility .....	3
Setting up Novell SLED (HP Workstations only) .....	3
Protecting the Software .....	4
Hewlett-Packard Vision Diagnostics (Windows systems) .....	4
Accessing HP Vision Diagnostics (Windows systems) .....	4
Downloading the Latest Version of HP Vision Diagnostics .....	5
Turning Off the Computer .....	5
Finding More Information .....	6
Before You Call for Technical Support .....	6
Helpful Hints .....	8
Basic Troubleshooting .....	9
Interpreting POST Diagnostic Front Panel LEDs and Audible Codes .....	9
Using, Updating, and Maintaining Your PC (Windows 7 Systems) .....	9







---

# Quick Setup & Getting Started

## Installing and Customizing the Software

If your computer was not shipped with a Microsoft operating system, some portions of this documentation do not apply. Additional information is available in online help after you install the operating system.

 **NOTE:** If the computer was shipped with Windows Vista or Windows 7 loaded, you will be prompted to register the computer with HP Total Care before installing the operating system. You will see a brief movie followed by an online registration form. Fill out the form, click the **Begin** button, and follow the instructions on the screen.

 **CAUTION:** Do not add optional hardware or third-party devices to the computer until the operating system is successfully installed. Doing so may cause errors and prevent the operating system from installing properly.

 **NOTE:** Be sure there is a 10.2-cm (4-inch) clearance at the back of the unit and above the monitor to permit the required airflow.

---

## Installing the Windows Operating System

The first time you turn on the computer, the operating system is installed automatically. This process takes about 5 to 10 minutes, depending on which operating system is being installed. Carefully read and follow the instructions on the screen to complete the installation.

 **CAUTION:** Once the automatic installation has begun, **DO NOT TURN OFF THE COMPUTER UNTIL THE PROCESS IS COMPLETE.** Turning off the computer during the installation process may damage the software that runs the computer or prevent its proper installation.

 **NOTE:** If the computer shipped with more than one operating system language on the hard drive, the installation process could take up to 60 minutes.

---

If your computer was not shipped with a Microsoft operating system, some portions of this documentation do not apply. Additional information is available in online help after you install the operating system.

## Downloading Microsoft Windows Updates

1. To set up your Internet connection, click **Start > Internet Explorer** and follow the instructions on the screen.
2. Once an Internet connection has been established, click the **Start** button.
3. Select the **All Programs** menu.
4. Click on the **Windows Update** link.

In Windows Vista and Windows 7, the **Windows Update** screen appears. Click **view available updates** and make sure all critical updates are selected. Click the **Install** button and follow the instructions on the screen.

In Windows XP, you will be directed to the **Microsoft Windows Update Web site**. If you see one or more pop-up windows that ask you to install a program from <http://www.microsoft.com>, click **Yes** to install the program. Follow the instructions on the Microsoft Web site to scan for updates and install critical updates and service packs.

It is recommended that you install all of the critical updates and service packs.

5. After the updates have been installed, Windows will prompt you to reboot the machine. Be sure to save any files or documents that you may have open before rebooting. Then select **Yes** to reboot the machine.

## Installing or Upgrading Device Drivers (Windows systems)

When installing optional hardware devices after the operating system installation is complete, you must also install the drivers for each of the devices.

If prompted for the i386 directory, replace the path specification with `C:\i386`, or use the **Browse** button in the dialog box to locate the i386 folder. This action points the operating system to the appropriate drivers.

Obtain the latest support software, including support software for the operating system from <http://www.hp.com/support>. Select your country and language, select **Download drivers and software (and firmware)**, enter the model number of the computer, and press **Enter**.

## Customizing the Monitor Display (Windows systems)

If you wish, you can select or change the monitor model, refresh rates, screen resolution, color settings, font sizes, and power management settings. To do so, right-click on the Windows Desktop, then click **Personalize** in Windows Vista and Windows 7 or **Properties** in Windows XP to change display settings. For more information, refer to the online documentation provided with the graphics controller utility or the documentation that came with your monitor.

## Launching Windows XP from Windows 7

Windows XP Mode for Windows 7 allows you to install and launch Windows XP applications from the Windows 7 taskbar. This feature is available on some computer models only.

To set up from a pre-installed Windows 7 desktop, click **Start > Windows Virtual PC > Virtual Windows XP** and follow the instructions on the screen.

## Accessing Disk Image (ISO) Files

There are disk image files (ISO files) included on your PC that contain the installation software for additional software. These CD image files are located in the folder `C:\SWSetup\ISOs`. Each .iso file can be burned to CD media to create an installation CD. It is recommended that these disks be created and the software

installed in order to get the most from your PC. The software and image file names are:

- Corel WinDVD SD and BD – installation software for WinDVD – used to play DVD movies
- HP Insight Diagnostics OR Vision Diagnostics – software to perform diagnostic activities on your PC

## Setting up Red Hat Enterprise Linux (HP Workstations only)

HP offers an HP Installer Kit for Linux (HPIKL) to supplement Red Hat box sets and help HP Linux customers customize their system image. The HPIKL contains the HP driver CD and device drivers to successfully setup up the Red Hat Enterprise Linux (RHEL) operating system, The HP Installer Kit for Linux CDs are currently available for download at [http://www.hp.com/support/workstation\\_swdrivers](http://www.hp.com/support/workstation_swdrivers).

### Installing with the HP Driver CD

To install the HP driver CD, see “Installing with the HP Installer Kit for Linux” in the HP Workstations for Linux manual at [http://www.hp.com/support/workstation\\_manuels](http://www.hp.com/support/workstation_manuels).

### Installing and Customizing Red Hat-enabled Workstations

Linux-enabled workstations require the HP Installer Kit and the purchase of a Red Hat Enterprise Linux box set. The Installer kit includes the HP CDs necessary to complete the installation of all versions of the Red Hat Enterprise Linux box set that have been qualified to work on an HP workstation.

To use the drivers in the HP Installer kit for Linux other than RHEL, you must manually extract the drivers from the HP Driver CD and install them. HP does not test the installation of these drivers on other Linux distributions nor does HP support this operation.

### Verifying Hardware Compatibility

To see which Linux versions have been qualified to work on HP Workstations visit [http://www.hp.com/support/linux\\_hardware\\_matrix](http://www.hp.com/support/linux_hardware_matrix).

## Setting up Novell SLED (HP Workstations only)

To set up the SUSE Linux Enterprise Desktop (SLED) on systems preloaded with the operating system:

1. Boot the workstation.
2. Start the Installation Settings and enter the password, network, graphics, time, keyboard settings, and Novell Customer Center Configuration for the workstation.



**NOTE:** During Installation Settings after the first time after booting the system the Novell subscription can be activated from the Novell Customer Center Configuration screen. Visit the full Novell Customer Center documentation at <http://www.novell.com/documentation/ncc/>.

## Protecting the Software

To protect the software from loss or damage, keep a backup copy of all system software, applications, and related files stored on the hard drive. Refer to the operating system or backup utility documentation for instructions on making backup copies of your data files.

If you cannot create system recovery CDs or DVDs, you can order a recovery disk set from the HP support center. To obtain the support center telephone number for your region see <http://www.hp.com/support/contactHP>.

## Hewlett-Packard Vision Diagnostics (Windows systems)



**NOTE:** HP Vision Diagnostics is included on CD with some computer models only.

The Hewlett-Packard Vision Diagnostics utility allows you to view information about the hardware configuration of the computer and perform hardware diagnostic tests on the subsystems of the computer. The utility simplifies the process of effectively identifying, diagnosing, and isolating hardware issues.

The Survey tab is displayed when you invoke HP Vision Diagnostics. This tab shows the current configuration of the computer. From the Survey tab, there is access to several categories of information about the computer. Other tabs provide additional information, including diagnostic test options and test results. The information in each screen of the utility can be saved as an html file and stored on a diskette or USB flash drive.

Use HP Vision Diagnostics to determine if all the devices installed on the computer are recognized by the system and functioning properly. Running tests is optional but recommended after installing or connecting a new device.

You should run tests, save the test results, and print them so that you have printed reports available before placing a call to the Customer Support Center.



**NOTE:** Third party devices may not be detected by HP Vision Diagnostics.

## Accessing HP Vision Diagnostics (Windows systems)

To access HP Vision Diagnostics, you must burn the utility onto a CD or copy it onto a USB flash drive then boot to the CD or USB flash drive. It can also be downloaded from <http://www.hp.com> and either burned to CD or installed to a USB flash drive. See [Downloading the Latest Version of HP Vision Diagnostics on page 5](#) for more information.



**NOTE:** HP Vision Diagnostics is included with some computer models only.

If you have already downloaded HP Vision Diagnostics to either a CD or USB Flash drive, then begin the following procedure at step 2.

1. In Windows Explorer, go to **C:\SWSetup\ISOs** and burn the file **Vision Diagnostics.ISO** to a CD or copy it to a USB flash drive.
2. While the computer is on, insert the CD in the Optical Drive or USB flash drive in a USB port on the computer.
3. Shut down the operating system and turn off the computer.
4. Turn on the computer. The system will boot into HP Vision Diagnostics.

---

 **NOTE:** If the system does not boot to the CD in the optical drive or to the USB flash drive, you may need to change the boot order in the Computer Setup (F10) utility. Refer to the *Maintenance and Service Guide* (English only) for more information.

---
5. At the boot menu, select either the **HP Vision Diagnostics** utility to test the various hardware components in the computer or the **HP Memory Test** utility to test memory only.

---

 **NOTE:** The HP Memory Test is a comprehensive memory diagnostic utility that is run as a stand-alone application, outside of HP Vision Diagnostics.

---
6. If running **HP Vision Diagnostics**, select the appropriate language and click **Continue**.
7. In the End User License Agreement page, select **Agree** if you agree with the terms. The HP Vision Diagnostics utility launches with the Survey tab displayed.

## Downloading the Latest Version of HP Vision Diagnostics

1. Go to <http://www.hp.com>.
2. Click the **Support & Drivers** link.
3. Select **Download drivers and software (and firmware)**.
4. Enter your product name in the text box and press the **Enter** key.
5. Select your specific computer model.
6. Select your OS.
7. Click the **Diagnostic** link.
8. Click the **Hewlett-Packard Vision Diagnostics** link.
9. Click the **Download** button.

 **NOTE:** The download includes instructions on how to create the bootable CD or the bootable USB flash drive.

---

## Turning Off the Computer

To properly turn off the computer, first shut down the operating system software. In Windows Vista, click **Start**, click the arrow on the lower right corner of the Start menu, then select **Shut Down**. The computer automatically shuts down. In Windows 7 and Windows XP Professional, click **Start > Shut Down**. In Windows

XP Home, click **Start > Turn Off Computer**. In Linux systems, click **Computer > Shut Down**.

Depending on the operating system, pressing the power button may cause the computer to enter a low-power or “standby” state instead of automatically turning the power off. This allows you to conserve energy without closing software applications; later, you can start using the computer immediately without having to restart the operating system and without losing any data.

 **CAUTION:** Manually forcing the computer off will cause the loss of any unsaved data.

To force the computer off manually and bypass the “standby state,” press and hold the power button for four seconds.

On some models, you can reconfigure the power button to work in On/Off mode by running Computer Setup. Refer to the *Maintenance and Service Guide* (English only) for more information about using the Computer Setup utility.

## Finding More Information

The following publications are available on the computer hard drive. To access the publications, select **Start > All Programs > HP User Manuals**.



**NOTE:** Not all of the publications listed are included on all models.

- *Quick Setup & Getting Started*—Helps you connect the computer and peripheral devices and set up factory-provided software; also includes basic troubleshooting information should you encounter any problems during initial startup.
- *Hardware Reference Guide*—Provides an overview of the product hardware, as well as instructions for upgrading this series of computers; includes information on RTC batteries, memory, and power supply.
- *Maintenance and Service Guide* (English only)—Provides information on parts removal and replacement, troubleshooting, Desktop Management, setup utilities, safety, routine care, connector pin assignments, POST error messages, diagnostic indicator lights and error codes.
- *Safety & Regulatory Information Guide*—Provides safety and regulatory information that ensures compliance with U.S., Canadian, and various international regulations.

## Before You Call for Technical Support

 **WARNING!** When the computer is plugged into an AC power source, voltage is always applied to the system board. To reduce the risk of personal injury from electrical shock and/or hot surfaces, be sure to disconnect the power cord from the wall outlet and allow the internal system components to cool before touching.

If you are having problems with the computer, try the appropriate solutions below to try to isolate the exact problem before calling for technical support.

- Run the diagnostics utility. Refer to [Hewlett-Packard Vision Diagnostics \(Windows systems\) on page 4](#) for more information.
- Run the Drive Protection System (DPS) Self-Test in Computer Setup. Refer to the *Maintenance and Service Guide* (English only) for more information.



**NOTE:** The Drive Protection System (DPS) Self-Test software is available on some models only.

- Check the power LED on the front of the computer to see if it is flashing red. The flashing lights are error codes that will help you diagnose the problem. Refer to the *Maintenance and Service Guide* (English only) for details.
- If the screen is blank, plug the monitor into a different video port on the computer if one is available. Or, change out the monitor with a monitor that you know is functioning properly.
- If you are working on a network, plug another computer with a different cable into the network connection. There may be a problem with the network plug or cable.
- If you recently added new hardware, remove the hardware and see if the computer functions properly.
- If you recently installed new software, uninstall the software and see if the computer functions properly.
- Boot the computer to the Safe Mode to see if it will boot without all of the drivers loaded. When booting the operating system, use “Last Known Configuration.”
- Refer to the comprehensive online technical support at <http://www.hp.com/support>.
- Refer to [Helpful Hints on page 8](#) in this guide for more general suggestions.
- Refer to the comprehensive *Maintenance and Service Guide* (English only) for more detailed information.

To assist you in resolving problems online, HP Instant Support Professional Edition provides you with self-solve diagnostics. If you need to contact HP support, use HP Instant Support Professional Edition’s online chat feature. Access HP Instant Support Professional Edition at: <http://www.hp.com/go/ispe>.

Access the Business Support Center (BSC) at <http://www.hp.com/go/bizsupport> for the latest online support information, software and drivers, proactive notification, and worldwide community of peers and HP experts.

If it becomes necessary to call for technical assistance, be prepared to do the following to ensure that your service call is handled properly:

- Be in front of your computer when you call.
- Write down the computer serial number and product ID number, and the monitor serial number before calling.
- Spend time troubleshooting the problem with the service technician.

- Remove any hardware that was recently added to your system.
- Remove any software that was recently installed.



**NOTE:** For sales information and warranty upgrades (HP Care Pack), call your local authorized service provider or dealer.

---

## Helpful Hints

If you encounter problems with the computer, monitor, or software, see the following list of general suggestions before taking further action:

- Check that the computer and monitor are plugged into a working electrical outlet.
- Check to see that the voltage select switch (some models) is set to the appropriate voltage for your region (115V or 230V).
- Check to see that the computer is turned on and the green power light is on.
- Check to see that the monitor is turned on and the green monitor light is on.
- Check the Power LED on the front of the computer to see if it is flashing. The flashing lights are error codes that will help you diagnose the problem. Refer to the *Maintenance and Service Guide* (English only) for details.
- Turn up the brightness and contrast controls of the monitor if the monitor is dim.
- Press and hold any key. If the system beeps, then the keyboard should be operating correctly.
- Check all cable connections for loose connections or incorrect connections.
- Wake the computer by pressing any key on the keyboard or pressing the power button. If the system remains in suspend mode, shut down the computer by pressing and holding the power button for at least four seconds. Then press the power button again to restart the computer. If the system will not shut down, unplug the power cord, wait a few seconds, then plug it in again. The computer will restart if automatic start on power loss is set in Computer Setup. If it does not restart, press the power button to start the computer.
- Reconfigure your computer after installing a non–plug and play expansion board or other option.
- Be sure that all the needed device drivers have been installed. For example, if you are using a printer, you need a driver for that model printer.
- Remove all bootable media (diskette, CD, or USB device) from the system before turning it on.
- If you have installed an operating system other than the factory-installed operating system, check to be sure that it is supported on the system.
- If the system has multiple video sources (embedded, PCI, or PCI-Express adapters) installed (embedded video on some models only) and a single monitor, the monitor must be plugged into the monitor connector on the source



selected as the primary VGA adapter. During boot, the other monitor connectors are disabled and if the monitor is connected into these ports, the monitor will not function. You can select which source will be the default VGA source in Computer Setup.

△ **CAUTION:** When the computer is plugged into an AC power source, there is always voltage applied to the system board. You must disconnect the power cord from the power source before opening the computer to prevent system board or component damage.

## Basic Troubleshooting

You can find troubleshooting information in the comprehensive *Maintenance and Service Guide* (English only) available under the reference library at <http://www.hp.com/support>. Select your country and language, select **See support and troubleshooting information**, enter the model number of the computer, and press **Enter**.

## Interpreting POST Diagnostic Front Panel LEDs and Audible Codes

If you see flashing LEDs on the front of the computer or if you hear beeps, see the *Maintenance and Service Guide* (English only) for interpretation and recommended action.

## Using, Updating, and Maintaining Your PC (Windows 7 Systems)

Systems with Windows 7 provide a centralized location to easily manage your PC, including the following:

- View or change your computer name and other system settings
- Add a device or printer and change other system settings
- Get help and support for your specific model
- Install HP support software for your computer
- Purchase supplies and accessories for your computer

To access the centralized PC management location, click **Start > Devices and Printers** then double-click on the picture of your PC.



## Free Manuals Download Website

<http://myh66.com>

<http://usermanuals.us>

<http://www.somanuals.com>

<http://www.4manuals.cc>

<http://www.manual-lib.com>

<http://www.404manual.com>

<http://www.luxmanual.com>

<http://aubethermostatmanual.com>

Golf course search by state

<http://golfingnear.com>

Email search by domain

<http://emailbydomain.com>

Auto manuals search

<http://auto.somanuals.com>

TV manuals search

<http://tv.somanuals.com>