

Getting Started Guide

The only warranties for Hewlett-Packard products and services are set forth in the express statements accompanying such products and services. Nothing herein should be construed as constituting an additional warranty. HP shall not be liable for technical or editorial errors or omissions contained herein.

HP assumes no responsibility for the use or reliability of its software on equipment that is not furnished by HP.

This document contains proprietary information that is protected by copyright. No part of this document may be photocopied, reproduced, or translated to another language without the prior written consent of HP.

Hewlett-Packard Company
P.O. Box 4010
Cupertino, CA 95015-4010
USA

Copyright © 2000–2006 Hewlett-Packard Development Company, L.P.

May be licensed in the United States by one or both of U.S. Patents Nos. 4,930,158 and 4,930,160 until August 28, 2008.

Microsoft and Windows are U.S. registered trademarks of Microsoft Corporation.

HP supports lawful use of technology and does not endorse or encourage the use of our products for purposes other than those permitted by copyright law.

The information in this document is subject to change without notice.

Table of Contents

Setting Up Your PC	1
Putting Your PC Together	1
Placing your PC in the proper location	1
Using surge protection	1
Connecting to the PC	2
Storing documentation and recovery discs	4
Turning On Your PC for the First Time	4
Setting Up and Connecting to the Internet.....	5
Configuring and Registering Norton Internet Security Software.....	6
Using the PC with Safety and Comfort.....	7
Signing Up for Software Updates	7
Setting Up Accounts on Your New PC.....	8
Creating user accounts	8
Creating passwords	9
Guidelines for Installing Software and Hardware Devices.....	9
Using HP and Compaq Products.....	10
Transferring Files and Settings from Your Old PC to Your New PC.....	10
Using HP Organize or Compaq Organize Software	10
Using the Keyboard	11
Customizing the keyboard buttons	13
Using Your PC Top	15
Using Your Docking Bay.....	15

Configuring Speaker and Sound Options.....	19
Step 1: Connecting the speakers	19
Sound connector types	19
Speaker configurations	22
Speaker types	23
Connecting 2.1 (2 speakers and a subwoofer) audio speakers	23
Connecting 4.1 (4 speakers and a subwoofer) audio speakers	24
Connecting 5.1 (5 speakers and a subwoofer) audio speakers	25
Connecting 7.1 (7 speakers and a subwoofer) audio speakers	27
Connecting the PC to a home audio system	29
2 or 2.1 home stereo installation	30
5.1 (5 speakers and a subwoofer) home audio installation	31
5.1 (5 speakers and a subwoofer) home audio installation procedure.....	32
Connecting digital audio	33
Step 2: Configuring the Sound Software	34
Configuring audio output with Multi-channel Sound Manager	35
Configuring audio output with Sound Effect Manager	37
Configuring audio output with Realtek HD Sound Effect Manager.....	39
Configuring multistreaming audio	41
Step 3: Configuring Sound for the Media Software Program	43
Selecting Recording Devices	44
Resolving Sound Issues.....	44
Configuring the Creative Sound Blaster X-Fi Sound Card (Select Models Only)	45
Connecting the Speakers.....	45
Configuring the sound card software	46
Configuring the FlexiJack connector	46
Recording with the sound card	47
Sound Blaster X-Fi configuration modes	47
More Information	48
Using the Memory Card Reader	49
Using the Memory Card Reader	50
Media Insertion Guide	51
Using the HP Personal Media Drive	53
Connecting the Drive	54
Inserting the Drive	55
Locating the Drive and Assigning a Drive Letter.....	56
Using the Drive	57
Disconnecting the Drive.....	58

Working with Digital Images.....	59
Using HP Photosmart Premier	60
Playing CDs and DVDs	63
Playing Music CDs	63
Playing DVDs.....	63
Using country/region codes.....	64
Playing CDs and DVDs with Windows Media Player	64
Playing Video CDs (VCDs).....	65
Playing Video CDs (VCDs) with Windows Media Player.....	65
Creating Audio and Data Discs	67
Erasing Rewritable Discs Before Recording	68
Working with Audio CDs	68
Verifying audio disc recorded without errors	69
Audio CD tips	69
Creating audio CDs	70
Creating jukebox discs	70
Working with Data DVDs and CDs.....	71
Verifying data disc recorded without errors.....	71
Data disc tips	71
Creating data discs.....	72
Copying a DVD or CD	73
Archiving Files on a CD or DVD	73
Working with Image Files.....	74
Creating an image file	74
Burning from an image file	74
Disc Labeling with LightScribe	75
LightScribe requirements.....	75
Burning a LightScribe label with Sonic Express Labeler	75
Using adhesive disc labels.....	76
Compatibility Information	76
Disc Features and Compatibility Table	77
Optical Drive Quick Reference Table	78
Software Quick Reference Table.....	79

Creating Video Discs and Movies.....	81
Before You Begin Capturing Video	81
Sonic MyDVD Video Projects	82
Creating a Video Project	82
Adding files to a video project	83
Capturing video to a video project	83
Adding slideshows to a video project	84
Adding submenus to a video project.....	84
Editing the style of a video project.....	85
Editing movie files	85
Burning a video project to disc.....	86
Creating a Video Project with the Direct-to-Disc Wizards.....	87
Video Quality and Disc Size.....	88
DVD Recording Time	89
Creating Movies Using muvee autoProducer	91
Basic Steps to Make a Movie.....	91
Locating muvee autoProducer.....	92
Using muvee autoProducer	93
Getting started	93
Capturing video from a DV camcorder.....	94
Adding videos	95
Adding pictures.....	97
Adding music	97
Selecting the style.....	98
Changing the settings	98
Adding an opening title and closing credits.....	99
Making the movie.....	100
Previewing the movie.....	100
Modify the movie	101
Saving the movie project.....	102
Recording the movie project to disc	103
Getting Help	105
Finding Onscreen Guides.....	105
Finding Guides on the Web	105
Using the Onscreen Help and Support Center.....	106
Using PC Help & Tools.....	106
Using Updates from HP (or Compaq Connections).....	106
Getting messages	107
Turning off messages	107
Reactivating messages	108
Index.....	109

Setting Up Your PC



WARNING: The power supply is preset for the country/region in which you purchased your PC. If you move, please check the voltage requirements before plugging your PC into an AC power outlet.



WARNING: Please read "Safety Information" in the *Warranty and Support Guide* before installing and connecting your PC to the electrical power system.

Putting Your PC Together

Follow the steps on the setup poster to set up your PC.

Look in the PC box for printed details or updates regarding your model PC.

Placing your PC in the proper location

When setting up your new PC, place it where ventilation openings are unobstructed. Make sure all connections are secure and all cabling is out of the way of walkways and will not be stepped on or run over by furniture.

Using surge protection









Help protect your monitor, PC, and accessories by connecting all power cords for your PC and peripheral devices (such as a monitor, printer, or scanner) to a surge-protection device such as a power strip with surge protection or uninterruptible power supply (UPS). Many surge protection devices have surge-protection inputs and outputs for modem/phone lines. Phone lines are a common path for lightning spikes to get into your system. Some surge protection devices have surge protection for television cable connections as well: Use those if your PC has a television tuner installed.





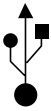
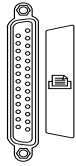

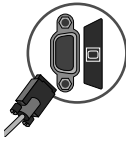

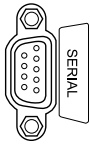





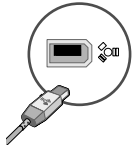

Not all power strips provide surge protection; the power strip must be specifically labeled as having this ability. Use a power strip whose manufacturer offers a damage replacement policy so you can replace your equipment if surge protection fails.

Connecting to the PC

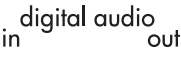
Connect your main hardware devices such as the monitor, keyboard, and mouse to the back of the PC. Other peripheral devices such as a printer, scanner, or camera also plug into connectors on the back of your computer. Some PC models also have connectors on the front of the PC. The table does not show all connectors.

NOTE: Your PC features and location, availability, and number of connectors may vary.

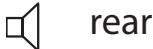
Connector	Connector symbol	Description
		Mouse (PS/2 connector)
		Keyboard (PS/2 connector)
		Universal Serial Bus (USB) for mouse, keyboard, digital cameras, or other devices with USB connectors
		Printer (parallel)
		Monitor
	Serial	Serial port for some digital cameras or other serial devices

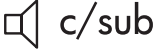
Connector	Connector symbol	Description
		Audio Line Out (powered speakers)
		Audio Line In
		Headphones
		Microphone
		FireWire® (IEEE 1394) for video cameras or other devices with very fast transfer rates
		Digital audio in and digital audio out
		Side speaker out
		Rear speaker out
		Center/subwoofer

Storing documentation and recovery discs

Store all PC user manuals and warranty information in an easy-to-find, safe location. It is a good idea to store your system recovery discs with your documentation. This will allow easy access to all important PC documents and files in one place.

Turning On Your PC for the First Time

After you have completed the steps on the quick setup poster, you are ready to turn on your PC.

- 1** Press the Power button on the monitor.
- 2** Press the On button on the front of the PC.
- 3** Turn on the speakers, if they are present.
- 4** Click an option to select your language (if applicable for your model). Click **OK**, and then confirm your selection by clicking **Yes**. Wait until the PC makes preparations. (It may take up to 30 minutes for this one-time language setup on the PC.)
- 5** Set up Microsoft® Windows® by following the onscreen instructions.
- 6** (Select models only) Follow the Easy Internet Sign-up or Internet Services wizard to set up an Internet connection. If you do not wish to set up an Internet connection at this time, Easy Internet Sign-up or Internet Services can be manually started at a later time. See "Setting Up and Connecting to the Internet" on page 5.
- 7** (Select models only) Follow the Easy Setup wizard to update the PC security tools, register the PC and finish PC setup. If you decide to finish setup at a later time, the wizard can be started by double-clicking the **Easy Setup** icon on the desktop.

Setting Up and Connecting to the Internet

Requirements

- A PC.
- A dial-up modem or a cable or DSL modem for high-speed broadband connections. Contact your Internet service provider (ISP) for any specific software and hardware you may need.
- Internet service with an ISP.
- A Web browser.

To set up and connect to the Internet:

- 1** Make sure the modem or other Internet access cable is connected.
- 2** Sign up with an ISP. If you already have an account with an ISP, skip this step and follow the instructions provided by the ISP.

If Internet service was not set up during the initial setup of the PC, it can be set up now using the Easy Internet Sign-up or the Internet Services wizard (select models only).

Click **Start** on the taskbar, **All Programs**, **Online Services**, and **Easy Internet Sign-up** or **Internet Services**.

Follow the onscreen instructions to select an ISP and set up Internet service.

NOTE: Easy Internet Sign-up or Internet Services provides a list of Internet service providers; however, you may choose another ISP or transfer an existing account to this PC. To transfer existing accounts, follow the instructions provided by the ISP.

- 3** Connect to the Internet. You must connect through the ISP to connect to the Internet.
Double-click the ISP-provided icon on the desktop.
- 4** Open your Web browser and browse the Internet.
You can use any Web browser; most PCs have Internet Explorer. Click **Start**, **All Programs**, and **Internet Explorer**.

NOTE: If you have questions, contact the ISP directly.

Configuring and Registering Norton Internet Security Software

Norton Internet Security software is preinstalled on your PC and includes a complimentary 60-day subscription to protection updates. You can enable Symantec's LiveUpdate™ to obtain protection updates automatically whenever you are online.

When you first set up the PC, the Norton Internet Security Information Wizard helps you to configure and register your copy of Norton Internet Security.

Be sure to set up Norton Internet Security before you start surfing the Internet. Just click on the **Norton Internet Security** icon after you've established an Internet service account, and a wizard guides you through the simple setup process.

- 1** Double click the **Norton Internet Security** icon in the system tray to launch the Configuration Wizard. 
- 2** Click **Next** and follow the instructions to:
 - Complete registration.
 - Schedule post-installation tasks including running LiveUpdate™, scanning for viruses, and scheduling weekly scans of local hard drives.
- 3** On the Summary page, click **Finish**.

When registration and initial setup are finished, Norton Internet Security automatically begins the post-installation tasks you selected.

For information about using and updating the Norton Internet Security software, click **Start, All Programs, Norton Internet Security**, and then click **Help and Support**.

Using the PC with Safety and Comfort



WARNING: To reduce the risk of serious injury, read the *Safety & Comfort Guide*. It describes proper workstation setup, posture, and health and work habits for PC users. It also provides important electrical and mechanical safety information.

Before you begin using the PC, arrange the PC and your work area to maintain your comfort and productivity. Refer to the *Safety & Comfort Guide* for important ergonomic information:

- Click **Start**, choose **All Programs**, choose **User's Guides**, and then click **Safety & Comfort Guide**.

Or

- Type <http://www.hp.com/ergo> into your Web browser address box, and then press Enter on the keyboard.

Signing Up for Software Updates

Microsoft continually updates the Windows operating system. It is recommended that you check for, download, and install these updates at least monthly. Take advantage of the Automatic Updates feature, a convenient way to keep the operating system up to date. When you are connected to the Internet, Windows Update automatically notifies you through a pop-up message or icon in the notification area when critical updates are available. When you see the Windows Update message, allow the updates to download to the system. If you update the system weekly, or at least monthly, the time required for download is minimal.

To configure Automatic Updates:

Click **Start**, **Control Panel**, **Other Control Panel Options**, and then **Automatic Updates**.

In the Automatic Updates window, select the desired configuration:

- **Automatic** (recommended) — This is the default setting, and it allows you to specify a day and time to automatically download and install recommended updates.
- Download updates for me, but let me choose when to install them.
- Notify me but don't automatically download or install them.

The **Turn off Automatic Updates** option makes the PC more vulnerable and is not recommended.

Setting Up Accounts on Your New PC

User accounts allow you to set the privileges for each user of your PC. For example, you can set the software programs that each user is allowed to access. Follow the simple steps in this section when setting up your PC to create user accounts.

Creating user accounts

The information below describes the different account types in Windows XP and explains how to change account types.

Creating multiple user accounts on the same PC has certain advantages as well as some drawbacks.

- Advantages to multiple user accounts:
 - Ability to create individual user settings
 - Ability to limit access to software for certain users
- Drawbacks to multiple user accounts:
 - More memory (RAM) usage
 - Multiple Temporary Internet Files folders to remove during Disk Cleanup
 - More data to back up
 - Longer time to complete virus scan

Windows XP provides three types of user accounts:

- Administrative
Allowed to change account types for other users, change passwords, change system-wide settings, and install Windows XP-compatible software and drivers.
- Limited
Not allowed to change other user settings, or passwords. Limited account may not be able to install or run some software.
Allowed to change the limited account picture, and create, edit, or delete the account password.
- Guest
Not allowed to change other user settings or passwords.
Users who log on to the PC using the guest account do not have access to password-protected files, folders, and settings.

Creating passwords

Passwords help protect your PC and information from unauthorized access and help ensure that information on the PC stays private and secure. Use the following list as a basic guide when choosing your password:

- Choose a password that is easy for you to remember but difficult for others to guess.
- Choose a long password (minimum of 6 characters).
- Use a combination of upper and lower-case letters, numbers, and symbols.
- Don't use personal information that others can easily figure out, such as your birthday, child's name, or phone number.
- Don't write down your password.

Guidelines for Installing Software and Hardware Devices

After you set up the PC, you may wish to install additional software programs or hardware devices. Keep in mind these important guidelines:

- Before installation, make a restore point using the Microsoft System Restore program.
Click **Start, All Programs, PC Help & Tools**, and then **System Restore**.
The restore point is a snapshot of your PC configuration. By using System Restore, you ensure that you have a point to return to before an issue occurred. For information about System Restore, refer to the Microsoft Web site at:
<http://www.microsoft.com/worldwide>
- Choose software that is compatible with your PC — check the operating system, memory, and other requirements listed for the new software for compatibility with your PC.
- Install the new software according to the directions provided by the software manufacturer. Check the manufacturer's documentation or customer service information for help if you need it.
- For antivirus software, uninstall the existing software program before reinstalling it or installing a new antivirus program.

NOTE: Only use licensed original software. Installing copied software may be illegal, may result in an unstable installation, or may infect your PC with a virus.

Using HP and Compaq Products

HP and Compaq PCs include preloaded software for select HP All-In-One, camera, scanner, and printer peripheral products. Preloaded software simplifies and speeds product setup for HP peripherals. Simply connect the HP peripheral product, turn it on, and your HP or Compaq PC automatically configures it so it is ready to use.

Transferring Files and Settings from Your Old PC to Your New PC

You can copy the old PC files to the new PC using media such as CD or DVD discs, memory sticks, or personal media drives. You can also copy certain settings such as Web browser Favorites and address books using Microsoft's Files and Settings Transfer Wizard.

For more information click **Start, All Programs**, and then **Help and Support**.

Search for *transfer wizard*, and select the overview article, "Files and Settings Transfer Wizard overview." This information describes a Microsoft solution for moving your files onto your new PC.

Using HP Organize or Compaq Organize Software

HP (or Compaq) Organize software (select models only) is a desktop tool you use to organize both your PC shortcuts and your favorite Internet destination links. You use it to organize the important things you do on the PC and the Internet and to arrange them the way you want. HP (or Compaq) Organize makes all your information available with just a few mouse clicks.

HP (or Compaq) Organize looks like a window with multiple category frames. Each category has links to Internet destinations or shortcuts to software programs or files on your PC. Use the player area for viewing pictures, for listening to your MP3 music files stored on your PC, or for watching video clips. For searching, there is a search bar at the top of HP (or Compaq) Organize where you can select the search engine you want to use.

To open HP (or Compaq) Organize:

- 1 Click **Start** on the taskbar.
- 2 Choose **All Programs**.
- 3 Click **HP Organize** or **Compaq Organize**.





Using the Keyboard







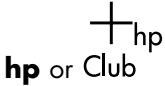

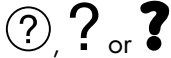
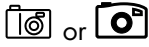
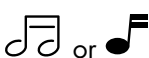



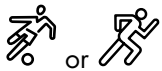
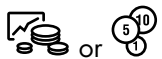

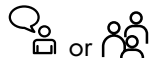
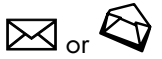
Your keyboard has an arrangement of standard keys, indicator lights, and special buttons (select models only).



Identifying Special Keyboard Buttons

There are special buttons (select models only) at the top of the keyboard. (Some models have some of these special buttons on the left side of the main keys.) These buttons operate a CD or DVD player, connect you to the Internet, or provide quick access to specific functions.

NOTE: The number, location, and labeling of buttons vary by keyboard model.

Icon	Feature	Description
	Standby	Puts PC into power-saving mode (screen is blank but PC is still on). To make the screen reappear, press the Esc key, or press Standby again. May take 10–30 seconds before the screen reappears.
	User	Switches between the PC users.
	HP	Links to an HP Web site.
	Compaq My Presario	Links to Compaq Web site.
	Help	Opens the Help and Support Center.
	Pictures (Photos)	Opens an imaging software program. Can be reconfigured.
	Music	Opens music software program. Can be reconfigured.

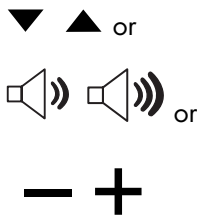
Icon	Feature	Description
	Video	Opens video software program. Can be reconfigured.
	Shopping	Goes to popular Web sites. Can be reconfigured to open a site or software program.
	Sports	
	Finance	
	Connect to Internet	
	Search	
	Chat	
	E-Mail	
	Entertainment	
	Offers	
	Calculator	
A  B  C  D  E  F 	Media controls (CD/DVD/MP3)	Operates a disc player. A Open and close disc tray B Record C Play or pause D Stop E Skip to the previous track F Skip to the next track

Icon	Feature	Description
	Volume control (Volume knob or Volume Up and Volume Down buttons)	Volume knob: Increases speaker volume when turned clockwise and decreases volume when turned counterclockwise. It can be turned indefinitely, even after maximum sound has been reached. Volume Up and Down buttons: Press the Volume Up button to increase volume and the Volume Down button to decrease volume.
	Mute	Turns speaker sound on and off.

NOTE: The number, location, and labeling of buttons vary by keyboard model.

Customizing the keyboard buttons

You can customize some of the special buttons on the keyboard (select models only) to open different programs or files or to connect to favorite Web sites:

- 1 Click **Start** on the taskbar.
- 2 Choose **Control Panel**.
- 3 Click **Printers and Other Hardware**, if it is present.
- 4 Double-click **Keyboard**.
- 5 On the Buttons tab, double-click the button you want to change.
- 6 For the Button configuration, click the **Down arrow** to the right of the list and choose the button capability, such as *Complex remote page with label* or *Simple local file with label*.
- 7 Enter a display label and the address information. For a Web page, enter the URL.
- 8 Click **OK**.
- 9 On the Buttons tab, click **Apply**.
- 10 Repeat steps 5 through 9 for each button you want to customize.
- 11 Click **OK** to finish.

NOTE: Clicking the **Restore Defaults** button on the Button tab restores all of the Internet buttons to the factory settings.



Using Your PC Top

Your PC may have a storage area or docking bay (select models only) on the top of the PC chassis.

Using Your Docking Bay

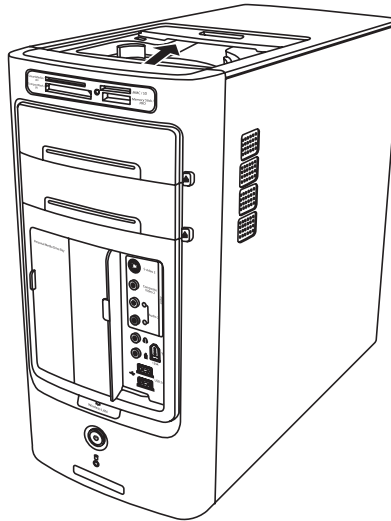

You can use the docking bay to:

- Store CDs, DVDs, or memory cards.
- Dock a peripheral device in the bay, such as a digital camera docking station.
- Install a special cover (optional) and an HP camera and HP camera docking station. (Both the camera and the docking station are sold separately.)

The bay design allows you to place a device and thread the USB or FireWire (IEEE 1394) data cable and the power cord underneath the rear top cover to the connectors on the back of the PC.

Your PC may look different from the one shown here. Components and location, availability, and number of connectors may vary.

To store CDs, DVDs, or memory cards:

Gently press down on the bay lid and slide it open.

To install a peripheral device or an HP camera and HP camera docking station:

- 1 Gently press down on the bay lid and slide it open.
- 2 Place the peripheral device or the camera docking station (**A**) on the top of the PC.

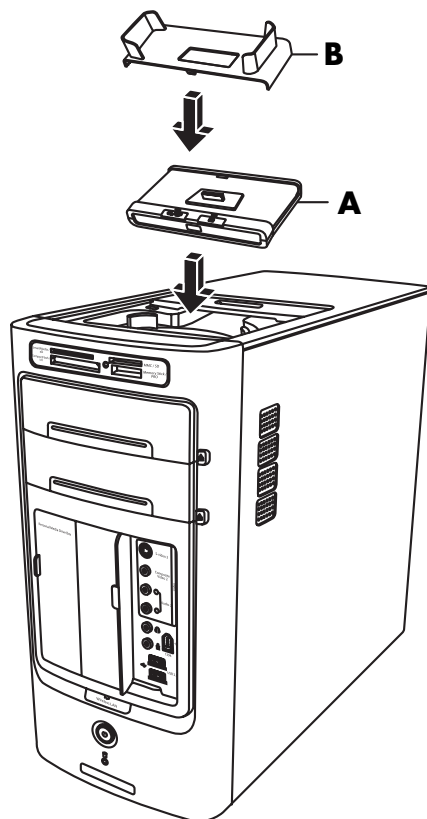

- 3 For a camera, place the camera cradle (**B**) that came with the digital camera on the camera docking station. The cradle clips onto the camera docking station.

- 4** Thread the cables that came with your peripheral devices or camera docking station through the cable tunnel (**C**). Starting from the back of the PC, thread them to the front of the PC. Pull the cables to the center and connect them to the peripheral or the docking station (**D**).

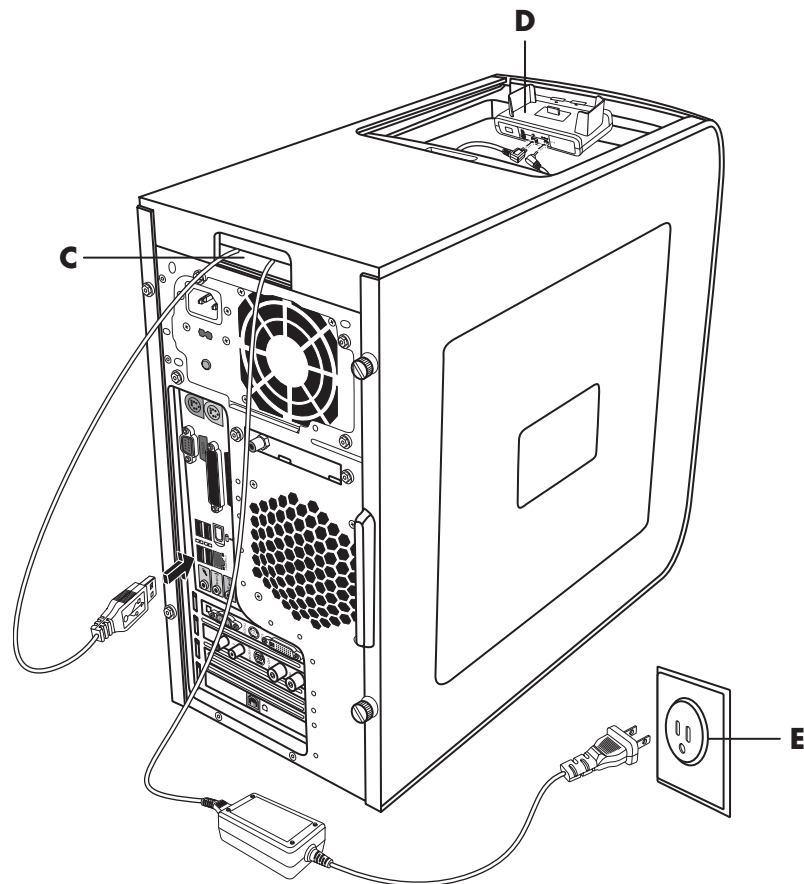

- 5** Connect the cables to the back of the PC or to a power outlet (**E**).
For a peripheral, refer to the instructions that came with your peripheral device.

For an HP camera docking station:

- Plug the USB cable into the back of the PC.
- Plug the power cord into a power outlet.

Optionally, if you want to view the camera images on a TV, plug the red and yellow connectors (not shown) into the TV.

Refer to the instructions that came with the HP camera docking station.

- 6 Place the correct camera docking station lid (**F**) on top of the PC. Gently guide the edge of the lid into the top of the PC.

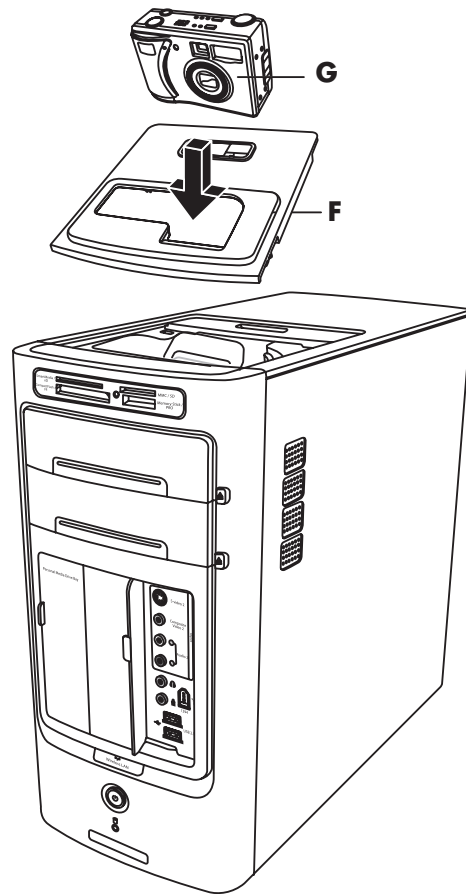

- 7 When you want to use it, place the HP digital camera (**G**) into the docking station.
- 8 Follow the instructions that came with your peripheral or docking station.

Configuring Speaker and Sound Options

There are three steps to setting up sound on the PC:

- 1** Connecting the speakers.
- 2** Configuring the sound software.
- 3** Configuring sound for the media software program.

Your PC supports many different audio options, sound connections, and speaker configurations. This chapter describes the most typical options. Your system may have different components.

NOTE: For additional information on connecting the speakers, refer to the setup poster that came with the PC and the documentation that came with your speakers.

Step 1: Connecting the speakers



Sound connector types

Your model may include one of three analog sound connector types on the back of your PC:

- Three connectors
- Six connectors
- Sound card

Your system may also have a separate Digital Out connection (select models only).

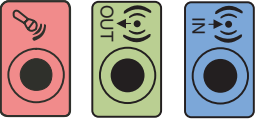
Software configuration is different for each connector type, as noted in the instructions.

Connector	Description	Illustration	Type
Three connectors	Your PC model may include three sound connectors. You can connect up to a 5.1 audio system to the PC. If you want to connect multichannel audio, follow the instructions carefully.		3
Six connectors	Your PC model may include six sound connectors on the back of your PC. You can connect up to a 7.1 audio system to the PC.		6
Sound card connector	Your PC may include a sound card. You can connect up to a 5.1 audio system (7.1 audio system for select models) or digital speakers to the sound card on the PC.	See below.	S

















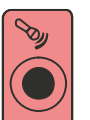

NOTE:

- Type 3 is three connectors
- Type 6 is six connectors
- Type S is a sound card connector

Use the sound connectors that match your PC model when installing cables, as shown in the installation procedure steps.

The following table shows the sound connectors on the back panel of PC systems.

Sound connector			Description
3	6	S	
			Line Side (gray) for side speakers in an eight-speaker system (7.1).
			Line C/Sub (gold) for center/subwoofer speakers in a multichannel audio configuration.
			Line Rear (black) for rear speakers in a multichannel audio configuration.
			Line Out (lime green) for front speakers.
			Mic (pink) connects to microphone. (Type 3 also functions as center/subwoofer Line Out when a multichannel audio configuration is activated.)
			Line In (light blue) connects to an analog audio device such as a CD player for input into PC. (Type 3 also functions as rear Line Out when a multichannel audio configuration is activated.)
			Digital Out (orange) connects to a digital audio device with digital input (such as a home audio receiver/amplifier) or digital speakers (select models only).

NOTE:

- Type 3 is three connectors
- Type 6 is six connectors
- Type S is a sound card connector

Speaker configurations

You may set up your PC for the following supported configurations:

Name	Speaker system	See
Headphones	None, muted.	
2 (stereo)	Left speaker, right speaker.	"Connecting 2.1 (2 speakers and a subwoofer) audio speakers" on page 23.
2.1	Left speaker, right speaker, and a subwoofer.	"Connecting 2.1 (2 speakers and a subwoofer) audio speakers" on page 23.
4.1	Two front speakers, two rear speakers, and a subwoofer.	"Connecting 4.1 (4 speakers and a subwoofer) audio speakers" on page 24.
6/5.1	Two front speakers, two rear speakers, a center speaker, and a subwoofer.	"Connecting 5.1 (5 speakers and a subwoofer) audio speakers" on page 25.
8/7.1	Two front speakers, two rear speakers, two side speakers, a center speaker, and a subwoofer (select models only).	"Connecting 7.1 (7 speakers and a subwoofer) audio speakers" on page 27.
Home audio system	Home stereo or home theater audio system with passive speakers.	"Connecting the PC to a home audio system" on page 29.
Digital audio	Digital speakers or digital input connector on audio system.	"Connecting digital audio" on page 33.
Multistreaming audio	Two front speakers, two rear speakers, two side speakers, a center speaker, and a subwoofer (select models only).	"Configuring multistreaming audio" on page 41.

Speaker types

Speakers may be included with the monitor (select models only) or sold separately. Refer to the product documentation for your speakers.

Your PC supports only an active (powered) speaker system. An active speaker system must have its own power cord. A home audio system does not require active speakers because the receiver provides amplification.

A stereo speaker set is a left-right, two-channel speaker system. A multichannel audio speaker system has a left-right front and left-right rear channel, and it may include a subwoofer and a center speaker. Side speakers are included in more advanced systems. A subwoofer provides enhanced bass sounds.

".1" indicates a subwoofer. For example, 7.1 channels refers to an eight-speaker mode and uses two front speakers (left-right), two side speakers (left-right), two rear speakers (left-right), a center speaker, and a subwoofer.

Connecting 2.1 (2 speakers and a subwoofer) audio speakers

To connect simple left/right stereo active speakers or two speakers and a subwoofer for 2.1 speaker output:

- 1 Turn off the PC.
- 2 Connect the speaker cable to the lime green Audio Line Out connector that matches the back of your PC.

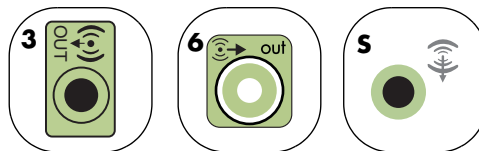

- Type 3 is three connectors
 - Type 6 is six connectors
 - Type S is a sound card connector
- 3 Connect the cable to the audio system.
 - 4 For 2.1 speakers that were shipped with your PC (select models only), connect the Audio Line Out connector to the subwoofer.
 - 5 Connect the left and right speakers to the subwoofer. Refer to the speaker documentation.
 - 6 Turn on the PC.
-
- NOTE:** Always turn on the PC before you turn on the speaker system.
-
- 7 Plug in the speaker system power.
 - 8 Turn on the speaker system.
- Step 8 is optional for a two-speaker setup.

- 9 After the speakers are connected to the PC, configure the audio software for sound output for your PC model:
 - Type 3 connectors: See “Configuring audio output with Multi-channel Sound Manager” on page 35.
 - Type 6 connectors: See “Configuring audio output with Sound Effect Manager” on page 37.

The following diagram shows a typical 2.1 audio installation:

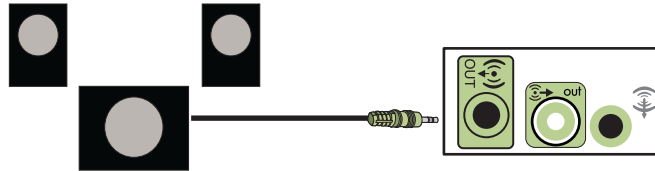

Connecting 4.1 (4 speakers and a subwoofer) audio speakers

To connect two front speakers, two rear speakers, and a subwoofer for four-channel (4.1 speaker) output:

- 1 Turn off the PC.
- 2 Connect the front speaker cable to the lime-green Audio Line Out connector that matches the back of your PC.



- Type 3 is three connectors
- Type 6 is six connectors
- Type S is a sound card connector

- 3 Connect the rear speaker cable to the black connector that matches the back of your PC.



For type 3 connectors, the blue Audio Line In connector functions as a rear Line Out when a multichannel audio configuration is activated.

- 4 Connect the cables to the audio system.
- 5 Connect the front and rear speakers to the subwoofer. Refer to the speaker documentation.

6 Turn on the PC.

NOTE: Always turn on the PC before you turn on the speaker system.

7 Plug in the speaker system power.

8 Turn on the speaker system.

9 After the speakers are connected to the PC, configure the audio software for sound output for your PC model:

- Type 3 connectors: See “Configuring audio output with Multi-channel Sound Manager” on page 35.
- Type 6 connectors: See “Configuring audio output with Sound Effect Manager” on page 37.

The following diagram shows a typical 4.1 audio installation:

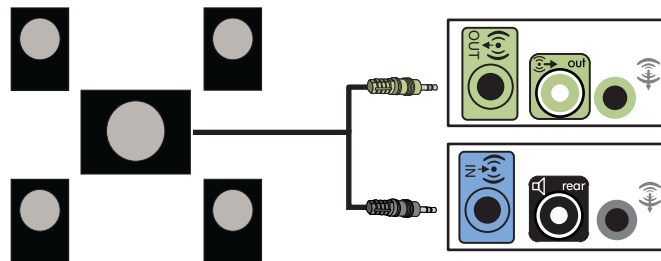

Connecting 5.1 (5 speakers and a subwoofer) audio speakers

To connect two front speakers, two rear speakers, a center speaker, and a subwoofer for six-channel (5.1 speaker) output:

- 1 Turn off the PC.
- 2 Connect the front speaker cable to the lime green Audio Line Out connector that matches the back of your PC.

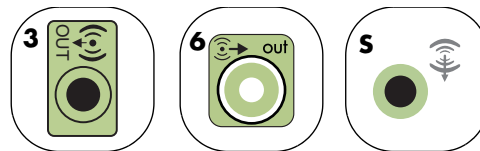

- Type 3 is three connectors
- Type 6 is six connectors
- Type S is a sound card connector

- 3 Connect the rear speaker cable to the black connector that matches the back of your PC.



For type 3 connectors, the blue Audio Line In connector functions as a rear Line Out when a multichannel audio configuration is activated.

- 4 Connect the center/subwoofer speaker cable to the gold (or pink) Mic connector that matches the back of your PC.

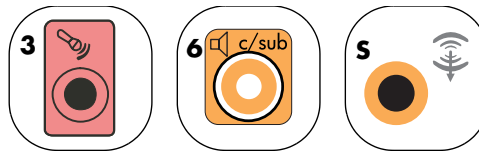

For type 3 connectors, the pink Mic connector functions as a center/subwoofer speaker Line Out when a multichannel audio configuration is activated.

- 5 Connect the cables to the audio system.
- 6 Connect the front, rear, and center speakers to the subwoofer. Refer to the speaker documentation.
- 7 Turn on the PC.

NOTE: Always turn on the PC before you turn on the speaker system.

- 8 Plug in the speaker system power.
- 9 Turn on the speaker system.
- 10 After the speakers are connected to the PC, configure the audio software for sound output for your PC model:
 - Type 3 connectors: See "Configuring audio output with Multi-channel Sound Manager" on page 35.
 - Type 6 connectors: See "Configuring audio output with Sound Effect Manager" on page 37.
 - Type 6 connectors, multistreaming: See "Configuring audio output with Realtek HD Sound Effect Manager" on page 39.

The following diagram shows a typical 5.1 audio installation:

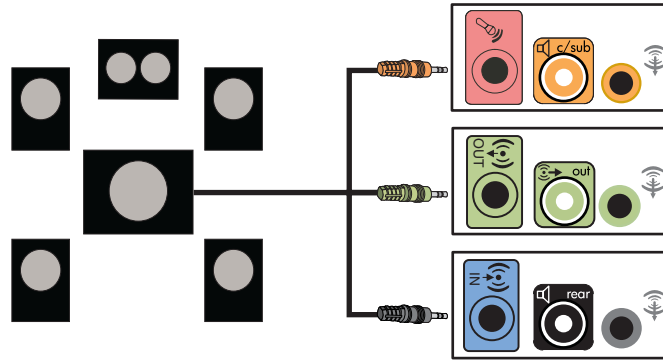

Connecting 7.1 (7 speakers and a subwoofer) audio speakers

To connect two front speakers, two side speakers, two rear speakers, a center speaker, and a subwoofer for eight-channel (7.1 speaker) output:

- 1 Turn off the PC.
- 2 Connect the front speaker cable to the lime green Audio Line Out connector on the back of your PC.



- 3 Connect the rear speaker cable to the black connector on the back of your PC.



- 4 For 6 connectors only, connect the side speaker cable to the gray connector on the back of your PC.



- 5 Connect the center speaker and subwoofer speaker cable to the gold connector on the back of your PC.



- 6 Connect the cables to the audio system.
- 7 Connect the front, rear, side, and center speakers to the subwoofer. Refer to the speaker documentation.
- 8 Turn on the PC.

NOTE: Always turn on the PC before you turn on the speaker system.

- 9 Plug in the speaker system power.
- 10 Turn on the speaker system.
- 11 After the speakers are connected to the PC, configure the audio software for sound output for your PC model:
 - Type 6 connectors: See “Configuring audio output with Sound Effect Manager” on page 37.
 - Type 6 connectors, multistreaming: See “Configuring audio output with Realtek HD Sound Effect Manager” on page 39.

The following diagram shows a typical 7.1 audio installation:

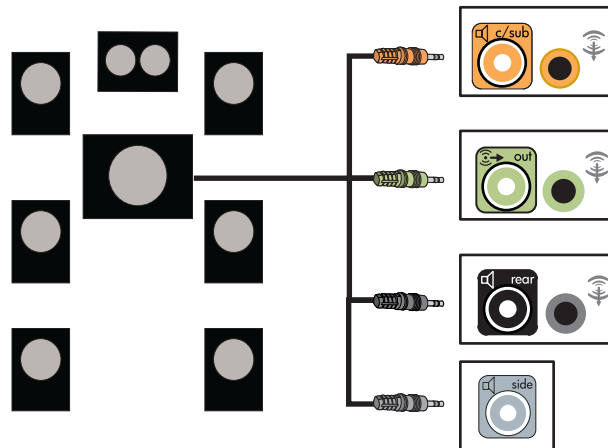

Connecting the PC to a home audio system

You can connect your PC to your home stereo or home theater multichannel audio receiver/amplifiers using your existing speakers.

For example, see “2 or 2.1 home stereo installation” on page 30, or “5.1 (5 speakers and a subwoofer) home audio installation” on page 31.

Y adapter cables

Most home receiver/amplifiers have RCA-type connectors. You may need to connect Y adapter cables between your PC and your receiver/amplifier. Y adapter cables have one 1/8-inch (3.5-mm) stereo mini-jack on one end and two RCA connectors on the other end. These cables are purchased separately.

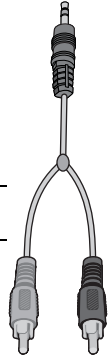

NOTE: Y adapter and extension cables are purchased separately.

The number of Y adapter cables you need to connect to your home stereo system depends on the number of speakers you install:

- 2/2.1 speaker system: 1 Y adapter cable
- 4/4.1 speaker system: 2 Y adapter cables
- 5.1 speaker system: 3 Y adapter cables
- 7.1 speaker system: 4 Y adapter cables

Connecting a home stereo to a PC typically requires audio cables that are long enough to connect from the PC to the stereo. You may also need to purchase RCA or mini-extension cables.

2 or 2.1 home stereo installation

The following diagram shows a typical 2 or 2.1 speaker installation that uses passive stereo speakers and that plugs into a home stereo standard left and right input.

This is only a suggested configuration. Your system may be different.

- A** PC back-panel connectors (3, 6, or sound card)
- B** Y adapter cables
- C** Receiver/amplifier
- D** Subwoofer
- E** Front speakers (left and right)

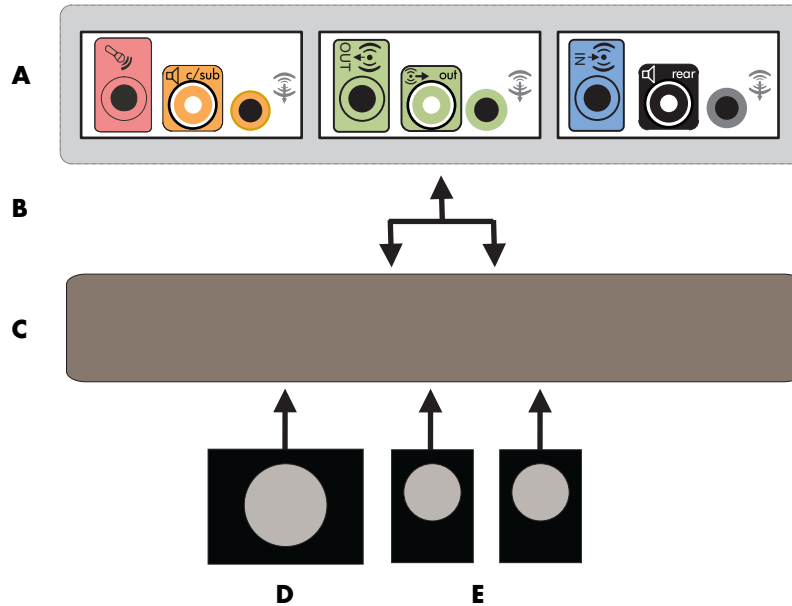

PC to 2.1 multichannel audio system connection

5.1 (5 speakers and a subwoofer) home audio installation

The following diagram shows a typical advanced home theater audio 5.1 speaker installation that requires multichannel inputs on a receiver/amplifier.

This is only a suggested configuration. Your system may be different.

- A** PC back-panel connectors (type 3, type 6, or sound card)
- B** Y adapter cables
- C** Receiver/amplifier
- D** Subwoofer
- E** Center speaker
- F** Front speakers (left and right)
- G** Rear speakers (left and right)

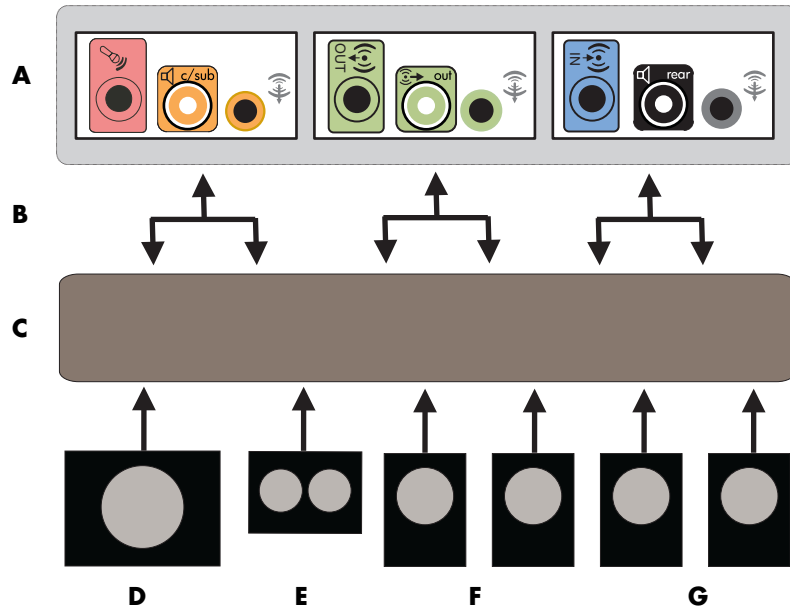

PC to 5.1 multichannel audio system connection

5.1 (5 speakers and a subwoofer) home audio installation procedure

NOTE: Receiver/amplifier input connectors may be labeled Surround, 5.1, or 6 Channel inputs, CD, DVD, or DVD In.

To connect a six-channel (5.1 speaker) home audio system to the PC:

- 1 Turn off the PC.
- 2 Turn off the receiver/amplifier.
- 3 Connect the front stereo mini-jack end of a Y adapter cable into the lime green Audio Line Out connector that matches the back of your PC:
 - Type 3 is three connectors
 - Type 6 is six connectors
 - Type S is a sound card connector



Connect the left and right ends of the Y adapter cable into the front left (L) and right (R) inputs on the back of the receiver/amplifier.

- 4 If you have rear speakers, connect the rear stereo mini-jack end of a Y adapter cable into the Audio Line In (blue) or the Rear Speaker Out (black) connector that matches the back of your PC.



Connect the left and right ends of the Y adapter cable into the rear left (L) and right (R) inputs on the back of the receiver/amplifier.

- 5 Connect the stereo mini-jack of a Y adapter cable into the microphone (pink) connector or the center speaker/subwoofer (gold) connector that matches the back of your PC.

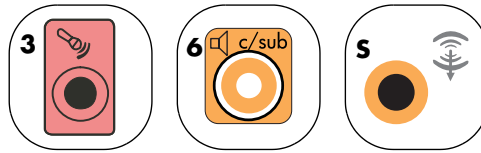

- Connect the left and right ends of the Y adapter cable into the center/subwoofer inputs on the back of the receiver/amplifier (5.1 or higher channel system).
 - Plug the Y adapter cable into the subwoofer connector on the back of the receiver even if a subwoofer is not used.
- 6 Turn on the receiver/amplifier.
 - 7 Select the receiver/amplifier input that the Y adapter cables are plugged into.
 - 8 Turn on the PC.

NOTE: Always turn on the PC before you turn on the speaker system.

- 9 After the audio system is connected to the PC, configure the audio software for sound output for your PC model:
 - Type 3 connectors: See “Configuring audio output with Multi-channel Sound Manager” on page 35.
 - Type 6 connectors: See “Configuring audio output with Sound Effect Manager” on page 37.

Connecting digital audio

(Select models only)

If you have a sound card and you are connecting your home stereo AV receiver via Digital Out, plug the 3.5-mm stereo cable into the **Digital Out** connector on the sound card. Connect the red RCA stereo cable in the 3.5-mm Y cable to the AV receiver’s digital input connector. If the red RCA stereo cable does not work, try the white stereo cable. One of the connectors is not used.

To connect digital audio, your PC must include a Digital Out connector on the sound card or on the back panel. You do not need to connect multichannel speaker outputs if you connect the digital output.

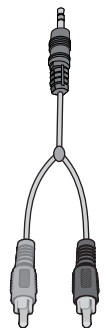

To connect digital audio speakers:

- 1 Turn off the PC.
- 2 Connect the digital input on the digital speakers or a digital audio system to the orange Digital Out connector that matches the back of your PC:
 - Type 3 is three connectors
 - Type 6 is six connectors
 - Type S is a sound card connector



- 3 Turn on the PC.

NOTE: Always turn on the PC before you turn on the speaker system.

- 4 Plug in the speaker system power.
- 5 Turn on the speaker system.
- 6 After the speakers are connected to the PC, configure the audio software for sound output for your PC model:
 - Audio card with digital output and type 3 connectors: See “Configuring audio output with Multi-channel Sound Manager” on page 35. Follow the instructions to enable digital audio output.
 - Audio card with digital output and 6 connectors: See “Configuring audio output with Sound Effect Manager” on page 37. Digital audio output is already enabled as the default.

After connecting the speaker system to the PC, configure the sound software.

Step 2: Configuring the Sound Software

Follow these steps after you have installed and connected the speakers to configure the speakers using the sound software. You can configure your speaker’s audio output with the following software. Use the software that applies to your PC model:

- Multi-channel Sound Manager (type 3 connectors)
- Sound Effect Manager (type 6 connectors)
- Realtek HD Sound Effect Manager (multistreaming audio)

Configuring audio output with Multi-channel Sound Manager

If your PC model has type 3 connectors, follow these steps after you have installed and connected your speakers.

To configure multichannel audio output for PCs with Multi-channel Sound Manager:

- 1 Click **Start** on the taskbar.
- 2 Choose **All Programs**.
- 3 Click **Multi-channel Sound Manager**. The Multi-channel Audio Configuration window opens with five control screens.

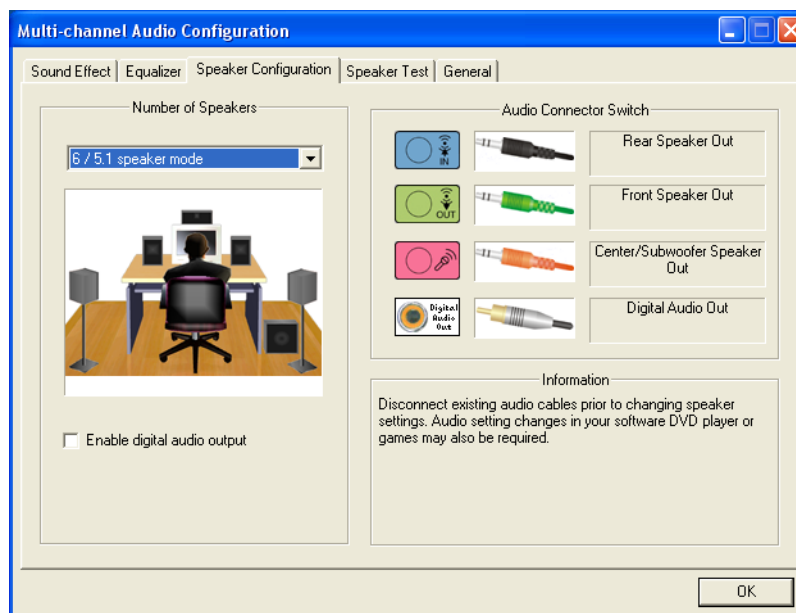

- **Sound Effect** – Select the environment settings.
 - **Equalizer** – Equalize the audio frequencies.
 - **Speaker Configuration** – Select the number of speakers. The Audio Connector Switch indicates the speaker configuration.
 - **Speaker Test** – Test all connected speakers for correct configuration.
 - **General** – View driver and audio information.
- 4 Click the **Speaker Configuration** tab near the top of the window to open the control screens. (Your speakers may need to be plugged in to see this tab.)
 - 5 Select the option describing the number of speakers in your system, in a range from **2/2.1 speaker mode** to **5.1 speaker mode**.
 - 6 Enable digital audio if you want digital audio output. See “Enabling digital audio output with Multi-channel Sound Manager (optional)” on page 36.

7 Click **OK**.

8 (Optional) Test the speakers. Click the **Speaker Test** tab, and follow the onscreen instructions.

Now that the speaker software has been configured, to take full advantage of the speaker capabilities, you must also configure the software media program. The procedure is different for each software media program. See the instructions and documentation that came with the media software program.

Enabling digital audio output with Multi-channel Sound Manager (optional)

Your PC must include a Digital Audio Out connector on the back panel.

To enable digital audio output:

- 1** Follow steps 1 through 5 of the previous procedure, "Configuring audio output with Multi-channel Sound Manager."
- 2** Place a check next to **Enable digital audio output**. The Output digital and analog option is automatically selected.
- 3** Connect the Digital Audio Output connector on the back of your PC to your home audio system's digital audio input.
- 4** Select your stereo system's digital audio input.
- 5** Click **OK**.
- 6** (Optional) Test the speakers to make sure the setup is working.

Now that the speaker software has been configured, to take full advantage of the speaker capabilities, you must also configure the software media program. The procedure is different for each software media program. See the instructions and documentation that came with the media software program.

Configuring audio output with Sound Effect Manager

Follow these steps after you have installed and connected your speakers, if your PC model has 6 connectors.

NOTE: A connector with no descriptive text in the Connection Guide indicates that the connector is not used for the selected speaker configuration.

- 1 Click **Start** on the taskbar.
- 2 Click **Control Panel**.
- 3 Click **Sounds**, and then **Speech and Audio Devices** (or **Sounds and Audio Devices**).
- 4 Click **Sound Effect Manager**. The window opens.
- 5 Click the **Speaker Configuration** tab.
- 6 Select the option describing the number of speakers in your system in a range from **2.1 Speaker** to **7.1 Speaker**.
- 7 Click the **Speaker Test** button to test the speakers.
- 8 Click **OK**.

Now that the speaker software has been configured, to take full advantage of the speaker capabilities, you must also configure the software media program. The procedure is different for each software media program. See the instructions and documentation that came with the media software program.

The Sound Effect Manager control screens

- **Sound Effect** — selects the Environment and the Equalizer settings. You can select an environment such as **Under Water** or **Auditorium**. To use the Equalizer, click the Power button in the center of the circular equalizer control to turn it on. You can click a preset button, such as **Pop** or **Live**, or manually adjust the settings and then save them for easy selection later.
- **Speaker Configuration** — selects the number of speakers, shows the Connection Guide, and has the Speaker Test button to test the speakers. A connector with no descriptive text in the Connection Guide indicates that the connector is not used for the selected speaker configuration.
- **Digital Audio** — selects the digital audio output and digital audio frequency for the digital audio connectors on the PC.
- **Audio Wizard** — opens a window that shows the connector panel on the front of the PC. To close the window without enabling the wizard, click **OK**.

To enable the Audio Wizard:

Make sure the **Enable auto detection** check box is selected to enable the wizard. Click **OK** to close the window.

Using the Audio Wizard in the Sound Effect Manager

The Sound Effect Manager Audio Wizard can help you connect front-panel audio.

To use the Audio Wizard:

- 1 Turn on the PC.
- 2 Click **Start** on the taskbar.
- 3 Choose **Control Panel**.
- 4 Click **Sounds**, then **Speech and Audio Devices** (or **Sounds and Audio Devices**).
- 5 Click **Sound Effect Manager**. The window opens.
- 6 Click **Audio Wizard**. A window opens that shows the connector panel on the front of the PC.
- 7 Place a check in the **Enable jack detection** check box to enable the wizard.
- 8 Connect the speaker system audio cable plugs into the connectors on the front of your PC. The panel display highlights a cable that is properly inserted in a connector.
- 9 Close the window.

Retasking front-panel connectors with Sound Effect Manager

With the Audio Wizard enabled, both the microphone connector and the headphones connector on the front of the PC can be retasked to perform a different audio function. These two connectors are universal audio jacks. When you plug in a cable, the wizard asks you to select the function for the cable from a list, and then it sets the universal audio jack to perform as the selected function. The functions are:

- Stereo Speaker (Out)
- Microphone (In)
- Headphone (In)
- Audio Line In

To retask front-panel connectors:

- 1 Follow steps 1 through 7 of the procedure, "Using the Audio Wizard in the Sound Effect Manager" on page 38.

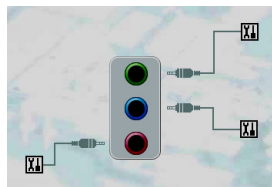

- 2 When you plug in a cable, the wizard asks you to select the device you plugged in from a list.
- 3 Close the window.

Disabling digital audio output with Sound Effect Manager (optional)

To disable digital audio output:

- 1 Open the Sound Effect Manager: Click **Start, Control Panel, Sounds, Speech, and Audio Devices**, and then **Sound Effect Manager**.
- 2 Click **Audio Wizard**. A window opens displaying the connector panel on the front of the PC.
- 3 Click the **Digital Audio** button. Select **Digital output off** (you can also select **Digital-in to Digital-out pass through mode**).
- 4 Close the window.

Configuring audio output with Realtek HD Sound Effect Manager

Follow these steps after you have installed and connected your speakers, if your PC model has type 6 connectors and is capable of multistreaming audio.

To configure multichannel audio output for PCs with Realtek HD Sound Effect Manager:

- 1 Click **Start** on the taskbar.
- 2 Click **Control Panel**.
- 3 Click **Sounds**, then **Speech and Audio Devices** (or **Sounds and Audio Devices**).

NOTE: If you do not see the device for your configuration, change the speaker selection in the Speaker Configuration window.

- 4 Click **Realtek HD Sound Effect Manager**. The window opens.
- 5 Click a button near the top of the window to see that control screen.

The Realtek HD Sound Effect Manager control screens

- **Sound Effect** — selects the Environment and the Equalizer settings. You can select an environment, such as **Under Water** or **Auditorium**. To use the Equalizer, click the Power button in the center of the circular equalizer control to turn it on. You can click a preset button, such as **Pop** or **Live**, or manually adjust the settings and then save them for easy selection later.
- **Mixer** — allows control over volume, playback, mute, recording, and multistreaming audio. Click the **Multi-streaming** button to set up multistreaming. 
- **Audio I/O** — selects the number of speakers, shows the whether the plugs are analog or digital, and selects the digital audio output and digital input device. Only speakers being used are displayed.
- **Microphone** — allows fine control over the microphone/recording quality. Includes buttons for noise suppression and acoustic echo cancellation.

Configuring the Realtek HD Sound Effect Manager

- 1 Click the **Audio I/O** tab.
- 2 Select the option describing the number of speakers in your system — for example, **7.1 speakers**.
- 3 Only connectors being used are shown; if the connector is not shown it means that it is not used for the selected speaker configuration.
- 4 Click **OK**.

To hear DVD movies recorded with multichannel audio from all speakers, change the audio properties for the DVD player software program to match your speaker configuration (if your DVD program supports more than two channels).

To use a microphone or set up the PC for recording, see “Configuring sound for recording with the Realtek HD Sound Effect Manager” on page 40.

To use Multistreaming Audio, see “Configuring multistreaming audio” on page 41.

Configuring sound for recording with the Realtek HD Sound Effect Manager

The microphone connector is ready to use for recording sound. If you want to use another connector for recording, such as the Digital Audio In connector, use these steps to select it.

NOTE: The front pink and green connectors can be retasked to perform other audio functions; refer to “Retasking front panel audio connectors with the Realtek HD Sound Effect Manager” on page 41.

- 1 Click **Start** on the taskbar, click **Control Panel, Sounds, Speech, and Audio Devices**, and then select **Realtek HD Sound Effect Manager**.
- 2 Click the **Mixer** tab.
- 3 In *Record* click the drop-down list. Choose:
 - **RealTek HD Digital Input** to use the digital audio in connector (select models only).
 - **Line in/Mic in** to use the Audio Line In (In) or the Microphone (Mic) connectors.
- 4 Click **OK** to close the window.

Retasking front panel audio connectors with the Realtek HD Sound Effect Manager

The pink and green connectors on the front of the PC connectors can be retasked as needed.

- 1 Click **Start** on the taskbar, click **Control Panel, Sounds, Speech, and Audio Devices**, and then select **Realtek HD Sound Effect Manager**.
- 2 Click the **Audio I/O** tab.
- 3 Click the **Tool** icon in the Front Panel section. The connector settings window displays. 
- 4 Select **Enable Jack detection when device is plugged in**, and click **OK**.

The front pink and green connectors can now be used as input or output devices.

Configuring multistreaming audio

The Realtek HD Sound Effect Manager software allows you to listen to two different audio sources on two different speaker sets.

For example, you hear one audio source through a rear-panel speaker connection and a second source through a front-panel headphone or speaker connection. You must configure multistreaming audio for your system if you want to hear two audio sources on separate speakers.

NOTE: Digital Audio In cannot be multistreamed.

When to use multistreaming audio

You may multistream two audio sources as described in the following typical examples:



- 1 For online gaming, where you hear 5.1 game sound on your AV receiver or powered speakers, while you also hear gaming conversation on your headset. See "Example 1: Online gaming" on page 42.
- 2 For digital home entertainment, where you hear:
 - DVD sound on your living room TV/display or AV receiver from the rear speaker connections.
 - While you also hear your PC headphone or powered speakers that are connected to the front-panel green headphone jack, from one of the following external PC audio sources:
 - a Front-panel Line In
 - b Internal source residing on: a hard disk drive, DVD, CD, USB drive, or other external device.

See "Example 2: For digital home entertainment" on page 43.

Setting up multistreaming audio

Example 1: Online gaming



To configure multistreaming audio output for online gaming with Realtek HD Sound Effect Manager, you must enable Voice-over IP (VOIP) software (software used to converse over the Internet). Other players hear your voice from the microphone via the Internet and you hear the game audio from the rear speakers:

- 1 Connect the audio input and output connectors to:
 - A headphone set to the front Headphone Out (green) connector.
 - A microphone to the front Mic In (pink) connector for online conversation.
 - A set of powered stereo, 5.1, or 7.1 speakers to the rear Speaker Out connectors for gaming sound output.
- 2 Click the **Realtek HD Audio Manager** icon on the system tray to open the Realtek HD Audio Sound Effect Manager window. 
- 3 Choose the **Mixer** tab.
- 4 Click the **Multi-streaming setting** audio button. The dialog box opens. 
- 5 Select the **Enable multi-streaming playback** check box.
- 6 Select one of the following options to determine how you would like to hear your own voice:
 - Check the **Output Mic In/Line In to front panel** check box, and select **OK**.
 - Check the **Output Mic In/Line In to rear panel** check box, and select **OK**.
- 7 Select **Realtek HD Audio rear output** from the drop-down list.
- 8 Start the game that you are about to play. You should hear the gaming sound on the rear stereo, 5.1, or 7.1 speakers.
- 9 At the Mixer tab, select **Realtek HD Audio front output** to enable audio conversation with your teammates.

NOTE: To ensure you have sound output, go to the Mixer window, and check that the setting of the front pink microphone is not muted.

Example 2: For digital home entertainment

To configure multistreaming audio output for digital home entertainment with Sound Effect Manager:

- 1 Connect the audio output connectors to:
 - A headphone set or powered speakers connected to the front Headphone Out (green) connector for stereo music playback.
 - A set of powered stereo, 5.1, or 7.1 speakers connected to the rear Speaker Out connectors for DVD playback sound output.
- 2 Click the **Realtek HD Audio Manager** icon on the system tray to open the Realtek HD Audio Sound Effect Manager window. 
- 3 Choose the **Mixer** tab.
- 4 Click the **Multi-streaming setting** audio button. The dialog box opens. 
- 5 Select the **Enable multi-streaming playback** check box, and select **OK**.
- 6 Select **Realtek HD Audio rear output** from the drop-down list.
- 7 Insert and play a DVD movie. You should hear the DVD sound on the rear speakers.
- 8 Select **Realtek HD Audio front output** from the drop-down list.
- 9 Open Windows Media Player to play music. You should hear the music sound on the front headphone connection.
- 10 To hear an external device source from the Line In or Mic In connection:
 - a Click the **Multi-streaming setting** audio button. The dialog box opens. 
 - b Check the **Output Mic In/Line In to front panel** check box in the dialog box, and select **OK**.

Step 3: Configuring Sound for the Media Software Program

To take full advantage of the sound system capabilities, such as surround sound, after connecting and configuring the speakers, you must also configure the media software program.

For example, if you have a 7.1 speaker system and want to have surround sound when listening to music or watching DVD movies, you must enable surround sound within the media software program.

The procedure is different for each software media program. See the instructions and documentation that came with the media software program.

Selecting Recording Devices

(Type 6 connectors only)

To select a sound recording device:

- 1 Click **Start** on the taskbar.
- 2 Choose **Control Panel**.
- 3 Click **Sounds and Audio Devices** (or **Sounds, Speech, and Audio Devices**). The Sounds and Audio Devices window opens.
- 4 Click the **Audio** tab. The window opens.
- 5 In Sound Recording, select a recording device.
- 6 Click **OK**.
- 7 Close the window.

Resolving Sound Issues





If you don't have sound from your speakers, check the following:

- Check volume and mute settings.
- Use active, powered speakers, or speakers with an amplifier.
- Verify cable connections.
- Make sure the software program and sound software are configured.
- Some programs may result in low volume, even when the Volume knob is turned to the maximum position. If this is the case, double-click the **Volume** icon on the taskbar, and increase the volume.
- Reconfigure the sound software for surround sound.
- Reinstall the sound card drivers by using HP or Compaq Application Recovery. See "Application Recovery" in the *PC Troubleshooting and Maintenance Guide*.

Configuring the Creative Sound Blaster X-Fi Sound Card (Select Models Only)

This section provides an overview of connecting to, configuring, and recording with the Creative Sound Blaster X-Fi sound card.

Connecting the Speakers

Connector	Description
	AD Link for AD_Link X-Fi I/O Console (The X-Fi Console is sold separately.)
	Line Out _3 (orange or yellow) <ul style="list-style-type: none"> • 5.1 audio setup: Front center, subwoofer • 6.1 audio setup: Front center, subwoofer, and rear center • 7.1 audio setup: Front center, subwoofer, and side left
	Line Out _2 (black) <ul style="list-style-type: none"> • 4.1, 5.1, 6.1 audio setup: Rear left and right • 7.1 audio setup: Rear left, rear right, and side right
	Line Out _1 (lime green) <ul style="list-style-type: none"> • 2/2.1 audio setup: Front left and right
	FlexiJack (white) for Line-In, Microphone, Digital In/Out The FlexiJack supports three functions. You must select the function in the Creative Console Launcher. See "Configuring the FlexiJack connector" on page 46.

NOTE: For additional information on connecting the speakers, refer to the documentation that came with your speakers.

- 1 Use the audio connection table above to connect your audio system to the sound card.
- 2 Turn on the PC.
- 3 Plug in and turn on the speaker system power.

After connecting the speaker system to the sound card, follow the steps below to configure the speaker settings in the Creative Sound Blaster X-Fi software. See "Configuring the sound card software" on page 46.

Configuring the sound card software

Follow these steps after you have installed and connected your speakers to configure multi-channel audio output for PCs.

NOTE: Three modes are available; Entertainment Mode is highlighted here. For information about other modes, see "Sound Blaster X-Fi configuration modes" on page 47.

- 1 Click **Start** on the taskbar.
- 2 Choose **All Programs**.
- 3 Choose **Creative, SoundBlaster X-Fi**, and then click **Creative Console Launcher**.

The Entertainment Mode window displays. If a different mode displays, click the **mode** button and select **Entertainment Mode**.



- 4 Select a speaker setting from the Speakers and Headphones Selection drop-down menu. Select a speaker configuration from 2/2.1 to 7.1.
- 5 If your speakers support digital audio, and you would like to enable digital audio. See "Configuring the FlexiJack connector" on page 46.
- 6 Close the window.

Now that the sound card software has been configured, you need to configure audio output for your media software program. The procedure is different for each program. See the instructions that came with the media software program.

Configuring the FlexiJack connector

The FlexiJack connector performs three functions:

- Digital Input/Output
- Line-In
- Microphone

You must select the function in the Creative Console Launcher.

- 1 Connect your audio cable to the FlexiJack connector on the sound card (white).
- 2 Follow steps 1 through 4 of the "Configuring the sound card software" section.
- 3 Click the **Digital I/O button**.

The Digital I/O window displays.



- 4 Under FlexiJack Mode, select either **Digital I/O** or **Mic-In/Line-In**.
- 5 Close the window.

NOTE: If you are using the FlexiJack as your Digital In connection, and want to connect digital speakers as your output device, you need a special connector from Creative.

Recording with the sound card

The Sound Blaster X-Fi enables sound recording from multiple audio sources using Smart Recorder.

- 1 Click **Start** on the taskbar.
- 2 Choose **All Programs, Creative, SoundBlaster X-Fi**, and then click **Smart Recorder**.

The Smart Recorder window displays.

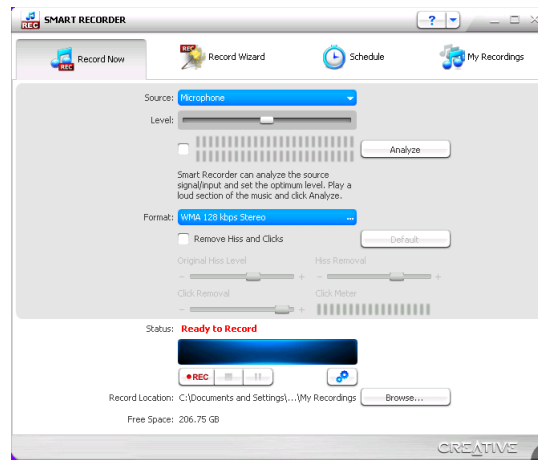

Smart Recorder Tools	Description
Record Now	Configure settings for audio source, recording format, output location, and audio quality on one screen.
Record Wizard	Configure recording settings with the help of a wizard.
Schedule	Set Smart Recorder to automatically record at a time of your choosing.
My Recordings	Access your saved recordings.

NOTE: For additional information on recording refer to the Sound Blaster X-Fi documentation.

Sound Blaster X-Fi configuration modes

The Sound Blaster X-Fi sound card has three modes:

- Audio Creation Mode
- Entertainment Mode
- Game Mode

The main functions, such as speaker configuration, equalizer, and volume control, are available in all three modes. However, each mode optimizes the sound card resources to provide the best audio performance for the activity. Select the appropriate mode for what you are doing.

Modes	Functions
Audio Creation Mode	Audio Creation Mode optimizes the sound card for advanced recording functions. Available features: <ul style="list-style-type: none"> • Recording from several audio sources • Applying studio-quality effects • Mixer settings • Equalizer settings
Entertainment Mode	Entertainment Mode optimizes the sound card for playing movies and music. Available features: <ul style="list-style-type: none"> • Configuring speakers and headphones • Configuring surround sound, DTS, and THX • Volume, bass, and treble controls • Mixer settings
Game Mode	Game Mode optimizes the sound card for playing games. Available features: <ul style="list-style-type: none"> • Volume, bass, and treble controls • Mixer settings • Configure speakers and headphones • Configure surround sound

More Information

For additional information on configuring and using the sound card, go to the Sound Blaster X-Fi documentation:

- 1 Click **Start** on the taskbar.
- 2 Choose **All Programs, Creative, SoundBlaster X-Fi**, and then click **Documentation**.
- 3 Click **Online Manual**.

Using the Memory Card Reader

Digital cameras and other digital imaging devices use memory cards, or *media*, to store digital picture files. The optional memory card reader (select models only) can read and write to a variety of types of memory cards and the IBM Microdrive disk drive.

You can place media in one or more of the card slots and use each media independently. Place only one piece of media in a slot at one time.

Each card slot has its own drive letter and icon. When you insert media, the display label may change to the title of the media, if the title is present.



CAUTION: Do not click *Stop* in the *Safely Remove Hardware* window with the **USB Mass Storage Device selected. Doing so removes the operating system recognition of the memory card reader from your PC; you must restart the PC to see your memory card reader again.**

If you open the *Safely Remove Hardware* window by mistake, click **Close**.

Using the Memory Card Reader

- 1 Insert the media into the card slot until it stops.

The activity light (**A**) on the memory card reader lights, and the PC automatically detects the media.

NOTE: Media must be inserted correctly. Note the direction of the notched corner on the media. See the "Media Insertion Guide" on page 51. CompactFlash and Microdrive are keyed and cannot be inserted incorrectly. Insert the receptacle edge (holes) of this media into the slot.

- 2 The PC opens a window so you can use the media contents. You can copy files from or to the media.
- 3 When you are finished, right-click the drive icon, select **Eject**, check that the activity light is on but not blinking, and then remove the media. A steady activity light indicates that the PC is not reading or writing the media.











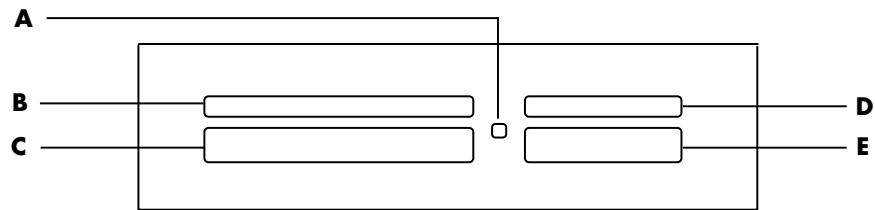



WARNING: Do not try to remove media when the activity light is blinking; doing so may cause loss of data.

Media Insertion Guide

4-slot memory card reader (select models only)

- A** Activity light
- B** Upper-left slot
- C** Lower-left slot
- D** Upper-right slot
- E** Lower-right slot







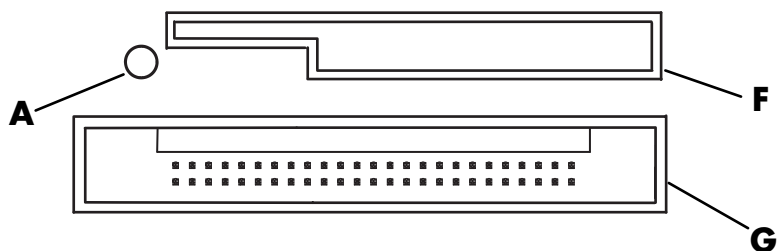

Card	Insert	Into 4-slot reader
CompactFlash Type I media	Receptacle edge (holes)	C (lower-left)
CompactFlash Type II media	Receptacle edge (holes)	C (lower-left)
IBM Microdrive disk drive	Receptacle edge (holes)	C (lower-left)
Secure Digital (SD) Memory Card*	Facing up	D (upper-right) 
Mini Secure Digital (MiniSD) Memory Card*	Facing up	D (upper-right) 
MultiMediaCard (MMC)	Facing up	D (upper-right) 
Reduced size MultiMediaCard (RSMC)*	Facing up	D (upper-right) 
MultiMediaCard Plus (MMC+)*	Facing up	D (upper-right) 
MultiMediaCard Mobile (MMC Mobile)*	Facing up	D (upper-right) 
Memory Stick (MS) Memory Card	Facing up	E (lower-right) 
Memory Stick (MS-Pro) Memory Card	Facing up	E (lower-right) 
Memory Stick (MS-Pro Duo) Memory Card*	Facing up	E (lower-right) 
Memory Stick (MS-Duo) Memory Card*	Facing up	E (lower-right) 
SmartMedia (SM) Memory Card	Facing up	B (upper-left) 
xD media	Facing up	B (upper-left) 

*Select models only. Not available in all countries/regions.

2-slot memory card reader (select models only)

- A** Activity light
- F** Upper slot
- G** Lower slot



Card	Insert	Into 2-slot reader
Secure Digital (SD) Memory Card	Label up (gold connector fingers down)	F (Upper) 
MultiMediaCard (MMC)	Label up (gold connector fingers down)	F (Upper) 
Memory Stick (MS) Memory Card	Label up (gold connector fingers down)	F (Upper) 
Memory Stick (MS-Pro) Memory Card	Label up (gold connector fingers down)	F (Upper) 
SmartMedia (SM) Memory Card	Label down (gold connector fingers up)	F (Upper) 
xD media	Label up (gold connector fingers down)	F (Upper) 
IBM Microdrive disk drive	Receptacle edge (holes) (label up)	G (Lower)
CompactFlash Type I media	Receptacle edge (holes) (label up)	G (Lower)
CompactFlash Type II media	Receptacle edge (holes) (label up)	G (Lower)

NOTE: Do not use SM and xD media in the memory card reader at the same time. Only the first one inserted is recognized by the memory card reader.

Using the HP Personal Media Drive

The HP Personal Media Drive (sold separately) can be used as an internal or external USB hard disk drive designed to quickly and easily increase your storage capacity and to transfer media files such as digital photos, music, videos, and other important files. You can also use the HP Personal Media Drive to back up other drives on your PC.

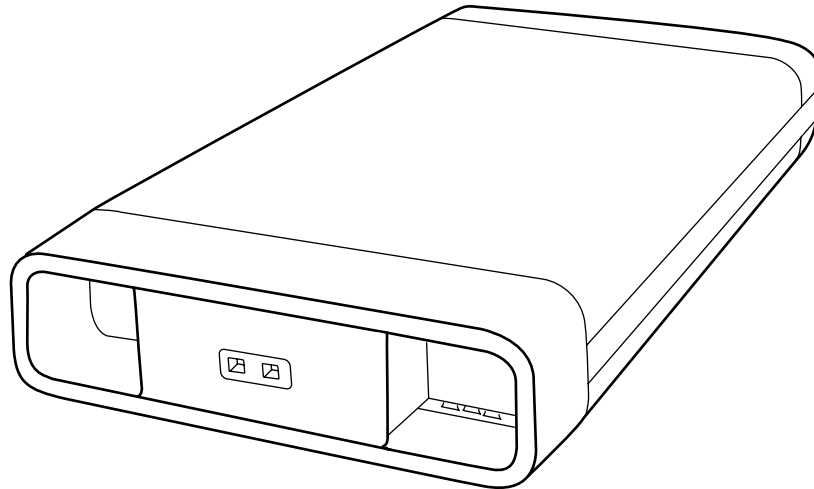

NOTE: Before starting the System Recovery Program, remove the HP Personal Media Drive. See your System Recovery documentation.

Connecting the Drive

As an external drive, the HP Personal Media Drive connects and disconnects easily from a USB 2.0 connector on the front or the back of most PCs. The drive comes with software, an external USB cable, and an external power cord and power adapter. For information about connecting and using the HP Personal Media Drive as an external drive, refer to the documentation that came with the HP Personal Media Drive.

For some PCs (select models only), the HP Personal Media Drive is designed to fit inside a horizontal or vertical drive bay.

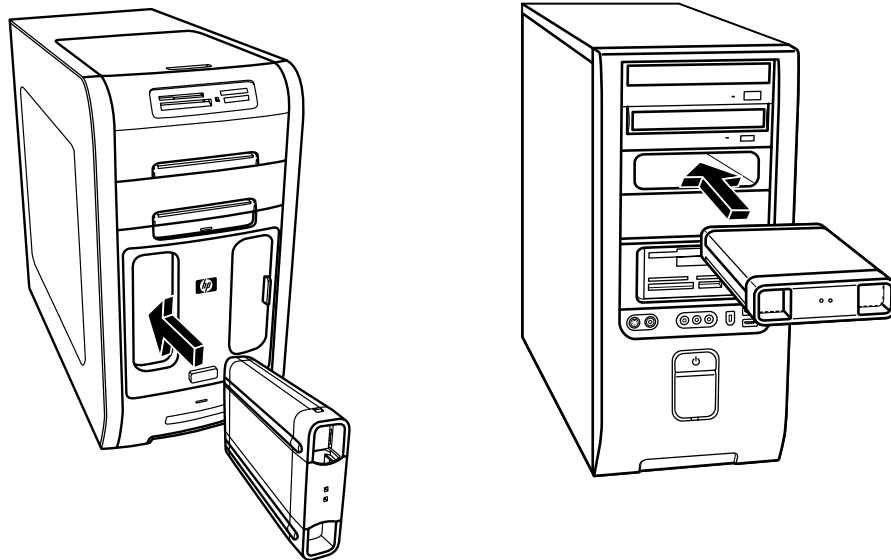

This special drive bay includes an internal USB port and power cable that connect to the drive when it is inserted.

The drive turns on when it is plugged into an active USB port. If the PC is turned on with the drive connected, the drive automatically turns on. When the USB cable for the drive is not plugged in or when the USB power from the PC is turned off, the drive automatically turns off. When the PC is in standby mode (a reduced power state), the drive remains turned on.

NOTE: The drive can be easily inserted and removed from the bay without turning off the PC. This feature is sometimes referred to as *warm swappable*.



WARNING: Do not move the PC with the HP Personal Media Drive inserted in the bay or connected to a USB port on the PC. This can cause damage to the drive and cause data loss.

Inserting the Drive

- 1 Turn on the PC.
- 2 Line up the ridges on the bottom of the drive with the two slots on the side or the bottom of the PC drive bay. Do not force the drive into the bay; it should slide easily into the bay.
- 3 Slide the drive all the way into the drive bay until the drive is firmly connected to the internal power and USB port. With the PC turned on, the power indicator **(B)** on the front of the drive is lit when the drive is inserted correctly.

- A** Drive activity indicator light
- B** Power on indicator light
- C** HP Personal Media Drive guide ridges

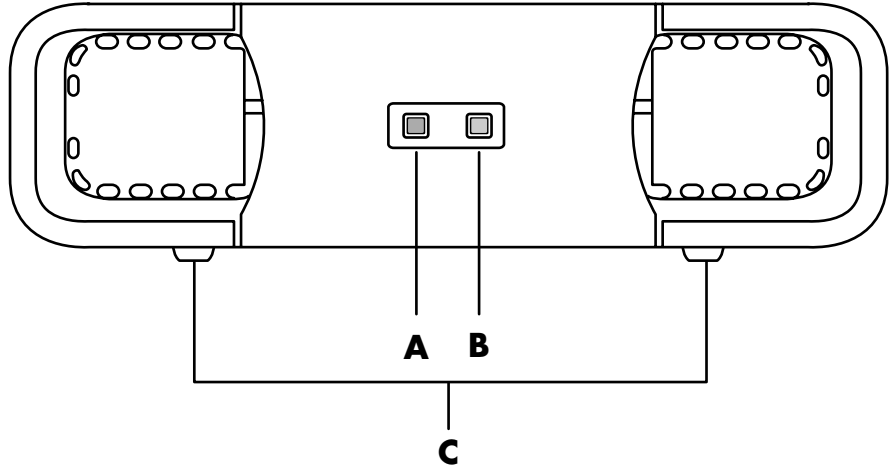

Locating the Drive and Assigning a Drive Letter

After you insert the drive into the PC, you can find the drive in My Computer. The operating system automatically assigns a letter to the drive. The assigned letter depends on the other storage devices connected to the PC.

To locate the drive:

- 1 Click **Start** on the taskbar.
- 2 Click **My Computer**.
- 3 Select the drive under Hard Disk Drives. The default name is HP Personal Media Drive.

You can permanently assign a drive letter to avoid the letter changing when you connect and disconnect this drive and other devices. Also, it is easier for a software program to locate the files on the HP Personal Media Drive if a drive letter is assigned. Some programs may not be able to find files if the drive has a new drive letter.

It is best to always remove your drive safely to avoid errors. See "Disconnecting the Drive" on page 58.

To assign a drive letter:

- 1 Click **Start** on the taskbar.
- 2 Right-click **My Computer**.
- 3 Select **Manage** and then click **Disk Management**.
- 4 Right-click the **HP Personal Media Drive**.
- 5 Select **Change Drive Letter and Paths**.
- 6 Click **Change**, and select a letter. Then apply the changes by clicking **OK**.

The default volume label of this drive is HP Personal Media Drive. You can rename the drive in the My Computer window by right-clicking the drive, selecting **Rename**, and then typing a new name. Rename the drive if you have more than one HP Personal Media Drive.

NOTE: To avoid multiple hard disk drives using the same drive letter, when connecting and removing the drives, assign the letter Z to the HP Personal Media Drive.

Using the Drive

When running for long periods of time, the aluminum case of the HP Personal Media Drive may become very warm. This is part of the HP Personal Media Drive's advanced design and is completely normal.

The built-in, low-noise fan is designed to automatically turn on at pre-set temperatures. If you are using the HP Personal Media Drive connected externally to your PC, please place the drive in a well-ventilated area.

Storing files

The best way to transfer files to the HP Personal Media Drive is to drag them from your local hard disk drive. This allows you to place files in specific folders. Refer to the following procedures for more detailed instructions about creating linked folders.

Playing media files

You can play media from an HP Personal Media Drive:

- 1 Click **Start** on the taskbar.
- 2 Click **My Computer**.
- 3 Double-click the **HP Personal Media Drive** icon to locate your media file.
- 4 Double-click the file. Most media files open in Windows Media Player.

Playing music files

You can play music files that are stored on the HP Personal Media Drive:

- 1 Click **Start** on the taskbar, click **My Computer**, and then double-click the **HP Personal Media Drive** icon.
- 2 Create a personal music folder by right-clicking the drive window and choosing **New** and then **Folder**. Type a name for your personal music folder.
- 3 Drag or copy your music files into this created folder.
- 4 Open Windows Media Player by clicking **Start, All Programs**, and then clicking **Windows Media Player**.
- 5 In the Windows Media Player window, click **Tools**, select **Options**, and then select the **Media Library** tab.
- 6 Click the **Monitor Folders** button.
- 7 Click **Add** to add a pathway to your HP Personal Media Drive.
- 8 Browse to locate your created music file folder on your HP Personal Media Drive, and then click **OK**.
- 9 Click **OK**, and then **OK** again to close the Options window. Now your music files on your HP Personal Media Drive appear in the Windows Media Player library when your drive is connected to the PC.

When you disconnect the drive, your music files may still appear in the Windows Media Player Library. To refresh your PC, open and close Windows Media Player. If that doesn't work, restart the PC.

Disconnecting the Drive

You can safely remove the drive when it is not active. When the amber activity light is blinking, the drive is active, saving or transferring data. Removing the drive while the light is blinking may cause data loss or damaged files.

To disconnect the HP Personal Media Drive safely:

- 1** Close all programs that may be accessing your HP Personal Media Drive. Make sure that the activity light on the drive is off.
- 2** Double-click the **Safely Remove Hardware** icon in the system tray (on the Start taskbar). If this icon is hidden, click the arrows on the taskbar to display it. The Safely Remove Hardware window opens. 
- 3** Double-click **USB Mass Storage Device** to locate your HP Personal Media Drive. USB Mass Storage Device may be listed twice. One may contain a memory card reader or other mass storage drive.
- 4** Select the **HP Personal Media Drive**, and then click **OK**. The name of the drive may be different if you renamed it, or it may appear as Generic Volume followed by the assigned drive letter.
A Safe to Remove Hardware message appears in the system tray, letting you know that the device is safe to disconnect.
- 5** Click **Close**.
- 6** Disconnect the drive by removing it from the drive bay.

Working with Digital Images

You can copy, edit, and share digital images using the PC.

Transfer digital images to the PC using the following methods:

- CD or DVD: Insert the disc into the CD or DVD drive.
- Digital camera or digital video camera: Connect the device to the PC with the transfer cable that came with the device. (Select models have a digital camera docking bay. See "Using Your Docking Bay" on page 15.)
- Memory card: Insert the memory card into the memory card reader (select models only).

Digital images you copy or transfer to the PC appear in the **My Pictures** folder.

Using HP Photosmart Premier

Use the HP Photosmart Premier software program to manage your photos, scanned images, and video clips. It has all the tools you need for viewing, organizing, editing, printing, sharing, and protecting digital images.

To open HP Photosmart Premier:

Click **Start** on the taskbar, **All Programs**, **HP**, and **HP Photosmart Premier**.

The HP Photosmart Premier window opens.

- A** Function screen tabs and different view buttons for images in the work area. Click **Preferences** to customize HP Photosmart Premier settings, such as the default location for storing images.
- B** Control area. Displays controls for the selected function screen.
- C** Work area. Shows images on the PC.
- D** Selection tray.

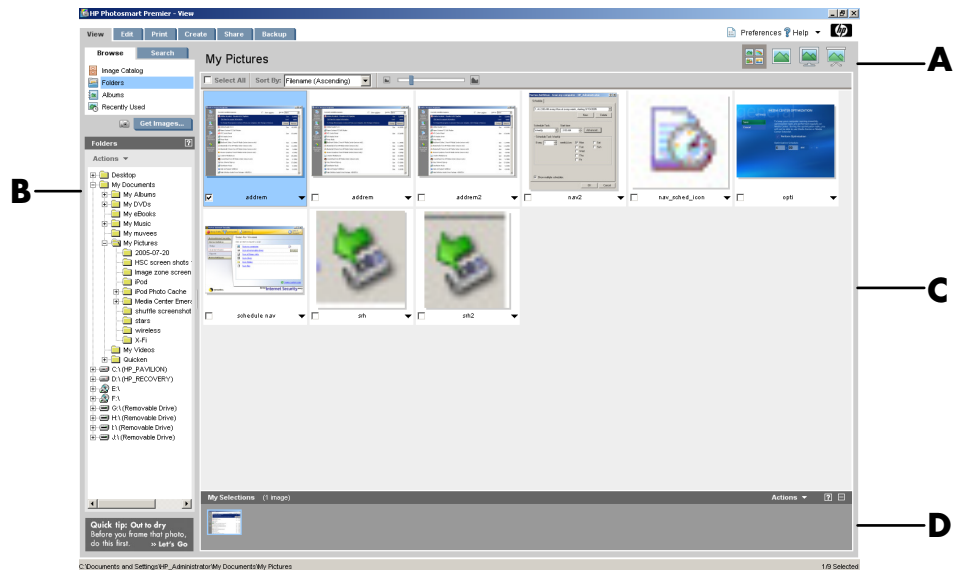

Click a tab at the top of the application window (**A**) to choose the desired function screen, as described in the following list:

View Click this tab to find, view, and manage single or multiple photos or video clips. At the top of the control area (**B**), click **Image Catalog** to view all your images, or choose **Folders** to browse for images. To select the images that you want to print or use, click the image (or images) in the work area (**C**), and it appears in the selection tray (**D**). The selection tray images appear under every tab. For more information, see "View Tab Help" in Help.

Edit Click this tab to make changes, such as crop, resize, and red-eye removal, to the images and video clips you placed in the selection tray. For more information, see "Edit Tab Help" in Help.

Print Click this tab to print photos, photo packages, and index sheets using the images in the selection tray. Projects include photo pages, cards, and flyers. For more information, see "Print Tab Help" in Help.

Create Click this tab to create and to print a project using the images in the selection tray. Projects include album pages, calendars, labels, panoramas, cards, and flyers. For more information, see "Create Tab Help" in Help.

Share Click this tab to share photos with family and friends. Using Share, you can create an e-mail, select the pictures to include, and then send your message. Share creates thumbnails of your images that the recipients can view immediately in the message instead of opening a large e-mail attachment. To view the original photo, they can click a thumbnail in their message, which links them to a secure Web page. On the Web page, they can see the photos, order prints (if the service is available in your country/region), save the images to their PC, and other tasks. For more information, see "Share Help" in Help.

NOTE: You must be connected to the Internet to use the Share feature.

Backup Click this tab to create backup discs of all the images on your PC or to recover images (either from a backup disc or from the Image Vault).

For more information on using HP Photosmart Premier, click the **Help** link.



Playing CDs and DVDs

This section describes how to play CDs, VCDs, or DVDs using Windows Media Player or other audio and video programs.

Playing Music CDs

You must have either a CD or DVD drive.

- 1** Insert the music CD into your CD or DVD drive.
The default audio program opens. If the Audio CD wizard window opens, choose the program you want to use from the list. You may have to scroll down in the window to see all available programs.
- 2** The music CD automatically begins to play.

For help online, go to:

<http://www.hp.com/music>
(English only)

Playing DVDs

You must have a DVD drive.

- 1** Insert the DVD into your DVD drive.
The default DVD program opens. If the DVD wizard window opens, choose the program you want to use from the list. You may have to scroll down in the window to see all available programs.
- 2** Use the controls in the DVD program to play the DVD.

Using country/region codes

Most DVD discs have country/region codes embedded in the disc data that limit where the DVD movie can be played.

The country/region number is usually placed over a world globe printed on the DVD packaging and disc. DVDs without country/region codes play on any player or drive in any country/region.



WARNING: You can change countries/regions only five times before the country/region code locks and becomes permanent. Once the code locks, you can play DVDs from that country/region only. If the country/region code locks and you need help, contact Support.

Playing CDs and DVDs with Windows Media Player

Your PC must have a DVD drive to play DVD movies.

- 1 Insert the music CD or DVD movie into the drive.
 - The Windows Media Player window opens. If the wizard window opens, select **Windows Media Player** from the list. You may have to scroll down in the window to see Windows Media Player.

Or

 - If the Windows Media Player window does not automatically open, click **Start** on the taskbar, choose **All Programs**, and then click **Windows Media Player**.
- 2 To play the CD or DVD, use the playback buttons in the Windows Media Player window. To play a particular track, double-click the title (or track number) in the Playlist. You can also control playback by using the media control buttons on the keyboard (select models).

For more information on using Windows Media Player, click the **Help** menu in the Windows Media Player menu bar. If necessary, first display the menu bar by clicking the **up arrow** icon in the upper-left corner of the Windows Media Player window.

Playing Video CDs (VCDs)

You must have either a CD or DVD drive.

- 1 Insert the video CD into your CD or DVD drive.
The default video CD program opens. If the Video CD wizard window opens, choose the program you want to use from the list. You may have to scroll down in the window to see all available programs.
- 2 Use the controls in the video CD program to play the video CD.

Playing Video CDs (VCDs) with Windows Media Player

- 1 Insert your video CD (VCD) into a DVD or CD drive.
- 2 Select **Play using Windows Media Player**, and click **OK**.
Or
If the program doesn't open, click **Start**, choose **All Programs**, and **Windows Media Player**.
- 3 Click **File** on the menu bar at the top, and click **Open**. (If you do not see the menu bar, click the small circle with the up arrows and down arrows in the upper-left corner of the window.)
- 4 Click the **Look In** drop-down arrow, and select the drive that has the video CD.
- 5 Double-click the **MPEGAV** folder.
- 6 Select **Any File (*.*)** from the **Files of type** drop-down list.
- 7 Select the file, and click **Open**.
- 8 If you have a dual-language VCD, the sound of one language comes out of the left speaker, and the other language comes out of the right speaker. Click **View** on the menu bar, choose **Enhancements**, and select **Graphic Equalizer**.
- 9 Move the **Balance** slider bar all the way to the left or to the right, depending on which language you want to hear.
- 10 Close the Graphic Equalizer window.



Creating Audio and Data Discs

This chapter contains the procedures you must perform to record (or *burn*) music and data files to recordable CD and DVD discs. It also includes information about labeling your discs using the LightScribe labeling technology included on select models.

For information about recording video files to DVDs, see “Creating Video Discs and Movies” on page 81.

Your PC includes one or more CD, DVD, or combination optical drives capable of recording. Additionally, your PC may include the following software programs for recording to CDs or DVDs:

- Windows Media Player
- Real Rhapsody (select models only)
- Sonic MyDVD Plus (select models only)
- Sonic DigitalMedia Plus (select models only)
- Windows XP

These programs include features that enable you to copy, archive, and manage music and data files and then record the files to CDs or DVDs. You can also use Windows Media Player to download and copy music files to a portable device or memory card.

IMPORTANT: HP supports the lawful use of technology and does not endorse or encourage the use of our products for purposes other than those permitted by copyright law.

NOTE: *Burn* is an industry term used to describe the recording of information onto a DVD or CD. Optical recording uses a laser beam to place information onto the disc, thus the term *burning*.

Erasing Rewritable Discs Before Recording

Previously recorded files on CD-RW, DVD-RW, or DVD+RW discs must be erased before recording new files. CD-R, DVD-R, and DVD+R discs cannot be erased.

To erase a rewritable disc in Sonic DigitalMedia Plus:

- 1 Open the DigitalMedia Plus program by clicking **Start, All Programs, Sonic**, and then **DigitalMedia Home**.
- 2 Click **Tools** and then **Erase Disc**.



- 3 Insert the rewritable disc you want to erase.
- 4 Click the **Quick Erase** or **Full Erase** option, and then click the **Erase Disc** icon.



Working with Audio CDs

Sonic DigitalMedia Plus enables you to create audio CDs that play in your car or home CD player, and on PCs. You can create two main types of music CDs:

- **Uncompressed** — Typical CD format like you would purchase on a commercial CD. This type of CD holds 10 to 20 songs depending on their length.

Uncompressed files can be burned on CD-Rs (which play in most home and car stereos, DVD players, and computers) or CD-RWs (which play only in some stereos, DVD players, and PCs).

The procedure for creating this type of CD is described in "Creating audio CDs" on page 70.

- **Compressed** — Files are burned to a disc using a compressed file format (.mp3, .wma, or .m4a). The smaller file format enables you to fit approximately ten times as many songs onto the disc (depending on length and format).

Compressed files can be burned to CD-Rs, CD-RWs, DVDs, DVD-RWs, or DVD+RWs (select models only). Compressed files can only be played on PCs, CD players, or DVD players that support the *file format* you use to create the disc (.mp3 is most commonly supported). For file format compatibility, check the documentation for the device where you intend to play the disc. You may hear a slight loss of sound quality using compressed audio files.

The procedure for creating this type of CD is described in "Creating jukebox discs" on page 70.

For more compatibility information, see "Disc Features and Compatibility Table" on page 77.

Both Sonic programs create *closed-session* music CDs, which means you must record all music files on one CD in one recording session. Music files can be recorded repeatedly on a rewritable CD-RW disc, but all previously recorded files must be erased first. CD-R discs cannot be erased.

IMPORTANT: HP supports the lawful use of technology and does not endorse or encourage the use of our products for purposes other than those permitted by copyright law.

Verifying audio disc recorded without errors

When copying or burning audio files to CD, it is recommended that you use Sonic DigitalMedia Plus because it includes a feature that confirms that your disc has been created without errors.

This data verification feature is enabled by default.

To check the status of the write verification feature in DigitalMedia Plus:

- 1 Open the DigitalMedia Plus program by clicking **Start, All Programs, Sonic**, and then **DigitalMedia Home**.
- 2 Click the **Tools** menu and then click **Options**.
- 3 In the Options window, click **Copy**.
- 4 Ensure the **Verify copied data discs** option is checked.
- 5 Click **OK**.

Audio CD tips

When recording music files, it is important to note that:

- To play your music CD in a home or car stereo, it needs to be recorded as a music CD in CD audio (CDA) format, not as a data CD.
- As you add music files in the recording session, DigitalMedia Plus calculates and displays the amount of recording time available to record additional music files.
- You can't record song titles unless you make an exact copy of a music CD in your collection.
- If your recording fails, manually select a slower recording speed, if available, each time you make a recording. Refer to the Help menu in your selected software program for more information about selecting a slower recording speed.
- If you try to record more than a standard CD can hold, a message displays warning you that all the tracks may not fit on your disc.

IMPORTANT: HP supports the lawful use of technology and does not endorse or encourage the use of our products for purposes other than those permitted by copyright law.

Creating audio CDs

To create uncompressed audio CDs using Sonic DigitalMedia Plus:

- 1 Open the DigitalMedia Plus program by clicking **Start, All Programs, Sonic**, and then **DigitalMedia Home**.
- 2 Click the **Audio** tab and then **Audio CD**.
- 3 Do one or more of the following:
 - Click **Add Music** and navigate to music stored on your PC.
 - In the Quick Find panel, click **Scan** to automatically search your PC for songs.
 - Insert a CD and add songs from it.
- 4 Select the songs you want to record, and then click **Add**.
- 5 Click the **Burn** icon when you have added all the audio files to your music CD project. 
- 6 When prompted, insert a blank CD-R or CD-RW disc. If you want to play your music CD in your home or car stereo, use a CD-R disc. CD-RW discs may not play in some stereos.
- 7 Click **OK**.

You can get detailed online Help by clicking the **Help** menu and then selecting **Help**.

Creating jukebox discs

To create compressed (jukebox) music CDs or DVDs using Sonic DigitalMedia Plus:

- 1 Open the DigitalMedia Plus program by clicking **Start, All Programs, Sonic**, and then **DigitalMedia Home**.
- 2 Click the **Audio** tab, and then **Jukebox CD/DVD**.
- 3 Do one or more of the following:
 - Click **Add Music**, and navigate to music stored on your PC.
 - In the Quick Find panel, click **Scan** to automatically search your PC for songs.
 - Insert a CD, and add songs from it.
- 4 Select the songs you want to record, and then click **Add**.
- 5 Click the **Burn** icon when you have added all the audio files to your music CD project. 
- 6 When prompted, insert a blank disc.

DVD discs can store significantly more music files than a CD. Jukebox discs can only be played on PCs, CD players, or DVD players that support the *file format* you use to create the disc (.mp3 is most commonly supported).

For file format compatibility, check the documentation for the device where you intend to play the disc.
- 7 Click **OK**.

You can get detailed online Help by clicking the **Help** menu and then selecting **Help**.

NOTE: DigitalMedia Plus scans for all audio files, even the sounds from your operating system. If you don't want to display some of these sounds, you can select the **Options** icon (wrench). In the Options window, select **Audio**, and then **Quick Find**. Select **Hide Audio Files Shorter Than** (in seconds), type the number of seconds, and click **OK**.

Working with Data DVDs and CDs

Unlike audio CDs and jukebox DVDs, data DVDs and CDs can be recorded in multiple sessions.

Verifying data disc recorded without errors

When copying or burning data files to DVD or CD, it is recommended that you use Sonic DigitalMedia Plus because it includes a feature that confirms that your disc has been created without errors.

This data verification feature is enabled by default.

To check the status of the write verification feature in DigitalMedia Plus:

- 1 Open the DigitalMedia Plus program by clicking **Start, All Programs, Sonic**, and then **DigitalMedia Home**.
- 2 Click the **Tools** menu and then click **Options**.
- 3 In the Options window, click **Data**.
- 4 Ensure the **Verify data written to the disc after burning** box is checked.
- 5 Click **OK**.

Data disc tips

When storing data files on a disc, it is important to note that:

- You can add new data files to a CD-R, DVD+R or DVD-R in a later recording session, until the disc is full. With DVD+R or DVD-R discs, insert your partially recorded DVD, click the **Wrench** icon to display the Options window, click **Data**, select the first **Write-Once DVD Compatibility** option, and then click **OK**.
- When you record files that have the same name as previously recorded files, Sonic DigitalMedia Plus updates the file, and the previous version is overwritten.



- Sonic DigitalMedia Plus allows you to change the names of files you want to record and files that were previously recorded.
- As you select data files to record to your disc, Sonic DigitalMedia Plus calculates and displays the amount of recording space used on your disc.
- If your recording fails, manually select a slower recording speed, if available, each time you make a recording. Refer to the Help menu in your selected software program for more information about selecting a slower recording speed.

Creating data discs

To create data CDs or DVDs using Sonic DigitalMedia Plus:

- 1 Open the DigitalMedia Plus program by clicking **Start, All Programs, Sonic**, and then **DigitalMedia Home**.
- 2 Click the **Data** tab, and then click **Data Disc**.
- 3 Do one or more of the following:
 - Click **Add Data** and navigate to files stored on your PC.
 - In the Quick Scan panel, select a type of file to search for, and then click **Scan** to automatically search your PC for the selected file type.
 - Insert a CD or DVD that contains the file you want to add.
- 4 Select the files you want to record, and then click **Add**.
- 5 To name your disc, highlight **Volume Label**, and then type a name over it. Sonic DigitalMedia Plus assigns a name based on the recording date if you do not type a name.
- 6 Click the **Burn** icon when you have added all the files to your data project. 
- 7 When prompted, insert a blank or appendable disc.
DVD discs can store significantly more files than a CD.
- 8 Click **OK**.

You can get detailed online Help by clicking the **Help** menu and then selecting **Help**.

NOTE: An appendable disc can have additional files added to it, if there is disc space available. Recorded audio CDs are closed-session discs that are not appendable.

NOTE: You can rename your files in the file selection window by selecting and typing over the current name. This does not affect the original files on your hard disk drive.

NOTE: DVD discs can store significantly more files than a CD.

Copying a DVD or CD

Sonic DigitalMedia Plus enables you to make copies of an existing music or data disc. You can configure Sonic DigitalMedia Plus to verify that:

- Data files have been copied without errors by performing the procedure described in “Verifying data disc recorded without errors” on page 71.
- Music files have been copied without errors by performing the procedure described in “Verifying audio disc recorded without errors” on page 69.

IMPORTANT: HP supports the lawful use of technology and does not endorse or encourage the use of our products for purposes other than those permitted by copyright law.

To make a copy of an existing music or data disc using Sonic DigitalMedia Plus:

- 1 Open the DigitalMedia Plus program by clicking **Start, All Programs, Sonic**, and then **DigitalMedia Home**.
- 2 Click the **Copy** tab, and then click **Disc Copy**.
- 3 Insert the CD or DVD you want to copy.
- 4 Insert a blank DVD or CD into the drive.
- 5 Click the **Copy** icon.
- 6 Click **Done** when the recording is complete.



Archiving Files on a CD or DVD

To make an archive file copy of files stored on your PC using Sonic DigitalMedia Plus:

- 1 Open the DigitalMedia Plus program by clicking **Start, All Programs, Sonic**, and then **DigitalMedia Home**.
- 2 Click the **Data** tab and then **Easy Archive**.
- 3 Select the path to the files that you want to archive (or click **Browse** to navigate to them).
- 4 Select the type of files you want to add to the archive, or select **All Files in the Selected Path**.
- 5 If desired, place a check mark in the **Only Archive files changed since** box, and select a date to limit the scan to files that have been changed since that date.
- 6 Click **Save**, enter a name for your archive, and then click **OK**.
- 7 Click the **Burn** icon.



- 8 When prompted, insert a recordable disc, and then click **OK**.
If the files do not fit on one disc, you are prompted for additional discs.
 - 9 Click **Done** when recording is complete.
- For additional information about saving archives on your hard disk drive or scheduling automatic archives, see the online Help.

Working with Image Files

The Sonic recording programs can convert all the files from a CD or DVD and convert them into a single .iso file, or a series of .gi files (none exceeding 2 GB) known as an *image file*. You can use the image file to reproduce the original disc. Image files are typically used when you need to make multiple copies of the same disc.

NOTE: Your DVD Writer or CD Writer drive will not copy commercially available DVD movies. Most commercial DVDs are encoded to prevent unauthorized duplication.

Creating an image file

To make an image file using Sonic DigitalMedia Plus:

- 1 Open the DigitalMedia Plus program by clicking **Start, All Programs, Sonic**, and then **DigitalMedia Home**.
- 2 Click **Copy**, and then click **Save Image**.
- 3 Insert the CD or DVD from which you want to make an image file.
- 4 Click **Browse** to select the location where the image file will be created and choose the image type (.gi or .iso) to be saved. Click **Save**.
- 5 Click the **Save Image** icon to create the image file.
- 6 Click **Done** when the image file is created.



Burning from an image file

To burn a CD or DVD from an image file using Sonic DigitalMedia Plus:

- 1 Open the DigitalMedia Plus program by clicking **Start, All Programs, Sonic**, and then **DigitalMedia Home**.
- 2 Click **Copy** and then **Burn Image**.
- 3 Click **Browse** to select the image file.
- 4 Insert a recordable CD or DVD into the drive.
- 5 Click the **Burn Image** icon.
- 6 Click **Done** when recording is complete.



Disc Labeling with LightScribe

LightScribe (select models only) is a direct disc labeling technology providing you a simple way to burn precise, silk screen-quality labels. It combines the CD or DVD drive of your PC with specially coated discs (sold separately) and enhanced disc-labeling software.

A LightScribe-enabled CD or DVD disc drive uses the optical laser in the drive to burn a label onto a thin dye coating on the label side of the disc. There is no ink to smear or paper to curl, and there are no adhesives to loosen.

LightScribe media is identified by the LightScribe logo on the retail packaging and on the inner hub area of the disc itself. Your PC may come ready to work with many versions of LightScribe media (select models only); however, as new media versions are introduced, you need to update the driver software for your LightScribe-enabled CD or DVD drive. Get driver updates from the HP Support Web site:

<http://www.hp.com/support>

NOTE: LightScribe creates a grayscale image similar to a black-and-white photograph.

LightScribe requirements

Burning a label with LightScribe requires three things:

- LightScribe-enabled CD or DVD drive (select models only).
- Labeling software that supports LightScribe.
- LightScribe discs (sold separately).

Burning a LightScribe label with Sonic Express Labeler

- 1** Click **Start**, **All Programs**, **Sonic**, and then click **Express Labeler**.

NOTE: You can open Express Labeler from within DigitalMedia Plus by clicking **Tools** and then **Label Disc**.

- 2** In the Step 1: Select Project area, make sure that **Disc Label** is selected.
- 3** In the Step 2: Edit area:
 - a** Click **Disc Titles** to display the Edit Disc Title window. Enter text for the title and subtitle, and then click **OK**.
 - b** Click **Tracks** to display the Edit Tracks window. Click **New** to display the Track window. Enter text to identify the first track or file (you can optionally enter artist and date, or length), and then click **OK**.

- c** Repeat the previous step for each track or file on the disc.
 - d** Click the left or right arrows next to **Layout** and **Background** to select design elements for the disc. The selections you make are previewed in the disc window.
- 4** When you are satisfied with the appearance of your label, insert the LightScribe media disc (label side down) into the disc drive tray, and then click **Print**.

NOTE: LightScribe creates a grayscale (monochrome) image similar to a black-and-white photograph.

- 5** From the Disc Label menu, select **LightScribe 12cm disc**.
- 6** Click **OK** to begin burning the label.

The estimated time to complete the label displays, along with a progress bar to show you the time remaining. You can continue to work on your PC while LightScribe is burning the label.

Using adhesive disc labels



WARNING: When labeling your CDs and DVDs, do not use sticky labels. They can cause the disc to play erratically. Instead, write on the disc with a felt-tip pen to label it.

Or, you can create a LightScribe label for your disc if you have a LightScribe optical drive and you use LightScribe media discs. Refer to “Disc Labeling with LightScribe” on page 75.

Compatibility Information

An important feature of a DVD Writer/CD Writer drive is its high level of compatibility with other optical drives and CD and DVD players:

- The CDs that you create play in most home and car stereos and in most PC DVD-ROM and CD-ROM drives.
- The DVDs that you create are compatible with some DVD video players and with most PC DVD-ROM drives.
- CD-R discs are more compatible with home and car stereos than CD-RW discs are.

Your DVD Writer/CD Writer drive is able to read from and record to almost every type of optical disc. Writing speed rates for the DVD Writer/CD Writer drive are fast, allowing quick recording times.

NOTE: CD-R discs are more compatible with home and car stereos than CD-RW discs.

Disc Features and Compatibility Table

Disc	File type	Can be recorded onto	Plays in PC	Plays in home or car stereo	Plays in home DVD player
CD-ROM	Data	No	Yes	No	No
	Music	No	Yes	Yes	Varies by model
CD-R	Data	Yes	Yes	No	No
	Music	Yes	Yes	Varies by model	Varies by model
CD-RW	Data	Yes	Yes	No	No
	Music	Yes	Yes	Varies by model	Varies by model
DVD-ROM	Data	No	Yes	No	No
	DVD movie	No	Yes	No	Yes
DVD-RAM	Data	Yes	Varies by model	No	No
	DVD movie	Yes	Varies by model	No	Varies by model
DVD+R and DVD-R	Data	Yes	Yes	No	No
	DVD movie	Yes	Yes	No	Varies by model
Double-layer DVD+R/ DVD-R	Data	Yes	Varies by model	No	Varies by model
	DVD movie	Yes	Varies by model	No	Varies by model
DVD+RW and DVD-RW	Data	Yes	Yes	No	No
	DVD movie	Yes	Yes	No	Varies by model
VCD	DVD movie	No	Yes	No	Varies by model

NOTE: Some PCs come with the double-layer DVD Writer. It supports single-layer and double-layer DVD media. Double-layer technology gives you greater capacity and allows you to store up to 8 GB* of data on double-layer DVD+R or DVD-R media. Double-layer is a new technology. Double-layer media compatibility will vary widely with some home DVD players and DVD-ROM drives.

* 1 GB is defined as 1 billion bytes. 1 GB = 1 billion bytes when referring to hard disk drive capacity. Actual formatted capacity is less.

For the latest disc compatibility information for your PC, go to the HP Support Web site at:

<http://www.hp.com/support>

NOTE: Double-layer DVD technology is supported by select models only.

NOTE: The Sonic recording programs support the double-layer technology.

Optical Drive Quick Reference Table

Optical drive can:	CD-ROM	CD-RW	DVD-ROM	DVD-RAM	DVD+RW/+R DVD-RW/-R	Double-layer DVD	Combo CD-RW/ DVD
Read CDs, CD-Rs, and CD-RWs	Yes	Yes	Yes	Yes	Yes	Yes	Yes
Read DVDs	No	No	Yes	Yes	Yes	Yes	Yes
Read data on a CD	Yes	Yes	Yes	Yes	Yes	Yes	Yes
Play music	Yes	Yes	Yes	Yes	Yes	Yes	Yes
Record data or music to disc for storage or backup	No	Yes	No	Yes	Yes	Yes	Yes
View DVD movies	No	No	Yes	Yes	Yes	Yes	Yes
Record DVD movies	No	No	No	Yes	Yes	Yes	No
Play games	Yes	Yes	Yes	No	Yes	Yes	Yes

Software Quick Reference Table





Your PC includes a number of software programs that:



- Record and play CDs
- Record data CDs
- Import and edit video files
- Record video CDs and DVDs
- Organize digital media files

The following table describes the functionality specific to each of these programs. Use it to determine which program to use to perform a task.

Note that some programs listed may not be included with your model, and that this is not a complete list of all included software.

To open any of these programs, click **Start** on the taskbar, choose **All Programs**, select the program folder (for example, **Sonic**), and then click the program name to open the software.

With this program:	You can:
DVD Play (select models only) 	<ul style="list-style-type: none"> • Play DVD movies and video CDs (VCDs).
Real Rhapsody (select models only) 	<ul style="list-style-type: none"> • Play music CDs, .mp3s, and other audio files. • Record music files. • Record a copy of an existing music or data CD to use on the PC. • Organize digital files into a library for recording or listening.
muvee autoProducer (select models only) 	<ul style="list-style-type: none"> • Add your own style to your movies with music, pictures, titles, scene transitions, and captions. • Edit your home movies.
RealPlayer (select models only) 	<ul style="list-style-type: none"> • Play music CDs, .mp3s, and other audio files. • Play DVD movies. (RealPlayer can play DVDs only if another DVD player program, such as DVD Play, is installed.) • Play video CDs. • Record music files. • Organize digital files into a library for recording or listening.

With this program:	You can:
<p>Sonic DigitalMedia Plus (select models only)</p> 	<ul style="list-style-type: none"> • Record data and music files. • Record a copy of an existing music or data CD to use on the PC. • Create customized music CDs from CDs in your collection, or from .wav, .mp3, or .wma files. These CDs can be played in your home or car stereo. • Copy and share data files. • Create archive CDs or DVDs from files on your PC. • Copy video files. • Verify that the disc has been created without errors.
<p>Sonic MyDVD Plus (select models only)</p> 	<ul style="list-style-type: none"> • Record movie files. • Copy and share video files. • Capture video files.
<p>Windows Movie Maker 2.0</p> 	<ul style="list-style-type: none"> • Import audio, video, and other media files from a videotape, an audiotape, a Web camera, or a television broadcast. • Record audio and video files to create a video project that becomes a Windows Media source file with a .wmv extension. • Edit and preview files. • Send a movie in an e-mail or upload it to a Web server. • Add music files (.mp3). • Import audio files such as .mp3, .asf, or .wma; video files such as .wmv, .asf, .avi, or .mpg; or image files such as .jpg or .gif. • Create .avi and .wmv (Windows Media Video) files.

NOTE: You may have a software update CD included with your PC. You may need to install this CD before using the DVD Writer/CD Writer drive. To do this, follow the installation instructions that came with the CD.

Creating Video Discs and Movies

Your PC may include the following movie-making programs:

- Sonic MyDVD (select models only)
- Sonic DigitalMedia Plus (select models only)
- Windows Movie Maker
- muvee autoProducer (select models only)

These programs all capture, edit, and manage your home video files, while allowing you to add your own personal touch to your home movies. They come installed on your PC and can be started by clicking **Start** and then **All Programs** on your desktop.

IMPORTANT: HP supports the lawful use of technology and does not endorse or encourage the use of our products for purposes other than those permitted by copyright law.

Before You Begin Capturing Video

You can capture (copy) video files to your hard disk drive by using the Sonic MyDVD program. Among the devices supported by Sonic MyDVD are analog video devices, digital camcorders, and Web cameras. Use your composite or S-video inputs (input connectors vary by model) to capture video from a VCR or an analog video camera.

To capture video files, you need to:

- 1** Connect your video source device according to the device's instructions.
- 2** Turn your device on and set it to playback mode.
- 3** Make sure Sonic MyDVD can detect your digital or analog device.
- 4** If your PC has multiple video devices connected, they all appear on the Capture screen. You must select the video source you would like to use.

NOTE: You may need to turn your digital video device off and on again for the program to detect it.

Sonic MyDVD Video Projects

A Sonic MyDVD *video project* is a way to group, organize, store, play, and burn related video and still digital files. For example, if you went on a family vacation, you might have digital still and video images, and prints from a film camera. You can transfer all these images onto your PC and organize them into a project. (A scanner is required to transfer printed photos and is not included.)

Projects can remain on your PC for playback and as an archive, and they can be burned to a DVD or video CD (VCD).

Sonic MyDVD enables you to create video projects using the following interfaces:

- Standard program interface (described beginning in "Creating a Video Project" on page 82).
- Direct-to-Disc Wizards (described beginning in "Creating a Video Project with the Direct-to-Disc Wizards" on page 87).

Note that the Direct-to-Disc Wizards do not include the editing features that are available from the standard interface. You can edit a project created with a wizard before burning it to a disc as described in:

- "Editing the style of a video project" on page 85.
- "Editing movie files" on page 85.

Creating a Video Project

To create a video project:

- 1** Click **Start**, choose **All Programs**, **Sonic**, and then **DigitalMedia Home**.
- 2** Click the **Video** button to display the Video Guide.
- 3** Click **Create Project**, and then **DVD** or **VCD** depending on the type of project you want to create.
A project named Untitled DVD-Video or Untitled Video CD is created and displayed in the MyDVD project window.
- 4** Click **File** and then **Save As** to change the name of your project from Untitled to a more descriptive name. After renaming your project, click **Save**.

Continue your project by performing the procedure described in one or more of the following sections:

- "Adding files to a video project" on page 83.
- "Capturing video to a video project" on page 83.
- "Adding slideshows to a video project" on page 84.
- "Adding submenus to a video project" on page 84.

Adding files to a video project

You can add files to your DVD or VCD video project from:

- An existing DVD or VCD.
- Video files already stored on your PC.
- Video capture from a digital video camera (as described in the next section).

To add files from a DVD, VCD, or from your hard disk drive:

- 1** Click **File, Open Project**, and then select a video project that you created as described in “Creating a Video Project” on page 82.
- 2** Click **Add Files**.
- 3** Navigate to the folder that contains the video files you want to add, or to the media drive that contains the DVD or VCD.
- 4** Select the files you want to add, and then click **Open**. The files are added to the current project and displayed in the project window.

Capturing video to a video project

You can capture live video or still images by connecting a Web camera or digital video camera to your PC’s USB connector. The video capture is added to your video project and stored in a file on your hard disk drive.

To add a video capture to a video project:

- 1** Click **File, Open Project**, and then select a video project that you created as described in “Creating a Video Project” on page 82.
- 2** Connect your digital camera to the USB port.
- 3** Click **Capture Video** to display the Capture screen.
Sonic MyDVD displays the name of the capture device (your camera), the default capture type (audio and video), and the default quality setting (DV format).
- 4** Click **Record Settings** to edit any of these default settings.
- 5** Optionally, set capture length, chapter points, or scene detection. Click the corresponding **Help** icon to display the online help for each of these features. 
- 6** Click one of the following:
 - **Grab Frame** — The image currently displayed in the Capture window is stored as a picture file (.jpg, .bmp, .gif, .tif, or .png format).
 - **Start Capturing** — Starts a video capture (.mpeg format).
- 7** Click **Stop Capturing** to manually stop the capture if you did not set a capture length (step 5).

- 8 In the Save As dialog box, name the captured file, and select the file format and the folder where you want to save it. Click **Save**.
- 9 Click **OK** to return to the project window.
The file is stored on your hard disk drive and added to the current project.

Adding slideshows to a video project

You can create a *slideshow* (a series of still images displayed automatically) by adding existing still photos to your project or by capturing them with a connected digital video source.

To add a slideshow to a video project:

- 1 Click **File, Open Project**, and then select a video project that you created as described in "Creating a Video Project" on page 82.
- 2 Click **New Slideshow** to open the Create Slideshow window.
- 3 Do one or more of the following:
 - Click **Add Files** to add existing picture files to the slideshow.
 - Click **Capture Pictures** to capture still images from your camera.
- 4 Click **Options** to set the slide duration, or to add a background audio track. Online Help is available for these features by clicking the **Help**  icon in the MyDVD window.
- 5 Click **OK** to add the slideshow to the video project.

Adding submenus to a video project

Each *project element* (video file, still picture file, and slideshow) that you add to a video project is represented in the main project window.

Each menu displays six items before a new menu is automatically created and linked to the previous menu by a **Next** button. 

You can manually add submenus to a project and use them to organize topics associated with the theme of your project. For example, if the project is your child's soccer game, the video files of the game could be the main menu elements, and you could insert a submenu that contains interviews with your son and his teammates.

To add a submenu to a video project:

- 1 Click **File, Open Project**, and then select a video project that you created as described in "Creating a Video Project" on page 82.
- 2 Click **New Sub-Menu**. A submenu called Untitled Menu 0 is added to the first menu that has less than six project elements.
- 3 Click the submenu name (**Untitled Menu 0**), and type an appropriate name for the menu.

- 4 Double-click the new submenu, and do one or more of the following:
 - Add existing video files as described in “Adding files to a video project” on page 83.
 - Capture video as described in “Capturing video to a video project” on page 83.

Editing the style of a video project

You can change the style of a number of elements within your video project. The elements include:

- Background color and graphics on the menus and submenus
- Button styles
- Background music
- Text format (font, color, and size)
- Import custom styles

To edit the look of a video project:

- 1 Click **File, Open Project**, and then select a video project that you created as described in “Creating a Video Project” on page 82.
- 2 Click **Edit Style**.
- 3 In the Edit Style dialog box, change any of the previously mentioned elements, and then click **Apply To All Menus** or **Apply To This Menu**.



Editing movie files

After you capture or import video files, you can edit them using Sonic MyDVD to:

- Add additional files
- Add background music
- Search for specific scenes
- Delete scenes
- Add transition effects between scenes
- Superimpose colors, themes, and effects over video scenes
- Superimpose text effects over video scenes

To edit your video files:

- 1 Click **File, Open Project**, and then select a video project that you created as described in "Creating a Video Project" on page 82.
- 2 Click **Edit Movie**.
- 3 If you have already captured videos for this project, they appear along the bottom as a storyboard. If you have video files on your hard disk drive you would like to add to this project, click **Add Files**.
- 4 Click one of the four tabs (**Fades & Dissolves**, **Filters, Text**, or **Themes and backgrounds**) next to the preview screen.



- 5 Drag and drop any of the effects over scenes (or between them for transitions) in the storyboard.
- 6 Click **OK** to save the edits.

For more information about any of the editing features, click **Help** and then **Sonic MyDVD Help** from within the Edit window.

Burning a video project to disc

After you are satisfied with the contents and style of your video project, you can burn it to a DVD or VCD disc as follows:

- 1 Click **File, Open Project**, and then select a video project that you created as described in "Creating a Video Project" on page 82.
- 2 In the Quality fields, set the recording quality and the DVD or VCD type:
 - The quality settings range from **HQ** (the highest quality, but uses the most disc space) to **EP** (lowest quality, but you can fit more files).
As you select different quality settings, the disc space remaining indicator displays how much blank space there is on the disc for this mode.
 - The DVD formats include **2xDVD (8.5GB)** (double layer); **DVD (4.7GB)** (the default setting); **DVD-RAM (2.6GB)**; and **DVD (1.4GB)**.
Some of these formats may not be supported by your model of PC.
- 3 Insert the selected type of disc into the appropriate drive tray, close it, and click **Burn**.



For detailed information about DVD and VCD recording quality and time, see:

- "Video Quality and Disc Size" on page 88.
- "DVD Recording Time" on page 89.

Creating a Video Project with the Direct-to-Disc Wizards

Sonic MyDVD includes Direct-to-Disc Wizards that guide you through the steps you must complete to create a DVD or VCD *video project*. A video project is a way to group, organize, store, play, and burn related video and still digital files.

- 1 Connect your digital camcorder or Web camera to your PC.
- 2 Click **Start**, choose **All Programs**, **Sonic**, and then **DigitalMedia Home**.
- 3 Click the **Video** button and then **Direct-to-Disc**.
- 4 Click **DVD** or **VCD** depending on the type of project you want to create. The Direct-to-VCD or Direct-to-DVD Wizard displays.
- 5 Click **Edit Style**, and edit any of the following elements:
 - Background color and graphics on the menus and submenus
 - Button styles
 - Background music
 - Text format (font, color, and size)
 - Custom styles

Alternately, you can click **No Menus** in the Direct-to-Disc Wizard if you do not want to be able to select from multiple files in the project.

- 6 Type a name for your project in the project name field.
- 7 Click one of the following:
 - **Record to DVD** (or **Record to VCD** if you are creating a VCD project): Select the device, number of copies, and write speed.
 - **Record to hard disk**: The video capture is stored by default in the My DVDs folder. Click **Location** if you want to select a different folder.
- 8 Click **Next**. The Capture screen displays.

Make sure the output from your digital camcorder appears in the Preview window. If it does not, double-check your connections and make sure your camera is in playback mode.
- 9 Click **Record Settings** to edit any of the default settings.
- 10 Optionally, set a capture length, chapter points, or scene detection. Click the corresponding **Help** icon to display the online Help for each of these features. 
- 11 Click one of the following:
 - **Grab Frame** — The image currently displayed in the Capture window is stored as a picture file (.jpg, .bmp, .gif, .tif, or .png format).
 - **Start Capturing** — Starts a video capture (.mpeg format).
- 12 Click **Stop Capturing** to manually stop the capture if you did not set a capture length (step 10).
- 13 A confirmation message displays stating the disc or file was created successfully. Click **OK**.

Note that the Direct-to-Disc Wizards do not include the editing features that are available from the standard interface. You can edit a project created with a wizard before burning it to a disc as described in:

- "Editing the style of a video project" on page 85.
- "Editing movie files" on page 85.

Video Quality and Disc Size

Sonic MyDVD includes four DVD video quality (bit-rate) settings and a Fit-to-DVD option that can be applied to a video project or to individual movie files. The DVD quality settings are:

- **HQ (High Quality)** — Best audio and video quality available, but requires the most disc space per second of video. Good choice for video files that contain high-speed action (for example, motor sports). High Quality is the default setting for new projects.
- **SP (Standard Play)** — Good audio and video quality with most video sources.
- **LP (Long Play)** — Fits approximately twice as much video onto a DVD as HQ. Not recommended when the original video is low-quality or noisy.
- **EP (Extended Play)** — Fits the most video onto a DVD, but video quality is low. Not recommended unless the original video is very good quality.
- **Fit-to-DVD** — (Available only with upgrade to MyDVD Deluxe.) As you add more content to the project, MyDVD reduces the project quality automatically to fit the selected disc size.

NOTE: VCDs have a fixed bit rate that delivers one quality level. You can fit approximately 1 hour of video on a VCD (the recording time is reduced if you use animated menu buttons or backgrounds).

NOTE: You can record the same file on a disc at each different quality level to compare the results.

DVD Recording Time

The following table lists the approximate DVD video recording time for different disc sizes at different video quality settings (your DVD recorder may not support all these disc sizes).

Video quality	Audio format	Estimated time per disc size			
		8.5 GB	4.7 GB	2.6 GB	1.4 GB
HQ	Dolby Digital	130 min.	70 min.	40 min.	20 min.
	PCM	110 min.	60 min.	30 min.	15 min.
SP	Dolby Digital	210 min.	120 min.	65 min.	35 min.
	PCM	160 min.	95 min.	50 min.	25 min.
LP	Dolby Digital	310 min.	180 min.	100 min.	50 min.
	PCM	215 min.	125 min.	65 min.	35 min.
EP	Dolby Digital	415 min.	240 min.	130 min.	70 min.
	PCM	265 min.	150 min.	85 min.	45 min.

- The video quality depends on PC speed and graphics processing abilities. Some PCs may be unable to capture video at the HQ setting.
- These are estimated recording times. The maximum duration is reduced if you use animated menu buttons or backgrounds.
- To change the audio format, see the online Help.
- Your version of MyDVD may not support Dolby Digital audio. See the online Help for details.



Creating Movies Using muvee autoProducer

Creating personalized and professional-looking video movies is simple with muvee autoProducer (select models only).

Basic Steps to Make a Movie

The basic steps to produce a movie with muvee autoProducer are:

- 1 Capture digital video:** Capture live or recorded video to your hard disk drive directly from a compatible digital video camcorder.
- 2 Add videos and pictures:** Select video and picture files from your PC folders. You can easily add videos and still images to your movie production.

You can use these video and still image file types in your movie project:

File extension	File type
.dv	Digital Video
.avi	Audio Video Interleaved
.mpeg-1	Motion Picture Experts Group
.mpeg-2	For DVD video playback
.mpeg-4	High-quality video format (for Web streaming, wireless devices, etc.)
.wmv	Windows Movie Video
.asf	Advanced Streaming Format
.mov	QuickTime video clip
.jpg, .jpeg	Joint Photographic Experts Group, still image
.gif	Graphics Interchange Format, still image
.bmp	Bitmap, still image

- 3 Add music:** Select music files on your PC to add to your movie soundtrack. You can use these music file types in your movie project:

File extension	File type
.aac	Advanced Audio Coding
.mp3	MPEG Layer 3 audio
.m4a	MPEG-4 Audio layer
.wav	Windows Audio
.wma	Windows Media Audio

- 4 Select a style:** Apply a movie style editing template for different effects and picture transitions in your movie.
- 5 Add captions:** Personalize your movie with opening titles and closing credits.
- 6 Make the movie:** Automatically analyze the videos, pictures, music, movie style, and captions you added to your movie, and save your movie to your PC hard disk drive, CD, or DVD.
- 7 Modify the movie:** Make final changes before saving.
- 8 Burn to disc:** You can burn a video to DVD, VCD, or SVCD.

The following sections contain detailed instructions.

Locating muvee autoProducer

You can access muvee autoProducer as follows:

- Click **Start** on the desktop taskbar, and select **All Programs**, **muvée Technologies**, **muvée autoProducer**, and **muvée autoProducer** to open muvee autoProducer.



Using muvee autoProducer







Getting started

To open muvee autoProducer:

- 1 Click **Start** on the taskbar.
- 2 Select **All Programs, muvee Technologies, muvee autoProducer**, and then **muvee autoProducer** to open muvee autoProducer.

NOTE: You can also open muvee autoProducer from within Digital Media Plus. Select the **Video** tab and then **muvee autoProducer**.

- 3 Open a project by selecting, from the File menu, either **New Project** or **Open Project**.
- 4 Select one of the button options:

Button	Allows you to	See
Add Video 	Open the Add Video window to add existing video files to your project.	"Adding videos" on page 95.
Add Pictures 	Open the Add Pictures window to add existing still image files to your project.	"Adding pictures" on page 97.
Add Music 	Open the Add Music Files window to add existing music files to your project.	"Adding music" on page 97.
Change Settings 	Open the muvee Settings window to adjust audio and video production settings for your movie.	"Changing the settings" on page 98.
Title/Credits 	Open the muvee Title and Credits window to type in an opening title and closing credits for your movie.	"Adding an opening title and closing credits" on page 99.
make muvee 	Open the Make muvee window to automatically create and preview the movie.	"Making the movie" on page 100.
Save/Burn muvee 	Open the Listed muvee Files window to save the finished movie on your PC hard disk drive, or to record the finished movie to a disc.	"Saving the movie project" on page 102. "Recording the movie project to disc" on page 103.

Capturing video from a DV camcorder

You can capture (copy) digital video files to your hard disk drive by using muvee autoProducer either:

- **Live** (known as *camera mode*) using a compatible DV camcorder. See "Capturing live video from a DV camcorder" on page 94.

Or

- **Recorded** (known as *VCR mode*) using a recorded tape in your DV camcorder. See "Capturing recorded video from a DV camcorder" on page 95.

Captured video files are automatically added to your movie project. To remove the file from your movie project, select the video file in the Captured Video Files list, and then click the **trash can** icon.

When capturing video, it is important to be aware of the amount of free space available on your PC hard disk drive. Capturing video can use a large amount of disk space. The amount of free disk space displays on the Capture Video window in muvee autoProducer while you are capturing video.

Capturing live video from a DV camcorder

Capturing live video in camera mode allows you to create a video file without even having a tape in the camcorder.

To capture (copy) live video to your hard disk drive using muvee autoProducer:

- 1** Connect your DV camcorder to the FireWire (IEEE 1394) port on your PC.
- 2** Turn on the camcorder and set to VCR mode. For more information about using VCR mode with your camcorder, refer to the instructions that came with the camcorder.
- 3** Click **Tools**, then **Get Video from Camera**.
- 4** Click the **Start Capture** button to begin capturing the live image directly to your hard disk drive.
- 5** Click the **Stop Capture** button to stop capturing.
- 6** Click **Capture Folder** to specify a folder for the captured video file.
- 7** Click **Filename** to specify a file name for the captured video file.
- 8** Click the **Done** button to automatically add captured video files to your movie project.

Capturing recorded video from a DV camcorder

For best results with muvee autoProducer, capture only video footage that you are most interested in using in your movie project.

To capture camcorder (copy) recorded video to your hard disk drive:

- 1 Connect your DV camcorder to the FireWire (IEEE 1394) port on your PC.
- 2 Turn on the camcorder and set to VCR mode. For more information about using VCR mode with your camcorder, refer to the instructions that came with the camcorder.
- 3 Click **Tools**, then **Get Video from Camera**.
- 4 Click the **Play** button on the screen to begin viewing the video.
- 5 Click **Start Capture** when you see the start of the video footage you want to use in your movie project.
- 6 Click **Stop Capture** to stop capturing.
- 7 Repeat steps 5 and 6 to capture additional sections of video footage.
- 8 Click the **Capture Folder** to specify a folder for the captured video file.
- 9 Click **Filename** to specify a file name for the captured video file.
- 10 Click the **Done** button to automatically add captured video files to your movie project.

Adding videos

To add video files to your movie production:

- 1 Select the **Add video** button in the video/pictures area. The Add Video window opens. 
- 2 Browse the folders.
- 3 Select existing video files on your hard disk drive, if desired for your movie:
 - Add up to three video files.
 - Select multiple video files by pressing and holding Ctrl on your keyboard while selecting the files.
- 4 Adjust the order of the video files by selecting and then dragging and dropping the file.

To remove a video clip from the production, select the clip, and click the **trash can** icon.

- 5** You can mark specific scenes in a video clip to include or leave out of your final movie, with the magicMoments feature in muvee autoProducer.

To select video scenes with magicMoments:

- a** Select a video file in the Select Video/Pictures window, and then click the **magicMoments** button. The magicMoments window opens.
- b** Click the **Play** button to start viewing the video.
- c** Use the magicMoments controls to mark video scenes to include and exclude:



- Click and hold down the **green thumbs-up** button to mark scenes that must be included in the movie.
- Click and hold down the **red thumbs-down** button to mark scenes that must be left out of the movie.
- Click and hold down the **gray thumb** button to undo one second of a selected scene. Shift and click to undo scenes that were marked with the thumbs-up or thumbs-down buttons.
- Click and hold down the **arrow** buttons to navigate backward and forward through the video footage.



Video footage left unmarked is still analyzed when you make the movie and may be included in the final version of the movie.

For best results with the production of your movie:

- Keep each magicMoment to less than 10 seconds.
 - Keep the total duration of magicMoments to less than 50 percent of the duration of your movie. It is recommended to select only a few scenes.
- d** Click **OK** when you finish marking scenes. The window closes. Note that the video clip is marked on the lower-left side.

Adding pictures

To add still image files to your movie production:

- 1 Select the **Add Pictures** button in the Video/Pictures area. The Add Picture window opens. 
- 2 Browse the folders, as required.
- 3 Select existing still image files on your hard disk drive, if desired for your movie:
 - Add up to 50 .jpg, .gif, or .bmp picture files.
 - Select multiple picture files by pressing and holding Ctrl on your keyboard while selecting the files.
- 4 Adjust the order of the picture files by selecting and then dragging and dropping the picture file.
To remove a picture from the production, select the picture, and click the **trash can** icon.
- 5 Select the **Rotate Image Clockwise** button to rotate still images. 
- 6 Use magicSpot to control the motion that is applied to your picture:
 - Select the **magicSpot** button to open the magicSpot window.
 - Click the **manual** button to display two overlapping frames over your picture. 
 - Move the frames around to set the start and end points for motion. The arrow in the frames shows the direction of motion.

Adding music

To add music files to your movie production soundtrack:

- 1 Select the **Add Music** button in the music area. The Add Music window opens. 
- 2 Browse the folders, as required.
- 3 Select existing music files on your hard disk drive, if desired for your movie:
 - Add up to three .mp3, .wav, or .wma files.
 - Select multiple music files by pressing and holding Ctrl on your keyboard while selecting the files.
- 4 Adjust the order of the music files by selecting and then dragging and dropping the file. Select the music, and click the **trash can** icon to remove a music clip from the production.

Selecting the style

The muvee autoProducer program comes with a set of style templates for setting the pace, scene transition effects, and caption fonts. The style you use also affects how muvee autoProducer combines the video, picture, and music files in your movie project to produce the final movie.

For example, using the Cinema style results in a movie that is moderately paced, color enhanced, and uses a wide-screen format.

To select a style, just click a style from the list. A sample of the style displays in the preview window.

Changing the settings

You can adjust audio and video production settings for your movie.

- 1 Select the **Change Settings** button. The muvee Settings window opens. 
- 2 Select the **Duration** tab to set the length of your video production and preferences. Click one of the following duration settings:
 - **Fit to music.** The produced version may reuse or drop some video and pictures.
 - **Best fit for videos and pictures.** The produced version may repeat or trim music.
 - **User Defined.** Select the duration in minutes and seconds:
 - If the duration of your music is longer than the duration of video and pictures, place a check in the **Allow video and pictures to repeat** check box to repeat video clips and pictures for the full duration of your music files.
 - If the total duration of your video and picture files is longer than the duration of your music, place a check in the **Allow music to repeat** check box to repeat music for the duration of the video clips.
- 3 Select the **Video** tab to set the video and still image preferences. Click one of the following settings:
 - **Style default.** Use the selected style to sequence still images and video clips.
 - **Keep shots in sequence.** Use the sequence of still images and video clips in the Add Video/Pictures window.
 - **Shuffle shots.** Move the slider bar to determine the frequency of sequencing still images and video clips.
 - Place a check in the **Interleave pictures** check box to blend pictures with video at intervals.

- 4 Select the **Audio** tab to set the sound preferences. Click one of the following settings:
 - **Use all music.** Place a check in the check box to use the sequence of sound files in the Add Music window.
 - **smartJoin™ multiple music files.** Place a check in the check box to automatically remove silence between music tracks.
 - **Normalize music.** Place a check in the check box to automatically adjust audio playback volume to the same level.
 - Move the slider bar to adjust the **Sound mix level** of the music and original soundtrack.
- 5 Click **OK** when you are finished adjusting the settings for your movie project.
Or
Click **Cancel** to not change any settings.

Adding an opening title and closing credits

You can personalize your movie project by adding an opening title and closing credits.

- 1 Click the **Title/Credits** button. The muvee Title and Credits window opens. 
- 2 Click the **Title tab**:
 - a Select a title effect from the drop-down window.
 - b Type the text you want to appear at the start of your movie in the **Enter your title here** box.
 - c Click the **Use font** button to select the font, style, size, color, and effects from the Font window.
 - d Select a background image or color for the title.
- 3 Click the **Credits tab**:
 - a Select a credits effect from the drop-down window.
 - b Type the text you want to appear at the end of your movie in the **Enter your credits here** box.
 - c Click the **Use font** button to select the font, style, size, color, and effects from the Font window.
 - d Select a background image or color for the ending credits.
- 4 Click **Apply**.
- 5 Click **OK** to close the muvee Title and Credits window.

Making the movie

After you have added at least one video or picture file to your movie project, you can have muvee autoProducer make the movie.

The muvee autoProducer program makes a movie by combining the video, picture, and music files you have selected, along with the style of movie, and puts together all of these pieces into a professional-looking movie with just a few steps.



To make a movie:

- 1 Click the **make muvee** button. Click **OK** as required.
- 2 After making a movie you can preview the movie in the muvee autoProducer Preview window. Use the controls in the Preview window to play, pause, and stop the movie preview:
 - Each time you make a change to a movie project, you need to click the **make muvee** button again to add that change to your movie.
 - You can revise and preview the movie as often as you want to experiment with different styles and the content of the movie.

Previewing the movie

After you have made the movie, you can preview how the movie looks and sounds and take snapshots of frames in the movie.

To preview a movie:

- 1 Click the **Start Playback** button. The movie begins playing.
- 2 Use the **Stop** and **Previous Frame/Next Frame** buttons to navigate through the movie.
- 3 Click the **Take Snapshot** button to save the current frame as a picture file (.jpeg, .bmp, or .gif).
- 4 Click the **Locate Shot** button to open the MagicMoments window. See "Adding videos" on page 95 for more information on using MagicMoments.



Modify the movie

After you have created the movie, muvee autoProducer allows you make some quick final changes to your project before saving. muvee autoProducer can automatically replace shots with other similar or contrasting ones. Alternatively, you can manually choose your replacement shots.

To modify a movie:

- 1 Click the **Tweak muvee** button.
The Tweak muvee window opens.
- 2 Click the **Start Playback** button. The movie begins playing. Click the **Pause Playback** button to stop the movie at any time.
You can also click on the seek bar or drag the slider to move to a particular point in the movie.
- 3 Use the controls in the Tweak muvee window to modify the movie project:



NOTE: In the Tweak muvee window, you can only replace a video segment with another video segment and pictures with other pictures from the original footage. You cannot expand the duration of the chosen or replacement clip.

- Click the **auto-replace with similar** button to automatically replace a picture or video segment with another similar picture or video segment.



- Click the **auto-replace with different** button to automatically replace a picture or video segment with a completely different picture or video segment.



- Click the **manually replace** button to replace a picture or video segment with a picture or video segment of your choice.



- Click the **Undo** or **redo** buttons as needed.
- 4 When you are done modifying the movie project, click **OK** to save your changes and close the Tweak muvee window. Alternatively, click **Cancel** to exit the Tweak muvee window without saving your changes.



Saving the movie project

Once you are satisfied with the look of your movie project, you are ready to save it. To save the movie as a file on your hard disk drive:

- 1 Click the **Save/Burn** button.

The Listed muvee Files window opens with all your muvee files listed.



- 2 Remove the check mark next to any muvee files you do not want to save.

- 3 Edit the muvee files before saving:

- Click the **Rename** button to change the name of the selected muvee file.
- Click the **Move up** or **Move down** button to change the order of the muvee files in the list.



- Press the **Select all** or **Deselect all** button to save all muvee files or to save none of the muvee files.

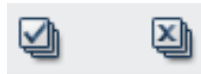

- Highlight a muvee file and click the **trash can** icon to delete the file.

- 4 The TV System area shows the current TV format (NTSC or PAL). To change the format, click the name of the current format and select the correct format in the window that opens.

- 5 Click **Save Now**.

The Save muvee window opens.

- 6 Choose where you want to play the movie (**PC**, **TV**, or **Mobile Devices**) and the file format. The following table lists the format types available in each category:

PC	TV	Mobile Devices
Computer playback	DV camera	Mobile phone
E-mail	DVD	Pocket PC
Web streaming	VCD	
AVI	SVCD	

- 7 Click the **Change Settings** button to change the video and audio settings of the movie file type as required (advanced users only).
- 8 Click **Browse** to choose a location on the hard disk drive to save the movie.
- 9 Click the **Save** button. You can watch the preview as it saves.
- 10 When saving is complete, you can click **Play muvees** to watch the files you saved or **Open output folder** to view the folder where you saved the files.
- 11 Click **Close** when you are done.

Recording the movie project to disc

To create a DVD, VCD, or SVCD disc:

- 1 Click the **Save/Burn** button.

The Listed muvee Files window opens with all your muvee files listed.



- 2 Remove the check mark next to any muvee files you do not want to save.
- 3 Edit the muvee files before saving:
 - Click the **Rename** button to change the name of the selected muvee file.
 - Click the **Move up** or **Move down** button to change the order of the muvee files in the list.



- Press the **Select all** or **Deselect all** button to save all muvee files or to save none of the muvee files.

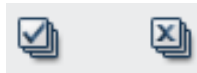

- Highlight a muvee file and click the **trash can** icon to delete the file.
- 4 Select the check box next to **Burn source files to disc** to create copies of all of the picture and video files used to create the muvee file.
 - 5 The TV System area shows the current TV format (NTSC or PAL). To change the format, click the name of the current format and select the correct format in the window that opens.
 - 6 Click **Burn Now**. The muvee Burner window opens.
 - 7 Enter a title for your disc under Disc title.
 - 8 Select the disc menu theme from the drop-down list. You can preview the different themes in the window.
 - 9 Select the **CD** or **DVD** burner drive.

- 10** Select the type of video disc to create: **DVD**, **VCD**, or **SVCD**.
The window shows the disc capacity, disc capacity used, and available disc space.
- 11** If you wish to create more than one disc using the same muvee file, use these steps:
 - Click **Options** and then click **Number of copies**.
 - Select the number of copies to burn and click **OK**.
- 12** Click **Burn Now** to begin burning your movie to disc.
To save the current settings for future use, click **Burn Later**.
- 13** Click **OK** when the recording is complete. Close the muvee Burner window.

Getting Help

Finding Onscreen Guides

Onscreen guides are available in the User's Guides folder (select models only).

- 1 Click **Start** on the taskbar.
- 2 Choose **All Programs**.
- 3 Choose **User's Guides**.
- 4 Click an item to view it or use it.

NOTE: If there are no guide titles listed in the folder, your PC has no onscreen guides.

Finding Guides on the Web

You can find guides and information for your PC using the Internet to access the Support Web site.

- 1 Go to **<http://www.hp.com/support>** in your Web browser.
- 2 Select your country/region and language.
- 3 From the Support and Drivers page, click **See support and troubleshooting information**, enter the model number of your PC, and then click **Search** .
- 4 Click **Manuals**.
- 5 Locate the manual you want and do one of the following:
 - Click the title to display the file in Adobe Acrobat Reader (you can download it from the Manuals page if it is not currently installed on your PC).
 - Right-click the title, select **Save Target As**, specify a location on your PC where you want to save the file, rename the file (retaining the .pdf extension), and then click **Save**.

Using the Onscreen Help and Support Center

Information about your PC is in the onscreen Help and Support Center (select models only). Here you can find links to driver updates, access to technical support options, and information about commonly asked questions.

To open the Help and Support Center:

- Press the Help button (select models only) on your keyboard.

Or

- Click **Start** on the taskbar, and choose **Help and Support**.

Using PC Help & Tools

The PC Help & Tools folder (select models only) in the All Programs menu contains special utilities for PC owners such as support information and programs.

To see the items in the PC Help & Tools folder:

- 1 Click **Start** on the taskbar.
- 2 Choose **All Programs**.
- 3 Choose **PC Help & Tools**.
- 4 Click an item to view it or use it.

Using Updates from HP (or Compaq Connections)

Updates from HP (or Compaq Connections) (select models only) is an Internet-based service provided by HP to bring you important information for your PC:

- Product notices
- Tips
- Special offers for your PC

Messages arrive while you're connected to the Internet and will display an alert or a notice on your desktop. You can view messages as they arrive or read them later.

Most Support updates delivered by Updates from HP (or Compaq Connections) messages are also available to you through the Support Web site under the information for your PC model.

Getting messages

After you view or close a message, it will not automatically display again.

To read a previously received message, open Updates from HP (or Compaq Connections):

- 1** Click **Start** on the taskbar.
- 2** Choose **All Programs**.
- 3** Choose **PC Help & Tools**.
- 4** Click **Updates from HP** (or **Compaq Connections**). Updates from HP (or Compaq Connections) displays.
 - If Updates from HP (or Compaq Connections) has been activated on your system, click **View messages** to view a list of previously received messages. To read a message, double-click the message title in the window. You can exit this window, and Updates from HP (or Compaq Connections) remains active.
 - If Updates from HP (or Compaq Connections) has not been activated on your system, the screen contains an **Activate** button to activate the service. Click **Activate** to start the service and view a list of messages that may have been received previously.

Turning off messages

NOTE: You cannot receive Updates from HP (or Compaq Connections) messages, including important information that may be critical to the operation of your PC, while the service is off.

To turn off the Updates from HP (or Compaq Connections) Service:

- 1** Click **Start** on the taskbar.
- 2** Choose **All Programs**.
- 3** Choose **PC Help & Tools**.
- 4** Click **Updates from HP** (or **Compaq Connections**). Updates from HP (or Compaq Connections) displays.
- 5** Click **Choose preferences** and then **Deactivate** to deactivate the service. The service is turned off until you reactivate it.

Reactivating messages

When you reactivate the Updates from HP (or Compaq Connections) service, the service runs whenever you are connected to the Internet, and you automatically receive messages as they become available.

To turn on the service:

- 1 Click **Start** on the taskbar.
- 2 Choose **All Programs**.
- 3 Choose **PC Help & Tools**.
- 4 Click **Updates from HP** (or **Compaq Connections**). Updates from HP (or Compaq Connections) displays.
- 5 Click **Activate** to reactivate the service.

Index

A

- adding
 - files to video projects 83
 - music 93, 97
 - pictures 93, 97
 - video 93, 95
- adhesive disc labels 76
- antivirus, installing program 9
- appending discs 71, 72
- audio connectors
 - retasking (multistreaming) 41

B

- best fit for videos and pictures 98
- bit rate
 - DVDs, VCDs 88
- Burn to disc 92
- burning
 - audio and data disc 68–72
 - CDs, DVDs 67–80
 - DVDs
 - quality settings 88
 - video quality 88
 - image files 74
 - labels, LightScribe 75
 - multiple sessions 71
 - time
 - DVD 89
 - VCD 88
 - tips, data discs 71
 - VCDs 86
 - video projects to disc 86
- buttons, keyboard
 - customizing 13
 - special keys 11

C

- cable tunnel 17
- camcorder capture 94
- camera docking station 16
- captions 92
- capturing video
 - DV camcorder 94
 - in video projects 83
 - live video 94
 - recorded video 94
 - requirements 81
- card reader, memory 49
- carpal tunnel syndrome 7
- CDs
 - burning tips
 - data discs 71
 - erasing rewritable 68
 - Compaq Organize 10
 - Computer Playback 102
- connecting
 - audio 19–21
 - digital video camera 29
 - peripherals 2
- connectors
 - audio 19–21
 - PC 2
- country/region codes 64
- creating
 - CDs 74
 - DVDs 74, 86
 - VCDs 86
- Credits effect 99
- customizing keyboard buttons 13

D

- data
 - archiving 73
 - burning in multiple sessions 71
 - burning tips 71
 - verifying integrity 71
- digital images 59
- digital images, managing 60
- digital picture 49, 59
- digital video camera
 - recording videos 29
- Direct-to-Disc Wizards (MyDVD) 82, 87
- discs
 - drive compatibility 76
 - erasing rewritable 68
 - features and compatibility 77
 - labeling
 - adhesive 76
- docking bay 15
- docking station, camera 15
- documentation, onscreen 105
- driver updates, LightScribe 75
- DVD Play, features 79
- DVDs
 - burning to disc 86
 - data discs, burning tips 71
 - erasing rewritable 68
 - movies, creating 81
 - quality settings 86
 - supported formats 85

E

- editing
 - video files (MyDVD) 85
- equalizer
 - Realtek HD Sound Effect Manager 39
- erasing rewritable discs 68
- errors
 - reducing recording speed 69
 - verifying data integrity of data discs 69, 71

F

- file extensions
 - .aac 92
 - .asf 91
 - .avi 91
 - .bmp 91
 - .dv 91
 - .gif 91
 - .jpg 91
 - .m4a 92
 - .mov 91
 - .mp3 92
 - .mpeg-1 91
 - .mpeg-2 91
 - .mpeg-4 91
 - .wav 92
 - .wma 92
 - .wmv 91
- file formats, video 83
- files
 - adding to partially recorded discs 71
 - image 74
 - supported video formats 83
 - verifying copied data 71
 - verifying integrity of backups 71
- FireWire 15, 94, 95
- Fit to music 98

G

- getting video from Camera 94

H

- Help and Support 106
- home stereo system
 - connecting to the PC 29
- home videos 29
- HP Organize 10
- HP Personal Media Drive 53
 - activity and power lights 55
 - automatic on and off feature 54
 - disconnecting the drive 58
 - inserting a drive 55
 - location and drive letter 56
 - storing files 57

I

- image files 74
- interleave pictures 98
- Internet
 - organizing destinations 10
 - signing up with an ISP 5

K

- keeping shots in sequence 98
- keyboard
 - customizing buttons 13
 - types of buttons 11
 - using 11

L

- labeling discs
 - adhesive labels 76
 - with LightScribe 75
- LightScribe
 - compatible media 75
 - disc labeling 75
 - driver updates 75
 - requirements 75

M

- magicMoments 96
- magicSpot 97
- make muvee 100
- manuals
 - storing 4
- memory card reader
 - card types 49
 - using 49
- movie
 - making movies with
 - muvee autoProducer 93
- multichannel speakers
 - configuring 40
- music 92
 - Allow Music to repeat 98
 - normalize 99
 - playing with Windows Media Player 64

- muvee autoProducer 91
 - adding titles and credits 99
 - copying a movie to disc 103
 - features 79
 - getting started 93
 - making a movie 100
 - setting the style 98
- MyDVD see: Sonic MyDVD

N

- Norton Internet Security
 - configuring 6
 - registering 6

O

- optical drive quick reference 78
- organizing Internet links and the PC 10

P

- passwords
 - creating 9
- PC
 - Help & Tools 106
 - setting up 1
 - transferring files and settings to new PC 10
- peripherals 4
 - using the docking station 16
- pictures, managing 60
- playing music CDs 63, 65

Q

- quality settings, recording DVDs 86

R

- RealOne Player, features 79
- recording
 - CDs, VCDs, and DVDs see: burning with Realtek HD Sound Effect Manager, 40
- repetitive strain injury (RSI) 7
- rewritable discs, erasing 68

S

- Safety & Comfort Guide 7
- safety warnings 7
- setting up PC 1
- settings
 - user defined, muvee autoProducer 98
- Shuffle shots 98
- slideshows in MyDVD 84
- smartJoin multiple music files 99
- software programs
 - DVDPlay 79
 - Windows Movie Maker 2.0 80
- Sonic Digital Media Plus see: Sonic MyDVD
- Sonic MyDVD
 - default verify data setting 69, 71
 - Direct-to-Disc Wizards 82, 87
 - editing video files 85
 - erasing discs 68
 - online Help 84
 - verifying data feature 71
 - video
 - projects 82
 - quality 88
 - settings (quality) 89
- speaker systems 19
- speakers
 - enable digital audio output 36, 39
 - multichannel audio
 - configuring 35
 - connecting 21, 23, 23–28, 32, 39
 - resolving sound issues 44
- stereo
 - connecting to the PC 29
- storing data files 71
- style 92, 98
- submenus in video projects 84
- Support
 - messages 106
- supported formats
 - DVD 85
 - video 83
- surge protector 1
- SVCD 103

T

- Title effect 99
- Title/Credits 93
- Title/Credits in muvee autoProducer 99
- transferring information to your new PC 10
- TV shows
 - copying to CDs or DVDs 91
- tweak muvee 101

U

- Updates from Compaq Connections 106
- Updates from HP, using 106
- updates, LightScribe drivers 75
- updating, system 106
- User accounts
 - creating 8
- user interfaces 82

V

- VCD 103
 - bit rate 88
 - burning 88
 - recording time 88
 - playing with Windows Media Player 65
- verifying copied data setting 71
- video
 - adding files to projects 83
 - allow to repeat 98
 - capturing 81, 83, 87, 94
 - DVD recording times 89
 - editing
 - files (MyDVD) 85
 - muvee autoProducer 93

- projects
 - background music 85
 - burning to disc 86
 - button styles 85
 - capture length 83
 - capturing video 83
 - chapter points 83
 - custom styles 85
 - Direct-to-Disc wizards 87
 - editing 85
 - MyDVD 82
 - scene detection 83
 - searching for scenes 85
 - slideshows 84
 - submenus 84
 - supported file formats 83
 - text formatting 85
 - transition effects 85
 - user interfaces 82
 - quality settings (MyDVD) 89
 - supported DVD formats 85
- volume
 - controls 13

W

- Web Streaming 102
- Windows Media Player
 - play music CDs 64
 - playing video CDs 65
- Windows Movie Maker 2.0, features 80
- Windows update 7
- working in comfort 7



Free Manuals Download Website

<http://myh66.com>

<http://usermanuals.us>

<http://www.somanuals.com>

<http://www.4manuals.cc>

<http://www.manual-lib.com>

<http://www.404manual.com>

<http://www.luxmanual.com>

<http://aubethermostatmanual.com>

Golf course search by state

<http://golfingnear.com>

Email search by domain

<http://emailbydomain.com>

Auto manuals search

<http://auto.somanuals.com>

TV manuals search

<http://tv.somanuals.com>