

---

# Technical Reference Manual

---

## Product Description - Vectra VL400

This technical reference and BIOS document for Vectra VL400 PCs contains summary information only. More detailed information on system hardware is available in the *Technical Reference Manual - Vectra Technology*.

**HP Vectra VL400 PCs**

---



---

## About this Document

This technical reference and BIOS document for Vectra VL400 PCs contains summary information only. More detailed information on system hardware is available in the *Technical Reference Manual - Vectra Technology*.

---

## VL400 Documentation

The following documentation is available for the HP Vectra VL400.

### Quick User's Guide

This paper manual came with your PC but is also available at [www.hp.com/go/vectrasupport](http://www.hp.com/go/vectrasupport).

### Information CD-ROM

This CD-ROM contains extensive information about your PC. It can be ordered from [www.hp.com/go/vectrasupport](http://www.hp.com/go/vectrasupport).

If you do not want to order this CD-ROM, you can also download individual documents and information modules from

[www.hp.com/go/vectrasupport](http://www.hp.com/go/vectrasupport).

The CD-ROM contains the following information modules:

- Setting up your PC
- Using your PC
- Installing components and accessories in your PC
- Solving problems (troubleshooting)
- Warranty information.

The CD-ROM also contains the following documents:

- Product Datasheet
- Corporate Evaluator's Guide
- Corporate Deployment Guide
- Technical Reference Manual (in 3 parts, the manual you are reading)
- Service Handbook chapters
- e-DiagTools User's Guide.

---

## VL400 Bibliography

- ❑ HP Vectra VL400 user, troubleshooting and upgrading manuals at:  
[www.hp.com/go/vectrasupport](http://www.hp.com/go/vectrasupport)
- ❑ *Technical Reference Manual -Vectra Technology*  
[www.hp.com/go/vectrasupport](http://www.hp.com/go/vectrasupport)
- ❑ HP Vectra PC *Service Handbook* Chapter at:  
[www.hp.com/go/vectrasupport](http://www.hp.com/go/vectrasupport).

Data sheets can be obtained at:

- ❑ *Pentium Processors*  
[www.intel.com/design/pentiumIII/datashts](http://www.intel.com/design/pentiumIII/datashts)
- ❑ *HP Product Data Sheet*  
[www.hp.com/desktops](http://www.hp.com/desktops)

---

# Contents

## 1 System Overview

Package Features . . . . .	8
Rear Connectors . . . . .	8
Desktop . . . . .	9
Minitower . . . . .	10
Small Form Factor . . . . .	12
Specifications . . . . .	14
Physical Characteristics . . . . .	14
Environmental Specifications . . . . .	15

## 2 System Features

VL400 System Board Layout . . . . .	18
System Board . . . . .	18
Architectural View . . . . .	20
Main Memory . . . . .	21
Processors . . . . .	21
Mass Storage Devices . . . . .	22
Hard Disk Drives . . . . .	22
Floppy Disk Drives . . . . .	22
CD-ROM and DVD Drives . . . . .	22
DVD Region Codes . . . . .	25
Integrated Graphics Controller . . . . .	26
Supported Resolutions . . . . .	26
Connectors . . . . .	27
Matrox Millennium G450 AGP 4X or PCI Graphics Card . . . . .	28
Key Features . . . . .	28
Maximum Supported Refresh Rates . . . . .	29
Audio . . . . .	30
Network . . . . .	31
Accessory Boards . . . . .	33

## 3 Serviceability

VL400 Desktop . . . . .	36
-------------------------	----

VL400 Minitower . . . . .	37
VL400 Small Form Factor . . . . .	38

#### 4 BIOS Overview

BIOS Summary . . . . .	40
Using the HP Setup Program . . . . .	40
Help Information . . . . .	40
Main Menu . . . . .	41
Advanced Menu . . . . .	41
Security . . . . .	42
Boot Menu . . . . .	43
Power Menu . . . . .	43
Power Saving and Ergonometry . . . . .	44
Soft Power Down . . . . .	44
Safe Off . . . . .	44
Power Management . . . . .	44
Operating System Power Management . . . . .	44
APM Power Management Modes . . . . .	44
ACPI Power Management Modes (Windows 2000 and Windows98 SE only) . . . . .	45
BIOS Addresses . . . . .	46
System Memory Map . . . . .	46
HP I/O Port Map (I/O Addresses Used by the System) . . . . .	46
DMA Channel Controllers . . . . .	48
Interrupt Controllers . . . . .	49
PCI Interrupt Request Lines . . . . .	49
Order in Which the POST Tests are Performed . . . . .	50
HP e-DiagTools Preboot Diagnostic (Beep Codes) . . . . .	57

#### 5 Drivers and Software

Drivers . . . . .	60
Software . . . . .	60
BIOS Updates . . . . .	61

---

## System Overview

This chapter introduces the internal and external features, and lists the specifications of the HP Vectra VL400 PC models.

---

## Package Features

### Rear Connectors

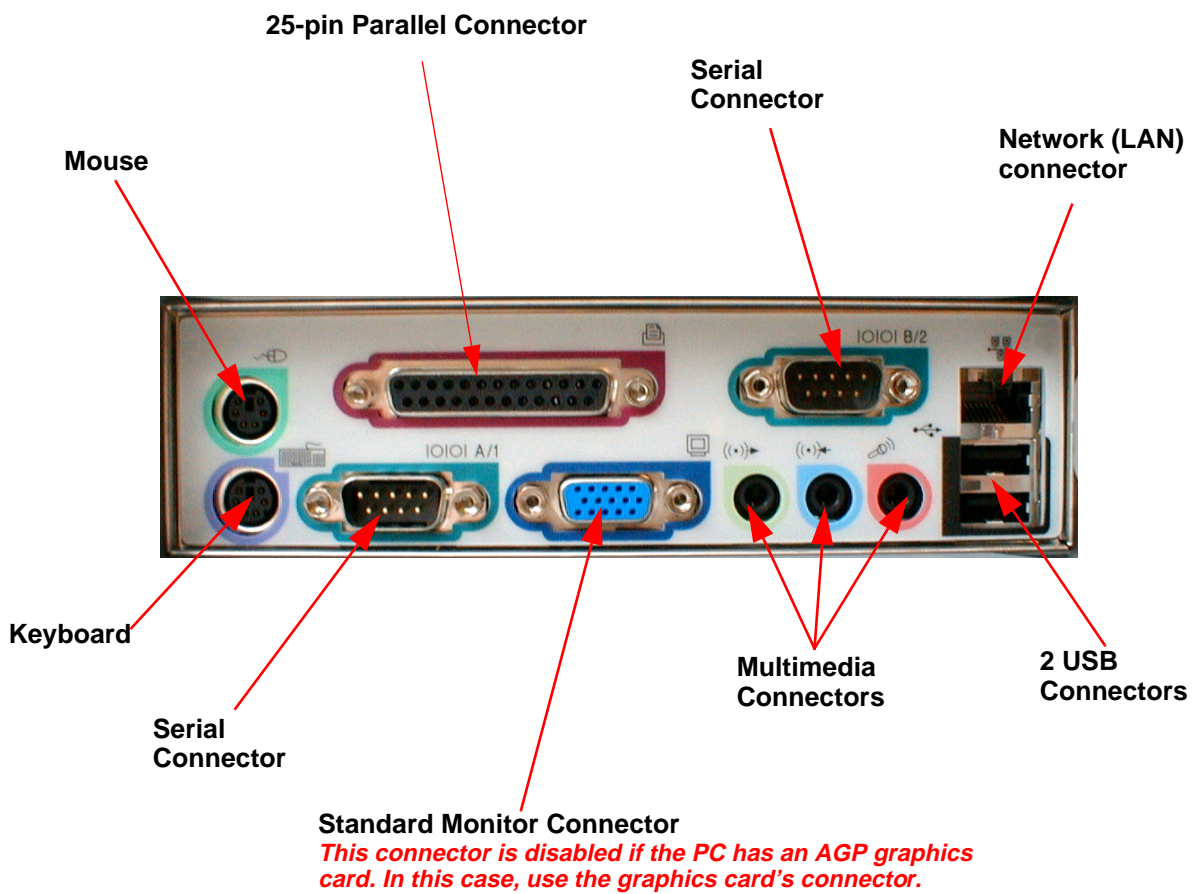



## Desktop

### Front panel

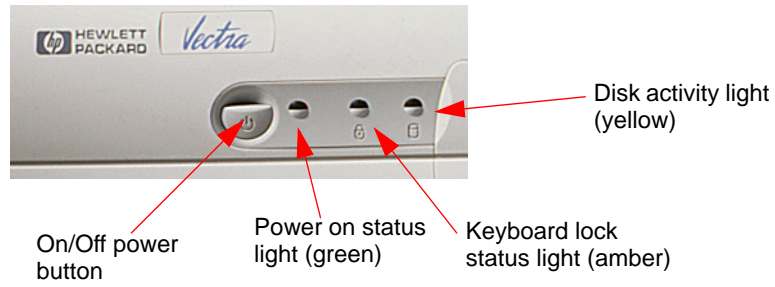

### Inside the Desktop

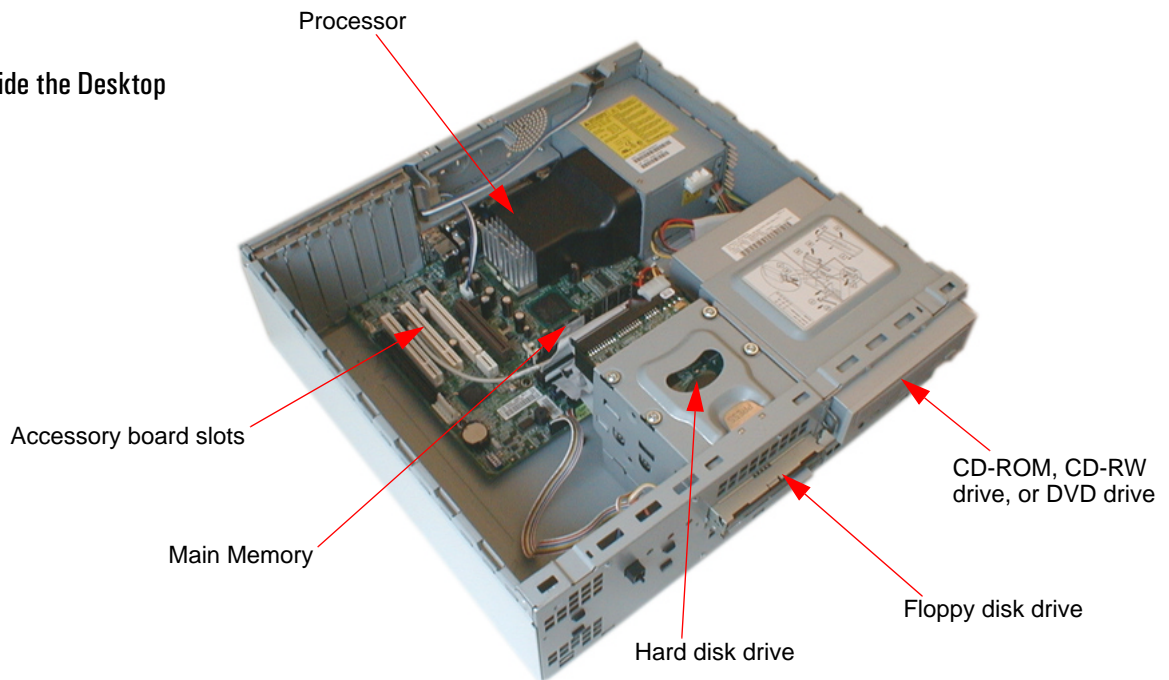

## 1 System Overview

### Package Features

#### Rear view

Location of the voltage switch and power connector on the desktop.



#### Minitower

#### Front view

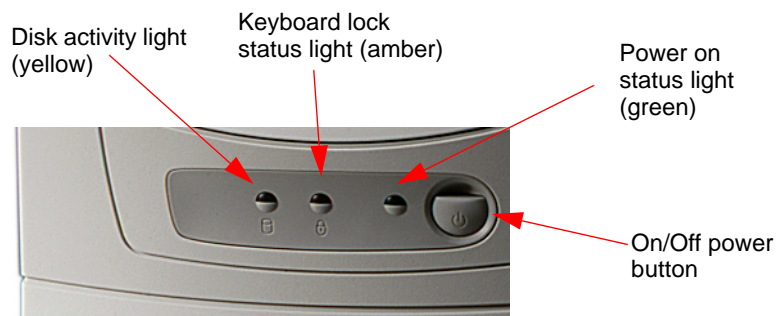

Inside the  
Minitower

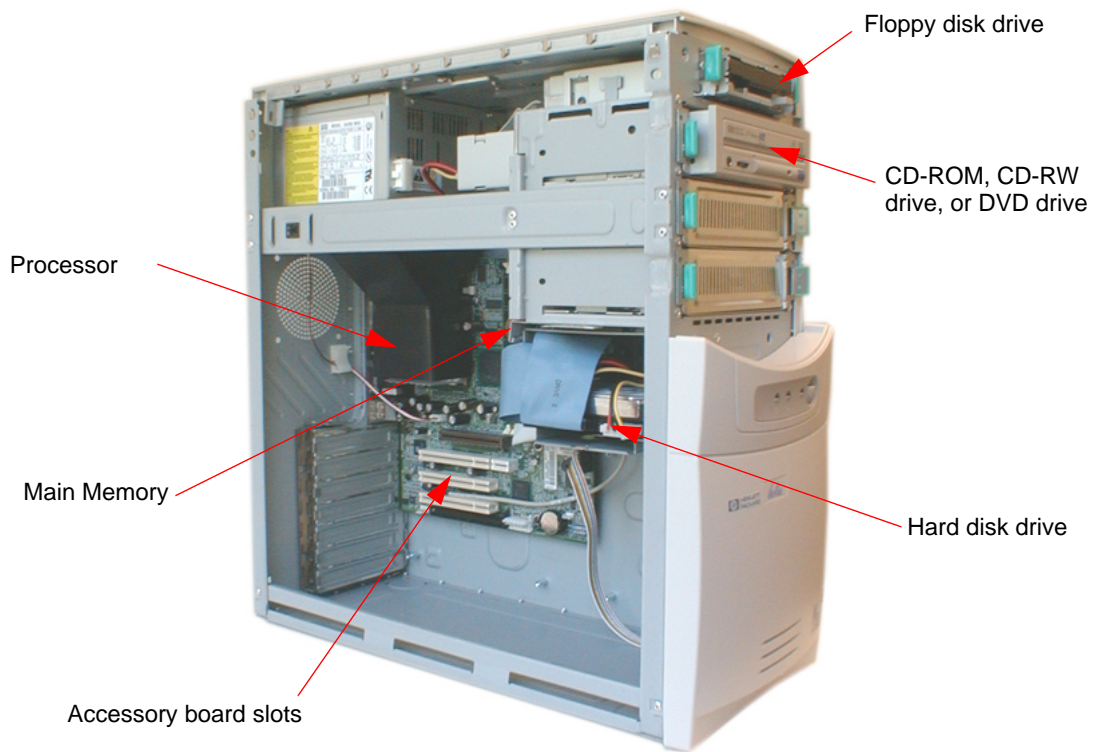

Rear view

Location of the voltage  
switch and power connector  
on the minitower.



1 System Overview  
Package Features

## Small Form Factor

### Front panel

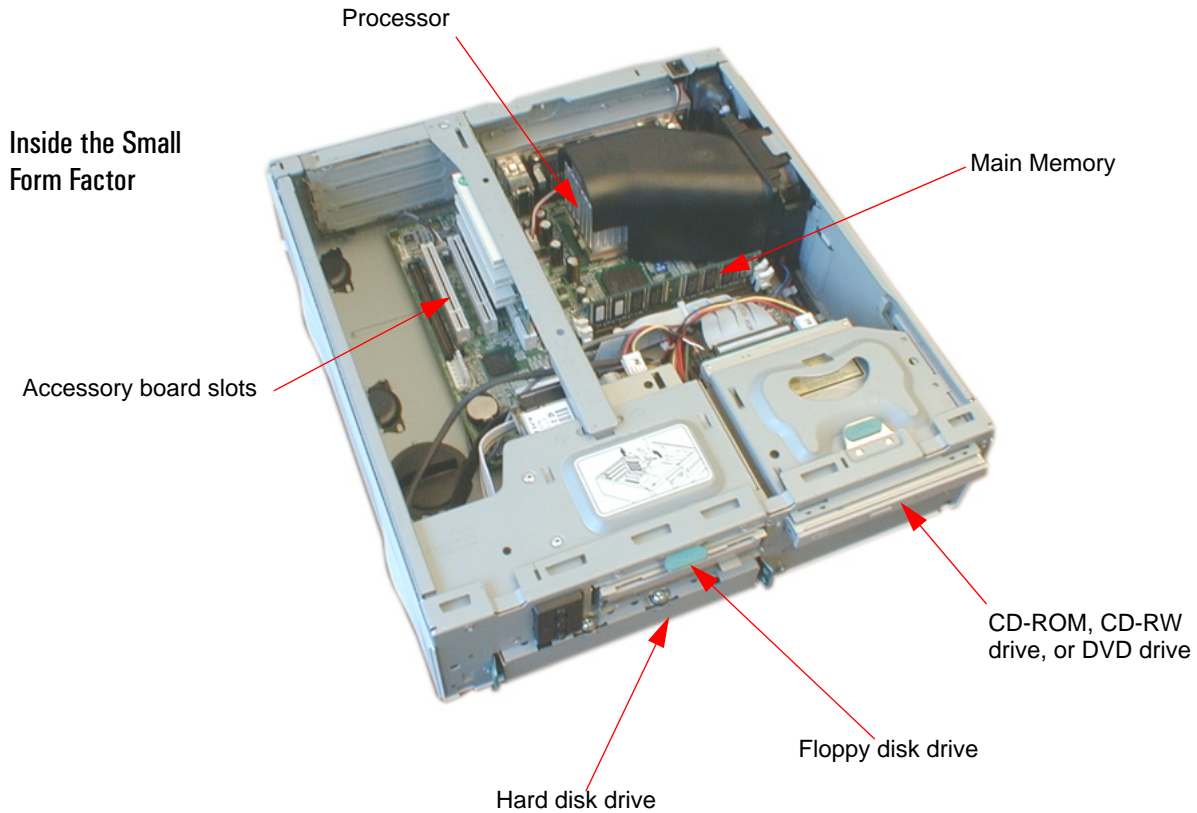
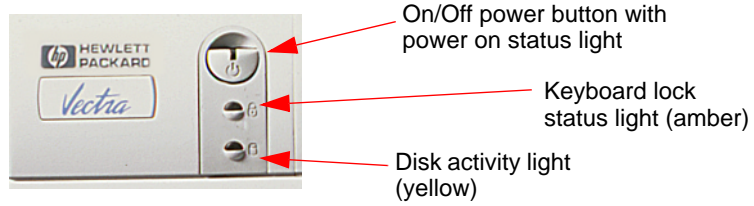

Rear view

Location of the voltage switch  
and power connector on the  
small form factor.



## 1 System Overview

### Specifications

---

## Specifications

### Physical Characteristics

Characteristics	VL400 Desktop PC	VL400 Minitower PC	VL400 SFFactor PC
Weight (configuration with 1 CD-ROM drive, excluding keyboard and display)	10 kg (22 pounds)	13.4 kg (29.5 pounds)	8 kg (17.6 pounds)
Dimensions	Width: 43.5cm (17.13in.) Height: 13.5cm (5.32in.) Depth: 43cm (16.93in.)	Width: 20.6cm (8.15in.) Height: 46.9cm (18.46in.) Depth: 45.5cm (17.9in.)	Width: 36.6cm (14.4in.) Height: 10.1cm (3.98in.) Depth: 40.7cm (16.14in.)
Footprint	0.187 m <sup>2</sup> (2.01 ft <sup>2</sup> )	0.094 m <sup>2</sup> (1.01 ft <sup>2</sup> )	0.15 m <sup>2</sup> (1.61 ft <sup>2</sup> )
Acoustic noise emission (IS 07779)	Sound power level LwA ≤ 3.5 BA (35 dBA)		
Operating (idle):	Sound pressure level at the operator position LpA ≤ 26 dBA		
Power Supply	Input Voltage: 100-127 V 4A, 200-240V 2A ac (voltage selection switch) Input Frequency: 50/60 Hz Maximum output power: 120W continuous	Input Voltage: 100-127 V 6A, 200-240V 3A ac (voltage selection switch) Input Frequency: 50/60 Hz Maximum output power: 200W continuous	Input Voltage: 100-127 V 2500mA, 200-240V 1300mA ac (voltage selection switch) Input Frequency: 50/60 Hz Maximum output power: 100W continuous
Power consumption	115V/60Hz and 230V/50Hz	115V/60Hz and 230V/50Hz	115V/60Hz and 230V/50Hz
Typical:	40 W	40 W	40 W
Suspend to RAM (ACPI s3):	4.8 W	4.8 W	4.8 W
Storage Humidity	8% - 85% (relative), non-condensing at 40°C (104°F)		

As an ENERGY STAR partner, HP has determined that this product meets the ENERGY STAR guidelines for energy efficiency (Windows 2000, Windows 98 and Windows 95 only).

Low power consumption (4.8W in suspend mode) can be achieved when Suspend to RAM is activated. This can be done with ACPI operating systems only (Windows 98 and Windows 2000). To activate Suspend to RAM, enter your BIOS Setup by pressing **F2** during startup, then go to the **Power** menu and make sure that the field **Suspend to RAM** is set to **enabled**.

When Suspend to RAM is not activated, or if it is activated in non-ACPI operating systems, the power consumption in suspend mode will be around 25W.

**Notes**

Operating temperature and humidity ranges may vary depending on the mass storage devices installed. High humidity levels can cause improper operation of disk drives. Low humidity ranges can aggravate static electricity problems and cause excessive wear of the disk surface.

The power consumption and acoustics figures given in the tables above are valid for the standard configuration as shipped. For more information, refer to the product's data sheet at HP's web site: [www.hp.com/desktop](http://www.hp.com/desktop)

When the computer is turned off with the power button on the front panel, the power consumption falls below 3W, but it is not zero. The special on/off method used by these computers considerably extends the lifetime of the power supply. To reach zero power consumption in "off" mode, either unplug the power outlet or use a power block with a switch.

### Environmental Specifications

Environmental Specifications (System Processing Unit, with Hard Disk)	
Operating Temperature	+ 10°C to + 35°C (+ 50°F to 95° F)
Storage Temperature	-40°F to +70°F (-40°C to +158°C)
Operating Humidity	15% to 80% (relative)
Storage Humidity	8% to 85% (relative), non-condensing at 40°C (104°F)
Operating Altitude	10000 ft (3100m) max
Storage Altitude	15000ft (4600m) max

Operating temperature and humidity ranges may vary depending upon the mass storage devices installed. High humidity levels can cause improper operation of disk drives. Low humidity levels can aggravate static electricity problems and cause excessive wear of the disk surface.

**1 System Overview**  
Specifications



---

## System Features

This chapter describes core components of the PC such as processors, chipsets, mass storage devices, graphics controllers, audio controllers, network features and input devices.

## 2 System Features

### VL400 System Board Layout

## VL400 System Board Layout

All HP Vectra VL400 PC system boards have a Socket 370 for a compatible Celeron or Pentium III processor.

### System Board

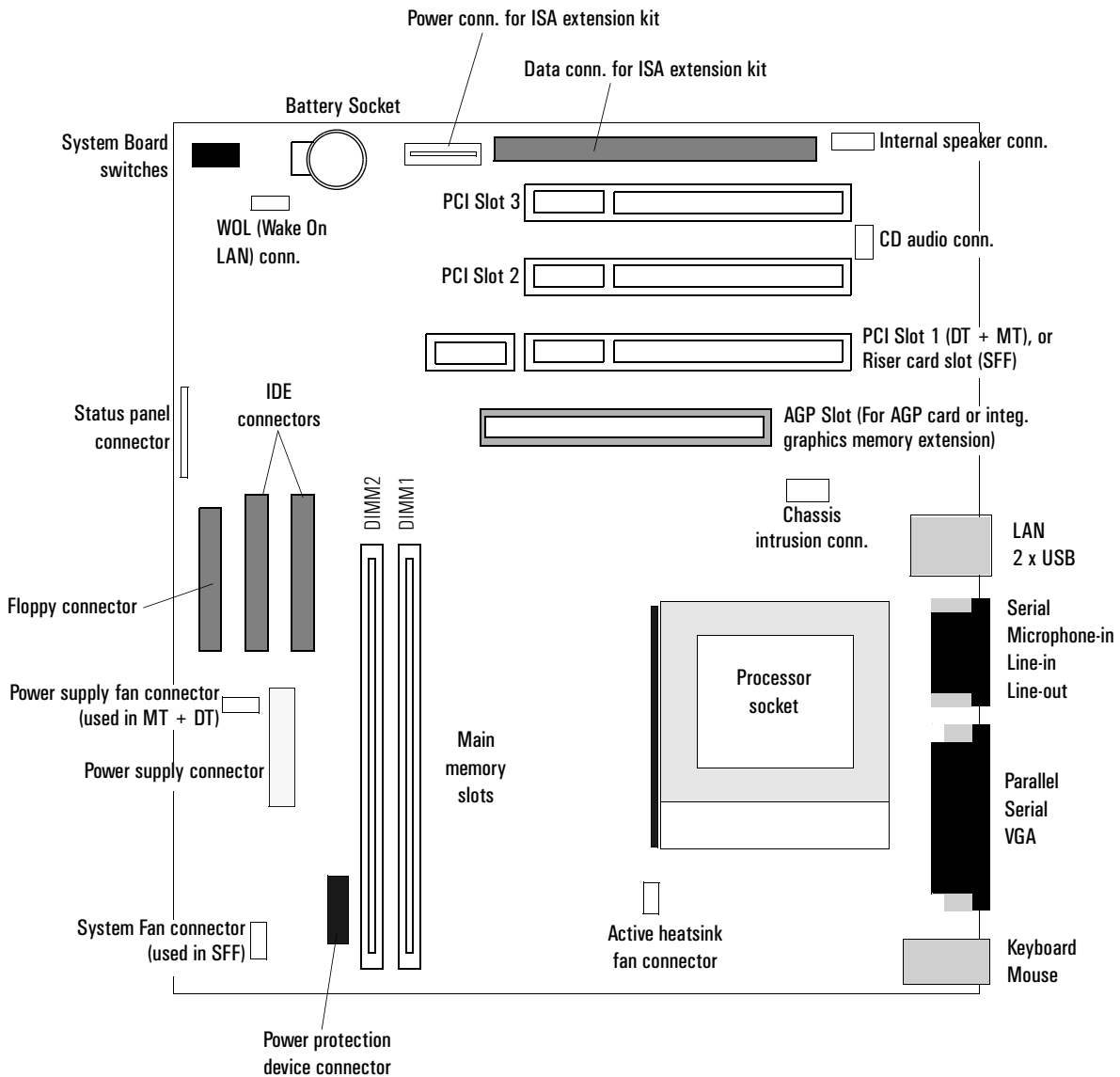

## PCI Mapping

VL400 PCI Mapping Table			
Bus	Device	PCI Device	Slot#
0	0	GMCH: Host bridge	
0	2	GMCH: AGP bridge	
0	30	ICH: Hub interface to PCI bridge	
0	31	ICH: PCI to LPC bridge	
0	31	ICH: IDE controller	
0	31	ICH: USB controller	
0	31	ICH: SMBUS controller	
0	31	ICH: AC97 audio controller	
1	2	PCI slot 1	1
1	1	PCI slot 2	2
1	0	PCI slot 3	3
2	0	AGP device	AGP slot

## 2 System Features

### Architectural View

## Architectural View

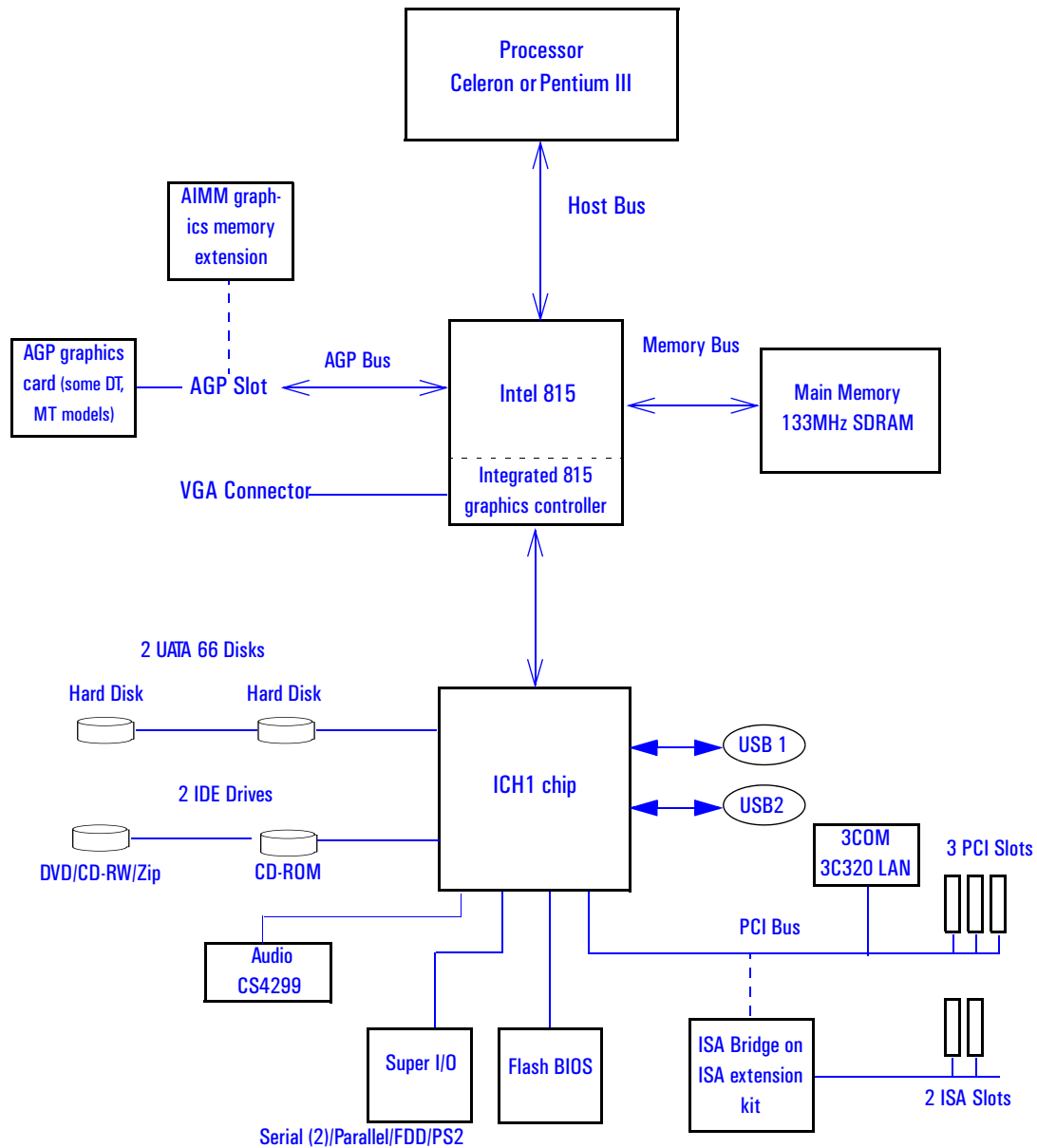

This block diagram applies primarily to Desktop and Minitower configurations.

---

## Main Memory

There are two 168-pin DIMM slots on the system board for installing main memory. You can install 133MHz SDRAM modules. These are available in 64, 128, 256 and 512 MB memory modules. You can install only one 512 MB module. A maximum of 512 MB is supported.

You can use ECC or non-ECC memory modules. However, single/multiple bit-error processing is not done by the 815 chipset.

---

## Processors

The VL400 is equipped with either a single Socket 370 Intel Celeron or socket 370 Intel Pentium III processor. Socket 370 is a conversion of Slot 1 (used previously by Celerons and Pentium IIs) to a socket, running at the same bus protocol as the Pentium II (the GTL+ bus protocol). The processor is connected to the system board through a Plastic Pin Grid Array (PPGA) 370 Socket. The reduction in size achieved by the Socket 370 Celeron is due to the integration of the L2 cache on the processor die. Like the Celeron processor, the Pentium III comes in a 370-pin socket (PGA370) package.

To find out more about Socket 370 Celeron technology, refer to the *Technical Reference Manual - Vectra Technology*.

## 2 System Features

### Mass Storage Devices

---

## Mass Storage Devices

### Hard Disk Drives

A 3.5-inch hard disk drive is supplied on an internal shelf in some models. These hard drives can be provided with the PC. To see which other hard disk drives can be purchased as accessories for the VL400, refer to [www.hp.com/go/pcaccessories](http://www.hp.com/go/pcaccessories).

	<b>10 GB Ultra-ATA 66</b>	<b>15 GB Ultra-ATA 66</b>	<b>30 GB Ultra-ATA 66</b>	<b>9.1 GB Ultra-SCSI</b>
Typical Seek Times (ms)				
Average	9.5	8.5	< 9.0	6.8
Track-to-Track	2.0	0.8	< 1.0	0.9
Full Stroke	18.0	15.0	< 20.0	15.0
Rotational Speed (RPM)	5 400	7 200	7 200	7 200
Internal Data Rate (Mb/s)	Up to 194	235	191 to 298	Up to 257
Buffer Size (KB) Ultra ATA	512	512	2048	2048

To find out about Ultra-ATA DMA/ 66 hard disk drive technology, refer to the *Technical Reference Manual - Vectra Technology*.

### Floppy Disk Drives

All models are supplied with a 3.5-inch floppy disk drive.

### CD-ROM and DVD Drives

Models may be fitted with a 48X Max IDE CD-ROM drive. It can play standard CD-ROM discs, conforming to optical and mechanical standards as specified in the Red and Yellow Book. This drive can also be purchased as an accessory. Refer to [www.hp.com/go/pcaccessories](http://www.hp.com/go/pcaccessories).

To find out about CD-ROM and DVD drive technology, refer to *Technical Reference Manual - Vectra Technology*.

**Features of the  
CD-ROM Drive  
(D9444A)**

- CD-ROM Mode-1 data disc.
- CD-ROM Mode-2 data disc (Mode 1 and Mode 2).
- Photo-CD Multisession.
- CD Audio disc.
- Mixed mode CD-ROM disc (data and audio).
- CD-ROM XA, CD-I, CD-Extra, CD-R, CD-RW.

	Description
HP product number	D9444A
Disc Diameter	120 mm
Data Block Size	2,055 bytes (14X, Mode-1) 4,800 bytes (32X, Mode-2)
Storage Capacity	650 Mbytes (Mode-1) 742 Mbytes (Mode-2)
Sustained Transfer Rate	Outerside: 7,200 KB/s (48X)
Burst Transfer Rate	PIO mode 4 - 16.6 Mbytes/s maximum Single Word DMA Mode 2 - 8.3 Mbytes/s maximum Multi Word DMA Mode 2 - 16.6 Mbytes/s maximum.
Access Time	Average Stroke (1 / 3) 110 ms Full Stroke 180 ms
Buffer Memory Size	128 kbytes
Rotational speed	Approx. 11,100 rpm maximum

## 2 System Features

### Mass Storage Devices

#### Features of the CD-RW Drive (D9524A)

- CD-ROM Mode-1 data disc.
- CD-ROM Mode-2 data disc (Mode 1 and Mode 2).
- Photo-CD Multisession.
- CD Audio disc.
- Mixed mode CD-ROM disc (data and audio).
- CD-ROM XA, CD-I, CD-Extra, CD-R, CD-RW.

	Description
HP product number	D9524A
Disc Diameter	120 mm
Data Block Size	2,055 bytes (14X, Mode-1) 4,800 bytes (32X, Mode-2)
Storage Capacity	650 Mbytes (Mode-1) 742 Mbytes (Mode-2)
Write Mode	4X (CD-R) and 4X (CD-RW)
Read Mode	Full CAV <sup>1</sup> 10.3X to 24X
Burst Transfer Rate	PIO mode 4 - 16.6 Mbytes/s maximum Single Word DMA Mode 2 - 8.3 Mbytes/s maximum Multi Word DMA Mode 2 - 16.6 Mbytes/s maximum.
Access Time	Average Stroke (1 / 3) 110 ms Full Stroke 180 ms
Buffer Memory Size	128 kbytes
Rotational speed	Approx. 7,300 rpm maximum

<sup>1</sup>CAV = Constant Angular Velocity



### Features of the DVD-ROM Drive (D7521A)

- CD-ROM Mode-1 data disc.
- CD-ROM Mode-2 data disc (Mode 1 and Mode 2).
- Photo-CD Multisession.
- CD Audio disc.
- Mixed mode CD-ROM disc (data and audio).
- CD-ROM XA, CD-I, CD-Extra, CD-R, CD-RW.
- DVD-ROM, DVD-Video, DVD Audio, DVD-RAM.

	Description
HP product number	D7521A
Disc Diameter	120 mm
Storage Capacity	650 MB to 17 GB (depending on disk type)
Read Mode	8 X max (DVD), 40X max CD-ROM
Burst Transfer Rate	PIO mode 4 - 16.6 Mbytes/s maximum Single Word DMA Mode 2 - 8.3 Mbytes/s maximum Multi Word DMA Mode 2 - 16.6 Mbytes/s maximum.
Access Time	Average Stroke (1 / 3) 110 ms Full Stroke 180 ms
Buffer Memory Size	128 kbytes
Rotational speed	Approx. 7,300 rpm maximum

---

#### **NOTE**

---

If a disk is still in the drive after power failure or drive failure, the disk can be reclaimed by inserting a straightened paper-clip into the small hole at the bottom of the door.

#### DVD Region Codes

The DVD-ROM drive is only able to play DVD video discs from regions 1 and 2 (see table below). DVD region settings can be changed up to 5 times.

Region Codes	Region	Supported by the D4388A DVD Drive
1	USA & Canada	Yes
2	Europe & Japan	Yes
3	South East Asia	No
4	Latin America & Australia	No
5	Russia, Rest of Asia, Africa	No
6	China	No

---

## 2 System Features

### Integrated Graphics Controller

---

## Integrated Graphics Controller

Some models use the integrated Intel® 815 graphics controller for 2D and 3D graphics. The Intel® 815 graphics controller uses Direct AGP and Dynamic Video Memory technology.

The controller uses 9-10 MB of system memory for graphics purposes. You can also install a 4 MB graphics memory extension (in the AGP slot) for a total of 12 MB memory (8 MB system memory is used in this case). The 4 MB memory extension can improve 2D and 3D graphics performance significantly.

### Supported Resolutions

The following non-interlaced resolutions are supported:

Mode	Colors	Refresh
640 x 480	256	60, 70, 72, 75, 85
640 x 480	65K	60, 70, 72, 75, 85
640 x 480	16.8M	60, 70, 72, 75, 85
800 x 600	256	60, 70, 72, 75, 85
800 x 600	65K	60, 70, 72, 75, 85
800 x 600	16.8M	60, 70, 72, 75, 85
1024 x 768	256	60, 70, 75, 85
1024 x 768	65K	60, 70, 75, 85
1024 x 768	16.8M	60, 70, 75, 85
1152 x 864	256	60, 70, 72, 75, 85
1152 x 864	65K	60, 70, 72, 75, 85
1152 x 864	16.8M	60, 75, 85
1280 x 1024	256	60, 70, 72, 75, 85
1280 x 1024	65K	60, 70, 72, 75, 85
1280 x 1024	16.8M	60, 70, 75, 85
1600 x 1200	256	60, 70, 72, 75

## Connectors

A 15-pin VGA DB connector is located on the rear panel of the PC.

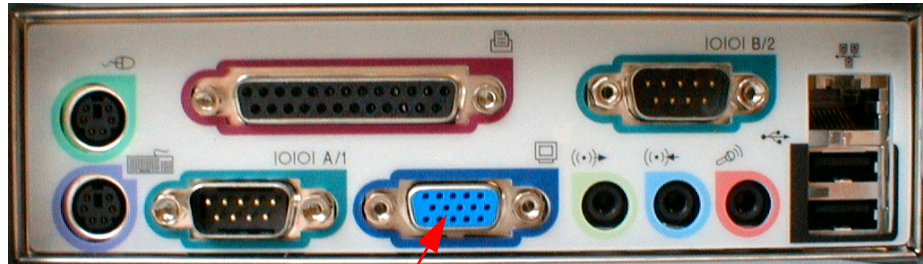

### **15-pin VGA DB Monitor Connector**

*This connector is disabled if the PC has an AGP graphics card. In this case, use the graphics card's connector.*

## 2 System Features

Matrox Millennium G450 AGP 4X or PCI Graphics Card

---

### Matrox Millennium G450 AGP 4X or PCI Graphics Card

Some *Vectra VL400 PC* models are supplied with a Matrox Millennium G450 AGP 4X graphics controller. Also, there is a PCI version of this graphics card available for the VL400 Small Form Factor.

The Matrox Millennium G450 is a very high performance 2D/3D graphics card.

For more information, refer to the *Technical Reference Manual - HP Vectra Technology* available in PDF (Acrobat) format from [www.hp.com/go/vectrasupport](http://www.hp.com/go/vectrasupport).

#### Key Features

- Dual monitor output
- TV-out encoder
- 64-bit Double Data Rate (DDR) memory interface
- Maximum resolution:  
On main display, 2048 × 1536, true color at 85 Hz.  
On second display, 1600 × 1200, true color at 85 Hz.
- Environment-Mapped Bump Mapping for greater 3D realism
- VCQ2 rendering for improved color and text
- 3D Rendering Array Processor for fast, advanced 3D graphics
- 256-bit DualBus graphics chip
- AGP 4X host interface with 1GB/s bandwidth and Symmetrical Rendering Architecture
- High-speed 360 MHz RAMDAC with ultra sharp image quality. Provides fast screen refresh to eliminate screen flicker
- Second RAMDAC at 200MHz
- 16 MB video memory (non-upgradeable).

### Maximum Supported Refresh Rates

Aspect Ratio	Display Resolution	Main Display 360MHz RAMDAC Horizontal / Vertical	Secondary Display 200MHz RAMDAC Horizontal / Vertical
<b>4:3/5:4 Standard</b>	640 x 480	130kHz / 200Hz	130kHz / 200Hz
	800 x 600	130kHz / 200Hz	130kHz / 200Hz
	1024 x 768	130kHz / 160Hz	130kHz / 160Hz
	1152 x 864	130kHz / 140Hz	125kHz / 140Hz
	1280 x 1024	130kHz / 120Hz	110kHz / 100Hz
	1600 x 1200	130kHz / 100Hz	90kHz / 70Hz
	1800 x 1440	130kHz / 85Hz	—
	1920 x 1440	130kHz / 85Hz	—
	2048 x 1536	130kHz / 85Hz	—
<b>16:9/16:10 Wide Screen</b>	856 x 480	130kHz / 200Hz	130kHz / 200Hz
	1280 x 720	130kHz / 160Hz	110kHz / 120Hz
	1600 x 1024	130kHz / 120Hz	90kHz / 85Hz
	1920 x 1090	130kHz / 110Hz	—
	1920 x 1200	130kHz / 100Hz	—

## 2 System Features

### Audio

---

## Audio

The Crystal<sup>®</sup> integrated PCI audio solution (not upgradeable) in your PC is a CrystalClear<sup>™</sup> CS4299 Audio Codec '97 version 2.1. The CS4299 interfaces directly with the South Bridge chip and performs all digital operations, such as sample rate conversions and synthesis, as well as mixing and processing all the analog signals.

All models have a Line In jack, Line Out jack and Mic In jack connector located on the rear panel. These external jacks are standard connectors.

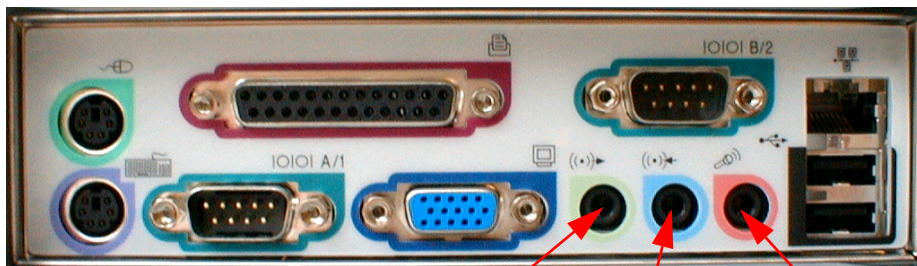

**Line out / speaker  
connector**

**Line in connector**

**Microphone  
connector**

### Adding an Audio Accessory Board

The integrated PCI audio can be disabled in the **Advanced** menu of the *Setup* program, if an audio accessory board is installed.

For more information on audio technology, refer to the *Technical Reference Manual - Vectra Technology*.

---

## Network

All models have an integrated 3COM 3C920 Fast Etherlink 10/100 Base-TX LAN controller.

The integrated 3COM 3C920 is a full duplex LAN controller with automatic 10/100 BT port selection. It supports both AMP and ACPI power management features, such as WOL (Wake On LAN).

If you install a LAN card, you can disable the integrated LAN controller in the PC's *Setup* program.

### Connectors

The 10/100BT connector is located on the rear of the PC.

**10/100BT LAN connector**

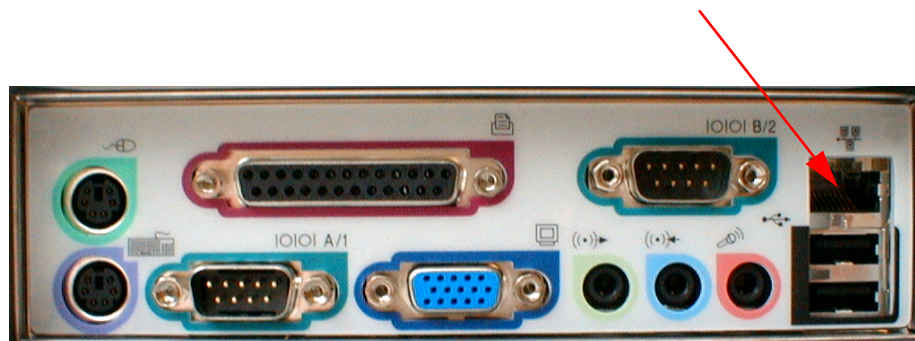

## 2 System Features

### Network

A Wake On LAN (WOL) connector is located on the system board as shown here. It is not required for PCI 2.2-compliant LAN cards such as the 3Com 3C905CTX LAN card but can be useful for other cards for Remote Wake Up (in a token ring environment for example).

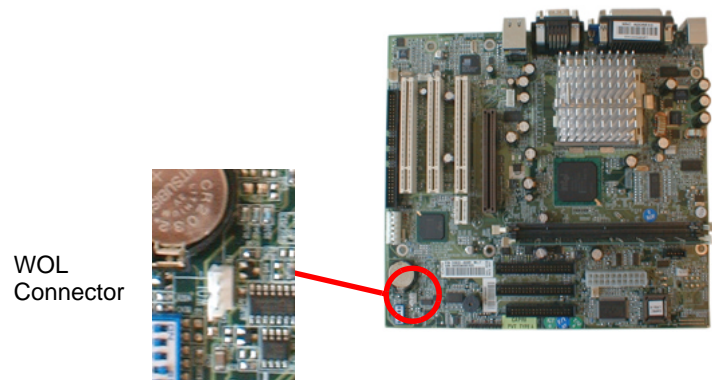

For more information on network technology, refer to the *Technical Reference Manual - Vectra Technology*.



---

## Accessory Boards

The VL400 has four accessory board slots: three PCI slots and one AGP slot (refer to the system board diagram on page 18 for their location). In the minitower and desktop, you can also install the HP Two ISA Slot Extension Kit (available as an accessory) for two ISA slots.

Some models have a high-end graphics card installed in the AGP slot.

**Small Form Factor PCs** In the VL400 SF, the PCI slots on the system board are not used for accessory boards. Instead, there is a riser card installed in the special PCI-riser slot. The standard riser card provides 3 PCI slots. An alternative riser card is also available that provides one PCI slot and one combo PSI-ISA slot.

**PCI Slot Numbers** Your PC uses logical slot numbers in the BIOS *Setup* program. You need to know these logical slot numbers if you want to change the PCI slot configuration in the *Setup* program (refer to the system board diagram on page 18 for their location). PCI slot numbers are also indicated on the system board itself.

## 2 System Features

### Accessory Boards

---

## Serviceability

This chapter introduces the enhanced serviceability features of the *HP Vectra VL400* PC. It shows how easily you can open the PC and remove or add system components using the serviceability features developed for these PC models.

---

## VL400 Desktop

Removing the cover



Shows how to remove the retaining clip

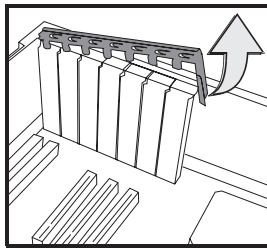

EXPANSION CARDS

Shows how to remove the drive bay

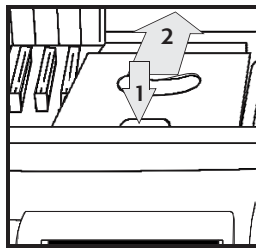

HARD DISK / FLOPPY

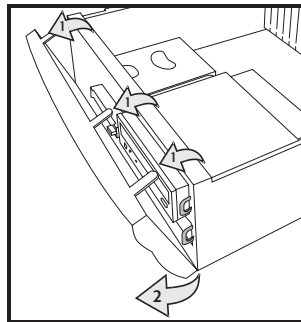

Shows how to remove the front panel

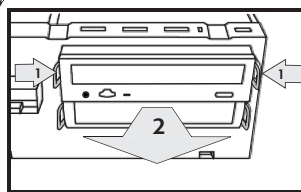
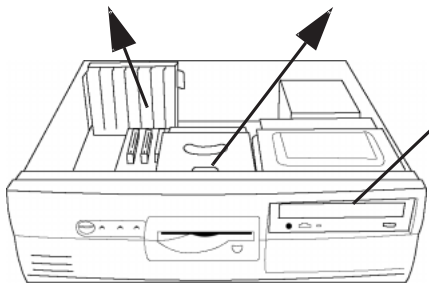

Shows how to remove the DVD, CD-RW, or CD-ROM drive

CD / DVD

## VL400 Minitower

Removing the cover



Shows how to remove the hard disk

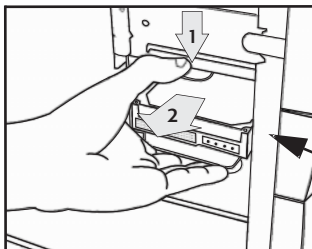

HARD DISK

Shows how to remove the front panel

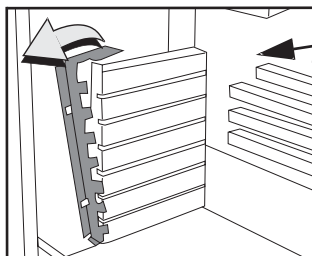
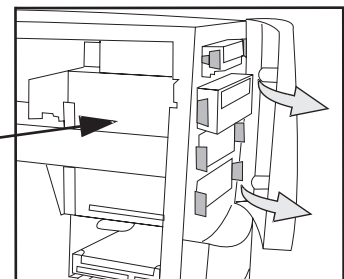

EXPANSION CARDS

Shows how to remove the retaining clip

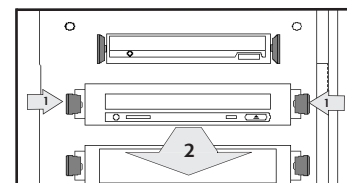

Shows how to remove the DVD, CD-RW, or CD-ROM drive

## VL400 Small Form Factor

Removing the cover

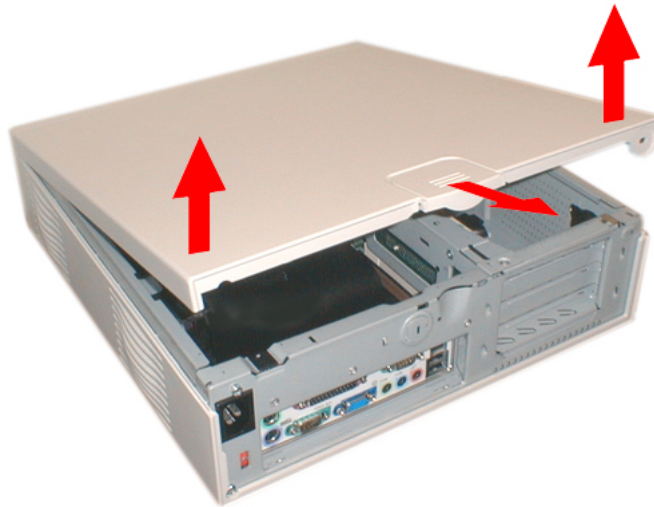

Shows how to remove the front panel

Shows how to remove the DVD, CD-RW, or CD-ROM drive (top) and floppy drive (middle)

Shows how to remove the accessory board bracket

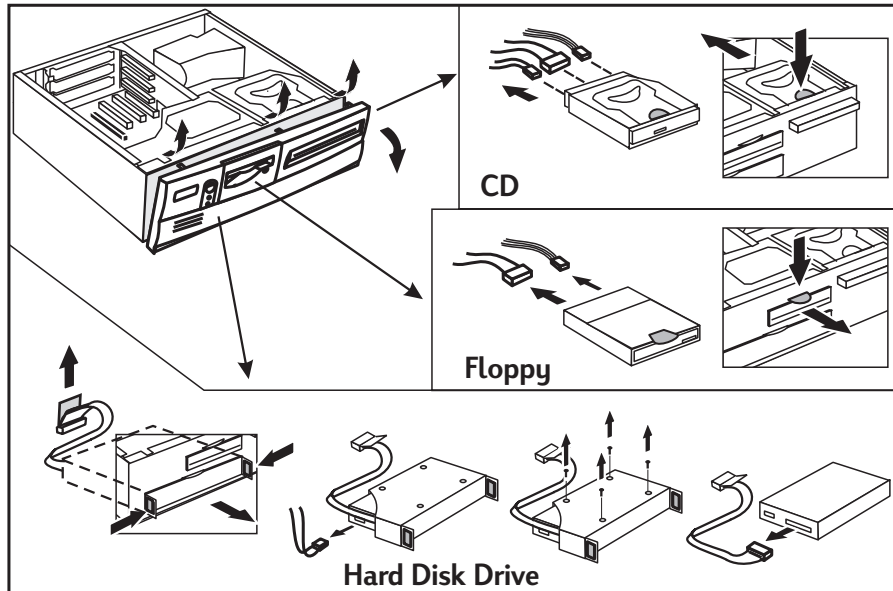
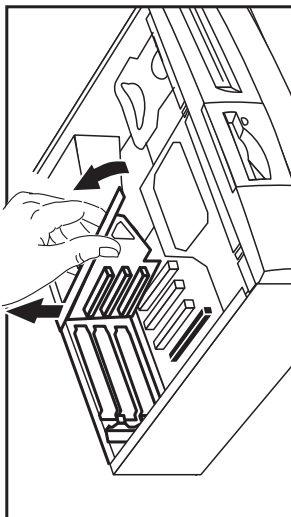

Shows how to remove the hard disk drive

---

## BIOS Overview

This chapter describes the BIOS features for the *HP Vectra VL400 PC* models.

---

## BIOS Summary

HP Vectra VL400 PCs contain a Phoenix BIOS (Basic Input Output System), which was customized by Phoenix for use on the VL400. The system ROM contains the POST (power-on self-test) routines, and the BIOS: the System BIOS, video BIOS, and 3Com LAN boot ROM.

The system BIOS is identified by the version number **IP.xx.xx**. The latest BIOS version for your PC and instructions for updating the BIOS can be downloaded from the HP's Support Web site at:

**[www.hp.com/go/vectrasupport](http://www.hp.com/go/vectrasupport)**.

This section covers:

- The BIOS Setup program
- Power saving
- BIOS addresses
- The order in which POST tests are performed
- Beep codes.

### Using the HP Setup Program

Press **F2** to run the *Setup* program, when the HP logo is displayed immediately after restarting the PC.

Press **F8** to enter the *Boot* menu. Use the boot menu to select the order of the devices the PC will use to start (boot) from.

Press **F12** to boot (start) on the network. This option will only work if your PC and the network is configured correctly.

Alternatively, press **Esc** to view the summary configuration screen. By default, this remains on the screen for 20 seconds, but by pressing the **Pause** key once, it can be held on the screen indefinitely until any key is pressed.

The *Setup* screen offers five menus: Main, Advanced, Security, Boot, Power and Exit. These are selected using the left and right arrow keys.

### Help Information

The HP *Setup* Program provides detailed help information. To get help on any field, simply highlight the chosen field using the keyboard arrow keys. The right hand portion of the *Setup* window will provide help information for that field.



### Main Menu

The Main Menu contains the following fields:

- System date
- System time
- BIOS version
- CPU Type
- CPU Speed
- Cache RAM
- Base Memory
- Extended Memory

The Main Menu also contains the *Keyboard Features* sub-menu, which enables you to set Numlock and auto-repeat features.

### Advanced Menu

The Advanced menu contains the following fields:

- CPU Bus Ratio
- Plug & Play O/S
- Reset Configuration Data
- Memory Hole at 15M-16M
- Processor serial number

These additional fields can be used to disable the integrated facilities (useful when you install an accessory card that performs these functions):

- Integrated USB Interface
- Integrated Network Interface
- Integrated Audio Interface

The Advanced menu also contains the following sub-menus:

- *Cache Options*. To set the state of the processor memory cache.
  - *Flexible Disk Drives*. To set the on-board floppy disk drive configuration.
  - *IDE Devices*. Configure IDE Primary and Secondary devices.
  - *Video Options*. To configure video options, such as which video controller to use.
  - *Integrated I/O Ports*. Configure, enable or disable the on-board parallel and serial ports.
  - *PCI Configuration*. Configure a specific PCI device.
-

## 4 BIOS Overview

### BIOS Summary

- *CPU Microcode Update.* To update the CPU microcode. You must have Administrator rights to use this facility.

### Security

There are sub-menus for changing the characteristics and values of the system administrator password, user password, Hardware Protection and Boot Device Security, the amount of protection against the system's drives and network connections, and the amount of protection for booting from the system's drives and network connections.

The Security Menu contains the following sub-menus:

- *User and Administrator Password.*  
The user password can only be set when an administrator password has been set. The user password prevents unauthorized use of the computer, protects stored data.  
The administrator password prevents unauthorized access to the computer's configuration. It can also be used to start the computer.
- *Hardware protection.* Allows you to enable, disable or write protect the following devices: hard disk, parallel port, serial ports, and boot sector. Write protect helps to prevent users from copying confidential data (to floppy disk for example).
- *Boot Devices Security.* Allows you to prevent or authorize users from booting from devices such as the network, CD-ROM, floppy disk, and hard disk.

### Protection Against Viruses

The VL400 has several features to protect it from viruses:

- **Hard Drive Master Boot Sector Protection:** It is impossible to write on the boot sector or to format the hard disk when this feature is enabled. This protection is enabled in the *Security - Hardware protection* menu of the Setup program.
- **PC Boot Block Protection:** The boot block is protected by a physical switch on the system board (switch 4) and a software switch. When flashing the BIOS, the switch must be closed; HP's BIOS flash program closes the software switch before flashing the BIOS.
- **BIOS Flash Protection:** BIOS flashing is protected by two software switches.

### Boot Menu

The *QuickBoot Mode* option allows the system to skip certain tests while booting. This decreases the time needed to boot the system.

The *Boot-time Diagnostics* screen enables the user to display *either* the HP logo *or* diagnostic's screen during POST.

*Boot Device Priority* allows you to select the order of the devices from which the BIOS attempts to boot the operating system. During POST, if the BIOS is unsuccessful at booting from one device, it will then try the next one on the list until an operating system is found.

*Hard Disk Drives* allows you to choose the hard drive you want to boot from.

*Removable Devices* allows you to choose which drive letters you want to assign to removable devices.

### Power Menu

The Power menu has the following fields:

- *State After Power Failure*. This field allows you to select the state that the PC will place itself into after a power failure. For example, if you set this field to Off, the PC will not start up after a power failure. Setting this value to Auto means that the PC will return to the state it was in before the power failure took place.
- *Advanced Power Management (APM)* fields. These fields allow you to set APM features, such as the timeout before the PC goes into suspend mode, and whether the PC will wake up (or power on) from modem or network card activity.
- *Advanced Configuration and Power Management (ACPI)* field. It allows you to enable or disable the Suspend to RAM feature available with ACPI operating systems (such as Windows 2000).

---

## Power Saving and Ergonometry

### Soft Power Down

*Soft Power Down* is available with the Windows NT operating system. If users want to shut down their PC, they are able to do so directly from the Windows NT interface. There is no longer any need to physically switch off the PC.

The hardware to do this is contained in the ICH chipset. This chipset is described in detail in *Technical Reference Manual - HP Vectra Technology*.

### Safe Off

*Safe Off* is available with the Windows 95 and Windows 98 operating systems. If users attempt to shut down the operating system when an application is open and has not been saved, they are requested to save their work before the computer can be powered off.

In Windows 2000, the equivalent to HP's *Safe Off* is provided by the operating system.

The hardware to do this is contained in the ICH chipset. This chipset is described in detail in *Technical Reference Manual - HP Vectra Technology*.

### Power Management

You can reduce the PC's overall power consumption by using Power Management to slow down the PC's activity when it is idle.

#### Operating System Power Management

Operating systems such as Windows 98 SE, Windows NT 4.0 and Windows 2000 differ in their power management capabilities. Refer to your operating system documentation for more information.

#### APM Power Management Modes

- Suspend  
In Windows 95 for example, you can enter this low power state by clicking **start** ⇒ **suspend**. You can also set the timeout value (time of inactivity before going into Suspend mode) in the PC's *Setup* Program. In this mode, the LED on the PC's front panel blinks green.

#### ACPI Power Management Modes (Windows 2000 and Windows98 SE only)

- Standby  
In Windows 2000 for example, you can enter this low power state by clicking **Start** ⇒ **Shut Down**, then selecting **Stand by** and clicking **OK**. In this mode, the LED on the PC's front panel blinks green.  
There are two forms of Standby: normal (s1) and Suspend to RAM (s3), which is a lower power consumption state than normal Standby. You can use Suspend to RAM by enabling this feature in the PC's *Setup* Program. To do this, press **F2** during startup, then set **Suspend to RAM** in the **Power** menu to **enabled**. If this feature is disabled, the normal (s1) Standby is used.
- Hibernate (s4)  
This is available in Windows 2000 only and is lower power state than Standby. In Windows 2000, you can enter this low power state by clicking **Start** ⇒ **Shut Down**, then selecting **Hibernate** and clicking **OK**. In this mode, the LED on the PC's front panel is off.

## 4 BIOS Overview

### BIOS Addresses

---

## BIOS Addresses

This section provides a summary of the main features of the HP system BIOS. This is software that provides an interface between the computer hardware and the operating system.

### System Memory Map

Reserved memory used by accessory boards must be located in the area from C8000h to EFFFFh.

0000 0000 - 0000 03FF	Real-mode IDT
0000 0400 - 0000 04FF	BIOS Data Area
0000 0500 - 0009 FC00	Used by OS
0009 FC00 - 0009 FFFF	Extended BIOS Data Area
000A_0000 - 000B_FFFF	Video RAM or SMRAM (not visible unless in SMM)
000C 0000 - 000C 7FFF	Video ROM
000C 8000 - 000F FFFF	Adapter ROM, RAM, memory-mapped registers
000E 0000 - 000F FFFF	System BIOS (Flash/Shadow)
10 0000 - FF FFFF	Memory (1 MB to 16 MB)
100 0000 - 1FF FFFF	Memory (16 MB to 32 MB)
200 0000 -3FF FFFF	Memory (32 MB to 64 MB)
400 0000 -1FFF FFFF	Memory (64 MB to 512 MB)
FFF80000 - FFFF FFFF	512 KB BIOS (Flash)

### HP I/O Port Map (I/O Addresses Used by the System)

Peripheral devices, accessory devices and system controllers are accessed via the system I/O space, which is not located in system memory space. The 64 KB of addressable I/O space comprises 8-bit and 16-bit registers (called I/O ports) located in the various system components. When installing an accessory board, ensure that the I/O address space selected is in the free area of the space reserved for accessory boards (100h to 3FFh).

Although the *Setup* program can be used to change some of the settings, the following address map is not completely BIOS dependent, but is determined partly by the operating system. Note that some of the I/O addresses are allocated dynamically.

I/O Address Ports	Function
0000 - 000F	DMA controller 1
0020 - 0021	Master interrupt controller (8259)
002E - 002F	NS364 Configuration registers
0040 - 0043	Timer 1
0060, 0064	Keyboard controller (reset, slow A20)
0061	Port B (speaker, NMI status and control)
0070	Bit 7: NMI mask register
0070 - 0071	RTC and CMOS data
0080	Manufacturing port (POST card)
0081 - 0083, 008F	DMA low page register
0092	PS/2 reset and Fast A20
00A0 - 00A1	Slave interrupt controller
00C0 - 00DF	DMA controller 2
00F0 - 00FF	Co-processor error
0170 - 0177	IDE secondary channel
01F0 - 01F7	IDE primary channel
0278 - 027F	LPT 2
02E8 - 02EF	Serial port 4 (COM4)
02F8 - 02FF	Serial port 2 (COM2)
0372 - 0377	IDE secondary channel, secondary floppy disk drive
0378 - 037A	LPT1
03B0 - 03DF	VGA
03E8 - 03EF	COM3
03F0h- 03F5	Floppy disk drive controller
03F6	IDE primary channel
03F7	Floppy disk drive controller
03F8 - 03FF	COM1
04D0 - 04D1	Interrupt edge/level control
0678 - 067B	LPT2 ECP
0778 - 077B	LPT1 ECP
0CF8 - 0CFF	PCI configuration space

## 4 BIOS Overview

### BIOS Addresses

#### DMA Channel Controllers

Only "I/O-to-memory" and "memory-to-I/O" transfers are allowed. "I/O-to-I/O" and "memory-to-memory" transfers are disallowed by the hardware configuration.

The system controller supports seven DMA channels, each with a page register used to extend the addressing range of the channel to 16 MB. The following table summarizes how the DMA channels are allocated.

DMA controller	
Channel	Function
0	Free
1	Free if not used for parallel port in <i>Setup</i>
2	Floppy disk controller
3	Free if not used for parallel port in <i>Setup</i>
4	Used to cascade DMA channels 0-3
5	Free
6	Free
7	Free



## Interrupt Controllers

The Interrupt Requests (IRQ) are numbered sequentially, starting with the master controller, and followed by the slave.

IRQ (Interrupt Vector)	Interrupt Request Description
INTR	
IRQ0	System Timer
IRQ1	Keyboard Controller
IRQ3	Used by serial port if enabled
IRQ4	Used by serial port if enabled
IRQ5	Free if not used for parallel port or audio
IRQ6	Floppy Disk Controller
IRQ7	LPT1
IRQ8	RTC
IRQ9	Available for PCI devices, if not used by ISA board or USB port
IRQ10	Available for PCI devices, if not used by ISA board or USB port
IRQ11	Available for PCI devices, if not used by ISA board or USB port
IRQ12	Mouse
IRQ13	Co-processor
IRQ14	IDE Primary channel
IRQ15	IDE Secondary channel. Free unless disabled

## PCI Interrupt Request Lines

PCI devices generate interrupt requests using up to four PCI interrupt request lines (INTA#, INTB#, INTC#, and INTD#). PCI interrupts can be shared; several devices can use the same interrupt. However, optimal system performance is reached when minimizing the sharing of interrupts.

## 4 BIOS Overview

### Order in Which the POST Tests are Performed

---

## Order in Which the POST Tests are Performed

Each time the system is powered on, or a reset is performed, the POST is executed. The POST process verifies the basic functionality of the system components and initializes certain system parameters.

The POST starts by displaying a graphic screen of the Hewlett-Packard logo when the PC is started.

Devices, such as memory and newly installed hard disks, are configured automatically. The user is not requested to confirm the change. Newly removed hard disks are detected, and the user is prompted to confirm the new configuration by pressing (F4). Note, though, that the POST does not detect when a hard disk drive has been otherwise changed.

During the POST, the BIOS and other ROM data is copied into high-speed shadow RAM. The shadow RAM is addressed at the same physical location as the original ROM in a manner which is completely transparent to applications. It therefore appears to behave as very fast ROM. This technique provides faster access to the system BIOS firmware.

The following table lists the POST checkpoint codes written at the start of each test.

Checkpoint Code	POST Routine Description
02h	Verify Real Mode
03h	Disable Non-Maskable Interrupt (NMI)
04h	Get CPU type
06h	Initialize system hardware
08h	Initialize chipset with initial POST values
09h	Set IN POST flag
0Ah	Initialize CPU registers
0Bh	Enable CPU cache
0Ch	Initialize caches to initial POST values
0Eh	Initialize I/O component

#### 4 BIOS Overview

##### Order in Which the POST Tests are Performed

<b>Checkpoint Code</b>	<b>POST Routine Description</b>
0Fh	Initialize the local bus IDE
10h	Initialize Power Management
11h	Load alternate registers with initial POST values
12h	Restore CPU control word during warm boot
13h	Initialize PCI Bus Mastering devices
14h	Initialize keyboard controller
17h	Initialize cache before memory autosize
18h	8254 timer initialization
1Ah	8237 DMA controller initialization
1Ch	Reset Programmable Interrupt Controller
24h	Set ES segment register to 4 GB
26h	Enable A20 line
28h	Autosize DRAM
29h	Initialize POST Memory Manager
2Ah	Clear 512 KB base RAM
32h	Test CPU bus-clock frequency
33h	Initialize POST Dispatch Manager
34h	Test CMOS RAM
35h	Initialize alternate chipset registers
36h	Warm start shutdown
37h	Reinitialize the chipset (MB only)
38h	Shadow system BIOS ROM
39h	Reinitialize the cache (MB only)
3Ah	Autosize cache
3Ch	Configure advanced chipset registers

#### 4 BIOS Overview

Order in Which the POST Tests are Performed

<b>Checkpoint Code</b>	<b>POST Routine Description</b>
3Dh	Load alternate registers with CMOS values
40h	Set initial CPU speed
42h	Initialize interrupt vectors
44h	Initialize BIOS interrupts
45h	POST device initialization
47h	Initialize manager for PCI Option ROMs (Rel. 5.1 and earlier)
48h	Check video configuration against CMOS
49h	Initialize PCI bus and devices
4Ah	Initialize all video adapters in system
4Bh	Display QuietBoot screen
4Ch	Shadow video BIOS ROM
4Eh	Display BIOS copyright notice
50h	Display CPU type
51h	Initialize EISA board
52h	Test keyboard
54h	Set key click if enabled
56h	Enable keyboard
59h	Initialize POST display service
5Ah	Display prompt "Press F2 to enter SETUP"
5Bh	Disable CPU cache
5Ch	Test RAM between 512 and 640 KB
60h	Test extended memory
62h	Test extended memory address lines
64h	Jump to UserPatch1
66h	Configure advanced cache registers

#### 4 BIOS Overview

##### Order in Which the POST Tests are Performed

<b>Checkpoint Code</b>	<b>POST Routine Description</b>
67h	Initialize Multi Processor APIC
68h	Enable external and CPU caches
69h	Setup System Management Mode (SMM) area
6Ah	Display external L2 cache size
6Ch	Display shadow-area message
6Eh	Display possible high address for UMB recovery
70h	Display error messages
72h	Check for configuration errors
74h	Test real-time clock
76h	Check for keyboard errors
7Ah	Test for key lock on
7Ch	Set up hardware interrupt vectors
7Eh	Initialize coprocessor if present
80h	Disable onboard Super I/O ports and IRQs
81h	Late POST device initialization
82h	Detect and install external RS 232 ports
83h	Configure non-MCD IDE controllers
84h	Detect and install external parallel ports
85h	Initialize PC-compatible PnP ISA devices
86h	Re-initialize onboard I/O ports
87h	Configure Motherboard Configurable Devices
88h	Initialize BIOS Data Area
89h	Enable Non-Maskable Interrupts (NMIs)
8Ah	Initialize Extended BIOS Data Area
8Bh	Test and initialize PS/2

#### 4 BIOS Overview

Order in Which the POST Tests are Performed

<b>Checkpoint Code</b>	<b>POST Routine Description</b>
8Ch	Initialize floppy controller
8Fh	Determine number of ATA drives
90h	Initialize hard disk controllers
91h	Initialize local-bus hard disk controllers
92h	Jump to UsersPatch2
93h	Build MPTABLE for multi-processor boards
94h	Disable A20 address line (Rel. 5.1 and earlier)
95h	Install CD ROM for boot
96h	Clear huge ES segment register
97h	Fixup Multi Processor table
99h	Check for SMART drive
9Ah	Shadow option ROMs
9Ch	Set up Power Management
9Eh	Enable hardware interrupts
9Fh	Determine number of ATA drives
A0h	Set time of day
A2h	Check key lock
A4h	Initialize typematic rate
A8h	Erase F2 prompt
AAh	Scan for F2 key stroke
ACh	Enter SETUP
A Eh	Clear IN POST flag
B0h	Check for errors
B2h	POST done - prepare to boot operating system
B5H	Terminate QuietBoot

<b>Checkpoint Code</b>	<b>POST Routine Description</b>
B6h	Check password (optional)
B8h	Clear global descriptor table
B9h	Clean up all graphics
BAh	Initialize DMI parameters
BBh	Initialize PnP Option ROMs
BCh	Clear parity checkers
BDh	Display MultiBoot menu
BEh	Clear screen optional
BFh	Check virus and backup reminders
C0h	Try to boot with INT 19
C1h	Initialize POST Error Manager (PEM)
C2h	Initialize error logging
C3h	Initialize error display function
C4h	Initialize system error handling
<b>The following are for boot block in Flash ROM</b>	
E0h	Initialize the chipset
E1h	Initialize the bridge
E2h	Initialize the CPU
E3h	Initialize system timer
E4h	Initialize system I/O
E5h	Check force recovery boot
E6h	Checksum BIOS ROM
E7h	Go to BIOS
E8h	Set Huge Segment
E9h	Initialize Multi Processor

#### 4 BIOS Overview

Order in Which the POST Tests are Performed

<b>Checkpoint Code</b>	<b>POST Routine Description</b>
EAh	Initialize OEM special code
EBh	Initialize PIC and DMA
ECh	Initialize Memory type
EDh	Initialize Memory size
EEh	Shadow Boot Block
EFh	System memory test
F0h	Initialize interrupt vectors
F1h	Initialize Run Time Clock
F2h	Initialize video
F3h	Initialize beeper
F4h	Initialize boot
F5h	Clear Huge segment
F6h	Boot to Mini DOS
F7h	Boot to Full DOS



---

## HP e-DiagTools Preboot Diagnostic (Beep Codes)

When your PC starts up, its BIOS performs a Power-on Self Test (POST) to test your hardware configuration for any problems. If a problem is detected during the POST, an error is displayed on your PC's monitor.

If, however, your PC is unable to display an error message (for example, when you graphics controller has failed), it will emit a buzzing sound. This is the e-DiagTools preboot diagnostic. Immediately after the buzzing sound, a series of beeps is emitted.

If you hear a series of beeps, you should count them as this will help you detect the cause of the problem.

Number of Beeps	Meaning
0	System OK
1	Processor absent, not correctly connected or ZIP socket not closed
2	Power supply is in protected mode
3	No memory, bad memory modules, incompatible memory module
4	Graphics card problem
5	PnP/PCI initialization problem
6	Corrupted BIOS. You need to activate crisis recovery procedure.
7	Defective system board

Note that for Memory (code 3), Video Card (code 4), and PnP/PCI (code 5) errors, e-DiagTools preboot diagnostic will only detect them after a 15-second timeout.

If you miss the beep code, turn off the PC. Then press the on/off power button for five seconds or more, then listen for the signal again.

The e-DiagTools preboot diagnostic, as well as emitting a beep sequence, also encodes troubleshooting information (such as the PC models, serial number, and failing component) into a coded audio signal. During a support call, this coded signal can then be decoded by the HP Service Provider to provide immediate and effective assistance.

---

## 4 BIOS Overview

HP e-DiagTools Preboot Diagnostic (Beep Codes)

---

## Drivers and Software

This chapter describes the drivers and software preloaded with *HP Vectra VL400* PCs.

## 5 Drivers and Software

### Drivers

---

## Drivers

You can download up-to-date versions of drivers required for VL400 PCs from the “Software and Drivers” section of HP’s Support web site at [www.hp.com/go/vectrasupport](http://www.hp.com/go/vectrasupport).

---

## Software

VL400 models come preloaded with the following software. You can download the most up-to-date versions from the “Software and Drivers” section of HP’s Support web site at [www.hp.com/go/vectrasupport](http://www.hp.com/go/vectrasupport).

### Operating Systems

Either Windows 2000 (with Windows NT4 SP6 as alternative on CD-ROM), or Windows 95 (with Windows 98 SE as alternative on CD-ROM).

### Software

- e-DiagTools 3.0
- NT Lock
- CD-R/W or DVD software
- Soft Power Down (Windows NT4)
- TopTools
- Safe Off
- Anti-Virus software (on CD-ROM).

### e-DiagTools

HP e-DiagTools, the hardware diagnostics utility can help you diagnose hardware-related problems on your HP PC. For more information about this utility, refer to the *e-Diagtools User's Guide*. The *e-Diagtools User's Guide* is available on the *HP Information CD-ROM* for the VL400, or on HP’s support web site ([www.hp.com/go/vectrasupport](http://www.hp.com/go/vectrasupport)).

e-DiagTools is installed on the Utility Partition on the PC’s hard disk drive, is provided on one of the CD-ROMS that came with the PC (*HP Image Library and Diagnostics System CD-ROM*), and is available on the *HP e-DiagTools CD* (you can order this CD-ROM from HP’s Support web site).

---

## BIOS Updates

The system BIOS is identified by the version number **IP.xx.xx**. The latest BIOS version for your PC and instructions for updating the BIOS can be downloaded from the HP support Web site at:

**[www.hp.com/go/vectrasupport](http://www.hp.com/go/vectrasupport)**.

## 5 Drivers and Software

BIOS Updates



The Technical Reference Manual contains the following documents available on the *HP Information CD-ROM* or downloadable from the Web in PDF format:

- **Introduction & HP Vectra Product Line Overview**  
Describes how to use the Technical Reference Manual and provides a brief overview of the Vectra product line.
- **Product Description**  
The document you are reading. A separate document exists for VEi7, VEi8, VL400, VL600, VLi8, VLi8SF, and e-Vectra PCs, providing detailed BIOS information and summary information on the hardware components in the PC.
- **HP Vectra Technology**  
A detailed look at the hardware components in all the PCs in the product line. Includes information on processors, chipsets, graphics controllers, network cards, connectors and sockets.



## Free Manuals Download Website

<http://myh66.com>

<http://usermanuals.us>

<http://www.somanuals.com>

<http://www.4manuals.cc>

<http://www.manual-lib.com>

<http://www.404manual.com>

<http://www.luxmanual.com>

<http://aubethermostatmanual.com>

Golf course search by state

<http://golfingnear.com>

Email search by domain

<http://emailbydomain.com>

Auto manuals search

<http://auto.somanuals.com>

TV manuals search

<http://tv.somanuals.com>