

**hp** photosmart  
7550

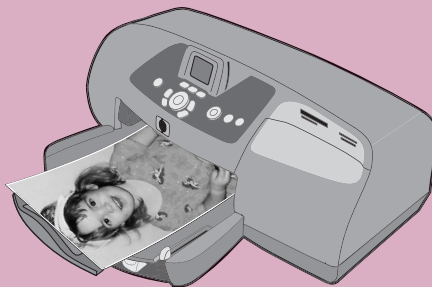

# basics guide



© Copyright 2002 Hewlett-Packard Company

All rights are reserved. No part of this document may be photocopied, reproduced, or translated to another language without the prior written consent of Hewlett-Packard Company.

The information contained in this document is subject to change without notice. Hewlett-Packard shall not be liable for errors contained herein or for consequential damages in connection with the furnishing, performance, or use of this material.

HP, the HP logo, and Photosmart are property of Hewlett-Packard Company.

The Secure Digital logo is a trademark of the SD Association.

Microsoft and Windows are registered trademarks of Microsoft Corporation.

CompactFlash, CF, and the CF logo are trademarks of the CompactFlash Association (CFA).

Mac, the Mac logo, and Macintosh are registered trademarks of Apple Computer, Inc.

IBM is a registered trademark of International Business Machines Corporation.

Other brands and their products are trademarks or registered trademarks of their respective holders.

The copyrights to certain photos within this document are retained by the original owners.

# contents

<b>1</b>	<b>get started</b>	<b>1</b>
	welcome	1
	printer parts	2
	back	2
	front	3
	control panel	4
	card slots	5
	indicator lights	5
	paper information	6
	load paper in the IN tray	6
	load photo paper in the photo tray	7
	print cartridge information	8
	use reserve mode	9
	install or replace the print cartridges	9
	use the control panel	11
	use the buttons	11
	use the indicator lights	12
	menu map	13
<b>2</b>	<b>use your printer with a camera</b>	<b>15</b>
	print camera-selected photos	15
	select and print photos	15
	print from a memory card	16
	supported memory cards	16
	insert a memory card	17
	decide which photos to print	19
	print photos from the control panel	20

<b>3</b>	<b>use your printer with a computer</b>	<b>21</b>
	print from a Windows PC	21
	print from a software application	21
	use the Windows PC taskbar icons	22
	print from a Macintosh	25
	print from a software application (OS X or OS 9.x)	25
<b>4</b>	<b>troubleshooting</b>	<b>27</b>
	Windows PC connection problems	27
	Macintosh connection problems	28
	print a diagnostic page	29
	USB connection problems	30
	printer problems	35
	printing problems	39
<b>5</b>	<b>specifications</b>	<b>53</b>
	system requirements	53
	specifications	54
	<b>index</b>	<b>55</b>

# get started

# 1

## welcome

Thank you for purchasing an HP Photosmart printer! Your new printer comes with the following documentation to help you get started and get the most out of your printer:

- **Setup Guide** — The *HP Photosmart Setup Guide* is the poster that comes with your printer. It contains quick and easy instructions to help you set up your printer and install the printer software.
- **Basics Guide** — The *HP Photosmart 7550 Basics Guide* is the booklet you are reading. It includes a quick reference guide to help you get acquainted with your new printer. It describes how to use the basic features of your printer, and it contains hardware troubleshooting information.
- **Software Setup & Product Support** — The *HP Photosmart Software Setup & Product Support* booklet explains how to install and set up the software that comes with your printer. It contains software troubleshooting information, and it also describes how to get support from [www.hp.com](http://www.hp.com) and how to contact HP Support and Services.
- **HP Photosmart Printer Help** — The HP Photosmart Printer Help is an online guide that describes how to use the more advanced features of your new printer. It also includes information on printer care and maintenance as well as a section on advanced troubleshooting and error messages.

After you have installed the HP Photosmart software on your computer, you can view and print the HP Photosmart Printer Help.

### view the hp photosmart printer help

- **Windows PC:** From the **Start** menu, choose **Programs, Hewlett-Packard, Photosmart 130, 230, 7150, 7345, 7350, 7550,** and **HP Photo & Imaging Director.** From the **HP Photo & Imaging Director,** click **Help.**
- **Macintosh:** Insert the HP Photosmart CD. In the **User Docs** folder, select your **language,** then click the **photosmart 7550.html** file.

### print the hp photosmart printer help

- **Windows PC:** Click **Print** in the top navigation bar of the HP Photosmart Printer Help window.
- **Macintosh:** Click in the frame you want to print. From the **File** menu, select **Print,** or click **Print** in the top navigation bar of the browser.

## printer parts

### back

#### USB port

Use this port to connect the printer to your computer

#### Power cord connection

Use this to connect the power cord included with the printer

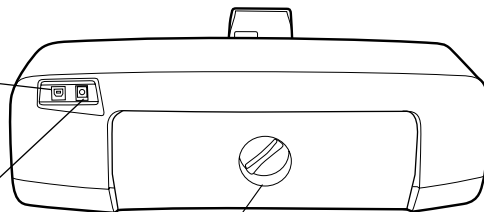

#### Rear access door

Remove this door to clear a paper jam

## front

### OUT tray

This removable tray catches your printed photos or documents

### Control panel

For more information, see **control panel** on page 4

### LCD

This display screen shows photos and menu options

### Memory card slots

For more information, see **card slots** on page 5

### Camera port

Use this port to connect an HP direct-printing digital camera to the printer

### Side door

Open this cover to change the print cartridges

### Paper width guide

Adjust this guide to fit close to the edge of the paper in the IN tray

### Photo tray

Open the cover to load 4 x 6 inch (10 x 15 cm) photo paper in the photo tray

### IN tray

Place paper or envelopes in this tray for printing

### OUT tray extension

Adjust this guide for different paper lengths

### Paper length guide

Adjust this guide to fit close to the end of the paper in the IN tray

### Photo tray slider

Use this slider to engage or disengage the photo tray

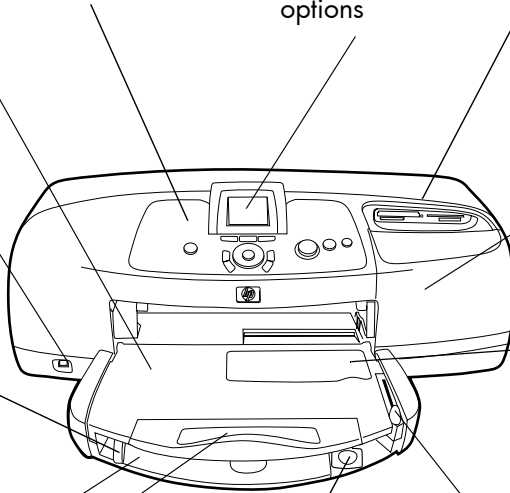

## control panel

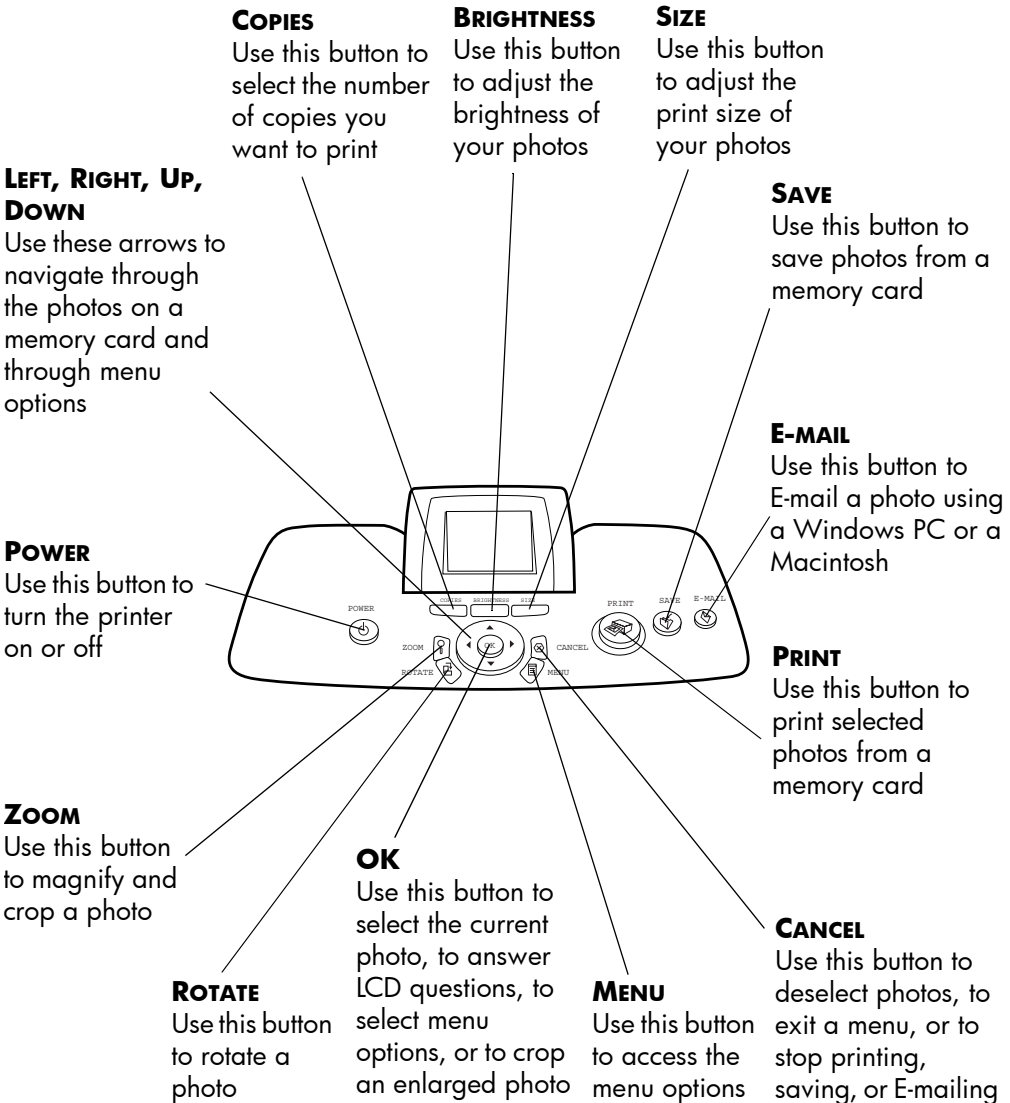



## card slots

### CompactFlash/IBM Microdrive memory card slot

Insert a CompactFlash or IBM Microdrive memory card into this slot to view, save, or print your photos

### SmartMedia memory card slot

Insert a SmartMedia memory card into this slot to view, save, or print your photos

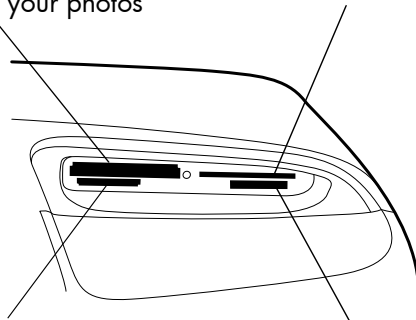

### MultiMediaCard/Secure Digital memory card slot

Insert a MultiMediaCard or Secure Digital memory card into this slot to view, save, or print your photos

### Memory Stick memory card slot

Insert a Memory Stick memory card into this slot to view, save, or print your photos

## indicator lights

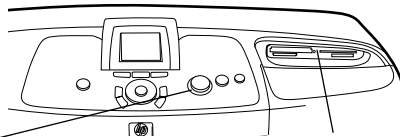

### Print light On (Green)

The power is on

### Off

The power is off

### Blinking (Green)

The printer is busy

### Blinking (Amber)

The printer requires attention

### Memory card light (Green)

The memory card is inserted correctly

### Off

There is no memory card inserted

### Blinking

Information is being transmitted between the memory card and the printer or computer

## paper information

You can print on a wide variety of paper types and sizes, from index cards and photo paper to envelopes and transparencies. We recommend using HP-designed inkjet paper for the best results.



If you are using HP-designed inkjet paper, remember to set the paper type in the printer Properties dialog box (Windows PC) or the Print dialog box (Macintosh).

- Use the IN tray for all supported paper types and sizes
- Use the photo tray when printing on 4 x 6 inch (10 x 15 cm) photo paper
- Use the envelope slot on the OUT tray when you need to print a single envelope

For more information on supported paper types and sizes, see **specifications** on page 53.

### load paper in the IN tray

- 1 Lift the OUT tray.

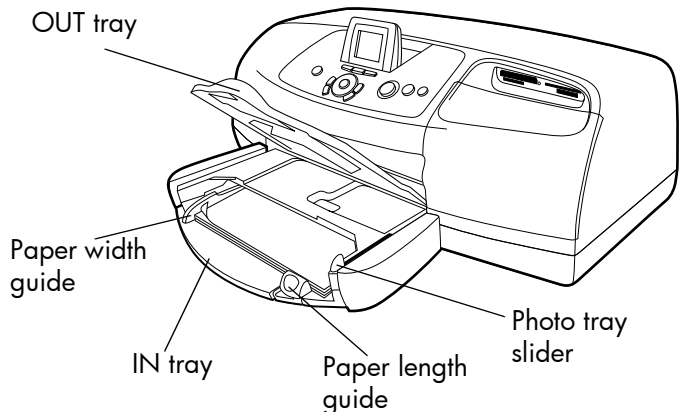

- 2 Pull out the paper length guide on the IN tray and slide the paper width guide as far to the left as it will go.

- 3 Place a stack of paper in the IN tray.
  - Load the paper with the **side to be printed facing down**. The printer pulls the paper in, flips it over, and then prints on the paper; the finished document faces up in the OUT tray.
  - Always load paper in the portrait direction, with the shortest edge toward you.
  - Be careful not to use too much or too little paper. If the tray contains only one or two sheets, the printer may have trouble picking up the paper, or the paper may bend and not feed correctly.
  - Use one type and size of paper at a time. Do not mix paper types or sizes in the IN tray.
- 4 Move the photo tray slider toward you until it stops. This disengages the photo tray.
- 5 Adjust the paper width guide and paper length guide to fit close to the edges of the paper without bending the paper. This helps the paper feed straight into the printer.
- 6 Lower the OUT tray.

## load photo paper in the photo tray

When you use the photo tray, you can leave paper in the IN tray.



If you run out of photo paper in the photo tray during a print job, the printer continues to print using paper from the IN tray.

- 1 Move the photo tray slider toward you until it stops. This disengages the photo tray.
- 2 Lift the photo tray cover.
- 3 Load paper in the photo tray with the **side to be printed facing down**. If you are using tabbed paper, insert the paper so the tab feeds in last. The printer pulls the paper in, flips it over, then prints on the paper; the finished document faces up in the OUT tray.
  - You can load up to 20 sheets of paper in the photo tray.
  - Be careful not to use too much or too little paper. It may be difficult for the printer to pick up a sheet of paper when there are only one or two sheets in the photo tray.

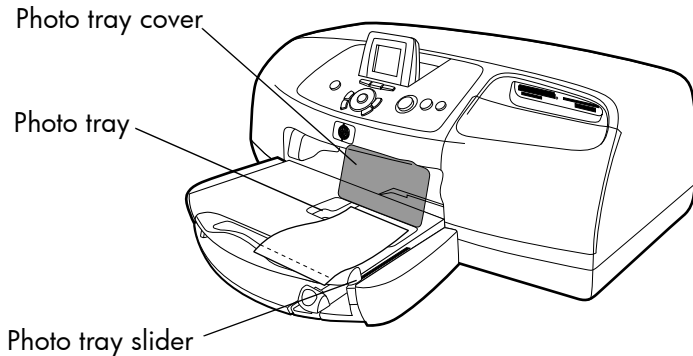

- 4 Lower the photo tray cover.
- 5 Move the photo tray slider away from you (toward the inside of the printer) until it stops against the edge of the paper. This engages the photo tray.
- 6 When you finish using the photo tray, move the photo tray slider toward you until it stops. This disengages the photo tray so the printer uses the paper in the IN tray.

See the HP Photosmart Printer Help for more information on:

- Loading a single envelope
- Loading a stack of envelopes
- Loading index cards and other small media
- Loading transparencies

## print cartridge information

Your HP Photosmart 7550 printer comes equipped with three print cartridges:

- **HP #57 (C6657A)** — Tri-color print cartridge
- **HP #58 (C6658A)** — Photo print cartridge
- **HP #56 (C6656A)** — Black print cartridge

Printing with all three print cartridges ensures that you get the best quality printouts.

## use reserve mode

Reserve Mode allows you to keep printing if one or two of your print cartridges fails, runs out of ink, or is incompatible with your printer. If a print cartridge error message appears on the LCD, remove the print cartridge and close the side door to enter Reserve Mode. You will see a message reminding you that the printer is in Reserve Mode.

Printing in Reserve Mode slows the printer and affects the print quality.

If you are printing with only a...	The result is...
Black print cartridge	Colors print as grayscale
Tri-color print cartridge	Colors print but black prints as gray
Photo print cartridge	Colors print as grayscale



Although Reserve Mode allows you to keep printing, the print quality is reduced. For the highest print quality, be sure to replace the missing print cartridge as soon as possible.

## install or replace the print cartridges

To get the best performance from your printer, use only genuine HP supplies, including genuine HP factory-filled print cartridges.

To get maximum use from your print cartridges, use the **POWER** button to turn off the printer. Do not unplug the printer or turn off the power source (such as a power strip) until the Print light is off. This allows the printer to store the print cartridges in a protected state.

**Caution!** Check that you are using the correct print cartridges. Do not refill print cartridges yourself. Damage that results from modifying or refilling HP print cartridges is specifically excluded from the HP printer warranty coverage.

- 1 If the printer is off, press the **POWER** button on the printer's control panel to turn the printer on.
- 2 Load plain paper in the IN tray so the printer can print a calibration page after you install the print cartridges.
- 3 Open the side door.
- 4 Lift the cradle latch of the print cartridge you want to install or replace by placing your finger under the number on the latch and pulling out. The print cartridge latch will pop open.
- 5 If you are replacing a print cartridge, slide out the old print cartridge and recycle or discard it.

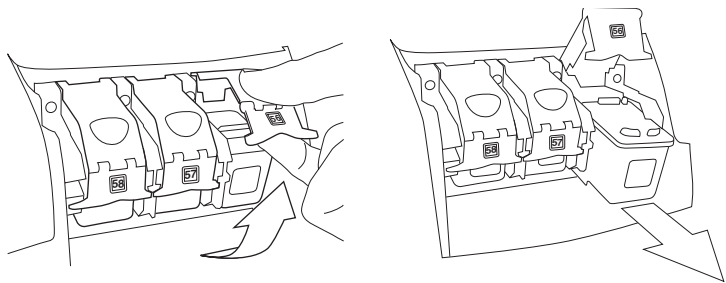

- 6 Take the new print cartridge out of its package.
- 7 Grasp the pink tab and gently peel off the plastic tape. Make sure you remove only the clear tape. Do not touch or remove the copper contacts.

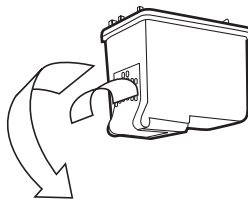

Do **NOT** touch the ink nozzles or the copper contacts. Touching these parts may cause print cartridge failure.

- 8 Insert the print cartridge:
  - Hold the print cartridge so the copper contacts go into the printer first. Line up the ridges on the left and right sides of the top of the print cartridge with the grooves

on the inside of the print cartridge cradle. Carefully slide the print cartridge into the cradle, then firmly push the cartridge in until it stops.

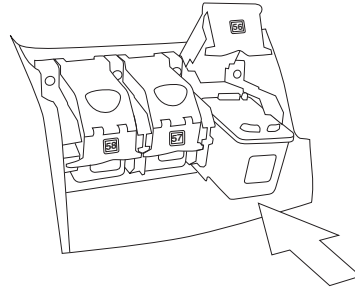

- Lower the cradle latch. Place your finger on the top of the latch. Place your thumb under the number on the latch and hold it forward while pushing the latch down. Release the latch to lock the print cartridge into place.
- 9 Close the side door. The printer prints a calibration page.

## use the control panel

### use the buttons

Your printer's control panel has several buttons:

- **BRIGHTNESS** — Use this button to adjust the brightness of your photo. Press and hold the button to change the brightness rapidly.
- **CANCEL** — Use this button to deselect photos, to exit a menu, or to stop printing, saving, or E-mailing.
- **COPIES** — Use this button to select the number of copies you want to print. Press and hold the button to change the number of copies rapidly.
- **E-MAIL** — Use this button to send a photo via E-mail.
- **LEFT, RIGHT, UP, DOWN** — Use the **LEFT** or **RIGHT** arrow to scroll through all the photos on a memory card. Use the **UP** or **DOWN** arrow to scroll through menu options or selected photos. Press and hold the arrows to change the selection rapidly.
- **MENU** — Use this button to access the menu options.
- **OK** — Use this button to select the current photo, to answer LCD questions, to select menu options, or to crop an enlarged photo.

- **POWER** — Use this button to turn the printer on or off.
- **PRINT** — Use this button to print photos from a memory card.
- **ROTATE** — Use this button to rotate the selected photo or crop box in 90° increments.
- **SAVE** — Use this button to save photos from a memory card to your computer.
- **SIZE** — Use this button to adjust the print size of a photo. Press and hold the button to change the size rapidly.
- **ZOOM** — Use this button to change the magnification of the currently selected photo or to crop the photo.

## use the indicator lights

Your printer's control panel has two indicator lights:

- **Print light** — When this light is on, the power is on. When this light is blinking green, the printer is busy. When this light is blinking amber, the printer requires attention.
- **Memory card light** — When this light is off, there is no memory card inserted in a memory card slot. When this light is green, a memory card is inserted correctly. When this light is blinking green, information is being transmitted between the memory card and the printer or computer.



## menu map

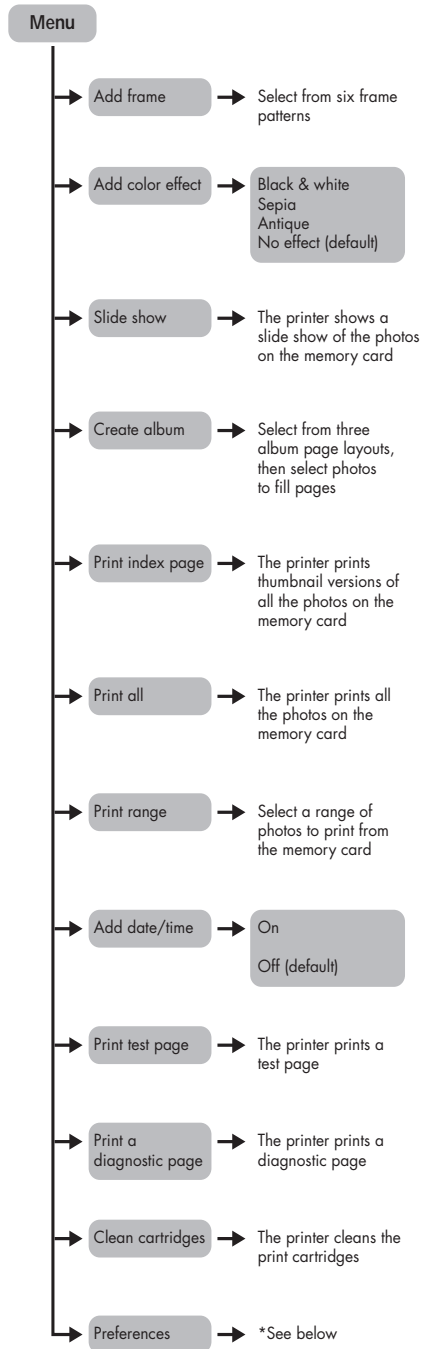

## Preferences

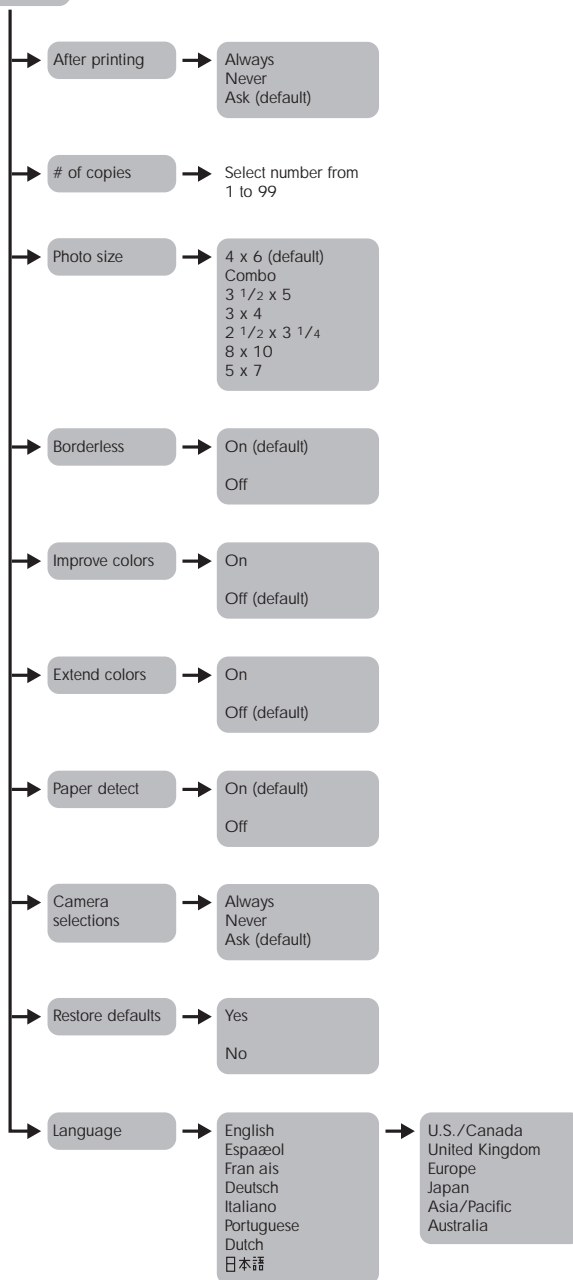

## use your printer with a camera

# 2

Your HP Photosmart 7550 printer lets you print beautiful photos from your HP direct-printing digital camera without using your computer.

### print camera-selected photos

If you have an HP direct-printing digital camera, you can use your printer to print camera-selected photos.

#### select and print photos

- 1 Use your camera's Share menu to select the photos you want to print.
- 2 Connect the camera to the camera port on the front of your printer using the USB cable that came with your camera.

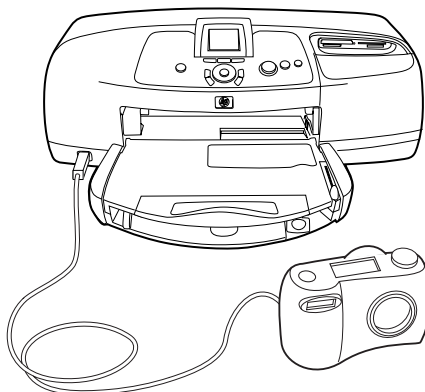

- 3 When you connect the camera to the printer, the camera's Print Setup menu appears. Use this menu to:
  - Change the photos you have selected for printing
  - Select the paper type
  - Select the paper size

- 4 When you are ready to print, follow the instructions on your camera's LCD.



To learn more about using camera-selected photos, see the documentation that came with your camera.

## print from a memory card

If your digital camera uses a memory card to store photos, you can insert a memory card into the printer to print your photos without using a computer. The printer LCD guides you through the process.

Your printer supports seven different memory cards. These cards are manufactured by several vendors and are available in a variety of storage capacities. You can purchase memory cards where you purchased your digital camera or at most computer supply stores.

### supported memory cards

The printer can read **CompactFlash™ Association (CFA) certified Type I or II**, **IBM Microdrive™** (up to 528 MB), **SmartMedia™**, **MultiMediaCard™**, **Secure Digital™**, and **Memory Stick™** memory cards.

**Caution!** Using any other type of memory card may damage the memory card and the printer.

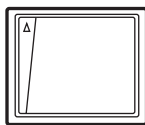

CompactFlash  
Type I or II

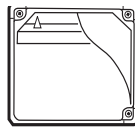

IBM Microdrive  
(up to 528 MB)

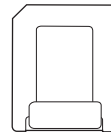

SmartMedia

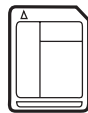

MultiMediaCard



Secure Digital

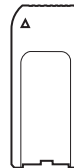

Memory Stick

If your digital camera supports multiple file types, it may be able to save photos in several different file formats, such as JPEG, uncompressed TIFF, FlashPix, and RAW. You can print JPEG and uncompressed TIFF files directly from the memory card. To print other file types, save the photos to your computer and print them using a software application.

## insert a memory card

After you have taken pictures with your digital camera, you can insert a memory card into your printer to print photos immediately or use the printer to save the photos to your computer.



The printer can only access one memory card slot at a time.

When you insert the memory card correctly, the memory card light illuminates. The LCD briefly shows the number of photos on the memory card, then displays the first photo.

**Caution!** Do not pull out the memory card while the memory card light is blinking. Removing a memory card while it is being accessed may damage the printer or the memory card, or corrupt the information on the memory card.

## insert a CompactFlash or IBM Microdrive memory card

Insert the memory card into the upper left memory card slot so the front of the memory card faces up. Insert the edge with pin holes into the printer first.

**Caution!** Inserting the card any other way may damage the memory card or the printer.

Gently push the memory card into the printer until it stops. The card may not insert all the way into the printer. Forcing the card in too far may result in damage to the memory card and the printer.

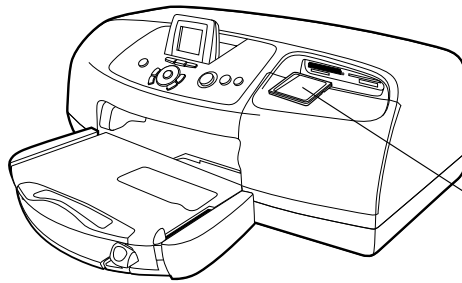

CompactFlash or  
IBM Microdrive  
memory card

### insert a MultiMediaCard or Secure Digital memory card

Insert the memory card into the lower left memory card slot so the front of the memory card faces up and the side with the metal contacts faces down. Insert the end with the metal contacts into the printer first.

**Caution!** Inserting the card any other way may damage the memory card or the printer.

Gently push the memory card into the printer until it stops. The card may not insert all the way into the printer. Forcing the card in too far may result in damage to the memory card and the printer.

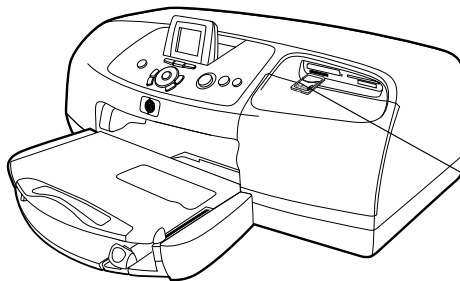

MultiMediaCard  
or SecureDigital  
memory card

### insert a SmartMedia memory card

Insert the memory card into the upper right memory card slot so the front of the memory card (the black side) faces up and the side with the metal contacts faces down. Insert the end with the metal contacts into the printer first.

**Caution!** Inserting the card any other way may damage the memory card or the printer.

Gently push the memory card into the printer until it stops. The card may not insert all the way into the printer. Forcing the card in too far may result in damage to the memory card and the printer.

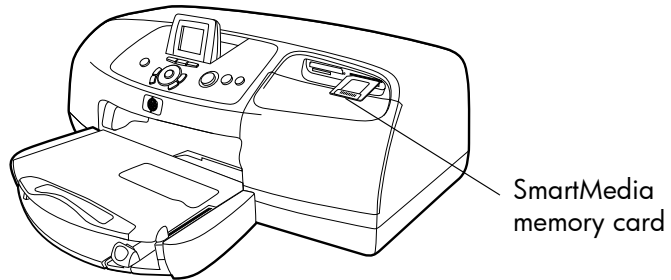

### insert a Memory Stick memory card

Insert the memory card into the lower right memory card slot so the side with the metal contacts faces down. Insert the end with the metal contacts into the printer first.

**Caution!** Inserting the card any other way may damage the memory card or the printer.

Gently push the memory card into the printer until it stops. The card may not insert all the way into the printer. Forcing the card in too far may result in damage to the memory card and the printer.

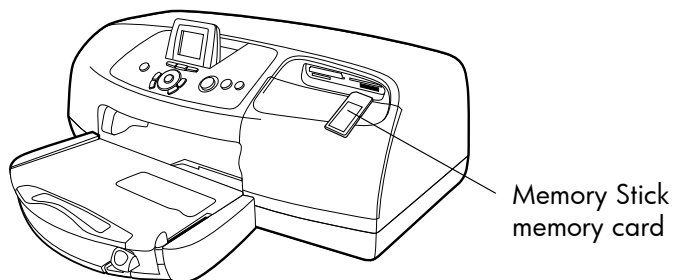

## decide which photos to print

You can decide which photos to print by viewing the photos on the printer's LCD or by printing an index page.

## print photos from the control panel

### view photos on the LCD

- 1 Insert a memory card into the printer's memory card slot.
- 2 Wait for the first photo stored on the memory card to appear on the LCD, then press the **LEFT** or **RIGHT** arrow to view the photos. Each time you press an arrow, a new photo appears on the LCD.

### print a photo index page

- 1 Insert a memory card into the printer's memory card slot.
- 2 Wait for the first photo stored on the memory card to appear on the LCD, then press the **MENU** button on the printer's control panel.
- 3 Press the **DOWN** arrow until **Print index page** appears highlighted on the LCD, then press the **OK** button.

For information on printing and saving photos from a memory card, see HP Photosmart Printer Help.

Printing photos from a memory card is as easy as inserting the memory card into the printer's memory card slot, selecting the photos you want to print, and pressing the **PRINT** button.

- 1 Insert a memory card into the printer's memory card slot.
- 2 Wait for the first photo stored on the memory card to appear on the LCD, then press the **LEFT** or **RIGHT** arrow until the photo you want to print appears on the LCD.
- 3 Press the **COPIES**, **BRIGHTNESS**, or **SIZE** buttons to adjust the print settings.



To print more than one photo at a time, press the **OK** button to select each photo.

- 4 Press the **PRINT** button.

For more information on printing individual or multiple photos, printing a continuous range of photos, or printing photos in a variety of sizes, see the HP Photosmart Printer Help.



# use your printer with a computer

# 3

You can use your HP Photosmart 7550 printer with any Windows PC or Macintosh software application that allows printing. You can print all kinds of projects, such as photo album pages, greeting cards, or newsletters.

If you already know how to use a printer with your computer, you can begin printing as usual. If you are new to printing, or if you have questions, use this chapter to learn more.

When you print from your computer, the control panel settings on the printer do not apply; the software on your computer overrides the printer's print settings.

## print from a Windows PC

### print from a software application

- 1 From your software application's **File** menu, select **Print**.
- 2 In the Print dialog box, select the pages and the number of copies you want to print.

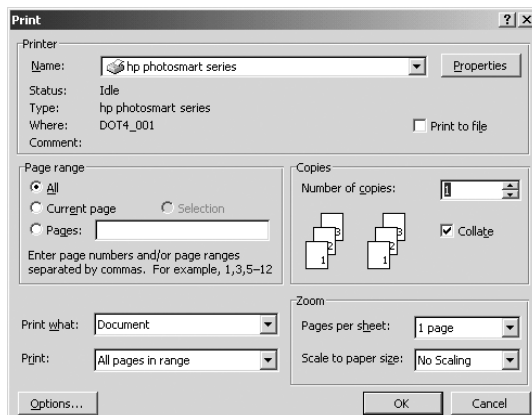

- 3 To access more advanced settings, click **Properties**. Set the printer properties (such as print quality and paper type) and click **OK**.

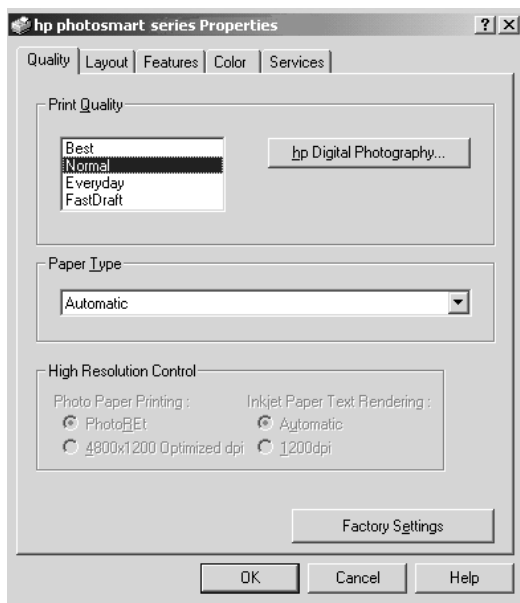

To learn more about the available settings, click the ? in the upper right corner of the printer Properties dialog box, then click the item you want more information about. You can also click **Help**.



- 4 Click **OK** to begin printing.

See the HP Photosmart Printer Help for more information on:

- Changing the default print settings
- Zooming, rotating, and cropping photos
- Adjusting photo color and brightness
- Printing photo album and index pages

## use the Windows PC taskbar icons

After you install the printer software, two icons appear in your Windows taskbar:

- The HP Photosmart printer icon 
- The HP Photosmart memory card icon 

These icons help you perform a variety of tasks.

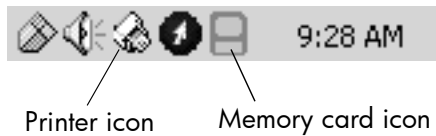

Printer icon

Memory card icon

### hp photosmart printer icon

Use the printer icon to access the printer Properties dialog box, select a default printer, or access the HP Photosmart Toolbox.

- When you click the printer icon, the printer Properties dialog box appears.
- When you right-click the printer icon, the following menu appears. Make your selection from the menu.

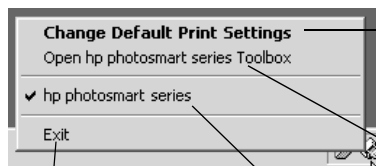

Click to open the printer Properties dialog box

Click to open the HP Photosmart Toolbox



Click to close the menu and remove the printer icon from the taskbar. To close the menu without removing the printer icon from the taskbar, click anywhere outside the menu

Select the HP Photosmart printer you want to use from the list of installed printers. A check mark indicates the currently selected printer

### hp photosmart memory card icon

Use the memory card icon to determine the status of your printer, access the photos stored on your memory card, and display the connection dialog boxes.

The appearance of the icon tells you the status of the printer.

	When the memory card icon is green, a memory card is inserted in the printer and the printer is ready to access the photos stored on the memory card.
	When the memory card icon is gray, a memory card is not inserted in the printer.
	When a red "x" appears on the memory card icon, the connection between the printer and the computer has been lost. To print from the computer you must re-establish communication. See <b>Windows PC connection problems</b> on page 27 for information about re-establishing communication.

When you right-click the memory card icon, the following menu appears. Make your selection from the menu.

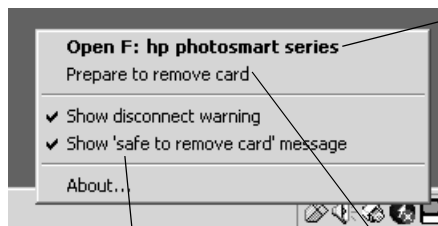

Click to open Windows Explorer where you can move, copy, delete, or open photos. You can also double-click the memory card icon to open Windows Explorer

Click one of the "Show..." lines if you want connection messages to appear when the printer loses communication or attempts to regain communication with your computer. A check mark indicates the message will appear

Click to remove the memory card from the printer

See the HP Photosmart Printer Help for more information on:

- Setting the printer properties
- Using the HP Photosmart Toolbox
- Using the HP Photo & Imaging Director

## print from a Macintosh

### print from a software application (OS X or OS 9.x)



The following steps are specific to OS X. For OS 9.x, the steps may be slightly different. Be sure you have selected your Photosmart printer in the Print Center (OS X) or in the Chooser (OS 9.x) before you begin printing. For more information, see the *HP Photosmart Software Setup & Product Support* booklet that came with your printer.

- 1 From your software application's **File** menu, select **Page Setup**.
- 2 In the **Format for** pull-down menu, select **Photosmart 7550**, then select the page attributes (such as paper size, orientation, and scaling) for your project. When you have finished selecting the page attributes, click **OK**.

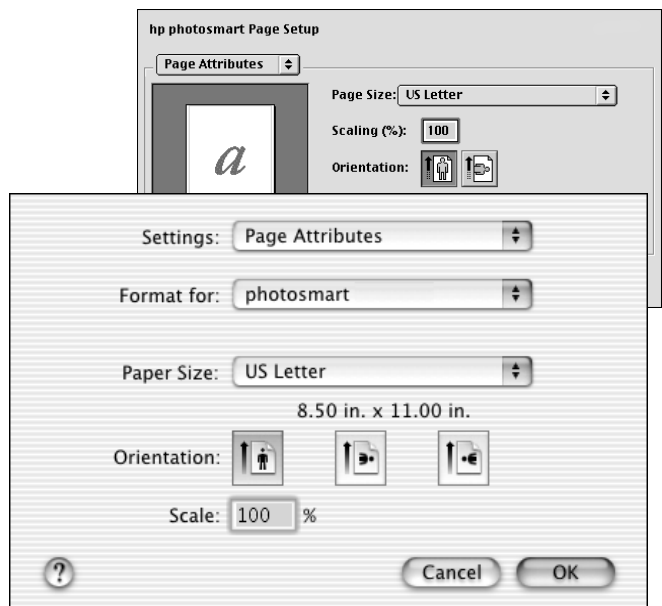

- 3 From your software application's **File** menu, select **Print**.
- 4 Select the print settings appropriate for your project. Use the pull-down menu to access the other panels.

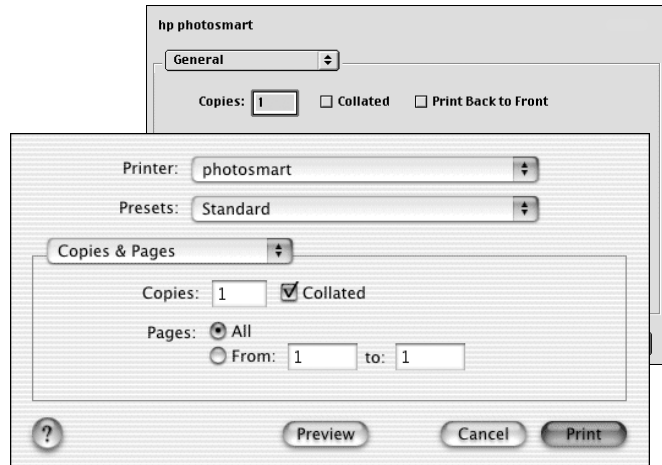

- 5 Click **Print** (OS X) or **OK** (OS 9.x) to begin printing.



To learn more about the available settings, click the **?** in the lower left corner of the dialog box (OS X only).

See the HP Photosmart Printer Help for more information on:

- Changing the default print settings
- Zooming, rotating, and cropping photos
- Adjusting photo color and brightness
- Printing photo album and index pages

# troubleshooting

# 4

Your HP Photosmart printer is designed to be reliable and easy to use. This section offers tips and advice for addressing frequently asked questions. Before you begin, make sure:

- All the cable connections between your printer and computer are secure.
- You are using the most recent version of the software. Go to **www.hp.com** to check for software updates. See the *HP Photosmart Software Setup & Product Support* booklet that came with your printer for contact information.

## Windows PC connection problems

If you are using your HP Photosmart printer with a Windows PC, the printer requires a continuous connection to the computer. The computer uses this communication link to receive feedback from the printer.

If the connection between your Windows PC and your HP Photosmart printer is lost, a warning message appears on your computer screen.



Possible causes of a lost connection are:

- The computer might not be connected to the printer, the printer might be off, or the printer might not be connected to a power source.
- You might be using a USB hub or docking station that has multiple devices connected to it. Accessing another device can temporarily break the connection to the printer. Wait until the other device is no longer being accessed, or connect the printer directly to the computer.

Whenever a connection is broken, the Windows taskbar displays this icon: .

To reconnect, try the following:

- Make sure the USB cable is securely attached to both the computer and to the USB port on the **back** of the printer.
- Make sure that the printer's power cord is securely attached, that the printer is connected to a power source, and that it is turned on.
- If the connection is still broken, right-click the broken connection memory card icon and select **Reconnect hp photosmart series** from the menu.



If an HP Photosmart dialog box appears, click **Retry** to try to re-establish a connection.

## Macintosh connection problems

If you are using your HP Photosmart printer with a Macintosh computer, the printer requires a continuous connection to the computer. The computer uses this communication link to receive feedback from the printer.

If the connection between your Macintosh computer and your HP Photosmart printer is lost, a warning message appears on your computer screen.





# USB connection problems

Problem	Possible cause	Solution
My printer is connected with a USB cable through another USB device or a hub and when I try to print I get an error message.	Your printer may not be getting good data from the other device or hub. OR Two-way communication between the printer and the computer was interrupted by another device attached to the hub.	Try the following: <ul style="list-style-type: none"><li>• Connect the printer directly to the USB port on the computer.</li><li>• Make sure the USB cable is securely attached to both the computer and to the USB port on the <b>back</b> of the printer.</li><li>• Try disconnecting other USB devices from the hub and print your document again.</li></ul>
	The USB cable is too long.	Make sure you are using a USB cable length that is supported by your printer. For more information, see <b>specifications</b> on page 53.

Problem	Possible cause	Solution
<p>When I connect a USB cable between the printer and my computer, I get an error saying YOU HAVE CONNECTED YOUR COMPUTER TO THE PRINTER'S FRONT USB PORT.</p>	<p>You have connected your computer to the camera port on the front of the printer. This port should only be used to connect an HP direct-printing digital camera to the printer.</p>	<p>Try connecting the USB cable to the USB port on the <b>back</b> of the printer.</p> <p>If you were installing the printer software when you received the error message, try the following:</p> <p><b>Windows PC</b></p> <ol style="list-style-type: none"> <li>1 Uninstall the printer software. Insert the printer software CD into your computer, click <b>Remove HP Photosmart software</b>, then follow the instructions on your computer screen.</li> <li>2 When the uninstall is complete, restart your computer.</li> <li>3 Connect the USB cable to the USB port on the <b>back</b> of the printer.</li> <li>4 Reinstall the printer software. For instructions, see the <i>Software Setup &amp; Product Support</i> booklet.</li> </ol> <p><b>Macintosh</b></p> <ol style="list-style-type: none"> <li>1 Uninstall the printer software. Insert the printer software CD into your computer, select <b>Uninstall</b> from the Installer, then follow the instructions on your computer screen.</li> <li>2 When the uninstall is complete, restart your computer.</li> <li>3 Connect the USB cable to the USB port on the <b>back</b> of the printer.</li> <li>4 Reinstall the printer software. For instructions, see the <i>Software Setup &amp; Product Support</i> booklet.</li> </ol>

Problem	Possible cause	Solution
<p><b>Windows PC only</b> I have connected my printer using a USB cable, and when I try to print I get a message saying THERE WAS AN ERROR WRITING TO DOT4.</p>	<p>There is a problem with the USB connection.</p>	<p>Try the following:</p> <ul style="list-style-type: none"> <li>• Unplug the USB cable from the computer, then plug it in again.</li> <li>• Make sure the cable is securely attached to both the computer and to the USB port on the <b>back</b> of the printer.</li> <li>• Restart your computer.</li> </ul>
<p><b>Windows PC only</b> When I connect a USB cable between the printer and my computer, the New Hardware Wizard does not appear. <i>(continued on next page)</i></p>	<p>You may not be using Windows 98, 2000, ME, or XP.</p>	<p>Make sure your computer's operating system is Windows 98, 2000, ME, or XP and that your computer is connected to the USB port on the <b>back</b> of the printer using a USB cable.</p>
	<p>Your USB cable may not be working or may not be connected properly.</p>	<p>Try the following:</p> <ul style="list-style-type: none"> <li>• Make sure the USB cable is securely attached to both the computer and to the USB port on the <b>back</b> of the printer.</li> <li>• Disconnect, then reconnect the USB cable from your printer.</li> <li>• Unplug the power cord from the printer, then plug it in again.</li> <li>• If you are still having problems, try using another USB cable.</li> </ul>
	<p>The USB cable is too long.</p>	<p>Make sure you are using a USB cable length that is supported by your printer. For more information, see <b>specifications</b> on page 53.</p>

Problem	Possible cause	Solution
<p><i>(continued from previous page)</i></p> <p><b>Windows PC only</b></p> <p>When I connect a USB cable between the printer and my computer, the New Hardware Wizard does not appear.</p>	<p>You may not have USB enabled.</p>	<p>Unplug the power cord and the USB cable from the printer, then plug them in again.</p> <p>OR</p> <p>Try the following:</p> <ol style="list-style-type: none"> <li><b>1</b> In Windows 98, 2000, or ME, click <b>Start, Settings, Control Panel</b>. In Windows XP, click <b>Start, Control Panel</b>.</li> <li><b>2</b> In Windows 98, 2000, or ME, double-click the <b>System</b> icon. In Windows XP, click <b>Performance and Maintenance</b>, then click the <b>System</b> icon.</li> <li><b>3</b> In Windows 98, 2000, or ME, click the <b>Device Manager</b> tab. In Windows XP, click the <b>Hardware</b> tab, then click <b>Device Manager</b>.</li> <li><b>4</b> Click the (+) icon next to the <b>Universal Serial Bus Controller</b> option. If you see a USB host controller and a USB root hub listed, USB is probably enabled. If you do not see these devices listed, refer to your computer's documentation or contact the computer manufacturer for more information on enabling and setting up USB.</li> </ol>

Problem	Possible cause	Solution
<p><b>Windows PC only</b></p> <p>When I connected a USB cable between the printer and my computer, the New Hardware Wizard appeared once, but the printer did not install completely. Now the New Hardware Wizard will not appear again.</p>	<p>Installation was not completed, it was cancelled, or there was an error.</p>	<p>Try the following:</p> <ol style="list-style-type: none"> <li>1 Disconnect the USB cable from your computer.</li> <li>2 Unplug the power cord from the printer, then plug it in again.</li> <li>3 Uninstall the printer software. Insert the printer software CD into your computer, click <b>Remove HP Photosmart software</b>, then follow the instructions on your computer screen.</li> <li>4 When the uninstall is completed, restart your computer.</li> <li>5 Reconnect the USB cable to your computer. Make sure the cable is securely attached to the USB port on the <b>back</b> of the printer.</li> <li>6 Reinstall the printer software. For instructions, see the <i>Software Setup &amp; Product Support</i> booklet.</li> </ol>
<p><b>Windows PC only</b></p> <p>When I connect a USB cable between the printer and my computer, an UNKNOWN DEVICE message appears.</p>	<p>Static electricity has built up in the cable between your computer and printer. OR You may have a defective USB cable. OR Your USB cable may not be connected properly. OR The software could not identify the printer; the printer-USB connection may be defective.</p>	<p>Try the following:</p> <ol style="list-style-type: none"> <li>1 Disconnect the USB cable from your printer.</li> <li>2 Disconnect the power cord from the printer.</li> <li>3 Wait approximately 10 seconds.</li> <li>4 Plug the power cord back into the printer.</li> <li>5 Plug the USB cable back into the port on the <b>back</b> of the printer.</li> <li>6 If UNKNOWN DEVICE continues to appear in the New Hardware Wizard, check <b>www.hp.com</b> for updates or contact HP Support and Services. For contact information, see the <i>Software Setup &amp; Product Support</i> booklet that came with your printer.</li> </ol>

Problem	Possible cause	Solution
<b>Macintosh only</b> My printer is connected with a USB cable through another USB device or a hub and my printer and computer have lost communication.	Your printer may not be getting good data from the other device or hub. OR Two-way communication between the printer and the computer was interrupted by another device attached to the hub.	Try the following: <ul style="list-style-type: none"> <li>• Connect the printer directly to the USB port on the computer.</li> <li>• Make sure the USB cable is securely attached to both the computer and to the USB port on the <b>back</b> of the printer.</li> <li>• Try disconnecting other USB devices from the hub and print your document again.</li> </ul>
	The USB cable is too long.	Make sure you are using a USB cable length that is supported by your printer. For more information, see <b>specifications</b> on page 53.

## printer problems

Problem	Possible cause	Solution
Printing is very slow. <i>(continued on next page)</i>	Your computer may have less than the recommended system requirements.	Check the amount of free RAM (memory) and the processor speed of your computer. For information on the system requirements, see <b>specifications</b> on page 53.
	Too many software programs may be running at the same time.	Close all unnecessary software programs.

Problem	Possible cause	Solution
<p>(continued from previous page)            Printing is very slow.            (continued on next page)</p>	<p>You may be using outdated printer software.</p>	<p>Check <a href="http://www.hp.com">www.hp.com</a> for the most recent software updates. For contact information, see the <i>Software Setup &amp; Product Support</i> booklet that came with your printer.</p> <p><b>Windows PC</b>            Use HP's Web Update software to check the version of the printer driver you are using.</p> <p><b>Macintosh</b>            Use the Print dialog box (OS 9.x) or the Print Center (OS X) to check the version of the printer driver you are using.</p>
	<p>You may be printing a complex document containing graphics or photographs.            OR            You may be trying to print a high resolution photo.</p>	<p>Try the following:</p> <ul style="list-style-type: none"> <li>• Free up some space on your hard disk. Having less than 100MB of free space on your computer's hard disk can mean longer processing time.</li> <li>• Be patient. Large, complex documents containing graphics or photographs print slower than text documents.</li> </ul>
	<p>A page may be drying in the OUT tray.</p>	<p>If this is the case, the LCD displays this message: "Page is drying... To start next page, remove wet page and press OK."            You can either follow these directions or simply wait. Printing continues once the ink is dry.</p>



Problem	Possible cause	Solution
<p>(continued from previous page)</p> <p>Printing is very slow.</p> <p>(continued on next page)</p>	<p>You may have chosen <b>4800x1200 Optimized dpi</b>.</p>	<p><b>Windows PC</b></p> <ol style="list-style-type: none"> <li>1 On the <b>Quality</b> tab of the printer Properties dialog box, set the Print Quality to <b>Best</b> and set the Paper Type to <b>Photo Paper</b>. Under High Resolution Control, select <b>PhotoREt</b> instead of <b>4800x1200 Optimized dpi</b>.</li> <li>2 Try printing again.</li> </ol> <p><b>Macintosh</b></p> <ol style="list-style-type: none"> <li>1 On the <b>Paper Type/Quality</b> panel, deselect <b>High Resolution Photo</b>.</li> <li>2 Try printing again.</li> </ol>
	<p>You may be using a USB hub and other USB devices are in use.</p>	<p>Try the following:</p> <ul style="list-style-type: none"> <li>• Connect the USB cable directly from the computer to the USB port on the <b>back</b> of the printer; do not use a hub.</li> <li>• Avoid using other devices attached to a hub while printing.</li> </ul>
	<p>The Paper Type option may be set to <b>Automatic</b>.</p>	<p>When the paper type is set to <b>Automatic</b>, the printer scans the paper to determine the appropriate paper type. This may take a few extra seconds. To avoid this, select a specific paper type before printing.</p> <p><b>Windows PC</b></p> <ul style="list-style-type: none"> <li>• Select the appropriate paper type on the <b>Quality</b> tab of the printer Properties dialog box.</li> </ul> <p><b>Macintosh</b></p> <ul style="list-style-type: none"> <li>• Select the appropriate paper type on the <b>Paper Type/Quality</b> panel of the Print dialog box.</li> </ul>
	<p>You may be printing in Reserve Mode. The printer enters Reserve Mode when one of the print cartridges is missing.</p>	<p>Replace the missing print cartridge with a new one.</p>

Problem	Possible cause	Solution
<i>(continued from previous page)</i> Printing is very slow.	You may have selected the <b>Improve colors</b> or <b>Extend colors</b> settings from the printer's control panel.	Turn these settings off to speed up the printing process. For more information, see the <b>set defaults on your printer</b> section of Printer Help.
The printer will not turn on.	The printer may have drawn too much power.	Unplug the printer's power cord and wait approximately 10 seconds. Reconnect the power cord and press the <b>POWER</b> button to turn the printer on.
	The printer is plugged into a power strip and the power strip is turned off.	Turn the power strip on.
The Print light is blinking green but the printer is not printing.	The printer may be processing information.	Be patient. The printer needs some time to finish processing the information.
The Print light is blinking amber.	The printer needs attention.	Try the following: <ol style="list-style-type: none"> <li>1 Check the printer's LCD and the computer monitor for instructions.</li> <li>2 If this does not work, and you have a digital camera connected to the printer, check the camera's LCD for instructions.</li> <li>3 If this does not work, turn the printer off. Unplug the printer's power cord, wait one minute, then plug it in again. Turn the printer on.</li> </ol>

Problem	Possible cause	Solution
The Print light is blinking red.	An unrecoverable error has occurred.	Try the following: <b>1</b> Turn the printer off. Unplug the printer's power cord, wait one minute, then plug it in again. Turn the printer on. <b>2</b> If this does not work, check <b>www.hp.com</b> or contact HP Support and Services. For contact information, see the <i>Software Setup &amp; Product Support</i> booklet that came with your printer.
<b>Windows PC only</b> The broken connection memory card icon appears in the taskbar. 	There is a connection or communication problem between the printer and the computer.	Click the memory card icon, then click <b>Connect</b> in the dialog box. If there is still a connection problem, try the following: <ul style="list-style-type: none"> <li>• Check that the USB cable is securely attached to both the computer and the USB port on the <b>back</b> of the printer.</li> <li>• Unplug the USB cable from the computer, then plug it in again.</li> <li>• Unplug the power cord from the printer, then plug it in again.</li> </ul>
The printer cannot recognize the file on the memory card.	Your memory card contains file types the printer cannot read.	Set your camera to save the photos in file types the printer supports. For a list of supported file types, see the <b>specifications</b> section of the Printer Help. For instructions on setting your camera to save specific file types, see the documentation that came with your camera.

## printing problems

Problem	Possible cause	Solution
Photo paper does not feed into the printer correctly. (continued on next page)	The photo tray is not engaged.	Engage the photo tray by moving the photo tray slider away from you until it stops against the edge of the paper.

Problem	Possible cause	Solution
<i>(continued from previous page)</i> Photo paper does not feed into the printer correctly.	You are in an extremely high or low humidity environment.	Try the following: <ul style="list-style-type: none"> <li>• Insert the photo paper as far as it will go into the photo tray.</li> <li>• Load one sheet of photo paper at a time.</li> </ul>
Paper does not feed into the printer correctly. OR Paper does not come out of the printer correctly.	There may be too much paper loaded in the IN tray.	Remove some paper from the IN tray and try printing again.
	The paper guides may not be adjusted correctly.	Make sure that the paper width guide and the paper length guide fit close to the edges of the paper without bending the paper.
	The paper may be too thin or too thick.	For a list of supported paper weights, see the <b>specifications</b> section of the Printer Help.
	The paper may be wrinkled or bent.	Try using different paper.
No page came out of the printer. <i>(continued on next page)</i>	The printer needs attention.	Read the LCD for instructions.
	Power may be off or there may be a loose connection.	Try the following: <ul style="list-style-type: none"> <li>• Make sure the power is on.</li> <li>• Make sure the power cord is securely connected.</li> </ul>
	You may not have any paper in the IN tray.	Check that paper is loaded correctly in the IN tray. For paper-loading instructions, see <b>load paper in the IN tray</b> on page 6.
	The printer's side door may be open.	Close the printer's side door.

Problem	Possible cause	Solution
<p><i>(continued from previous page)</i>            No page came out of the printer.  <i>(continued on next page)</i></p>	<p>There may be a paper jam.</p>	<p>Try the following:</p> <ul style="list-style-type: none"> <li>• Check the LCD for instructions.</li> <li>• Remove the paper from the IN tray and the OUT tray.</li> <li>• If you were printing labels, make sure a label did not become unglued from the label sheet while going through the printer.</li> </ul> <p>If the paper is still jammed, try the following:</p> <ol style="list-style-type: none"> <li>1 Turn the printer off.</li> <li>2 Unplug the printer. Open the rear access door by turning the knob counter-clockwise. Remove the door.</li> <li>3 Gently remove the jammed paper from the printer, then replace the rear access door.</li> <li>4 Plug the printer back in and turn it on.</li> <li>5 When you have cleared the paper jam, print your document again.</li> </ol> <p>If you experience paper jams when printing on 4 x 6 inch (10 x 15 cm) photo paper, try the following:</p> <ul style="list-style-type: none"> <li>• Insert the photo paper as far as it will go into the photo tray.</li> <li>• Load one sheet of photo paper at a time.</li> </ul>
	<p>The print cartridge cradle may be stuck.</p>	<p>Try the following:</p> <ul style="list-style-type: none"> <li>• Check the LCD for error messages.</li> <li>• Remove any paper from the print cartridge cradle's path, then press the <b>OK</b> button.</li> </ul>
	<p>A problem may exist with one of the print cartridges.</p>	<p>Try the following:</p> <ul style="list-style-type: none"> <li>• Check the LCD for error messages.</li> <li>• Print a diagnostic page and replace the print cartridges if necessary.</li> </ul>

Problem	Possible cause	Solution
<i>(continued from previous page)</i> No page came out of the printer.	The printer may still be processing information.	For more information, see <b>printer problems</b> on page 35.
<b>Macintosh OS 9.x only</b> No page came out of the printer.	Not enough memory is allocated in the system's PrintMonitor application.	Allocate more memory to the application in the Get Info dialog box.
A blank page came out of the printer.	The print cartridge may be out of ink.	Print a diagnostic page and replace the print cartridges if necessary.
	You may have previously started a print job and then cancelled it.	If you cancel a print job before the file starts printing, the printer may have already loaded paper in preparation for printing. When you start the next print job, the printer ejects the blank page before continuing with the current job.
	You may be trying to print a fax.	Try the following: <b>1</b> Save the fax in a graphic format, such as TIFF. <b>2</b> Place it in a word processing document and print it from there.
	You are printing in Reserve Mode with only the black print cartridge installed and with borderless printing turned on. The printer cannot print borderless 4 x 6 inch (10 x 15 cm) photos in grayscale.	Replace the missing print cartridges with new ones. OR Turn borderless printing off. For more information on printing in Reserve Mode, see <b>use reserve mode</b> on page 9.

Problem	Possible cause	Solution
<p>The document or photo did not print using the selected print settings.</p>	<p>The printer's default print settings may be different than the application's print settings. An application's print settings override the printer's default settings.</p>	<p><b>Windows PC</b></p> <ul style="list-style-type: none"> <li>From the application's <b>File</b> menu, select <b>Print</b>, then click <b>Properties</b> to set the desired print settings.</li> </ul> <p><b>Macintosh</b></p> <ul style="list-style-type: none"> <li>From the application's <b>File</b> menu, select <b>Print</b> and set the desired print settings.</li> </ul>
	<p>You may have set the print settings differently for an individual photo; these settings override the printer's default settings.</p>	<ol style="list-style-type: none"> <li>Deselect the photo if it is not already deselected.</li> <li>Set the printer's default settings to your liking, then print the photo again. The photo should print using the defaults.</li> </ol>
<p>The paper type is set as <b>Automatic</b>, but when preparing to print, the printer ejects the paper.</p>	<p>The printer may be placed in direct sunlight, which overwhelms the automatic paper sensor.</p>	<p>Move the printer out of direct sunlight.</p>
<p>Parts of the document are missing or are in the wrong place. <i>(continued on next page)</i></p>	<p>You may have selected the incorrect paper orientation.</p>	<p><b>Windows PC</b></p> <ul style="list-style-type: none"> <li>Make sure you have selected the correct orientation (portrait or landscape) on the <b>Layout</b> tab of the printer Properties dialog box and in the application's Page Setup dialog box.</li> </ul> <p><b>Macintosh</b></p> <ul style="list-style-type: none"> <li>Make sure you have selected the correct orientation (portrait or landscape) in the Page Setup dialog box.</li> </ul>

Problem	Possible cause	Solution
<p>(continued from previous page)</p> <p>Parts of the document are missing or are in the wrong place.</p>	<p>You may have selected an incorrect paper size.</p>	<p><b>Windows PC</b></p> <ul style="list-style-type: none"> <li>• Make sure you have selected the correct paper size on the <b>Layout</b> tab of the printer Properties dialog box and in the application's Page Setup dialog box.</li> </ul> <p><b>Macintosh</b></p> <ul style="list-style-type: none"> <li>• Make sure you have selected the correct paper size in the Page Setup dialog box.</li> </ul>
	<p>You may have selected incorrect margins in your application.</p>	<p>Make sure the margins are within the printable areas. For more information, see the <b>specifications</b> section of the Printer Help.</p>
	<p>You may have accidentally left <b>Poster Printing</b> (Windows PC) or <b>Tiling</b> (Macintosh) on.</p>	<p><b>Windows PC</b></p> <ul style="list-style-type: none"> <li>• Deselect <b>Poster Printing</b> on the <b>Features</b> tab of the printer Properties dialog box.</li> </ul> <p><b>Macintosh</b></p> <ul style="list-style-type: none"> <li>• On the <b>Layout</b> panel in the Print dialog box, set the Pages Per Sheet to <b>1</b>.</li> </ul>
	<p>You may have incorrectly scaled text or graphics, or there may be file format problems within the document.</p>	<p>Make sure the text and graphics are scaled correctly and that the file formats are compatible within your document.</p>
<p>The document printed at an angle or is off-center.</p> <p>(continued on next page)</p>	<p>Paper may not be loaded correctly.</p>	<p>Try the following:</p> <ul style="list-style-type: none"> <li>• Make sure the paper is correctly oriented in the IN tray.</li> <li>• Make sure the paper width guide and the paper length guide fit close to the edges of the paper.</li> </ul> <p>For paper-loading instructions, see <b>load paper in the IN tray</b> on page 6.</p>



Problem	Possible cause	Solution
<p><i>(continued from previous page)</i> The document printed at an angle or is off-center.</p>	<p>The print cartridges may not be properly calibrated.</p>	<p><b>Windows PC</b></p> <ul style="list-style-type: none"> <li>Go to the <b>Device Services</b> tab of the <b>HP Photosmart Toolbox</b> and click <b>Calibrate the Printer</b>.</li> </ul> <p><b>Macintosh</b></p> <ul style="list-style-type: none"> <li>Go to the <b>Calibrate</b> panel in the <b>HP Inkjet Utility</b> and click <b>Align</b>.</li> </ul>
<p>Print quality is poor. <i>(continued on next page)</i></p>	<p>You may be printing in Reserve Mode. The printer enters Reserve Mode when one or two of the print cartridges is missing.</p>	<p>Replace the missing print cartridge(s) with a new one.</p>
	<p>You are printing in Reserve Mode with only the black print cartridge installed and borderless printing turned on.</p>	<p>Replace the missing print cartridges, or turn off borderless printing. For more information on printing in Reserve Mode, see <b>use reserve mode</b> on page 9.</p>
	<p>You may have enlarged the photo too much.</p>	<p>Press the <b>ZOOM</b> button one or more times to reduce the magnification.</p>
	<p>The print cartridge may be running out of ink.</p>	<p>Print a diagnostic page. OR</p> <p><b>Windows PC</b></p> <ul style="list-style-type: none"> <li>Check the ink levels of the print cartridges from the <b>Estimated Ink Level</b> tab of the <b>HP Photosmart Toolbox</b>.</li> </ul> <p><b>Macintosh</b></p> <ul style="list-style-type: none"> <li>Check the ink level status in the <b>HP Inkjet Utility</b>.</li> </ul> <p>If the print cartridge is running out of ink, replace the print cartridge.</p>

Problem	Possible cause	Solution
<p><i>(continued from previous page)</i>            Print quality is poor.  <i>(continued on next page)</i></p>	<p>You may not be using the best paper type for your output.</p>	<p>Try the following:</p> <ul style="list-style-type: none"> <li>• Make sure you are using a paper type intended for the printer. Use HP-designed inkjet paper for best results. For more information on paper types, see <b>specifications</b> on page 53.</li> <li>• Choose paper that is specifically designed for the output (photographs, transparencies, etc.) rather than plain paper.</li> </ul>
	<p>You may be printing on the wrong side of the paper.</p>	<p>Make sure the paper is loaded with the <b>side to be printed facing down</b>.</p>
	<p>You may not have selected the correct paper type in the printer software.</p>	<p><b>Windows PC</b></p> <ul style="list-style-type: none"> <li>• Make sure you have selected the correct paper type on the <b>Quality</b> tab of the printer Properties dialog box.</li> </ul> <p><b>Macintosh</b></p> <ul style="list-style-type: none"> <li>• Make sure you have selected the correct paper type on the <b>Paper Type/Quality</b> panel in the Print dialog box.</li> </ul>
	<p>You may need to clean the print cartridges.</p>	<p>On the printer's control panel, press the <b>MENU</b> button, press the <b>DOWN</b> arrow to select <b>Clean Print Cartridges</b>, then press the <b>OK</b> button.</p> <p>OR</p> <p><b>Windows PC</b></p> <ul style="list-style-type: none"> <li>• From the <b>Device Services</b> tab of the <b>HP Photosmart Toolbox</b>, click <b>Clean the Print Cartridges</b>.</li> </ul> <p><b>Macintosh</b></p> <ul style="list-style-type: none"> <li>• From the <b>Clean</b> panel in the <b>HP Inkjet Utility</b>, click <b>Clean</b>.</li> </ul>

Problem	Possible cause	Solution
<p><i>(continued from previous page)</i>            Print quality is poor.  <i>(continued on next page)</i></p>	<p>If black prints still show white streaks after cleaning the print cartridges, and you have determined that the print cartridges are not low on ink, you may have dropped one of the print cartridges.</p>	<p><b>Windows PC</b></p> <ol style="list-style-type: none"> <li>1 Click <b>Best</b>, instead of <b>Everyday</b> or <b>FastDraft</b>, on the <b>Quality</b> tab of the printer Properties dialog box.</li> <li>2 Print using the higher quality for one day.</li> <li>3 After one day, switch back to the desired print quality.</li> </ol> <p><b>Macintosh</b></p> <ol style="list-style-type: none"> <li>1 Click <b>Best</b>, instead of <b>Everyday</b> or <b>FastDraft</b>, on the <b>Paper Type/Quality</b> panel in the Print dialog box.</li> <li>2 Print using the higher quality for one day.</li> <li>3 After one day, switch back to the desired print quality.</li> </ol>
	<p>Your print cartridges may be out of alignment.</p>	<p><b>Windows PC</b></p> <ul style="list-style-type: none"> <li>• If the color and black ink are not lining up on the printed page, go to the <b>Device Services</b> tab of the <b>HP Photosmart Toolbox</b> and click <b>Calibrate the Printer</b>.</li> </ul> <p><b>Macintosh</b></p> <ul style="list-style-type: none"> <li>• If the color and black ink are not lining up on the printed page, go to the <b>Calibrate</b> panel in the <b>HP Inkjet Utility</b> and click <b>Align</b>.</li> </ul>
	<p>If the printing appears faded or dull, you may be using <b>Everyday</b> or <b>FastDraft</b> mode.</p>	<p><b>Windows PC</b></p> <ul style="list-style-type: none"> <li>• Click <b>Normal</b> or <b>Best</b>, instead of <b>Everyday</b> or <b>FastDraft</b>, on the <b>Quality</b> tab of the printer Properties dialog box.</li> </ul> <p><b>Macintosh</b></p> <ul style="list-style-type: none"> <li>• Click <b>Normal</b> or <b>Best</b>, instead of <b>Everyday</b> or <b>FastDraft</b>, on the <b>Paper Type/Quality</b> panel in the Print dialog box.</li> </ul>

Problem	Possible cause	Solution
<p>(continued from previous page)</p> <p>Print quality is poor.</p>	<p>If the printing appears faded or dull, you may be printing in Reserve Mode. The printer enters Reserve Mode when one of the print cartridges is missing.</p>	<ul style="list-style-type: none"> <li>• Check that all the print cartridges are correctly installed and are not running out of ink.</li> <li>• If you are printing in Reserve Mode, replace the missing print cartridge with a new one.</li> </ul>
	<p>You may not have selected <b>Best</b> print quality.</p>	<p><b>Windows PC</b></p> <ul style="list-style-type: none"> <li>• Click <b>Best</b> on the <b>Quality</b> tab of the printer Properties dialog box.</li> </ul> <p><b>Macintosh</b></p> <ul style="list-style-type: none"> <li>• Click <b>Best</b> on the <b>Paper Type/Quality</b> panel in the Print dialog box.</li> </ul>
	<p>If the print is smeared, the selected print quality may be using too much ink for the paper type.</p>	<p><b>Windows PC</b></p> <ul style="list-style-type: none"> <li>• Click <b>Everyday</b> or <b>FastDraft</b>, instead of <b>Best</b> or <b>Normal</b>, on the <b>Quality</b> tab of the printer Properties dialog box.</li> </ul> <p>OR</p> <ul style="list-style-type: none"> <li>• Reduce the amount of ink by clicking <b>Advanced Features</b> from the <b>Features</b> tab of the printer Properties dialog box and using the <b>Ink Volume</b> slider.</li> </ul> <p><b>Macintosh</b></p> <ul style="list-style-type: none"> <li>• Click <b>Everyday</b> or <b>FastDraft</b>, instead of <b>Best</b> or <b>Normal</b>, on the <b>Paper Type/Quality</b> panel in the Print dialog box.</li> </ul> <p>OR</p> <ul style="list-style-type: none"> <li>• Reduce the amount of ink. On the <b>Paper Type/Quality</b> panel in the Print dialog box, select the <b>Ink</b> tab in the Print dialog box. Use the sliders to adjust the ink density.</li> </ul>
<p>Photos are not printing correctly. (continued on next page)</p>	<p>You may not have loaded the photo paper correctly.</p>	<p>Load the photo paper with the <b>side to be printed facing down</b>. If you are using tabbed paper, load the paper so the tab feeds in last.</p>

Problem	Possible cause	Solution
<p>(continued from previous page)</p> <p>Photos are not printing correctly.</p>	<p>The photo paper may not have fed into the printer correctly.</p>	<p>Check for a paper jam, then try the following:</p> <ul style="list-style-type: none"> <li>• Insert the photo paper as far as it will go into the photo tray.</li> <li>• Load one sheet of photo paper at a time.</li> </ul>
	<p>You may not have selected the appropriate paper type or paper size.</p>	<p><b>Windows PC</b></p> <ol style="list-style-type: none"> <li>1 Select the appropriate HP photo paper as the paper type on the <b>Quality</b> tab of the printer Properties dialog box.</li> <li>2 Select the size of the photo paper as the <b>Paper Size</b>.</li> </ol> <p><b>Macintosh</b></p> <ol style="list-style-type: none"> <li>1 In the Page Setup dialog box, select the size of the photo.</li> <li>2 On the <b>Paper Type/Quality</b> panel of the Print dialog box, select <b>Photo Paper</b> as the paper type, then select the specific photo paper.</li> <li>3 Click <b>OK</b> to print your document.</li> </ol>
	<p>You may have used your application's Page Setup dialog box to select the paper size or type.</p>	<p><b>Windows PC</b></p> <ul style="list-style-type: none"> <li>• From the application's <b>File</b> menu, select <b>Print</b>, then click <b>Properties</b> to set the correct paper size and type.</li> </ul> <p><b>Macintosh</b></p> <ul style="list-style-type: none"> <li>• From the application's <b>File</b> menu, select <b>Page Setup</b> to set the paper size.</li> <li>• From the application's <b>File</b> menu, select <b>Print</b> to set the correct paper type.</li> </ul>
	<p>One or more of your print cartridges may be low on ink.</p>	<p>Check that all the print cartridges are correctly installed and are not running out of ink.</p>

Problem	Possible cause	Solution
<p>The photos I selected for printing using the numbers on the camera LCD did not print. Different photos printed instead.</p>	<p>Your camera may assign numbers to your photos that do not match the numbers that the printer assigns to them.</p>	<p>Print a photo index page. Use the number shown on the photo index page to select the photos to print. For more information, see <b>print a photo index page</b> on page 20.</p>
<p>The photos I marked for printing in my camera do not print.</p>	<p>Some digital cameras, such as the HP 318 and HP 612, let you mark photos for printing on both the camera's internal memory and on the memory card. If you move photos from the camera's internal memory to the memory card, the marks do not transfer.</p>	<p>Mark photos for printing after you transfer them from your camera's internal memory to the memory card.</p>
<p>The print quality is different if the paper type is set to <b>Automatic</b> rather than the specific paper type.</p>	<p>When the paper type is set to <b>Automatic</b>, the print quality automatically changes to <b>Normal</b>. When the paper type is set to a specific paper type, the default print quality may be different.</p>	<p><b>Windows PC</b></p> <ul style="list-style-type: none"> <li>• Select the appropriate paper type on the <b>Quality</b> tab of the printer Properties dialog box, then choose the desired print quality.</li> </ul> <p><b>Macintosh</b></p> <ul style="list-style-type: none"> <li>• Select the appropriate paper type on the <b>Paper Type/Quality</b> panel of the Print dialog box, then choose the desired print quality.</li> </ul>

Problem	Possible cause	Solution
<p>The paper type is set to <b>Automatic</b>, but the printer does not use the best print mode for the paper.</p>	<p>The paper may be marked, scratched, or wrinkled. OR The paper may be dark in color or contain metallic fibers.</p>	<p>If the paper is damaged, dark in color, or contains metallic fibers, the sensor may not detect paper type and size accurately. Make sure the paper is clean and free of scratches or wrinkles, is light-colored, and does not contain metallic fibers.</p> <p><b>Windows PC</b></p> <ul style="list-style-type: none"> <li>• Select the appropriate paper type on the <b>Quality</b> tab of the printer Properties dialog box.</li> </ul> <p><b>Macintosh</b></p> <ul style="list-style-type: none"> <li>• Select the appropriate paper type on the <b>Paper Type/Quality</b> panel of the Print dialog box.</li> </ul>
	<p>The paper may be letterhead or stationery with a preprinted pattern at the top edge.</p>	<p>Set the paper type manually instead of selecting <b>Automatic</b>.</p>

See the HP Photosmart Printer Help for more information on:

- Printing a diagnostic page
- Software problems
- USB connection problems
- Printer problems
- Printing problems
- Error messages





# specifications

# 5

## system requirements

Component	Windows PC minimum	Macintosh minimum
<b>Operating system</b>	Windows 98, 2000 Professional, ME, XP Home, and XP Professional	Macintosh® OS 9.x, OS X 10.1 or later
<b>Processor</b>	Pentium® II (or equivalent) or higher	G3 or greater
<b>RAM</b>	64 MB (128 MB recommended)	OS 9.x: 64 MB (128 MB recommended) OS X: 128 MB
<b>Free disk space</b>	500 MB	300 MB
<b>Video display</b>	800 x 600, 16-bit or higher	800 x 600, 16-bit or higher
<b>CD-ROM drive</b>	4x	4x
<b>Connectivity</b>	USB port and USB cable	USB port and USB cable
<b>Browser</b>	Microsoft® Internet Explorer 5.5 or higher	

# specifications

See the HP Photosmart Printer Help for additional specifications.

<b>Paper Tray Input Capacity</b>	100 sheets of letter 24 sheets of 4 x 6 inch (10 x 15 cm) photo 15 envelopes 40 index cards 20 sheets of banner paper 20 sheets of labels 25 transparencies 40 Hagaki cards
<b>Output Capacity</b>	50 sheets of 20 lb. paper, sizes A and A4 20 sheets of 4 x 6 inch (10 x 15 cm) photo paper 10 envelopes 10 cards
<b>Media Types</b>	Paper (plain, inkjet, photo, and banner) Envelopes Transparencies Labels Cards (index, greeting, Hagaki) Iron-on transfers
<b>Memory Card</b>	CompactFlash I, II (includes IBM Microdrive up to 528 MB) Memory Stick MultiMediaCard Secure Digital SmartMedia
<b>Dimensions</b>	20.21 x 6.45 x 15.2 inches (513.4 x 163.9 x 386 mm)
<b>Weight</b>	14.3 lb (6.5 kg)
<b>USB Support</b>	USB 2.0 Full speed (Windows 98, 2000 Professional, ME, XP Home and Professional, and Mac OS 9.x and OS X 10.1. USB cable must be no longer than 3 meters)

# index

## A

arrows **4, 11**

## B

Brightness button **4, 11**

buttons, control panel **4, 11**

## C

camera port **3**

camera-selected photos, print **15**

Cancel button **4, 11**

CompactFlash memory card slot **5**

computer. See Windows PC or Macintosh

control panel **4, 11**

Copies button **4, 11**

## D

diagnostic page **29**

digital cameras

print from memory cards **16**

print photos **15**

documentation **1**

## E

E-mail button **4, 11**

## H

HP Photosmart 7550 Basics Guide **1**

HP Photosmart 7550 Setup Guide **1**

HP Photosmart 7550 Software Setup & Product Support booklet **1**

HP Photosmart Printer Help **1**

## I

IBM Microdrive memory card slot **5**

icons **23**

icons, Windows taskbar **23**

IN tray **3, 6**

index page **20**

indicator lights **5, 12, 17**

ink level **29**

install print cartridges **9**

## L

lights, indicator **5, 12, 17**

load

paper in IN tray **6**

paper in photo tray **7**

## M

Macintosh

connection problems **28**

print from **25**

system requirements **53**

memory cards

card slots **5**

icon **23**

indicator light **5, 17**

inserting **17**

print from **16**

supported **16**

MemoryStick memory card slot **5**

Menu button **4, 11**

MultiMediaCard memory card slot **5**

## O

OK button **4, 11**

OUT tray **3**

## P

Page Setup dialog box (Macintosh) **25**

paper

guides **3**

load in IN tray **6**

load photo paper in photo tray **7**

overview **6**

photo tray

load photo paper **7**

slider **3**

photos

index page **20**

print camera-selected photos **15**

print from memory cards **16**

print from the control panel **20**

view **20**

Power button **4, 12**

power cord connection **2**

print

button **4, 12**

dialog box (Macintosh) **25**

dialog box (Windows PC) **21**

from Macintosh software applications **25**

from memory cards **16**

from the control panel **20**

from Windows PC software applications **21**

light **5**

photo index page **20**

print cartridges

ink level **29**

install and replace **9**

Reserve Mode **9**

printer

control panel **11**

diagrams of **2–5**

documentation **1**

icon **23**

problems **35–39**

use with computer. See Windows PC or Macintosh

printer Properties dialog box (Windows PC) **21**

printing problems **39–51**

## R

rear access door **2**

replace print cartridges **9**

Reserve Mode **9, 45**

Rotate button **4, 12**

## S

Save button **4, 12**

SecureDigital memory card slot **5**

side door **3**

Size button **4, 12**

SmartMedia memory card slot **5**

system requirements **53**

## T

taskbar icons **22, 23**

troubleshooting

Macintosh connection problems **28**

print a diagnostic page **29**

printer problems **35–39**

printing problems **39–51**

USB connection problems **30–35**

Windows connection problems **27**

## U

USB port **2, 30–35**

## W

Windows PC

connection problems **27**

print from **21**

system requirements **53**

taskbar icons **22**

## Z

Zoom button **4**









Printed on recycled paper  
Printed in U.S., 6/02



ENERGY STAR® is a U.S. registered mark.  
As an ENERGY STAR® partner,  
Hewlett-Packard Company has determined that this  
product meets the ENERGY STAR® guidelines for  
energy efficiency.



i n v e n t

[www.hp.com](http://www.hp.com)

©2002 Hewlett-Packard Company

Q1605-90188





## Free Manuals Download Website

<http://myh66.com>

<http://usermanuals.us>

<http://www.somanuals.com>

<http://www.4manuals.cc>

<http://www.manual-lib.com>

<http://www.404manual.com>

<http://www.luxmanual.com>

<http://aubethermostatmanual.com>

Golf course search by state

<http://golfingnear.com>

Email search by domain

<http://emailbydomain.com>

Auto manuals search

<http://auto.somanuals.com>

TV manuals search

<http://tv.somanuals.com>