

HP Photosmart D5060 series

Setup Guide / Guide de configuration / מדריך התקנה



Q8484-90002

EN FR HE



Attention Windows users: Wait to connect the USB cable (sold separately) until prompted during software installation.

Utilisateurs Windows : ne connectez pas le câble USB (vendu séparément) avant d'y être invité pendant l'installation du logiciel.

לתשומת לב משתמשי Windows: אל תחבר את כבל ה-USB (נמכר בנפרד), אלא כאשר תונחה לעשות זאת במהלך התקנת התוכנה.

1 Unpack your printer Déballez votre imprimante הוצא את המדפסת מהאריזה

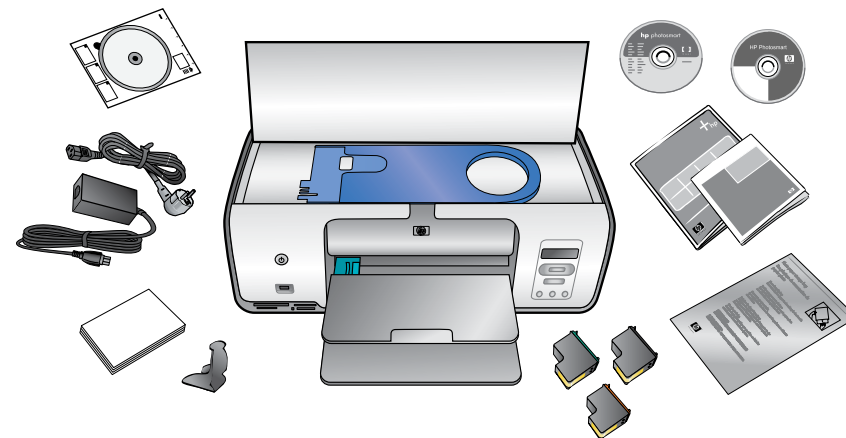

Remove packaging materials from inside and around the printer. **Peel the protective film off the screen.** Contents may vary by country/region.

Retirez les différents éléments d'emballage situés à l'intérieur et autour de l'imprimante. **Ôtez la pellicule de protection de l'écran.** Le contenu de l'emballage peut varier en fonction du pays/de la région.

הסר את חומרי האריזה שבתוך המדפסת ומסביבה. **קלף את הסרט המגן מהמסך.** תכולת האריזה עשויה להשתנות בהתאם למדינה/אזור.

2 Unfold the paper trays Dépliez les bacs papier פתח את מגשי הנייר

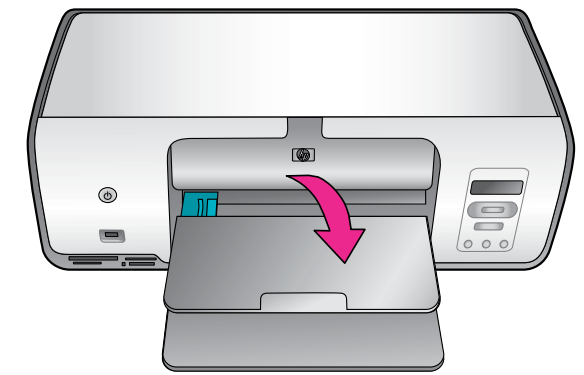
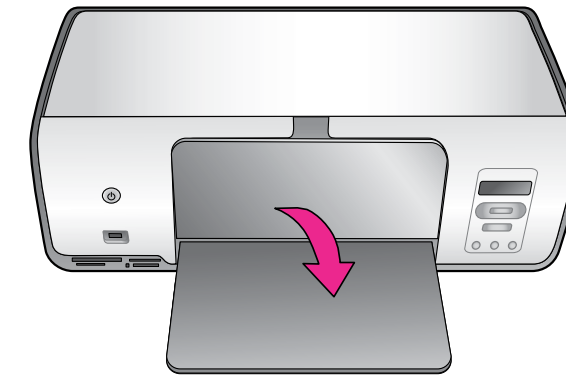

3 Connect the power cord only Branchez uniquement le câble d'alimentation

חבר את כבל המתח בלבד

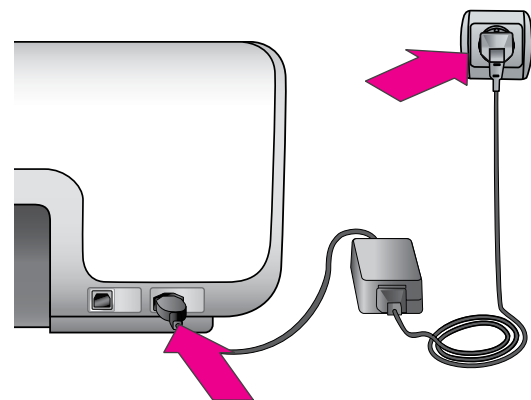

4 Load plain paper Chargez du papier ordinaire

טען נייר רגיל

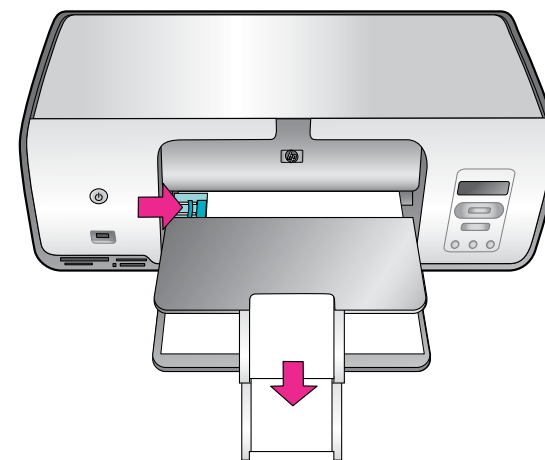
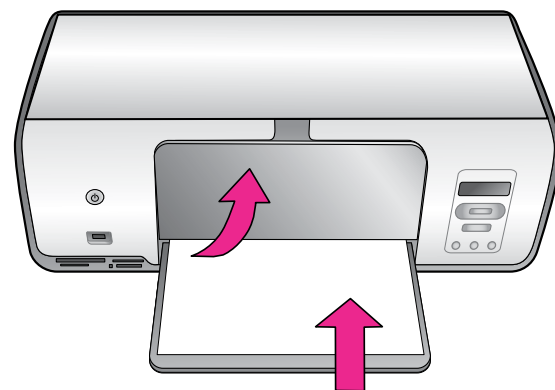

For more information about loading photo paper in the cassette, see the Basics Guide.

Pour plus d'informations sur le chargement du papier photo dans la cassette, reportez-vous au Guide d'utilisation.

לקבלת מידע נוסף על טעינת נייר צילום במגש, עיין במדריך הבסיסי.

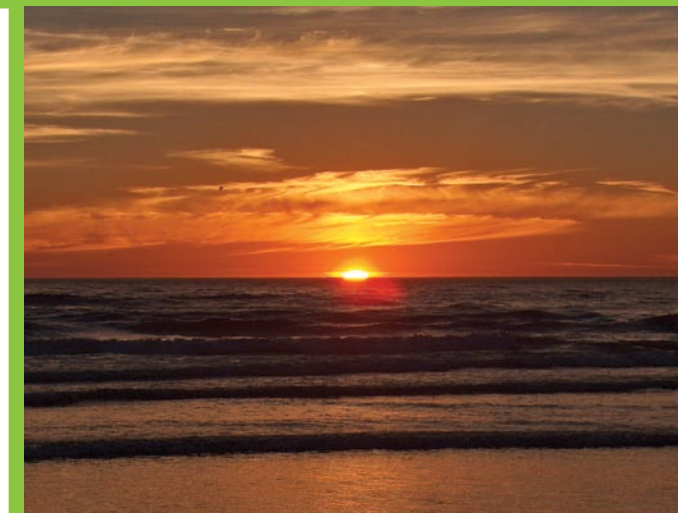



5 Install the print cartridges

Installez les cartouches d'encre

התקן את מחסניות ההדפסה



Do not touch the ink nozzles or the copper-colored contacts!

Ne touchez ni les buses d'encre, ni les contacts cuivrés.

אל תיגע בחריצי הדיו או במגעי הנחושת!

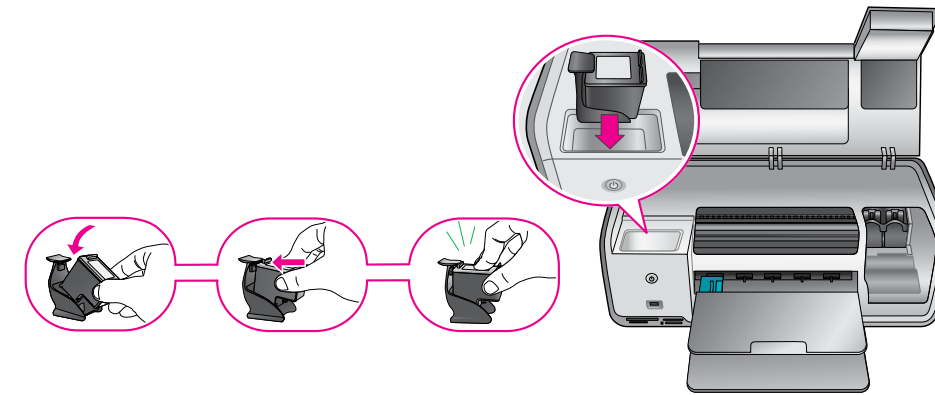
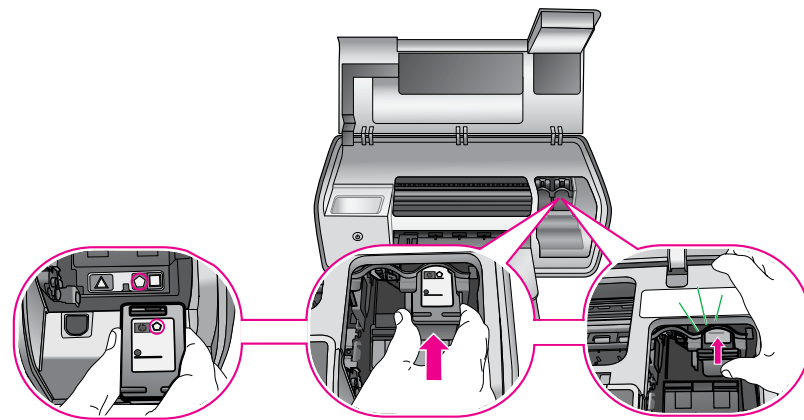
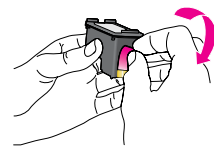

Store an optional print cartridge in the protector and keep it in the storage area when not in use.
Stockez une cartouche d'impression en option dans le dispositif de protection et conservez-la dans la zone de stockage lorsque vous ne l'utilisez pas.

אחסן את מחסנית ההדפסה האופציונלית בתוך המגן, והשאר אותה באזור האחסון כאשר אינה בשימוש.

6 Insert the CD in the computer, then click the installation icon to install the HP Photosmart software

Insérez le CD-ROM dans le lecteur de l'ordinateur, puis cliquez sur l'icône d'installation du logiciel HP Photosmart

הכנס את התקליטור למחשב ולחץ על סמל ההתקנה כדי להתקין את תוכנת HP Photosmart

Windows PC

Windows® 98, Me, 2000 Professional, XP Home, XP Professional



1

USB connection
Connexion USB
חיבור USB



2



3



4

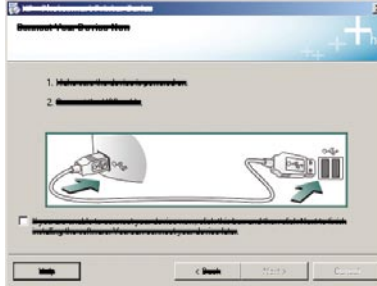

5

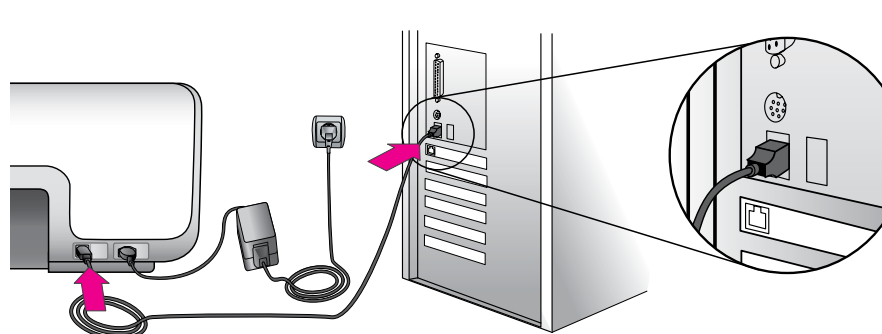

USB connection
Connexion USB
חיבור USB

Macintosh

Macintosh OS X v10.3, 10.4+

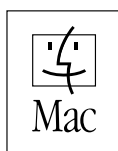

1

USB connection
Connexion USB
חיבור USB

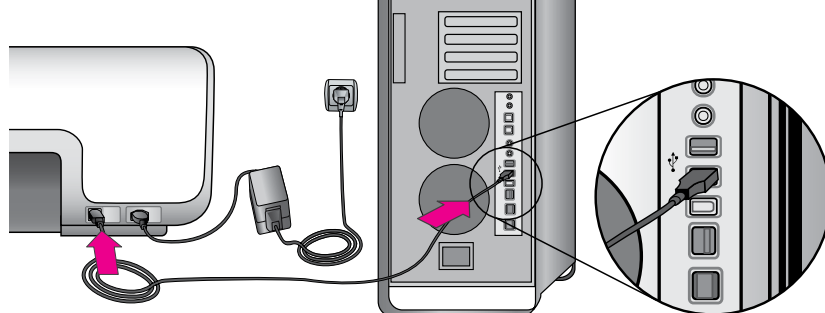

2

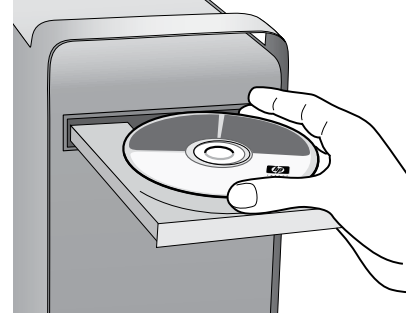

3



4



Need more information? Plus d'informations ? זקוק למידע נוסף?

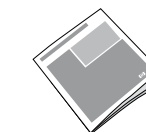

Basics Guide
Guide d'utilisation
מדריך בסיסי



Onscreen Printer Help
Aide en ligne de l'imprimante
עזרה על-המסך של המדפסת



User Guide on CD
Guide de l'utilisateur sur CD-ROM
מדריך למשתמש בתקליטור



www.hp.com/support

Printed in Germany 07/06 v1.0.0
Imprimé en Allemagne 07/06 v1.0.0

© 2006 Hewlett-Packard Development Company, L.P.

Free Manuals Download Website

<http://myh66.com>

<http://usermanuals.us>

<http://www.somanuals.com>

<http://www.4manuals.cc>

<http://www.manual-lib.com>

<http://www.404manual.com>

<http://www.luxmanual.com>

<http://aubethermostatmanual.com>

Golf course search by state

<http://golfingnear.com>

Email search by domain

<http://emailbydomain.com>

Auto manuals search

<http://auto.somanuals.com>

TV manuals search

<http://tv.somanuals.com>