

Model Number and Description

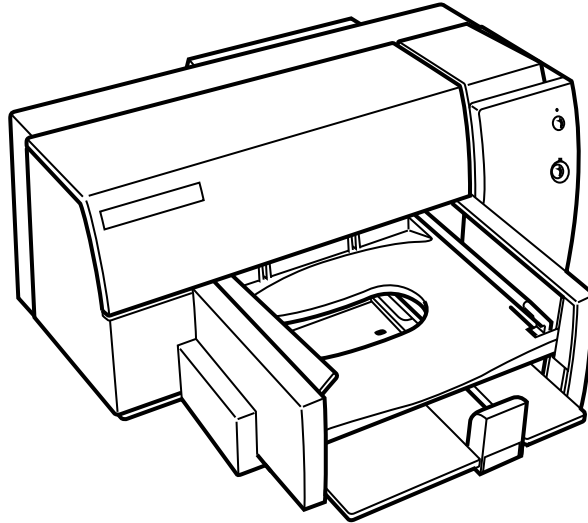

2162607

HP DeskJet 600 Printer

Printer Name	Model Number	Status	Description
HP DeskJet 600	C2184A	Available	Fast personal printer for DOS computers with optional color.

Front View

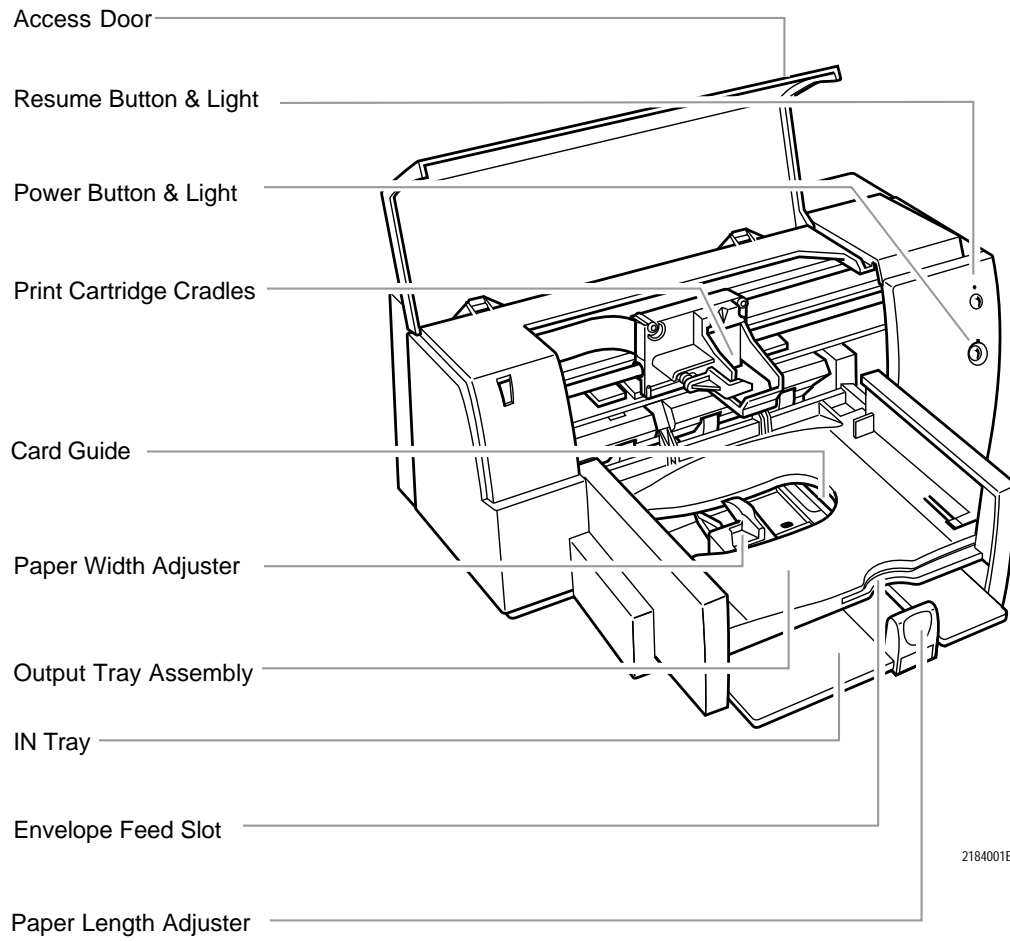

Rear View

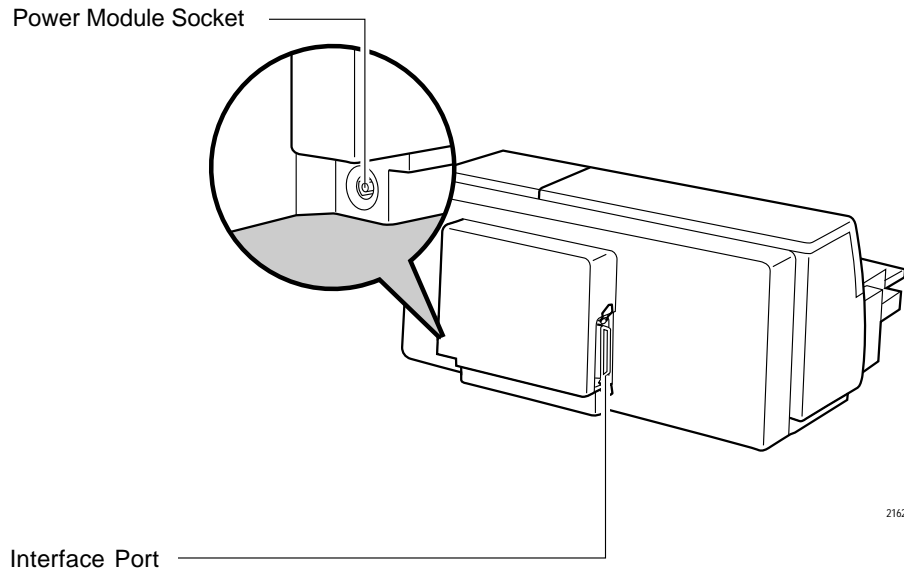

Ordering Printer Options

Printer Number and Language of Kits

Region or Country	Printer Option Number	Language of Documentation and Printer Software
Argentina	C2184A AC8	Spanish
Asia, North	C2184A ART	English
Asia, Pacific	C2184A ARS	English
Australia	C2184A ABG	English
Brazil	C2184A AC4	Portuguese
Brazil-2	C2184A A1Z	Portuguese
Canada (French)	C2184A ABC	French
Caribbean	C2184A ARV	English
Caribbean	C2184A ARV	English
Chinese	C2184A AB2	Simplified Chinese/English
Czechoslovakia	C2184A AKB	Czechoslovakian
Denmark	C2184A ABY	Danish
Europe (Dutch)	C2184A ACU	Dutch
Europe (English)	C2184A ABB	English
Europe (French)	C2184A ACS	French
Europe (German)	C2184A ACT	German
Europe (Italian)	C2184A ARP	Italian
Finland	C2184A ABX	Finnish
Greece	C2184A AB7	Greek/English
Hong Kong	C2184A AB5	English
Hungary	C2184A AKC	Hungarian
India	C2184A ACJ	English
Israel	C2184A AKJ	English
Jordan	C2184A ARW	Arabic/English
Latin America	C2184A ABM	Spanish
Latvia	C2184A A2J	English
Lithuania	C2184A A2H	English
Middle East	C2184A ARU	Arabic/English
Norway	C2184A ABN	Norwegian
Peoples Republic of China	C2184A AB2	Chinese/English
Poland	C2184A AKD	Polish

Continued on next page

Printer Number and Language of Kits (Cont.)

Region or Country	Printer Option Number	Language of Documentation and Printer Software
Portugal	C2184A AB9	Portuguese
Russia	C2184A AR3	English
Russia	C2184A ACB	Russian/English
Saudi Arabia	C2184A ARG	Arabic/English
Singapore	C2184A AB4	English
South Africa	C2184A ACQ	English
South America	C2184A AKV	Spanish
Spain	C2184A ABE	Spanish
Sweden	C2184A ABS	Sweden
Taiwan	C2184A AB0	Taiwanese
Thailand	C2184A AB3	Thailand/English
Turkey	C2184A AB8	Turkish/English
U.K.	C2184A ABU	English
U.S.	C2184A ABA	English

Power Cord, Documentation, and Software Kits

Region or Country	Power Module	User's Documentation Kit	Printer Software Kit
Argentina	9100-5129	C2184-60218	C2184-60239
Asia, North	9100-5346	C2184-60201	C2184-60227
Asia, Pacific	9100-5131	C2184-60201	C2184-60227
Australia	9100-5127	C2184-60201	C2184-60227
Brazil	9100-5124	C2184-60216	C2184-60238
Brazil-2	9100-5346	C2184-60216	C2184-60238
Canada (French)	9100-5124	C2184-60208	C2184-60232
Caribbean	9100-5346	C2184-60200	C2184-60225
Czechoslovakia	9100-5132	C2184-60204	C2184-60228
Denmark	9100-5132	C2184-60205	C2184-60229
Europe (Dutch)	9100-5132	C2184-60206	C2184-60230
Europe (English)	9100-5132	C2184-60202	C2184-60227
Europe (French)	9100-5132	C2184-60208	C2184-60232
Europe (German)	9100-5132	C2184-60209	C2184-60233
Europe (Italian)	9100-5132	C2184-60212	C2184-60235
Finland	9100-5132	C2184-60207	C2184-60231
Greece	9100-5132	C2184-60210	C2184-60226
Hong Kong	9100-5346	C2184-60201	C2184-60227
Hungary	9100-5132	C2184-60211	
India	9100-5128	C2184-60201	C2184-60227
Israel	9100-5132	C2184-60202	C2184-60226
Jordan	9100-5132	C2184-60203	C2184-60226
Latin America	9100-5124	C2184-60218	C2184-60239
Latvia	9100-5132	C2184-60202	C2184-60226
Lithuania	9100-5132	C2184-60202	C2184-60226
Middle East	9100-5131	C2184-60203	C2184-60226
Norway	9100-5132	C2184-60214	C2184-60236
People's Republic of China	9100-5129	C2184-60222	C2184-60227
Poland	9100-5132	C2184-60215	C2184-60237
Portugal	9100-5132	C2184-60216	C2184-60238

Continued on next page

Power Cord, Documentation, and Software Kits (Cont.)

Region or Country	Power Module	User's Documentation Kit	Printer Software Kit
Russia1	9100-5132	C2184-60202	C2184-60226
Russia2	9100-5132	C2184-60217	C2184-60226
Saudi Arabia	9100-5124	C2184-60203	C2184-60226
Singapore	9100-5131	C2184-60201	C2184-60227
South Africa	9100-5128	C2184-60202	C2184-60227
South America	9100-5346	C2184-60218	C2184-60239
Spain	9100-5132	C2184-60218	C2184-60239
Sweden	9100-5132	C2184-60219	C2184-60240
Taiwan	9100-5124	C2184-60220	C2164-60242
Thailand	9100-5346	C2184-60223	C2164-60226
Turkey	9100-5132	C2184-60221	C2184-60227
U.K.	9100-5131	C2184-60202	C2184-60227
U.S.	9100-5124	C2184-60200	C2184-60225

Items Included

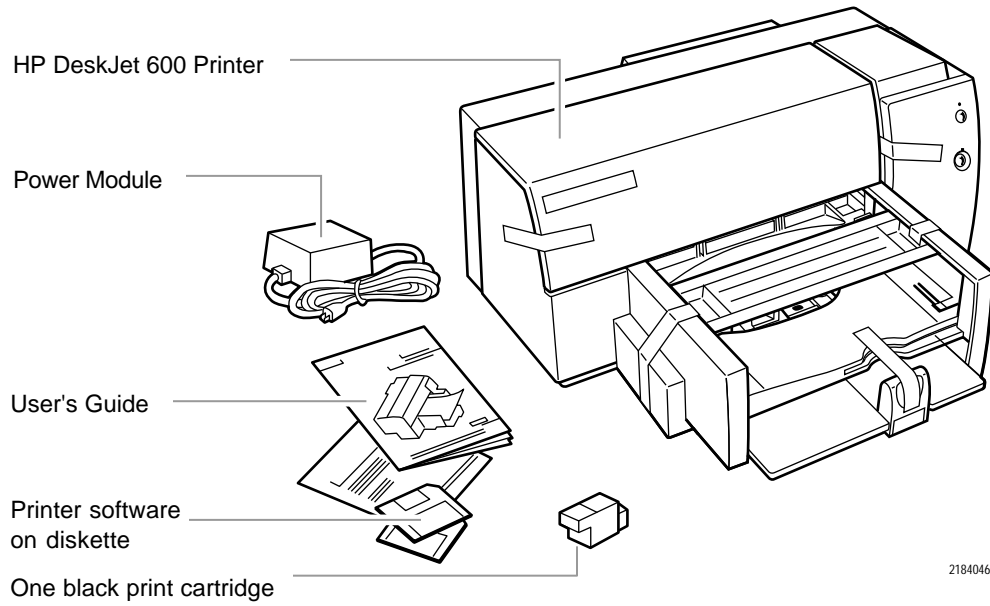

Fonts Included

CG Times
CG Times Bold
CG Times Italic
CG Times Bold Italic
Letter Gothic
Letter Gothic Bold
Letter Gothic Italic
Letter Gothic Bold Italic

Univers
Univers Bold
Univers Italic
Univers Bold Italic
Courier
Courier Bold
Courier Italic
Courier Bold Italic

2145806

Scalable TrueType® Fonts For MS Windows

Arial® Black
PL Benguiat Frisky
GILL SANS® SHADOW
CG Goudy Old Style
CG Goudy Old Style Bold
CG Goudy Old Style Italic
Graphite Light

Graphite Light Narrow
Lucida® Casual
Lucida® Casual Italic
Milestones™ ← 🚲 🏀 🍷
Phyllis
CG Poster Bodoni
Signet Roundhand

2145804

Internal Fonts and Symbol Sets

Symbol Sets

- PC-8
- PC-8 Turkish
- French (69)
- Spanish (17)
- PC-852
- Latin 2 (8859/2)
- Danish/Norwegian (60)
- ANSI/ASCII (06)
- German (21)
- Swedish (11)
- ECMA-94 Latin 1 (8859/1)
- Latin 5 (8859/9)
- PC-8 Danish/Norwegian
- United Kingdom (04)
- Italian (15)
- PC-850
- Legal

Additional Fonts in Region Specific Printers

Some HP DeskJet 600 printers contain flash memory. Flash memory provides the capability to install fonts and symbol sets for specific regions. The following figure shows how to identify printers with flash memory by observing the serial number label on the back of the printer.

Identifying Printers with Flash Memory

With Flash Memory



2145892

No Flash Memory

To identify a printer with flash memory, look for the lightning bolt symbol on the serial number label located on the back of the printer. The flash font code found directly below the lightning bolt can be used to identify the language of fonts downloaded into flash memory. Use the following tables to identify the fonts and symbol set(s) loaded into flash memory.

Flash Fonts Information

Fonts and Symbol Sets for Flash Codes

Flash Codes	Name of Font and Symbol Set	Country/Region	Printer Model
THA	Thai	Thailand	C2184A AB3

Flash Fonts and Symbol Sets

Thai (Flash Font Code THA)

Spacing	Font Name	Point Sizes	Pitches
Fixed	Thai Courier	10	12
		12	10
		24	6
	Thai Courier Bold	10	12
		12	10
		24	6
	Thai Courier Italic	10	12
		12	10
		24	6
	Thai Courier Bold Italic	12	10
	Thai Line Printer	8.5	16

Symbol Set: TIS (TAPIC23)

Note TAPIC23 is the registration name for Hewlett-Packard's Thai HP DeskJet symbol set.

Part Numbers

Item	Description	Part Number
Color Kits ¹	Contains color print cartridge and storage garage. The color print cartridge replaces the black cartridge to allow color printing.	
	U.S.	C4533A
	Europe	C4534A
	Asia	C4535A
	Japan, Inter-America	C4536A
Interface Cables	HP IEEE-1284 Parallel Interface Cable (2 meter length)	C2950A
	HP IEEE-1284 Parallel Interface Cable (3 meter length)	C2951A
	HP Centronics Parallel Interface Cable	C2912B or HP24542D
Print Cartridges	Black Inkjet Print Cartridge	51629A
	Color Inkjet Print Cartridge	51649A
Media	Premium Transparency Film (U.S. letter, 50 sheets)	C3834A
	Premium Transparency Film (U.S. letter, 20 sheets)	C3828A
	Premium Transparency Film (European A4, 50 sheets)	C3835A
	Premium Transparency Film (European A4, 20 sheets)	C3832A
	Premium Glossy Paper (U.S. letter, 50 sheets)	C3836A
	Premium Glossy Paper (U.S. letter, 10 sheets)	C3833A
	Premium Glossy Paper (European A4, 50 sheets)	C3837A
	Premium Glossy Paper (European A4, 10 sheets)	C3831A
	Premium InkJet Paper (U.S. letter, 200 sheets)	51634Y
Premium InkJet Paper (European A4, 200 sheets)	51634Z	

1. For color kit information, see "Color Kit Information."

Color Kit Information

Color Kit

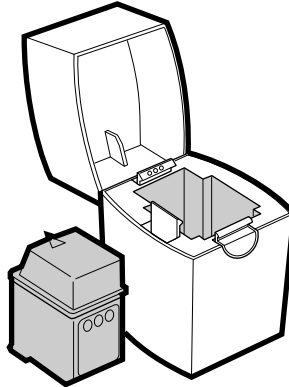

2162615

The optional Color Kit which includes a color print cartridge and a print cartridge storage container, provides color output printing capability from an HP DeskJet 600 printer. The printer comes from the factory as color capable, it does not require any modifications. Color features, however, need to be turned on in the printer driver dialog box in MS Windows. For more information, refer to the HP DeskJet 600 printer user documentation or to the information included with the Color Kit.

Notes

The print cartridge storage container will hold one black or one color print cartridge. To obtain maximum print quality and print cartridge life, always store the open print cartridge that is not in the printer in the print cartridge storage container.

When printing a color page with the color print cartridge, you cannot print true black. The printer will print composite black, made up of cyan, magenta, and yellow inks.

User Replaceable Components

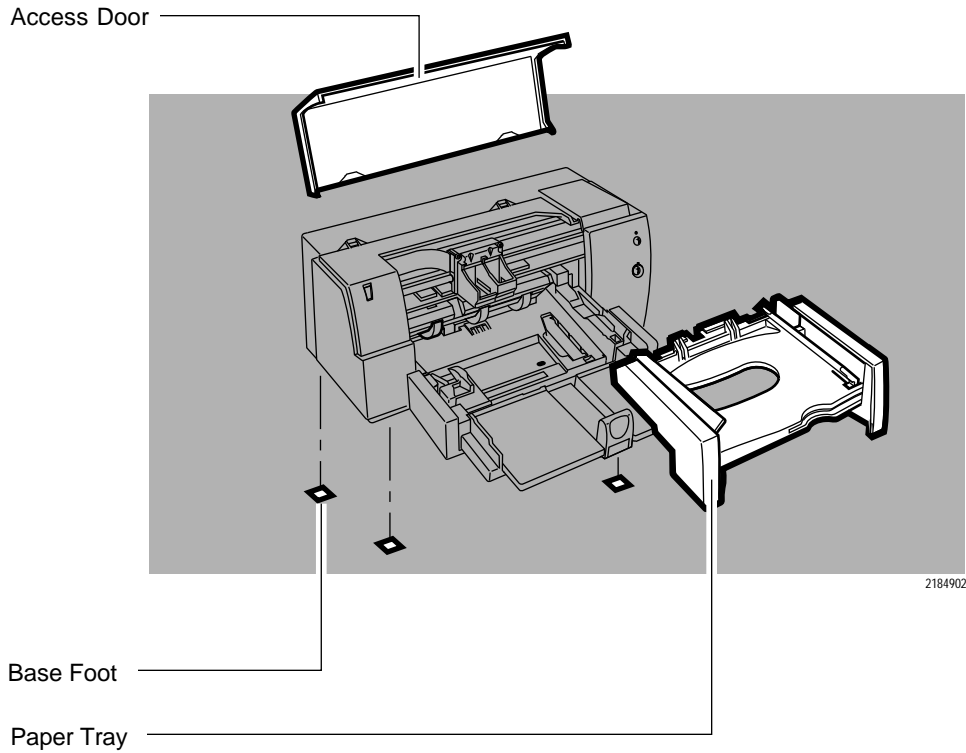

Description	Part Number
Access Door (Top Cover) Assembly	C2164-67816
Base Foot Assembly	C2162-60098
Paper Tray Assembly	C2164-67807

Host/System Requirements

MS Windows

- MS Windows 3.1 or later
- 80386 or faster processor
- At least 2 MB of RAM to print in black or at least 4 MB of RAM to print in color
- At least 10 MB free hard disk space

DOS

- DOS, Version 3.3 or later
- 80286 or faster processor
- At least 2 MB of RAM to print in black or at least 4 MB of RAM to print in color

Driver Installation

For the printer to operate properly, a printer driver must be installed in your computer. Refer to “Printer Driver Information/Installing the Printer Driver” for more detailed information.

Interface Specifications

Category	Specification
Interface	IEEE-1284 Compatible
Communication Modes Available	Compatible (Centronics) Nibble ECP
Built-In RAM	512 Kbytes
Receive Buffer	32 Kbytes

Note For a complete description of your printer's interface, see "Printer Interface Information."

Product Performance Specifications

The HP DeskJet 600 prints a 600x300 dot size. Dots are placed on a 600x300 grid. Depletion is used to remove approximately 10% of the dots to prevent laying too much ink on the page.

In the Best mode, the paper advances at 600 DPI increments and places dots on a true 600x600 grid. Depletion in the Best mode removes approximately 43% of the dots.

To conserve memory, DOS fonts are stored at 300x300. REt is used to convert them to 600x300.

When printing from MS Windows, resolution determinations are made in the PC and then sent to the printer.

MS Windows Print Speed

	EconoFast Mode	Normal Mode	Best Mode
Black Print Speed ¹	4 pages per minute	2.5 pages per minute	1 page per minute
Color Print Speed ¹	1.0 minutes per page	2.0 minutes per page	4 minutes per page

1. Approximate figures. Exact speed will vary depending upon the system configuration, software program, and document complexity.

MS DOS Print Speed (Black Mechanism)

	EconoFast Mode	Normal Mode
Black Print Speed ¹	270 CPS at 10 CPI	134 CPS at 10 CPI

1. Approximate figures. Exact speed will vary depending upon the system configuration, software program, and document complexity.

Resolution

	EconoFast Mode	Normal Mode	Best Mode
Black Resolution			
MS Windows (text and graphics)	300 x 300 DPI	600 x 300 DPI	600 x 600 DPI
DOS (text only)	300 x 300 DPI	600 x 300 DPI	600 x 600 DPI
Color Resolution			
Plain & Premium Papers	300 x 300 DPI	300 x 300 DPI	300 x 300 DPI
Glossy Paper and Transparency Film (black and color)	N/A	600 x 300 DPI	600 x 300 DPI
DOS (graphics)	Full-page 75, 150, 300 DPI	Full-page 75, 150, 300 DPI	Full-page 75, 150, 300 DPI

Note

DPI is measured in addressable raster points per inch.

Paper Handling Specifications

Category	Specification
Paper Grain	Long Grain Only
Paper	60 to 135 g/m ² (16 to 36 lb.)
Envelopes	75 to 90 g/m ² (20 to 24 lb.)
Cards	110 to 200 g/m ² (29 to 53 lb., 61 to 110 lb. index max.; 8.5 pt max thickness)
Labels ²	Up to 25 Sheets of Avery Paper Labels
IN Tray Capacity	Up to 100 Sheets (<1/2 in.)
OUT Tray Capacity	Up to 50 Sheets
Multiple Envelopes ¹	Up to 20 Envelopes (<1/2 in.)
Card Capacity	Up to 30 Cards

1. Envelope capacity is dependent upon the manufacturer, the type of envelope and its construction.
2. Use only U.S. letter or A4 size sheets. Use only Avery paper labels specifically designed for use with HP InkJet Printers.

Note

The HP DeskJet 600 Printer works well with most types of paper although variables in paper composition may affect print quality and paper handling. Bond paper, such as letterhead, gives excellent quality. Paper should be tested to ensure best performance.

Supported Media/Sizes

Category	Specification
US Letter	215.9 x 279.4 mm (8.5 x 11 in.)
US Legal	215.9 x 355.6 mm (8.5 x 14 in.)
U.S. Executive	184.1 x 266.7 mm (7.25 x 10.5 in.)
ISO & JIS A4	210 x 297 mm (8.27 x 11.69 in.)
ISO & JIS A5	148.5 x 210 mm (5.83 x 8.27 in.)
ISO & JIS B5	182 x 257 mm (7.17 x 10.12 in.)
U.S. No. 10 Envelope ¹	104.7 x 241.3 mm (4.12 x 9.5 in.)
U.S. A2 Envelope (5.5)	111 x 146 mm (4.375 x 5.75 in.)
European DL Envelope ¹	110 x 220 mm (4.33 x 8.66 in.)
European C6 Envelope ¹	114 x 162 mm (4.49 x 6.38 in.)
U.S. 4 x 6 Card	101.6 x 152.4 mm (4 x 6 in.)
U.S. 5 x 8 Card	127 x 203.2 mm (5 x 8 in.)
European A6 Card	105 x 148.5 mm (4.13 x 5.83 in.)
Japanese Hagaki Postcard	100 x 148 mm (3.94 x 5.83 in.)
Custom Size (user defined)	
Width	127 to 216 mm (5 to 8.5 in.)
Length	148 to 356 mm (5.83 to 14 in.)

1. To minimize print skew, use envelopes with rectangular flaps rather than triangular flaps.

Printable Area Specifications

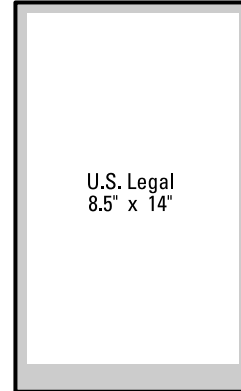
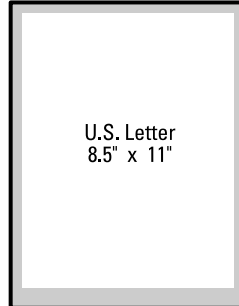
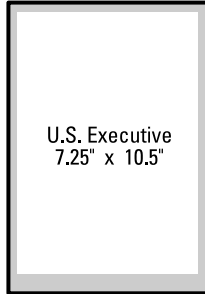

2162985

U.S. Paper and Transparency

DOS Black Printing

Page Size	Top Margin	Bottom Margin	Left and Right Margins	Printable Area
U.S. Executive 184.1 x 266.7 mm (7.25 x 10.5 in.)	0.0 mm (0.0 in.)	11.7 mm (0.46 in.)	6.3 mm (0.25 in.)	171.5 mm x 255.0 mm (6.75 x 10.04 in.)
U.S. Letter 215.9 x 279.4 mm (8.5 x 11 in.)	0.0 mm (0.0 in.)	11.7 mm (0.46 in.)	6.3 mm (0.25 in.)	203.2 mm x 267.7 mm (8.00 x 10.54 in.)
U.S. Legal 215.9 x 355.6 mm (8.5 x 14 in.)	0.0 mm (0.0 in.)	11.7 mm (0.46 in.)	6.3 mm (0.25 in.)	203.2 mm x 343.9 mm (8.00 x 13.54 in.)

DOS Color Printing

Page Size	Top Margin	Bottom Margin	Left and Right Margins	Printable Area
U.S. Executive 184.1 x 266.7 mm (7.25 x 10.5 in.)	0.0 mm (0.0 in.)	14.9 mm (0.59 in.)	6.3 mm (0.25 in.)	171.5 mm x 251.7 mm (6.75 x 10.04 in.)
U.S. Letter 215.9 x 279.4 mm (8.5 x 11 in.)	0.0 mm (0.0 in.)	14.9 mm (0.59 in.)	6.3 mm (0.25 in.)	203.2 mm x 264.4 mm (8.00 x 10.41 in.)
U.S. Legal 215.9 x 355.6 mm (8.5 x 14 in.)	0.0 mm (0.0 in.)	14.9 mm (0.59 in.)	6.3 mm (0.25 in.)	203.2 mm x 340.6 mm (8.00 x 13.41 in.)

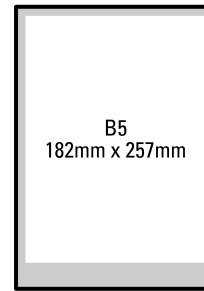
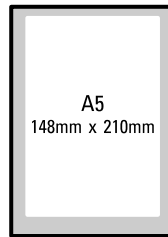
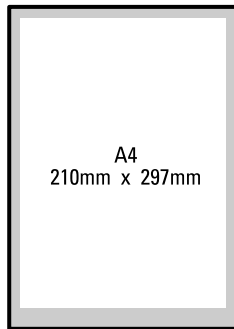

2162987

International Paper and Transparency

DOS Black Printing

Page Size	Top Margin	Bottom Margin	Left and Right Margins	Printable Area
International A4 210 x 297 mm (8.27 x 11.69 in.)	0.0 mm (0.0 in.)	11.7 mm (0.46 in.)	3.2 mm (0.13 in.)	203.2 mm x 285.3 mm (8.00 x 11.23 in.)
International A5 148.5 x 210 mm (6.00 x 8.27 in.)	0.0 mm (0.0 in.)	18.0 mm (0.71 in.)	3.2 mm (0.13 in.)	141.6 mm x 192.0 mm (5.58 x 7.56 in.)
International B5 182 x 257 mm (7.17 x 10.12 in.)	0.0 mm (0.0 in.)	11.7 mm (0.46 in.)	4.2 mm (0.17 in.)	173.6 mm x 245.4 mm (6.83 x 9.66 in.)

DOS Color Printing

Page Size	Top Margin	Bottom Margin	Left and Right Margins	Printable Area
International A4 210 x 297 mm (8.27 x 11.69 in.)	0.0 mm (0.0 in.)	14.9 mm (0.59 in.)	3.2 mm (0.13 in.)	203.2 mm x 282.0 mm (8.00 x 11.10 in.)
International A5 148.5 x 210 mm (6.00 x 8.27 in.)	0.0 mm (0.0 in.)	21.3 mm (0.84 in.)	3.2 mm (0.13 in.)	141.6 mm x 188.7 mm (5.58 x 7.43 in.)
International B5 182 x 257 mm (7.17 x 10.12 in.)	0.0 mm (0.0 in.)	14.9 mm (0.59 in.)	4.2 mm (0.17 in.)	173.6 mm x 242.1 mm (6.83 x 9.53 in.)

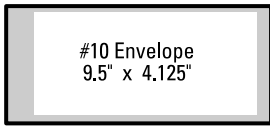

2162986

Envelopes

DOS Black Printing

Envelope Size	Top & Bottom Margins	Left Margin	Right Margin	Printable Area
U.S. #10 Envelope				
104.7 x 241.3 mm (4.12 x 9.5 in.)	3.2 mm (0.13 in.)	18.0 mm (0.71 in.)	0.0 mm (0.0 in.)	98.4 mm x 223.3 mm (3.88 x 8.79 in.)
International DL				
110 x 220 mm (4.33 x 8.66 in.)	3.2 mm (0.13 in.)	18.0 mm (0.71 in.)	0.0 mm (0.0 in.)	103.6 mm x 201.9 mm (4.08 x 7.95 in.)
International C6				
114 x 162 mm (4.49 x 6.38 in.)	3.2 mm (0.13 in.)	18.0 mm (0.71 in.)	0.0 mm (0.0 in.)	107.6 mm x 144.0 mm (4.24 x 5.67 in.)

DOS Color Printing

Envelope Size	Top & Bottom Margins	Left Margin	Right Margin	Printable Area
U.S. #10 Envelope				
104.7 x 241.3 mm (4.12 x 9.5 in.)	3.2 mm (0.13 in.)	21.3 mm (0.84 in.)	0.0 mm (0.0 in.)	98.4 mm x 220.0 mm (3.88 x 8.66 in.)
International DL				
110 x 220 mm (4.33 x 8.66 in.)	3.2 mm (0.13 in.)	21.3 mm (0.84 in.)	0.0 mm (0.0 in.)	103.6 mm x 198.6 mm (4.08 x 7.82 in.)
International C6				
114 x 162 mm (4.49 x 6.38 in.)	3.2 mm (0.13 in.)	21.3 mm (0.84 in.)	0.0 mm (0.0 in.)	107.6 mm x 140.7mm (4.24 x 5.54 in.)

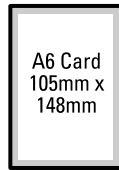
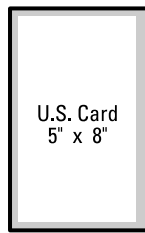
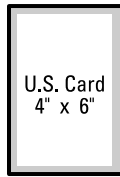

2162988

Cards

DOS Black Printing

Card Size	Top Margin	Bottom Margin	Left and Right Margins	Printable Area
U.S. 4 x 6 101.6 x 152.4 mm (4 x 6 in.)	0.0 mm (0.0 in.)	18.0 mm (0.71 in.)	3.2 mm (0.13 in.)	95.2 x 134.4 mm (3.75 x 5.29 in.)
U.S. 5 x 8 127 x 203.2 mm (5 x 8 in.)	0.0 mm (0.0 in.)	18.0 mm (0.71 in.)	3.2 mm (0.13 in.)	120.6 x 185.2 mm (4.75 x 7.29 in.)
International A6 105 mm x 148.5 mm (4.13 x 6.00 in.)	0.0 mm (0.0 in.)	18.0 mm (0.71 in.)	3.2 mm (0.13 in.)	98.6 mm x 130.0 mm (3.88 x 5.12 in.)
Japanese Hagaki Postcard 100 mm x 148 mm (3.94 x 5.83 in.)	0.0 mm (0.0 in.)	18.0 mm (0.71 in.)	4.2 mm (0.17 in.)	91.6 mm x 130.0 mm (3.60 x 5.12 in.)

DOS Color Printing

Card Size	Top Margin	Bottom Margin	Left and Right Margins	Printable Area
U.S. 4 x 6 101.6 x 152.4 mm (4 x 6 in.)	0.0 mm (0.0 in.)	21.3 mm (0.84 in.)	3.2 mm (0.13 in.)	95.2 x 131.6 mm (3.75 x 5.16 in.)
U.S. 5 x 8 127 x 203.2 mm (5 x 8 in.)	0.0 mm (0.0 in.)	21.3 mm (0.84 in.)	3.2 mm (0.13 in.)	120.6 x 181.9 mm (4.75 x 7.16 in.)
International A6 105 mm x 148.5 mm (4.13 x 6.00 in.)	0.0 mm (0.0 in.)	21.3 mm (0.84 in.)	3.2 mm (0.13 in.)	98.6 mm x 126.7 mm (3.88 x 4.99 in.)
Japanese Hagaki Postcard 100 mm x 148 mm (3.94 x 5.83 in.)	0.0 mm (0.0 in.)	21.3 mm (0.84 in.)	4.2 mm (0.17 in.)	91.6 mm x 130.0 mm (3.60 x 4.99 in.)

Physical Specifications

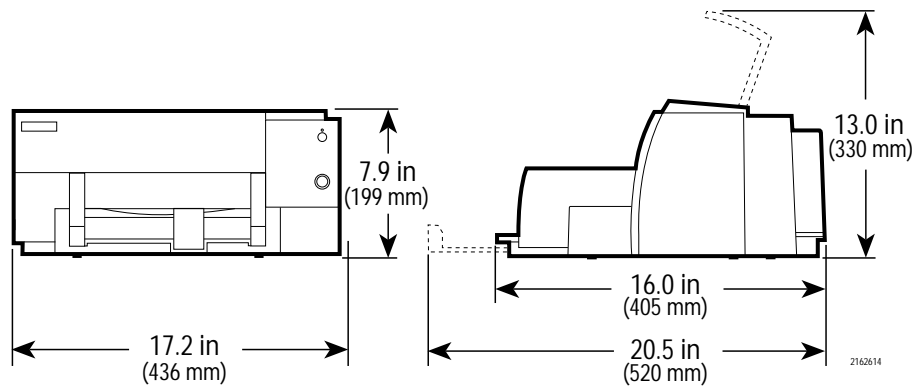

Weight: 5.3 Kg (11.6 lb.)

Electrical Specifications

Category	Specification
Input Voltage ¹	100 VAC, 120 VAC, 127 VAC, 220 VAC, 230 VAC, or 240 VAC ($\pm 10\%$)
Frequency	
100 VAC	50/60 Hz (± 3 Hz)
120 VAC	60 Hz (± 3 Hz)
127 VAC	60 Hz (± 3 Hz)
220 VAC	50 Hz (± 3 Hz)
230 VAC	50 Hz (± 3 Hz)
240 VAC	50 Hz (± 3 Hz)
Maximum Power Consumption	
Powered Off (plugged in)	2 Watts
Powered On (non-printing)	4.5 Watts
Powered On (Printing state)	12 Watts

1. Power modules are available for each listed input voltage.

Environmental Specifications

Category	Specification		
Temperature			
Operating	5 to 40° C (41 to 104° F)		
Non-Operating (storage)	-40 to 60° C (-40 to 140° F)		
Relative Humidity	10 to 80% RH non-condensing		
Recommended Operating Conditions for Best Print Quality	15 to 35° C (59 to 95° F), 20 to 80% RH non-condensing		
Noise Levels per ISO 9296	Best Mode	Normal Mode	EconoFast Mode
Sound Power, L_{wAd}	6.0 B(A)	6.3 B(A)	6.5 B(A)
Sound Pressure, L_{pAm}^1	46 dB(A)	50 dB(A)	51 dB(A)

1. Bystander positions.

Safety and EMI Specifications

Category	Specification
Safety Certifications Power Module	UL, CSA, TUV, SEMKO, NEMKO, SEV, SECV, FIMKO, DEMKO, NOM
Printer with Power Module	UL, CSA, TUV, ETL
EMI Certifications Printer with Power Module	FCC Class B, when used with a Class B computing device (USA), EMC Directive 89/336/EEC (European Community), VCCI (Japan), SABS (South Africa)

Reliability Specifications

Category	Specification
Mechanism Life	60,000 pages
Mean Time Between Failures (MTBF)	20,000 hours
Printer Usage Rate	
Power On Per Year	2,000 hours
Printed Pages Per Year	12,000 pages
Black Pages Per Month	1,000 pages total maximum
Color Pages Per Month	160 pages total maximum

Packaging Specifications

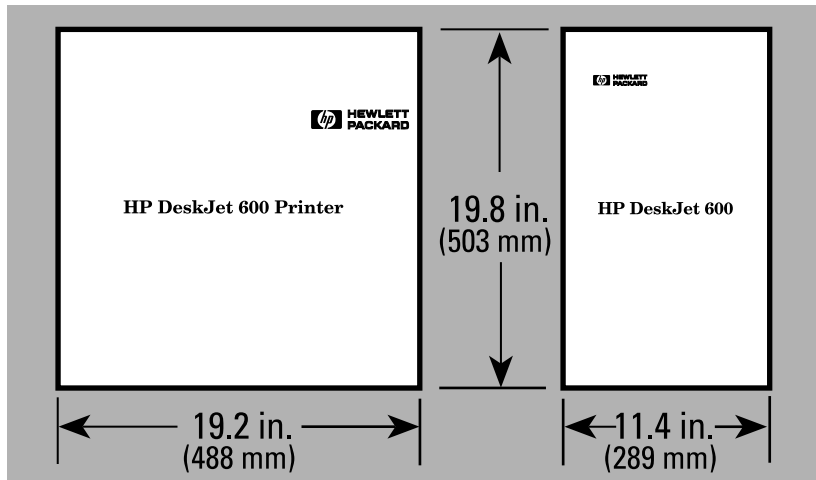

2184900

Weight = 8.137 kg (17.94 lb.)

Refilling Policy

Caution The ink in the print cartridges has been carefully formulated by Hewlett-Packard to ensure superior print quality and compatibility with the printer. Damage to the printer resulting from modifying the print cartridge is not the responsibility of Hewlett-Packard.

Hewlett-Packard does not support the refilling of print cartridges. Hewlett-Packard cannot guarantee the print quality from refilled print cartridges. *Attempting to refill the high-capacity print cartridge may cause a sudden loss of ink from the print cartridge.* Printer damage caused by refilling high-capacity black ink or color ink print cartridges is not covered by the Hewlett-Packard warranty or customer service agreements.

Part Numbers

Item	Part Number	Description
Print Cartridges	51649A ¹	Color Inkjet Print Cartridge (Cyan, Magenta, and Yellow Inks)
	51629A	High Capacity Inkjet Print Cartridge (Black)
Color Kits	C4533A	U.S.
	C4534A	Europe
	C4535A	Asia
	C4536A	Japan, Inter-Americas

1. The Color print cartridge is compatible with the following printers: HP DeskJet 600, DeskJet 660C, DeskJet 680C, DeskJet 685C, DeskWriter 600, DeskWriter 660C, and DeskWriter 680C.
2. The color kits include a color print cartridge and a print cartridge storage container. The storage container can hold one black or one color print cartridge.

Print Cartridge Specifications

Specification	Hewlett-Packard Print Cartridges
Type	Plain paper drop-on-demand Thermal InkJet printing
Ink Base 51629A (Black) 51649A (Color)	Pigment Based Ink Dye Based Ink
Print Cartridge Life 51629A (Black) ¹ 51649A (Color) ²	650 Pages at 5% Density 350 Pages at 15% Density
Typical Usable Ink 51629A (Black) 51649A (Color)	40 ml 7.6 ml per Chamber
Number of Nozzles 51629A (Black) 51649A (Color)	48 Nozzles 48 Nozzles (16 per Color)
Pen Speed 51629A (Black) 51649A (Color)	8 kHz 5 kHz
Shelf Life	18 Months
Vertical Resolution	300 dpi

1. The 51629A print cartridge life is based on an 8 in. x 10 in. printable area with a 5% printing density.
2. The 51649A print cartridge life is based on an 8 in. x 10 in. printable area with a 15% printing density. The printing consists of 10% composite black and 15% of the following colors: cyan, magenta, yellow, green, red and blue.

Thermal Inkjet Technology

The HP DeskJet printer family uses Thermal InkJet II (TIJ II) technology. This technology centers on a disposable print cartridge which propels ink out of 48 nozzles. The basic principle of TIJ II is to apply heat to a tiny measure of ink until it expands and is propelled through a nozzle.

This is achieved by first filling a small reservoir, known as the firing chamber, with ink. The next step is to heat the ink with a thin-film resistor layered above the firing chamber. As the ink heats up, it expands to form a bubble. As the bubble continues to expand and burst, it is forced through the nozzle located below the firing chamber.

This process is repeated up to 8,000 times per second and creates residual heat in the resistor which must be removed. A layer of silicon placed above the resistor transfers the residual heat from the resistor.

Print Cartridge Safety

If ink is accidentally ingested, contact the HP Health Line 1 (800) 457-4209 in North America. From all other international locations the HP Health Line can be reached by calling 1 (503) 494-7199. For health related issues, this line is staffed 24 hours per day.

Material Safety Data Sheet (MSDS)

A Material Safety Data Sheet (MSDS) is available for the print cartridges. The MSDS includes product identification, characteristics of the ink, and precautions for handling and use. You can request a MSDS at the following address:

Hewlett-Packard Customer Information Center
Department MSDS
19310 Pruneridge Avenue
Cupertino, CA 95014
Mailstop 49AS

Telephone 1 (800) 752-0900
Ask for Department MSDS (6:00 AM to 5:00 PM Pacific Time)

The Material Safety Data Sheet is also available from the following sources:

- HP forums of electronic bulletin board services
- HP FIRST
- Customer Support Centers

Refer to "Service and Support/Resources" for access to the above resources.

Maintaining Print Cartridges

The printer automatically performs operations of spitting, wiping, and capping of the print cartridge nozzles to maintain optimum print quality. These operations occur transparently to the user.

Proper use and handling will provide optimum print quality and print cartridge life.

Note See “Print Cartridge Information/Maintenance and Troubleshooting” for more print cartridge troubleshooting information.

Print Cartridge Tips

Print Cartridge Dos and Don'ts

Do:	Don't:
Keep print cartridges sealed in their packaging until ready for use. (The print cartridges have a longer life sealed in the packaging than in the printer or the print cartridge storage container.	Do not use print cartridges after the expiration date. See “Print Cartridge Information/Maintenance and Troubleshooting.”
Keep opened print cartridges in the printer or the storage container.	Do not unplug the printer without turning the power off from the power button. Pressing the power button caps the print cartridge in the service station, keeping the ink from drying in the print cartridge nozzles.
If the printout is missing dots or white lines appear to run through the printout, refer to “Troubleshooting Information/Print Quality Problems/Missing Dots.”	Do not allow the print cartridge contacts and nozzles to touch any surface or object, including your fingers. Skin oil and dust can cause print quality problems.
Store print cartridges at room temperature.	Do not install a print cartridge that has crusting of dried ink around the print cartridge nozzles. Discard it and install a new print cartridge.
Press the Power button to turn off the printer rather than unplugging the printer.	

Note On the HP DeskJet and Desk Writer 600 Series Printers, opening the access door automatically moves the print cartridge to the center of the mechanism for easy access.

Modifying or Refilling Print Cartridges

See “Print Cartridge Information/General/Refilling Policy.”

Identifying the Expiration Date

Print quality problems may be caused by print cartridges that have passed their expiration date. The print cartridge expiration date is 18 months after the date of manufacture.

Methods for Identifying Print Cartridge Expiration Dates

Method 1 - Read the Date on the Box

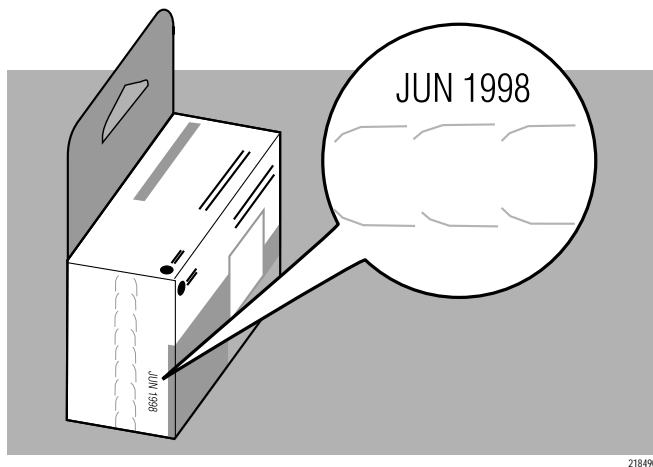

If the print cartridge is in a box, read the "Use Before" date printed on the box.

Method 2 - Read the Code on the Print Cartridge

1. Determine the manufacturing date from the code printed on the print cartridge.

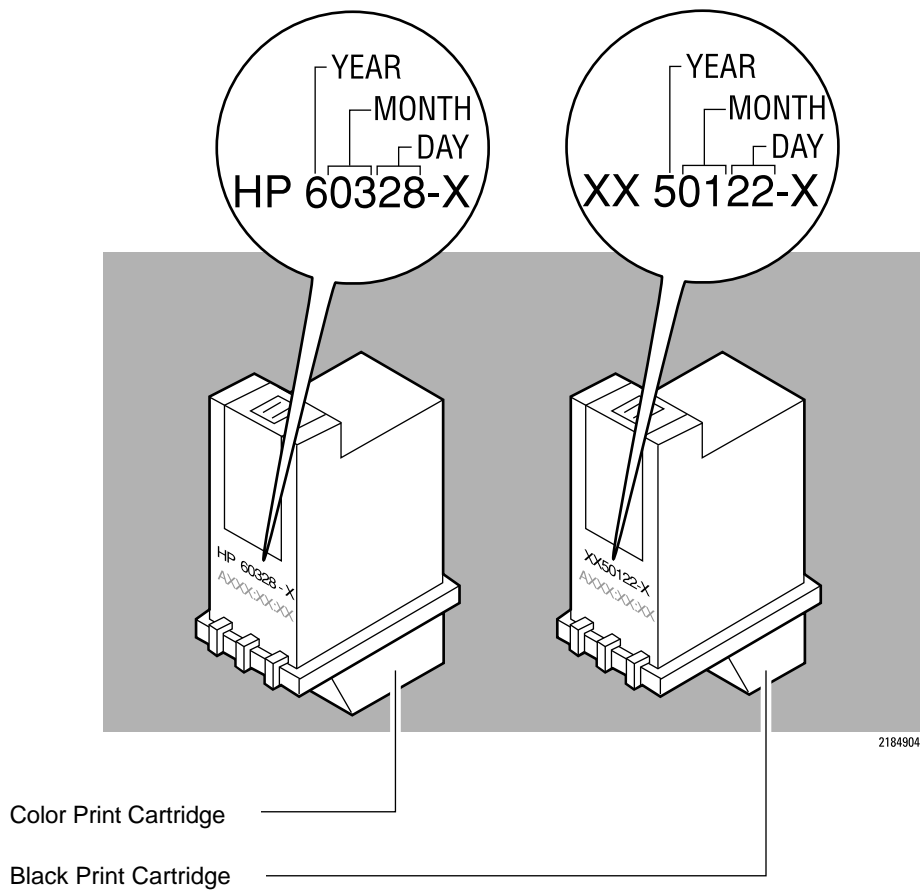

2. Replace the print cartridge if it is more than 18 months after the manufacturing date code.

Note

Ink can evaporate through the nozzles, reducing the print cartridge life. Therefore, keep print cartridges in their sealed container or capped by the service station at the right end of the mechanism.

Use a FIFO (First In, First Out) inventory control process to avoid having print cartridges longer than the print cartridge shelf life specification.

Short Print Cartridge Life

There are several causes for short print cartridge life. The information below shows the average life of a print cartridge and possible causes for a reduction to its life.

Print Cartridge Life Specifications

Print Cartridge	Part Number	5% Density	15% Density	Sealed in its Container (Shelf Life)
Black	51629A	650 Pages		18 Months
Color	51649A		350 Pages	18 Months

1. The 51629A print cartridge life is based on a 8 in. x 10 in. printable area with a 5% printing density.
2. The 51649A print cartridge life is based on an 8 in. x 10 in. printable area with a 15% printing density. The printing consists of 10% composite black and 15% of the following colors: cyan, magenta, yellow, green, red and blue.

Possible Causes for Short Print Cartridge Life

Cause	Reason
Higher coverage rate than listed in specifications.	The rate of coverage on the page significantly impacts the number of pages per print cartridge. Heavy concentrations of ink and higher print quality significantly reduces the number of pages per print cartridge.
The pages contain graphics.	Generally, graphics use ink at a much higher rate than text. If possible, print drafts of documents without the graphics.
The selected print mode uses more ink.	Higher quality print modes use more ink than a draft print mode. To maximize print cartridge life, print drafts of documents in EconoFast mode, then print the final copies in Best mode.
Print cartridge is past its expiration date.	Replace the print cartridge. Use a FIFO (First In-First Out) inventory process to minimize having a stock of expired print cartridges.

[Continued on next page](#)

Possible Causes for Short Print Cartridge Life (Cont.)

Cause	Reason
Printer was unplugged with the print cartridge out of its home position	A service station is located at the right end of the mechanism. This service station caps the print cartridge nozzles to minimize ink drying in the nozzles. Turning off the printer caps the print cartridge and returns it to the service station. Always allow the print cartridge to return to the home position by pressing the Power button rather than unplugging the printer.
Print cartridge may need to be restored.	Run the print cartridge cleaning routine. If print quality is not restored after a page of printing, replace the print cartridge.
Excessive use of the print cartridge cleaning routine.	The process of restoring print cartridges, by running the cleaning routine, uses ink. Avoid excessive use of the cleaning routine.
Print cartridge stored outside of the printer.	Open print cartridges must be stored in the printer.
Print cartridge has been refilled.	Hewlett-Packard does not recommend or guarantee the print quality or life from the refilling of print cartridges. Replace the print cartridge with a new print cartridge.
The print cartridge was prematurely removed from its sealed container.	The print cartridge has a longer life sealed in its packaging rather than in the printer or the print cartridge storage container. Keep print cartridges sealed in their packaging until needed. Then, install the print cartridge promptly into the printer.
Estimate of pages printed with the print cartridge is incorrect.	It is very easy to underestimate the number of pages printed. When counting pages per cartridge, be sure to count drafts that are thrown away.
The print cartridge is faulty.	Replace the print cartridge. If there becomes a pattern of faulty print cartridges, the printer may be causing the print cartridges to fail. In this case, return the printer for repair and indicate the history of the faulty print cartridges.
The printer has a hardware problem.	The service station may be faulty, or the printer may be damaging the print cartridges. If the problem recurs with the printer, return the printer for repair and indicate the history of the faulty print cartridges.
Short color print cartridge life.	Most of the causes for short black print cartridge life also apply to the color print cartridge. Review the other possible causes in this table.

Print Cartridge Cleaning Routine

If rows of dots are missing on printouts, try cleaning the print cartridge by using the print cartridge cleaning routine in the printer. Refer to "Troubleshooting Information/Printer Diagnostic Information/Print Cartridge Cleaning."

Clearing Clogged Nozzles

If rows of dots are missing, the print cartridge contains ink, and print cartridge cleaning procedure did not solve the problem, the print cartridge may have clogged nozzles. Replace the print cartridge.

Printout Missing Dots

Horizontal rows of dots missing on printouts may be the result of a connection problem between the printer carriage contacts and the print cartridge contacts. For information about solving missing dot problems, refer to "Troubleshooting Information/Print Quality Problems/Missing Dots."

Print Quality Problems

Refer to "Troubleshooting Information/Print Quality Problems/Misc. Print Quality Problems."

Media Part Numbers

The following are general guidelines for the selection and loading of paper and media in HP DeskJet and DeskWriter printers. For information about your specific printer, refer to “User’s Guide/Printable Area and Paper Handling.”

HP Media Part Numbers

Product Name	Description	Dimensions	Package Size	Part Number
HP Premium Inkjet Paper (Not for use with photo pen)	U.S. Letter/A-size coated paper for premium DeskJet printing	216 x 279 mm (8.5 x 11 in)	200 sheets	51634Y
HP Premium Inkjet Paper (Not for use with photo pen)	European/A4-size coated paper for premium DeskJet printing	210 x 297 mm	200 sheets	51634Z
HP Premium Transparency Film	U.S. Letter/A-size transparency film for presentation-quality overheads	216 x 279 mm (8.5 x 11 in)	20 sheets	C3828A
HP Premium Transparency Film	European/A4-size transparency film for presentation-quality overheads	210 x 297 mm	20 sheets	C3832A
HP Premium Transparency Film	U.S. Letter/A-size transparency film for presentation-quality overheads	216 x 279 mm (8.5 x 11 in)	50 sheets	C3834A
HP Premium Transparency Film	European/A4-size transparency film for presentation-quality overheads	210 x 297 mm	50 sheets	C3835A
HP Premium Glossy Paper	U.S. Letter/A-size glossy paper	216 x 279 mm (8.5 x 11 in)	10 sheets	C3833A
HP Premium Glossy Paper	European/A4-size glossy paper	210 x 297 mm	10 sheets	C3831A
HP Premium Glossy Paper	U.S. Letter/A-size glossy paper	216 x 279 mm (8.5 x 11 in)	50 sheets	C3836A
HP Premium Glossy Paper	European/A4-size glossy paper	210 x 297 mm	50 sheets	C3837A
HP Greeting Card Paper	A-size paper and matching envelope for Quarter fold cards	216 x 279 mm (8.5 x 11 in)	20 ea	C1812A

[Continued on next page](#)

HP Media Part Numbers (Cont.)

Product Name	Description	Dimensions	Sheets per Pack	Part Number
HP Bright White InkJet Paper	U.S. Letter/A-size treated paper great for two-sided printing	216 x 279 mm (8.5 x 11 in)	500 sheets	C1824A
HP Bright White InkJet Paper	European/A4-size treated paper great for two-sided printing	210 x 297 mm	500 sheets	C1825A
HP Banner Paper ¹	U.S. Letter/A-size Z-Fold, both-side printable	216 x 279 mm (8.5 x 11 in)	100 sheets	C1820A
HP Banner Paper ¹	European/A4, Z-fold, both-side printable	210 x 297 mm	100 sheets	C1821A
HP Photo Paper ²	U.S. Letter/A-size glossy paper great for photos	216 x 279 mm (8.5 x 11 in)	20 sheets	C1846A
HP Photo Paper ²	European/A4-size glossy paper great for photos	210 x 297 mm	20 sheets	C1847A
HP Photo Paper Greeting Card (Available Spring '97) ²	U.S. Letter/A-size glossy paper great for photos	216 x 148.5 mm (8.5 x 5.5 in)	20 sheets	C1848A
HP Photo Paper Greeting Card (Available Spring '97) ²	European/A4-size glossy paper great for photos	210 x 297 mm	20 sheets	C1849A
HP Photo Paper Invite Card (Available Spring '97) ²	Glossy paper and matching envelopes for half-fold Invite Card with two-sided printing	216 x 148.5 mm (8.5 x 5.5 in)	20 sheets	C1850A
HP Photo Paper Invite Card (Available Spring '97) ²	Glossy paper and matching envelopes for half-fold Invite Card with two-sided printing	148 x 210 mm	20 sheets	C1851A

1. Verify through your User's Guide the applicability of using banner paper with your printer.
2. Verify through your User's Guide the applicability of using photo paper with your printer.

Selecting Paper Tips

Tips for Selecting and Using Paper

- For paper handling and printable area specifications, refer to “Product Information/Specifications.”
- Always use paper that conforms to the product’s specifications. Refer to “Product Information/Specifications.”
- Most plain paper manufactured for photo-copying produces good results for most printing needs. However, cotton bond paper, HP Premium Inkjet Paper, and HP Premium Glossy Paper produce excellent printing results for special projects.
- Before you purchase large quantities of a certain type of paper, print on both sides of a few sheets to determine if it provides acceptable quality printing on its "print side." (See "Determining the Print Side of Media.")
- Be sure that your paper does not have tears, dust, wrinkles, or curled or bent edges.

Tips for Selecting and Using Envelopes

- Always use envelopes that conform to the product’s Specifications. Refer to “Product Information/Specifications.”
- Before you purchase large quantities of a certain type of envelope, first sample its ease of use with the printer to determine whether it's compatible.
- Use high quality envelopes that are thin and sharply creased.
- Do not use envelopes that are shiny or embossed or that have clasps or windows.
- Do not use envelopes with thick or crooked edges, or envelopes that are damaged, curled, wrinkled, or irregularly shaped.

Tips for Selecting and Using Transparencies and other Media



- Always use transparencies, index cards, postcards, and other media that conform to the product's Specifications. Refer to "Product Information/Specifications."
- For best results when printing on transparencies, use HP Premium Transparency Film.
- Do not use paper that is damaged, curled, or wrinkled.
- Do not use paper with cutouts or perforations.
- Do not use multiple-part forms.
- Do not use paper that is heavily textured or embossed.

Tips for Selecting and Using Labels

The following Hewlett-Packard printers support labels:

- HP DeskJet 510
- HP DeskJet 520
- HP DeskJet 540
- HP DeskJet 550C
- HP DeskJet 560C
- HP DeskJet 600 Series
- HP DeskJet 750C
- HP DeskJet 800 Series
- HP DeskWriter 510
- HP DeskWriter 520
- HP DeskWriter 540
- HP DeskWriter 550C
- HP DeskWriter 560C
- HP DeskWriter 600 Series

While label support is not officially recognized in the User's Guides, the printers listed above can successfully be used if the following guidelines are STRICTLY followed:



Caution Failure to follow the suggestions below can permanently damage your printer.

The following are guidelines when using labels in HP DeskJet printers:

- Use only Avery paper labels that are specifically designed for use with HP inkjet printers. These labels are less likely to peel when inside the printer.
- Do not use plastic or clear labels. DeskJet inks are formulated for use with paper or specially treated plastic papers and will not dry properly when used with plastic or clear labels.
- Do not use ANY label material which is damaged, folded, curled, or wrinkled in any fashion. These conditions are frequent causes of jams caused by labels peeling inside the printer. Labels that have peeled inside the printer are difficult to remove and may necessitate returning the printer to HP for service.
- Do not use labels that are over two years old. Older label materials are more likely to peel inside the printer.
- Do not print on partially used sheets of label material. The varying thicknesses of material passing over the print rollers can cause label jams or print skew.

Observe the following guidelines when storing label materials:

- Always store label materials in the manufacturer's packaging until ready for use. The manufacturer's packaging protects the labels and adhesives from humidity extremes which could prematurely age the labels.
- Always store label materials out of direct sunlight.
- Keep label materials flat in the original packaging to help prevent premature aging, wrinkling or bending.

Tips for Selecting and Using Banner Paper

- For paper handling and printable area specifications, refer to “Product Information/Specifications.”
- Always use paper that conforms to the product’s specifications. Refer to “Product Information/Specifications.”
- Most 20 lb Z-fold banner-type paper will produce good results for your banner printing needs. However, HP Premium Inkjet Banner Paper, will produce excellent printing results for all your banner printing projects.
- Before you purchase large quantities of a certain type of paper, print a few sheets to determine if it provides acceptable quality printing.
- Be sure that your paper does not have tears, dust, wrinkles, or curled or bent edges.



Tips for Selecting and Using HP Photo Paper with the HP Photo Cartridge

- Verify that the HP Photo Cartridge is intended for use in your printer. Refer to the “User’s Guide” for your printer.
 - Remove the black print cartridge and replace it with the HP Photo Cartridge. Refer to the “User’s Guide” for your printer for instructions.
 - Be certain that you have selected “Use HP Photo Cartridge” in the Page Setup box.
 - Use HP Photo Paper (loaded glossy-side down) in your printer’s IN tray, not HP Premium InkJet paper when you print photographs. Using HP Photo paper will ensure high-quality, fade-resistant images.
 - For paper handling and printable area specifications, refer to the “User’s Guide” for your printer.
 - Before you purchase large quantities of a certain type of paper, print a few sheets to determine if the paper provides acceptable quality printing.
 - Be sure that your paper does not have tears, dust, wrinkles, or is curled, or has bent edges.
 - For best results with the HP Photo paper/HP Photo cartridge combination, scan your photographs at 100 or 150 dpi. If you scan them at a higher dpi, you won’t improve the print quality, and your photographs will take longer to print.
 - Printing in Best mode yields the most vivid colors. (If the slower printing speed is acceptable.)
- 

Loading Paper Tips

General Tips for Loading Media Effectively

- To obtain the best print quality and avoid getting media jammed in the paper feed rollers, always use paper and other media that conform to the product's specifications. Refer to "Product Information/Specifications."
- Load only one media type at a time into the IN tray making sure the right edge of the media is aligned with the right edge of the IN tray.
- Insert all paper, cards, envelopes, labels, transparencies and banner paper print-side-down into the IN tray of the printer. (See "Determining the Print Side of Media.")
- Never load more than the recommended amount of media into the IN tray at one time.
- Always load index cards, postcards, and envelopes in portrait orientation (that is, where the paper is longer than wide when placed in the IN tray).
- Always use print settings in the printer driver that match the media type, size, and orientation.
- Before inserting a stack of media into the IN tray, always tap its edges on a flat surface to even it out.



Determining the Print Side of Media

Insert all paper, cards, envelopes, labels, transparencies and banner paper print-side down into the IN tray of the printer. Here are some tips for loading media print side down:

- For plain paper, load the side identified by the paper's packaging as the printside face down.
- For letterhead paper, load the letterhead side down and facing the back of the paper tray.
- For HP Premium Inkjet Paper, load face down the side identified on the packaging as the print side with the corner arrow facing the back of the paper tray.
- For HP Premium Glossy Paper, load the glossy side down.
- For index cards or postcards, load the side designed to be written upon face down.
- For envelopes, load the side you address face down
- For labels, load the paper side down (the slick side up).
- For HP Premium Transparency Film, load the rough side down with the sensing strip facing the back of the paper tray.
- For HP Premium Banner Paper, load face down the side identified on the packaging as the print side with the corner arrow facing the back of the paper tray.

Using the Single-Sheet Feeder

If your printer is equipped with a single-sheet feeder, the single-sheet feeder allows you to feed a single sheet of paper or other media into the printer without unloading the IN tray. The single-sheet feeder slides freely to the right and left to accommodate the width of the media you insert. Always use paper and other media that conform to the product's Specifications. Refer to "Product Information/Specifications."



Part Numbers

Note These power modules are not compatible with the HP DeskJet 300 series printers.

Power Module Part Numbers and General Information

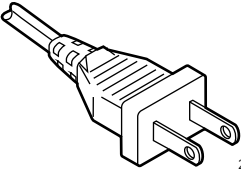
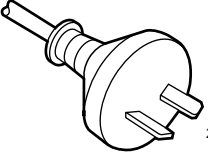
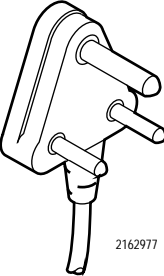
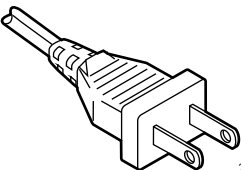
Power Module Plug Type	Country or Region	Region's AC Voltage	HP Part Number
 2162978	US Canada Latin America Brazil Ecuador Columbia Taiwan Saudi Arabia Mexico Japan	 120 VAC 60 Hz 100 VAC 50/60 Hz	 9100-5124 (C2175A) 9100-5130 (C2178A)
 2162980	People's Republic of China Argentina Australia	 220 VAC 50 Hz 240 VAC 50 Hz	 9100-5129 (C2179A) 9100-5127 (C2181A)
 2162977	India South Africa	220 VAC 50 Hz	9100-5128 (C2180A)
 2162978	Brazil Philippines	220 VAC 50 Hz	9100-5391

Continued on next page

Power Module Part Numbers and General Information (Cont.)

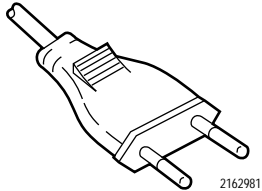
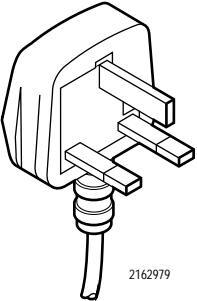
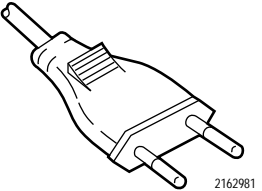
Power Module Plug Type	Country or Region	Region's AC Voltage	HP Part Number
 <p>2162981 (4.8 mm Plug)</p>	Korea	220 VAC 60 Hz ¹	9100-5126 (C2182A)
 <p>2162979</p>	United Kingdom Singapore Malaysia Asia-Pacific Middle East	240 VAC 50 Hz	9100-5131 (C2177A)
	Hong Kong	220 VAC 50 Hz	9100-5348
 <p>2162981 (4 mm Plug)</p>	Eastern & Western Europe Chile Israel Jordan Nicaragua North Africa Paraguay Peru Russia Turkey	230 VAC 50 Hz	9100-5132 (C2176A)
	Asia, North Caribbean Indonesia South America Thailand	220 VAC 60 Hz ¹	9100-5346

1. This power module is wound for 50 Hz.

Specifications

Power Module Specifications

Category	Specification
Input Voltage (Power Module Dependent)	100 VAC, 120 VAC, 220 VAC, 230 VAC, or 240 VAC ($\pm 10\%$)
Frequency	
100 VAC	50/60 Hz (± 3 Hz) \pm
120 VAC	60 Hz (± 3 Hz)
220 VAC	50 Hz (± 3 Hz)
230 VAC	50 Hz (± 3 Hz)
240 VAC	50 Hz (± 3 Hz)

Troubleshooting

Possible Causes of Printer Not Printing

- Power module plug may not be fully seated in the printer's power socket.
- Power module may not be connected to a powered receptacle. Make sure any power strip switches are turned on. Also, try a different outlet.
- Power Module is not the correct device for the country or region's power. Refer to "Product Information/Ordering Printer Options".
- Power Module may be faulty. Substitute another power module if available.

Warranty Information

The warranty for HP DeskJet/DeskWriter printers varies depending upon the product and the date and country of purchase.

For products returned under warranty, Hewlett-Packard may use one of the following options:

- Repair the product
- Replace the product with a re-manufactured unit
- Replace the product with a product of equal or greater functionality
- Refund the purchase price

Hewlett-Packard Limited Warranty Statement

HP Product	Duration of Limited Warranty (Unless otherwise stated in the printer's documentation)
Software	90 days
Print Cartridges	90 days
Printer and Peripheral Hardware	1 Year

Extent of Limited Warranty

1. Hewlett-Packard (HP) warrants to the end user customer that HP products will be free from defects in materials and workmanship, for a specified time after the date of purchase by the customer. The duration of this limited warranty is stated above. Certain additional conditions and limitations of HP's warranty are stated in the user's guide. Those conditions and limitations include:
 - a. For software products, the warranty applies only to the media upon which the product is recorded; and
 - b. HP does not warrant the operation of any product to be uninterrupted or error free.

2. HP's limited warranty covers only those defects which arise as a result of normal use of the product, and do not apply to any:
 - a. Improper or inadequate maintenance;
 - b. Software or interfacing not supplied by HP;
 - c. Unauthorized modification or misuse;
 - d. Operation outside the product's environmental specifications, including duty cycle abuse or use of a mechanical switchbox without a designated surge protector;
 - e. Use of non-supported printing media or memory boards; or
 - f. Improper site preparation or maintenance.
3. For HP printer products, the use of a non-HP print cartridge or a refilled print cartridge does not affect either the warranty to the customer or any HP support contract with the customer; print cartridge includes both toner cartridges and ink cartridges. However, if printer failure or damage is attributable to the use of a non-HP or refilled print cartridge, HP will charge its standard time and materials charges to service the printer for the particular failure or damage.
4. If any software media product or print cartridge product proves defective during the applicable warranty period, and if the product is covered by HP's warranty, the customer shall return the product for replacement.
5. If HP receives, during the applicable warranty period, notice of a defect in a hardware product which is covered by HP's warranty, HP shall either repair or replace the product, at its option. Any replacement product may be either new or like-new, provided that it has functionality at least equal to that of the product being replaced.
6. If HP is unable to repair or replace, as applicable, a defective product which is covered by HP's warranty, HP shall within a reasonable time after being notified of the defect, refund the purchase price for the product, provided the customer returns the product.
7. Your warranty is valid in any country where this product is distributed by Hewlett-Packard. Contracts for additional services such as on-site service are available from any authorized HP service facility in countries where this product is distributed by HP or an authorized importer.
8. This limited Warranty Statement gives the customer specific legal rights. The customer may also have other legal rights which vary from state to state in the United States, from province to province in Canada, and from country to country elsewhere in the world.

Limitations of Warranty

1. NEITHER HP NOR ANY OF ITS THIRD PARTY SUPPLIERS MAKES ANY OTHER WARRANTY OF ANY KIND, WHETHER EXPRESS OR IMPLIED, WITH RESPECT TO HP PRODUCTS. HP AND ITS THIRD PARTY SUPPLIERS SPECIFICALLY DISCLAIM THE IMPLIED WARRANTIES OF MERCHANTABILITY AND FITNESS FOR A PARTICULAR PURPOSE.
2. To the extent that this Limited Warranty Statement is inconsistent with the law of the locality where the customer uses the HP product, this Limited Warranty Statement shall be deemed modified to be consistent with such local law. Under such local law, certain limitations of this Limited Warranty Statement may not apply to the customer. For example, some states in the United States, as well as some governments outside the United States (including provinces in Canada), may:
 - a. Preclude the disclaimers and limitations in this Warranty Statement from limiting the statutory rights of a customer (e.g. Australia and the United Kingdom);
 - b. Otherwise restrict the ability of a manufacturer to make such disclaimers or impose such limitations; or
 - c. Grant the customer additional warranty rights, specify the duration of implied warranties which the manufacturer cannot disclaim, or not allow limitations on how long an implied warranty lasts.
3. To the extent allowed by local law, the remedies provided in this Warranty Statement are the customer's sole and exclusive remedies.

Limitations of Liability

1. EXCEPT FOR THE OBLIGATIONS SPECIFICALLY SET FORTH IN THIS WARRANTY STATEMENT, IN NO EVENT SHALL HP BE LIABLE FOR ANY DIRECT, INDIRECT, SPECIAL, INCIDENTAL, OR CONSEQUENTIAL DAMAGES, WHETHER BASED ON CONTRACT, TORT, OR ANY OTHER LEGAL THEORY AND WHETHER ADVISED OF THE POSSIBILITY OF SUCH DAMAGES.

Obtaining Printer Drivers

Updates to the HP Printer Driver software occur periodically. New versions can be obtained from authorized Hewlett-Packard dealers or any of the sources listed below.

24-hour modem access

HP BBS Library

HP's electronic bulletin board library service is available 7 days a week, 24 hours a day for your convenient access to HP printer drivers and support information.

In the United States (for the following baud rates: 300, 1200, 2400, 4800, 9600, 14400), call (208) 344-1691.

In the United Kingdom (for baud rates up to 14400) call, 44 (1344) 361891.

World-wide (for the following baud rates: 300, 1200, 2400, 4800, 9600, 14400), call 1 (208) 344-1691.

Set your modem communications software to N,8,1.

CompuServe

Printer drivers and interactive sharing of technical information are available on CompuServe's HP Peripherals forum (GO HPPER).

To subscribe in the United States, call CompuServe, Inc., at (800) 524-3388 and ask for representative #51 (This service is not operated by Hewlett-Packard).

To subscribe in the United Kingdom, call toll-free (0800) 289378 or (614) 529-1349.

To subscribe world-wide, call (614) 529-1349.

Internet

Printer drivers and product support information can be obtained through the World-Wide Web as follows:

URL <http://www.hp.com/home.html>
or, www.hp.com/go/cposupport

Updated Printer Drivers by Mail

HP's Distribution Centers provide printer drivers and printer driver updates.

Worldwide Fulfillment Information

Driver Distribution	Languages Available	Telephone Orders	Fax Orders	Mail Orders
US and Canada	<ul style="list-style-type: none"> ■ English ■ French ■ Spanish 	970-339-7009 Mon - Sat, 24 Hours per day	970-330-7655	US Driver Fulfillment for Hewlett-Packard PO Box 1754 Greeley, CO 80623
UK (0) is used only when calling within the country	<ul style="list-style-type: none"> ■ English ■ French ■ German ■ Spanish ■ Italian 	-- 44 (0) 1429 865 511 --- 44 (0) 1429 863 343 -- 44 (0) 1429 863 353 -- 44 (0) 1429 520 012 --- 44 (0) 1429 520 013 Mon - Fri, 8:30 am to 6 pm CET, (except Wed 8:30 am to 4 pm CET)	(Within UK) 0 1429 866 000 (Outside UK) 44 1429 866 000	European Fulfillment for Hewlett-Packard c/o Starpack International, Ltd. PO Box 63 Hartlepool Cleveland TS25 2YP United Kingdom
Asia Pacific (Singapore)	All localized languages	65 740 4477 Mon - Fri 8:30 am-5:30 pm Singapore time	65 740 4499 (24 hours a day - 7 days a week)	Fulfillment: Plus Pte Ltd. No. 51, Ubi Ave 3 Singapore 1440
Australia (Sidney)	All localized languages	612 565 6099 Mon - Fri 8:30 am-5:30 pm Australian Eastern Time	612 519 5631 (24 hours a day - 7 days a week)	Fulfillment: Plus Pty Ltd. Private Bag 75 Alexandria NSW Australia 2015

U.S. Service Support Contracts

HP Express Exchange Service

Hewlett-Packard offers an express exchange service to minimize product downtime. With HP Express Exchange Service, a replacement unit is available by 10:30 the next working day.

HP Express Exchange provides next day exchange service (same as HP SupportPack) but the fee is based on a per incident of repair rather than throughout the warranty period. This service does not need to be purchased within 30 days of the printer purchase date.

To order the HP Express Exchange Service, call toll-free at 800-835-4747; ask for ext. 524.

HP SupportPack

The HP SupportPack is an enhancement to the customer's original one-year warranty repair service. The HP SupportPack provides next day express exchange service (see above) for the duration of a three-year warranty period. This service enhancement provides customers with a cost-effective and timely way to achieve quality support. The HP SupportPack (ordered like any other HP product) is sold exclusively through resellers and is not available directly from Hewlett-Packard. Customers must purchase this service enhancement within 30 days of purchasing the printer. The HP SupportPack is not transferable from one piece of equipment. Additional information on HP SupportPack and the prices for the service upgrade are available through HPNN and the In-Touch newsletter.

HP Customer Return Repair Service

If uptime is less critical, the HP Customer Return Repair Service provides maintenance service at the HP Customer Service Center located in Corvallis, Oregon. HP will repair the product within two working days from receipt and return via surface transportation.

To order the HP Customer Return Repair Service for customers with non-critical applications, call toll-free 800-835-4747; ask for ext. 524.

Non-U.S. Service Support Contracts

HP SupportPack

The HP SupportPack enhances the service offering during the warranty period by upgrading warranty repair service to a next day exchange service. This service enhancement provides customers with a cost-effective and timely way to achieve quality support. HP SupportPack is sold exclusively through resellers (ordered like any other HP product) and is not available directly from Hewlett-Packard. Additional information on HP SupportPack and the prices for the service upgrade is available through HPNN.

For other service and support contracts, contact the Hewlett-Packard office or Response Center for that country.



Returning a Printer for Service

In the USA

If a printer requires service, the customer can contact a service authorized reseller. The reseller should verify that the printer is in need of repair and contact the HP Corvallis Service Center. Sales authorized resellers should call (800) 544-9976 to arrange for repair. Service authorized resellers should call (503) 750-2035.

Customers can contact Hewlett-Packard directly by calling HP Customer Support Center at (208) 323-2551. They will verify that the printer is in need of repair and transfer the customer to the HP-Corvallis Repair Center. If packaging materials are needed, call the HP Resellers Response Line at (800) 544-9976.

Printer Return Instructions

If the printer needs to be shipped, be sure it is packed in a protective carton. Hewlett-Packard recommends that the original shipping container be saved for this purpose. In-transit damage is not covered by the warranty. It is suggested that shipments are always insured.

When either a customer or reseller calls HP to arrange for service, the HP Corvallis Service Center will dispatch a premium carrier to pick up the product at the reseller or customer location. The printer will be delivered to HP, at HP's expense, using second day delivery. The customer or reseller must still package the printer for shipment.

Once the printer is repaired, HP will ship it to the customer or reseller location using second day delivery.

You can help assure effective servicing of your customer's printer by following these guidelines:

Procedure:

1. Follow the troubleshooting instructions in this manual to make certain the malfunction is in the printer and not the result of an interface error or a malfunction in the computer or software. If possible, identify the defective area or function.
2. If you determine that repair is required, please provide the following with the printer when returning the printer for service:
 - a. Printout a copy of the "HP Printer Repair Sheet." (For information regarding printouts, see the note at the top of the HP Printer Repair Sheet.)
 - b. Determine the appropriate customer code from the Printer Repair Feedback Information section which follows.
 - c. Fill out the repair sheet. Include specific information, such as the configuration at the time of the malfunction, the type of interface cable, a description of the computer or host, and a description of the software application in use.
 - d. If purchased through a Hewlett-Packard reseller, include a copy of the sales slip or other proof of purchase to establish the warranty coverage period.

In the UK, France, Germany, Switzerland, Austria, Belgium, Norway, Sweden, Denmark, Finland, and the Netherlands

If a printer fails during the warranty period, the customer should do the following:

1. Follow the troubleshooting procedures in this document or consult the HP FIRST facsimile assistance services.
2. If the customer is still unable to determine the cause of the failure, the customer should contact their local reseller or the European Customer Support Center.

Customer support representatives can answer your questions regarding the setup, configuration, installation, and operation of the printer. They can also troubleshoot and diagnose printer problems and, if necessary, can give instructions for getting the printer serviced and repaired.

If available for your country and language, phone numbers for HP FIRST and the European Customer Support Center are given in a separate document shipped with the printer. If additional information is needed, customers can call the reseller or the nearest HP Sales and Support Office.

If a printer fails after the warranty period:

1. Follow the troubleshooting procedures in this document or the printer user's guide.
2. If the customer is unable to determine the cause of the failure, the customer should contact their local reseller or the nearest HP Sales and Support Office for instructions on returning your printer for service and repair.

Elsewhere in the World

If a printer fails during or after the warranty period:

1. Follow the troubleshooting procedures in this document or the printer user's guide.
2. If the customer is unable to determine the cause of the failure, the customer should contact their local reseller or the nearest HP Sales and Support Office for instructions on returning your printer for service and repair.

Notes

- Operating accessories (such as, optional plug-in cartridges, print cartridges, and software) should not be included with the printer unless the problem relates to an accessory.
- In the U.S., the power module should not be included with the printer unless instructed otherwise.
- Outside of the U.S., the power module should be included when returning the printer for repair.

Service and Support Resources

HP Support Assistant (CD-ROM)

HP Support Assistant is an on-line tool providing technical information on a variety of Hewlett-Packard computers and peripheral products. This information is contained on a CD-ROM which is updated quarterly and mailed to you as part of the subscription. This system runs on any PC under MS Windows.

Obtaining HP Support Assistant CD-ROM

Country	Telephone Number	Fax Number	Mailing Address
U.S., Canada	1 (800) 457-1762 (24 Hours) 7 Days)	(317) 364-8888	Hewlett-Packard Company PO Box 4700 Crawfordsville, IN 47933 USA
Latin America	01 (317) 364-8882 (24 Hours) (7 Days)	(317) 364-8888	Hewlett-Packard Company PO Box 4700 Crawfordsville, IN 47933 USA
UK	1 (800) 457-1762 (24 Hours) (7 Days)	0-800-960-273	Hewlett-Packard Company PO Box 501 7300 AM Apeldoorn The Netherlands
Europe	31 (55) 384279 (9:00 - 6:00) (Monday - Friday)	31 (55) 434455	Hewlett-Packard Company PO Box 501 7300 AM Apeldoorn The Netherlands
Asia Pacific	65 740-4629 65 740-4477 (8:30 - 5:30) (Monday - Friday)	65 740-4617 65 740-4477	Hewlett-Packard Company Circuit Road PO Box 0131 Singapore 9137 Singapore

Hewlett-Packard News Network (HPNN)

HPNN is an electronic bulletin board service available only to HP authorized resellers. This service provides the following information:

- Presales Information
- Printer Drivers
- HP SupportPack Information
- Software Notes
- Postsales Information



For more information, call 1 (408) 553-7303.

HP Distribution Center

The HP Distribution Center has current printer drivers for Hewlett-Packard products. Call 1 (303) 339-7009 except Sundays.

HP Customer Information Center

The HP Customer Information Center provides presales product information. This service is available for resellers and end-user customers. Call 1 (800) 752-0900, Monday - Friday, 6:00 AM - 5:00 PM Pacific Time.

HP Reseller Response Line

The HP Reseller Response Line provides pre-sales and post-sales technical support for HP authorized resellers. Call 1 (800) 544-9976, Monday - Friday, 8:00 AM - 4:00 PM Pacific Time.

Ordering Supplies

Ordering Supplies

Country	Telephone Number
Austria	(1) 25000 536
Australia/New Zealand	(03) 895-2895
Belgium/Luxembourg	02-778 34 00
Canada (Except Toronto)	1 (800) 387-3154
Canada (Toronto)	(416) 671-8383
Community of Independent Sales	(095) 181 8002
Czech Republic	(2) 47 17 230
Denmark	4599 1000
Europe (East Central Headquarters)	(1) 25 000 0
Finland	(90) 887 21
France	Minitel 3616 HPMICRO, Rubrique 2: "Points de Vente" agréés
Germany	0180-53262-22
Greece	30-1-689 64 11
Hungary	(1) 142 09 86
Iceland	(1) 67 10 00
Israel	00972 3 53 80 380
Italy	02/9212 4378
Japan	(03) 331-6111
Latin America	(525) 326-40-00
Lebanon	009611 89 31 13
Norway	22 73 56 00
Poland	(22) 37 50 65
Portugal	(01) 301 7343
Slovenia	(61) 159 33 22
South Africa	002711 806 10 00
Spain	900 123 123
Sweden	(0) 8 750 2000
Switzerland	01 / 735 71 11
The Netherlands	020 - 547 6666
Tunisia	002161 28 01 44
Turkey	(0) 212 224 59 25
United Arabian Emirates	009714 37 75 91
United Kingdom	01344 369 369
U.S.	1 (800) 538-8787

HP BBS Library

The HP electronic bulletin board library service contains drivers and support information which can be downloaded to your PC via modem.

HP BBS Library

Country	Number	Baud Rate
Austria	+ 43 (222) 251658	2400, 4800, 9600, 14400, 19200, 28000, or ISDN
Belgium	+ 32 (2) 778-3819	1200, 2400, 4800, 9600, 14400
Denmark	+ 45 (45) 991905	300, 1200, 2400, 4800, 9600, 14400
Finland	(9600) 7280	2400, 4800, 9600, 14400
France	3616 HP MICRO	1200 to 14400 (Service Minitel)
Germany	*HP#	Datex J-BTX System
Italy	+ 39 (2) 9210-4244	Up to 14400
Netherlands	+ 31 (20) 647-5433	2400, 9600, 14400
Norway	+ 47 (2) 273-5697	2400, 4800, 9600, 14400, 19200
Sweden	+ 46 (8) 750-6262	2400, 4800, 9600, 14400
Switzerland	+ 41 (64) 560200	Up to 19200 or ISDN
United Kingdom	+ 44 (1344) 361891	Up to 14400
United States	+ 1 (208) 344-1691	300, 1200, 2400, 4800, 9600, 14400
Worldwide	Int Code + 1 (208) 344-1691	300, 1200, 2400, 4800, 9600, 14400

Set your modem for no parity, 8 data bits, and 1 stop bit (N, 8, 1).

HP FAXback on Demand - HP FIRST

You can use this service to select documents, such as product descriptions and technical information, which are then faxed to you. To access this service, use the handset on your fax machine and dial the appropriate number from the table in this section.

Use the following steps to use HP FIRST:

1. Call the system. You will need to use a touch-tone telephone or the phone set of your fax machine. A voice prompt will welcome you and guide you to the information you need. You will also need to give the phone number of the fax machine where you wish to receive the documents you select.
2. We suggest you initially request the index which lists all available documents.
3. Once you receive the HP FIRST index, choose the documents you need.
4. Call HP FIRST again. A voice prompt will ask you for the index number of the documents you have selected and would like to have faxed to you.
5. Selected documents will be sent immediately to the fax number you have specified.

Note

To obtain documents in English from outside the UK, dial your international access code and then (31) 20 681 5792 (international toll rates applicable).

HP FIRST Telephone Numbers

Country (Language)	Telephone Number
Austria (German)	0660-8128
Australia (English)	61-3-272 26 27
Denmark (Danish)	800-10453
Belgium (French)	0800 1 7043
Belgium (Dutch)	0800 1 1906
Europe (English)	(31) 20 681 5792
Finland (Finnish)	9800-13134
France (French)	05-905900
Germany (German)	0130-810061
Hong Kong (English)	506 24 22
Italy (Italian)	1678-59020
Korea (Korean)	82-2-769 05 43
Netherlands (Dutch)	06-0222420
Norway (Norwegian)	800-11319
Singapore (English)	65-291 79 51
Spain (Spanish)	900-993123
Sweden (Swedish)	020-795743
Switzerland (French)	155-1526
Switzerland (German)	155-1527
UK	0800 96 02 71
US	1 (800) 333-1917
Worldwide	Int Code + 1 (208) 344-4809

HP Audio Tips (U.S. Only)

HP Audio Tips is an automated audio (voice) problem-solving tips for your most frequently asked questions. Use the following telephone number:

- 1 (800) 333-1917

HP Forum on CompuServe

The HP Systems Forum on CompuServe is an on-line service accessible via modem. This service provides information about Hewlett-Packard products, and allows you to communicate with other Hewlett-Packard users.

You can join CompuServe at no charge by calling a telephone number in the table below. CompuServe will send you a free introductory membership immediately, including information on how to access CompuServe. From the CompuServe prompt, type:

GO HP <Enter>

CompuServe Telephone Numbers by Country Table

Country	Local Call/ Free-Phone Number	Direct Number
Argentina		54 (1) 345-3871
Australia	(008) 025240	61 (2) 410-4260
Canada	1 (800) 848-8199	1 (614) 529-1349
Chile		56 (2) 696-8807
France	36,638,122	33 (1) 4714-2160
Germany	(0130) 3732	49 (89) 6655-0111
Hong Kong		852 867-0118
Hungary		36 (1) 156-5366
Israel		972 (3) 290466
Japan	(0120) 221200	81 (3) 5471-5806
New Zealand	(0800) 446113	61 (2) 410-4260
Portugal		33 (1) 4714-2160
South Africa		27 (12) 841-2530
South Korea	(080) 022-7400	82 (2) 411-1327
Spain		33 (1) 4714-2160
Taiwan		866 (2) 651-6899
UK	(0800) 289378	44 (1272) 760680
U.S.	1 (800) 848-8199	1 (614) 529-1349
Venezuela		58 (2) 793-2984
Worldwide		Int Code + 1 (614) 529-1349

Hewlett-Packard Telephone Support

Technical Phone Support for Customers

The HP Customer Support Center provides free live technical assistance for peripherals during the hardware warranty of the product. If the product is still under warranty, the customer should call (208) 323-2551. If the product is out of warranty, the customer has two options.

- The customer can call 1 (900) 555-1500 at \$2.50 per minute.
- The customer can call 1 (800) 999-1148 at \$25.00 per call using VISA or MasterCard.

(The above prices are subject to change without notice)

To ensure the call is dealt with quickly, have the following information ready:

- The product model number and serial number.
- The operating system version and the configuration.
- A description of the software installed and the accessories used.

HP North American Customer Support Center

Assistance from the Hewlett-Packard North American Customer Support Center is available Monday to Friday, 7:00 AM to 6:00 PM Mountain time, except Wednesday when the hours are 7:00 AM to 4:00 PM.

- 1 (303) 635-1000

HP European Customer Support Center

Assistance from the Hewlett-Packard European Customer Support Center is available in English, Monday to Friday, 8:30 AM to 6:00 PM Central European time, except Wednesday when the hours are 8:30 AM to 4:00 PM.

- Int Code + 31 (20) 682-8291

Contacting Hewlett-Packard

To contact Hewlett-Packard, check your local telephone directory for the HP Sales and Service Office near you. If you cannot find an HP office, contact one of the major HP Sales and Service Offices or one of the following Worldwide Marketing Headquarters.

- Asia
Far East Sales Region Headquarters
Hewlett-Packard Asia Ltd.
22/F Peregrine Tower
Lipp Centre
89 Queensway, Central
Hong Kong
- Canada
Hewlett-Packard Ltd.
6877 Goreway Drive
Mississauga
Ontario L4V 1M8, Canada
- Europe
European Operations Headquarters
Hewlett-Packard S.A.
150, route du Nant-d'Avril
PO Box 1217
Meyrin 2/Geneva, Switzerland
- Latin America
Hewlett-Packard Latin Am. Headquarters
Monte Pelvoux 111
Lomas de Chapultepec
11000 Mexico D.F.
- Middle East/Africa
Middle East/Central Africa Sales Headquarters
Hewlett-Packard S.A.
Rue de Veyrot 39
CH-1217 Meyrin 1/Geneva, Switzerland
- U.S.
Intercon Operations Headquarters
Hewlett-Packard Company
3495 Deer Creek Road
PO Box 10495
Palo Alto, CA 94303-0896, USA

Printer Repair Feedback Information

Procedure for Providing Repair Feedback Information:

1. Make a copy of the HP DeskJet Printer Family Repair Sheet found on the following page.
2. Observe the problem with the printer. Verify the problem is repeatable.
3. Determine the customer code from the table below.
4. Fill out the repair sheet and return the repair sheet with the printer.

HP DeskJet Printer Family Customer Codes

Customer Code	Failure Keywords	Failure Description
STARTUP PROBLEMS		
CPS100	Power-Up Failed	No lights, no noise, no movement, power failure, dead
CPS105	Self-Test Failed	Self-test does not print or is incomplete/wrong
CPS110	Erratic/Intermittent Operation	Product behaves inconsistently or exhibits an intermittent failure
CPS200	Lights On Steady	LEDs on front panel ON steady
CPS205	Lights Flash in Unison	LEDs on front panel ON and flashing
CPS210	No Lights/Fan Only/No Lamp	No LEDs On or no LEDs and the fan is ON or lamp not on
CPS215	Lights Flashing Alternately	Different LED's flash On and Off alternately
QUALITY		
CWP000	Multiple Exchange	Customer has received more than one exchange per incident
CWP005	Customer Return	Customer returns exchanged unit
CWP010	Re-Repair 90 days	Unit fails within 90 days of previous repair
CWP015	Defective from Stock	Unit shipped to customer is defective from stock
CWP020	Customer Damaged	Customer/Reseller has damaged or mis-repaired unit
CWP025	Wrong Model	Wrong model or product sent to customer
PERFORMANCE		
CPG100	Won't Print	Printer will not print or locks up while printing
CPG105	Stops Printing	Prints part of a page then stops
CPP100	Burning Smell	During operation, unit emits a burning smell
CPN100	Grinding, Squeaking, Scraping Noise	Unusual, persistent grinding, squeaking, scraping noise
CPN105	Knocking, Clicking, Chattering Noise	Frequent shock or clicking or chattering noise

[Table continued on next page](#)

HP DeskJet Printer Family Customer Codes (Cont.)

Customer Code	Failure Keywords	Failure Description
MEDIA HANDLING		
CMM100	No Media Pick-Up	Paper/envelope/transparency not loading
CMM105	Multiple Pick	Several sheets/envelopes are picked together
CMM110	Incomplete Load	Sheet/envelope loads then stops or media slips
CMM115	Media Jams	Sheet/envelope/labels stuck inside of product/obstruction
CMM120	Skewed/Slanted Page	Sheet/envelope loads unevenly
CMM135	Media Eject Problem	Sheet/envelope fails to eject
CMM140	Continuous Media Feed	Continuously picks and feeds media
CMM150	Tracks on Media	Excessive force on pinch wheels causes tracks on media
PRINT/IMAGE QUALITY		
CGT100	Missing Dots	White line or streak through text or graphics, partial characters
CGT105	Fuzzy/Blurred/Wavy or Unusual Print	Overspray of dots or print appears wavy or compressed or faded
CGT110	Vertical Misalignment	Table columns of text/vertical lines are not well aligned (bi-directional shift)
CGT115	Underlines or Streaks in Printing	Prints extra lines across media when printing self-test
CGT120	Incomplete/Faded Print	Parts of printed characters are missing on self-test or print is faded
CGT125	Won't Print	Carriage moving but not printing
CGT130	Wrong Colors	Printing wrong colors or ink appears mixed
CPG115	Hardware Banding	Printed page exhibits banding in print not caused by the print cartridge

Table continued on next page

HP DeskJet Printer Family Customer Codes (Cont.)

Customer Code	Failure Keywords	Failure Description
CARRIAGE PROBLEMS		
CCP100	Left-Side Collision	Carriage slams to left side and stays there
CCP105	Right-Side Collision	Carriage slams to right side and stays there
CCP120	Erratic/Slow Movement	Erratic, slow movement or carriage stalls or hangs
CCP125	Pen Won't Lock	Pen cartridge won't lock in carriage
COMMUNICATION		
CKK100	I/O Port Fail	Serial or parallel Input/Output from PC fails to print...not cable or PC
CKK105	LAN/MIO Fail	Local Area Network communications failed
PRINT CARTRIDGE (PEN)		
CTT105	Leaking Pen	Print cartridge has leaked in printer and damaged printer
CTT110	Rejects Cartridge	Printer rejects cartridge or cartridge will not install properly
CTT120	Short Pen Life	Cartridge life not to specifications
MISCELLANEOUS		
CYD100	Loose/Damaged part	Broken, scratched, damaged or loose part
CZZ000	NTF	No trouble found

HP Printer Repair Sheet

Note To print this form, select "Print" under the "File" menu.

Company Information

Company name: _____

Address: _____

Phone number: _____

Your name: _____

Printer Information

Printer model: _____

Serial number: _____

Date of purchase: _____

Date that you are sending the printer: _____

Customer code: _____

Failure is:

Occasionally intermittent: ___

Frequently intermittent: ___

Continuous: ___

Brand and model of your computer: _____

Version of software you are using: _____

The driver you are using: _____

Other information about the problem: _____

Included Information

Check the following if able to provide additional troubleshooting information.

___ Sample printout included

___ Printer self-test included

___ Unable to print the printer self-test

___ Actions taken to resolve the problem and the results

MS Windows Printing

Microsoft Windows 3.1 comes with printer drivers that work with HP DeskJet printers. However, the Microsoft Printer Drivers do not provide access to the many of the more advanced capabilities of HP DeskJet 600 printer.

Only the HP ColorSmart Printer Driver software, part of the HP Printing System for Windows, takes advantage of all the features of HP DeskJet 600 printer.

The HP ColorSmart Printer Driver software is compatible with Microsoft Windows 3.1. Access to the printer driver to change specific settings is available from each software application program. The steps to access the printer driver will vary depending on the software program. Generally, the printer driver is found under a "print" menu in the software program.

The user can also access the printer driver through the Microsoft Windows Printers control panel. The control panel allows the user to:

- Select the default printer from a list of loaded printer drivers.
- Add Microsoft printer drivers.
- Remove unneeded printer drivers.
- Set various printer options (which may be superseded by the printer settings selected in the software application program).
- Confirm the port which the printer is using.

To open the Printers control panel:

1. Double-click **Main** in the Program Manager.
2. Double-click **Control Panel**.
3. Double-click **Printers**.

The default printer is listed in the text box at the top of the dialog box. To select a different default printer, double-click a printer from the list of installed printers.

Although the Printers control panel provides access to various printer settings, like paper type and page orientation, these settings are overridden by settings made from within an application. The Printers control panel settings are used when an application does not specify certain defaults.

Because the user can connect their printer to either an LPT or COM port, it is important to make sure the proper port was selected to avoid problems. The steps below identify how to select/change a printer port from the control panel.

To select a port:

1. Open the **Printers** control panel.
2. Click **Connect**.
3. Select the port from the list.

The default printer name is followed by the name of the port it is connected to.

Microsoft Windows 3.1 comes with printer drivers that work with HP DeskJet printers. However the Microsoft Printer Drivers do not provide access to the many of the more advanced capabilities of HP DeskJet printers. Only the HP DeskJet 600 Printer Driver software, part of the HP Printing System for Windows, takes advantage of all the features of the HP DeskJet 600 Printer.

HP Printing System for Windows

The HP Printing System for Windows includes:

- HP ColorSmart Printer Driver
- HP DeskJet Status Monitor
- HP DeskJet Utilities program group
- 14 TrueType Fonts
- Quick Tour (available during installation only)
- HP DeskJet Control Panel for DOS

The HP DeskJet Status Monitor allows you to:

- Monitor a current print job
- Monitor the printer's status at any time
- Print a self-test page
- Clean the print cartridge
- Cancel the current print job

The DeskJet Utilities include:

- Online information about the HP DeskJet 600 printer. To access the online information: click **Help** in the ColorSmart dialog box or the ColorSmart Options dialog box, or double-click the HP DeskJet 600 Printer Information icon in the HP DeskJet Utilities program group in the Program Manager.
 - Dr. DeskJet diagnostic program, which contains detailed information about common printing problems and easy to understand solutions. To access Dr. DeskJet: click **Dr.DeskJet** in the Online Information, or double-click the Dr. DeskJet icon in the HP DeskJet Utilities program group in the Program Manager.
 - Late-breaking release notes in the ReadMe.txt file.
-

Installing the Printer Driver

The minimum system requirements to run the HP Printing System for Windows are:

- Windows version 3.1
- An 80386 processor
- 2 MB of RAM to print in black or 4 MB of RAM to print in color
- 10 MB free hard disk space

Before you install the printer software:

1. Unpack the printer and set it up.
2. Make sure the computer and the printer are both turned on and connected with the proper cable.
3. Close any screen savers or other software running in the background on your computer.

To install the HP Printing System for Windows

1. Insert Installation Disk 1 into the disk drive.
2. Click **File** in the menu bar of the **Program Manager** window.
3. Choose **Run** in the **File** menu to open the Run dialog box.
4. Type **A:\SETUP** or **B:\SETUP** (depending on the computer's configuration) in the text box and click **OK**.
5. Follow the on-screen instructions during the installation process and provide appropriate computer system information
6. Restart Windows to activate the HP DeskJet 600 Printer Driver.

About the Printer Driver

The HP ColorSmart Printer driver software provides access to all the capabilities of the HP DeskJet 600 printer, when used with a Windows application. The following options are available from the ColorSmart dialog box:

- Automatic or Manual printing
- Color or Grayscale printing
- Best, Normal, or EconoFast print quality
- Paper Type
- Paper Size
- Number of Copies
- Ordered printing
- Portrait or Landscape print orientation

The HP ColorSmart Printer Driver has built-in, context-sensitive help. When an option in the dialog box is clicked, an explanation of that option appears at the bottom of the dialog box. For more detailed help, click the **Help** button in the ColorSmart dialog box.

Using the Printer Driver

To use the ColorSmart Printer Driver with the HP DeskJet 600 printer from within a Windows application:

1. Choose **Print** (or **Print Setup**, depending on the application) from the **File** menu.
2. Click the **Setup** button.

To use the ColorSmart Printer Driver with the HP DeskJet 600 printer from the Windows Control Panel:

1. Double-click **Main** in the Program Manager window.
2. Double-click **Control Panel**.
3. Double-click **Printers**.
4. Select the **HP DeskJet 600** printer in the Installed Printers list and click the **Setup** button.

The ColorSmart Dialog box appears.

ColorSmart Printer Driver Dialog Box

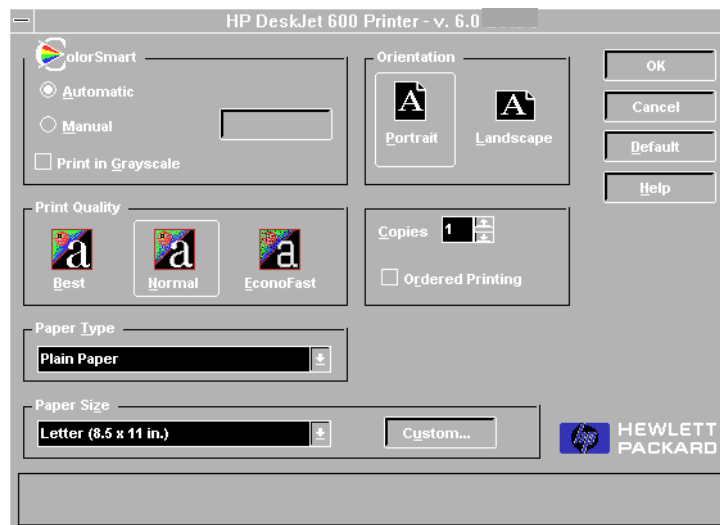

HP DeskJet 600 ColorSmart Dialog Box Options

Option	Description
Orientation	Portrait (tall) or landscape (wide).
Print Quality	Best (presentation quality), Normal (letter quality), or EconoFast (draft quality).
Copies	Set the number of copies to be printed. Click the Ordered Printing box to collate the printed pages of multiple copies.
Paper Type	The media may be either plain paper, one of HP's special media types, or transparency film.
Paper Size	The pop-up menu displays selections supported by the printer. Click the Custom button to specify a custom paper size.
OK	Accept changes.
Cancel	Cancel changes.
Default	Save the current settings as the default settings for the ColorSmart Dialog Box.
Help	Open the HP DeskJet 600 Printer online help.

Optimizing Performance

The print speed and overall performance of the HP DeskJet 600 printer can be affected by several things:

- The amount of RAM can determine how fast documents are sent to the printer. Increasing RAM can speed up this process as well as make the computer work more efficiently at other things besides printing.
- The printer driver used to print documents can make a significant difference in the quality of the printed output. Make sure an up-to-date version of an HP printer driver designed specifically for the HP DeskJet 600 printer is installed. To check this:
 1. Double-click the **Printers** icon in the Windows Control Panel.
 2. Select the HP DeskJet 600 printer in the **Installed Printers** list.
 3. Click **Setup** to check the version number. The version number is located in the title bar of the HP ColorSmart dialog box.
- The size and complexity of the documents printed can make a difference in the printer's performance. Graphics are usually more complex - especially color graphics - and print more slowly than text.
- The processing speed of the computer will determine how fast a document is sent to the printer. For example, a computer with a 486 processor runs faster than a computer with a 386 or a 286 processor.
- Running numerous software programs at one time slows down printing; each open program uses RAM. Therefore, limit the number of programs or documents open at one time.
- Screen fonts are stored in RAM, which means they use up memory that the printer may need in order to print. Delete screen fonts or printer fonts that are not needed.

Using Online Help

Two types of online help provide information about the printer software.

Printer Software Help

Type of help	Provides	How to access/where to find
Context Sensitive Help	Information about options in the dialog box when you click on certain parts of the screen.	Available within the ColorSmart Printer Driver dialog box.
Online Help	Comprehensive information about the printer software and hardware.	Click the Help button within the ColorSmart Printer Driver dialog box.
ReadMe Files	Release notes and current information.	On the Driver Installation Disk.

DOS Printing

Printer Drivers Available

Since DOS applications are developed independently under different standards, each DOS application requires its own printer driver. Current software drivers for most HP DeskJet printers are available from the individual software manufacturers. A list of DOS software developer contact information is in the DOS Printing Guide, part of the User's Guide Kit. Information on installing a DOS printer driver for a particular DOS application is supplied by the software manufacturer.

If there is no driver available for the DeskJet 600 printer, use a driver for a different HP DeskJet printer. In some cases, the substitute driver does not provide access to all of the DeskJet 600's capabilities. The following table outlines usable drivers and their capabilities when used with the DeskJet 600.

Substituting Printer Drivers

Printer Driver	Supported Features
HP DeskJet 600	Color Printing
HP DeskJet 540	Color Printing
HP DeskJet 560C	Color Printing
HP DeskJet 520	Color Printing
HP DeskJet 550C	Color Printing
HP DeskJet 500C	Color Printing
HP DeskJet 510	Monochrome Printing Only
HP DeskJet 500	Monochrome Printing Only

DeskJet Control Panel for DOS

The DeskJet Control Panel for DOS is software that replaces the front panel switches found on older printers. The Control Panel for DOS does not replace printer drivers; it must be used along with DOS software printer drivers. When there is no specific DeskJet 600 printer driver available for an application, the Control Panel for DOS gives the user access to print settings and features not available through the DOS application. If settings are available in the DOS application printer driver and the Control Panel for DOS, the settings made in the DOS application usually override those made in the Control Panel for DOS.

The Control Panel for DOS also lets the user monitor the printer's status, and clean and align the print cartridges.

Minimum System Requirements

- DOS version 3.3 (or newer)
- An 80286 (or better) processor
- 2 MB of RAM to print in black or 4 MB of RAM to print in color

Installation

Before you install the DOS control panel:

1. Unpack the printer and set it up.
2. Make sure the computer and the printer are both turned on and connected with the proper cable.

To install the DOS control panel:

1. Insert disk containing the Control Panel for DOS software into the disk drive.
2. At the DOS prompt, type **A:\Install** (or **B:\Install** depending on the floppy drive configuration) and press Enter.
3. Follow the on-screen instructions.

After installing the software, the print cartridges need to be aligned before beginning any print jobs.

To align the print cartridges:

1. Type **DJCP** at the DOS prompt to open the stand-alone Control Panel for DOS.
2. Select Align Print Cartridges and follow the on-screen instructions.

Two Ways to Use the Control Panel

The DOS Control Panel can run either as a stand-alone application or as a memory resident application. To run the DOS Control Panel as a stand alone application: type **DJCP** at the DOS prompt.

The DOS Control Panel must be loaded into memory at start-up to work as a memory resident application.

To set up the Control Panel for DOS as a memory resident application:

1. Type **DJCP** at the DOS prompt to open the stand-alone DOS Control Panel.
2. Select **More Settings**.
3. Select **Memory Resident Functions**.
4. Select **Make Memory Resident**.
5. Select **Done** and reboot the computer.

To open the memory resident Control Panel for DOS: type the DOS Control Panel hot key.

The memory resident Control Panel for DOS is a subset of the stand-alone application due to memory considerations.

Memory Resident DOS Control Panel

Whether stand-alone or memory resident, the DOS Control Panel allows the user to control or view the following:

- Pen Services (clean, prime, and align the pens)
- Print Quality
- Page Orientation
- Font Width (normal or compressed)
- Status Reports (limited in the resident DOS Control Panel)
- Context-Sensitive Help

In addition to these, the stand-alone DOS Control Panel provides access to:

- Paper Size
- Media Type (paper or transparencies)
- Character Set
- Lines per Page
- Line Termination
- Reset All Settings
- Memory Resident Controls

OS/2

The HP ColorSmart printer driver for the HP DeskJet 600 printer can be accessed through OS/2 by using Windows 3.1 in OS/2.

The Printing System

Printing systems contain hardware and software components which must work together properly before printing can take place. The printer driver provides the interface between the software applications that support printing, the computer's hardware, and the printer. The basic printing system consists of the following:

1. Host computer (PC or Macintosh)
2. Application software (word processing, graphics design, desktop publishing, etc.)
3. Printer driver (specific to your printer and, in some cases, your application software)
4. Printer cable
5. Printer (HP DeskJet or DeskWriter)
6. The paper or other media upon which printing will take place

Note Printing systems in networks may contain a somewhat different configuration of hardware and software.

HP ColorSmart printer drivers not only provide the hardware/software interface, but also allow bi-directional communication between the printer and the computer. Bi-directional communication allows printing information to flow from the computer to the printer, and printer status and error information to flow back from the printer to the computer.

Resolving Printing System Problems

Many printer problems and their solutions are reported in error messages that appear on the computer's screen. When one of these messages is received, follow the instructions given. Check the HP DeskJet Status Monitor (MS Windows users) or the Print Monitor (Macintosh) for information on the current status of the printer.

If you haven't received an error message on the computer's screen but have noted a problem with your printer, read through the troubleshooting topics that follow to find one that matches your printer's symptoms.

Troubleshooting Hints

The table below describes DeskJet and DeskWriter printing system problems along with their causes and solutions.

Note To save time diagnosing printing system problems, the Possible Cause column in the table below is given with the most likely cause listed first. If the printing system does not respond correctly after trying the first solution, proceed the next, etc.

Printing System Problems, Causes and Solutions

Problem	Possible Cause	Solution
Printer does not print. (Power light on, Form Feed light off)	The printer driver is still preparing data to send to the printer.	Wait a few minutes. Some computers take several minutes of processing time before sending any data to the printer.
	The interface connection or the interface cable has failed.	<ol style="list-style-type: none"> 1. Verify the interface cable is an approved interface cable. (Must conform to IEEE 1284-B standards) 2. The interface cable may be faulty. Check the interface cable connections or try another interface cable. 3. Wrong interface connection. For example, the printer is connected to the serial port (e.g. COM1) rather than a parallel interface port.
	Failure of the host computer.	<ol style="list-style-type: none"> 1. Verify the host is operating correctly by printing to another printer. 2. The computer-to-printer connection has failed. Unplug the printer from the host computer and try printing a self-test. If the self-test prints OK, verify the host computer and interface cable are functional by printing to a different printer using the same printer port and printer cable.
	The problem is caused by TSR programs or the application software.	<ol style="list-style-type: none"> 1. Close (or "rem-out") any screen saver or other TSR (Terminate Stay Resident) software programs (such as MacDisk) that are open and running in the background. Restart your computer. 2. Your software program is not set up for the printer. Follow the instructions in your software program manual for setting up the software to run with the printer.

[Continued on next page](#)

Printing System Problems, Causes and Solutions (Cont.)

Problem	Possible Cause	Solution
Printer does not print. (Cont.) (Power light is on, the Form Feed light is off)	The wrong printer is selected	(MS Windows) Open the Printers dialog box in the MS Windows Control Panel and verify that the correct printer is selected. (An on-screen message may ask you to open Page Setup in your application.) (Macintosh) Open the Chooser, select the correct printer, and close the Chooser. (An on-screen message may ask you to open Page Setup in your application.)
	The problem is caused by the printer driver.	It may be necessary to reinstall the printer driver software using the instructions from the setup card.
	The printer's name does not appear in the Installed Printers list in the Printers dialog box in the MS Windows Control Panel.	<ol style="list-style-type: none"> 1. Close all TSRs (screen savers and other software that runs in the background). 2. Exit and then restart MS Windows. 3. Verify all TSRs remained closed. 4. Reinstall the printer driver using the instructions from the setup card.
	The problem is caused by the application software or the printer driver.	<ol style="list-style-type: none"> 1. Restart Windows and print the self-test from the HP Toolbox. 2. Verify the proper printer driver and parallel port are selected. The printer driver's name should appear in the Installed Printers dialog box. 3. Close any screen saver or other TSR (Terminate Stay Resident) software programs that are open and running in the background. Restart your computer. 4. It may be necessary to reinstall the printer driver software using the instructions from the setup card. 5. Your software program is not set up for the printer. Follow the instructions in your software program manual for setting up the software to run with the printer.

Continued on next page

Printing System Problems, Causes and Solutions (Cont.)

Problem	Possible Cause	Solution
The printer does not print. (All lights are blinking)	The printer-to-computer connection failed.	<ol style="list-style-type: none"> 1. Switch off the printer, disconnect the printer cable, switch the printer on. 2. If the Power light comes on and the Form Feed light remain off, print a sample page. 3. If the sample page prints, the printer is not the problem. 4. Reconnect the printer cable and re-send the file. 5. If the problem persists, the problem may be with the printer cable, the cable connections, or the computer port. (First, try another printer cable.)
	The printer has failed.	<ol style="list-style-type: none"> 1. Switch off the printer, disconnect the printer cable, switch the printer on. 2. If all lights begin blinking again, the printer is faulty.
The printout contains garbled or strange text characters (such as hearts or smiling faces), or contains distorted graphic images.	The wrong printer may be selected.	Verify that the proper printer driver is selected. The printer driver's name should appear in the installed printer's dialog box (MS Windows) or the Chooser menu (Macintosh).
	The printer-to-computer connection failed.	<ol style="list-style-type: none"> 1. Switch off the printer, disconnect the printer cable, and switch the printer on. 2. Print a self-test (or demo) page. 3. If the self-test page prints, the printer is not the problem. 4. Reconnect the printer cable and re-send the file to the printer. 5. If the printout is still garbled, the problem may be with the printer cable, the cable connections, or the computer host. Try another printer cable. Try a different computer.
The paper does not eject from the printer.	The printer did not receive a form-feed command.	If the software does not send automatic form-feed commands, press the Form Feed key on the printer to initiate a manual form-feed.

Continued on next page

Printing System Problems, Causes and Solutions (Cont.)

Problem	Possible Cause	Solution
The colors in the printout do not match the colors on the host computer's monitor.	The printer driver settings may not be correct for your monitor.	Verify that your print cartridges are at room temperature and have plenty of ink, then try the following: <ol style="list-style-type: none">1. Verify that Complex Color Printing or Color Match option is selected in the Options menu of the Printer Setup menu.2. Try a different dithering method. See the "User's Guide" for your printer for dithering recommendations.
The printout contains faint or fuzzy print.	The printer driver settings, the pens, or the selected media may be faulty.	Verify the print cartridges are at room temperature, and have plenty of ink. Verify that the print settings are appropriate for the media selected. Make sure the correct print settings are selected in the printer driver. (The printer driver settings should appear in the Installed Printers dialog box.)

Printer Troubleshooting Hints

Troubleshooting Tools

The following table lists the tools needed for general printer maintenance.

Recommended Troubleshooting Tools and Supplies

Tool	Purpose
Tissue	Print Cartridge Cleaning Operations.
Lint -free cloth	Cleaning the Printer and the Print Cartridge Contacts.
Computer vacuum	Loosening and removing paper dust and other particulate matter from the interior of the printer.
Distilled water	Used for all cleaning purposes requiring water.

HP Toolbox (MS Windows Users)

HP Toolbox helps you diagnose and solve common printing problems. To access HP Toolbox, double-click the Toolbox icon in the HP DeskJet Utilities program group. Then follow the symptoms and solutions that apply.

Note Instead of the HP Toolbox, earlier versions of MS Windows printer drivers used Dr. DeskJet which performed similar functions. To access Dr. DeskJet, double-click the Dr. DeskJet icon in the HP DeskJet Utilities program group. Then follow the symptoms and solutions that apply.

Troubleshooting Flowcharts

Troubleshooting Flowcharts - Power-On Section

See "EX" and "EZ" See "CSP200"

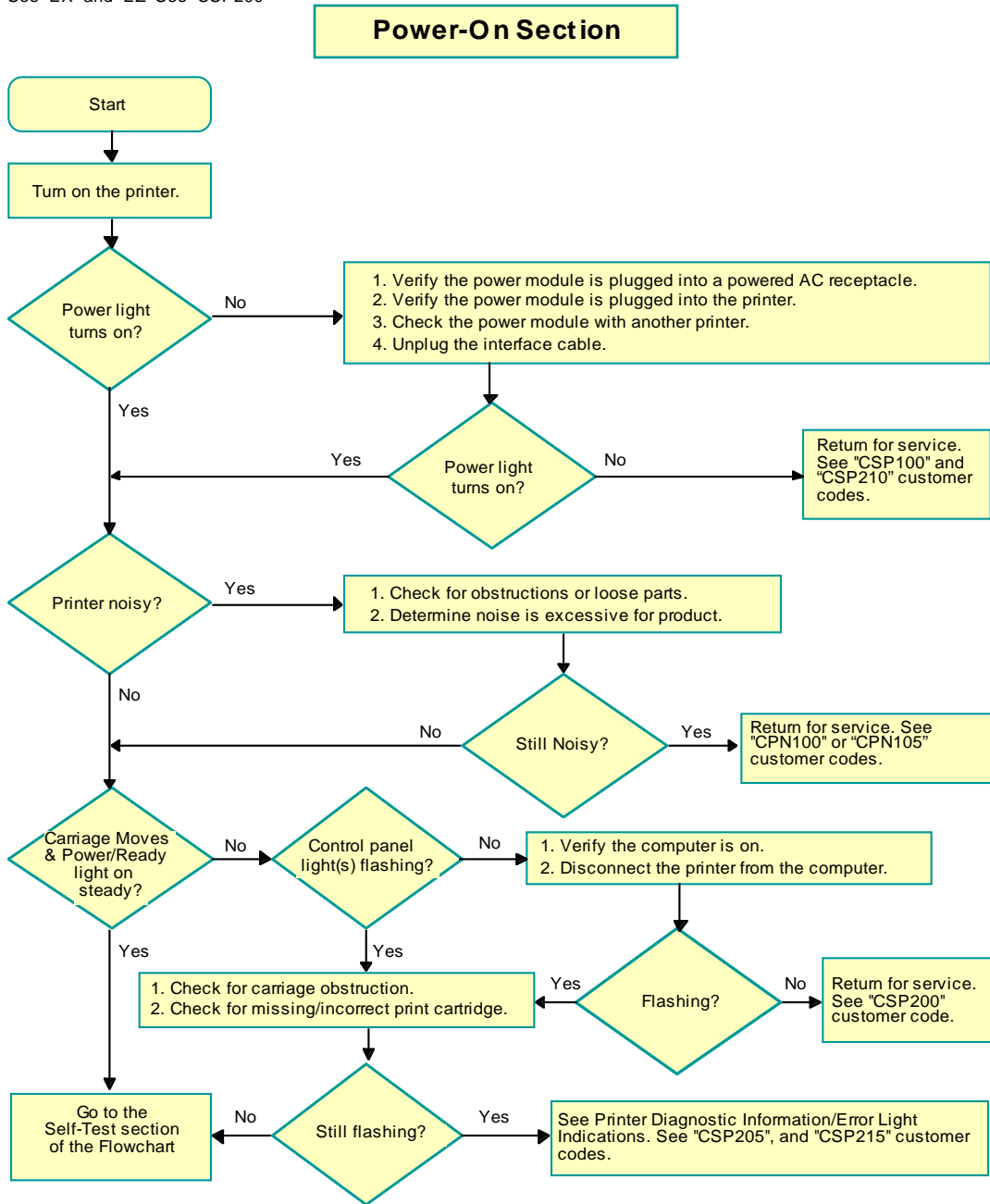

Troubleshooting Flowcharts - Self-Test Section

Self-Test Section

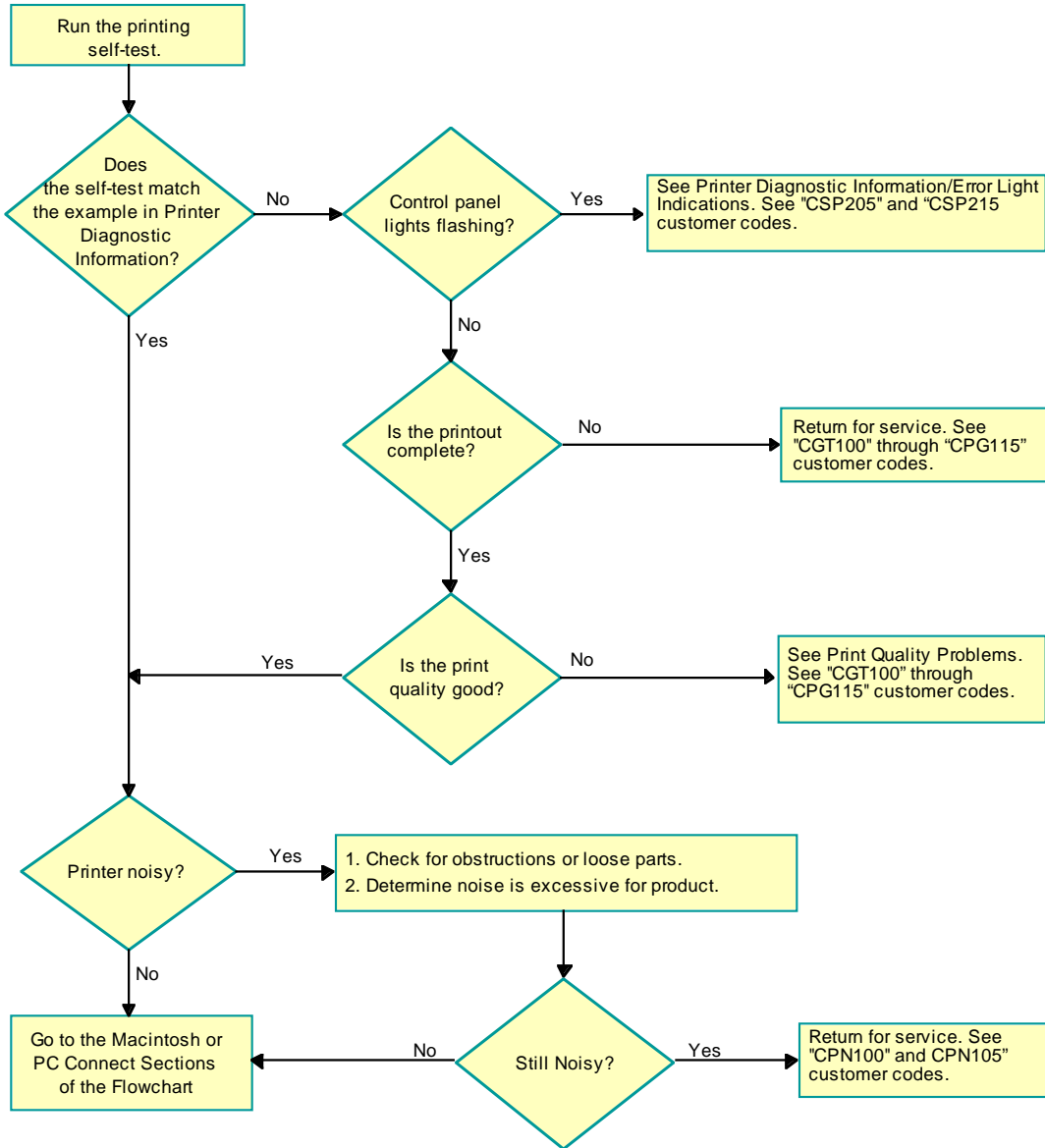

Troubleshooting Flowcharts - PC Connect Section

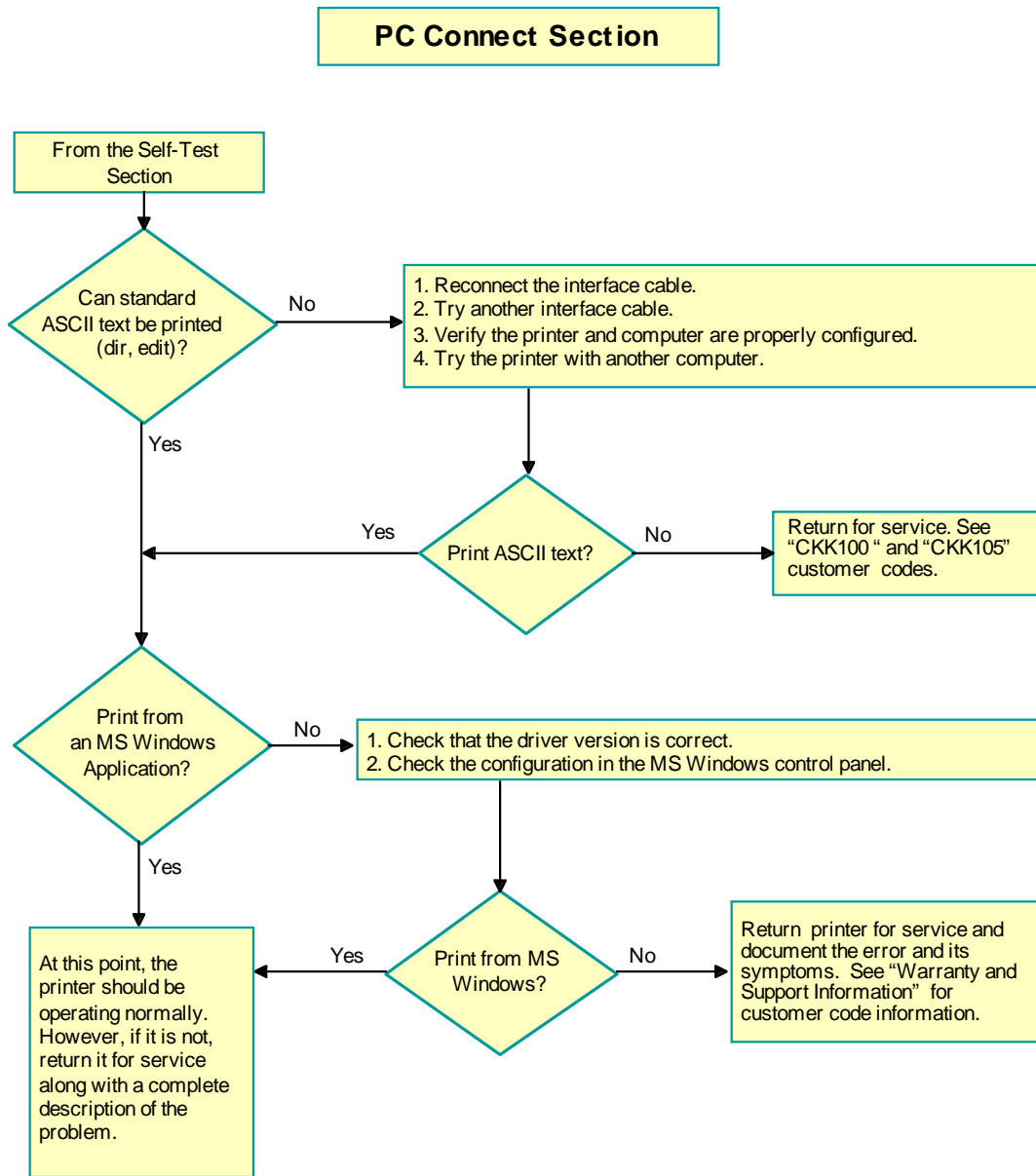

Troubleshooting Flowcharts - Macintosh Connect Section

Macintosh Connect Section

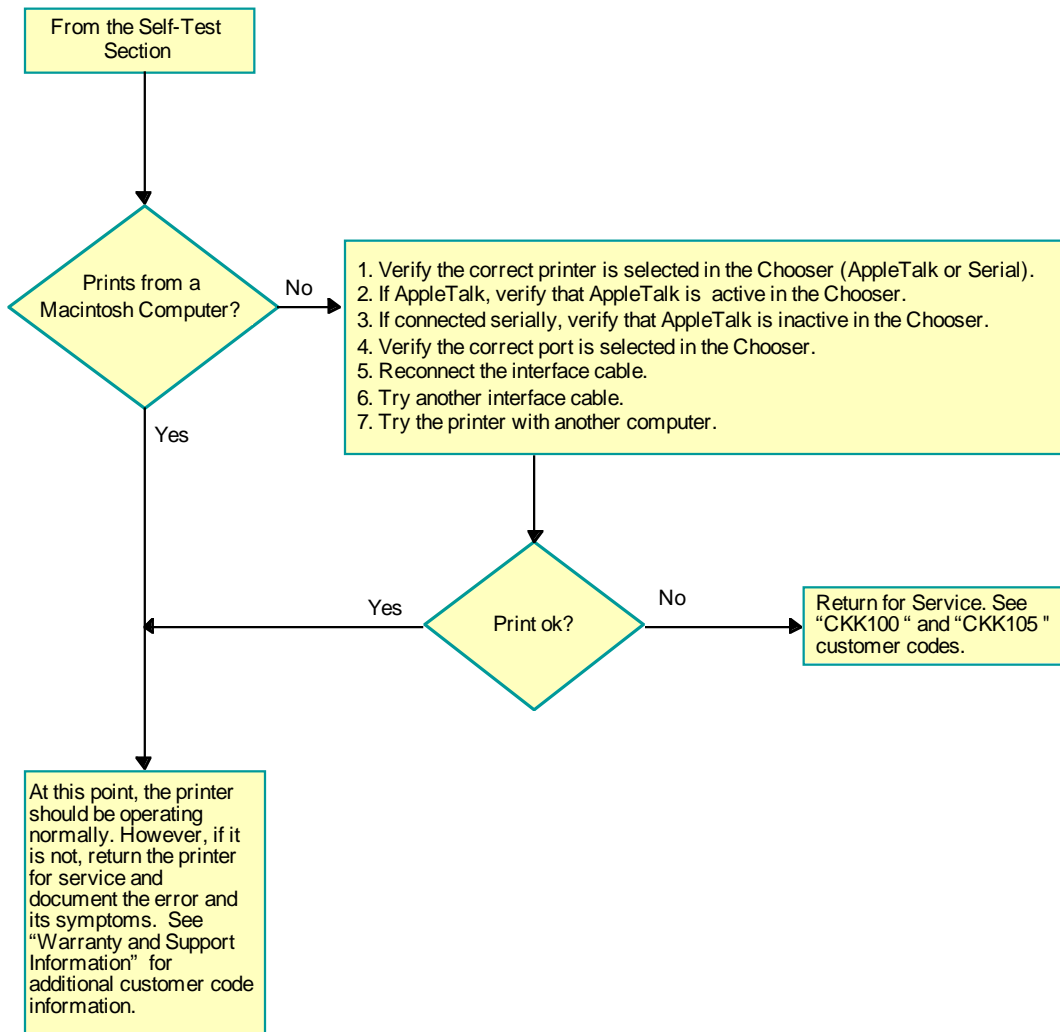

Macintosh Troubleshooting

Note HP periodically provides updates of the printer software. These updates may include enhancements that improve printer performance.

Problems and Solutions

Problem	Solution
Printer won't print	Open the Chooser and verify that the correct printer is selected.
Printer icon does not appear on the left side of the Chooser.	Make sure that the printer is turned on. Make sure that the printer driver icon is in the Extensions Folder.
The printer name does not appear on the right side of the Chooser or the HP DeskWriter family printer is not listed.	Make sure the printer is turned on. Open the Chooser and make sure AppleTalk is active.
Power light is On, the Resume light is Off.	Check that the correct printer is in the Chooser, then close all applications and restart. If this doesn't work it may be necessary to reinstall the printer driver software.

HP DeskJet Printers

Cable and Connector Information

Recommended Interface Cables

Host Interface	HP Cable Part Number	Cable Length	Cable Connectors
HP IEEE-1284 Compliant Cable	C2950A	2 Meters	DB-25 Male to 36-Pin Centronics Male
HP IEEE-1284 Compliant Cable	C2951A	3 Meters	DB-25 Male to 36-Pin Centronics Male

Interface Specifications

HP DeskJet printers communicate with computers through a single IEEE1284-B parallel I/O interface connector. For more information about interface connection and operation, see "DOS I/O Interface Description."

Communication Modes and Supported Protocols

Category	Specification
Interface Protocol	IEEE-1284 Compatible
Communication Modes Available	Compatible (Centronics) Nibble ECP

IEEE-1284 Interface Connector

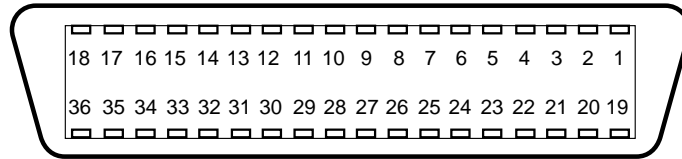

2162989

IEEE-1284 Interface Port (DOS/MS Windows)

Pin Number	Source	Compatibility Mode	Nibble Mode	ECP Mode
1	Host	nStrobe	HostClk	HostClk
2	Bi-Directional		Data 1 (LSB)	
3	Bi-Directional		Data 2	
4	Bi-Directional		Data 3	
5	Bi-Directional		Data 4	
6	Bi-Directional		Data 5	
7	Bi-Directional		Data 6	
8	Bi-Directional		Data 7	
9	Bi-Directional		Data 8	
10	Bi-Directional	nAck	PrtClk	PeriphClk
11	Bi-Directional	Busy	PrtBusy	PeriphAck
12	Bi-Directional	PError	AckDataReq	nAckReverse
13	Bi-Directional	Select	Xflag	Xflag
14	Host	nAutoFd	HostBusy	HostAck
15				

Continued on next page

IEEE-1284 Interface Port (DOS/MS Windows) (Cont.)

Pin Number	Source	Compatibility Mode	Nibble Mode	ECP Mode
16			Logic Gnd	
17			Chassis Gnd	
18	Peripheral		Peripheral Logic High	
19			Signal Ground (nStrobe)	
20			Signal Ground (Data 1)	
21			Signal Ground (Data 2)	
22			Signal Ground (Data 3)	
23			Signal Ground (Data 4)	
24			Signal Ground (Data 5)	
25			Signal Ground (Data 6)	
26			Signal Ground (Data 7)	
27			Signal Ground (Data 8)	
28			Signal Ground (Perror, Select, nAck)	
29			Signal Ground (Busy, nFault)	
30			Signal Ground (nAuto Fd, nSelectLn, nInit)	
31	Host	nInit	nInit	nReverseRequest
32	Peripheral	nFault	nDataAvail	nPeriphRequest
36	Host	nSelectLn	1284 Active	1284 Active

DOS I/O Interface Description

The IEEE-1284 standard defines a signaling method for bi-directional parallel communications between hosts and printers or other peripheral devices. This standard provides improved performance and bi-directional (two-way) communication, allowing a new generation of "intelligent" peripherals to talk and listen to the host device.

HP DeskJet printers have an IEEE 1284-B parallel I/O interface connector. This interface adheres to the IEEE 1284-B parallel interface standard which was derived from the earlier "Centronics®" interface. Firmware in HP DeskJet printers support the following modes of operation through the IEEE 1284-B parallel interface port:

- Compatibility Mode
- Nibble Mode
- Extended Capabilities Port (ECP) mode

Printer drivers on host computers "negotiate" with the printer to switch from one mode to another. If an error occurs while in Nibble or ECP mode, the interface automatically reverts to Compatibility mode.

HP DeskJet printer drivers meet the IEEE 1284-B standard for Level 1 devices. Input receivers meet the standard for Level 2 devices. This allows HP DeskJet printers to be connected to either a Level 1 or Level 2 host.

Level 1 devices drive the interface with 5 V TTL circuits. Their requirements are consistent with pre-existing installed devices and they can operate with any other Level 1 compliant device. Level 1 devices are characterized by steady-state electrical specifications.

Level 2 devices use output drivers with 45-55 ohms output impedance and TTL receivers with 0.2 V- 1.2 V hysteresis. Level 2 devices capitalize on the transmission-line characteristics of the connecting cable, providing faster data transmission.

Compatibility Mode

Compatibility mode is a unidirectional mode of operation in which data flows from the host computer to the printer. It is the mode that has, in the past, been called "Centronics."



Nibble Mode

Nibble mode is a unidirectional mode of operation in which data moves from the printer to the host computer. HP DeskJet printers and most computer hosts can operate in nibble mode. Hosts can switch back and forth between compatibility and nibble modes, thus establishing limited two-way (bi-directional) communication. The host must place itself and the printer into nibble mode to receive status from the printer. This type of bi-directional communication has previously been called "Bitronics."

ECP Mode

ECP mode provides a true bi-directional link between the printer and the host computer. HP DeskJet printers and most computer hosts can operate in ECP mode. ECP mode, combined with the HP proprietary communication protocol, allows the Remote Control Panel for DOS and the HP DeskJet Status Monitor for MS Windows to receive and display status information from the printer.



HP DeskWriter Printers

Cable and Connector Information

Recommended Interface Cables

Cable Type	HP Cable Part Number	Apple Cable Part Number
AppleTalk Network	92215N	M2068
RS-422-A High-Speed Clocked Serial	92215S	M0197

Interface Specifications

HP DeskWriter printers have an 8-pin mini-DIN interface connector port. This connector port is compatible with RS-422-A serial, AppleTalk, and high-speed externally-clocked serial mode communication. The printer automatically determines if it is connected to an AppleTalk network or directly to a Macintosh printer port.

Communication Modes and Supported Protocols

Category	Macintosh I/O Connector
Communication Modes	RS-422-A High-speed Serial
	AppleTalk (230.4 Kbaud)
Macintosh Protocols	Serial Pacing Protocol (SPP)
	AppleTalk Transaction Protocol (ATP)
	AppleTalk Link Access Protocol (ALAP)
	Datagram Delivery Protocol (DDP)
	Echo Protocol (EP)
	Name Binding Protocol (NBP)
	Printer Access Protocol (PAP)
Routing Table Maintenance Protocol (RTMP)	

RS-422 Interface Connector (8-pin Mini-DIN)

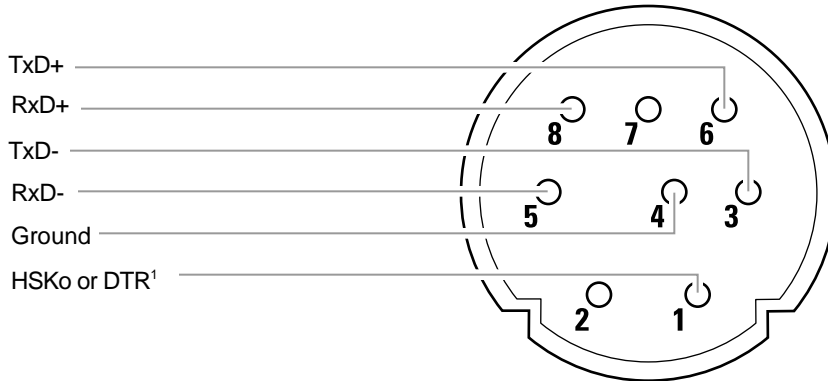

2124073

RS-422 Interface Port (AppleTalk)

Pin Number	Interface Pin Name	Interface Pine Description
1	DTR	Data Terminal Ready Output Handshake
2	NC	No Connection in Printer (Do not connect to ground or any other pin)
3	TxD-	Transmit Data Line
4	Ground	Shield Ground
5	RxD-	Receive Data Line
6	TxD+	Transmit Data Line
7	NC	No Connection
8	RxD+	Receive Data Line

Note HP DeskWriter printer interface ports conform to RS-422 and cannot be configured to operate as RS-232-C.

Mac I/O Description

HP DeskWriter printers detect and monitor which interface mode (serial or LocalTalk) is present, and automatically switch to the appropriate protocol. The printers determine if they are connected to a LocalTalk node by detecting the presence or absence of a transformer at the interface connector port. (A transformer detected at the interface connector indicates the printer is connected to an LocalTalk network.) If the mode changes while the printer is on, the printer restarts.

HP DeskWriter printers are compatible with two Macintosh serial interface modes:

- RS-422-A (57.6 Kbaud)
- Clocked

RS-422-A signals are modulated against an inverted copy of the modulated signal (for example RxD- and RxD+). Data communication occurs by sensing which line is more negative than the other. Sensing line polarity in respect to an inverted signal is more immune to interference and noise than to a signal compared to a common ground. The signal is also less likely to degrade over longer cable distances.

If a serial connection is made and "clocked" mode is detected, the printer switches from DTR mode (the default at power-up) to SPP mode. The printer selects a frequency for the clocking and clocks the DTR line at that frequency.

In AppleTalk mode, the printer receives data in a synchronous serial bit stream at 230.4 K bits per second and converts the data to parallel.

Note The Macintosh I/O connector is RS-422-A compatible. It is not possible to use this port as an RS-232-C serial interface port.

Free Manuals Download Website

<http://myh66.com>

<http://usermanuals.us>

<http://www.somanuals.com>

<http://www.4manuals.cc>

<http://www.manual-lib.com>

<http://www.404manual.com>

<http://www.luxmanual.com>

<http://aubethermostatmanual.com>

Golf course search by state

<http://golfingnear.com>

Email search by domain

<http://emailbydomain.com>

Auto manuals search

<http://auto.somanuals.com>

TV manuals search

<http://tv.somanuals.com>