



HEWLETT
PACKARD

MODEL 3314A FUNCTION GENERATOR

SERIAL NUMBERS

This manual applies directly to instruments with serial numbers prefixed 2734A.

With changes described in Section VII, this manual also applies to instruments with serial numbers prefixed 2141A and 2505A.

For additional important information about serial numbers, see **MANUAL AND INSTRUMENT IDENTIFICATION** in Section I.

Manual Part No. 03314-90025
Microfiche Part No. 03314-90225

Copyright © 1982,1987, Hewlett-Packard Company
8600 Soper Hill Road, Everett, Washington 98205-1298 U.S.A.

Printed: September 1987

CERTIFICATION

Hewlett-Packard Company certifies that this product met its published specifications at the time of shipment from the factory. Hewlett-Packard further certifies that its calibration measurements are traceable to the United States National Bureau of Standards, to the extent allowed by the Bureau's calibration facility, and to the calibration facilities of other International Standards Organization members.

WARRANTY

This Hewlett-Packard product is warranted against defects in material and workmanship for a period of one year from date of shipment. During the warranty period, Hewlett-Packard Company will, at its option, either repair or replace products which prove to be defective.

For warranty service or repair, this product must be returned to a service facility designated by -hp-. Buyer shall prepay shipping charges to -hp- and -hp- shall pay shipping charges to return the product to Buyer. However, Buyer shall pay all shipping charges, duties, and taxes for products returned to -hp- from another country.

HP software and firmware products which are designated by HP for use with a hardware product, when properly installed on that hardware product, are warranted not to fail to execute their programming instructions due to defects in materials and workmanship. If HP receives notice of such defects during their warranty period, HP shall repair or replace software media and firmware which do not execute their programming instructions due to such defects. HP does not warrant that the operation of the software, firmware or hardware shall be uninterrupted or error free.

LIMITATION OF WARRANTY

The foregoing warranty shall not apply to defects resulting from improper or inadequate maintenance by Buyer, Buyer-supplied software or interfacing, unauthorized modification or misuse, operation outside of the environmental specifications for the product, or improper site preparation or maintenance.

NO OTHER WARRANTY IS EXPRESSED OR IMPLIED. HEWLETT-PACKARD SPECIFICALLY DISCLAIMS THE IMPLIED WARRANTIES OF MERCHANTABILITY AND FITNESS FOR A PARTICULAR PURPOSE.

EXCLUSIVE REMEDIES

THE REMEDIES PROVIDED HEREIN ARE BUYER'S SOLE AND EXCLUSIVE REMEDIES. HEWLETT-PACKARD SHALL NOT BE LIABLE FOR ANY DIRECT, INDIRECT, SPECIAL, INCIDENTAL, OR CONSEQUENTIAL DAMAGES, WHETHER BASED ON CONTRACT, TORT, OR ANY OTHER LEGAL THEORY.

ASSISTANCE

Product maintenance agreements and other customer assistance agreements are available for Hewlett-Packard products.

For any assistance, contact your nearest Hewlett-Packard Sales and Service Office. Addresses are provided at the back of this manual.

SAFETY SUMMARY

The following general safety precautions must be observed during all phases of operation, service, and repair of this instrument. Failure to comply with these precautions or with specific warnings elsewhere in this manual violates safety standards of design, manufacture, and intended use of the instrument. Hewlett-Packard Company assumes no liability for the customer's failure to comply with these requirements. This is a Safety Class 1 instrument.

GROUND THE INSTRUMENT

To minimize shock hazard, the instrument chassis and cabinet must be connected to an electrical ground. The instrument is equipped with a three-conductor ac power cable. The power cable must either be plugged into an approved three-contact electrical outlet or used with a three-contact to two-contact adapter with the grounding wire (green) firmly connected to an electrical ground (safety ground) at the power outlet. The power jack and mating plug of the power cable meet International Electrotechnical Commission (IEC) safety standards.

DO NOT OPERATE IN AN EXPLOSIVE ATMOSPHERE

Do not operate the instrument in the presence of flammable gases or fumes. Operation of any electrical instrument in such an environment constitutes a definite safety hazard.

KEEP AWAY FROM LIVE CIRCUITS

Operating personnel must not remove instrument covers. Component replacement and internal adjustments must be made by qualified maintenance personnel. Do not replace components with power cable connected. Under certain conditions, dangerous voltages may exist even with the power cable removed. To avoid injuries, always disconnect power and discharge circuits before touching them.

DO NOT SERVICE OR ADJUST ALONE

Do not attempt internal service or adjustment unless another person, capable of rendering first aid and resuscitation, is present.

DO NOT SUBSTITUTE PARTS OR MODIFY INSTRUMENT

Because of the danger of introducing additional hazards, do not install substitute parts or perform any unauthorized modification to the instrument. Return the instrument to a Hewlett-Packard Sales and Service Office for service and repair to ensure that safety features are maintained.

DANGEROUS PROCEDURE WARNINGS

Warnings, such as the example below, precede potentially dangerous procedures throughout this manual. Instructions contained in the warnings must be followed.

WARNING

Dangerous voltages, capable of causing death, are present in this instrument. Use extreme caution when handling, testing, and adjusting.

SAFETY SYMBOLS

General Definitions of Safety Symbols Used On Equipment or In Manuals.



Instruction manual symbol: the product will be marked with this symbol when it is necessary for the user to refer to the instruction manual in order to protect against damage to the instrument.



Indicates dangerous voltage (terminals fed from the interior by voltage exceeding 1000 volts must be so marked).

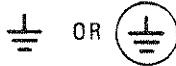

Protective conductor terminal. For protection against electrical shock in case of a fault. Used with field wiring terminals to indicate the terminal which must be connected to ground before operating equipment.



Low-noise or noiseless, clean ground (earth) terminal. Used for a signal common, as well as providing protection against electrical shock in case of a fault. A terminal marked with this symbol must be connected to ground in the manner described in the installation (operating) manual, and before operating the equipment.

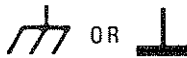

Frame or chassis terminal. A connection to the frame (chassis) of the equipment which normally includes all exposed metal structures.



Alternating current (power line).



Direct current (power line).



Alternating or direct current (power line).

WARNING

The WARNING sign denotes a hazard. It calls attention to a procedure, practice, condition or the like, which, if not correctly performed or adhered to, could result in injury or death to personnel.

CAUTION

The CAUTION sign denotes a hazard. It calls attention to an operating procedure, practice, condition or the like, which, if not correctly performed or adhered to, could result in damage to or destruction of part or all of the product.

NOTE :

The NOTE sign denotes important information. It calls attention to procedure, practice, condition or the like, which is essential to highlight.

SECTION 1

GENERAL INFORMATION

1-1. INTRODUCTION

This Service Manual contains information for Service-Trained personnel to install, test, adjust and service the Hewlett-Packard Model 3314A Function Generator. A front panel overview and the HP-IB Summary are also included; however, the Operating Manual should be used for detailed operating information.

1-2. MANUAL AND INSTRUMENT IDENTIFICATION

The -hp- part number for this manual and for a microfiche of this manual are located on the title page. Each 4 x 6 inch microfiche contains up to 96 photoduplicates of the Service Manual pages. The latest Manual Changes Supplement as well as Service Notes are also included in the microfiche.

Attached to the 3314A's rear panel is a serial number plate. $\Delta 8$

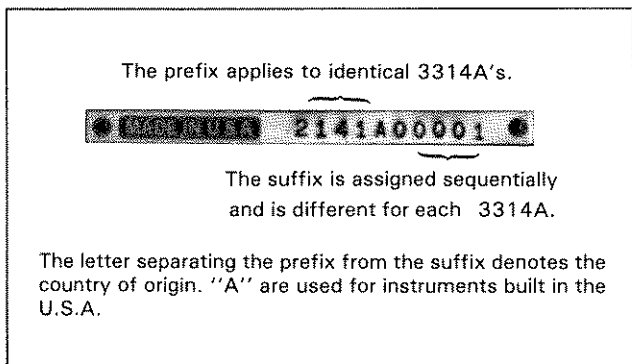

Figure 1-1. Serial Number Plate

The contents of this manual apply to instruments with the serial number prefix(es) listed under SERIAL NUMBERS on the title page. Changes made to instruments after the printing of this manual will be covered by a Manual Change Supplement. In addition to change information, a Manual Change Supplement may contain information correcting errors in this manual.

1-3. DESCRIPTION

The 3314A Function Generator is a multi-mode, programmable function generator. The 3314A features Sine, Triangle and Squarewave functions from 1mHz to

19.99MHz. In addition, the 3314A can be redefined as an ARbitrary Waveform Generator. ARB waveforms are made up of a series of voltage ramps called vectors. The operator has control over the number of vectors, the height and length of each vector. The operating modes include:

Free Run	Gate	N Cycle
CW	CW	1/2 Cycle
linear sweeps	linear sweeps	Fin X N
log sweeps	ARB	Fin ÷ N
ARB		

In addition, the 3314A has a programmable time interval for internal triggering. A trigger (either internal or external) is an important part of every operating mode except Free Run when not sweeping.

1-4. OPTIONS

The 3314A may be equipped with one or more of the following options:

- $\Delta 8$ Option 001, Simultaneous X3 Output
- Option 907, Front Handle Kit
- Option 908, Rack Mount Adapters
- Option 910, Extra Manual Set

Option 001 to the 3314A Function Generator is a low impedance, rear panel output. The X3 Output voltage is 3 times the voltage from the 3314A's Main 50 Ω Output. Note that the X3 Output is always active and that the voltage depends upon the selected amplitude and the Main Output's load. This output is DC coupled and is useable to 1 MHz.

1-5. SUPPLIED ACCESSORIES

Every 3314A is supplied with the following accessories:

- An Operating Manual
- A Service Manual
- A Power Cord
- A 50 Ω Feedthrough Termination

The power cord included with your 3314A was selected at the factory based upon the country of destination. If your power cord is incompatible with your AC mains outlet, contact your local -hp- Sales Office.

1-6. SPECIFICATIONS

The 3314A's specifications are listed in Table 1-1, Specifications. These specifications are the performance standards or limits against which every 3314A is tested.

Some of the 3314A's operating characteristics are listed in Table 1-2, Supplemental Characteristics. The Operating Manual contains detailed discussions of the remaining operating characteristics.

Table 1-1. Specifications

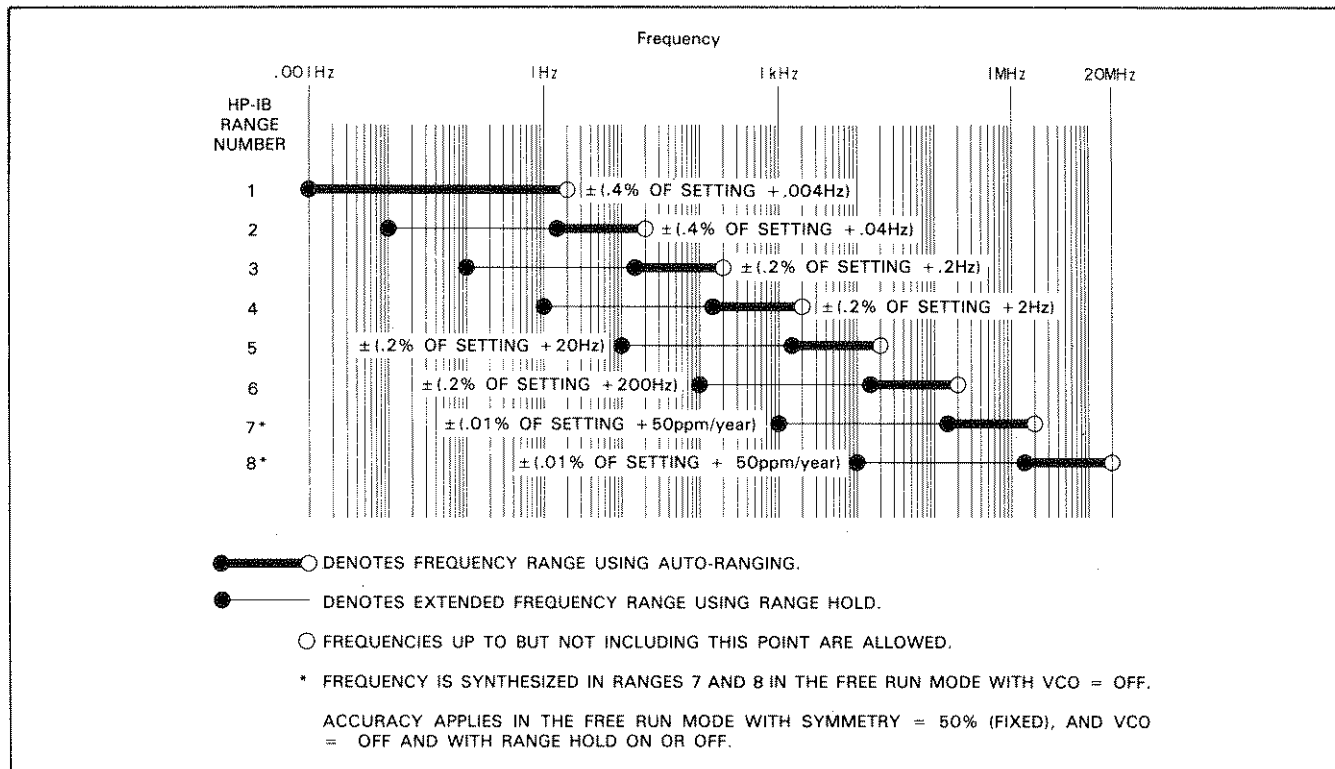

Amplitude

Absolute Amplitude Accuracy:

$\pm (1\% \text{ of display} + .035\text{Vp-p})$, sine wave and square wave
 $\pm (1\% \text{ of display} + .06\text{Vp-p})$, triangle

Amplitudes: 1.00Vp-p to 10.00Vp-p (Range 4)
 Frequency: 10kHz
 Auto-Range: ON

Flatness--sine wave:

Combines sine power flatness and vernier attenuator flatness
 Relative to 10kHz, 1.00 V to 10.00Vp-p (Range 4)

20Hz	50kHz	1MHz	19.99MHz
.07dB	.33dB	1.5dB	

Step Attenuator Accuracy:

	.001Hz	50kHz	19.99MHz
20dB	.05dB		.3dB
40dB			.5dB
60dB			

DC Offset

Offset Accuracy:

$\pm (3\% \text{ of display} + 10 \text{ mVDC} + 0.5\% \text{ of AC Amplitude Range})$

Frequency: < 100kHz
 Auto-Range: ON

Residual DC Offset:

$\pm 0.5\% \text{ of AC Amplitude Range}$
 If option 001:
 $\pm 0.5\% \text{ of AC Amplitude Range} \pm 500\mu\text{V}$

Setting: OVDC
 Frequency: $\leq 100\text{kHz}$

Symmetry

Symmetry Accuracy (Fixed):

$50\% \pm 0.2\%$

Fixed Symmetry: 50% (SYM light OFF)
 Frequency: 1Hz to 100kHz
 Function: square wave

Table 1-1. Specifications (Cont'd)

<p>Symmetry Accuracy (Variable)</p> <p>±0.5% of period:</p> <p>Frequency: 1Hz to 100kHz Function: square wave</p> <p>Phase</p> <p>Phase Offset--Phase lock Modes</p> <p>Accuracy: ±2° (50Hz to 25kHz)</p> <p>Phase Offset is referenced to the signal output for Fin + N or the trigger input for Fin X N.</p> <p>Start/Stop Phase--Burst Modes:</p> <p>Accuracy: ±3° (applies from .001Hz to 1kHz)</p> <p>Function Characteristics</p> <p>Sine Harmonic Distortion:</p> <p>Individual harmonics will be below these levels, relative to carrier level. Offset = 0V. Function Invert = OFF. *Add 4dB for ambient temperature 0 to 5°C or 45 to 55°C.</p> <table border="1" style="margin-left: auto; margin-right: auto;"> <tr> <td style="text-align: center;">20Hz</td> <td style="text-align: center;">50kHz</td> <td style="text-align: center;">1999kHz</td> <td style="text-align: center;">19.99MHz</td> </tr> <tr> <td style="text-align: center;">-55dB*</td> <td style="text-align: center;">-40dB</td> <td colspan="2" style="text-align: center;">-25dB</td> </tr> </table> <p>Square Wave Rise/Fall Time:</p> <p>≤9ns, 10% to 90% of a 10 Vp-p output</p> <p>Square Wave Aberrations:</p> <p>5% of (High Settled Amplitude - Low Settled Amplitude)</p> <p>where Settled Amplitude is the voltage on the pulse top or bottom measured 100ns after the appropriate zero crossing.</p> <p>Frequency: ≤ 1MHz</p> <p>Amplitude: 10Vp-p</p> <p>10% of p-p Aberrations relative to programmed amplitude.</p> <p>Frequency: > 1MHz</p> <p>Amplitude: 10Vp-p</p> <p>Triangle Linearity:</p> <p>±0.2% of the p-p voltage</p> <p>Frequency: .01Hz to 1kHz, Amplitude = 10 Vp-p Deviation is from a best fit straight line, from 10% to 90% of each ramp.</p> <p>Internal Trigger Interval</p> <p>Period Accuracy: ±(0.01% + 50 ppm/year) of displayed interval (excluding sweep intervals)</p>	20Hz	50kHz	1999kHz	19.99MHz	-55dB*	-40dB	-25dB		<p>Frequency Sweep</p> <p>Sweep Frequency Accuracy--Manual Sweep:</p> <p>± (0.2% of Stop Freq + 0.1% of Stop Freq Range), Stop Freq Range ≤ 200kHz ± 1% of Stop Freq, Stop Freq in 2MHz Range ± 3% of Stop Freq, Stop Freq in 20MHz Range</p> <p>Modulation</p> <p>Amplitude Modulation Envelope Distortion:</p> <p>≤ -40dB</p> <p>Carrier: = 1MHz, 10Vp-p, sine wave Modulating Input: 1kHz, sine wave Index of Modulation: 95%</p> <p>VCO Linearity:</p> <p>±0.15% of p-p frequency, .1Hz through 200kHz Range ± 1% of p-p frequency, 2MHz Range ± 3% of p-p frequency, 20MHz Range</p> <p>- 8Vdc to + 1 Vdc input (-80% to + 10%) Deviation is from a best fit straight line.</p> <p>Option 001 - Simultaneous X3 Output.</p> <p>Specifications apply when the X3 Output is terminated with > 500Ω and < 500pf and when the Main output is terminated with 50Ω.</p> <p>The X3 Output is useable into all loads until the output current limits at ≈ 30 mA peak or the output voltage clips at ≈ 15V peak.</p> <p>X3 Gain Accuracy:</p> <p>± 1% at 10kHz X3 Output amplitude ≈ (3 ± 1%) x Main Output Amplitude</p> <p>Sine Power Flatness:</p> <p>Relative to full output power at 10kHz</p> <table border="1" style="margin-left: auto; margin-right: auto;"> <tr> <td style="text-align: center;">20Hz</td> <td style="text-align: center;">50kHz</td> <td style="text-align: center;">500kHz</td> <td style="text-align: center;">1MHz</td> </tr> <tr> <td style="text-align: center;">± .1dB</td> <td style="text-align: center;">± .5dB</td> <td colspan="2" style="text-align: center;">± 1.5dB</td> </tr> </table> <p>Harmonic Distortion:</p> <p>All harmonically related signals will be below these levels, relative to the fundamental.</p> <table border="1" style="margin-left: auto; margin-right: auto;"> <tr> <td style="text-align: center;">20Hz</td> <td style="text-align: center;">50kHz</td> <td style="text-align: center;">1MHz</td> </tr> <tr> <td style="text-align: center;">-53dB</td> <td colspan="2" style="text-align: center;">-38dB</td> </tr> </table> <p>Square Wave Rise/Fall Time: (Rear Panel) < 200ns, 10% to 90% at full output.</p> <p>Residual DC Offset: (Rear Panel)</p> <p>≤ 40mVDC</p>	20Hz	50kHz	500kHz	1MHz	± .1dB	± .5dB	± 1.5dB		20Hz	50kHz	1MHz	-53dB	-38dB	
20Hz	50kHz	1999kHz	19.99MHz																				
-55dB*	-40dB	-25dB																					
20Hz	50kHz	500kHz	1MHz																				
± .1dB	± .5dB	± 1.5dB																					
20Hz	50kHz	1MHz																					
-53dB	-38dB																						

Table 1-2. Supplemental Characteristics

<p>General</p> <p>Specifications apply when:</p> <p>Main signal output is terminated into 50 ± 0.1 ohms Warm-up is ≥ 30 minutes Within ± 5°C, and 24 hours of last internal calibration Temperature 0° to 55°C Relative Humidity ≤ 95% at 40°C Altitude ≤ 15,000 ft.</p> <p>Storage Limits:</p> <p>Temperature - 40° to + 75°C Altitude ≤ 15,000 ft.</p> <p>Power:</p> <p>100/120/220/240 V, + 5% - 10%, 48 to 66 Hz 95 VA maximum</p> <p>Weight:</p> <p>7.3 kg (16 lbs) net 10.5 kg (23 lbs) shipping</p> <p>Dimensions:</p> <p>132.6 mm (5.22 in) high 212.3 mm (8.36 in) wide 419.0 mm (16.50 in) deep</p>	<p>Accessories Included:</p> <p>11048C 50 ohm feed through</p> <p>Accessories:</p> <p>Transit case for one 3314A; -hp- #9211-2677</p> <p>OPTION 001:</p> <p>Amplitude Range:</p> <p>AC only to 30Vp-p or 60mAp-p before clipping. DC only to ± 15VDC or ± 30mADC before clipping. AC + DC to ± 15V peak or ± 30mA peak before clipping.</p> <p>Frequency Range:</p> <p>DC to 1MHz</p> <p>Output Resistance:</p> <p>< 2Ω at 10kHz</p> <p>Relationship of the X3 Amplitude to the 3314A's displayed amplitude:</p> $X3 \text{ AMPTD} = 3 \left[2 \times \text{Display} \frac{\text{Main Output Load}}{\text{Main Output Load} + 50} \right]$
--	---

1-7. SAFETY CONSIDERATIONS

The 3314A is a Safety Class 1 instrument (provided with a protective earth terminal). The instrument and manuals should be reviewed for safety markings and instructions before operation.

1-8. GROUNDING

The outer conductor of all BNC type connectors, the shield and pins 12 and 18 through 24 of the HP-IB connector, the frame, chassis, covers, and all exposed metal surfaces are connected to the protective earth terminal.

WARNING

Do NOT interrupt the protective earth ground or "float" the 3314A. This action could expose operators to potentially hazardous voltages!

1-9. RECOMMENDED TEST EQUIPMENT

Equipment required to maintain the 3314A is listed in Table 1-3 Recommended Test Equipment. Other equipment may be substituted if it meets or exceeds the performance of the listed equipment. When substitutions are made, the user may have to change the test procedures to accommodate different operating characteristics.

1-10. OPERATOR MAINTENANCE

Operator Maintenance is limited to replacing the line fuse. There are no operator controls inside the 3314A. The Z-Axis polarity switch is located inside the 3314A, however, only Service Trained personnel using the instructions located in Section 2 of this manual are to set this switch.

WARNING

Under no circumstances should an operator remove any covers, screws, shields or in any other way enter the 3314A. There are no operator controls inside the 3314A.

1-11. AVAILABLE EQUIPMENT

The following service kits are available and contain the necessary hardware and instructions to retrofit the instrument:

- Front Panel Kit 03314-84401
- Rear Panel Kit 03314-84402

Table 1-3. Recommended Test Equipment

Instrument	Critical Specs	Recommended Model
Universal Counter	Freq Measurement to 20MHz Accuracy \pm 2 counts Resolution 8 Digits	-hp- 5328B PA (-hp- 5328A) (-hp- 5345A)
AC/DC Digital Voltmeter	DC Function Acc. \pm .05 % AC Function: True RMS Acc. \pm .2 % Resolution 6 Digits	-hp- 3455A PA (-hp- 3456A)
High Speed Digital Voltmeter	DC Voltage 0V-10V Sample/Hold Measurement External Trigger: Low True TTL Edge Trigger Trigger Delay: Selectable, 10 μ S to 140 μ S	-hp- 3437A P
Synthesizer/Function Generator	Sine Output: 1kHz Amplitude: 1Vrms into 10k Ω	-hp- 3325A PA (-hp- 3335A)
VHF Attenuator (see Note 1)	Atten: 100dB in 10dB steps Freq Range 50Hz to 20MHz Impedance 50 Ω	-hp- 355D P
High Frequency Spectrum Analyzer	Freq Range 40MHz to 120MHz Amplitude Accuracy: \pm .5dB	-hp- 8557A P (-hp- 8558B) (-hp- 141T,8552B)
Spectrum Analyzer (see Note 2)	Freq Range 20Hz to 40MHz Amplitude Linearity: \pm .3dB Resolution: .01dB	-hp- 3585A PA
3 Volt Thermal Converter	Input Impedance 50 Ω Input Voltage: 3Vrms Freq: 2kHz to 20MHz Frequency Response: \pm .05dB	-hp- 11049A P (Ballantine 1395A-3 with cable 12257A opt. 10) *
1 Volt Thermal Converter	Input Impedance 50 Ω Input Voltage: 1Vrms Freq: 2kHz to 20MHz Frequency Response: \pm .05dB	-hp- 11050A P (Ballantine 1395A-1 with cable 12257A opt. 10) *
Oscilloscope	Dual input, Ext Trigger, X-Y Display Mode X10 Mag, Delayed Sweep Vertical BW DC to 275MHz Deflection .01V to 10V/Div Horizontal Sweep: .01 μ S to 1s/Div	-hp- 1725A PA (-hp- 1745A)
Power Supply	Volts: -8VDC to +2VDC Amps: 10mA	-hp- 6235A P

Note 1: VHF attenuator must be characterized.
Note 2: The 3585A is required because of its .01dB Resolution.

P=Performance Test
A=Adjustments
()=Alternative Instruments

* Ballantine Laboratories, Inc.
P.O. Box 97
Boonton, NJ 07005, U.S.A.
Telephone: 201-335-0900 TWX: 710-987-8380

Table 1-3. Recommended Test Equipment (Cont'd)

Instrument	Critical Specs	Recommended Model
BNC/Tee Adaptor	50Ω BNC/Tee (m)(f)(f)	-hp- 1250-0781 PA
BNC/Banana Adaptor	50Ω BNC (f) to dual banana plug	-hp- 1250-2277 PA
BNC to Triax Adaptor	50Ω BNC (f) to BNC Triaxial (m)	-hp- 1250-0595 P
50Ω Feedthrough Termination	Accuracy: ±.2% Power Rating: 1W	-hp- 11048C PA
500Ω Feedthrough Termination (use in X3 test)	Resistor: 499Ω	-hp- 0698-4123 P
500Ω 250pF Feedthrough Termination (use in X3 test)	Resistor: 499Ω Capacitor: 240pF (10pF added by probe in test)	-hp- 0698-4123 A -hp- 0140-0199
450Ω Voltage Reducer (use in X3 test)	Resistor: 450Ω	-hp- 0698-3510 P
Low Pass Filter	Resistor: 1MΩ ± 5% Capacitor: 1μF ± 20%	-hp- 0683-1055 P -hp- 0160-0127
10:1 Probe	Impedance: 1MΩ Capacitance: 20-26pF	-hp- 10041A A
P=Performance Test A=Adjustments ()=Alternative Instruments		

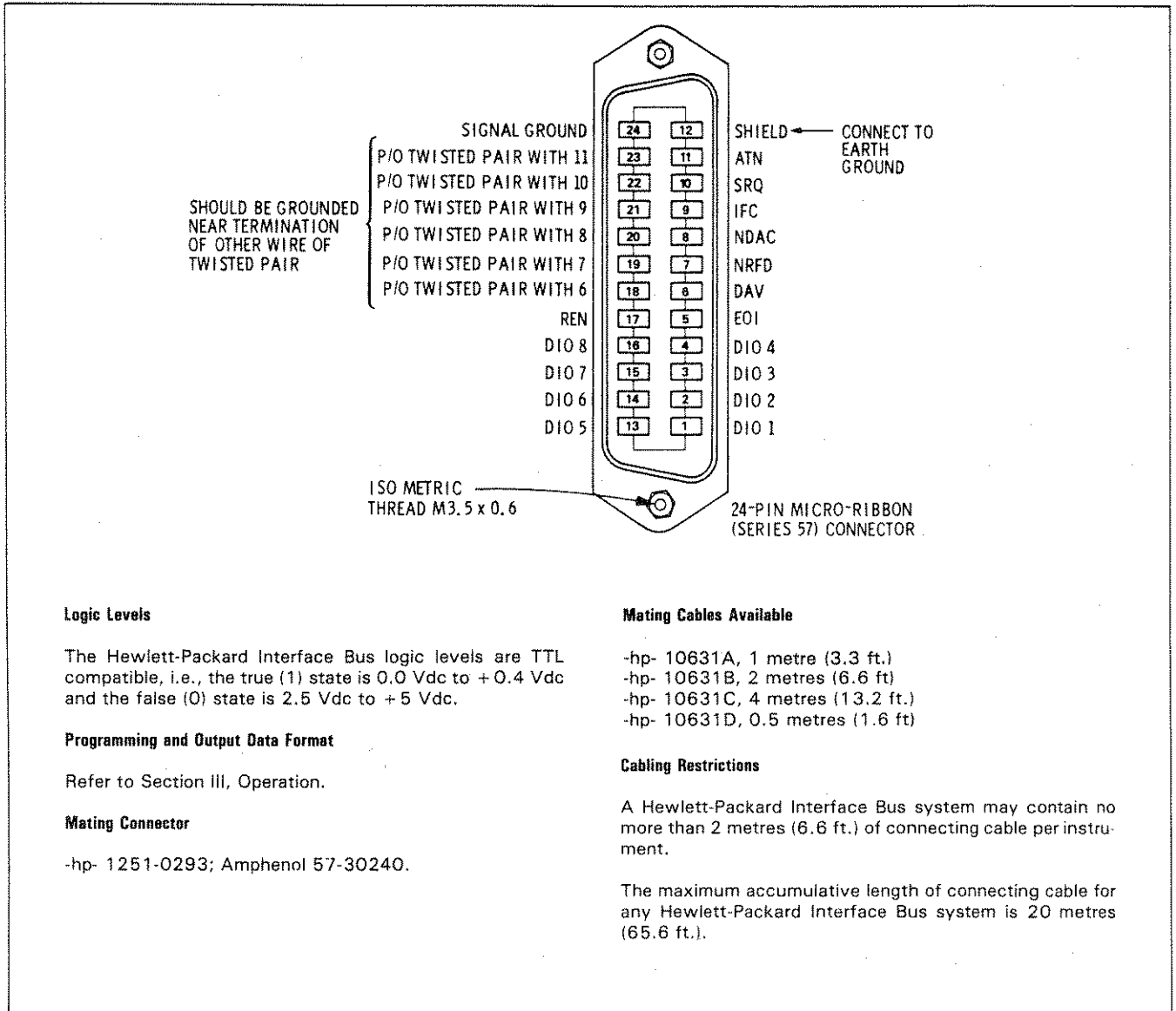

Figure 2-1. HP-IB Connector Detail

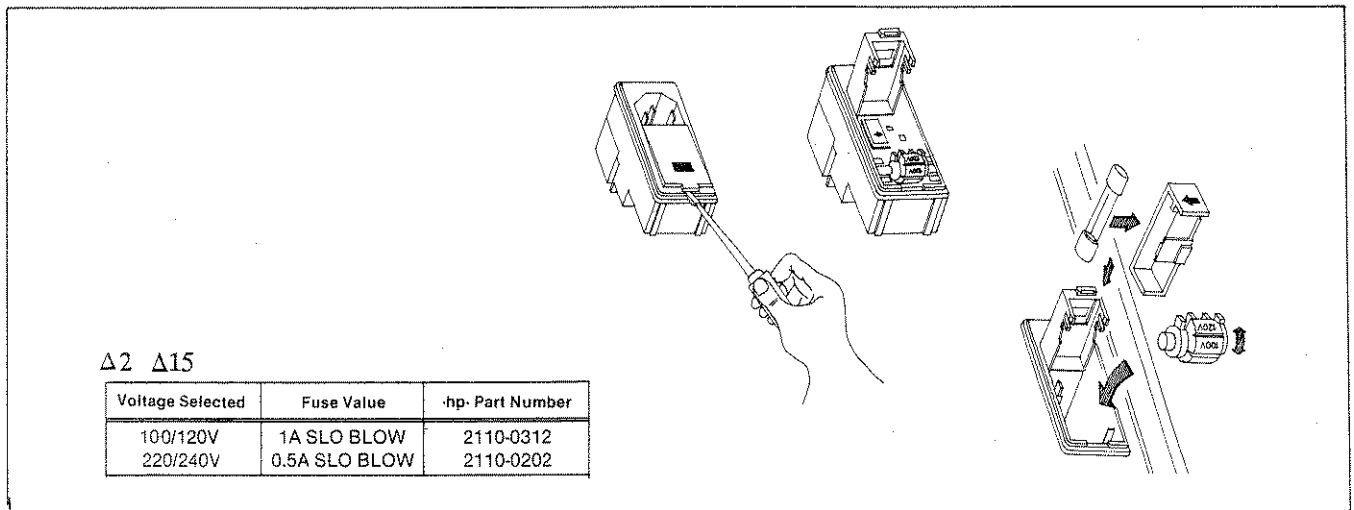

Figure 2-2. Line Voltage/Line Fuse Selection

SECTION II

INSTALLATION

2-1. INTRODUCTION

This section provides installation instructions for the 3314A Function Generator. This section also provides information about initial inspection and damage claims, preparation for using the 3314A and what to do in case of difficulty. In addition, installation instruction sheets for several -hp- accessories (rack, handle and foot kits) are located at the end of this section. See Section VII, Manual Backdating, for "Δ" explanations.

2-2. INITIAL INSPECTION

Inspect the shipping container for damage. If the shipping container or cushioning material is damaged, it should be kept until the contents of the shipment have been checked for completeness and the instrument has been checked mechanically and electrically. The contents of the shipment should be:

- An Operating Manual
- A Service Manual
- A Power Cord
- A 50Ω Feedthrough Termination

If the contents are incomplete, if there is mechanical damage or defect or if the 3314A does not pass the Performance Tests, notify the nearest Hewlett-Packard office. If the shipping container or the cushioning material is damaged, notify the carrier as well. Keep the shipping material for the carrier's inspection. The -hp- office will arrange for repair or replacement at -hp- option without waiting for a claim settlement.

WARNING

The integrity of the protective earth ground may be interrupted if the 3314A has been mechanically damaged. Under no circumstances should a 3314A be connected to power if it is damaged.

2-3. MATING CONNECTORS

The 3314A uses 50Ω BNC(f) type connectors for all signal I/O. The outer shield is connected to protective earth ground.

The HP-IB connector is an Amphenol or Cinch type 57 connector. See Figure 2-1 for pin assignments.



An improperly set voltage selector will cause the line fuse to blow.

The wrong fuse value or type will not protect the instrument's circuitry and may result in damage to your 3314A.

Remove line voltage selector to change voltage. Rotating selector without removal will damage the module.

Δ 2 Δ 15

2-4. LINE VOLTAGE SELECTION

Figure 2-2 provides instructions for line voltage and fuse selection. The line voltage selector position and line fuse value are selected at the factory based upon the country of destination. Always check the line voltage selector and line fuse value before connecting the 3314A to AC power. To change voltage, be sure to remove selector before rotating to avoid damaging the module.

The three-wire power cord provided with the 3314A establishes a protective earth ground for the chassis and cabinet when plugged into a receptacle with a ground contact. The offset pin on the plug is the ground connection.

This protective ground may be interrupted if the 3314A is mechanically damaged. Intentional interruption is prohibited. An interruption of any connection that establishes the ground can make the instrument dangerous. If it is likely that ground protection is impaired, the instrument must not be connected to power.

The line voltage selected for the 3314A is indicated on the line voltage selector. It is set at the factory to correspond to the most commonly used line voltage of the country of destination. Refer to Figure 2-2 for setting the line voltage and selecting the appropriate fuse.

If you make any changes to the voltage selector or the fuse, be aware of correct alignment indications. Before closing the module's cover, confirm that the arrow on the fuse holder aligns with the arrows on the inside of the cover. They should all point in the same direction. After firmly pushing the cover closed, be sure the correct line voltage appears through the cover window.

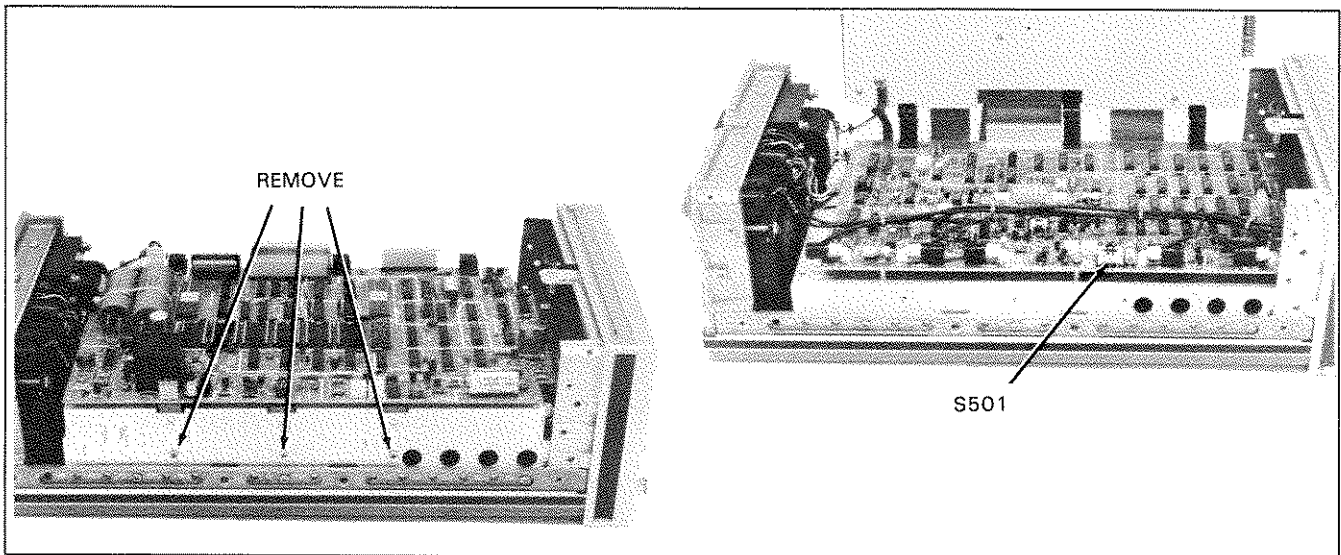

Figure 2-3. Z-AXIS Polarity Selection

2-5. Z-AXIS POLARITY SELECTION

The polarity of the Z-Axis output can be inverted by setting S501 on the A2 PC board. This switch is set at the factory to output positive ($> +5V$) blanking pulses, negative ($< -5V$) intensifying pulses and 0V baseline.

To gain access to this switch:

1. Disconnect the 3314A from its power source.
2. Remove the top handle and then the top cover.
3. Remove the three screws that secure the A3 PC Assembly shield to the main deck. See Figure 2-3.
4. Raise the A3 PC Assembly on its hinges to expose the A2 PC Assembly.
5. S501 is located at the left edge of the A2 PC Assembly.
6. Set S501 as required. "BLK-" is for negative blanking pulses. "BLK+" is for positive blanking pulses.
7. Re-assemble the 3314A.

2-6. HP-IB ADDRESS SELECTION

The HP-IB address is set from the front panel and stored in non-volatile memory.

To view the address:

1. Press the blue shift key and then the LCL key. The current address will be displayed for about 1/2 second.

To change the address:

1. Press the RECALL key and then the LCL key. The current address will be displayed indefinitely.
2. Set the 3314A's address from 0 to 30 inclusive with the Modify knob. Address 31 is not allowed. Incrementing the past 30 sets the address to Listen Only. When the 3314A is set to Listen Only, the displayed address will be "L-O".
3. Press the STORE key and then the LCL key to execute the entry.

The HP-IB address is set at the factory to 7. 7 is also the default address if the non-volatile memory is lost.

If you are using a controller in the "command" mode or are using an older type that requires the Talk and Listen addresses, use Table 2-1 to determine the proper addresses.

2-7. POWER ON AND OPERATOR'S CHECKS

Connect the 3314A to its power source using the power cord provided. If the power cord included with your 3314A is not compatible with the outlet, contact your nearest -hp- office for a replacement.

Table 2-1. HP-IB Address

Device	Talk	Listen
0	@	SP
1	A	!
2	B	"
3	C	#
4	D	\$
5	E	%
6	F	&
7	G	'
8	H	(
9	I)
10	J	*
11	K	+
12	L	,
13	M	-
14	N	.
15	O	/
16	P	0
17	Q	1
18	R	2
19	S	3
20	T	4
21	U	5
22	V	6
23	W	7
24	X	8
25	Y	9
26	Z	:
27	[;
28	\	<
29]	=
30	^	>

3314A factory setting

usually the controller

Listen Only

Set the LINE switch, located at the upper left corner of the front panel, to the on position. At this time the 3314A will

initiate a 2 second count down to allow electrical stabilization.

do a CALibrate ALL to generate a full complement of calibration constants. Every frequency range and all three functions are checked by a CAL ALL.

display the appropriate calibration errors if the CAL ALL failed. The 3314A will attempt to calibrate itself for another 20 seconds or until a calibration is successful.

This checks ~80% of the all the 3314A's circuitry. A special memory test has been built into the 3314A to test every ROM and RAM IC. To perform this test, hold the "ARB" key in while power is turned ON. While the 3314A is checking the memory, the front panel will be completely blank (about 30 seconds). After the test is finished, all the front panel LEDs will be lit if the test was successful. If the test was not successful, one or more of these LEDs will be off.

ROM IC	LED	RAM IC	LED
U208	FREQ AMPTD	U211	SW/TR INTVL START FREQ
U207	OFFSET SYM PHASE N		STOP FREQ MARK FREQ

In addition, you can now check every front panel key. When a key is pressed, a corresponding LED should go OFF. The Modify knob and arrow keys cause elements of the 7 segment display to go OFF.

2-8. WHAT TO DO IN CASE OF DIFFICULTY

There are several operator actions that should be performed before an 3314A is diagnosed as defective.

1. Clear the 3314A's memory completely by holding the PRESET key in while setting power ON. The 3314A will display "E09" after the normal start up to indicate the the non-volatile memory has been cleared.
2. Check the Line Voltage and the Line Voltage Selector. These must be compatible.
3. Check the Line Fuse for the proper value and type. Normal blow type fuses are not allowed.
4. Clean the air filter.
5. Perform the Operators Checks. See Paragraph 2-7.
6. Check the system cabling and the loading of each output.
7. Check the performance of the 3314A against the specifications with the instructions in Section 4 of this manual.

Hewlett-Packard has a world-wide service organization in case your 3314A requires service. Page ii of this manual contains explicit warranty information and should be thoroughly understood before an instrument is shipped to a repair facility. When a 3314A is shipped to a repair facility, use one of the Service Repair Tags to insure timely action. If you need more Service Repair Tags, order part number 9320-3896 from your nearest sales and service office.

2-9. OPTION 001: PRE-INSTALLATION AND ORDERING INFORMATION

This information applies when you want to install Option 001 into a 3314A in the field. Option 001 has been completely installed and tested at the factory in 3314A's which were ordered with Option 001.

Field installation requires that you order a K04-3314A kit that contains the necessary parts for converting a standard instrument to an Option 001. The K04-3314A kit includes the first six parts listed in the following table.

Qty.	Description	-hp- Part Number
1	X3 PC Assembly	03314-66505
1	X3 Output Cable	03314-61611
1	X3 Power Supply Cable	03314-61616
1	BNC Jack	1250-1717
4	SCREW PH M3	0515-0886
4	WASHER-LOCK-SCR 4	2190-0004
1*	DIODE, Zener, 35.8V	1902-3301
2*	Tie Point	0360-0124
.2ft.*	Flexible Tubing	0890-0060
1**	CABLE, COAX, A5 to Main Output	03314-61613
2**	WASHER, SHLDR	5040-0345
1	Label	7120-8377

* These items are required if you are installing Option 001 into 3314A's with serial numbers 2141A00101 through 2141A00150.
 ** These items are required if you are installing Option 001 into 3314A's with serial numbers 2141A00151 through 2141A00261. Cable W13 in this serial number range is 20mm shorter than a standard cable (too short to be used with Option 001). The short cable can be identified because it has an RCA PHONO type connector. The longer cable has a BNC panel connector.

WARNING

Failure to install A1CR123 (35.8V zener diode) into 3314A's with serial numbers 2141A00101 through 2141A00150 when installing Option 001, will affect the warranty of the 3314A and Option 001. This diode protects the X3 PC Assembly from "high line" operation. High line conditions exist whenever the line voltage exceeds the line voltage switch settings by more than 5%.

2-10. INSTALLATION (OPTION 001)

WARNING

Maintenance described herein is performed with power supplied to the instrument and protective covers removed. Such maintenance should be performed by service-trained personnel who are aware of the hazards involved (for example fire and electrical shock). Where maintenance can be performed without power applied, the power cord should be removed.

WARNING

Before any repair is completed, ensure that all safety features are intact and functioning and that all necessary parts are connected to their protective grounding means.

WARNING

All 3314A's with serial numbers from 2141A00101 through 2141A00150 must have a 35.8V zener diode added to the power supply before installing Option 001. This diode is required to protect Option 001 from "high line" operation. High line conditions exist when the line voltage exceeds the line voltage switch settings by more than 5%.

NOTE

The installation of A3CR123 must be done very carefully to meet HP's stringent quality assurance requirements. Failure to install A3CR123 as directed will affect the warranty. See "LIMITATION OF WARRANTY" paragraph on page i of this manual for exact details.

2-11. HOW TO INSTALL A3CR123 (Serial numbers 2141A00101 through 2141A00150 only)

Read the entire set of instructions and review Figure 2-4, "A3CR123 Installation" before beginning. Review the general safety consideration and the static sensitivity topics in Section VIII of the Service Manual.

CAUTION

There are several components on the A3 PC Assembly that are static sensitive. The work station, the soldering iron and the service personnel should be static protected.

- A. Remove the power cord.
- B. Remove the screws securing the top handle and then remove the handle. Remove the top cover by pulling the cover carefully up and to the rear of the 3314A.

C. Disconnect all five cables from the A3 PC Assembly.

D. Remove all eight screws that secure the A3 PC Assembly to the deck.

E. Carefully lift the A3 PC Assembly straight up. There are three transistors mounted on the deck that connect to the A3 PC Assembly via three connectors on the left side of the PC board.

F. Unsolder the collector of A3Q115 and the end of A3R146 that is nearest Q112.

G. Solder a Tie Point (0360-0124) into the empty holes created in step F.

H. Wrap the lead from A3Q115 around its tie point. This lead should make one full turn around the tie point to insure good mechanical contact and the lead should have a slight bend to relieve any stress.

I. Wrap the lead from A3R146 around its tie point. This lead should make one full turn around the tie point to insure good mechanical contact and the lead should have a slight bend to relieve any stress.

J. Install about .6 inch of flexible tubing on each lead of A3CR123.

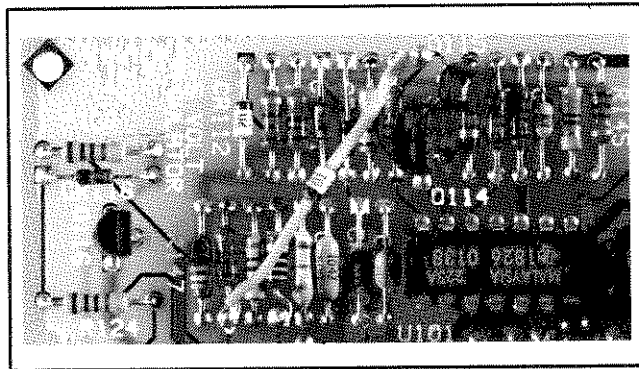

Figure 2-4. A3CR123 Installation

K. Wrap the lead from the cathode (the end with the stripe of A3CR123) to the A3R146 tie point. This lead should make one full turn around the tie point to insure good mechanical contact, the lead should have a slight bend to relieve stress and the end of the flexible tubing should end < .1 inch from the tie point. See Figure 2-4, "A3CR123 installation".

L. Install the other lead from A3CR123 onto the A3Q115 tie point. This lead should make one full turn around the tie point to insure good mechanical contact, the lead should have a slight bend to relieve any stress and the end of the flexible tubing should end < .1 inch

from the tie point. See Figure 2-4, "A3CR123 Installation."

M. Solder the leads to each tie point.

N. Remove the solder flux from both sides of the A3 PC Assembly with flux remover.

O. Carefully install the A3PC Assembly back into the 3314A. Make sure the leads from Q100, Q101 and Q108 are correctly seated in their respective connectors and are not bent. When the A3 PC Assembly is correctly installed, each transistor lead will show about .05 inch above the connectors.

P. Complete the assembly of the 3314A by reversing the actions taken in steps D, C, B and then A.

2-12. HOW TO INSTALL OPTION 001

A. Remove the power cord.

B. Remove the top and bottom covers.

C. Install the A5 PC assembly onto the A1 VCO shield using the four screws and washers supplied. Make sure that the two adjustment holes in the A5 PC Board align with the holes in the shield.

D. Install the X3 Power Supply Cable, 03314-61616, from A5J1 to A3J102.

E. Remove the temporary plug from the X3 Output hole in the rear panel.

F. Install the X3 BNC jack, 1250-1717, in the X3 Output hole. If you do not have a socket type wrench to tighten the nut properly, you will have to remove the rear panel. The rear panel is secured to the rear frame with two screws from the top and two screws from the bottom.

G. Install the X3 Output Cable, 03314-61611, from A5J4 to the X3 Output jack just installed. Install the rear panel if removed in step F.

H. Using a razor or sharp knife, carefully cut the tubing that secures the two SMB connectors located in the middle of the Main Output Cable. It is not necessary to remove the tubing, just to disconnect the SMB connectors.

I. Connect each SMB connector from the Main Output Cable to a corresponding SMB connector on the X3 PC Assembly.

J. Dress the cables so that they are not stressed and so that they will not interfere with the fan blades.

K. Replace all covers and then connect the power cord. All X3 PC Assemblies were fully tested at the factory, however, the Performance Tests should be performed to verify that the X3 Output is fully operational.

2-13. RE-PACKAGING A 3314A

The best material to re-pack a 3314A is the original material used by the factory. If this material has not been retained, the following steps should be performed:

1. Wrap the 3314A in heavy paper or plastic. If you are shipping the 3314A to a -hp- office, attach one of the Service Repair Tags. The front panel should also be protected with an additional piece of cardboard.
2. Use a strong shipping container. A double wall carton made of 350 pound test material is adequate.
3. Use a layer of shock-absorbing material 70 to 100 mm (3 to 4 inches) thick around all sides of the instrument to provide firm cushioning. Do not use loose filler such as styrofoam chips.
4. Seal the shipping container.
5. Mark the shipping container **FRAGILE** to ensure careful handling.
6. In any correspondence, refer to the 3314A by its full serial number.

2-14. INSTALLING ACCESSORIES $\Delta 8$

-hp- manufactures several kits to adapt your 3314A with handles, feet and rack mounts. These kits are available from -hp-.

5 1/4 H Front Handle Kit	5061-9689 Option 907
5 1/4 H Rack Adapter Kit (Half Module)	5061-9657 Option 908
5 1/4 H Support Shelf Kit	5061-0097
Slide Kit (For Support Shelf)	1494-0041
Lock Link Kit (Vertical and Horizontal)	5061-0094
5 1/4 H Bail Handle Kit (Half Module)	5061-2002
Feet-Rear Panel Stand-Off	5061-2009
Feet-Rear and Cord Wrap	5061-0095

132.6H FRONT HANDLE KIT

[PRODUCT HT. 132.6mm/5.219 in.]

HP PART NUMBER 5061-9689 (OPTION 907)

CONTENTS

QTY.	PART NO.	"INCH" EQUIV. PART NO.
2.....	FRONT HANDLE ASS'Y	5061-9499
2.....	FRONT HANDLE TRIM	5020-8896
6.....	M4 x 0.7 x 10 SCREW, FLAT HEAD, 90°	0515-0896 2510-0195

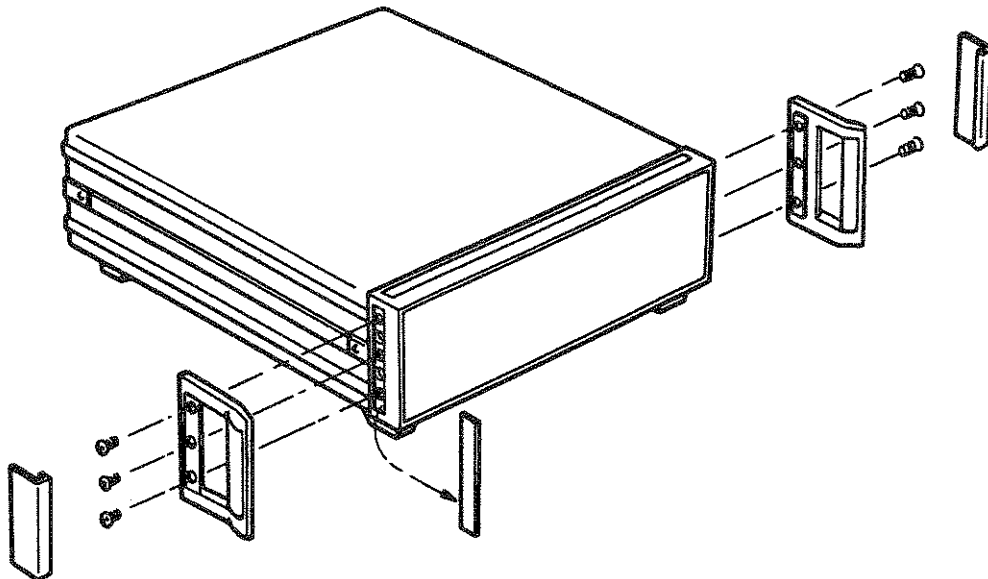

CAUTION: PLEASE VERIFY THE METRIC (5021- . . .) OR THE INCH (5020- . . .) PART NUMBER ON TOP OF THE FRONT FRAME OF THE CABINET FOR THE CORRECT SCREWS.

INSTRUCTIONS

1. REMOVE SIDE TRIM STRIPS.
2. ATTACH FRONT HANDLE ASS'Y WITH 3 SCREWS PER SIDE.
3. PRESS FRONT HANDLE TRIM IN PLACE.

MADE IN USA 2/85
 LABEL NO. 5958-3328

132.6H RACK ADAPTER KIT HALF MODULE

[PRODUCT HT. 132.6mm/5.219 in.]

HP PART NUMBER 5061-9657

CONTENTS

QTY.	PART NO.	"INCH" EQUIV. PART NO.
1.....	ADAPTER ASS'Y	5061-0006
1.....	RACK FLANGE	5020-8862
6.....	M4 x 0.7 x 10 SCREW, PAN HEAD ...	0515-1114 2510-0193

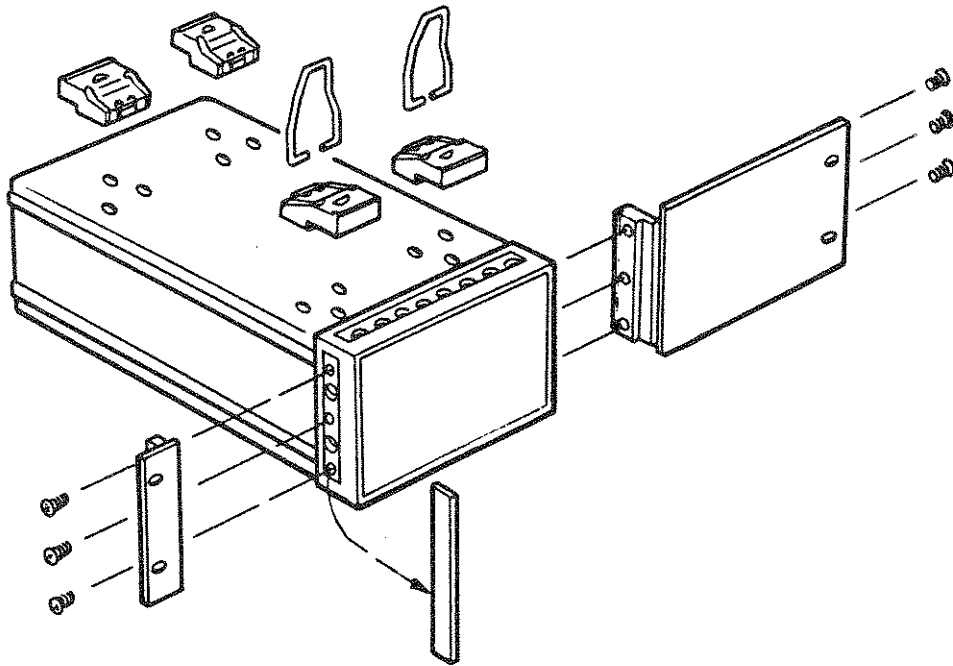

CAUTION: PLEASE VERIFY THE METRIC (5021-) OR THE INCH (5020-) PART NUMBER ON TOP OF THE FRONT FRAME OF THE CABINET FOR THE CORRECT SCREWS.

INSTRUCTIONS

1. REMOVE SIDE TRIM STRIPS.
2. ATTACH ADAPTER ASS'Y TO LEFT OR RIGHT SIDE WITH 3 SCREWS.
3. ATTACH RACK FLANGE TO OPPOSITE SIDE WITH 3 SCREWS.

MADE IN USA 2/85
LABEL NO. 5958-3301

132.6H SUPPORT SHELF KIT SUB MODULES

[PRODUCT WTS. to 22.7kg/50 lbs.]

HP PART NUMBER 5061-9697

CONTENTS

QTY.		PART NO.	"INCH" EQUIV. PART NO.
1	SUPPORT SHELF ASS'Y	5061-9697	
8	TIE DOWN CLIPS	1600-1424	
8	M3.5 x 0.6 x 6, SCREW*, PAN HEAD	0515-0887	2360-0330
8	M3.5 x 0.6 x 12, SCREW**, PAN HEAD	0515-0892	2360-0199
8	M3.5 WASHER	3050-1192	

* STANDARD CABINETS ** PLASTIC CABINETS

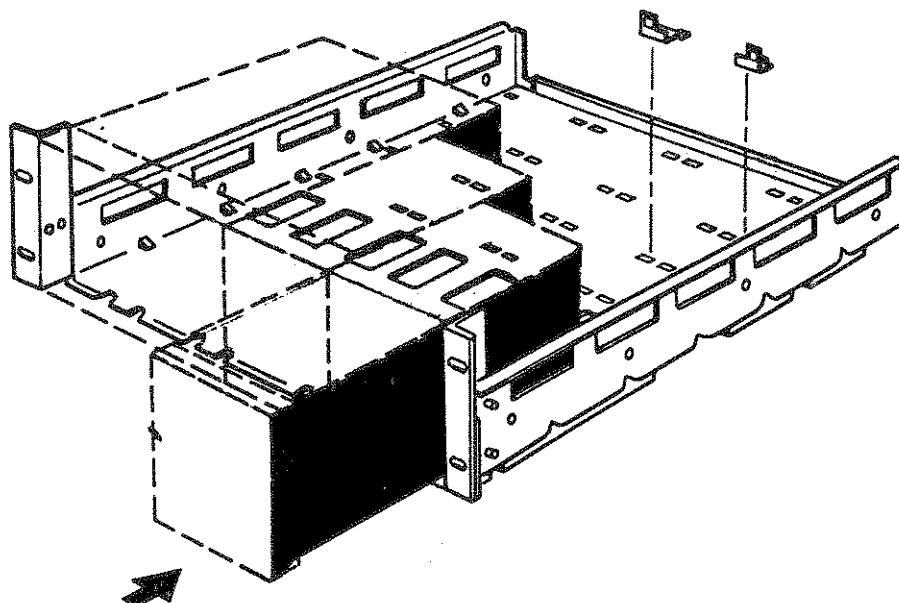

CAUTION: PLEASE VERIFY THE METRIC (5021-....) OR THE INCH (5020-....) PART NUMBER ON THE REAR FRAME OF THE CABINET FOR THE CORRECT SCREWS.

INSTRUCTIONS

1. REMOVE FEET FROM SUB MODULE INSTRUMENT.
2. SET MODULE ON FLOOR OF TRAY AND SLIDE BACK UNTIL TRAY TAB IS INSERTED IN FRONT FRAME.
3. INSERT 2 TIE DOWN CLIPS IN APPROPRIATE TRAY SLOTS, PRESS CLIPS OVER REAR CASTING BOSSES AND LOCK DOWN WITH APPROPRIATE M3.5 x 0.6 SCREWS & WASHERS.
4. MOUNT SUPPORT SHELF IN ANY STD. 482.6 mm RACK ENCLOSURE.

MADE IN USA 2/85
LABEL NO. 5958-3336

SLIDE KIT SUB-MODULE SUPPORT SHELF SYSTEM II

HP PART NUMBER 1494-0065

CONTENTS

QTY.		PART NO.
1 PR.	SLIDE ASSEMBLY	1494-0065
8	M4 x 0.7 x 6 SCREW, PAN HEAD	0515- 0898
8	M4 x 0.7 NUT W/LOCKWASHER	0535-0082
8	M5 x 0.8 x 12 PAN HEAD SCREW	0515-0909
8	M5 x 0.8 UNISTRUT NUT05#5-0079	0535-0079

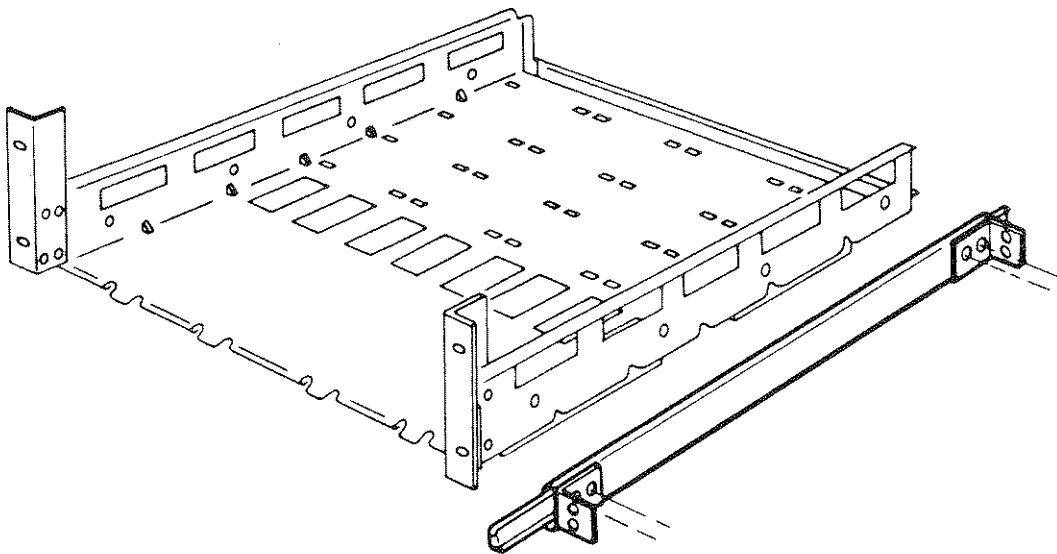

INSTRUCTIONS

1. ATTACH SLIDE (INNER MEMBER) TO EACH SIDE OF SUPPORT SHELF USING 4 M4 x 0.7 x 6 P.H. SCREWS AND NUTS PER SIDE.
2. INSERT 2 UNISTRUT NUTS IN THE REAR OF EACH OF THE 4 VERTICAL COLUMNS OF THE H.P. SYSTEMS ENCLOSURE.
3. ATTACH SLIDE (OUTER MEMBER) TO EACH SIDE OF SYSTEMS ENCLOSURE USING 4 M5 x 0.8 x 12 P.H. SCREWS PER SIDE.

MADE IN USA 2/85
LABEL NO. 5958-3359

LOCK LINK KIT VERTICAL AND HORIZONTAL

HP PART NUMBER 5061-9694

The vertical and horizontal lock link hardware is used for locking together various bench and rack mountable combinations of full and sub module cabinets of equal depths, sufficient horizontal links (12 front, 8 rear), to form three side by side joints (up to 4 sub module instruments), and sufficient vertical links (4 front, 4 rear) to form two sets of over-under joinings.*

CONTENTS

QTY		PART NO.
4	VERTICAL LOCK LINK, FRONT	1600-1423
8	M3.5 x 0.6 x 6 PAN HEAD	0515-0887
4	VERTICAL LOCK LINK, REAR	0050-2168
8	M3.5 x 0.6 x 12 (90°) FLAT HEAD PLASTIC MOD	0515-1235
8	M3.5 x 0.6 x 8 (90°) FLAT HEAD METAL MOD	0515-1234
12	HORIZONTAL LOCK LINK, FRONT	0050-2166
12	M4 x 0.7 x 6 (90°) FLAT HEAD	0515-1055
6	HORIZONTAL LOCK LINK, REAR	0050-2167
12	M3.5 x 0.6 x 12 (90°) FLAT HEAD PLASTIC MOD	0515-1235
12	M3.5 x 0.6 x 8 (90°) FLAT HEAD METAL MOD	0515-1234

"INCH" HARDWARE

This kit also contains the equivalent "inch" hardware to attach the lock links to the "inch" cabinet frames.

QTY	CONTENTS	PART NO.
8	6-32 x 0.188 PAN Head	2360-0330
20	6-32 x 0.312 FLAT HEAD, 100'	2360-0334
20	6-32 x 0.438 FLAT HEAD, 100'	2360-0360
12	8-32 x 0.250 FLAT HEAD, 100'	2510-0192

CAUTION

Please verify the "inch" front- or rear frame as follows:

"Inch" Front- or Rear Frame	5020-....
"Metric" Front- or Rear Frame	5021-....

(These P/N's are diecast into the top and rear of the frames).

INSTRUCTIONS

Vertical Locking

1. Remove top trim strip from bottom front frame.
2. Attach front vertical lock links to bottom front frame using 2 M3.5 x 0.6 pan hd. screws per link.
3. Slide top cabinet back to lock front frames together.
4. Attach rear vertical lock links over appropriate rear bosses using 2 M3.5 x 0.6 F.H.M. screws per link .

Horizontal Locking

1. Remove appropriate side trim strips.
2. Attach front horizontal lock links to front frames using 1 M4x0.7 F.H.M. screw per link. Opposing links must be installed to interlock.
3. Press cabinets together, slide left cabinet back to lock front frames.
4. Attach rear horizontal lock links over appropriate rear bosses using 2M3.5 x 0.6 F.H.M. screws per link.

*Locking cabinet together horizontally in a configuration wider than 1 full module width or locking more than two sub modules vertically is not recommended.

MADE IN USA 2/85
LABEL NO. 5958-3333

FRONT LOCK LINKS 

REAR LOCK LINKS 

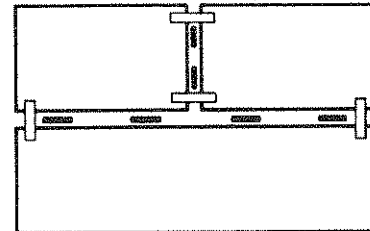
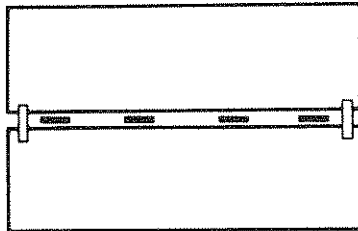

- VERTICAL LOCK LINKS FRONT
- VERTICAL LOCK LINKS REAR

- 4 - VERTICAL LOCK LINKS FRONT
- 2 - VERTICAL LOCK LINKS REAR
- 4 - HORIZONTAL LOCK LINKS FRONT
- HORIZONTAL LOCK LINKS REAR

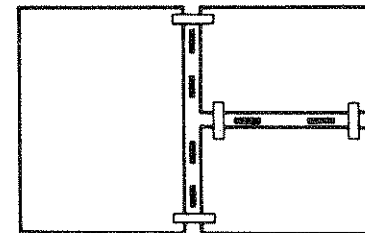
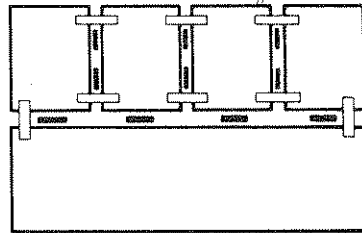

- 4 - VERTICAL LOCK LINKS FRONT
- 2 - VERTICAL LOCK LINKS REAR
- 12 - HORIZONTAL LOCK LINKS FRONT
- 6 - HORIZONTAL LOCK LINKS REAR

- 2 - VERTICAL LOCK LINKS FRONT
- 2 - VERTICAL LOCK LINKS REAR
- 8 - HORIZONTAL LOCK LINKS FRONT
- 2 - HORIZONTAL LOCK LINKS REAR

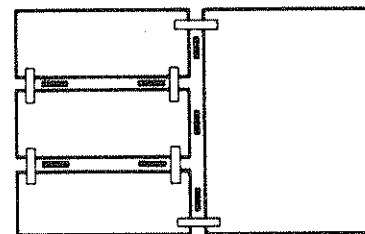
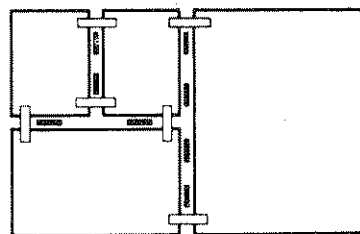

- 2 - VERTICAL LOCK LINKS FRONT
- 2 - VERTICAL LOCK LINKS REAR
- 12 - HORIZONTAL LOCK LINKS FRONT
- 4 - HORIZONTAL LOCK LINKS REAR

- 4 - VERTICAL LOCK LINKS FRONT
- 4 - VERTICAL LOCK LINKS REAR
- 6 - HORIZONTAL LOCK LINKS FRONT
- 2 - HORIZONTAL LOCK LINKS REAR

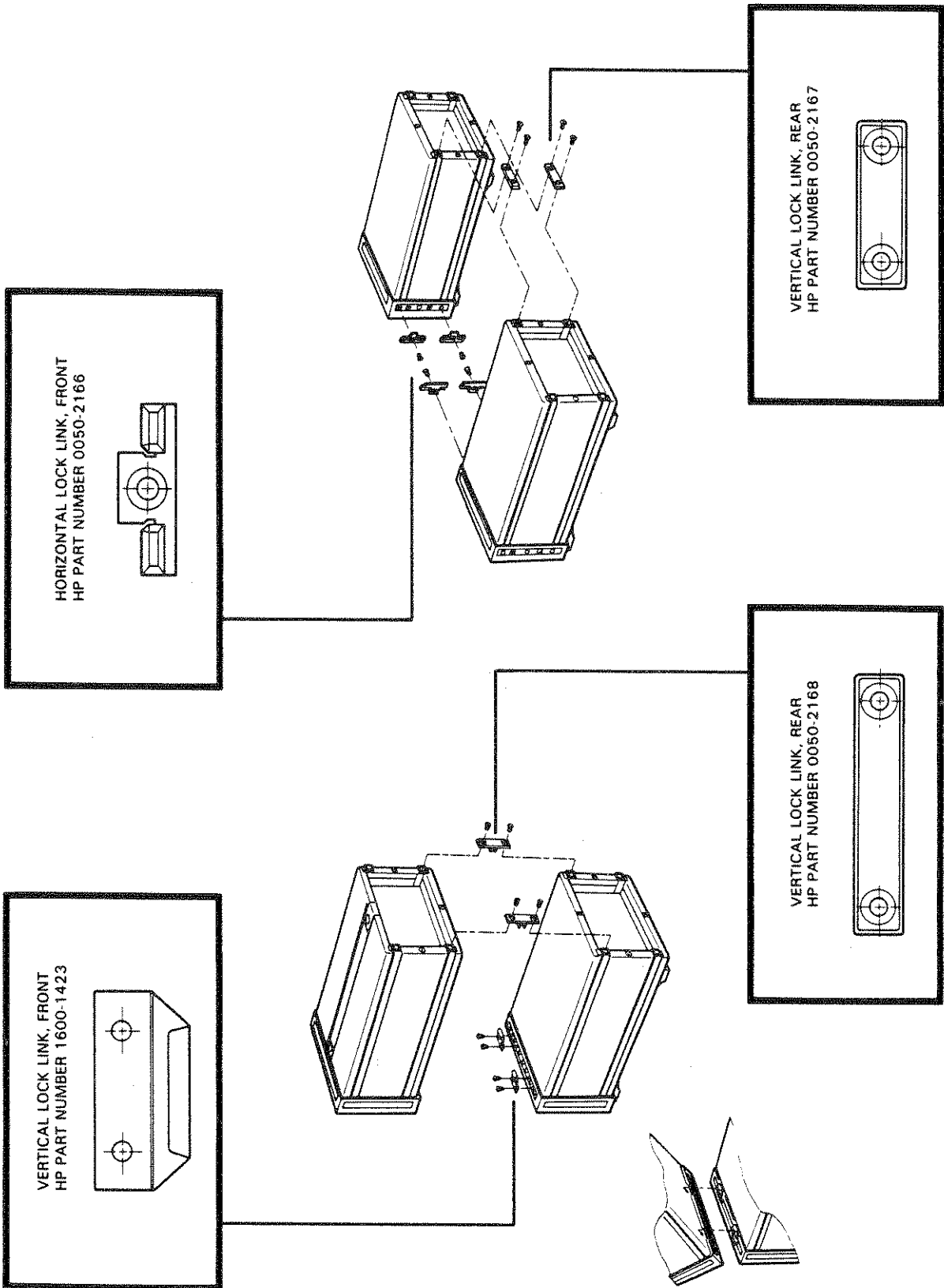

132.6H BAIL HANDLE KIT HALF MODULE

[PRODUCT HT. 132.6mm/5.219 in.]

HP PART NUMBER 5061-9702

CONTENTS

QTY.	PART NO.	"INCH" EQUIV. PART NO.
1	BAIL HANDLE ASS'Y 5061-0036	
2	BAIL HANDLE ADAPTER 5040-7217	
2	BAIL HANDLE RETAINER 5040-7216	
2	M4 x 0.7 x 16 SCREW, PAN HEAD . . . 0515-1106	2510-0194
2	SPACER 0380-1721	

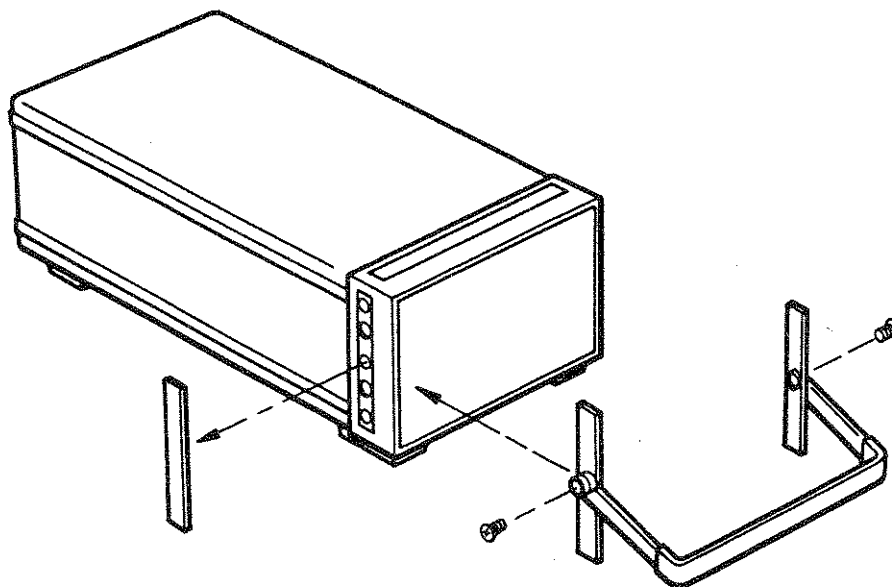

CAUTION: PLEASE VERIFY THE METRIC (5021-) OR THE INCH (5020-) PART NUMBER ON TOP OF THE FRONT FRAME OF THE CABINET FOR THE CORRECT SCREWS.

INSTRUCTIONS

1. REMOVE SIDE TRIM STRIPS.
2. ATTACH HANDLE ASSEMBLY WITH 1 SCREW PER SIDE.

MADE IN USA 2/85
LABEL NO. 5958-3340

FEET-REAR PANEL STAND-OFF FULL & SUB MODULES

HP PART NUMBER 5061-9709

CONTENTS

QTY.		PART NO.	"INCH" EQUIV. PART NO.
4	FOOT-REAR PANEL STAND-OFF	5040-7221	
4	M3.5 x 0.6 x 8 PAN HD. SCREW	0515-1232	2360-0195

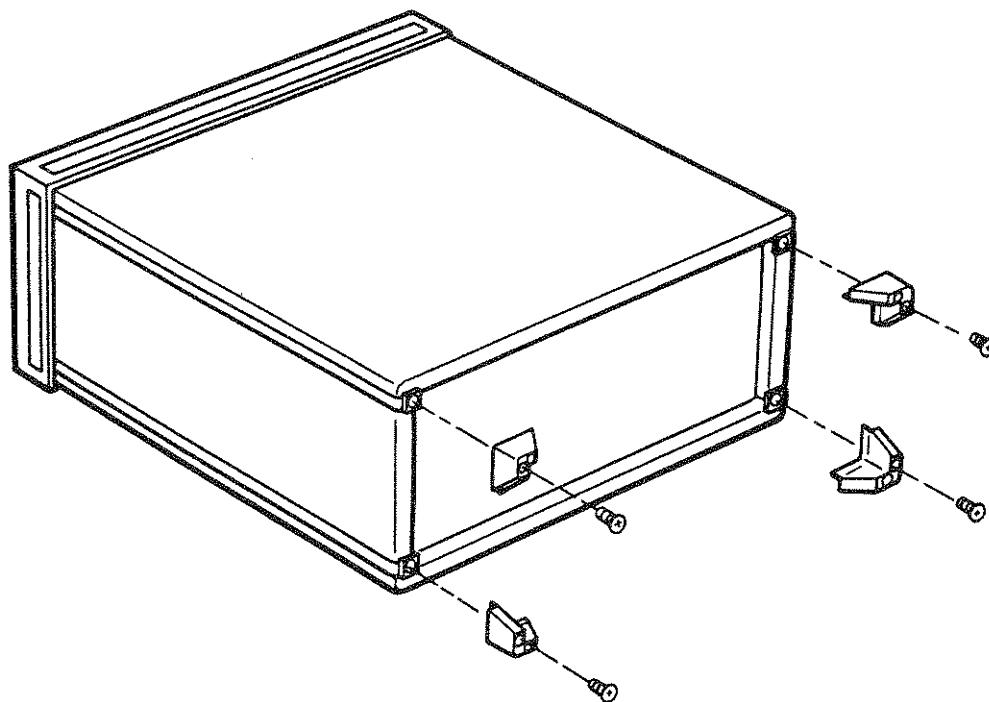

CAUTION: PLEASE VERIFY THE METRIC (5021- . . .) OR THE INCH (5020- . . .) PART NUMBER ON THE REAR FRAME OF THE CABINET FOR THE CORRECT SCREW.

INSTRUCTIONS

1. PLACE ONE FOOT OVER EACH CORNER BOSS ON REAR CASTING AND SECURE WITH 1 SCREW.

MADE IN USA 2/85
LABEL NO. 5958-3344

FEET-REAR & CORD WRAP SUB MODULES

HP PART NUMBER 5061-9695

CONTENTS

QTY.	PART NO.	"INCH" EQUIV. PART NO.
4.....	FOOT-REAR & CORD WRAP	5040-7213
4.....	M3.5 x 0.6 x 25 PAN HD. SCREW	0515-1233 2560-0209

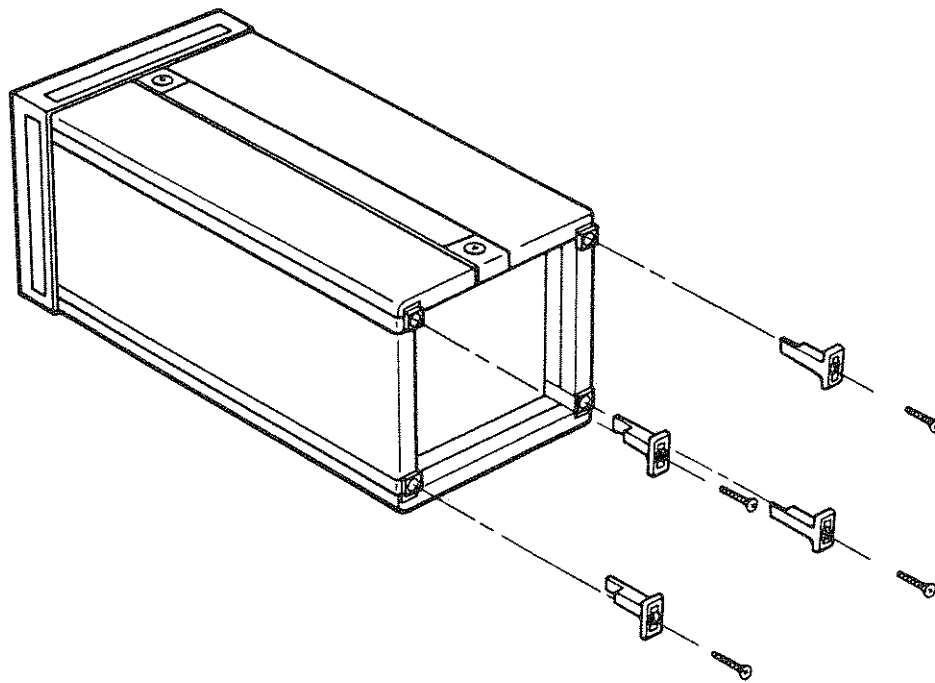

CAUTION: PLEASE VERIFY THE METRIC (5021- . . .) OR THE INCH (5020- . . .) PART NUMBER ON THE REAR FRAME OF THE CABINET FOR THE CORRECT SCREW.

INSTRUCTIONS

1. PLACE ONE FOOT OVER EACH CORNER BOSS ON REAR CASTING AND SECURE WITH 1 SCREW.

MADE IN USA 2/85
LABEL NO. 5958-3334

HP-IB PROGRAMMING SUMMARY

HP-IB Address

The 3314A's HP-IB address is set at the factory to 7. To view the current HP-IB address, press the BLUE shift key and then the LOCAL key. To change the HP-IB address, press the RECALL and then the LOCAL keys, rotate the TUNING KNOB until the desired address is displayed and then press the STORE and LOCAL keys. Listen Only is set by incrementing the address past 30.

3314A Programming Codes

3314A Function	HP-IB Codes		Format of Returned Data	3314A Function	HP-IB Codes		Format of Returned Data
	Program	Query			Program	Query	
Amplitude milli-Volt p-p Volt p-p	AP AV VO	QAP	AP 000000dd.ddVG or AP 000000d.dddVO or AP 000000.ddddVO or AP 00000.0dddVO	Preset	PR		
Amp Modulation OFF ON	AM 0 1	QAM	AMd	Range Down	RD		
ARB OFF ON ON/Clear Wave	AR 0 1 2	QAR	ARd	Range Hold OFF DC Offset Amplitude Frequency	RH G 1 to 2 1 to 4 1 to 8		
Calibrate All	CA			Range Up	RU		
Calibrate Disable	CD			Recall (non-ARB) Register	RC 0 to 5		
Calibrate Enable	CE			Recall Wave (ARB) ARB ON and recall Wave	RW 0 to 5	QRW	RWd
Calibrate Freq	CF			SRQ Mask, bits 0-3 Mask	ML @ to 0		
Data Transfer Mode Unbuffered 96 Byte Buffer	DM 1 2			SRQ Mask, bits 4-7 Mask	MH @ to 0		
Delete Vector	DV			Start Frequency Hertz kilo-Hertz Mega-Hertz	ST HZ KZ MZ	QST	ST 00000000d.HZ or ST 0000000d.dHZ or ST 000000d.ddHZ or ST 000000.dddHZ
Δ t milli-Seconds Seconds	DT MS SN	QDT	DT 00000.0000dSN or DT 0000.0000dSN	Stop Frequency Hertz kilo-Hertz Mega-Hertz	SP HZ KZ MZ	QSP	SP 00000000d.HZ or SP 0000000d.dHZ or SP 000000d.ddHZ or SP 000000.dddHZ
Display Errors OFF ON	DE 0 1			Store (non-ARB) Register	SO 1 to 5		
Error Codes		QER	ERdd	Sweep OFF Linear Log	SW 0 1 2	QSW	SWd
Frequency Hertz kilo-Hertz Mega-Hertz	FR HZ KZ MZ	QFR	FR 00000000d.HZ or FR 0000000d.dHZ or FR 000000.dddHZ or FR 000000d.dddHZ	Sweep Status Mask (bit 5 of Status Byte) Masked = 1 at Start = 1 at Stop = 1 either	SM 0 1 2 3		
Freq Modulation OFF ON	FM 0 1	QFM	FMd	Symmetry Percent	SY PC	QSY	SY 00000000d.PC
Function Invert OFF ON	FI 0 1	QFI	FI d	Sweep/Trig Interval milli-Seconds Seconds	TI MS SN	QTI	TI 00000000d.SN or TI 0000000d.dSN or TI 000000d.ddSN or TI 000000.dddSN or TI 00000.000dSN or TI 0000.000dSN
Function OFF Sine Square Triangle Insert Vector	FU 0 1 2 3 IV	QFU	FU d	Trigger Level 1V Threshold 0V Threshold	LV 1 2	QLV	LVd
Manual Sweep OFF ON	MA 0 1	QMA	MA d	Trigger Slope Positive Negative	SL 1 2	QSL	SLd
Manual Trigger	MN			Trigger Source Internal External	SR 1 2	QSR	SRd
Marker Frequency Hertz kilo-Hertz Mega-Hertz	MK HZ KZ MZ	QMK	MK 00000000d.HZ or MK 0000000d.dHZ or MK 000000.dddHZ or MK 000000d.dddHZ	VCO OFF ON	VC 0 1	QVC	VCd
Mode Free Run Gate N Cycle 1/2 Cycle Fin X N Fin + N	MO 1 2 3 4 5 6	QMO	MO d	Vector Height Enter	VH EN	QVH	VHs00000000d.EN
N Enter	NM EN	QNM	NM 00000000d.EN	Vector Length Enter	VL EN	QVL	VL 00000000d.EN
Offset Volts DC	OF VO	QOF	Ofs0000000d.dVVO or Ofs000000d.dddVO	Vector Marker Enter	VM EN	QVM	VM 00000000d.EN
Phase degree	PH DG	QPH	PHs00000000d.dDG PHASE				
PLL Status Mask (bit 5 of Status Byte) Masked = 1 at Lock = 1 at Unlock = 1 either	PM 0 1 2 3						

d = ASCII digits 0 to 9.

s = sign bit, ASCII space or -.

All other characters are exactly as shown.

All returned data is followed by an ASCII carriage return and line feed. EOI remains false.

HP-IB PROGRAMMING SUMMARY (cont)

Status Byte

Bits of the Status Byte are set (1) only after unmasking that bit and the condition is met. All bits are reset immediately after the Status Byte is sent.

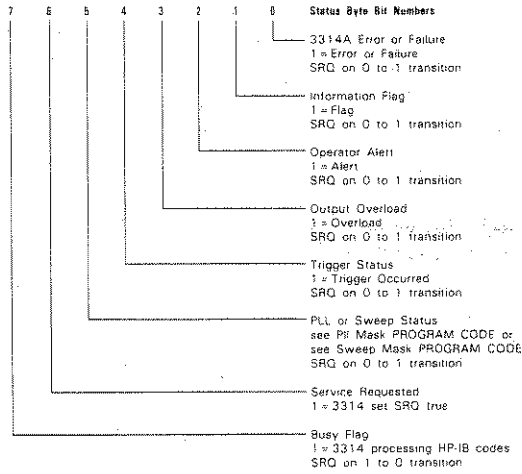

Unmasking The Status Byte

The 3314A will Request Service (SRQ line true) when a bit of the Status Byte is unmasked and the operating condition to set that bit exists. Masking is not affected by PRESET or CLEAR 7. All bits except bit 7 will set SRQ at the 0 to 1 logic transition. Bit 7 will set SRQ at the 1 to 0 logic transition and is useful when using Data Transfer Mode 2, indicating when the 3314A is ready to be programmed again.

	3	2	1	0	Bit Number		7	6	5	4	Bit Number
ML						MH					
@	MASKED	MASKED	MASKED	MASKED		@	MASKED	MASKED	MASKED	MASKED	
A	MASKED	MASKED	MASKED	UNMASKED		A	MASKED	MASKED	MASKED	UNMASKED	
B	MASKED	MASKED	MASKED	UNMASKED		B	MASKED	MASKED	UNMASKED	MASKED	
C	MASKED	MASKED	UNMASKED	UNMASKED		C	MASKED	MASKED	UNMASKED	UNMASKED	
D	MASKED	UNMASKED	MASKED	MASKED		D	MASKED	MASKED	MASKED	MASKED	
E	MASKED	UNMASKED	MASKED	UNMASKED		E	MASKED	MASKED	MASKED	UNMASKED	
F	MASKED	UNMASKED	UNMASKED	MASKED		F	MASKED	MASKED	UNMASKED	MASKED	
G	MASKED	UNMASKED	UNMASKED	UNMASKED		G	MASKED	MASKED	UNMASKED	UNMASKED	
H	UNMASKED	MASKED	MASKED	MASKED		H	UNMASKED	MASKED	MASKED	MASKED	
I	UNMASKED	MASKED	MASKED	UNMASKED		I	UNMASKED	MASKED	MASKED	UNMASKED	
J	UNMASKED	MASKED	UNMASKED	MASKED		J	UNMASKED	MASKED	UNMASKED	MASKED	
K	UNMASKED	MASKED	UNMASKED	UNMASKED		K	UNMASKED	MASKED	UNMASKED	UNMASKED	
L	UNMASKED	UNMASKED	MASKED	MASKED		L	UNMASKED	MASKED	MASKED	MASKED	
M	UNMASKED	UNMASKED	MASKED	UNMASKED		M	UNMASKED	MASKED	MASKED	UNMASKED	
N	UNMASKED	UNMASKED	UNMASKED	MASKED		N	UNMASKED	MASKED	UNMASKED	MASKED	
O	UNMASKED	UNMASKED	UNMASKED	UNMASKED		O	UNMASKED	MASKED	UNMASKED	UNMASKED	

Error Codes

ER #	Definition	Status Byte Bit #	ER #	Definition	Status Byte Bit #
00	No errors since errors were last queried (HP-IB function, only)			...	
	... OPERATOR ERRORS (Non-ARB)	
C1	Frequency/Symmetry conflict	0	30	No frequency detected	0
O2	Bus address entry error	0	31	Frequency error exceeds correction capability	0
O3	Front panel key failure	0	32	Frequency unstable during calibration	0
O4	Calibration measurements not performed	1		... AMPLITUDE CALIBRATION ERRORS ...	
O5	Allowed in sweep, only	0	34	Signal amplitude outside measurement range	0
O6	Not allowed in sweep	0	35	Signal amplitude gain too high	0
O7	Not allowed in log sweep	0	36	Signal amplitude gain too low	0
O8	Store 0 not allowed	0	37	Signal amplitude gain out of limit	0
O9	Non-volatile memory lost; battery down	0	38	Signal amplitude gain offset out of limit	0
	... OPERATOR ERRORS (ARB) HP-IB ERRORS ...	
10	Vector insert not allowed	0	41	Mnemonic invalid	0
11	Vector delete not allowed	0	42	Definition number invalid	0
18	Allowed in ARB, only	0	43	Data invalid	0
19	Not allowed in ARB	0	44	Units invalid	0
	... PLL ERRORS ...		45	Range Hold not allowed	0
20	Unstable input frequency	1	46	ARB/SWEEP parameter conflict	0
21	Input frequency outside of capture range	1	47	Not allowed in Manual Sweep	0
22	3314A output frequency would be out of range	1		... OVERLOAD ...	
23	Internal interval > 20ms	1	50	AM or FM/VCO input voltage exceeds normal operating limits (HP-IB) function only	1
24	Internal synthesis unlocked	0	51	Output voltage exceeds safe operating limits; or, excessive external voltage (greater than ±15V peak) applied to main output. 3314A has disconnected itself.	3

SECTION III OPERATION

3-1. INTRODUCTION

This section contains a front and rear panel overview, error code listing, and an HP-IB summary. The Operating Manual should be used for detailed operating information.

Table 3. Error Codes With Status Byte Bit#

Error #	Definition	Status Byte bit #
00	No Error (used via HP-IB, only)	
	--- OPERATOR ERRORS (non-ARB) ---	
01	Frequency/Symmetry conflict	0
02	Bus address entry error	0
03	Front panel failure/Invalid keycode	0
04	Calibration measurement not performed	1
05	Allowed in sweep, only	0
06	Not allowed in sweep	0
07	Not allowed in log sweep	0
08	Store 0 not allowed	0
09	Non-volatile memory lost;battery down	0
	--- OPERATOR ERRORS (ARB) ---	
10	Vector insert not allowed	0
11	Vector delete not allowed	0
18	Allowed in ARB, only	0
19	Not allowed in ARB	0
	--- PLL ERRORS ---	
20	Unstable input frequency	1
21	Input frequency outside of acquisition range	1
22	3314A output frequency would be out of range	1
23	SW/TR INTVL >20ms	1
24	Internal phase locked loop, unlocked	0
	--- FREQUENCY CALIBRATION ERRORS ---	
30	No frequency detected	0
31	Frequency error exceeds correction capability	0
32	Frequency unstable during calibration	0
	--- AMPLITUDE CALIBRATION ERRORS ---	
34	Signal amplitude outside measurement range	0
35	Signal amplitude gain too high	0
36	Signal amplitude gain too low	0
37	Signal amplitude gain exceeds correction capability	0
38	Signal amplitude gain offset exceeds correction capability	0
	--- HP-IB ERRORS ---	
41	Mnemonic invalid	0
42	Definition number invalid	0
43	Data invalid	0
44	Units invalid	0
45	Range Hold not allowed	0
46	ARB/SWEEP parameter conflict	0
47	Not allowed in MAN Sweep	0
	--- OVERLOAD ---	
50	AM or FM/VCO input voltage exceeds normal operating limits	1
51	Output voltage exceeds safe operating limits; or, excessive external voltage (greater than $\pm 15V$ peak) applied to main output. 3314A has disconnected itself.	3

) C

) C

) C

THE 3314A REAR PANEL

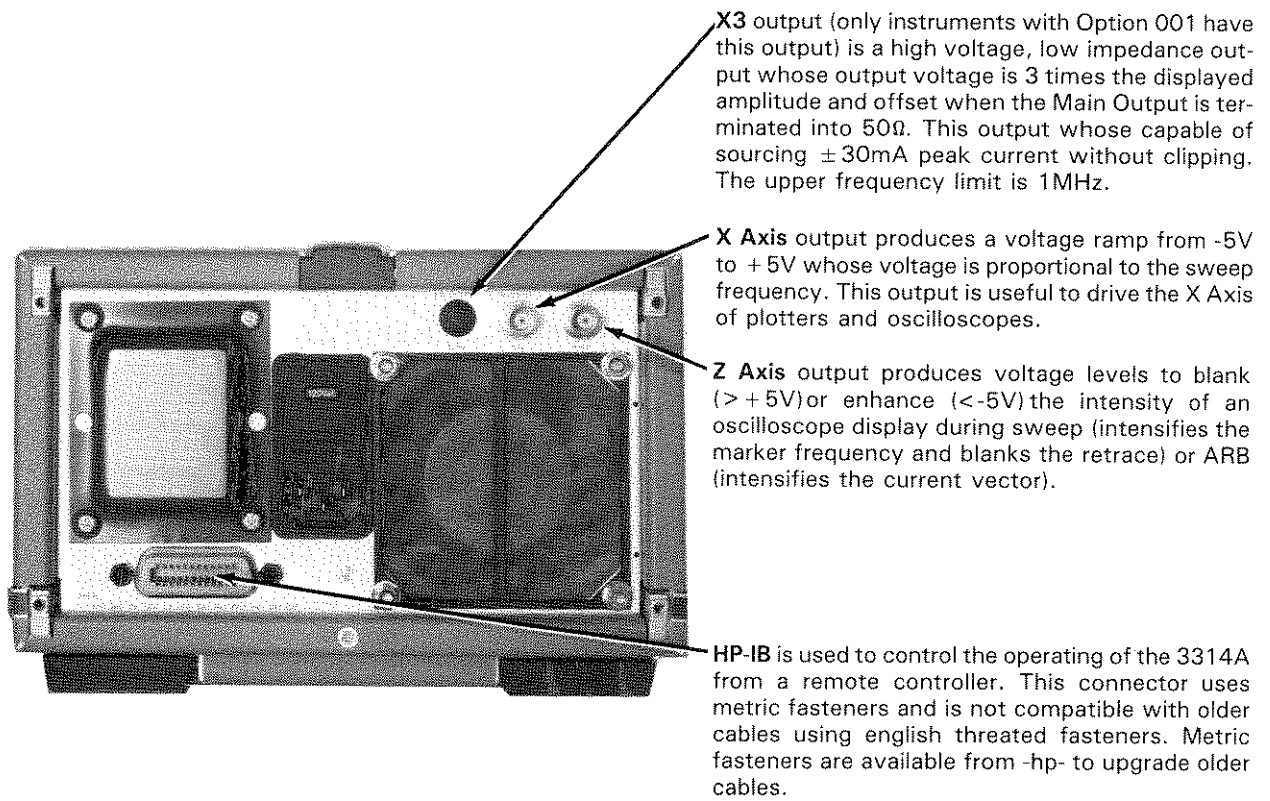

Figure 3-1a. 3314A Rear Panel

THE 3314A FRONT PANEL

1

Status

This group contains the HP-IB status indicators and the LCL key to switch control of the 3314A from remote to front panel operation. When the LCL key is preceded by the BLUE shift key, the 3314A displays its HP-IB address for 1/2 second. The HP-IB address is set from the front panel and stored in non-volatile memory. The factory setting is 7. See "How to Change the 3314A's HP-IB Address" located in the HP-IB section of this manual.

2

Mode

The 3314A has 7 basic operating modes. The trigger signal, either the 3314A's internal trigger source or an external signal you supply, is essential to every operating mode except FREE RUN with sweep off.

FREE RUN Mode. The 3314A outputs continuous Sine, Square, Triangle or ARB functions. Continuous functions, sweeps and ARB operations are allowed. See "How to Use the FREE RUN Mode".

GATE Mode. The output is "gated" ON and OFF by the Trigger level. Gated functions, sweeps and ARB operations are allowed. See "How to Use the GATE Mode".

N CYCLE Mode. The 3314A outputs a burst of N complete cycles of the selected function, starting when a Trigger edge is received. The N parameter sets the number of cycles from 1 to 1999. The start/stop phase is set with the Phase parameter from -90° to +90°. See "How to Use the N CYCLE Mode".

1/2 CYCLE Mode. The 3314A outputs alternate 1/2 cycles of the selected function when a Trigger edge is received. The start phase of the first 1/2 cycle (and the stop phase of the second 1/2 cycle) is set with the Phase parameter from -90° to +90°. See "How to Use the 1/2 CYCLE Mode".

Fin X N Mode. The 3314A will phase lock to the Trigger (reference) signal and output a frequency "N" times the reference frequency. The N parameter sets "N" from 1 to 1999. The frequency limits for both the 3314A and the reference are from 50Hz to 20MHz. See "How to Use the PHASE LOCK Modes".

Fin + N Mode. The 3314A will phase lock to the Trigger (reference) signal and output a frequency equal to the reference frequency divided by "N". The N parameter sets "N" from 1 to 1999. The frequency limits for both the 3314A and the reference are from 50Hz to 20MHz. See "How to Use the PHASE LOCK Modes".

ARB Mode. The ARB mode redefines the 3314A as an Arbitrary Waveform Generator. The output waveform consists of a series of voltage ramps called vectors. The operator has control over the number of vectors, the length of each vector in time and the height of each vector. Both continuous ARB functions (FREE RUN Mode) and gated ARB (GATE Mode) are allowed. See "How to Use the ARB Mode".

3

Preset

The Preset key initializes the 3314A to its basic operating state. This feature is especially useful to quickly recover from complex operating states.

4

Store/Recall

Up to 5, non-ARB front panel control settings can be stored in registers 1 through 5 to be recalled in the future. Register 0 is reserved for the front panel setting at power off. In addition, 6 ARB waveforms can be recalled from ARB registers 0 through 5. ARB waveforms are automatically stored as they are created.

5

External Trigger

One EXT Trigger is a signal you apply to the Trigger I/O port that satisfies the selectable slope and threshold conditions (note that the Trigger I/O port is an input when EXT Trigger is selected). EXT Triggers are level sensitive for Gate; edge sensitive for Burst, Phase Lock and Sweep operations.

Another EXT Trigger is the MAN key. You will have to press this key twice when in Gate mode, to simulate a complete trigger cycle (both levels). Once is sufficient for all other operations. The minimum signal that will consistently trigger the 3314A is $\geq 300\text{mVp-p}$, centered on the selected trigger threshold voltage.

There are two EXT Triggers available from the HP-IB, the Group Execute Trigger (GET) and the "MN" programming command.

6

Internal Trigger

The SW/TR INTVL parameter sets the period of the internal trigger (note that the Trigger I/O port is an output when INT trigger is selected). This output signal is useful as a sync signal during sweeps, gate and burst operations.

7

External Modulation

Type	Sensitivity	Range
AM	$\pm 1\text{V} \sim 100\%$	0% to > 100%
FM	$\pm 1\text{V} \sim \pm 1\%$ of range	0% to $\pm 1\%$ deviation
VCO	10%/Volt	+10% to -80%, useable to -100%

8

Function

The **MAIN OUTPUT**. This output has a characteristic output impedance of 50Ω. Although operation into other than 50Ω is allowed, the actual AC amplitude and DC offset will be different from the displayed values and the quality of the functions will be degraded at higher frequencies due to transmission line impedance mismatches.

The **SYNC OUTPUT**. This output has a characteristic output impedance of 50Ω when terminated into $\leq 50\Omega$. When terminated into $> 50\Omega$, it will deliver TTL compatible levels of 0 to $> 2.5\text{V}$. The maximum unloaded voltage is limited to $\sim 3\text{V}$. The edges of the sync signal are coincident with the peaks of the sine and triangle functions and coincident with the edges of the square function. This relationship is inverted by Function Invert.

9 Entry/Sweep

Most of the keys in this group are select keys for variable entries. The top row contains select keys for the more universal parameters. Note that the blue shifted definition of these keys presets the parameter. The second row contains the select keys for the 3314A's sweep capabilities. The SW/TR INTVL key is the select key for the sweep interval (SW INTVL) and for the internal trigger interval (TR INTVL). When ARB is active, the sweep functions are redefined to ARB functions. The keys are renamed by the labels below them.

10 Range

RANGE UP or **DOWN** (↑ or ↓) keys multiply or divide the displayed value by 10 until the 3314A's operating limits are reached. This provides an extremely fast method to modify the displayed parameter.

RANGE HOLD inhibits auto-ranging of Frequency (8 ranges), Amplitude (4 ranges), and/or DC Offset (2 ranges) when these parameters are changed with the Modify knob. When in Fin X N and Fin + N, Frequency Range Hold also inhibits auto-acquisition.

11 Modify

All variable parameters (selected by keys in the Entry Group) are entered into the 3314A using the Modify knob or the 1 or I keys. These controls change the value of the displayed operating parameter. The Modify knob has 2 basic operating modes called "Cursor" and "Multi Speed".

CURSOR (a digit is flashing). This mode is useful when making small changes or changes of constant increments. The flashing cursor digit is incremented or decremented by 1 whenever rotation of the Modify knob is sensed. The - and + keys move the cursor through the display.

MULTI SPEED (no digit is flashing). This mode is useful when making large changes. The least significant digit in the display is incremented or decremented 1, 2, 4, 8, 16 or 32 times faster depending upon how fast you turn the Modify knob.

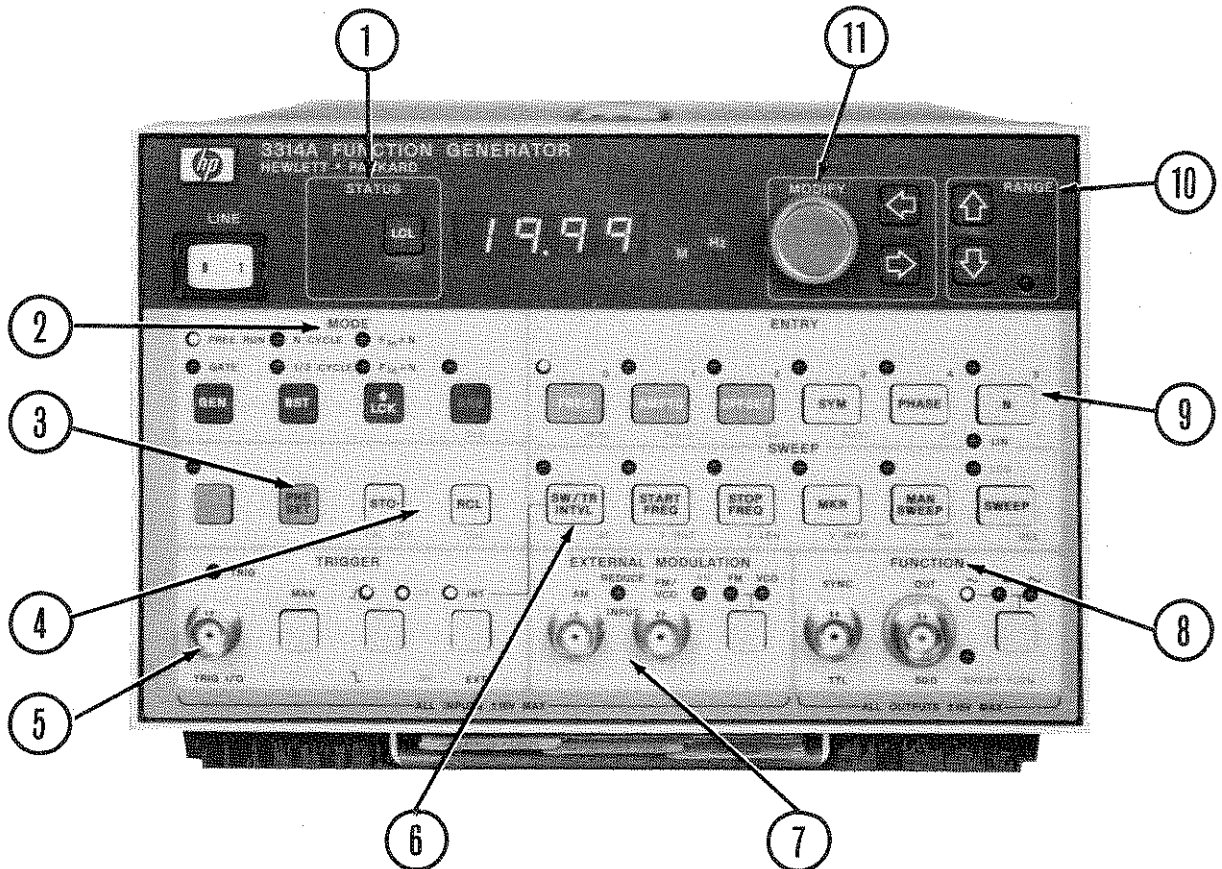

Figure 3-1b. 3314A Front Panel

) C

) C

) C

SECTION IV

PERFORMANCE TESTS

4-1. INTRODUCTION

The following tests are designed to compare various 3314A parameters to their given specifications, in order to determine the functional accuracy of the instrument. Test data can be entered on the Performance Test Record located at the end of this section. The test record, which contains the tested specifications and acceptable limits, may be copied without written permission from the Hewlett-Packard Co. See Section VII, Manual Backdating, for "Δ" explanations.

START FREQ -- 1kHz
 STOP FREQ -- 10kHz
 MKR -- 5kHz

NOTE

The following tests were developed using the equipment listed in Section I of this manual. Equipment with equal or better critical specifications may be used; however, the operator is responsible for the determination of accurate test results.

Table 4-1 Performance Tests

Test Name	Paragraph
Frequency Accuracy	4-2
Time Axis and Variable Symmetry	4-3
Internal Trigger Accuracy	4-4
Triangle Linearity	4-5
Start/Stop Phase Accuracy	4-6
Residual DC and DC Offset Accuracy	4-7
Square Wave Rise Time and Aberrations	4-8
Sine Wave Harmonics	4-9
AM Harmonics	4-10
VCO Linearity	4-11
Phase Locked Loop Phase Accuracy	4-12
Amplitude Accuracy	4-13
Sine Wave Power Flatness	4-14
Manual Sweep Accuracy	4-15
Step Attenuator Accuracy	4-16
Vernier Attenuator Flatness	4-17
Option 001 Test Name	4-18
X3 Gain Accuracy	4-19
Sine Power Flatness	4-20
Harmonic Distortion	4-21
Square Wave Rise/Fall Time	4-22
Residual DC Offset	4-23

4-2. FREQUENCY ACCURACY TEST

This is a test to verify the accuracy of the 3314A output signal frequency.

Specification:

Range 1,2: $\pm(0.4\%$ of setting + 0.2% of range)
 Range 3,4,5,6,: $\pm(0.2\%$ of setting + 0.1% of range)
 Range 7,8: $\pm(0.01\%$ of setting + 50ppm/year)

Equipment Required:

Universal Counter
 50 Ohm Feedthrough Termination

Procedures:

A. Preset the 3314A.

B. Set the 3314A as follows:

Amplitude 1Vp-p
 Frequency 19.99MHz
 Frequency Range Hold On

C. Set the Counter as follows:

Function Freq A
 Resolution 1Hz
 Input Attenuation x1
 Coupling DC
 Channel Input Com

D. Connect the output of the 3314A to the Counter input (see Figure 4-1).

When "PRESET" is pressed on the 3314A, the instrument defaults to the following conditions:

MODE -- Free Run
 FREQ -- 1kHz
 AMPTD -- 100mVp-p
 OFFSET -- 0VDC
 SYM -- 50%
 TRIGGER SLOPE -- Positive
 TRIGGER LEVEL -- 1Vp-p
 TRIGGER SOURCE -- Internal
 PHASE -- 0°
 N -- 1
 SW/TR INTVL -- 10ms

E. Record the Counter frequency to 4 significant digits in the test record. Compare this value to the limits given in part A of Table 4-2 for the frequency setting of 19.99MHz.

F. Using the Range Down function, decrement the frequency of the 3314A to the settings listed in part A of Table 4-2, recording the measured value in the test record.

NOTE

In order to measure the 199.9Hz frequency setting, set the resolution of the counter to 0.1Hz.

G. Using the Modify Knob only, set the frequency of the 3314A to 00.1Hz.

H. Set the Counter to "Per A" and the resolution to 1kHz.

I. Measure the period of the 00.1Hz signal. Take the reciprocal of that value and compare the result to the limits shown in part B of Table 4-2 for the 00.1Hz setting.

J. Set the Counter function to "Freq A" and the resolution to 0.1Hz.

K. Using the Range Up function, increment the value of frequency displayed on the 3314A to the values listed in part B of Table 4-2, recording the measured value in the test record.

NOTE

Allow the Counter at least 15 seconds to stabilize and display the correct frequency measurement.

Table 4-2. Frequency Accuracy Measurement Parameters With Specified Limits

3314A Frequency Setting (A)	Upper Limit	Lower Limit
19.99MHz	19.992MHz	19.988MHz
1999kHz	1999.2kHz	1998.8kHz
199.9kHz	200.5kHz	199.3kHz
19.99kHz	20.05kHz	19.93kHz
1999.Hz	2005Hz	1993Hz
199.9Hz	200.5Hz	199.3Hz
3314A Frequency Setting (B)	Upper Limit	Lower Limit
00.1Hz	0.3Hz	0.0Hz
001H	3Hz	0.0Hz
0.01kHz	30Hz	00Hz
00.1kHz	300Hz	0Hz
001kHz	1000.1Hz	999.9Hz
0.01MHz	10.001kHz	9.999kHz

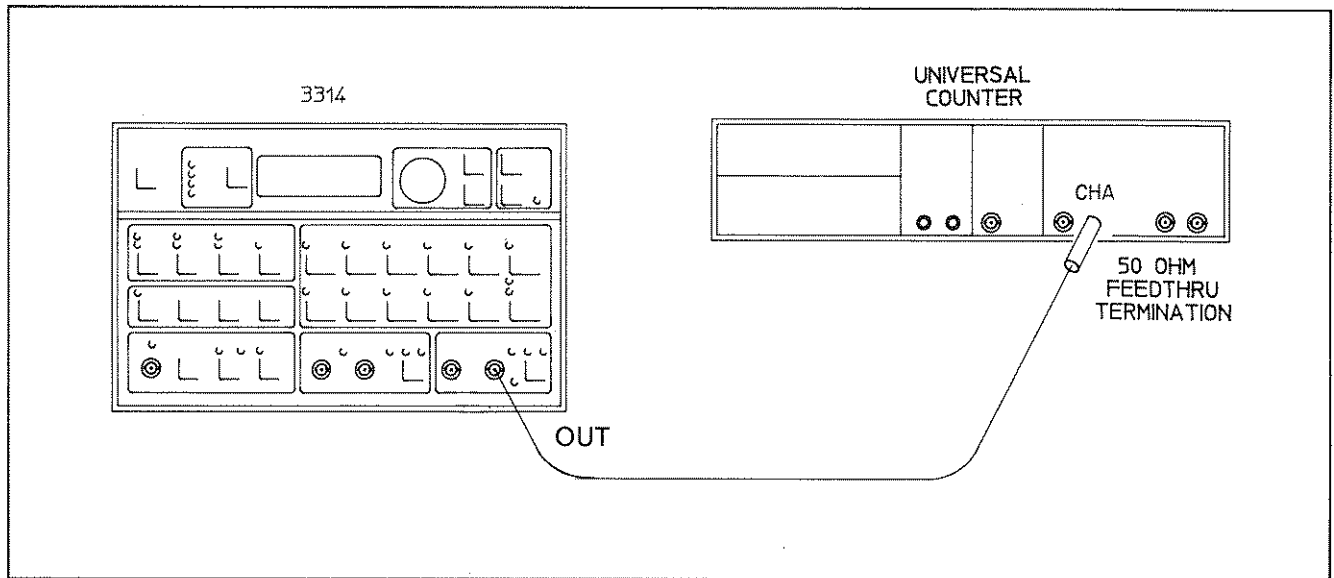

Figure 4-1. Frequency Accuracy Test

4-3. TIME AXIS AND VARIABLE SYMMETRY

This is a test to check the Symmetry function of the 3314A.

Specification:

%Symmetry	Specification
50%	50% ± 0.2% of period
5%	5% ± 0.5% of period
95%	95% ± 0.5% of period

Equipment Required:

- Universal Counter
- 50 Ohm Feedthrough Termination

Procedures:

A. Preset the 3314A.

B. Set the 3314A as follows:

- Function Square
- Frequency 100kHz
- Amplitude 10Vp-p
- Symmetry 50%

C. Set the Counter as follows:

- Function Per Avg A
- Resolution 0.1kHz
- Attenuation x10
- Channel A Slope +
- Channel B Slope -
- Coupling DC (Both Channels)
- Channel Input Com

D. Connect the 3314A to the Counter as shown in Figure 4-2.

E. Record the period of the 3314A Square Wave signal (t) displayed on the Counter.

F. Change the Counter function to "TI Avg A-B".

G. Record reading (t₁).

H. Calculate the percent of symmetry using the following equation and record in the test record:

$$\%Symmetry = (t_1/t)100\%$$

I. Adjust the symmetry on the 3314A to 5%, set the Counter function back to Period Avg A, and repeat steps E through H.

J. Adjust the symmetry on the 3314A to 95%, set the Counter function back to Period Avg A, and repeat steps E through H.

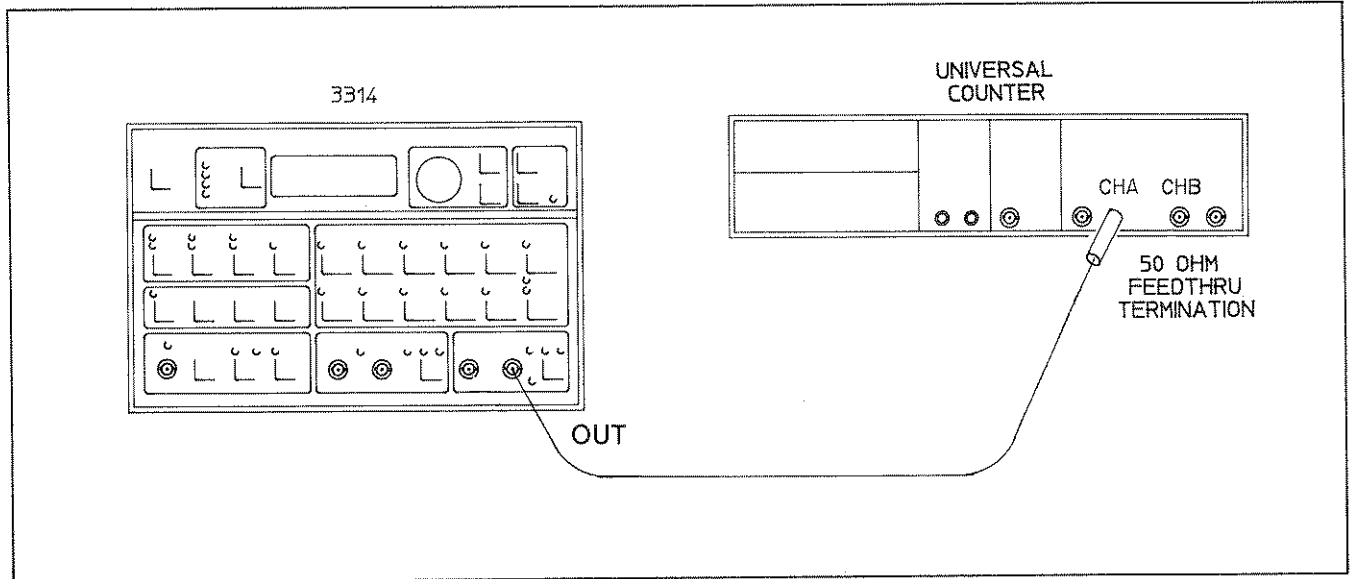

Figure 4-2. Time Axis and Variable Symmetry

4-4. INTERNAL TRIGGER ACCURACY

This test measures the accuracy of the 3314A Internal Trigger Period.

Specification:

$$\pm 0.01\% \text{ of setting} + 50\text{ppm/year}$$

Equipment Required:

Universal Counter

Procedures:

- A. Preset the 3314A.
- B. Set the Counter as follows:

Function	Per Avg A
Resolution	1MHz
Attenuation	x1
Coupling	AC
Channel Input	Com

- C. Connect the 3314A to the Counter as shown in Figure 4-3.

D. Record the measured value of the 3314A trigger period in the test record. The reading should be 10ms $\pm 0.001\text{ms}$.

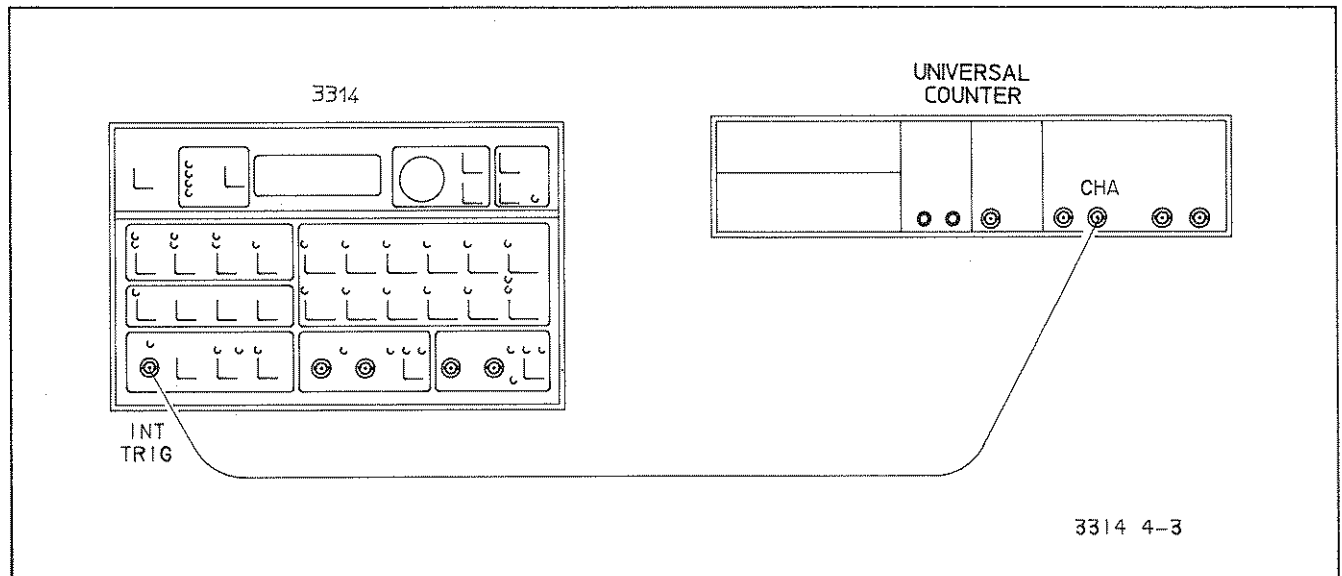

Figure 4-3. Internal Trigger Accuracy

4-5. TRIANGLE LINEARITY

This procedure determines the linearity of the 3314A Triangle wave at frequencies between 1Hz and 1kHz.

Specification:

$\pm 0.2\%$

Equipment Required:

- High Speed Digital Voltmeter
- 50 Ohm Feedthrough Termination
- Triax to BNC Connector

Procedures:

- A. Preset the 3314A.
- B. Set the 3314A as follows:

 Function Triangle
 Amplitude 10Vp-p
- C. Set the Digital Voltmeter as follows:

 Range 10V
 Trigger Ext
 Readings 1
 Delay 0.00055s

D. Connect the 3314A to the Voltmeter as shown in Figure 4-4.

E. Note the Digital Voltmeter reading. Record this value on the Performance Test Record under "Positive Slope Measurement". This is the 10% point on the positive slope of the Triangle (see Figure 4-5).

F. Increment the delay on the Digital Voltmeter to the values listed below. At each increment note and record the corresponding voltage under "Positive Slope Measurement" in the Performance Test Record. (Each increment represents a 10% segment of the positive slope.)

Delay	Percent of Slope
0.00060	20
0.00065	30
0.00070	40
0.00075	50
0.00080	60
0.00085	70
0.00090	80
0.00095	90

G. Measurements for the negative slope of the Triangle wave are made by incrementing the delay on the voltmeter to the values listed below. Note and record the corresponding voltages under "Negative Slope Measurement" in the Performance Test Record.

Delay	Percent of Slope
0.00105	90
0.0011	80
0.00115	70
0.0012	60
0.00125	50
0.0013	40
0.00135	30
0.0014	20
0.00145	10

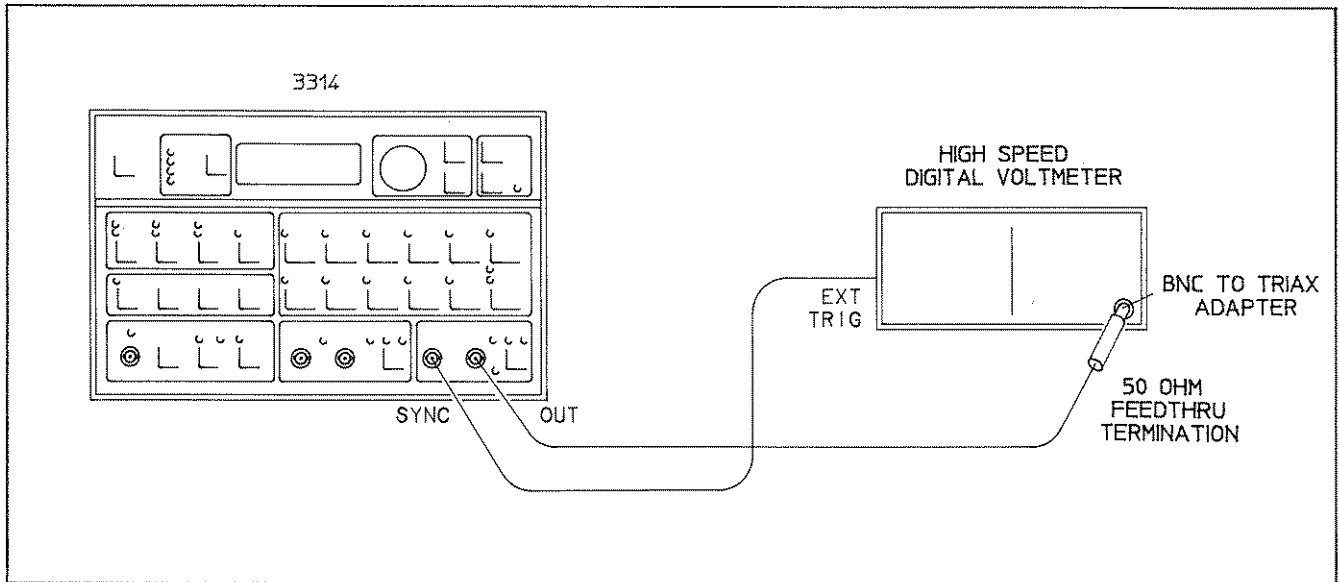

Figure 4-4. Triangle Linearity

H. Algebraically add the voltages recorded in the "Positive Slope Measurement" column and enter the total in the "Σy" space.

I. Multiply Σy by 45 (which is Σx) and enter the result in the ΣxΣy space.

J. Multiply each y value by the corresponding x value and enter the result in the "x Times y" column. Total these values and enter the result in the "Σxy" space.

K. The equation for determining the "best fit straight line" specification for each y value is:

$$y = mx + b$$

where m and b are constants to be calculated from data previously taken.

NOTE

Calculate the values of m and b to at least 5 decimal places.

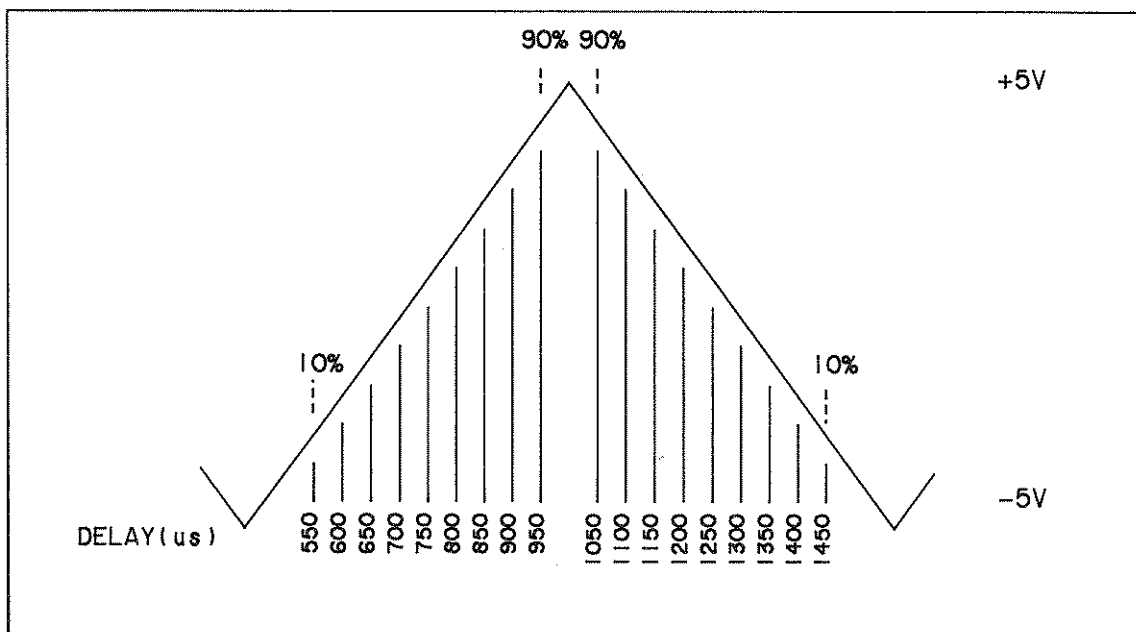

Figure 4-5. Triangle Linearity

L. Determine the value of m using the following equation:

$$m = \frac{\Sigma xy - \Sigma x \Sigma y / n}{\Sigma x^2 - (\Sigma x)^2 / n}$$

where Σx , Σy , Σxy , $\Sigma x \Sigma y$, Σx^2 , and $(\Sigma x)^2$ are the previously calculated values entered on the performance test record, and $n = 9$ (the number of points to be calculated).

M. Determine the value of b using the equation:

$$b = \Sigma y / n - m \Sigma x / n$$

N. Calculate the "best fit straight line" value for y_0 through y_9 using the equation:

$$y = mx + b$$

Enter each result on the Performance Test Record in the "Best Fit Straight Line" column.

O. Algebraically add the voltages recorded in the "Negative Slope Measurement" column and enter the total in the " Σy " space.

P. Repeat steps I through N to determine the "best fit straight line" values for the negative slope.

4-6. Start/Stop PHASE ACCURACY

This test determines the Start/Stop phase accuracy of the N Cycle mode on the 3314A.

Specification:

$$\pm 3^\circ$$

Equipment Required:

- High Speed Digital Voltmeter
- 50 Ohm Feedthrough Termination
- Triax to BNC Connector

Procedures:

A. Preset the 3314A.

B. Set the 3314A as follows:

- Function Triangle
- Amplitude 10Vp-p
- Mode N Cycle
- Trigger Negative Edge

C. Set the Digital Voltmeter as follows:

- Range 10V
- Trigger Ext
- Readings 1
- Delay 0.00025s

D. Connect the 3314A to the Digital Voltmeter as shown in Figure 4-6.

E. Record the voltage reading displayed on the Digital Voltmeter.

F. Set the delay on the Voltmeter to 0.00075s, and record the voltage reading.

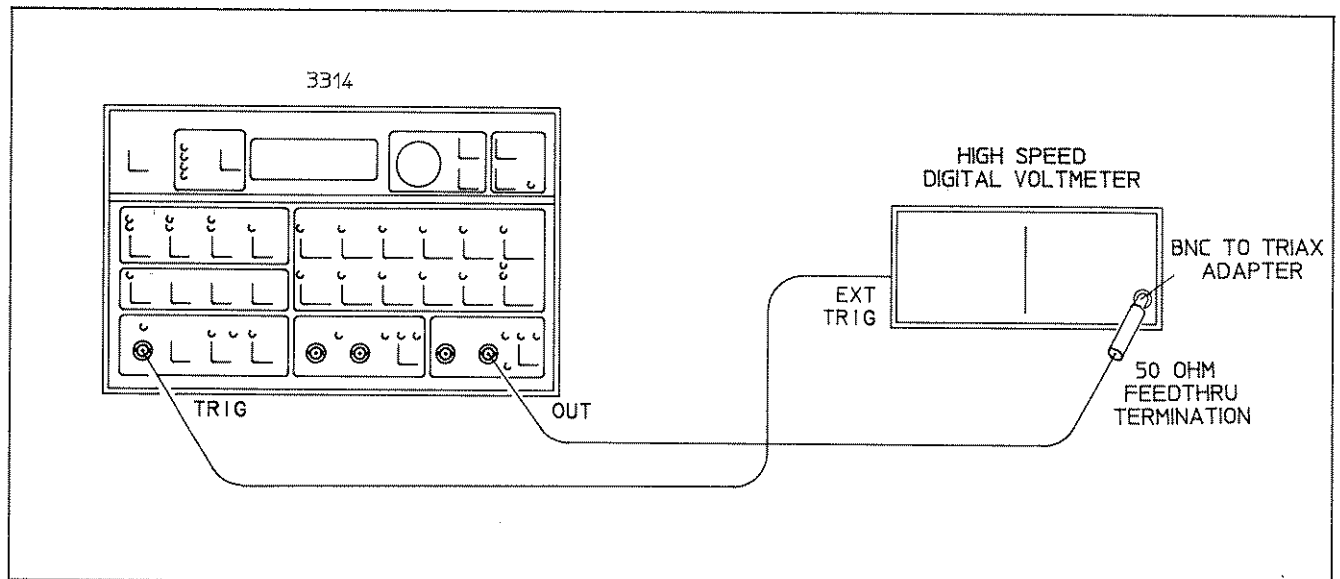

Figure 4-6. Start/Stop Phase Accuracy

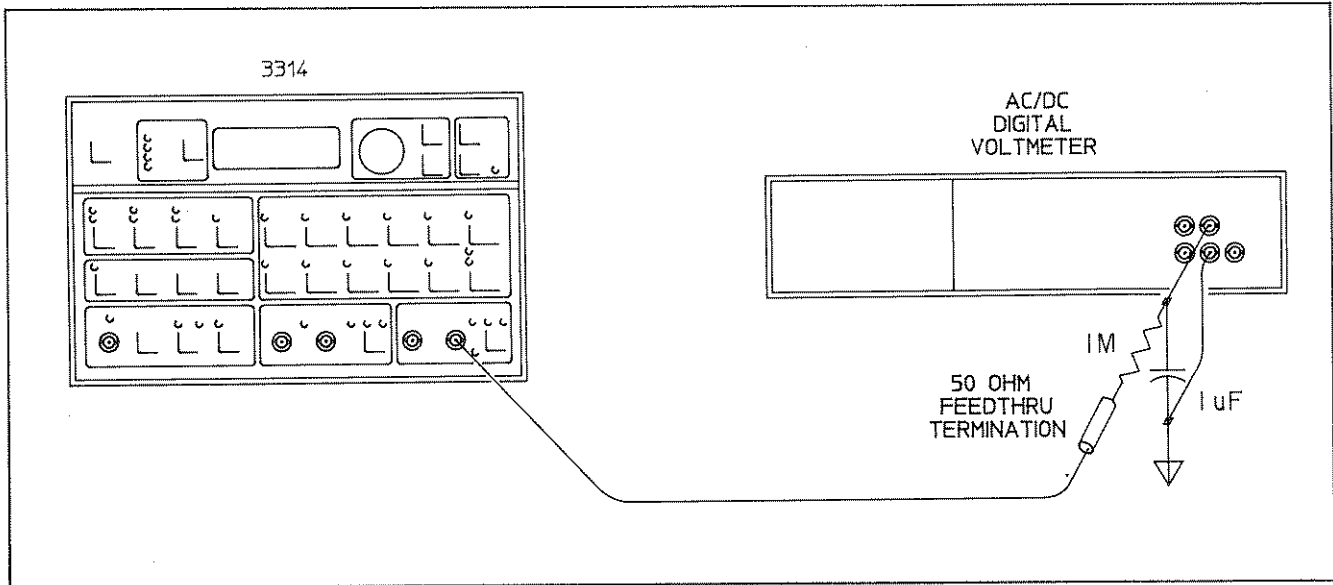

Figure 4-7. Residual and Variable DC Offset Accuracy

G. Average the readings taken in steps E and F and record in the Performance Test Record under "AVG"

H. Set the delay on the Voltmeter to 0.010s, and record the corresponding voltage.

I. This test passes if the average of the readings taken in steps E & F is within $\pm 0.167V$ of the reading taken in step H. (0.167V corresponds to 3° of phase difference.)

4-7. RESIDUAL DC AND DC OFFSET ACCURACY

This is a test to determine the accuracy of the Residual DC Offset (0V DC offset) and the Variable DC Offset function of the 3314A.

Specification:

- Residual: $\pm 0.5\%$ of AC Amplitude Range
- Variable: $\pm (3\%$ of setting, $+10mV$, $+0.5\%$ of AC Amplitude Range)

If option 001:

$\pm 0.5\%$ of AC Amplitude Range $\pm 500\mu V$

Equipment Required:

- AC/DC Digital Voltmeter
- 1 M Ω /1 μF Low Pass Filter
- 50 Ohm Feedthrough Termination

Procedures: (Residual)

A. Preset the 3314A.

B. Set the 3314A as follows:

- Frequency 100kHz
- Amplitude 10Vp-p

C. Set the Digital Voltmeter as follows:

- Function DC
- Trigger Internal
- Range Auto

D. Connect the 3314A to the Digital Voltmeter as shown in Figure 4-7.

E. Record and compare the Residual DC Offset measured on the Digital Voltmeter to the limits corresponding to the 10.00V 3314A setting given in Table 4-3.

NOTE

Tables 4-3 and 4-4 are provided for convenience in spot checking the measured parameters. The values obtained in this test may be permanently recorded in the corresponding section of the Performance Test Record.

F. Using the Range Down function, decrement the amplitude displayed on the 3314A to the values listed in Table 4-3. Record and compare the measured Residual Offset at each decrement to its corresponding limits.

(Variable Offset)

G. Set the amplitude of the 3314A to 10V and adjust the DC Offset to 5V.

H. Record and compare the DC Offset measured on the Digital Voltmeter to the limits shown in Table 4-4 for the 10V setting with 5V DC offset.

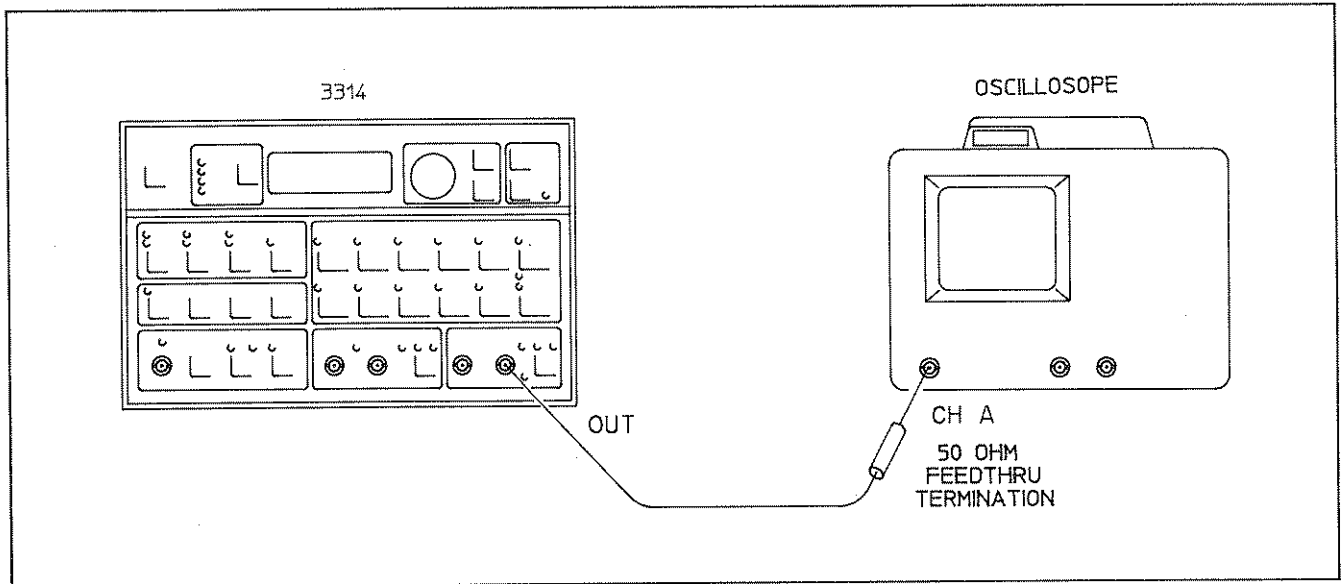

Figure 4-8 Square Wave Rise Time and Aberrations

I. Using the Range Down function, decrement the amplitude of the 3314A to the values shown in Table 4-4, each time recording and comparing the measured Offset to its corresponding limits.

J. Set the amplitude on the 3314A to 10V and adjust the DC offset to 0.887V.

K. Record and compare the DC Offset measured on the Digital Voltmeter to the limits given in the appropriate section of Table 4-4.

L. Repeat step I for the offset of 0.887V.

M. Set the amplitude of the 3314A to 10V and adjust the DC offset to -0.887V.

N. Record and compare the DC Offset measured on the Digital Voltmeter to the corresponding limits shown in Table 4-4.

O. Repeat step I for the offset of -0.887V.

P. Set the amplitude of the 3314A to 10V and adjust the DC offset to -5V.

Q. Record and compare the DC Offset measured on the Digital Voltmeter to the corresponding limits shown in Table 4-4.

R. Repeat step I for the Offset of -5V.

Table 4-3. Residual DC Offset Limits

3314A Voltage Setting	Residual Offset	
	Upper Limit	Lower Limit
10.00V	50mV	-50mV
1.000V	5mV	-5mV
100.0mV	0.5mV	-0.5mV
10.00mV	50µV	-50µV

Table 4-4. Variable DC Offset Limits

Voltage Setting	DC Offset	Upper Limit	Lower Limit
10.00V	5V	5.21V	4.79V
1.000V	5V	5.16V	4.84V
100.0mV	5V	5.16V	4.84V
10.00mV	5V	5.16V	4.84V
10.00V	0.887V	0.974V	0.8V
1.000V	0.887V	0.924V	0.85V
100.0mV	0.887V	0.924V	0.85V
10.00mV	0.887V	0.924V	0.85V
10.00V	-0.887V	-0.8V	-0.974V
1.000V	-0.887V	-0.85V	-0.924V
100.0mV	-0.887V	-0.85V	-0.924V
10.00mV	-0.887V	-0.85V	-0.924V
10.00V	-5V	-4.79V	-5.21V
1.000V	-5V	-4.84V	-5.16V
100.0mV	-5V	-4.84V	-5.16V
10.00mV	-5V	-4.84V	-5.16V

4-8. SQUARE WAVE RISE TIME AND ABERRATIONS

This test examines the Rise/Fall time and Aberrations of the 3314A Square Wave signal.

Specification:

Square Wave Rise/Fall Time
 10% to 90%) 9ns
 Square Wave Aberrations <5% at 10Vp-p

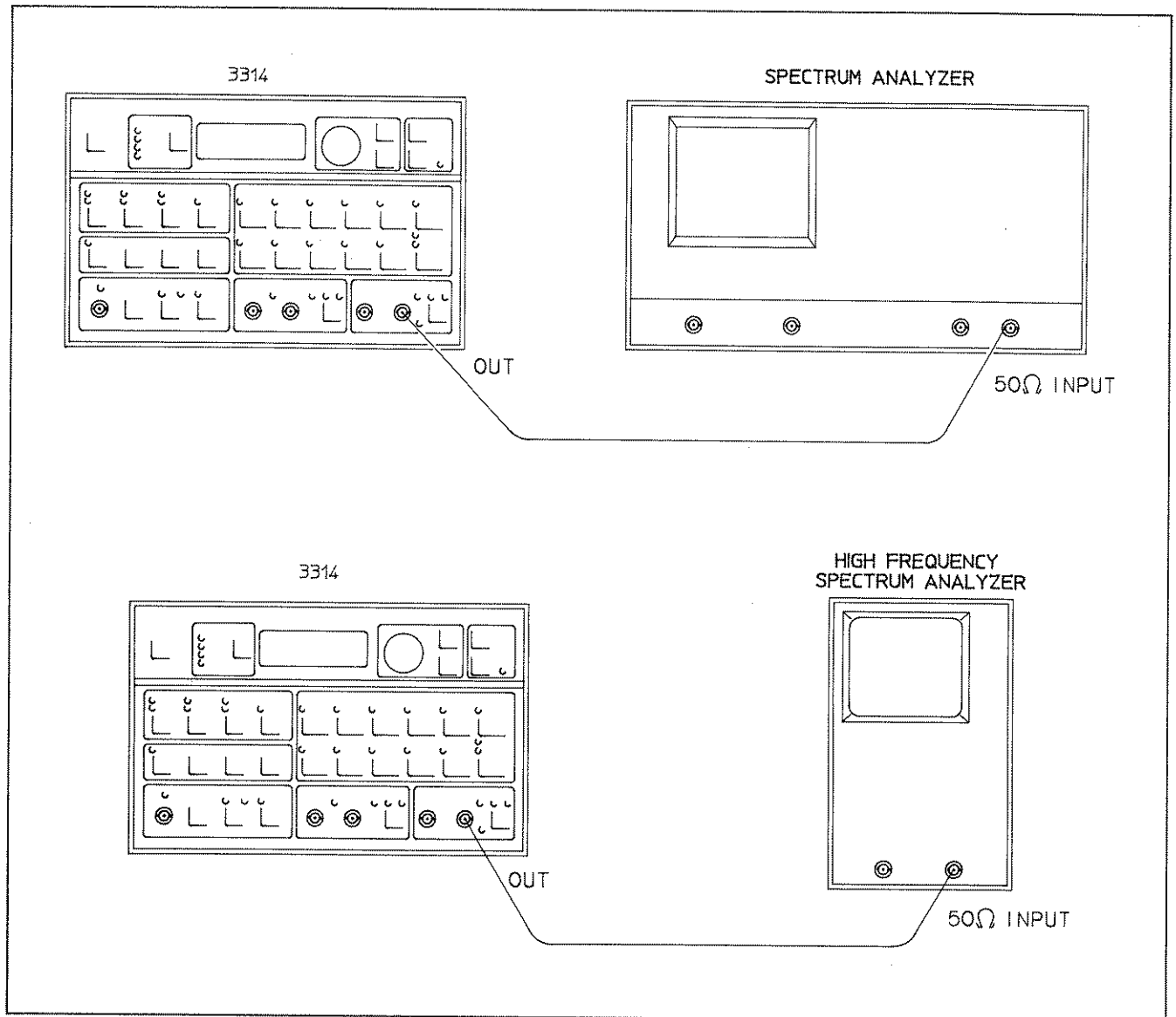

Figure 4-9. Sine Wave Harmonics

Equipment Required:

- Oscilloscope
- 50 Ohm Feedthrough Termination

Procedures:

A. Preset the 3314A.

B. Set the 3314A as follows:

- Function Square
- Frequency 19.99MHz
- Amplitude 10Vp-p

C. Set the Oscilloscope as follows:

- Volts/Div 2V
- Time/div 0.01us/cm
- Coupling DC
- Horizontal Display Main
- Main Triggering Positive

D. Connect the 3314A to the Oscilloscope as shown in Figure 4-8.

E. While observing the waveform on the Oscilloscope, use the Horizontal Position knob to ad-

just the waveform until the bottom of the Square wave's rising edge is on top of the Y-axis graticule. Note the distance between the 10% and 90% points on the rising edge. If the distance between the points is less than or equal to .9cm. (note scope setting), the specification is met.

F. Set the Main Triggering function of the Oscilloscope to negative.

G. Observe the trailing edge of the waveform. Note the distance between the 90% and 10% points. If the distance is less than or equal to .9cm, the test passes.

H. Set the Time/div setting on the Oscilloscope to 1us/cm.

I. Rotate the Oscilloscope's "Cal" knob (located on the VOLTS/DIV knob) counterclockwise until the waveform is four divisions tall. The "intensified" portion on the top of the wave should be <0.5V (1 minor division).

4-9. SINE WAVE HARMONICS

This is a test to check the amplitude levels of the Sine Wave Harmonics.

Specification:

20Hz to 50kHz	- 55dB
50kHz to 1.999MHz	- 40dB
1.999MHz to 19.99MHz	- 25dB

Equipment Required:

- Spectrum Analyzer
- High Frequency Spectrum Analyzer

Procedures:

A. Preset the 3314A.

B. Set the 3314A as follows:

Frequency	20.0Hz (Range 3)
Amplitude	10Vp-p
Function	Sine
Range Hold	On

C. Connect the 3314A to the Spectrum Analyzer as shown in Figure 4-9.

NOTE

To get to the frequencies listed in the following ranges (see Tables 4-5, 4-6, 4-7), set the 3314A to the middle value in the range (i.e. range 3, 100.0Hz), activate Range Hold, then use the Modify knob to select the frequencies. Be sure that the frequency on the 3314A is set exactly as shown in the table.

D. To verify that the Sine wave harmonics are within specification, set the Spectrum Analyzer as follows:

1. Press "INSTR PRESET".
2. Press "DSPL LINE" and adjust the Control knob for a -55 dB level.
3. Press "STOP FREQ" and set it to 8 times the 3314A frequency setting.
4. Press "MARKER" and using the Control knob, place it over the fundamental.
5. Press "MKR--REF LVL" and wait for the sweep to update the screen display.

E. Observe the harmonics displayed on the Spectrum Analyzer and verify that they are below the -55dB level.

F. Repeat steps D (parts 3-5) and E for the 3314A frequency settings listed in Tables 4-5 and 4-6 whose harmonic level specification is -55dB.

G. Press "INSTR PRESET" on the Spectrum Analyzer.

H. Press "DSPL LINE" and adjust the Control knob for a -40dB level.

I. Repeat step D, parts 3-5 for the 3314A frequency settings listed in Table 4-6 whose harmonic level specification is -40dB. Verify that these levels are within the specification.

J. Disconnect the 3314A from the Spectrum Analyzer.

K. To measure the harmonics of the frequencies listed in Table 4-7, connect the 3314A to the High Frequency Spectrum Analyzer as shown in Figure 4-9.

L. Set the frequency of the 3314A to 1.00MHz.

M. Set the High Frequency Spectrum Analyzer as follows:

Input Range	+ 30dBm
Time/div	Auto
Start Frequency	1MHz

N. Measure 2nd through 7th harmonics.

O. Set the frequency on the 3314A to 10.00MHz, and adjust the start frequency on the High Frequency Spectrum Analyzer to 10MHz.

P. Measure 2nd through 7th harmonics.

Q. Set the frequency on the 3314A to 19.99MHz, and adjust the start frequency on the High Frequency Spectrum Analyzer to 19.99MHz.

R. Measure the 2nd through 7th harmonics.

SINE WAVE HARMONICS

**Table 4-5. Sine Wave Harmonic Test Frequencies
3Hz Resolution Bandwidth**

3314A Frequency	Range	Harmonics dB					
		2nd	3rd	4th	5th	6th	7th
20.0Hz	3						
100.0Hz	3						
199.9Hz	3						
100.Hz	4			-55dB			
1000.Hz	4						
1999.Hz	4						

**Table 4-6. Sine Wave Harmonic Test Frequencies
300Hz Resolution Bandwidth**

3314A Frequency	Range	Harmonics dB					
		2nd	3rd	4th	5th	6th	7th
1.00kHz	5						
10.0kHz	5						
19.99kHz	5						
10.0kHz	6			-55dB			
100.0kHz	6						
199.9kHz	6						
100.kHz	7			-40dB			
1000.kHz	7						
1999.kHz	7						

**Table 4-7. Sine Wave Harmonic Test Frequencies
(High Frequency Spectrum Analyzer)**

3314A Frequency	Range	Harmonics dB					
		2nd	3rd	4th	5th	6th	7th
1.00MHz	8						
10.00MHz	8			-25dB			
19.99MHz	8						

4-10. AM HARMONICS

This test measures the AM envelope distortion.

Specification:

Sideband harmonics 40dB below sideband level

Equipment Required:

- Synthesizer/Function Generator
- Spectrum Analyzer
- 50 Ohm Feedthrough Termination

Procedures:

A. Preset the 3314A.

B. Set the 3314A as follows:

- Frequency 1MHz
- Amplitude 10Vp-p
- External Modulation AM

C. Set the Synthesizer as follows:

- Function Sine
- Frequency 1kHz
- Amplitude 1Vp-p

D. Press "INSTR PRESET" on the Spectrum Analyzer and set it as follows:

- Center Frequency 1MHz
- Frequency Span 10kHz

E. Connect the 3314A to the Synthesizer and Spectrum Analyzer as shown in Figure 4-10.

F. Press "DSPL LINE" on the Spectrum Analyzer and adjust the Control knob for a -46dB level.

G. Press "MARKER" and place it over the carrier peak.

H. Press "MKR → REFLVL".

I. Note the levels of the AM sideband harmonics (located at 1kHz intervals from sideband) relative to "DSPL LINE". The levels should not exceed this reference.

4-11. VCO LINEARITY

This is a test to determine the linearity of the Voltage Controlled Oscillator.

Specification:

± 3% of setting

Equipment Required:

- Power Supply
- Universal Counter
- AC/DC Digital Voltmeter
- 50 Ohm Feedthrough Termination

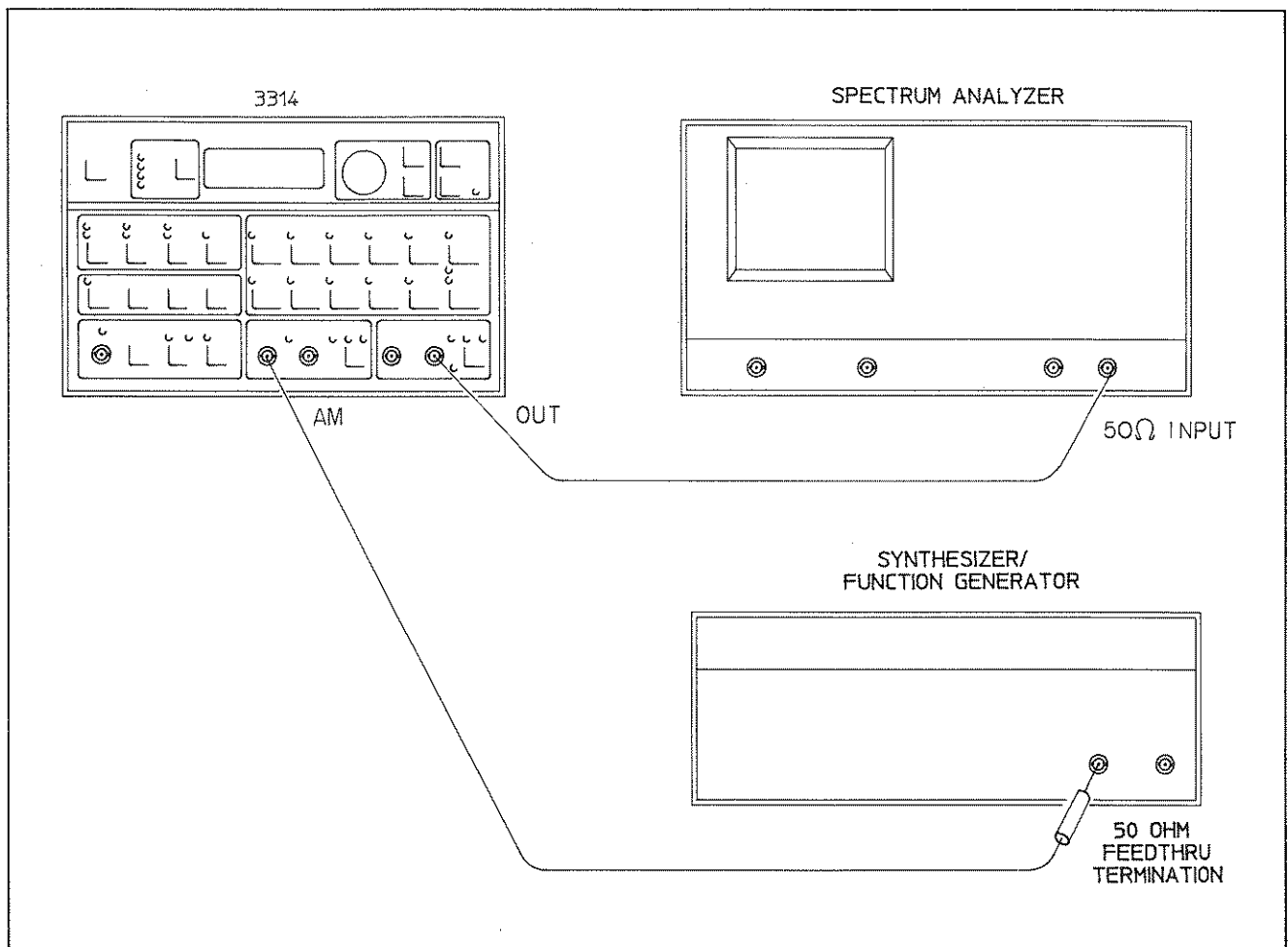

Figure 4-10. AM Harmonics

Procedures:

A. Preset the the 3314A.

B. Set the 3314A as follows:

Frequency 10MHz
 Amplitude 10Vp-p
 VCO On

C. Set the Counter as follows:

Function Frequency A
 Resolution 0.1kHz
 Channel Input Com

D. Set the Voltmeter as follows:

Range Auto
 Function DC
 Trigger Internal

E. Connect the Counter, Voltmeter, and Power Supply to the 3314A as shown in Figure 4-11.

F. Set the power supply voltage to $-8V \pm 10mV$ and record the frequency reading on the Counter. Frequency should be $2MHz \pm 300kHz$.

G. Set the power supply voltage to $-4.5V \pm 10mV$ and record the frequency reading on the Counter. Frequency should be $5.5MHz \pm 300kHz$.

H. Set the power supply voltage to $+1V \pm 10mV$ and record the frequency reading on the Counter. Frequency should be $11MHz \pm 300kHz$.

4-12. PHASE LOCKED LOOP PHASE ACCURACY

This is a test to determine the Phase Accuracy of the 3314A Phase Locked Loop.

Specification:

± 2 degrees of setting

Equipment Required:

- Synthesizer/Function Generator
- Universal Counter
- 50 Ohm Feedthrough Termination

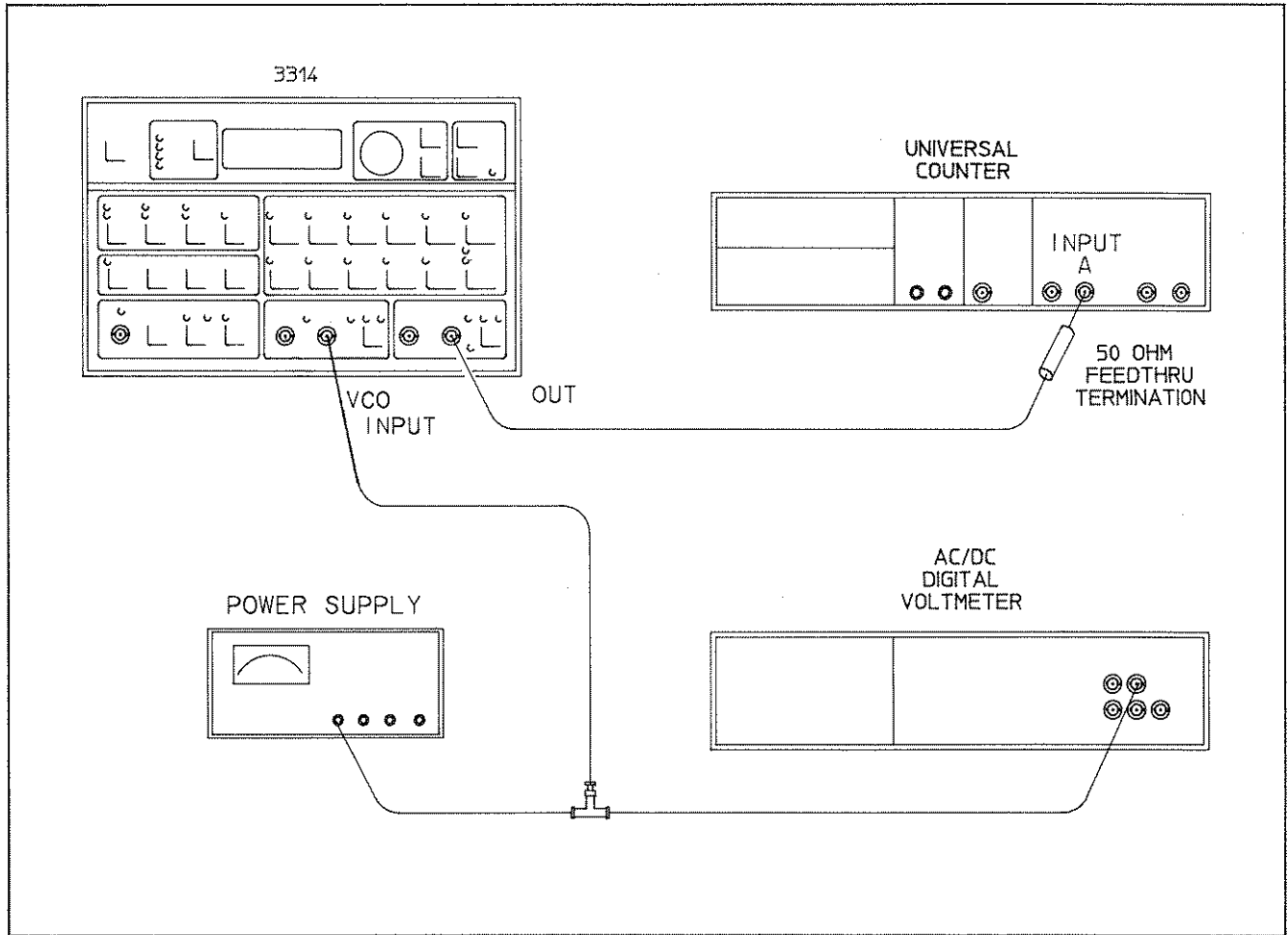

Figure 4-11. VCO Linearity

Procedures:

A. Preset the 3314A.

B. Set the 3314A as follows:

Function Square
 Amplitude 1Vp-p
 Trigger Source Ext
 Mode Fin x N
 Trigger Threshold 0V
 Phase -199.9 degrees

C. Set the Synthesizer/Function Generator as follows:

Function Square
 Amplitude 1Vp-p
 Frequency 50Hz

D. Set the Universal Counter as follows:

Coupling DC
 Attenuation x1
 Slope Setting Cha. +, Chb. +
 Function Period Avg A
 Periods Averaged 10
 Channel Input Sep

E. Connect the Synthesizer/Function Generator and the Universal Counter to the 3314A as shown in Figure 4-12.

F. Note and record the period (t) of the 50Hz signal now being measured on the Universal Counter.

G. Change the function of the Universal Counter to "TI Avg A-B" and record the corresponding period (t_1).

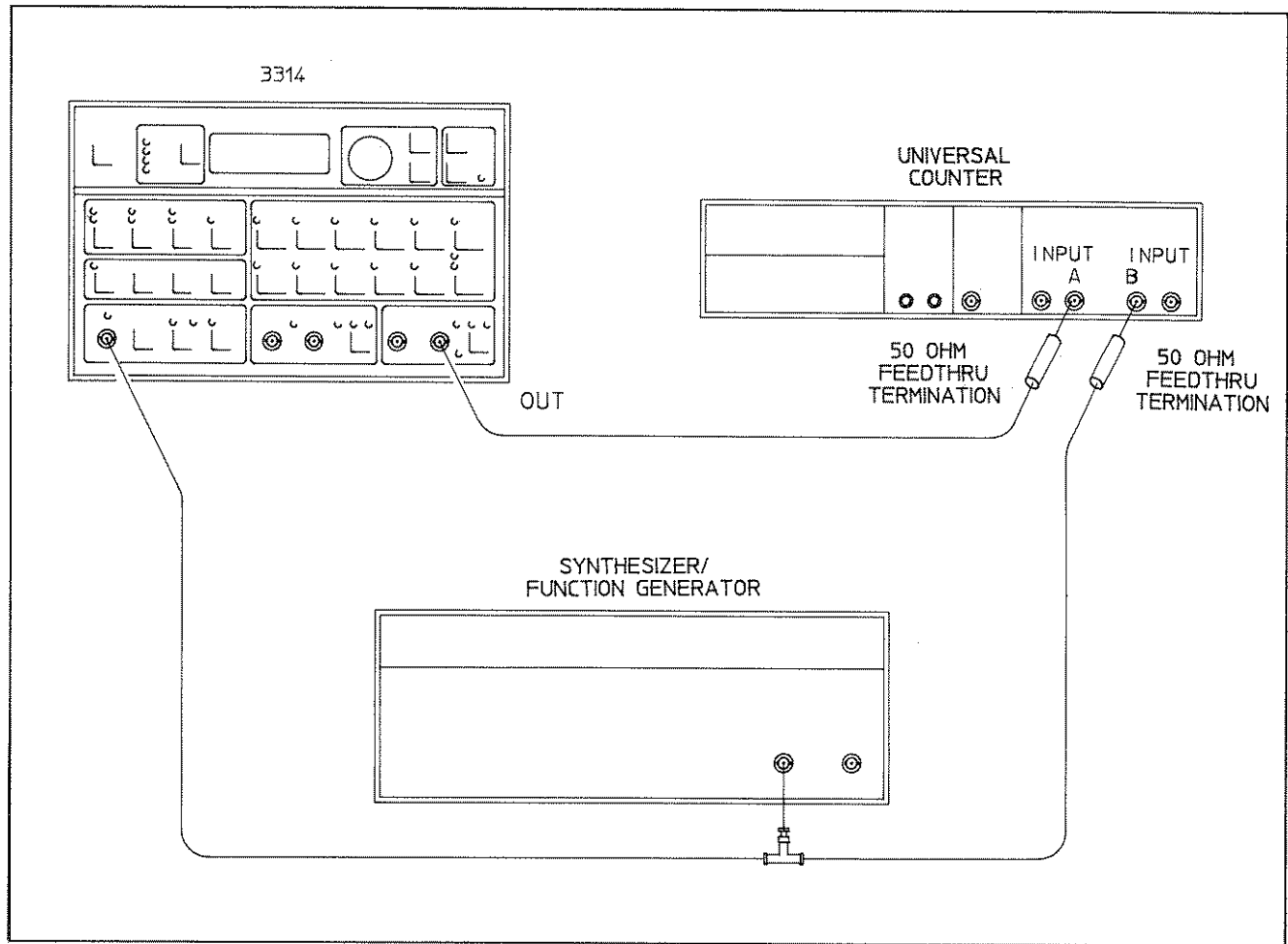

Figure 4-12. Phase Locked Loop Phase Accuracy

H. The accuracy of the phase setting displayed on the 3314A can be determined by the following equation:

$$\phi = (t_1/t)360^\circ$$

where t is the period of the 50Hz Synthesizer/Function Generator signal (constant throughout the test), and t_1 is the change in time between the trailing edges of the phase locked signals (varies with phase setting).

I. Repeat step H for phase settings on the 3314A of -90° , 0° , $+90^\circ$, and $+199.9^\circ$ noting that each phase setting will have a corresponding value of t_1 to be entered into the above equation.

NOTE

The data taken above can be entered into the Performance Test Record for permanent reference and comparison.

NOTE

This test always results in positive phases. Subtract 360° from the measured results to obtain negative phase shifts.

4-13. AMPLITUDE ACCURACY

This test determines the amplitude accuracy of the 3314A's Sine, Square, and Triangle wave signals.

Specifications:

Sine/Square	$\pm 1\%$ of setting $\pm 35\text{mV}$
Triangle	$\pm 1\%$ of setting $\pm 60\text{mV}$

Equipment Required:

- AC/DC Digital Voltmeter
- 50 Ohm Feedthrough Termination

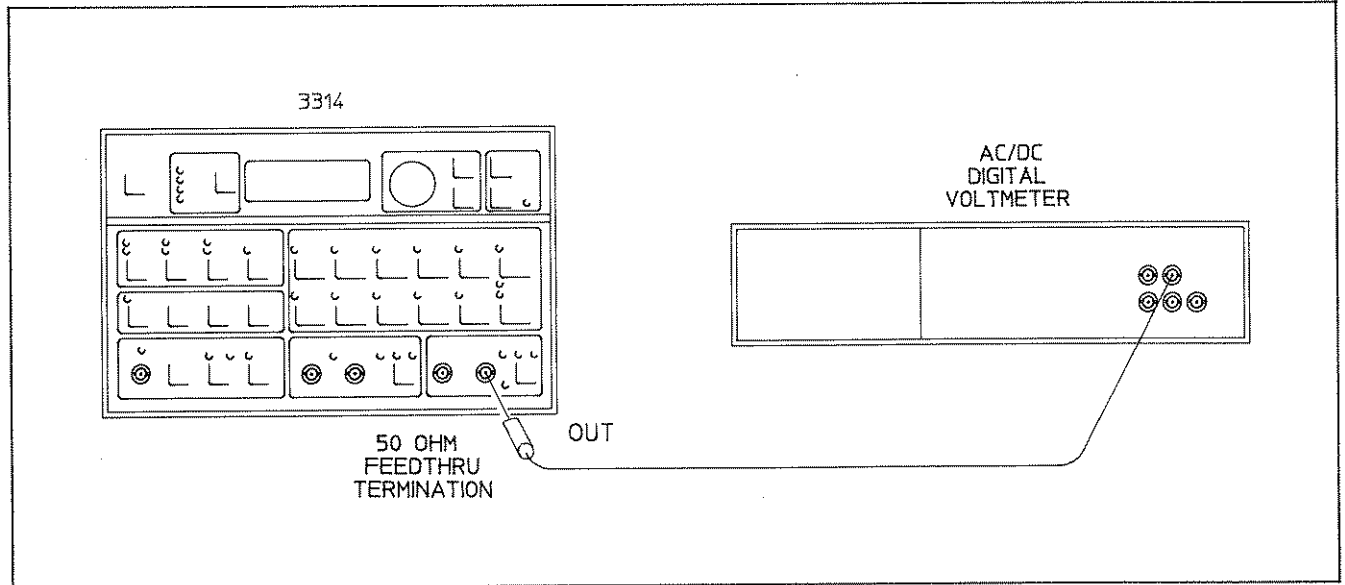

Figure 4-13. Amplitude Accuracy

Procedures:

A. Preset the 3314A.

B. Set the 3314A as follows:

Frequency 10kHz
 Amplitude 10Vp-p

C. Set the Digital Voltmeter as follows:

Range Auto
 Function AC
 Trigger Internal

D. Connect the 3314A to the Digital Voltmeter as shown in Figure 4-13.

NOTE

Cable length between the 3314A and the Digital Voltmeter should be as short as possible.

E. Calibrate the 3314A by pressing the Blue Shift Key followed by the "RCL" Key.

F. Note and record the voltage measured on the Digital Voltmeter. Reading should be 3.535V ±0.0477V.

G. Repeat step E.

H. Change the function on the 3314A to a Square wave.

I. Note and record the voltage measured on the Digital Voltmeter. Reading should be 5.0V ±0.0477V.

J. Repeat step E.

K. Change the function on the 3314A to a Triangle wave.

L. Note and record the voltage measured on the Digital Voltmeter. Reading should be 2.8867V ±0.0477V.

4-14. SINE WAVE POWER FLATNESS

This is a test to check the amplitude flatness of the 3314A Sine wave signal.

Specification:

20Hz to 50kHz	± 0.04dB	+0.046
50kHz to 1MHz	± 0.17dB	± 0.010
1MHz to 19.99MHz	± 0.8dB	± 0.010

Equipment Required:

- AC/DC Digital Voltmeter
- 3V Thermal Converter

NOTE

For accurate test results, allow the 3314A and the Thermal Converter time to settle and adjust to surrounding temperatures. Avoid sudden temperature changes around the Thermal Converter.

Procedures:

A. Preset the 3314A.

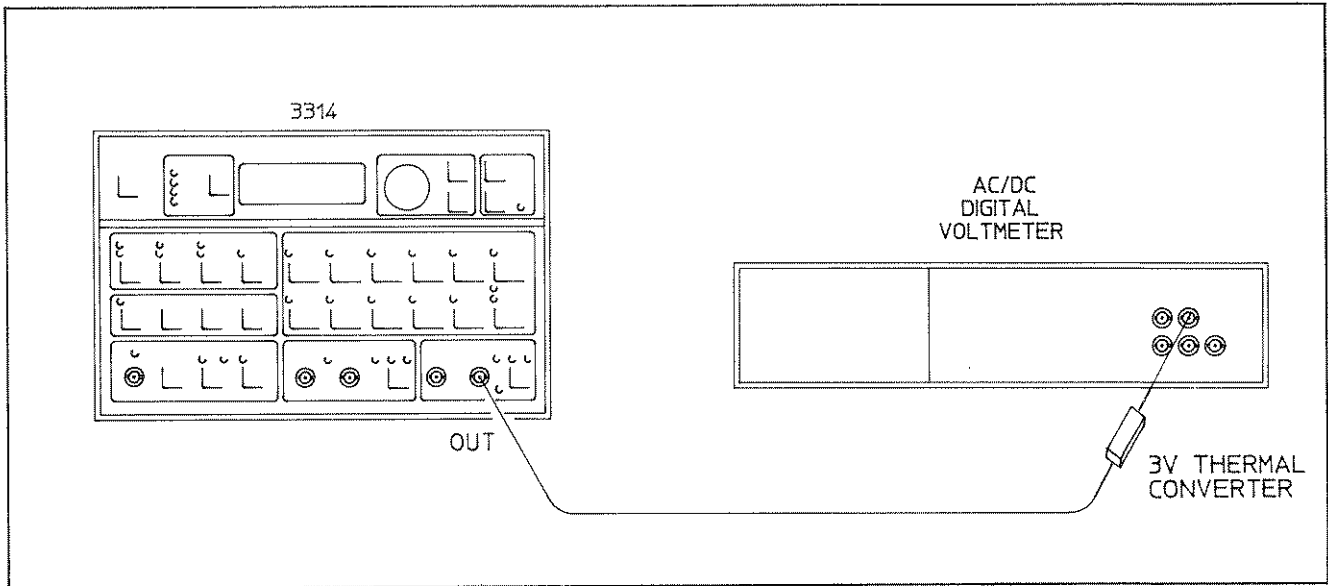

Figure 4-14. Sine Wave Power Flatness

B. Set the 3314A as follows:

Amplitude 7.5Vp-p
 Frequency 10kHz

C. Set the Voltmeter as follows:

Range 1
 Function DC
 Trigger Internal

CAUTION

*Double check the 3314A Signal Amplitude.
 The input signal to the Thermal Converter
 must not exceed 3V RMS (8Vp-p).*

D. Connect the 3314A to the Thermal Converter and the Digital Voltmeter as shown in Figure 4-14.

E. Record the voltage measured on the Digital Voltmeter. This is the reference voltage for the 7.5Vp-p 3314A setting.

F. Set the frequency on the 3314A to 100Hz.

G. Carefully adjust the amplitude on the 3314A until the voltage measured on the Digital Voltmeter is equal to the reference voltage recorded in step E.

H. Record the 3314A's displayed amplitude (in Vp-p) in the appropriate section of Table 4-8 in the Performance Test Record.

I. Repeat steps G & H for the 3314A frequency settings given below:

- 50kHz
- 800kHz
- 1MHz
- 5MHz
- 19.99MHz

J. Set the amplitude of the 3314A to 7.5Vp-p and the frequency to 10kHz.

K. Note and record the voltage reading on the Digital Voltmeter.

L. Using the data taken in steps E & K, calculate the reference drift of the 3314A using the equation given below:

$$\text{Drift(dB)} = 20 \text{ Log } |(\text{Step K Reference}/\text{Step E Reference})|$$

M. If Drift(dB) is < 0.025dB, the data taken in steps F,G,H, and I is acceptable. Proceed to step O.

N. If Drift(dB) is > 0.025dB, the data taken in steps F,G,H, and I is unacceptable. Repeat steps A through L. If the test fails again, perform the Amplitude Accuracy Test for amplitude verification and repeat Flatness test.

O. Disconnect the Thermal Converter from the 3314A.

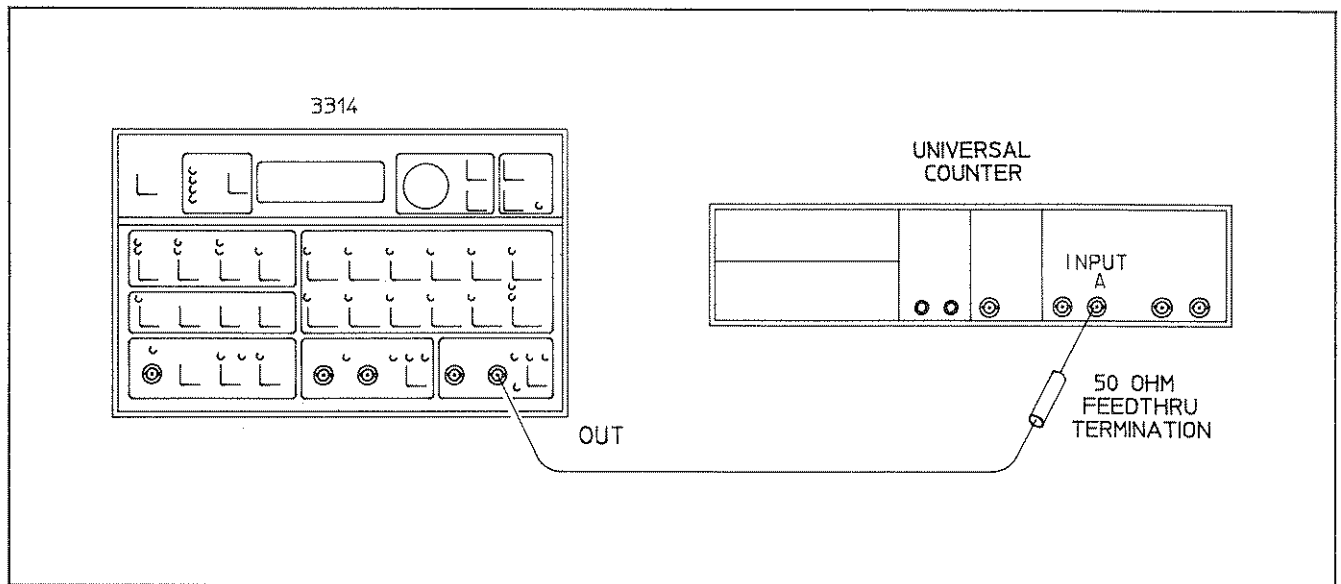

Figure 4-15. Manual Sweep Accuracy

P. Using the equation: Flatness Error (dB) = 20 Log (Displayed Amplitude/7.50V), calculate the Flatness Error in dB for each amplitude entered in the Performance Test Record. Compare the result of each calculation to the specification given in the table.

4-15. MANUAL SWEEP ACCURACY

This test checks the accuracy of the 3314A Manual Linear Sweep.

Specification:

- Manual Linear Sweep Accuracy:
- Stop Range = 20MHz ± 3% of Stop Frequency
 - Stop Range = 2MHz ± 1% of Stop Frequency
 - Stop Range ≤ 200kHz ± (0.2% of Stop Frequency + 0.1% of Range)

Equipment Required:

- Universal Counter
- 50 Ohm Feedthrough Termination

Procedures:

- A. Preset the 3314A.
- B. Set the 3314A as follows:

- Amplitude 10Vp-p
- Start Frequency 1MHz
- Stop Frequency 10MHz
- Sweep Linear

C. Set the Counter as follows:

- Function Frequency A
- Resolution 10Hz
- Channel Input Com

D. Connect the 3314A to the Counter as shown in Figure 4-15.

E. Press the "MAN SWEEP" key on the 3314A.

F. Press "START FREQ".

G. Record the frequency reading on the Universal Counter. Reading should be 1MHz ± 300kHz.

H. Set "STOP FREQ" on the 3314A to 1MHz and "START FREQ" to 100kHz.

I. Record the frequency reading on the Universal Counter. The reading should be 100kHz ± 10kHz

J. Set "STOP FREQ" on the 3314A to 100kHz and "START FREQ" to 10kHz.

K. Record the frequency reading on the Universal Counter. The reading should be 10kHz ± 400Hz.

4-16. STEP ATTENUATOR ACCURACY

This test compares the accuracy of the 3314A Step Attenuator against an attenuator of known precision.

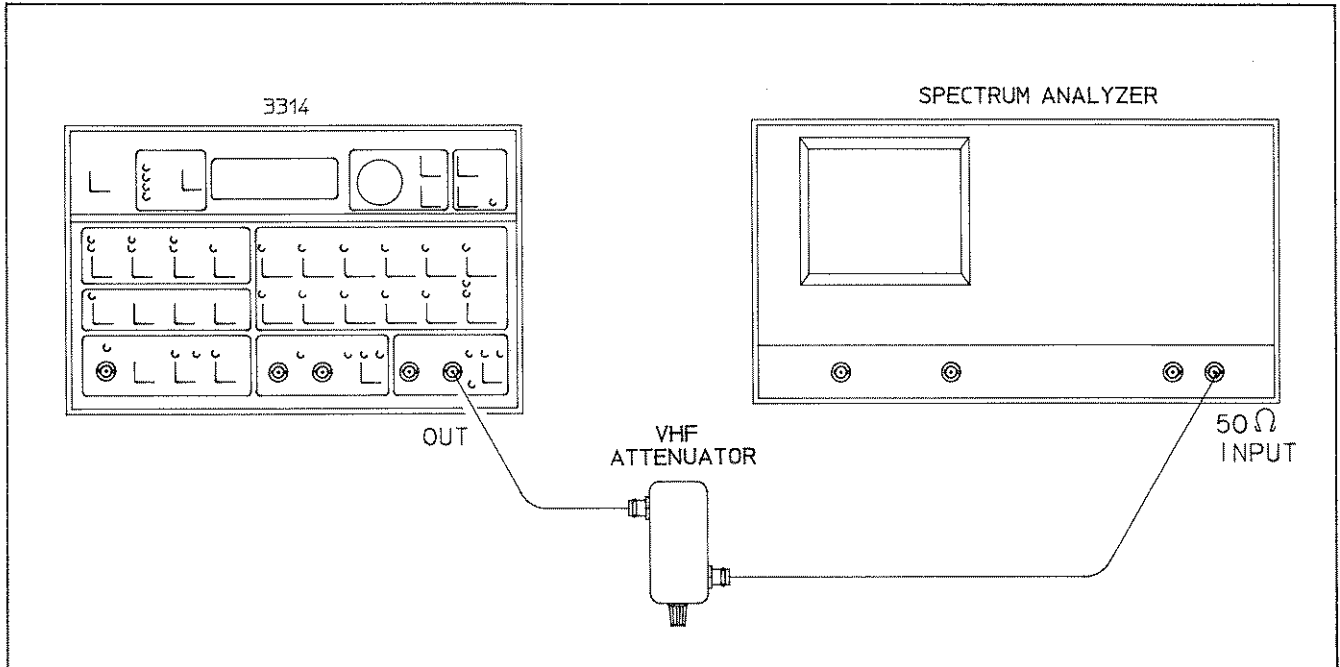

Figure 4-16. Step Attenuator Accuracy

Specification:

- 0.001Hz to 50kHz ±0.05dB
- 50kHz to 19.99MHz (20dB,40dB Attenuation) ±0.3dB
- 50kHz to 19.99MHz (60dB attenuation only) ±0.5dB

Equipment Required:

- Spectrum Analyzer
- VHF Attenuator*

***NOTE**

This attenuator must have current certification data at frequencies of 50kHz, 1MHz, 20MHz, and attenuations of 20dB, 40dB, and 60dB.

Procedures:

- A. Preset the 3314A.
- B. Set the 3314A as follows:
 - Frequency 50kHz
 - Amplitude 10Vp-p
- C. Set the Attenuator to 20dB attenuation.
- D. Connect the 3314A to the Attenuator and Spectrum Analyzer as shown in Figure 4-16.

E. Set the Spectrum Analyzer as follows:

1. Press "INSTR PRESET".
2. Enter Center Frequency (3314A Frequency Setting).
3. Set Frequency Span to 2x Center Frequency.
4. Enable "COUNTER".
5. Press "MKR→CF".
6. Disable COUNTER
7. Press "MANUAL".
8. Press "CLEAR A".
9. Press "MKR→REF LVL".
10. Set "dB/DIV" to 1dB.
11. Press "REF LVL" and adjust to approximately 1dB below full scale.
12. Set Video Bandwidth to 10Hz.
13. Press "OFFSET".
14. Press "ENTER OFFSET".
15. Press "SAVE (off)", "4 (cal)".

F. Using the Range Down function, set the amplitude of the 3314A to 1.000Vp-p.

G. Set the Attenuator to 0dB.

H. Record the Marker Amplitude displayed on the CRT in the appropriate section of Table 4-9 located in the Performance Test Record.

I. From the reading taken in step H, subtract the Insertion Loss Error of the Attenuator. Add that quantity to the Attenuator's setting and enter the result under "Actual Attenuation" in Table 4-9. (See Performance Test Record for an example.)

J. Set the Attenuator to 40dB.

K. Set the amplitude of the 3314A to 10.00Vp-p.

L. Repeat step E.

M. Using the Range Down function, set the amplitude of the 3314A to 100mVp-p.

N. Set the Attenuator to 0dB.

O. Repeat steps H&I.

P. Set the Attenuator to 60dB.

Q. Set the amplitude of the 3314A to 10.00Vp-p.

R. Repeat step E.

S. Using the Range Down function, set the amplitude of the 3314A to 10.0mVp-p.

T. Set the Attenuator to 0dB.

U. Repeat steps H & I.

V. Set the 3314A to the remaining frequencies shown in Table 4-9. Repeat steps E through U for each setting.

4-17. VERNIER ATTENUATOR FLATNESS

This test checks the flatness of the 3314A Vernier Attenuator.

Specification:

20Hz to 50kHz	±0.03dB
50kHz to 1MHz	±0.16dB
1MHz to 20MHz	±0.7dB

Equipment Required:

- Spectrum Analyzer
- VHF Attenuator*

***NOTE**

This attenuator must have current certification data at frequencies of 10kHz, 50kHz, 1MHz, 20MHz, and attenuations of 10dB and 20dB.

Procedures:

A. Preset the 3314A.

B. Set the 3314A as follows:

Frequency	10kHz
Amplitude	10Vp-p
Range Hold	On

C. Set the Attenuator to 10dB attenuation.

D. Connect the 3314A to the Attenuator and Spectrum Analyzer as shown in Figure 4-17.

E. Set the Spectrum Analyzer as follows:

1. Press "INSTR PRESET".
2. Enter Center Frequency (3314A Frequency Setting).
3. Set the Frequency Span to 2x Center Frequency.
4. Enable "COUNTER".
5. Press "MKR→CF".
6. Disable COUNTER.
7. Press "MANUAL".
8. Press "CLEAR A".
9. Press "MKR→REF LVL".
10. Set "dB/DIV" to 1dB.
11. Press "REF LVL" and adjust to approximately 1dB below full scale.
12. Set Video Bandwidth to 10Hz.
13. Press "OFFSET".
14. Press "ENTER OFFSET".
15. Press "SAVE (off)", "4 (cal)".

F. Using the Modify knob, set the amplitude of the 3314A to 3.16Vp-p.

G. Set the Attenuator to 0dB.

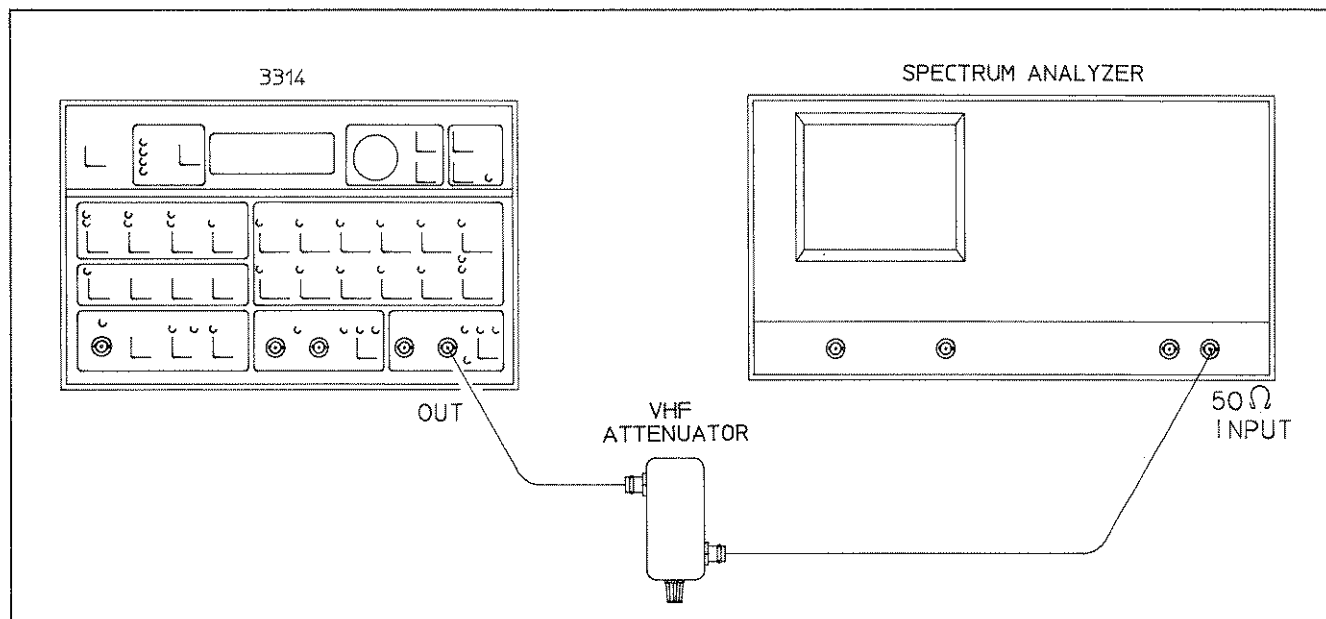

Figure 4-17. Vernier Attenuator Flatness

H. Record the Marker Amplitude displayed on the CRT in the appropriate section of Table 4-10 located in the Performance Test Record.

I. From the reading taken in step H, subtract the Insertion Loss Error of the Attenuator. Add that quantity to the Attenuator's setting and enter the result under "Actual Attenuation" in Table 4-10. (See Performance Test Record for example.)

NOTE

The "Actual Attenuation" calculated for settings of 10dB & 20dB at 10kHz is the reference attenuation to which "Actual Attenuation" at 50kHz, 1MHz, and 20MHz will be compared. (See Table 4-10.)

- J. Set the Attenuator to 10dB.
- K. Set the amplitude of the 3314A to 10.0Vp-p and the frequency to 50kHz.
- L. Repeat steps E through I.
- M. Set the Attenuator to 10dB.
- N. Set the amplitude of the 3314A to 10.0Vp-p and the frequency to 1MHz.
- O. Repeat steps E through I.
- P. Set the Attenuator to 10dB.
- Q. Set the amplitude of the 3314A to 10.0Vp-p and the frequency to 19.99MHz.
- R. Repeat steps E through I.
- S. Set the Attenuator to 20dB.
- T. Set the amplitude of the 3314A to 10.0Vp-p and the frequency to 10kHz.
- U. Repeat step E.
- V. Set the amplitude of the 3314A to 1.00Vp-p.
- W. Set the Attenuator to 0dB.
- X. Repeat steps H & I.
- Y. Set the Attenuator to 20dB.
- Z. Set the amplitude of the 3314A to 10.0Vp-p and the frequency to 50kHz.
- A.A. Repeat steps E, V-X.
- B.B. Set the Attenuator to 20dB.
- C.C. Set the amplitude of the 3314A to 10.0Vp-p and the frequency to 1MHz.
- D.D. Repeat steps E, V-X.
- E.E. Set the Attenuator to 20dB.
- F.F. Set the amplitude of the 3314A to 10.0Vp-p and the frequency to 19.99MHz.
- G.G. Repeat steps E, V-X.

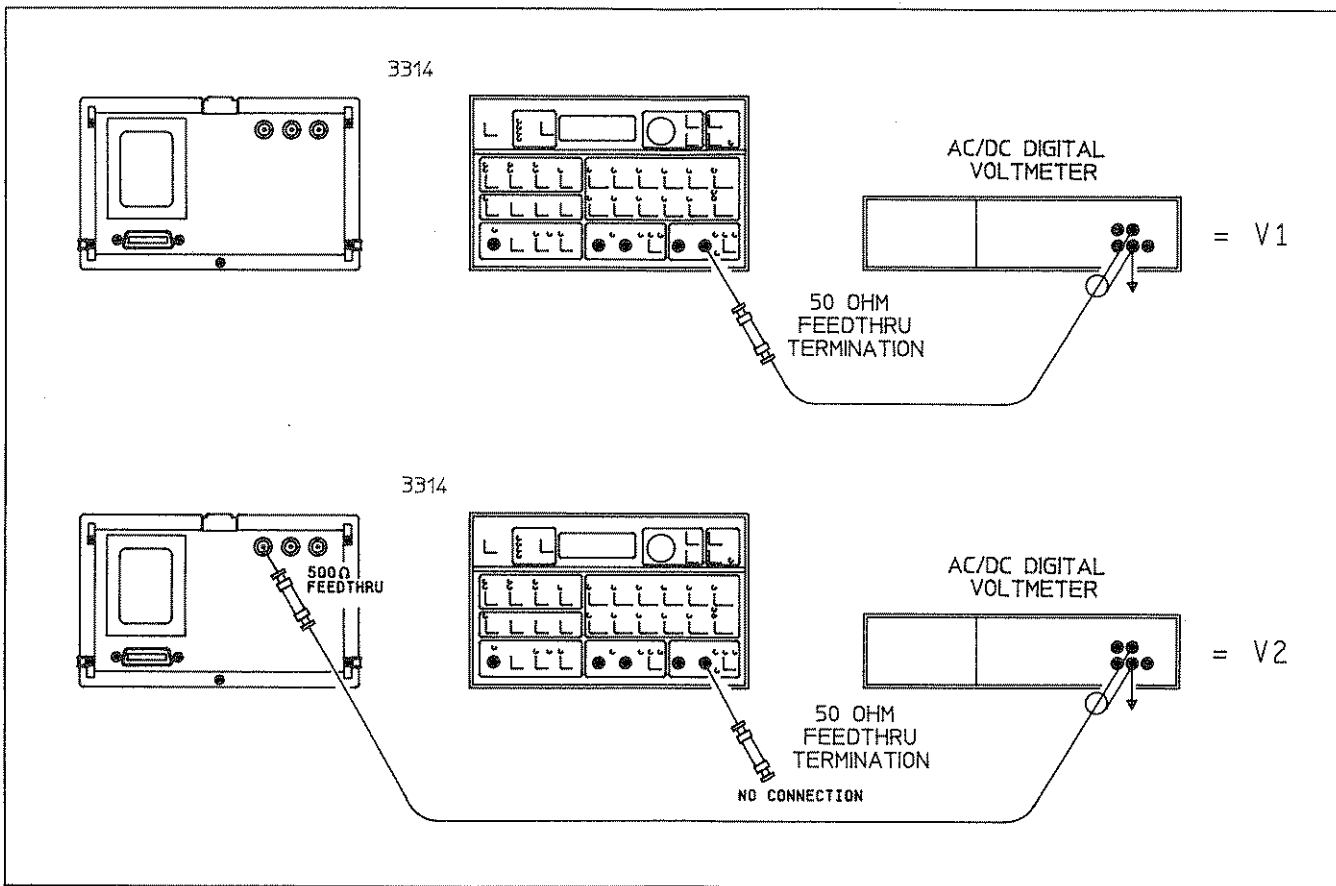

Figure 4-18. X3 Gain Accuracy Connections

4-18. OPTION 001 PERFORMANCE TESTS

These tests measure the performance of Option 001 to determine its functional quality.

4-19. X3 GAIN ACCURACY

This test measures the output voltage at the Main Output and at the X3 output to determine the gain. The gain at 10kHz is specified to be $3 \pm 1\%$.

Equipment Required:

- AC/DC Digital Voltmeter
- 50 Ohm Feedthru Termination
- A 500Ω Feedthru Termination consisting of:
 - 1 499Ω resistor, -hp- part number 0698-4123

Procedure:

A. Preset the 3314A.

B. Set the 3314A as follows:

- Frequency 10kHz
- Amplitude 10Vp-p

C. Connect the 50 Ohm Feedthru to the 3314A's Main Output. Connect the 500Ω Feedthru Termination to the 3314A's X3 Output.

D. Set the digital voltmeter to measure $\approx 3.5VRMS$ and then measure and record the voltage from the Main Output (V1).

E. Set the digital voltmeter to measure $\approx 10.6VRMS$ and then measure and record the voltage from the X3 Output (V2).

F. Compute the gain error using the following formula:

$$\text{Gain Error (\%)} = \left[\frac{V2}{V1} - 3 \right] \times 100\%$$

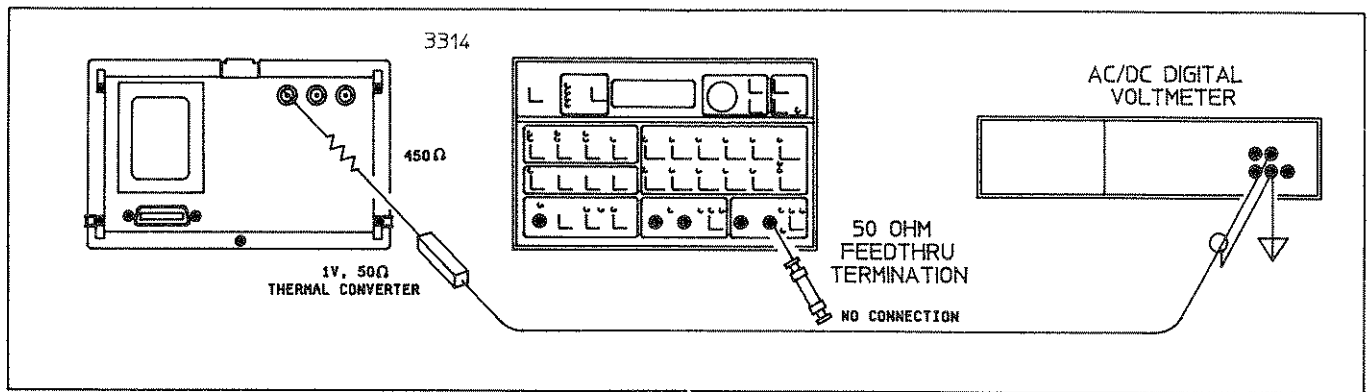

Figure 4-19. Sine Power Flatness Connections

4-20. SINE POWER FLATNESS

This test measures the X3 Output's power level at 30Vpp and 10kHz. Using this as a power reference, various power levels are measured at different frequencies to determine power flatness.

Required Equipment:

- AC/DC Digital Voltmeter
- 50 Ohm Feedthrough Termination
- A 450 Ohm Series Voltage Reducer consisting of:
 - 1 450Ω resistor, -hp- part number 0698-3510
- 1V Thermal Converter

Procedure:

A. Preset the 3314A.

B. Set the 3314A as follows:

Frequency 10kHz
 Amplitude 10Vp-p

C. Connect the 50 Ohm Feedthrough Termination to the 3314A's Main Output. Connect the Voltage Reducer and Thermal Converter to the 3314A's X3 Output as shown in Figure 4-19.

D. Set the digital voltmeter to measure $\approx 0.007\text{mVdc}$ and measure and record the thermal converter's output voltage (V_{ref}).

E. Reduce the 3314A's amplitude to 9.89Vp-p and record the thermal converter's output voltage (V_1 limit). This corresponds to a 0.1dB change and is the low frequency flatness limit.

F. Reduce the 3314A's amplitude to 9.44Vp-p and record the thermal converter's output voltage (V_2 limit). This corresponds to a 0.5dB change and is the mid frequency flatness limit.

G. Reduce the 3314A's amplitude to 8.41Vp-p and record the thermal converter's output voltage (V_3 limit). This corresponds to a 1.5dB change and is the high frequency flatness limit.

H. Set the 3314A's amplitude back to 10Vp-p and set the frequency to each of these values:

- 20Hz 50kHz 500kHz 1MHz

I. Measure and record the thermal converter's output voltage ($V_{20\text{Hz}}$, $V_{50\text{kHz}}$, $V_{500\text{kHz}}$, $V_{1\text{MHz}}$).

J. Voltages $V_{20\text{Hz}}$ and $V_{50\text{kHz}}$ should be within this range:

$$0.1\text{dB RANGE} = V_{\text{ref}} \pm (V_{\text{ref}} - V_1 \text{ limit})$$

K. Voltage $V_{500\text{kHz}}$ should be within this range:

$$0.5\text{dB RANGE} = V_{\text{ref}} \pm (V_{\text{ref}} - V_2 \text{ limit})$$

L. Voltage $V_{1\text{MHz}}$ should be within this range:

$$1.5\text{dB RANGE} = V_{\text{ref}} \pm (V_{\text{ref}} - V_3 \text{ limit})$$

4-21. HARMONIC DISTORTION

This test measures the relative harmonic levels with a spectrum analyzer.

Required equipment:

- Spectrum Analyzer
- 50 Ohm Feedthrough Termination
- A 500Ω Feedthrough Termination consisting of:
 - 1 499Ω resistor, -hp- part number 0698-4123

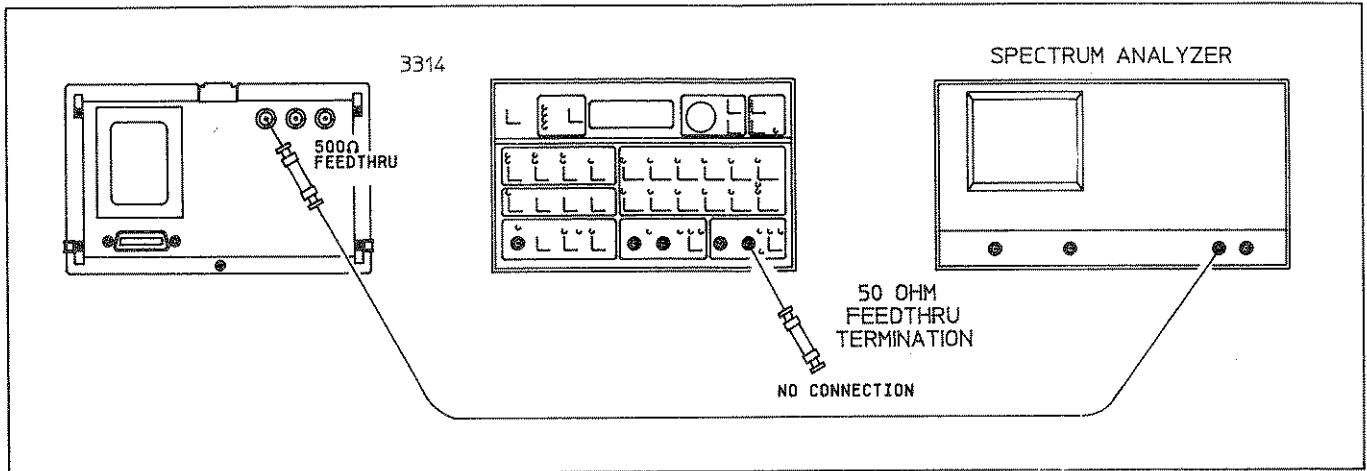

Figure 4-20. Harmonic Distortion Connections

Procedure:

- A. Preset the 3314A.
- B. Set the 3314A as follows:

Frequency 20Hz
 Amplitude 10Vp-p

C. Connect the 50 Ohm Feedthrough Termination to the 3314A's Main Output. Connect the 500Ω Feedthrough Termination to the 3314A's X3 Output.

D. Connect the spectrum analyzer's 1MΩ input to the 3314A's X3 Output. Set the spectrum analyzer to measure the fundamental and at least seven harmonics. Use the Marker function to verify that the level of the largest harmonic is more than 53dB below the fundamental.

E. Repeat step D for 3314A frequency settings of 50kHz and 1MHz. The largest harmonic should be more than 53dB below the fundamental at 50kHz, and more than 38dB below at 1MHz.

4-22. SQUARE WAVE RISE/FALL TIME

This test uses a wide bandwidth oscilloscope to measure the rise and fall time of a 10kHz, 30Vp-p square wave.

Required Equipment:

- Oscilloscope
- 50 Ohm Feedthrough Termination
- A 500Ω Feedthrough Termination consisting of:
 1 499Ω resistor, -hp- part number 0698-4123

Procedure:

- A. Preset the 3314A.
- B. Set the 3314A as follows:

Frequency 10kHz
 Amplitude 10Vp-p
 Function Square Wave

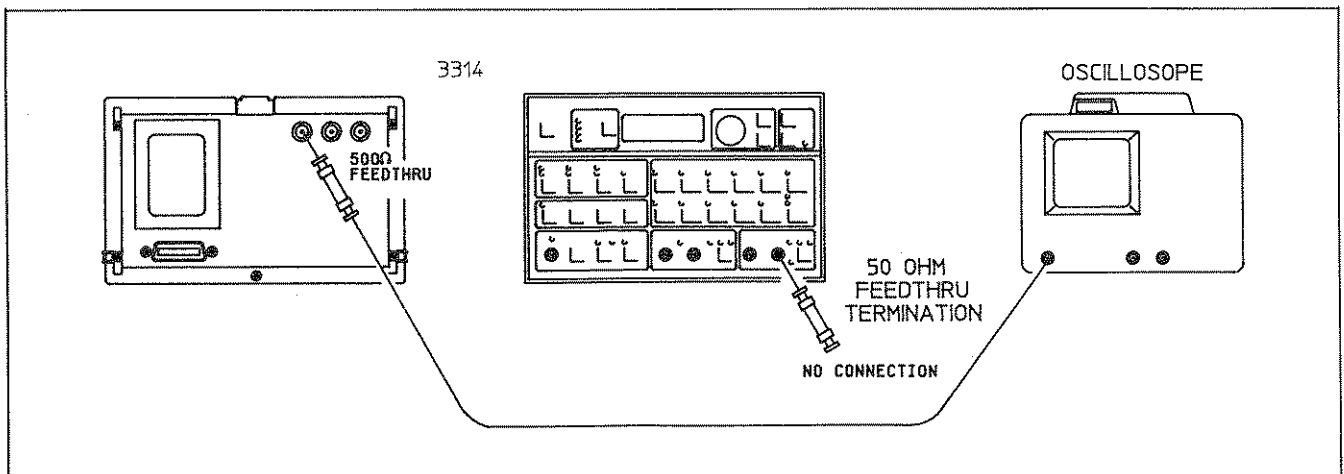

Figure 4-21. Square Wave Rise/Fall Time Connections

C. Connect the 50 Ohm Feedthrough Termination to the 3314A's Main Output. Connect the 500Ω Feedthrough Termination to the 3314A's X3 Output.

D. Connect the oscilloscope's 1MΩ input to the 3314A's X3 Output.

E. Set the oscilloscope to display 2 complete cycles with the peaks of the square wave at the 0% and 100% graticule lines.

F. Using the oscilloscope's delay function (set the delayed time per division to .1μS/DIV), measure the rise and fall time from the 10% to 90% graticule lines. In both cases, this should be less than 2 divisions (<200ns).

4-23. RESIDUAL DC OFFSET

This test measures the DC voltage output from the X3 Output with no signal present.

Required Equipment:

- AC/DC Digital Voltmeter
- 50 Ohm Feedthrough Termination
- A 500Ω Feedthrough Termination consisting of:
 - 1 499Ω resistor, -hp- part number 0698-4123

Procedure:

- A. Preset the 3314A.
- B. Set the 3314A as follows:

Function OFF
 Offset 0VDC

C. Connect the 50 Ohm Feedthrough Termination to the 3314A's Main Output. Connect the 500Ω Feedthrough Termination to the 3314A's X3 Output.

D. Measure the DC voltage at the X3 Output. This voltage should be within 40mV of 0VDC.

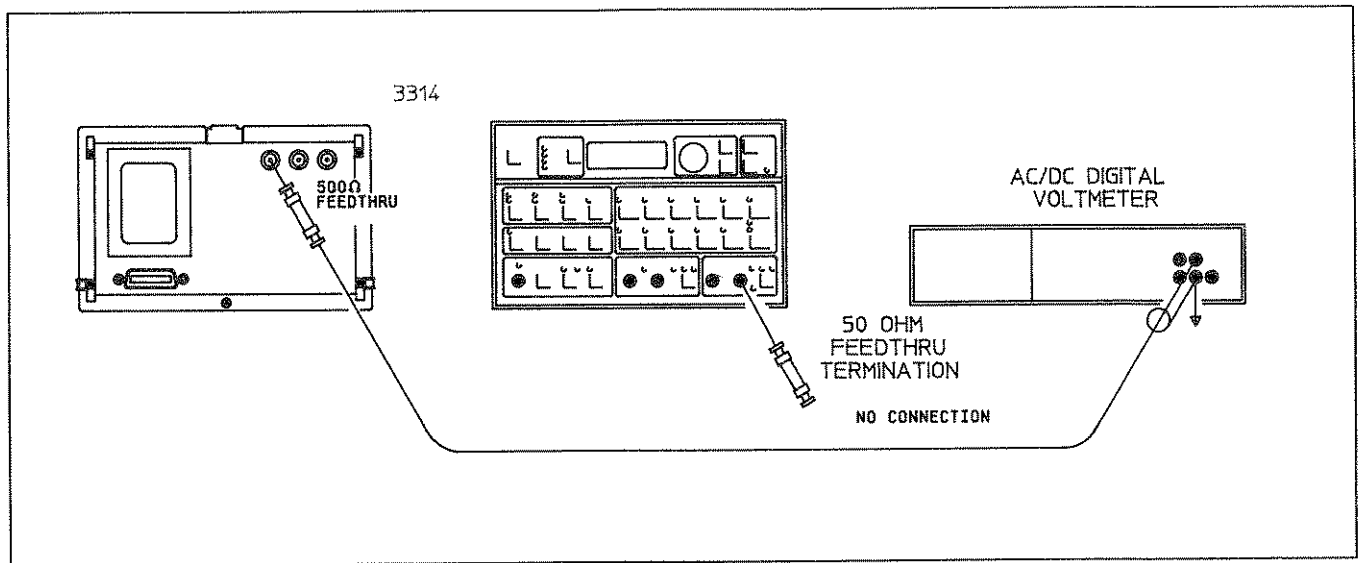

Figure 4-22. Residual DC Offset Connections

) C

) C

) C

PERFORMANCE TEST RECORD

HEWLETT-PACKARD MODEL 3314A

Tests Performed By _____

FUNCTION GENERATOR

Date _____

SERIAL NO. _____

FREQUENCY ACCURACY TEST:

3314A Frequency (A)	Specification	Counter Reading
19.99 MHz	± 2000 Hz	_____
1999 kHz	± 200 Hz	_____
199.9 kHz	± 600 Hz	_____
19.99 kHz	± 60 Hz	_____
1999. Hz	± 6 Hz	_____
199.9 Hz	± 6 Hz	_____
3314A Frequency (B)		
00.1 Hz	± 0.2 Hz	_____
001 Hz	± 2 Hz	_____
0.01 kHz	± 20 Hz	_____
00.1 kHz	± 200 Hz	_____
001 kHz	± 0.1 Hz	_____
0.01MHz	± 1 Hz	_____

TIME AXIS AND VARIABLE SYMMETRY:

%Symmetry	Specification	Calculated%
50%	$\pm 0.2\%$	_____
5%	$\pm 0.5\%$	_____
95%	$\pm 0.5\%$	_____

INTERNAL TRIGGER ACCURACY:

Period	Specification	Counter Reading
10.0ms	± 0.001 ms	_____

PERFORMANCE TEST RECORD (Cont'd)

TRIANGLE LINEARITY

x Values	Positive Slope Measurement	x Times y	Calculated Best Fit Straight Line	Tolerance*
$x_1 = 1$	10% _____	_____	(y_1) _____	$\pm 0.02V$
$x_2 = 2$	20% _____	_____	(y_2) _____	$\pm 0.02V$
$x_3 = 3$	30% _____	_____	(y_3) _____	$\pm 0.02V$
$x_4 = 4$	40% _____	_____	(y_4) _____	$\pm 0.02V$
$x_5 = 5$	50% _____	_____	(y_5) _____	$\pm 0.02V$
$x_6 = 6$	60% _____	_____	(y_6) _____	$\pm 0.02V$
$x_7 = 7$	70% _____	_____	(y_7) _____	$\pm 0.02V$
$x_8 = 8$	80% _____	_____	(y_8) _____	$\pm 0.02V$
$x_9 = 9$	90% _____	_____	(y_9) _____	$\pm 0.02V$

$$\begin{aligned} \Sigma x &= 45 & \Sigma y & \text{_____} & \Sigma xy & \text{_____} \\ (\Sigma x)^2 &= 2025 & \Sigma x \Sigma y & \text{_____} & m &= \text{_____} \\ \Sigma x^2 &= 285 & & & b &= \text{_____} \end{aligned}$$

*Tolerance is the maximum allowable difference between the "Positive Slope Measurement" (or "Negative Slope Measurement") and the "Calculated Best Fit Straight Line" value.

Tolerance is calculated by:

$$\text{Tolerance} = (\text{Triangle Amplitude})(\text{Specification})$$

$$= (10V_{p-p})(0.2\%)$$

$$= 0.02V$$

x Values	Negative Slope Measurement	x Times y	Calculated Best Fit Straight Line	Tolerance*
$x_9 = 9$	90% _____	_____	(y_9) _____	$\pm 0.02V$
$x_8 = 8$	80% _____	_____	(y_8) _____	$\pm 0.02V$
$x_7 = 7$	70% _____	_____	(y_7) _____	$\pm 0.02V$
$x_6 = 6$	60% _____	_____	(y_6) _____	$\pm 0.02V$
$x_5 = 5$	50% _____	_____	(y_5) _____	$\pm 0.02V$
$x_4 = 4$	40% _____	_____	(y_4) _____	$\pm 0.02V$
$x_3 = 3$	30% _____	_____	(y_3) _____	$\pm 0.02V$
$x_2 = 2$	20% _____	_____	(y_2) _____	$\pm 0.02V$
$x_1 = 1$	10% _____	_____	(y_1) _____	$\pm 0.02V$

$$\begin{aligned} \Sigma x &= 45 & \Sigma y & \text{_____} & \Sigma xy & \text{_____} \\ (\Sigma x)^2 &= 2025 & \Sigma x \Sigma y & \text{_____} & m &= \text{_____} \\ \Sigma x^2 &= 285 & & & b &= \text{_____} \end{aligned}$$

PERFORMANCE TEST RECORD (Cont'd)

N CYCLE PHASE ACCURACY:

Step E Reading	Step F Reading	AVG	Specification	Step H Reading
			± 0.167V	

RESIDUAL DC AND DC OFFSET ACCURACY:

(Residual) (if Option 001, add ± 500uV to specification.)

3314A Voltage	Offset	Specification	Voltmeter Reading
10.00V	0V	± 0.05V	_____
1.000V	0V	± 0.005V	_____
100.0mV	0V	± 0.0005V	_____
10.00mV	0V	± 0.00005V	_____

(Variable)

3314A Voltage	Offset	Specification	Voltmeter Reading
10.00V	5V	± 0.21V	_____
1.000V	5V	± 0.16V	_____
100.0mV	5V	± 0.16V	_____
10.00mV	5V	± 0.16V	_____
10.00V	0.887V	± 0.087V	_____
1.000V	0.887V	± 0.037V	_____
100.0mV	0.887V	± 0.037V	_____
10.00mV	0.887V	± 0.037V	_____

DC OFFSET ACCURACY (cont):

3314A Voltage	Offset	Specification	Voltmeter Reading
10.00V	- 0.887V	± 0.087V	_____
1.000V	- 0.887V	± 0.037V	_____
100.0mV	- 0.887V	± 0.037V	_____
10.00mV	- 0.887V	± 0.037V	_____
10.00V	- 5V	± 0.21V	_____
1.000V	- 5V	± 0.16V	_____
100.0mV	- 5V	± 0.16V	_____
10.00mV	- 5V	± 0.16V	_____

PERFORMANCE TEST RECORD (Cont'd)

SQUARE WAVE RISE TIME AND ABERRATIONS

Rise Time		Fall Time	
Specification	Oscilloscope Reading	Specification	Oscilloscope Reading
$\leq 1\text{ cm}$	_____	$\leq 1\text{ cm}$	_____

Aberrations

Specification	Oscilloscope Reading
$\pm 0.5\text{ V}$	_____

SINE WAVE HARMONICS:

3314A Frequency	Range	Specification	Pass	Fail
20.0Hz	3	HARMONICS < -55dB	_____	_____
100.0Hz	3	HARMONICS < -55dB	_____	_____
199.9Hz	3	HARMONICS < -55dB	_____	_____
100.Hz	4	HARMONICS < -55dB	_____	_____
1000.Hz	4	HARMONICS < -55dB	_____	_____
1999.Hz	4	HARMONICS < -55dB	_____	_____
1.00kHz	5	HARMONICS < -55dB	_____	_____
10.00kHz	5	HARMONICS < -55dB	_____	_____
19.99kHz	5	HARMONICS < -55dB	_____	_____
10.0kHz	6	HARMONICS < -55dB	_____	_____
100.0kHz	6	HARMONICS < -40dB	_____	_____
199.9kHz	6	HARMONICS < -40dB	_____	_____
100.kHz	7	HARMONICS < -40dB	_____	_____
1000.kHz	7	HARMONICS < -40dB	_____	_____
1999.kHz	7	HARMONICS < -40dB	_____	_____

Measured Levels

		2nd	3rd	4th	5th	6th	7th
1.00MHz	8	-25dB	_____	_____	_____	_____	_____
10.00MHz	8	-25dB	_____	_____	_____	_____	_____
19.99MHz	8	-25dB	_____	_____	_____	_____	_____

PERFORMANCE TEST RECORD (Cont'd)

AM HARMONICS:

Specification	Pass	Fail
Harmonic Levels Below "DSPL Line" Reference	_____	_____

VCO LINEARITY:

Power Supply Voltage	Specification	Counter Reading
-8V ± 10mV	2MHz ± 300kHz	_____
-4.5V ± 10mV	5.5MHz ± 300kHz	_____
1V ± 10mV	11MHz ± 300kHz	_____

PHASE LOCKED LOOP PHASE ACCURACY:

3314A Phase Setting	Specification	(t)	(t ₁)	Calculated Phase
-199.9°	SETTING ± 2°	_____	_____	_____
-90°	SETTING ± 2°	_____	_____	_____
0°	SETTING ± 2°	_____	_____	_____
90°	SETTING ± 2°	_____	_____	_____
199.9°	SETTING ± 2°	_____	_____	_____

AMPLITUDE ACCURACY:

Function	Specification	Voltmeter Reading
Sine	3.535V ± 0.0477V	_____
Square	5.0V ± 0.0477V	_____
Triangle	2.8867V ± 0.0477V	_____

SINE WAVE POWER FLATNESS:

$$\text{Drift(dB)} = 20 \text{ Log} \left| \frac{\text{Step K Reference}}{\text{Step E Reference}} \right| < 0.025\text{dB}$$

$$\text{Flatness Error(dB)} = 20 \text{ Log} \left(\frac{\text{Displayed Amplitude}}{7.5\text{V}} \right)$$

Step E Reference _____

Drift(dB) _____

Step K Reference _____

PERFORMANCE TEST RECORD (Cont'd)

Table 4-8. Sine Wave Power Flatness

3314A Frequency	3314A Displayed Amplitude	VREF	Specification	Calculated Flatness Error
100 Hz	_____	_____	± 0.04dB	_____
50 kHz	_____		± 0.04dB	_____
800kHz	_____		± 0.17dB	_____
1MHz	_____		± 0.17dB	_____
5MHz	_____		± 0.8dB	_____
19.99MHz	_____		± 0.8dB	_____

MANUAL SWEEP ACCURACY:

"Start Freq"	"Stop Freq"	Specification	Counter Reading
1 MHz	10 MHz	1 MHz ± 300kHz	_____
100 kHz	1 MHz	100 kHz ± 10 kHz	_____
10 kHz	100 kHz	10 kHz ± 400 Hz	_____

Table 4-9. Step Attenuator Accuracy

3314A Frequency	Attenuator Setting	Spectrum Analyzer Marker Amplitude	Attenuator Insertion Loss	Actual Attenuation	Upper Limit	Lower Limit
50 kHz	20 dB	_____	_____	_____	20.05 dB	19.95 dB
	40 dB	_____	_____	_____	40.05 dB	39.95 dB
	60 dB	_____	_____	_____	60.05 dB	59.95 dB
1 MHz	20 dB	_____	_____	_____	20.3 dB	19.7 dB
	40 dB	_____	_____	_____	40.3 dB	39.7 dB
	60 dB	_____	_____	_____	60.5 dB	59.5 dB
19.99 MHz	20 dB	_____	_____	_____	20.3 dB	19.7 dB
	40 dB	_____	_____	_____	40.3 dB	39.7 dB
	60 dB	_____	_____	_____	60.5 dB	59.5 dB

Example: Actual Attenuation = Attenuator Setting + (Marker Reading - Insertion Loss)

$$= 20 \text{ dB} + (0.01 \text{ dB} - (-0.013 \text{ dB}))$$

$$= 20.023 \text{ dB}$$

PERFORMANCE TEST RECORD (Cont'd)

Table 4-10. Vernier Attenuator Flatness

3314A Frequency	Attenuator Setting	Spectrum Analyzer Marker Amplitude	Attenuator Insertion Loss	Actual Attenuation	Upper Limit	Lower Limit
10 kHz	10 dB	_____	_____	*Ref	_____	_____
	20 dB	_____	_____	*Ref	_____	_____
50 kHz	10 dB	_____	_____	_____	Ref + 0.03 dB	Ref - 0.03 dB
	20 dB	_____	_____	_____	Ref + 0.03 dB	Ref - 0.03 dB
1 MHz	10 dB	_____	_____	_____	Ref + 0.16 dB	Ref - 0.16 dB
	20 dB	_____	_____	_____	Ref + 0.16 dB	Ref - 0.16 dB
19.99 MHz	10 dB	_____	_____	_____	Ref + 0.7 dB	Ref - 0.7 dB
	20 dB	_____	_____	_____	Ref + 0.7 dB	Ref - 0.7 dB

Example: Actual Attenuation = Attenuator Setting + (Marker Reading - Insertion Loss)
 = 20 dB + (0.01 dB - (-0.013 dB))
 = 20.023 dB

*Reference for attenuation flatness.

OPTION 001:

X3 Gain Accuracy:

Voltmeter Reading	V1

~ 3.5VRMS	_____
Voltmeter Reading	V2

~ 10.6VRMS	_____

$$\text{Gain Error (\%)} = \left[\frac{V2}{V1} - 3 \right] \times 100\%$$

= _____

PERFORMANCE TEST RECORD (Cont'd)

SINE POWER FLATNESS:

Vref	V1 Limit	V2 Limit	V3 Limit
_____	_____	_____	_____

3314A Frequency	Thermal Converter Output Voltage
20Hz	_____
50kHz	_____
500kHz	_____
1MHz	_____

The recorded voltages for 3314A frequency settings of 20Hz and 50kHz should fall within the range which is calculated as follows:

$$0.1\text{dB Range} = V_{\text{ref}} \pm (V_{\text{ref}} - V1 \text{ Limit})$$

$$= \underline{\hspace{2cm}}$$

For the 500kHz frequency setting, the recorded voltage should fall within the range:

$$0.5\text{dB Range} = V_{\text{ref}} \pm (V_{\text{ref}} - V2 \text{ Limit})$$

$$= \underline{\hspace{2cm}}$$

For the 1MHz frequency setting, the recorded voltage should fall within the range:

$$1.5\text{dB Range} = V_{\text{ref}} \pm (V_{\text{ref}} - V3 \text{ Limit})$$

$$= \underline{\hspace{2cm}}$$

HARMONIC DISTORTION:

3314A Frequency	Fundamental Level (dB)	Harmonic Levels (dB)
20Hz	_____	2nd _____
		3rd _____
		4th _____
		5th _____
		6th _____
		7th _____

Harmonic Levels are acceptable if:

$$(\text{Fundamental Level} - \text{Highest Level in Harmonics Column}) < -53\text{dB}$$

PERFORMANCE TEST RECORD (Cont'd)

3314A Frequency	Fundamental Level (dB)	Harmonic Levels (dB)
50kHz	_____	2nd _____
		3rd _____
		4th _____
		5th _____
		6th _____
		7th _____

Harmonic Levels are acceptable if:

$$\text{(Fundamental Level - Highest Level in Harmonics Column)} < -53\text{dB}$$

3314A Frequency	Fundamental Level (dB)	Harmonic Levels (dB)
1MHz	_____	2nd _____
		3rd _____
		4th _____
		5th _____
		6th _____
		7th _____

Harmonic Levels are acceptable if:

$$\text{(Fundamental Level - Highest Level in Harmonics Column)} < -38\text{dB}$$

SQUARE WAVE RISE/FALL TIME:

Rise Time		Fall Time	
Specification	Oscilloscope Reading	Specification	Oscilloscope Reading
≤ 200ns	_____	≤ 200ns	_____

RESIDUAL DC OFFSET:

Specification	Measured Offset
≤ 40 mVdc	_____

Free Manuals Download Website

<http://myh66.com>

<http://usermanuals.us>

<http://www.somanuals.com>

<http://www.4manuals.cc>

<http://www.manual-lib.com>

<http://www.404manual.com>

<http://www.luxmanual.com>

<http://aubethermostatmanual.com>

Golf course search by state

<http://golfingnear.com>

Email search by domain

<http://emailbydomain.com>

Auto manuals search

<http://auto.somanuals.com>

TV manuals search

<http://tv.somanuals.com>