

# DisplayMaker Legacy Esprit User Manual

Part Number 076064 Rev C



## Legal notices

© Copyright 2008 Hewlett-Packard Development Company, L.P.

The information contained herein is subject to change without notice. The only warranties for HP products and services are set forth in the express warranty statements accompanying such products and services. Nothing herein should be construed as constituting an additional warranty. HP shall not be liable for technical or editorial errors or omissions contained herein.

Printed in the US

For additional technical support and user documentation please refer to:

[www.hp.com/go/graphicarts](http://www.hp.com/go/graphicarts)

---

## Revision Log

The following is a list of major changes and additions that have been made to this manual since it was first released.

See the accompanying *Release Notes* for specific changes to the software and hardware between manual updates.

<b>Release Date</b>	<b>Description</b>
---------------------	--------------------

---

Aug 2000	Manual first released.
----------	------------------------

---

---

## Regulatory Statements

### FCC-A

This equipment has been tested and found to comply with the limits for a Class A digital device, pursuant to Part 15 of the FCC Rules. These limits are designed to provide reasonable protection against harmful interference when the equipment is operated in a commercial environment. This equipment generates, uses, and can radiate radio frequency energy and, if not installed and used in accordance with the instruction manual, may cause harmful interference to radio communications. Operation of this equipment in a residential area is likely to cause harmful interference in which case the user will be required to correct the interference at his or her own expense.

This equipment must be installed exactly as instructed in this manual using only the components supplied. If a supplied component ever needs to be replaced, it must be replaced with the same part supplied by the manufacturer. It is your responsibility to follow these instructions in order to maintain compliance with the FCC regulations. Changes or modifications not expressly approved by ColorSpan Corporation could void your authority to operate this equipment. In particular, this device must be operated with shielded cables to maintain FCC compliance.

A booklet is available from the Federal Communications Commission entitled, *How to Identify and Resolve Radio-TV Interference Problems* (#004-000-00345-4). Write to the U.S. Government Printing Office, Washington, DC 20402.

### DOC (Canada)

This digital apparatus does not exceed the Class A limits for radio noise for digital apparatus set out in the Radio Interference Regulations of the Canadian Department of Communications.

#### Normes de Sécurité (Canada)

Le présent appareil numérique n'émet pas de bruits radioélectriques dépassant les limites applicables aux appareils numériques de la Classe A prescrites dans le règlement sur le brouillage radioélectrique édictés par le Ministère des Communications du Canada.

## Telecommunications Network Statement



The ColorSpan VideoNet port on this device is not intended to be connected to a public telecommunications network. Connection of this device to a public telecommunications network in a European Community Member State will be in violation of national law implementing Directive 91/263/EEC on the approximation of laws of the Member States concerning telecommunication terminal equipment, including the mutual recognition of their conformity.

Der VideoNet port ist nicht dafür vorgesehen an ein öffentliches Telefonnetz angeschlossen zu werden. Der Anschluß dieses Gerätes an ein öffentliches Telefonnetz in einem Mitgliedstaat der EU, verstößt gegen nationale Gesetze zur Ausführung der Direktive 91/263/EEC, die sich mit der Annäherung von Gesetzen von Mitgliedstaaten beschäftigt, betreffend Telekommunikationsanlagen und die gegenseitige Anerkennung ihrer Konformität.

---

## About This Manual

Read this manual to unpack, set up, and use the ColorSpan DisplayMaker Esprit digital color printers.

- ◆ **Chapter 1** shows you how to unpack and assemble the printer, and introduces you to its main features.
- ◆ **Chapter 2** shows you how to use the control panel.
- ◆ **Chapter 3** shows you how to install ink and media.
- ◆ **Chapter 4** shows you how to calibrate the printer.
- ◆ **Appendix A** shows you how to troubleshoot common printing problems.
- ◆ **Appendix B** lists the printer's technical specifications.

For further information, refer to the following ColorSpan documentation:

- ◆ *Quick Start Guide* - **START HERE** to set up and install a brand new ColorSpan print server or software RIP, and connect and configure printers to it.
- ◆ *DisplayMaker Esprit Site Preparation Guide* - explains how to prepare your site for the printer's arrival and installation.
- ◆ *DisplayMaker Esprit Installation and User Guide* - a multimedia "how-to" guide available on CD-ROM and videocassette.
- ◆ ColorSpan Print Server Documentation - the *System Control User Guide*, *Printing Tools User Guides*, and *Print Server & Driver Setup Guide* show you how to print and RIP files through the ColorSpan print server. If the printer is connected to a non-ColorSpan print server (RIP), refer to the documentation that accompanies the server.
- ◆ *Release Notes* and *Update Notes* - late-breaking information, update descriptions, and update instructions.

Further information about all ColorSpan products is also available over the Internet at the ColorSpan World Wide Web site at <http://www.colors span.com>.

---

## Conventions

This manual uses the following informational conventions:



---

**Note** A special technique or information that may help you perform a task or understand a process.

---

---

**Hinweis** Ein Hinweis beschreibt eine spezielle Technik zur Lösung einer Aufgabe oder enthält Informationen, die Ihnen eine Prozedur näher erläutern.

---



---

**Caution** Alerts you to something that has the potential to cause damage to hardware, software, or data.

---

---

**Vorsicht** Dieses Feld weist auf einen Umstand hin, der einen Hardware- oder Software-Schaden oder Datenverlust verursachen könnte.

---



---

**WARNING** Alerts you to something that has the potential to cause physical harm to you or others around you.

---

---

**WARNUNG** Eine Warnung weist auf einen Umstand hin, durch den Ihnen und anderen Personen ein physischer Schaden erwachsen könnte.

---

Other WARNING symbols used:



**Electrical Hazard**

Vorsicht steht unter Spannung



**Lifting Hazard**

Vorsicht beim Anheben





# TABLE OF CONTENTS

Revision Log.....	iii
Regulatory Statements.....	iv
FCC-A.....	iv
DOC (Canada).....	iv
Telecommunications Network Statement.....	v
About This Manual .....	vi
Conventions.....	vii

## **1** Getting Started

Operating Requirements .....	1-2
Electrical.....	1-2
Environmental.....	1-2
Important Operating Notes.....	1-3
Safety Warnings.....	1-4
Installation Checklist.....	1-5
Unpacking and Assembly .....	1-6
Unpacking.....	1-6
Stand Assembly.....	1-8
Final Assembly .....	1-9
Connecting Power and VideoNet.....	1-11
Power.....	1-11
VideoNet.....	1-12
Power-Up Sequence.....	1-13
What's Next?.....	1-13
Workflow Overview .....	1-14
Print Server.....	1-14
ColorMark Software RIP.....	1-14
Parts Overview .....	1-15
Special Features .....	1-18
Performance Features .....	1-18
Ease-Of-Use Features .....	1-18
Options .....	1-18

## 2 Using the Control Panel

Overview .....	2-2
Status Screen .....	2-2
Main Menu .....	2-2
Navigation Keys .....	2-3
Printing Status .....	2-4
Options .....	2-5
Advance Media .....	2-5
Maintenance .....	2-5
Change Media .....	2-5
Load Media Sheet .....	2-5
Calibrate Printer .....	2-6
Expert Settings .....	2-6
Customize Settings.....	2-7
Settings .....	2-7
Modes .....	2-7
Restore All Defaults.....	2-8
Upgrade .....	2-8
Printer Info .....	2-9
Field Service .....	2-9

## 3 Installing Ink and Media

Variable Mode Printing .....	3-2
Installing Big Ink Packs .....	3-6
Removing and Storing a Big Ink Pack.....	3-10
Cleaning Ink Jets .....	3-11
Evaluating Cartridge Performance After Cleaning.....	3-12
Filling Depleted Cartridges and Resetting Vacuum.....	3-13
Cleaning the Service Station .....	3-14
Adjusting the Print Head Height .....	3-16
Drying Times.....	3-19
Loading Media.....	3-20
Loading Media Sheet.....	3-21
Recalibration .....	3-22
Cutting and Unloading Media.....	3-23

## **4** Calibrating the Printer

AutoSet Calibration.....	4-2
AutoBidi Calibration .....	4-4
AutoTune Scheduling .....	4-5
Quality Check Mode .....	4-5
Media Feed Calibration .....	4-6
Jet Status Lines .....	4-7
Expert Calibration Options .....	4-8
Manual Bidirectional Registration .....	4-9
Manual Head Registration.....	4-11
Manual Jet Mapping.....	4-14
Color Calibration .....	4-16

## **A** Troubleshooting

Troubleshooting Checklist .....	A-2
Diagnostics .....	A-5
ColorSpan Technical Support .....	A-6
Help From Your Organization .....	A-6
Help From ColorSpan .....	A-6
If All Else Fails .....	A-6

## **B** Technical Specifications

Specifications .....	B-2
Supported Ink and Media.....	B-4
Supplies and Accessories .....	B-6

## **Index**



# CHAPTER 1

---

## Getting Started

This chapter shows you how to get started using your printer. It includes these topics:

- ◆ Operating Requirements (page 1-2)
- ◆ Installation Checklist (page 1-5)
- ◆ Unpacking and Assembly (page 1-6)
- ◆ Workflow Overview (page 1-14)
- ◆ Parts Overview (page 1-15)
- ◆ Special Features (page 1-18)

---

## Operating Requirements

Choose a location for the printer before you unpack it. Keep the following requirements in mind:

### Electrical

- ◆ See “Connecting Power and VideoNet” on page 1-11 for detailed power requirements.
- ◆ Use the supplied power cords. Plug them directly into a grounded electrical outlet. Do not lengthen either power cord with an extension cord; the resulting voltage drop could damage the printer.
- ◆ Make sure the line voltage does not vary more than 10 percent from the voltage marked on the back of the printer. Install a voltage regulator or similar device if the power source is not stable.
- ◆ Unplug the printer during power failures. Wait for the power to return before plugging it back in.
- ◆ Connect the print server into a separate circuit from the printer.

### Environmental

- ◆ Make sure the room is well ventilated, with a temperature between 60° and 90° F (16° to 32° C). The relative humidity should be between 10 and 80 percent, non-condensing. Printing will slow automatically to aid drying in high humidity conditions.
- ◆ Performance will improve slightly as conditions approach 70° F (21° C) and 50% relative humidity.
- ◆ Store media and ink in an area with similar temperature and humidity conditions as the printer.
- ◆ Locate the printer close enough to the print server (RIP) so that they can be connected with the required cable.
- ◆ Locate the printer on a flat, level surface; otherwise, printing problems from improper ink flow could occur.
- ◆ Locate the printer where its normal operating noise will not disturb quiet work areas.
- ◆ This printer is not intended for use in a computer room.

- ◆ DO NOT install the printer near humidifiers, refrigerators, water faucets, heaters or similar equipment.
- ◆ DO NOT install the printer in areas where the temperature changes abruptly, such as near air conditioners or in the path of direct sunlight.
- ◆ DO NOT expose the printer to flames, dust or solvent chemicals.

Refer to Appendix B for detailed specifications.

## Important Operating Notes



- ◆ Wear cotton gloves (provided with each roll of ColorSpan media) when loading media to prevent fingerprints that could show after printing.
- ◆ Protect the media at all times from creases and tears, and ensure that the media is cut cleanly.
- ◆ DO NOT touch the print head's ink jet nozzles (the metal plate on the bottom of the ink cartridge) with your fingers. Any contaminants could clog the ink jet nozzles. The ink nozzles may be cleaned with a lint-free cloth.
- ◆ DO NOT touch the electrodes on the back of the ink cartridge. This could result in a faulty electrical connection, which would cause jets to misfire. If ink gets on the electrodes, clean them with a damp paper towel, or a lint-free cloth.
- ◆ DO NOT set heavy objects on the power cord or printer cable; do not bend the cables or force them into contorted positions.
- ◆ DO NOT place heavy objects anywhere on the printer.

## Safety Warnings



---

**WARNING** WITH THE POWER SWITCH IN THE OFF POSITION, POWER MAY STILL BE SUPPLIED TO THE PRINTER COMPONENTS. To completely cut power from the printer, you must unplug the power cords from the power outlets.

---



---

**WARNUNG** WENN DER NETZSCHALTER IN OFF POSITION STEHT, WIRD DEN KOMPONENTEN TROTZDEM STROM ZUGEFÜHRT. Um den Drucker komplett stromfrei zu machen, müssen Sie den Netzstecker ziehen.

---



---

**WARNING** The printer is too heavy to be lifted safely by one person. At least two persons are required to lift the printer: DisplayMaker Esprit: 270 pounds (122 kg)

---



---

**WARNUNG** Der Drucker ist zu schwer für eine Person. Mindestens 2 Personen sind erforderlich um den Drucker anzuheben. DisplayMaker Esprit: 122 kg

---



---

**WARNING** THE PRINTER ELECTRONICS ASSEMBLY CONTAINS A LITHIUM BATTERY DEVICE. THERE IS A DANGER OF EXPLOSION IF THE BATTERY IS INCORRECTLY REPLACED. The battery must be replaced only by ColorSpan authorized personnel, and must be replaced only with the same or equivalent type. Dispose of this lithium battery device in accordance with local, state (or province), and Federal (or country) solid waste requirements.

---



---

**WARNUNG** DIE ELEKTRONIK DES DRUCKERS ENTHÄLT EINE LITHIUM BATTERIE. ES BESTEHT EXPLOSIONSGEFAHR WENN DIESE UNSACHGEMÄSS AUSGEWECHSELT WIRD. Die Batterie darf nur durch einen ColorSpan autorisierten Techniker ausgewechselt werden und muss mit dem gleichen oder einem gleichwertigen Typ Batterie ersetzt werden. Bitte entsorgen Sie die Lithium Batterie gemäss Ihren Landes- oder Bundesgesetzen.

---



---

## Installation Checklist

Use the following checklist to install the printer. Detailed instructions appear on the following pages in this manual and the documentation that accompanies the server.

Step	See Page in this Manual
<input type="checkbox"/> 1. Select a location for the printer that meets its operating requirements.	1-2
<input type="checkbox"/> 2. Move the printer shipping carton to the operating location. (If necessary, you may assemble the printer in a remote location, then move it to its operating location.)	--
<input type="checkbox"/> 3. If you will be installing a ColorSpan Print Server (ColorMark Pro or RIPStation), set it up now and power it on. This will allow the server to perform its automatic one-time system setup while you unpack and assemble the printer.	(1)
<input type="checkbox"/> 4. Inspect the external packaging for shipping damage, remove packing material, account for parts.	1-6
<input type="checkbox"/> 5. Assemble the stand using the screws and screwdriver provided in the accessory box.	1-8
<input type="checkbox"/> 6. Attach the stand to the printer.	1-9
<input type="checkbox"/> 7. Lock down the casters and tilt the assembled printer upright.	1-9
<input type="checkbox"/> 8. Attach the ink tray to the printer module, remove the internal shipping foam and bands.	1-10
<input type="checkbox"/> 9. Connect power to the printer.	1-11
<input type="checkbox"/> 10. Power up the printer and observe the power-up sequence to confirm normal operation.	1-13
<input type="checkbox"/> 11. Adjust the print head carriage height.	3-16
<input type="checkbox"/> 12. Install inks.	3-6
<input type="checkbox"/> 13. Install media.	3-20
<input type="checkbox"/> 14. Perform an AutoSet calibration.	4-2
<input type="checkbox"/> 15. Connect the printer server to the printer.	(1)
<input type="checkbox"/> 16. Send a DiskDirect file to the printer (if using a ColorSpan print server), then send an application file from a Macintosh or PC workstation, to confirm a working network connection.	(1)

---

<sup>1</sup> Refer to the *Quick Start Guide* that accompanies your ColorSpan Server for instructions.

---

## Unpacking and Assembly

This procedure assumes that the printer is in its final location. See the *Site Preparation Guide* for moving and unpacking hints.



---

**WARNING** The printer is too heavy to be lifted safely by one person. At least two persons are required to lift the printer.

---



---

**WARNUNG** Der Drucker ist zu schwer für eine Person. Mindestens 2 Personen sind erforderlich um den Drucker anzuheben.

---



---

**Note** If you will be installing a ColorSpan Print Server (ColorMark Pro or RIPStation), set it up now and power it on. This will allow the server to perform its automatic one-time new system check while you unpack and assemble the printer.

---

### Unpacking

1. Examine the shipping packaging for shipping damage. Report any damage or apparent rough handling immediately to the shipper.
2. Remove the bands that secure the box to the pallet and open the top flaps of the box.
3. Remove the stand crossbar, which is packed on top of the printer.
4. Remove the stand legs and accessory boxes, which are packed together in the center of the pallet.
5. Remove the media spools, which are packed together under the printer module.
6. Remove the corrugated support packaging (end pieces, center tower).
7. Remove the outer box from the pallet.

Do not remove the printer module from the pallet at this time. The printer, resting on its back on the pallet, is at the correct height and position for assembly to the stand.



---

**Note** If possible, retain all shipping packaging for use if the printer needs to be shipped to another location. Replacement shipping packaging and instructions are also available from ColorSpan Technical Support.

---

8. Refer to the following list to verify that you received all of the parts and accessories.

Notify ColorSpan immediately if you are missing any of the components listed below.

---

<b>Main Box</b>	Outside of Box: <ul style="list-style-type: none"><li>◆ "Watch Me First" CD-ROM</li><li>◆ Unpacking &amp; Assembly Diagram</li></ul> Inside of Box: <ul style="list-style-type: none"><li>◆ Printer Module</li><li>◆ (2) Stand legs</li><li>◆ (1) Stand crossbar</li><li>◆ (1) Media spool</li></ul>
<b>Accessory Box</b>	<ul style="list-style-type: none"><li>◆ (1) Ink tray</li><li>◆ (11) Phillips head screws, black</li><li>◆ (4) Phillips head screws, silver</li><li>◆ Service Station</li><li>◆ Tool Holder</li><li>◆ Head Height Adjustment Gauge</li><li>◆ Screwdriver</li><li>◆ VideoNet or Ethernet cable</li><li>◆ (1) Power cord</li><li>◆ Power plug adapters</li><li>◆ <i>DisplayMaker Esprit User Manual</i></li><li>◆ <i>DisplayMaker Esprit Site Preparation Guide</i></li></ul>
<b>Print Server Kit (if ordered)</b>	The print server parts list will vary by model. Refer to the packing slip that accompanies the server for details.

---

## Stand Assembly

1. Locate the stand legs **1** and **2**, the crossbar **3**, and the tool holder **4**.
2. Using the Phillips head screwdriver and eight of the screws provided, assemble the stand.

Start by positioning the two stand legs upright, at approximately the width of the crossbar. Align the holes on the crossbar with the holes in the stand legs and the tool holder, and secure them with the screws.

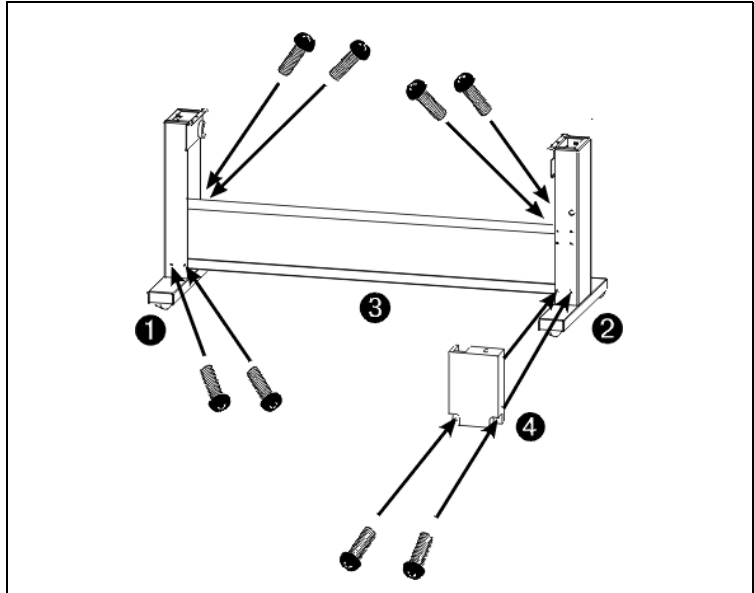

Fig. 1-1. Stand assembly

## Final Assembly

1. Gently tip the stand on its back. Protect the stand from being scratched by the floor.
2. Position the printer module **5** and stand for assembly as shown in Fig. 1-2.

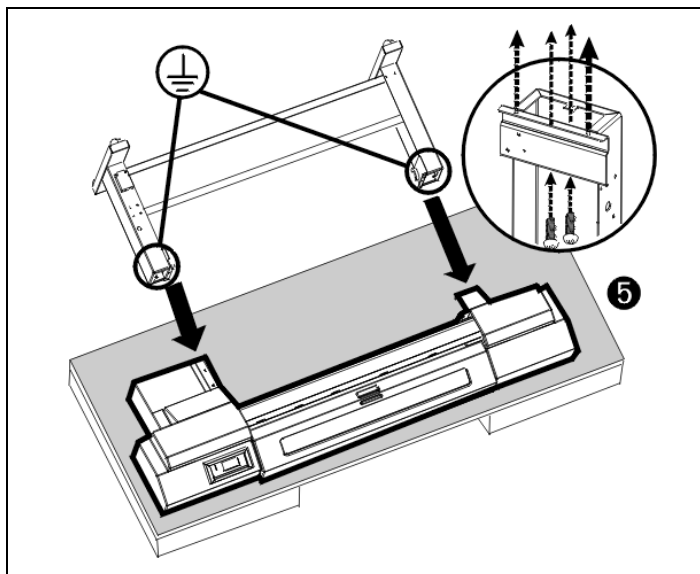

Fig. 1-2. Assemble the printer module and stand

3. Using the four SILVER Phillips head screws provided, attach the stand to printer module. (See Fig. 1-2.)



**WARNING** The silver screws are required to provide a ground connection to the printer. Failure to properly ground the printer could result in damage to the printer or injury to the operator.



**WARNUNG** Die silbernen Schrauben sind zur Erdung des Druckers erforderlich. Ist der Drucker nicht korrekt geerdet, sind Druckerbeschädigung oder Benutzerverletzung nicht auszuschliessen.

4. Press the caster locks down to prevent the printer from rolling.
5. Tilt the assembled printer upright.
6. Unlock the casters and roll the printer to its final location. Then lock down the casters.

7. Locate the printer on a flat, level floor, with all four wheels of the stand resting stationary on the floor. The printer must remain stationary and level for proper ink flow and best print quality.
8. Using three of the screws provided, attach the Big Ink Delivery System tray **6**. (See Fig. 1-3.)

There are two sets of mounting screw holes. Use the set of holes closest to the center (farthest from the end) of the printer.

Insert the three screws and tighten them most of the way, then insert and drop the trays into place onto the screws, then tighten the screws the rest of the way.

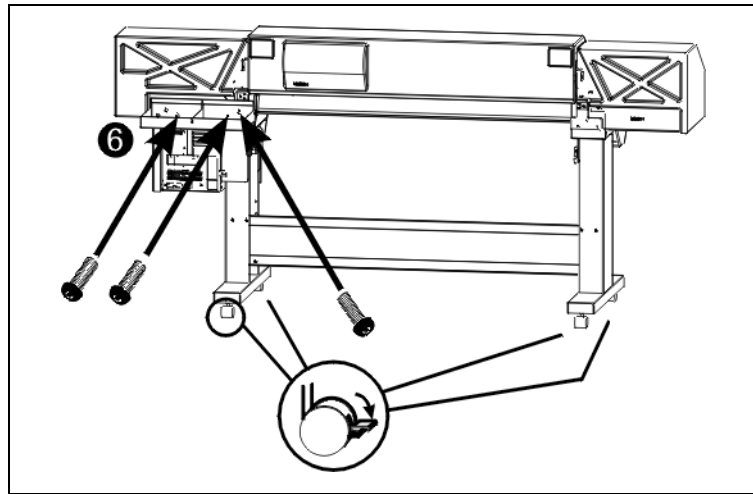

Fig. 1-3. Attach the ink tray

9. Remove the shipping bands from the long black chain connected to the print head carriage.
10. Remove the foam block that immobilizes the carriage for shipping.
11. Install the service station by inserting it into the rectangular cutout inside the right endcap (behind the control panel).

## Connecting Power and VideoNet



---

**WARNING** WITH THE POWER SWITCH IN THE OFF POSITION, POWER MAY STILL BE SUPPLIED TO THE PRINTER COMPONENTS. To completely cut power from the printer, you must unplug the power cords from the power outlets.

---



---

**WARNUNG** WENN DER NETZSCHALTER IN OFF POSITION STEHT, WIRD DEN KOMPONENTEN TROTZDEM STROM ZUGEFÜHRT. Um den Drucker komplett stromfrei zu machen, müssen Sie den Netzstecker ziehen.

---

### Power

Connect the power cord ⑧ from the printer's power inlet to a standard wall outlet. Non-U.S. installations may require one of the included power plug adapters. Refer to Fig. 1-4 for the locations of the printer power inlet.

## VideoNet

Connect the printer to the print server with the included VideoNet (for ColorSpan print servers) or Ethernet cable (non-ColorSpan RIPs) ⑦ (see Fig. 1-4).

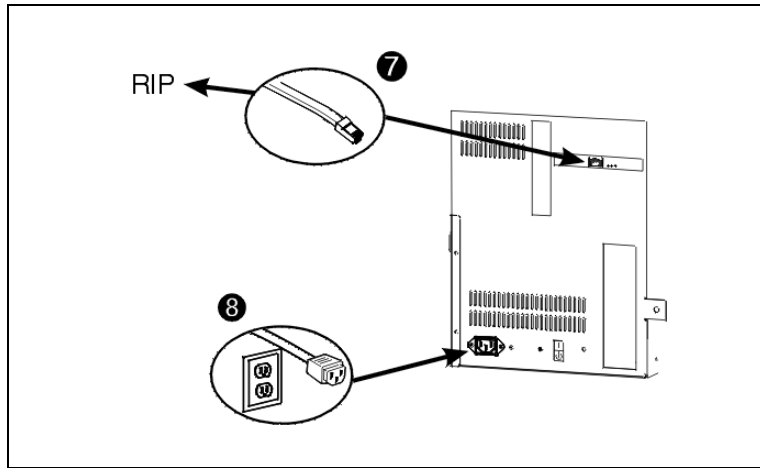

Fig. 1-4. Power and RIP connections

Refer to the print server (RIP) documentation for instructions on connecting the printer to the print server.



## Power-Up Sequence

Turn on the power switch to observe the typical power-up sequence:

1. The control panel backlight illuminates. Move the contrast lever (located to the right of the control panel screen) up and down until the control panel graphics and messages are easily visible.
2. The printer runs a series of self-tests, and reports any errors it finds.
3. The camera searches for the location of the installed media's home and far edges. If media is installed, this data tells the printer the width of the installed media. If no media is installed, the printer will prompt the user to load media when the next print job is sent to the printer.
4. The control panel displays the following message:

Ready

## What's Next?

- ◆ To familiarize yourself with the printer, refer to the remainder of this chapter.
- ◆ To proceed with installation, see Chapter 3, Installing Ink and Media.
- ◆ For a complete description of using the control panel, see Chapter 2, Using the Control Panel.

---

## Workflow Overview

Here is how a typical print job progresses from the client workstation to the printer.

### Print Server

1. An artist sends a file to be printed from a client workstation.
2. The print job is received by the print server.

Once it reaches the print server, the print job may be reprioritized, combined with other jobs, re-routed, or otherwise manipulated. Refer to the print server online help or manual for instructions.

3. The print server RIPs the job.

The raster image processing (RIP) process translates the PostScript language data that comprises the print job into the data required by the printer.

4. The server sends the image to the printer for printing.

### ColorMark Software RIP

1. An artist sends a file to to be printed to the ColorMark Software RIP.
2. The software RIPs the job.

The raster image processing (RIP) process translates the PostScript language data that comprises the print job into the data required by the printer.

3. The ColorMark Software RIP sends the image to the printer for printing.

## Parts Overview

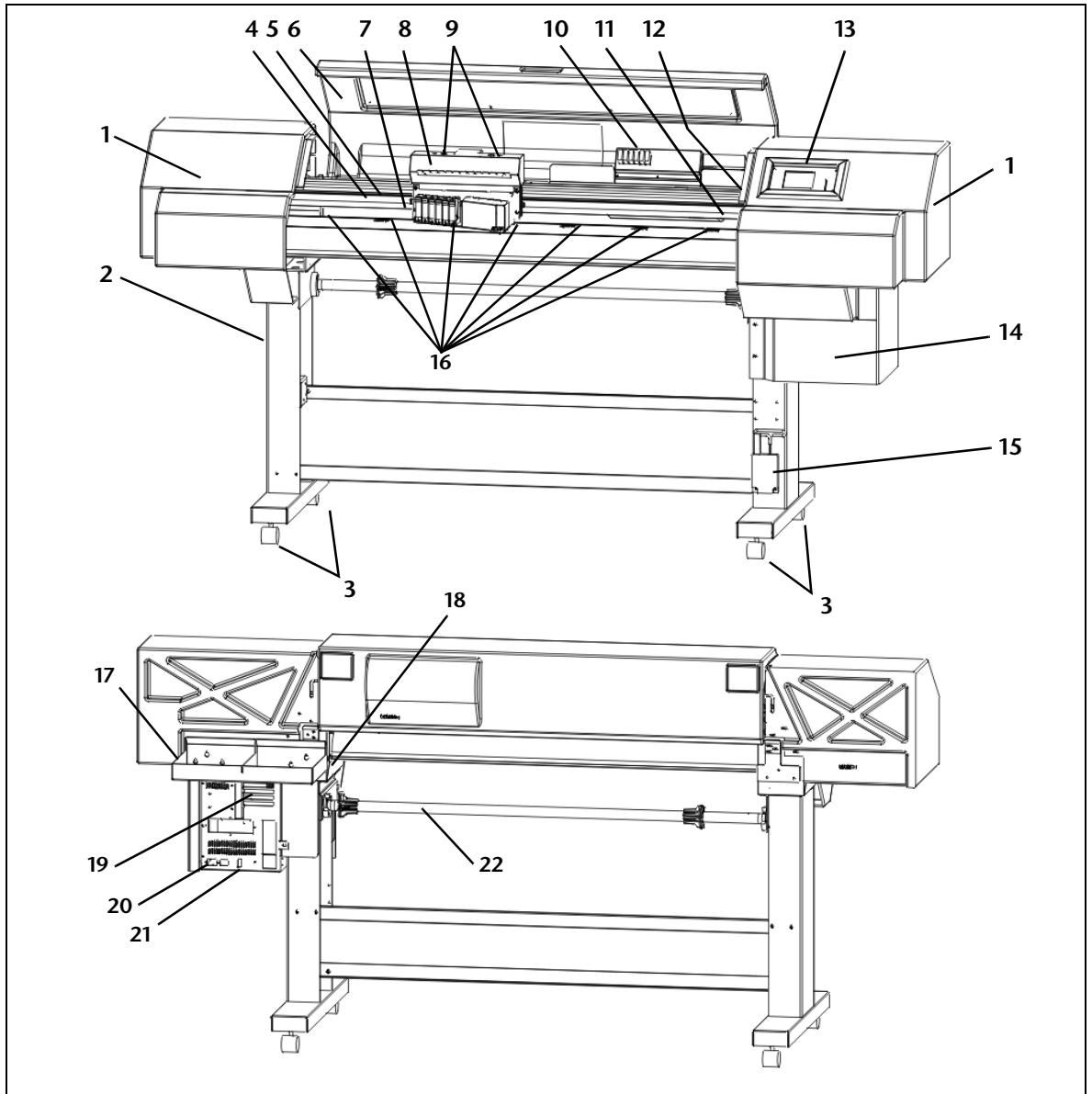

Fig. 1-5. Major parts of the printer

Number	Description
1	<b>End cap (two places)</b>
2	<b>Stand</b> - supports the printer.
3	<b>Casters (four places)</b> - enables easy movement of printer, can be locked in place.
4	<b>Encoder strip</b> - allows precise positioning of the print head carriage across the length of the platen.
5	<b>Main carriage drive belt</b> - moves the carriage across the length of the platen. <b>Transport chain</b> (not shown) - supports the ink supply tubes.
6	<b>Top cover</b> - protects the user from the rapid motion of the print head during printing. A safety interlock switch stops printing and cancels the print if the cover is raised.
7	<b>Platen</b> - supports the media under the print heads during printing.
8	<b>Carriage</b> - carries the ink jet cartridges (print heads) across the length of the platen.
9	<b>Head Height Adjustment Screw (two places)</b> - raises or lowers the carriage to accommodate thick and thin media.
10	<b>Profiler docking station</b> - holds the ink profilers, which communicate characteristics about the ink to the print server and color management system software.
11	<b>Paper out switch</b> - detects when the printer is out of media, which generates a control panel message to the user.
12	<b>Service station</b> - catches excess ink from the ink jet cartridges, wipes and caps the cartridges to prevent drying and clogging while not in use.
13	<b>Control panel</b> - displays messages and allows control of certain printer operations. Includes a contrast adjustment lever and audio feedback.
14	<b>Electronics module</b> - contains the printer's power supply and control electronics. Includes a humidity sensor to enable the printer to compensate for high-humidity conditions by slowing the speed of printing.

<b>Number</b>	<b>Description</b>
15	<b>Tools</b> - head height adjustment gauge and hex wrench, for adjusting the height of the print head carriage.
16	<b>Pinch rollers</b> - grip the media during loading and printing.
17	<b>Big Ink Delivery System tray</b> - holds Big Ink packs.
18	<b>Media advance switch</b> - enables user to manually advance media during loading.
19	<b>VideoNet port</b> - connects printer to print server.
20	<b>Power inlet</b> - connects printer to electrical power.
21	<b>Standby power switch</b> - places printer in standby mode (to disconnect from power, disconnect power cord).
22	<b>Media supply spool</b> - holds the supply of media.

---

## Special Features

The printer has several advanced automatic features to help you produce the best printed output with the least effort.

### Performance Features

- ◆ **AutoSet™ Calibration** - automatically aligns cartridges in the x-y directions and bidirectionally for precise positioning of ink jet dots, also compensates for lost or misfiring jets by correcting or substituting for them *without* slowing printing speed.
- ◆ **Head height adjustment** - allows the head height to be adjusted to accommodate various media thicknesses.
- ◆ **Straight-through media path** - allows the loading of cut-sheet and rigid media.
- ◆ **Humidity sensor** - slows printing in high humidity conditions to ensure drying, and alerts the user when ambient humidity is outside of operating range.

### Ease-Of-Use Features

- ◆ **Color Calibration** - the RIP's color management system can use the printer's on-board CCD camera to automatically color calibrate ink and media selections in one step.
- ◆ **Media width sensing** - automatically detects the width and position of the media loaded, to ensure precise image placement.

### Options

These features are available for purchase from ColorSpan:

- ◆ **12-head operation** - permits printing with three four-color ink sets, two six-color sets, or one twelve-color set.
- ◆ **Dryer heater** - assists drying prints in humid environments or for collection on the motorized takeup system.
- ◆ **Motorized takeup system** - assists with unattended printing by collecting output on a takeup spool.

# CHAPTER 2

---

## Using the Control Panel

This chapter describes the functions of the control panel.

---

## Overview

The control panel shows you the printer's current status, and enables you to interact with the printer when changing media and ink, respond to an error condition, or configure options.

### Status Screen

The status screen displays when you are not accessing the menus. It provides current printer status at a glance.

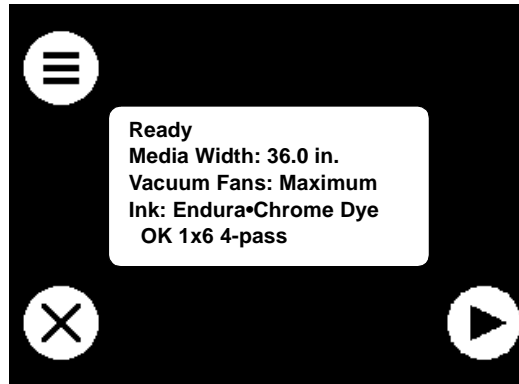



Fig. 2-1 Ready screen

### Main Menu

To display the main menu, press the  (Options) key. The main menu is the access point for all other menus and functions.

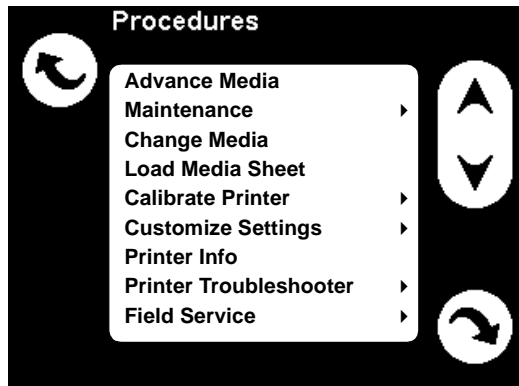









Fig. 2-2. Main Menu



## Navigation Keys

The following table shows you how to move through the menu system and perform printer control functions.

Key	Description
	<b>OPTIONS</b> - displays the main menu when not printing, and displays the Queue Management menu if pressed during printing.
	<b>PREVIOUS/Increment</b> - highlights the previous option, or increments a numeric value.
	<b>NEXT/Decrement</b> - highlights the next option, or decrements a numeric value.
	<b>MENU UP</b> - returns to the previous menu (to the main screen from the main menu).
	<b>MENU SELECT/Enter</b> - proceeds to the next menu, or selects the highlighted option.
	<b>PROCEED/Yes</b> - from a menu function, executes the function or indicates "yes."
	<b>CANCEL/No</b> - from a menu function, cancels the function or indicates "no." From a queue, deletes the current file. During printing, cancels printing.
	<b>SELECT</b> - chooses an option from a list.

## Printing Status

During printing, the following screen appears. They show the progress of any current printing or RIPing. You can press the  (Cancel) key to cancel the currently printing job.

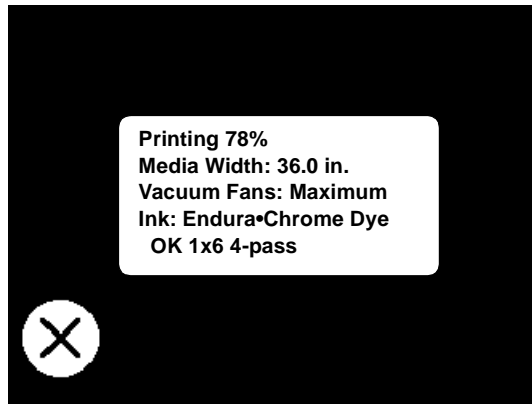





Fig. 2-3. Printing Status screen

---





## Options

When you press the  (Options) key from the printer control panel, you can scroll through each of the options by pressing the up or down arrows.

- ◆ To select an option, press the  (Menu Select) key.
- ◆ To go back to the previous level, press either the , or the  (Cancel) key.

Each of the control panel options is described in the following paragraphs.

### Advance Media

- ◆ Press the  key to advance the paper forward. When you press and hold the  key, the paper moves faster. You can also press the Media Advance switch on the rear of the printer, below the left profiler docking station, to advance the paper.
- ◆ Press the  key to advance the paper back onto the supply spool. When you press and hold the  key, the paper moves faster.

### Maintenance

- ◆ **Prime** - Fires all jets by drawing a set of lines called “prime bars.” This is a good way to inspect and prepare the jets for printing after they have been idle for more than a few hours.
- ◆ **Access Print Heads** - Selecting this option moves the carriage out of the service station so you can load one or more Big Ink packs or clean the print heads. See “Installing Big Ink Packs” on page 3-6 for instructions.
- ◆ **Access Service Station** - Selecting this option moves the carriage out of the service station to a point left of the Access Print Heads position.

### Change Media

Selecting this option causes the printer to measure the width of the media installed in the printer. This is also done automatically when the printer is powered on and before each print job.

### Load Media Sheet

Selecting this option allows you to load a cut sheet of media, rather than a roll-fed sheet. After selecting this option, stand in front of the printer, and place the media as instructed by the control panel. The printer will pull the sheet toward the rear of the printer, and measure its width and starting position. See “Loading Media Sheet” on page 3-21 for instructions.

## Calibrate Printer

This menu consists of the following options:

- ◆ **AutoSet Calibration** - runs the printer's automatic jet mapping and x-y alignment routine. The printer prints a series of calibration patterns, automatically reads each one, adjusts the print heads' alignment, and repeats this cycle until the heads are aligned. When AutoSet is complete, press  (Cancel) repeatedly until the control panel displays "Ready to receive." For further information, see "AutoSet Calibration" on page 4-2.
- ◆ **AutoBiDi** - runs just the bidirectional calibration, and not the entire AutoSet calibration, when the head speed and print mode are changed.
- ◆ **AutoTune** - if the optional takeup motor is installed, allows you to schedule AutoSet to automatically run after a certain number of prints have printed. For further information, see "AutoTune Scheduling" on page 4-5.
- ◆ **Media Feed** - allows you to calibrate the paper advance accuracy. See for "Media Feed Calibration" on page 4-6 for instructions.
- ◆ **Jet Status Lines** - prints the Jet Status Lines test pattern without prompting for calibration values.

## Expert Settings

These calibration options should be used only at the direction of ColorSpan Technical Support. They allow you to manually perform the various components of the automatic AutoSet calibration. Inaccurate judgments by the operator during these tests could result in substandard output. In most cases, use AutoSet instead.

- ◆ **Manual BiDi Registration** - prints bidirectional alignment patterns and allows you to report which pattern is the most precise. This pattern allows adjustments of one pixel. See "Manual Bidirectional Registration" on page 4-9 for instructions.
- ◆ **Manual Head Registration** - prints a registration pattern and allows you to register the position of each print head. This is the manual version of AutoSet Calibration. See "Manual Head Registration" on page 4-11 for instructions.
- ◆ **Manual Jet Mapping** - prints a pattern that enables you to identify which jets are not firing ink. See "Manual Jet Mapping" on page 4-13 for instructions.

- ◆ **Reset Reg Data** - resets all registration data to their factory default values.

## Customize Settings

This menu consists of two submenus: Settings and Modes.

### Settings

- ◆ **Takeup Direction** - (available if takeup motor is installed) allows you to wind the printed output onto the takeup spool Image Inside or Image Outside.
- ◆ **Space Between Prints** - allows you to set the amount of blank space between prints.
- ◆ **Top Gutters** - allows you to enable or disable the top gutter pattern, which displays technical details about the print, outside the top edge of the print.
- ◆ **Side Gutters** - allows you to enable or disable the side gutter pattern, which fires all jets in a narrow, medium, or wide pattern at the right and left edges of the print, for troubleshooting purposes.
- ◆ **Service Station** - allows you to specify the print head service station spit-and-wipe cycle: 30 seconds, 90 seconds (default), or 30 seconds with spit only (no wipe).
- ◆ **Humidity Sensor** - allows you to use the printer's preprogrammed algorithm for slowing the print speed when the ambient relative humidity is excessive, or allows you to specify a custom print speed. Slower print speeds allow adequate drying under higher ambient relative humidity.
- ◆ **Vacuum Fan Speed** - allows you to control the speed (and therefore suction power) of the vacuum fans. Maximum speed is recommended for most media, but lighter or polyester film media may require a slower speed for best results.
- ◆ **AutoSet Summary** - allows you to enable or disable the printed summary of an AutoSet calibration.
- ◆ **Units** - allows you to display values in U.S. or metric units of measure.

### Modes

- ◆ **Dryer Fan** - allows you to disable the dryer fan (if installed) to avoid streaking output on films such as ViewThrough Backlit.
- ◆ **3x Mode** - specifies the mode to use when the printer detects that three four-color ink sets are loaded (if upgraded).

- ◆ **1x/2x Mode** - specifies the mode to use (2, 4, 6 or 8 passes) when the printer detects that one or two ink sets are loaded. See “Variable Mode Printing” on page 3-2 for a description of print modes.
- ◆ **Quality Check Mode** - when enabled, AutoSet will report when calibration fails. This is designed to work with AutoTune scheduling (see “Media Feed Calibration” on page 4-6). This can give the operator a chance to print anyway, or cancel printing so the problem can be resolved. You can select a mode to suit your quality requirements:
  - ◆ **OFF** - no quality check is performed, all jobs will print regardless of whether AutoSet was successful.
  - ◆ **Attended Mode** - user must press  (Proceed) to acknowledge the error and print the job (if one is pending), or  (Cancel) to cancel printing.
  - ◆ **Unattended Mode** - no user acknowledgment of errors is required. When AutoSet fails, print jobs are sent to the ColorSpan print server’s Attention queue with a disposition of “Uncalibrated Printer.”
- ◆ **Camera Vision Mode** - enables improved calibration for soft signage (textile) media by causing the camera to read the larger calibration targets designed for these media. Select Textured for soft signage, or Normal for graphics media. When you reload media, this mode automatically resets to Normal (graphics media) mode.

## Restore All Defaults

Select this option to restore all variables under Settings and Modes to their default values.

## Upgrade

Select this option to upgrade the printer to support 12-head printing. This upgrade is available for purchase from ColorSpan. The printer software supplies an upgrade code number, which you give to ColorSpan Technical Support in exchange for an “upgrade key” number. When you enter the upgrade key number, the printer enables 12-head printing.

## Printer Info

This option displays a screen with the following information:

- ◆ **Printer Model** - model name of the printer.
- ◆ **Software Version** - version number of the software installed on the printer.
- ◆ **Company** - company ID, used for OEM versions of the printer.
- ◆ **Humidity** - relative humidity as detected by the printer's humidity sensor.
- ◆ **Total RAM** - amount of memory (RAM) installed in the printer.
- ◆ **Takeup Motor Status** - present or not present.
- ◆ **Drying Fans** - present or not present.
- ◆ **Ethernet ID** - the printer's Ethernet address.
- ◆ **Link** - connection speed and connection status (up or down).

## Field Service

These functions are for use by authorized service providers.





# CHAPTER 3

---

## Installing Ink and Media

This chapter describes:

- ◆ Variable Mode Printing (page 3-2)
- ◆ Installing Big Ink Packs (page 3-6)
- ◆ Removing and Storing a Big Ink Pack (page 3-10)
- ◆ Cleaning Ink Jets (page 3-11)
- ◆ Cleaning the Service Station (page 3-14)
- ◆ Adjusting the Print Head Height (page 3-16)
- ◆ Drying Times (page 3-19)
- ◆ Loading Media (page 3-20)
- ◆ Cutting and Unloading Media (page 3-23)

---

## Variable Mode Printing

The printer features a variety of print modes, each with a different speed and quality level. The following table summarizes the features of each printing mode.

Mode	Color Set	Resolution
High Speed Production	1 x 4 (CMYK)	600 dpi
	2 x 4	
	3 x 4*	
Gamut+	1 x 6 (CMYKOG, CMYKRB, CMYKOB)	600 dpi
	2 x 6*	
HiRes	1 x 6 (C2M2YK)	1200 dpi (apparent)
	2 x 6* (C2M2YK)	
Film Quality	1 x 8 (C3M3YK)	1200 dpi (apparent)
HiRes+	1 x 8 (C2M2YKOG, C2M2YKRB, C2M2YKOB)	1200 dpi (apparent)
12 Color	1 x 12* (C3M3YKOGRB)	1800 dpi (apparent)

\*Available as an upgrade option.

The printer uses these techniques to balance print speed and quality of a print:

- ◆ **Color Set** - a four-color ink set consists of Cyan, Magenta, Yellow, and Black inks. A Gamut+ set consists of Cyan, Magenta, Yellow, and Black, plus two of Orange, Green, Blue, or Red. A HiRes (six-color multidensity) set consists of Cyan, Magenta, Yellow, and Black, plus medium densities of Cyan and Magenta. A Film Quality (eight-color multidensity) set consists of Cyan, Magenta, Yellow, and Black, plus medium and light densities of Cyan and Magenta. A twelve-color set consists of all of these colors.
- ◆ **Passes** - number of times the print head passes over a given area of the image. 1x and 2x ink sets can be printed with 2, 4, 6, or 8 passes. 3x ink sets (available as an upgrade option) can be printed in 3 or 6 passes.

- ◆ **Jet Replacement** - jets on the print head that are misfiring or not firing at all can be replaced with alternate jets.

Print quality (apparent resolution and smooth gradients) is improved by increasing the number of passes or the number of different ink colors. Print speed is increased by reducing the number of passes or the number of different colors, and by printing without jet replacement (High Speed mode only).

The printer will use the mode specified on the control panel (see “Modes” on page 2-7 for instructions).

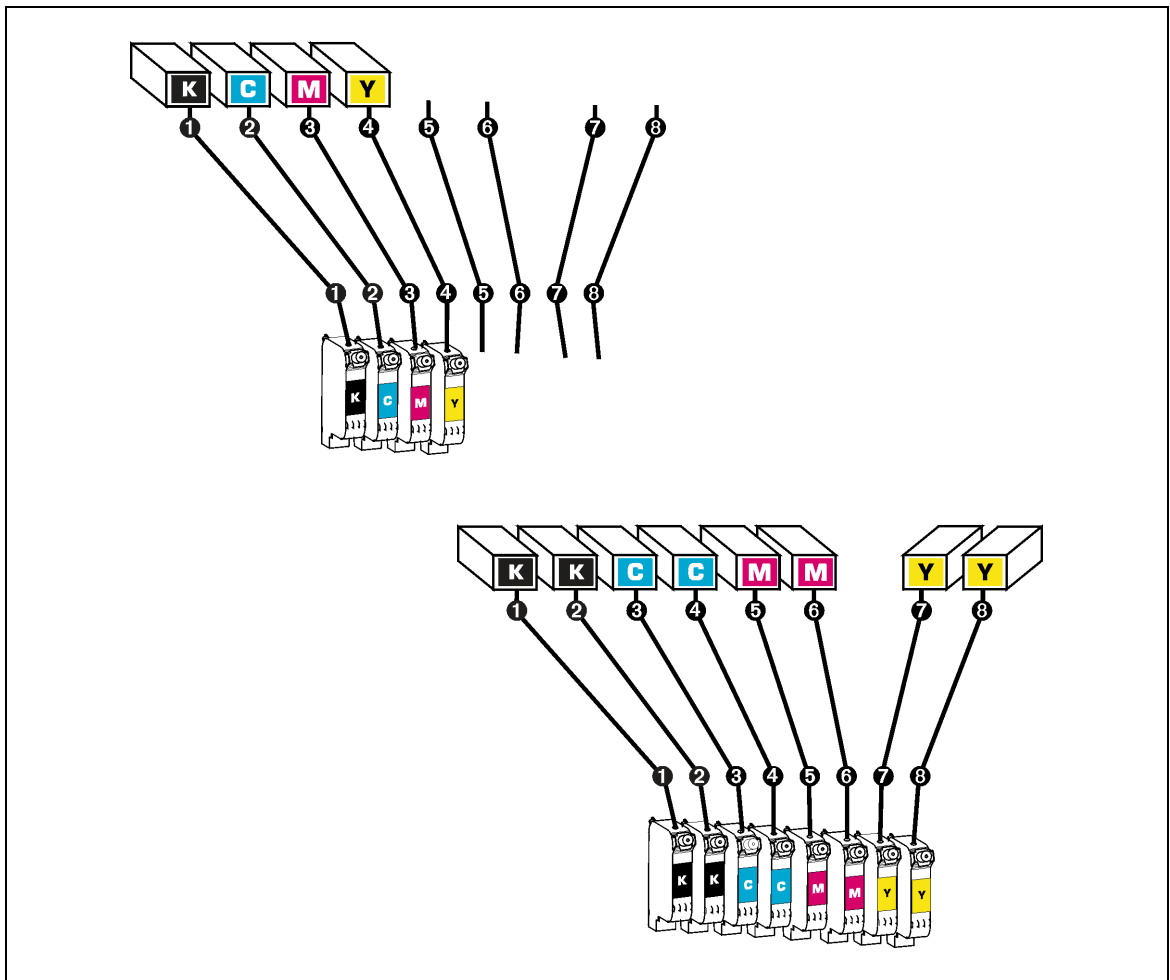

Fig. 3-1. Big Ink Pack positions for High Speed “1 x 4” and “2 x 4” ink sets

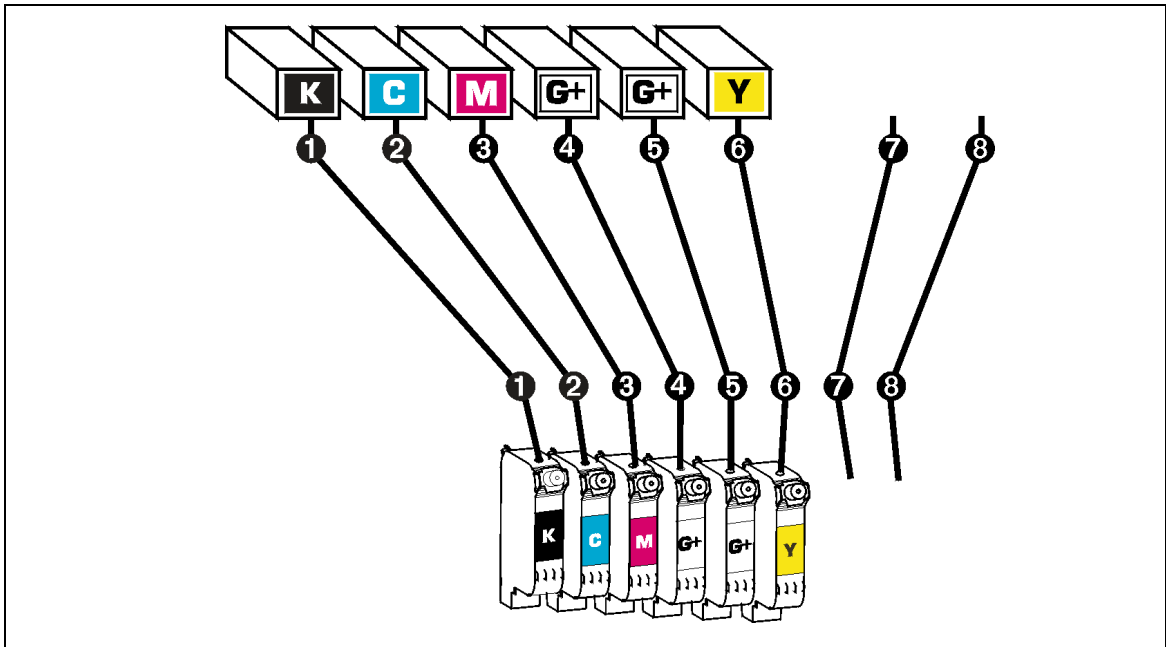

Fig. 3-2. Big Ink pack positions for Gamut+ "1 x 6" ink sets

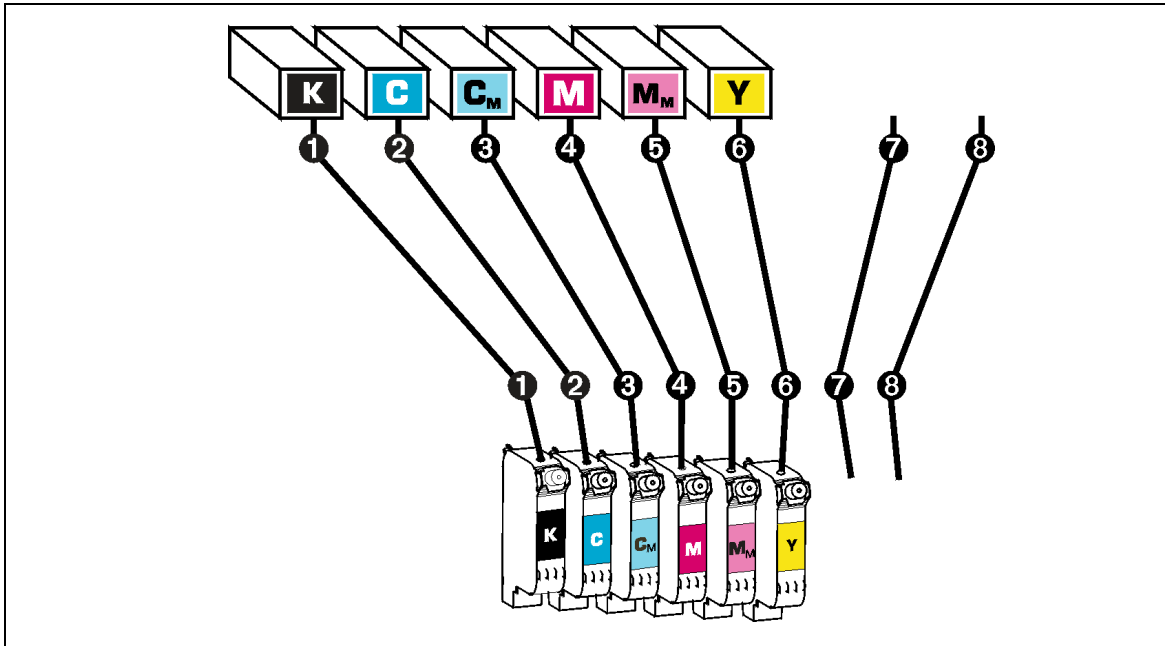

Fig. 3-3. Big Ink pack positions for HiRes "1 x 6" ink sets

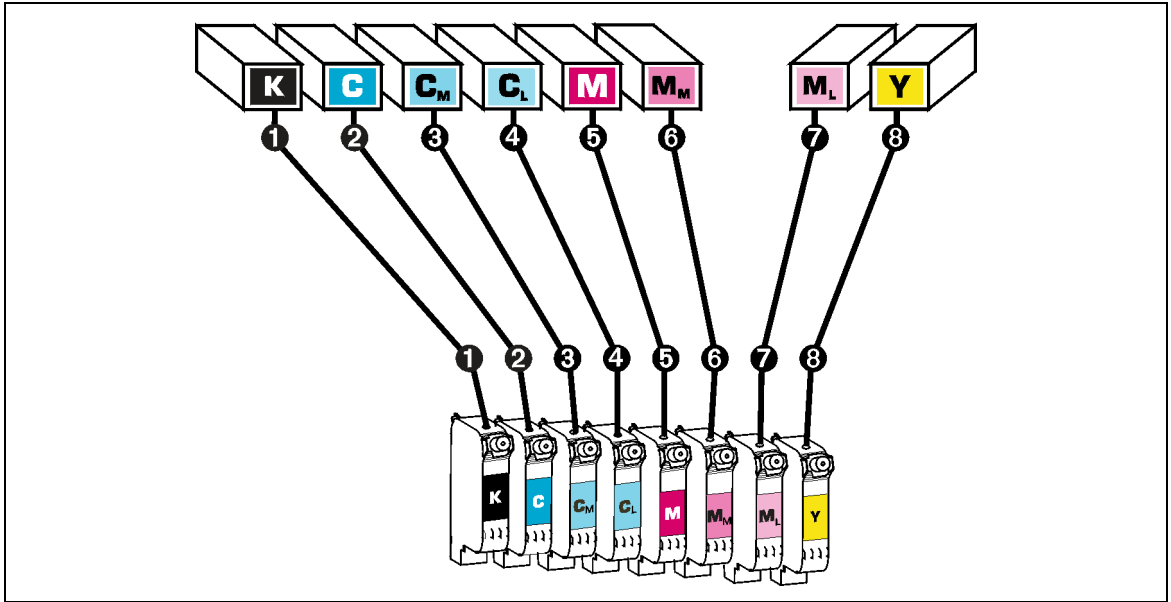

Fig. 3-4. Big Ink pack positions for HiRes+ "1 x 8" ink sets

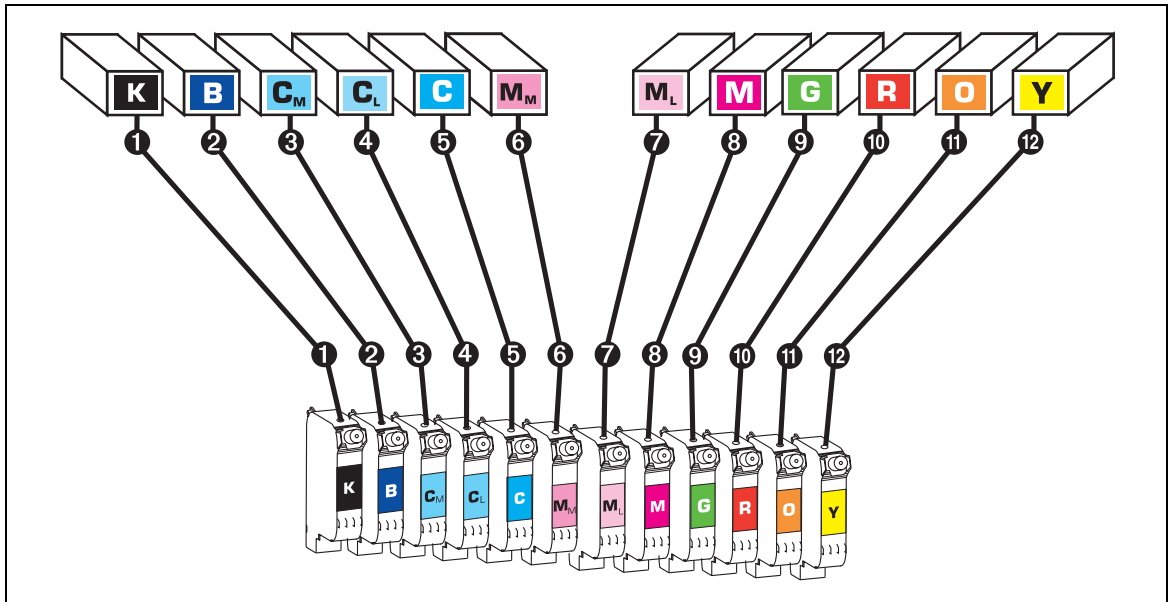





Fig. 3-5. Big Ink pack positions for "1 x 12" ink sets

---

## Installing Big Ink Packs

*To remove a Big Ink pack, refer to "Removing and Storing a Big Ink Pack" on page 3-10.*

You may perform this procedure whenever no printing is in progress.

1. Move the print head carriage to the access position.
  - a. On the control panel, press the  (Options) key.
  - b. Press the  key to select **Access Print Heads**.
  - c. Press the  (Menu Select) key. This moves the print head carriage into the access position.
2. Open the top cover of the printer.
3. Locate the set of Big Ink packs you will be loading.

Each Big Ink pack consists of the ink supply, ink tube, ink cartridge, and profiler. You will repeat the following procedure to load each Big Ink pack. Start with a Black ink pack.

4. Ensure that the ink valve on the Big Ink pack you are installing is closed.
5. Insert the ink profiler into the docking station.

The **ink ordinal number** on the profiler and cartridge indicate their relative position in the printer. The cartridges must always be positioned in order from lowest ID to highest ordinal number, from left to right (position 1 through 6), with like ordinal numbers adjacent to each other.

In order to print, there must always be at least one Big Ink pack and profiler each of Cyan, Yellow, Magenta, and Black, with a Black profiler and cartridge in position 1.

6. Place the Big Ink pack into its position in the ink tray.

Position the end of the box with the tube attached toward the printer. Refer to the ink routing label in the printer for the location of each Big Ink pack.
7. Uncoil the Big Ink tube from the Big Ink pack.
8. Smooth out any twists or kinks from the ink tube
9. Gently remove *both* pieces of protective tape from the ink cartridge. Save tape to seal a partially-used ink pack.

The hole on the bottom of the cartridge must be clear of all tape and adhesive to work properly. Make sure that all tape and adhesive is removed from the cartridge.

### Ink Cartridge Handling Tips

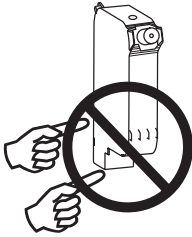

- ◆ Hold the ink cartridge only by the plastic body.
- ◆ **DO NOT** touch the ink jet nozzles on the bottom of the cartridge.
- ◆ **DO NOT** touch the electrodes on the back of the cartridge. The ink cartridge is fired by an electrical signal. The electrodes that carry this signal are easily contaminated.
- ◆ **DO NOT** set the ink cartridge down anywhere before you install it.
- ◆ **DO NOT** wipe the ink cartridge with any fiber-cellulose material, such as a paper tissue.
- ◆ **NEVER APPLY ISOPROPYL ALCOHOL ON THE CARTRIDGE OR SERVICE STATION. USE PLAIN WATER.** Alcohol reacts with pigmented inks, rendering the cartridge unusable. For stubborn clogs, see "Cleaning Ink Jets" on page 3-11.

10. Insert the bottom edge of the ink cartridge into position on the print head carriage, then push the top of the ink cartridge into position until you feel it snap into place in the holder.

You should feel a slight resistance as the cartridge snaps into place. **DO NOT** force the ink cartridge. If it does not snap easily into place, you may not have aligned it properly into the print head. Push back on the cartridge to verify that it is seated firmly.

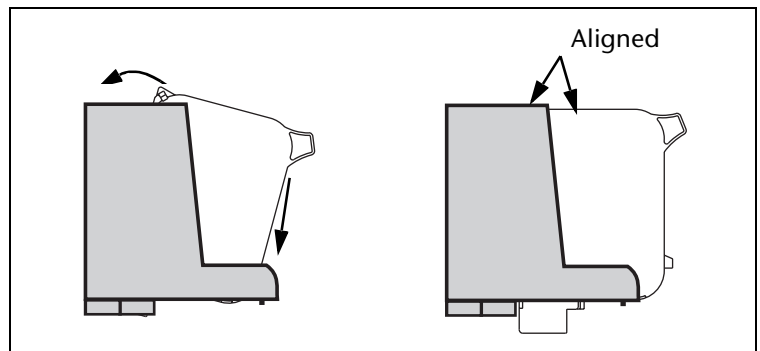

Fig. 3-6. Loading a cartridge

11. Press the tube into the routing clips along the track.

Start at the cartridge end of the tube and work toward the Big Ink pack trays. Do not apply tension where the tube attaches to the ink cartridge, or ink leakage could occur.

The routing clips allow the tube to lay flat along the track. Do not leave any slack in the hose along the track, but do not place any tension on the tube.

Keep the tube in the same position along the entire length of the track. This will enable you to replace any single Big Ink pack, without the ink tubes becoming tangled with one another.

Do not allow the tubes to become crimped.

12. Loosely coil the excess ink tubing and neatly place it on top of the Big Ink pack.

Keeping the ink tubes neatly organized will make it easier to replace individual packs.

13. Repeat steps 4 through 12 for each of the remaining Big Ink packs to be loaded.
14. Open the valves on all of the ink tubes, and ensure that there are no kinks or obstructions in the tubes. Massage out the crimp in the tube created by the valve.
15. Return the print head carriage to the service station.

The control panel should display the message “Press proceed to park heads.” Press the  (Proceed) key. This moves the print head carriage back to the service station.

16. If necessary, adjust the print head height.

For instructions, see “Adjusting the Print Head Height” on page 3-16.



17. Load media.

For instructions, see "Loading Media" on page 3-20.

The first time you install media on a new printer, run a Paper Feed Calibration. For instructions, see "Media Feed Calibration" on page 4-6.

18. Run AutoSet.

For instructions, see Chapter 2, Using the Control Panel. Run AutoSet whenever you install or replace a cartridge (for example, after cleaning the cartridge or replacing a Big Ink pack).

19. If you are loading ink for the first time or switching ink or media types, perform a color calibration. For further information, see "Color Calibration" on page 4-16.

---

## Removing and Storing a Big Ink Pack



You can store partially-used Big Ink packs. This enables you to switch between different types of ColorMark Big Ink as needed.

1. Close the valve on the ink tube.

---

**Caution** Failure to close the valve completely will result in leaking ink and possible loss of vacuum in the ink tube.

---

2. Remove the profiler from the docking station.
3. Remove the ink pack, the tube, and the cartridge as a unit from the printer.

Release the ink tube from its clips, starting at the Big Ink pack and work your way toward the cartridge.

4. Keep the profiler with its Big Ink pack. The profilers are not interchangeable, even between Big Ink packs of the same color.

Tape the profiler to the partially-used Big Ink pack, and store them together in a Big Ink shipping carton if possible.

5. Retape the original sealing tape over the heads on each cartridge, and store the cartridges upright.

This prevents air from entering the tubes and minimizes subsequent priming of the jets when placed back into service.

---



## Cleaning Ink Jets

In addition to running AutoSet, which compensates for missing and misfiring ink jets, you should clean the jets as described in the following paragraphs to keep them clear of accumulated ink.

The effectiveness of the high-resolution printing process used by the printer can be impaired by cartridges that are improperly maintained. Partially clogged nozzles may cause the jets to misfire intermittently, or deflect ink slightly in the wrong direction.

Cleaning will likely be required more often if the printer sits idle for extended periods.

### To clean ink jets:

1. On the control panel, press  (Options).
2. Press  twice to highlight **Access Print Heads**.
3. Press  (Menu Select).

The carriage moves out from the service station and stops.  
The control panel displays this message:

Press proceed  
to park heads



4. Open the printer's top cover.
5. On one of the ink tubes, close the valve near the Big Ink pack.  
Failing to do this can cause ink to flow backwards into the Big Ink supply, which may keep the cartridge from refilling.
6. Release the ink jet cartridge from the print head carriage.
7. Gently wick the ink jet nozzles and wipe the electrical contacts with a nonfibrous, lint-free foam swab moistened with water. **DO NOT USE ALCOHOL**, use plain water.  
  
If you find excessive buildup on the bottom of the cartridge, clean off the excess using a moistened pad, and then wipe the bottom of the cartridge with the swab.
8. Replace the ink jet cartridge into the print head carriage.
9. Repeat this process for each cartridge.



---

**Caution** When handling cartridges, do not touch the contacts or orifice plate (jet nozzles) with your bare fingers. Also, take care not to use excessive force when wiping the cartridges with the swabs or pads.

---

10. Open the valve on the hose near the Big Ink packs.
11. Clean the service station as described in "Cleaning the Service Station" on page 3-14.
12. Close the printer's top cover.
13. Press the  (Proceed) key to park the heads.
14. Press the  (Cancel) key to return the printer to its ready state.
15. Perform an AutoSet calibration. For instructions, see Chapter 2, Using the Control Panel.

### **Evaluating Cartridge Performance After Cleaning**

The Jet Status Lines test provides a quick method of determining the effectiveness of (or the need for) cleaning. This test prints a pattern of lines, each segment of which corresponds a single jet. If there are any missing segments in the lines, then a cleaning is recommended. If, however, the lines appear solid and consistent, then cleaning is most likely not required at this time. See "Jet Status Lines" on page 4-7 for instructions.

The AutoSet calibration can also indicate that cleaning is needed. When AutoSet maps out a significant number of jets due to D (missing), or X and Y (alignment) errors, it is probably due to clogged and deflected jets. In this case, cleaning is recommended.

## Filling Depleted Cartridges and Resetting Vacuum

Occasionally, you may find that the cartridge does not fill from the Big Ink pack supply. The primary cause of this is failure to open the clip on the ink pack tube after installing an ink pack. If a cartridge leaks ink, it may have lost vacuum. To correct these conditions:

1. Have a paper towel ready to catch any leaking ink during this procedure.

This procedure may cause ink to drop on the floor.

2. Remove the ink tube from the routing clips on the track.
3. Remove the cartridge from the print head carriage. Do not close the ink tube clip.
4. Move the cartridge, with the ink jets pointed up, below the level of the ink pack (close to the floor), until ink and air bubbles begin to flow out of the ink jets.
5. Hold the cartridge in this position, and sharply squeeze the sides of the cartridge repeatedly until no more air bubbles emerge from the jets (when ink begins to flow from the jets).
6. To reset the vacuum, hold the cartridge, with the ink jets pointed down (as when the cartridge is installed in the printer), approximately three feet (90 cm) above the level of the ink pack for exactly 10 seconds.
7. Reinstall the cartridge into the print head carriage.

---

## Cleaning the Service Station

The printer's service station wipers should be cleaned daily, and when switching between dye and pigment inks. This will help to prevent dried ink from clogging the ink jets.

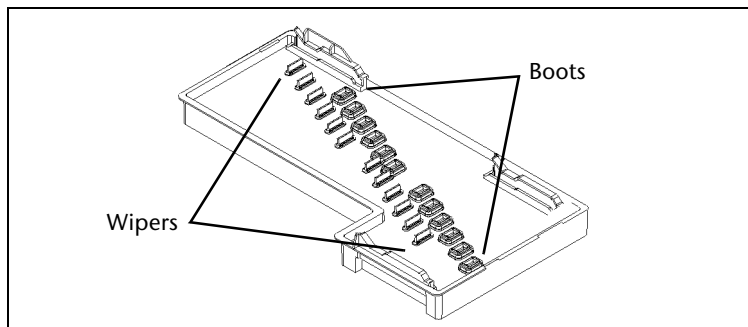





Fig. 3-7. Service station parts



---

**Caution** To avoid contaminating the ink, keep water away from the boots and boot holders during this procedure.

---

1. Once each day, press the  (Options) key to display the main menu.
2. Press the  key repeatedly to highlight **Access Service Station**.
3. Press the  (Menu Select) key.

This moves the print head carriage out to the center of the platen. The control panel displays this message:

Press proceed to park heads.

4. Reach inside the right endcap (behind the control panel) and lift the service station out of the printer.  
Hold the service station level to avoid spilling any ink that may be present.
5. Hold the service station with the wipers under a stream of water, keeping the boots away from the water.  
Rinse as much ink as possible from the wipers.
6. Blot any remaining water from the service station with a clean, lint-free cloth.

To avoid contaminating the ink, be sure to dry all water from the boots and boot holders.

7. Reinstall the service station.

The service station fits inside a rectangular cut-out in the printer.

Press the  (Proceed) key to park the print head carriage.

---

## Adjusting the Print Head Height

To accommodate media with a wide range of thicknesses, you can adjust the height of the print heads with the included head height gauge and 5 mm hex wrench. The tools are stored in a holder, which is located on the right stand leg under the control panel.

To adjust the print head height, you turn the adjustment screws on the right and left sides of the carriage until the gauge fits under the carriage. When used according to these instructions, the gauge positions the print heads approximately 0.050 inches (1.27 mm), or 50 mils, above the media.

1. Determine which end of the head height gauge to use.
  - ◆ **For media between 3 and 15 mils thick** (0.076-0.381 mm), ensure that no media is loaded on the printer, or at least is not on the platen. In this case, the head height is measured from the platen. Use the gauge end marked "0.003 - 0.015." This will position the head 0.059 inches (1.50 mm) above the platen.
  - ◆ **For media between 15 and 30 mils thick** (0.381-0.762 mm), ensure that no media is loaded on the printer, or at least is not on the platen. In this case, the head height is measured from the platen. Use the gauge end marked "0.015 - 0.030." This will position the head 0.072 inches (1.82 mm) above the platen.
  - ◆ **For media greater than 30 mils thick** (0.762 mm), load the media onto the printer. In this case, the head height is measured from the media. Use the gauge end marked "0.003 - 0.015." This will position the head 0.059 inches (1.50 mm) above the media.
  - ◆ **For media which "bubbles" or doesn't pull down flat to the platen, raise the head height sufficiently to prevent the head from contacting the media.**



2. Use the hex wrench to turn one of the head height adjustment screws counterclockwise until the end of the gauge will *not* fit under the carriage as shown in Fig. 3-8.

The access holes to the head height adjustment screws are marked with white circles on top of the carriage.

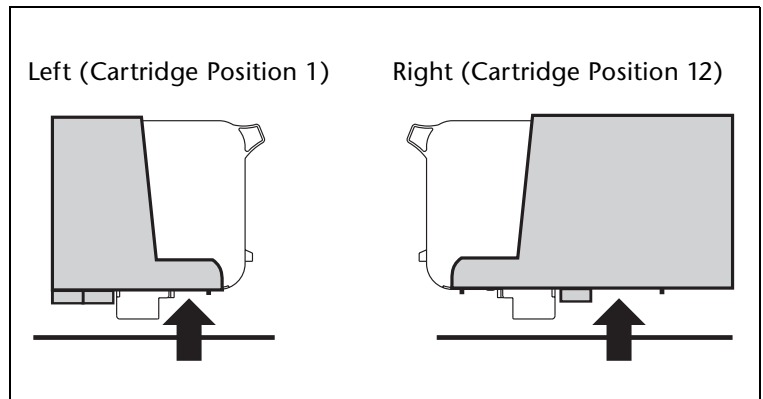

Fig. 3-8. Head height measurement points

3. Turn the head height adjustment screw clockwise, until the end of the gauge slides under the carriage and the raised gauge step touches the carriage.



**Caution** Do not allow the taller surface of the gauge to slide under the print head carriage. Damage to the carriage could result.

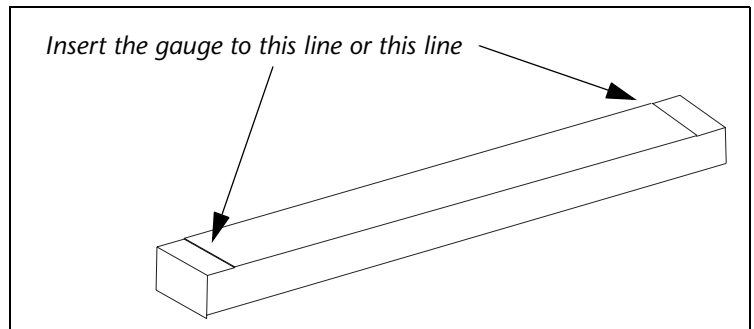

Fig. 3-9. Head height gauge

4. Remove the gauge and repeat steps 2 and 3 at the other side of the carriage.
5. Verify the heights at both sides of the carriage and adjust if necessary.
6. Remove the gauge and return it and the wrench to their holder on the printer stand.

---

## Drying Times

The amount of drying time required for a print depends on its ink coverage, the number of print passes used, and the relative humidity where the printer is being operated.

To illustrate these relationships, the following table shows the results of a test in which a 300% coverage test pattern was printed. The amount of time shown is the delay required at the end of each swath (right-to-left or left-to-right motion) of the print head carriage to ensure that the first three inches of the print are dry by the time the leading edge of the print reaches the floor. This delay is automatically implemented during printing (see "Customize Settings" on page 2-7).

This test was designed to illustrate an extreme ink coverage example. Typically, coverage is around 100%, which significantly reduces drying time. Drying times can also be reduced by using the optional heated dryer.

Print Passes	Relative Humidity		
	25%	50%	75%
2 passes	2.5 sec	7 sec	—
4 passes	1 sec	4 sec	16 sec
6 passes	—	3 sec	—
8 passes	0 sec	1 sec	—

---

## Loading Media

Wear cotton gloves during this procedure, or handle the media only by its very outside edges. This will prevent skin oils from being deposited on the media, which could render output quality unacceptable.



---

**Note** For best results, use genuine ColorSpan media.

---

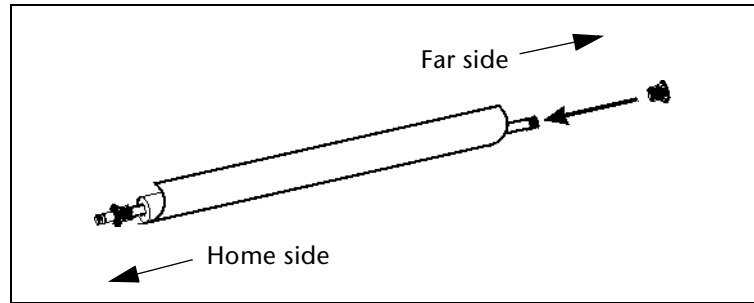

Fig. 3-10. Installing media roll and collets onto the spool

1. Load the collet with the setscrew onto the spool, and tighten the setscrew into the outside hole of the spool (if the media is on a 3-inch core, position the collet to the inside hole of the spool).

2. Load the media roll onto the spool so that it unrolls over the top of the spool.

See "Settings" on page 2-7 to set the takeup motor for Small (2-inch) or Large (3-inch) cores.

3. Load and press the adjustable collet (without the pin) tightly into the end of the cardboard media core.
4. From the rear of the printer, load the media and spool into the printer's supply spool holder.

Press the home side of the supply spool into the home side holder (on the left from the rear of the printer), then swing the far side of the supply spool into the far side holder (on the right).

5. With your right hand, feed the leading edge of the media into the printer's pinch rollers and hold it in place until the following step.



---

**Note** The printer automatically locates the right and left edges of the media, so it is not necessary to align the media edges to a reference mark on the platen.

---



6. With your left hand, press the Media Advance button to advance media a few inches (several centimeters).  
The Media Advance button is located to the left of the installed supply spool, on the rear of the printer next to the Big Ink pack tray and electronics enclosure.
7. Roll the media supply spool back sharply, about one-quarter turn, so the media snaps flush onto the platen.
8. Ensure that the right and left edges of the media web are perpendicular to the sides of the printer, that the tension appears uniform across the media web, and that the media is not unrolling unevenly (“telescoping”) from the supply spool.



---



**Note** These checks ensure that the tension is uniform across the width of the media. This is critical to trouble-free printing.

---

9. On the control panel, press  (Options) to display the menu, highlight **Change Media**, and press  (Menu Select).  
This causes the printer to measure the width of the media.
10. You are now ready to begin printing.

## Loading Media Sheet



When loading cut sheets of media, wear cotton gloves during, or handle the media only by its very outside edges. This will prevent skin oils from being deposited on the media, which could render output quality unacceptable.

1. On the control panel, press  (Options).
2. Press  three times to highlight **Load Media Sheet**.
3. Press  (Menu Select).

The control panel displays instructions for loading cut sheet media into the printer. These instructions are:

4. Push the media sheet under the rollers.

Make sure that the right hand edge of the media sheet is centered between the two rightmost rows of vacuum holes on the platen.

5. Adjust the head height if necessary.
6. Press  and  buttons to move the media under the rollers.
7. Close the cover on the printer.
8. Press the  (Proceed) key to AutoLoad the cut media sheet.

## Recalibration

When changing media types, you should perform a color calibration (if supported by your printer or RIP). This compensates for the differences between medias that affect color accuracy. For further information, see “Color Calibration” on page 4-16.

When replenishing the media supply with the same type of media, recalibration is unnecessary unless print quality has changed noticeably.

---

## Cutting and Unloading Media

1. Use the control panel or press the MEDIA ADVANCE button to advance the printed portion of the media past the cutter anvil (on the front edge of the platen).
2. From the front of the printer, cut the media with a knife or scissors.

If you use a knife, you can insert it into the channel at the front of the platen to ensure a straight cut.

3. Remove the print from the printer.





# CHAPTER 4

---

## Calibrating the Printer

This chapter explains how to calibrate the printer for the best possible output:

- ◆ AutoSet Calibration (page 4-2)
- ◆ AutoBidi Calibration (page 4-4)
- ◆ AutoTune Scheduling (page 4-5)
- ◆ Media Feed Calibration (page 4-6)
- ◆ Jet Status Lines (page 4-7)
- ◆ Manual Bidirectional Registration (page 4-9)
- ◆ Manual Head Registration (page 4-11)
- ◆ Manual Jet Mapping (page 4-14)
- ◆ Color Calibration (page 4-16)

---

## AutoSet Calibration

**AutoSet™** is an advanced printer calibration feature that uses an onboard camera and sophisticated software to detect and compensate for variations in ink jet printing. It can be initiated by the user or run automatically at specified intervals. AutoSet is designed to be a “one-button” calibration, the only calibration you need to run in most cases for superior quality output.

AutoSet consists of three separate functions:

- ◆ **AutoJet Calibration** - detects and disables individual ink jets that are misfiring or not firing at all. During subsequent printing, the printer compensates for these jets by using other jets in their place, ensuring maximum print quality without reducing print speed.
- ◆ **Bidirectional Registration** - ensures that every working jet fires a pixel at precisely the same location, regardless of the carriage’s direction of travel.
- ◆ **Head Registration** - precisely aligns each cartridge in the horizontal (x) and vertical (y) directions.



**Note** Clean cartridges always produce the best printed output. Ensure that the cartridges and service station are clean before running an AutoSet calibration.



---



**Note** AutoSet does not work with transparent media such as ColorMark ClearFilm. In this case, you should run AutoSet on a white media that is similar in thickness to the clear media, then switch to the transparent media; or manually run the calibrations under the Expert Settings menu using the transparent media.

---



### To run AutoSet once:

1. Ensure that media is loaded on the printer.
2. On the control panel, press the  (Options) key to enter the menu system.
3. Press the  key repeatedly to highlight the **Calibrate Printer** option.
4. Press  (Proceed).

The Calibrate Printer menu appears, with AutoSet highlighted.

5. Press  (Proceed).

The AutoSet calibration begins. First, AutoSet tests the jets on each cartridge for electrical failure.

- ◆ If any jets with electrical failures are found, the printer displays a list of the failed jets. Then press  (Menu Select) to run AutoSet.
  - ◆ If too many cartridges are found with an electrical failure, an accurate AutoSet calibration cannot be performed. Clean the electrical contacts, inspect the flex cable, and reinstall the cartridge(s) specified on the control panel, then press  (Retry) run the electrical test again.
6. AutoSet prints a calibration pattern, then looks for missing and deflected jets on each cartridge.
    - ◆ If a small number jets on any one cartridge are missing or deflected, AutoSet will compensate for them during printing.
    - ◆ If too many jets on any one cartridge are missing or deflected, AutoSet marks the cartridge as out-of-specification. It then asks whether you want to view a list of these cartridges.
  7. When AutoSet completes, press the  (Cancel) key repeatedly until the **Ready to receive** message appears.

---

## AutoBidi Calibration

Runs just the bidirectional calibration, and not the entire AutoSet calibration, when the head speed and print mode are changed.

When you change the print mode that includes a head speed change, a message is displayed on the control panel asking if you wish to run AutoBidi.

### To run AutoBidi:

1. Press  (Proceed).

The AutoBidi procedure runs.

### If you choose not to run AutoBidi:

1. Press  (Cancel).







The printer returns to the Modes menu.



---

## AutoTune Scheduling

AutoTune is available only when the optional takeup system is installed. When you use the AutoTune scheduler to run AutoSet, AutoSet always performs its three calibrations without prompting the user or canceling due to too many bad jets. You can use the Quality Check Mode feature to handle AutoSet errors, with or without user intervention.

### To run AutoSet at specified intervals (AutoTune):

1. On the control panel, press the  (Options) key to enter the menu system.
2. Press the  key repeatedly to highlight the **Calibrate Printer** option.
3. Press  (Menu Select).  
The Calibrate Printer menu appears.
4. Press the  key repeatedly to display the "AutoTune" option.
5. Press  (Menu Select).  
The control panel prompts you to specify an AutoTune interval.
6. Press  (Proceed).  
The control panel displays this message:  

Run AutoSet every 0 prints.
7. Press the  key repeatedly to increment the AutoTune interval to the number of prints you desire.
8. Press  (Proceed).
9. Press the  (Menu Up) key repeatedly until the control panel reads **Ready**.

### Quality Check Mode





When you run AutoSet manually, the software notifies you if there are any jet or alignment problems so that they can be addressed. When AutoTune runs AutoSet at scheduled intervals, you can use the Quality Check Mode feature to handle AutoSet errors. For instructions on setting the Quality Check Mode, see page 2-8.

---

## Media Feed Calibration



This calibration allows you to calibrate the accuracy of the Media Feed process. You may want to do this when printed output must be precise, as when tiling output. This calibration is not included in the AutoSet process.

To perform this procedure you need a one-meter metric ruler.

1. Press the  (Options) key on the control panel to display the menus.
2. Press the  key repeatedly to highlight the **Calibrate Printer** option.
3. Press the  (Menu Select) key to display the Calibrate Printer menu.
4. Press the  key repeatedly to highlight the **Media Feed Calibration** option.
5. Press  (Menu Select).

The control panel displays this prompt:





Print media feed  
calibration marks?

6. Press  (Proceed).  
The printer prints a calibration page.
7. When the calibration page has printed, cut it from the printer and lay it on a flat surface.
8. Measure the distance between the cross-shaped targets marked "MEDIA FEED CALIBRATION MARK."  
The distance should be exactly 900 mm.
9. Using the control panel, enter the measured distance.  
You can enter the distance to a precision of 0.5 mm.
10. Press  (Proceed).  
Media feed calibration is complete.

---

## Jet Status Lines

Jet Status Lines provides a quick assessment of which jets are not firing properly. This test prints a pattern of lines, each segment of which corresponds a single jet. If there are any missing segments in the lines, then a cleaning is recommended. If, however, the lines appear solid and consistent, then cleaning is most likely not required at this time.

1. Press  (Options) on the control panel to display the menus.
2. Press the  key to highlight the **Calibrate Printer** option.
3. Press  (Proceed) to display the Calibrate Printer menu.
4. Press the  key repeatedly to highlight the **Jet Status Lines** option.
5. Press  (Proceed).

The printer prints the Jet Status Lines pattern and a legend for the possible status codes:

R - Not replaced  
E - Electrical jet-out  
D - Disqualified by camera  
Y - Y error  
X - X error

If a line appears with no code, the jet is working properly. If a line appears with a code other than R, it has been identified and replaced by (reassigned to) other jets. If a line is missing and appears with or without an R, it has not been replaced.

After printing is complete, the Calibrate Printer menu reappears.

---

## Expert Calibration Options

AutoSet is designed to be a “one button” calibration. Manually performing the component calibrations of AutoSet is time-consuming and error-prone. They should only be performed as directed by ColorSpan Technical Support.

If you decide to manually calibrate the printer, first clean the print heads as described in “Cleaning Ink Jets” on page 3-11.

Next, perform one or more of the following calibrations:

- ◆ **Manual BiDi Registration** prints bidirectional registration patterns and allows you to report which pattern is the most precise. For instructions, see “Manual Bidirectional Registration” on page 4-9.
- ◆ **Manual Head Registration** (page 4-11) precisely aligns the print heads relative to each other, for accurate colors and precise registration of images.
- ◆ **Manual Jet Mapping** (page 4-14) enables you to detect and report nonfiring or misfiring ink jet nozzles, which enables the printer to “fill in” for them.

After calibration, perform a color calibration (if supported by your print server or RIP). This adjusts printing for variations in ink, media, and local environment to ensure accurate color matching. You should perform a color calibration when:

- ◆ When you notice a shift (change) in color output
- ◆ When changing ink types or sets
- ◆ When changing media types
- ◆ When changing print mode (only if the most precise color matching is required)

For further information, see “Color Calibration” on page 4-16.









---

## Manual Bidirectional Registration





Bidirectional registration is a method to align each of the cartridges so that dot placement is accurate in both directions along the X axis (along the direction of print head travel).

The bidirectional registration pattern consists of a series of vertical lines. Half the pixels in this pattern are printed in one direction, half of them in the other direction. When the pixels are accurately aligned, the pattern is clear. When the dots are not aligned, the pattern appears fuzzy and ill-defined.

1. When loading fabric, begin with step 7.
2. Press  (Options) on the control panel to display the menus.
3. Press the  key to highlight the **Calibrate Printer** option.
4. Press  (Proceed) to display the Calibrate Printer menu.
5. Press the  key repeatedly to highlight the **EXPERT SETTINGS** option.
6. Press  (Proceed) to display the EXPERT SETTINGS menu.
7. Press  (Proceed) to select Manual BiDi Registration, the default option.

The control panel displays this prompt:

Print a calibration  
page now?

8. Press  (Proceed).
9. Press the  or  keys to select the Extra-Coarse, Coarse, Medium, or Fine pattern.
10. Press  (Proceed).

The printer prints a calibration page.

11. When the calibration page has printed, the control panel displays this prompt:

BIDI REG

HEAD1 0

12. Examine the BiDi Registration pattern for the current head, and determine which pattern is the closest to perfectly aligned.

Use a printer's loupe to select the pattern, since the lines in the patterns may be difficult to discern otherwise.

In the example below, the best aligned pattern is +2.

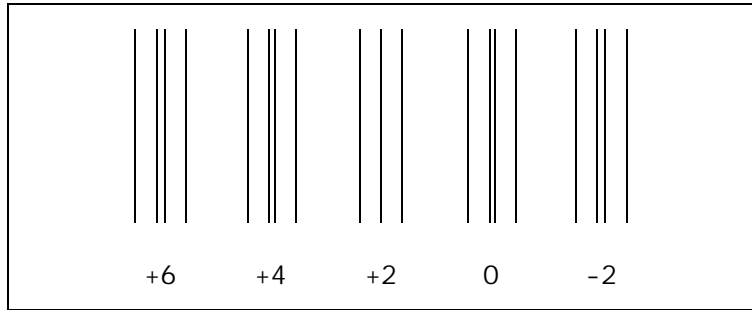





Fig. 4-1. BiDi Registration pattern

13. Press the  or  control panel keys repeatedly until the number next to the pattern that is closest to aligned perfectly is displayed.

For example, if pattern +2 is the closest aligned, press the  key to change the display to:

BIDI REG

HEAD1 3

14. Press  (Proceed).

The control panel message increments the head number by one.

15. Repeat steps 12 through 14 for each of the twelve heads.

When you have entered registration values for all heads, the control panel displays this message:

REGISTRATION COMPLETE

Bidirectional registration is complete.







16. Press the  (Menu Up) key repeatedly to return the printer to its ready state.

---

## Manual Head Registration

The printer creates images by firing dots of ink onto a sheet of media. Precise positioning of each dot is essential for optimal print quality. This is possible only if you register all ink cartridge heads in the print head assembly to each other in both the **X** (along the length of the platen) and **Y** (along the length of the media) directions.

This is a two-part process:

- ◆ Print a registration pattern.
  - ◆ Enter the X and Y registration data for each head.
1. Press  (Options) on the control panel to display the menus.
  2. Press the  key to highlight the **Calibrate Printer** option.
  3. Press  (Proceed) to display the Calibrate Printer menu.
  4. Press the  key repeatedly to highlight the **Expert Settings** option.
  5. Press  (Proceed) to display the Expert Settings menu.
  6. Press the  key repeatedly to highlight the **Manual Head Registration** option.
  7. Press  (Proceed).

The control panel displays this prompt:

Print a calibration  
page now?

If you have a calibration pattern from a recent print, you can use it to calibrate the heads. Press  (Cancel) and go to step 8.

If you need to print a new calibration pattern, press  (Proceed). The printer prints a calibration page.

8. When the calibration page has printed, the control panel displays this prompt:

X REG  
HEAD-1            +0

9. Examine the X registration pattern for the current head, and determine which pattern of colored and black lines are the closest to perfectly aligned.

Use a printer's loupe to select the pattern, since the lines in the patterns may be difficult to discern otherwise.

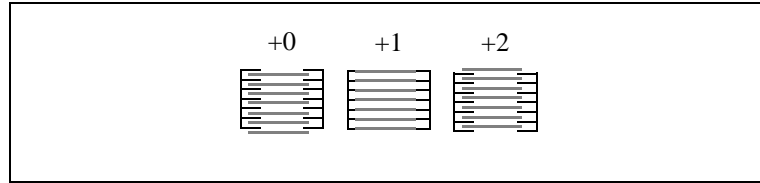





Fig. 4-1. Sample head calibration patterns.  
In this example, pattern "+1" is aligned the closest,  
so "+1" would be entered.

10. Press the  or  control panel keys repeatedly until the number next to the pattern that is closest to aligned perfectly is displayed.

For example, if pattern +2 is the closest aligned, press the  key to change the display to:

```
      X REG  
HEAD-1      +2
```

If a print head is extremely out of alignment, there may be no pattern in alignment. Since the black vertical bars are five pixels apart, you can add +5 or -5 to a pattern number to shift the colored bars right or left by one black bar. Alternatively, you can repeatedly perform an X calibration, which will move the head in smaller increments, until the head is aligned.

11. Press  (Proceed).

The control panel message increments the head number by one.



12. Repeat steps 9 through 11 for each of the heads.

When you have entered registration values for all the heads, the control panel displays this message:

```
      Y REG  
HEAD-7      +0
```

X registration is complete. You are now ready to begin Y registration.

13. Examine the Y registration pattern for the current head, and determine which pattern of colored and black lines are the closest to perfectly aligned.

14. Press the  or  control panel keys repeatedly until the number next to the pattern that is closest to aligned perfectly is displayed.

15. Press  (Proceed).

The control panel message increments the HEAD number by one.

16. Repeat steps 13 through 15 for each of the Y patterns.

When you have entered registration values for all of the patterns, the control panel displays this message:

Registration  
successful.

17. Press  (Proceed) to return to the **Head Registration** menu.

18. Press  (Cancel) repeatedly to return the printer to its ready state.

---

## Manual Jet Mapping

Each of the ink cartridges used by the printer includes a print head with over two hundred and forty ink jet nozzles (jets). If any one of these jets is clogged or has a bad electrical connection, print quality may be affected. A certain number of non-firing jets is within the performance specifications of most printers that use this technology.

---

**Note** For best results, before performing this procedure, clean the print heads as described in “Cleaning Ink Jets” on page 3-11.







---

*Autodetected missing jets (marked with an E) sometimes can be recovered by carefully wiping the electrical contacts on the cartridge and their corresponding contacts on the print head carriage with a lint-free wipe moistened with plain water.*

Using a patent-pending technique, the printer “fills in” the pixels that were not printed by the non-firing jets, without reducing print speed. The end result is that every print is made with no missing pixels.

The printer automatically maps out missing jets that are not firing for electrical reasons. Jets that are missing or misfiring for other reasons are usually detected during the AutoSet or AutoJet calibrations. You may also map jets manually using the following procedure.

### To report missing jets:

1. Press  (Options) on the control panel to display the menus.
2. Press the  key to highlight the Calibrate Printer option.
3. Press  (Menu Select) to display the Calibrate Printer menu.
4. Press the  key repeatedly to highlight the EXPERT SETTINGS option.
5. Press  (Proceed) to display the EXPERT SETTINGS menu.
6. Press the  key repeatedly to highlight the Manual Jet Mapping option.
7. Press  (Menu Select).

The control panel displays this message:

Print a jet test  
page now?

8. Press  (Proceed).

The printer prints a jet test page. When the calibration page has printed, the control panel displays a Map Jets Out menu with these options:

- ◆ Report individual bad jets - enables you to select a head number, then enter the number of one or more bad (missing) jets.
- ◆ Clear individual bad jets - enables you to remove a jet, specified by head and jet number, from the list of bad jets.
- ◆ View current bad jets - enables you to list all of the bad jets, by number, for each head.
- ◆ Clear all bad jets - enables you to delete all previously-reported bad jets from the lists for all heads.

9. Examine the jet test pattern for missing jets.



If a line segment is marked with an E (electrical failure) or U (user specified jet out), or other letters or numbers, it has already been detected by the software, so no further action by you is required. This data, however, may be requested by ColorSpan Technical Support to help diagnose printing problems.



---

<b>Note</b>	If the test detects (marks with an E) that more than twelve jets are missing on any one print head, the cartridge may be improperly seated. Try reseating the cartridge and selecting View current bad jets from the menu. If this does not correct the problem, missing jets sometimes can be recovered by carefully wiping the electrical contacts on the cartridge and their corresponding contacts on the print head carriage with a lint-free wipe moistened with plain water.
-------------	---

---

10. Select an option from the menu.

If a line segment is missing or broken, report it to the printer by selecting **Report individual bad jets** and pressing  and  to select a head number and jet number.

11. When you have reported all missing jets, press  (Cancel).
12. Press  (Proceed) to return to the Manual Jet Mapping menu.
13. Press the  (Menu Up) key repeatedly to return the printer to its ready state.

---

## Color Calibration

In addition to the printer engine calibrations described in this chapter, color calibration is necessary to ensure accurate color matching and color consistency from print to print. Color calibration is a feature of the print server or RIP connected to the printer. Refer to the documentation that accompanies the print server for further information.



# APPENDIX A

---

## Troubleshooting

This appendix explains how to prevent and diagnose printing problems and provides information about getting help from ColorSpan.

For other software-specific troubleshooting procedures, refer to your application software documentation or the other ColorSpan documentation listed on page vi of this manual.

If your printer is connected to a non-ColorSpan RIP or print server, refer to the accompanying third-party documentation.

---

## Troubleshooting Checklist

Before you troubleshoot your printer, make sure that it is properly installed as described in Chapter 1.

Follow the steps in this checklist to isolate and resolve printing problems.

### 1. Does the printer's power come ON?

**YES:** Go to question 2.

**NO:** The following could be the problem:

- ◆ The power cable may not be plugged into an electrical outlet.
- ◆ If the printer is plugged into a surge protector, the surge protector may not be connected to power, or it may be switched off.

### 2. Did the start-up sequence of the control panel display end with the message "Ready"?

**YES:** Go to question 3.

**NO:** The following could be the problem:

- ◆ There may be a hardware problem with the printer's internal components. Follow the diagnostic routine on the control panel to determine the problem. Call ColorSpan Technical Support as directed by the control panel.

### 3. Can you send a file from the print server to the printer?

**YES:** Go to question 4.

**NO:** The following could be the problem:

- ◆ The cable may not be securely connected between the print server and the printer. Refer to the server's documentation for more information.
- ◆ The cable may be connected to the wrong port on the print server. Refer to the server's documentation for more information.

**4. Can you send (print or download) a document from a client computer to the server?**

**YES:** Go to question 5.

**NO:** The following could be the problem:

- ◆ The connection from the client to the local area network may not be configured correctly. See your system administrator for assistance.
- ◆ The cable between your computer or network and the print server may not be securely connected at both ends. Refer to the print server manual for more information.
- ◆ Your computer may not be working properly. Run an application that you know works correctly and print to be sure.
- ◆ The computer's port may not be working properly. Print to another output device that you know works correctly (and is not connected to the print server) to check this.
- ◆ There may be another error condition reported by the print server.

**5. Is the print quality good?**

**YES:** Then the problem is not covered in this checklist. Contact ColorSpan Technical Support.

**NO:** The following could be the problem:

- ◆ The printer may need to be calibrated. See "AutoSet Calibration" on page 4-2 for instructions.
- ◆ One or more ink jets may be clogged or not firing. See "Cleaning Ink Jets" on page 3-11 for instructions.
- ◆ If the print head is striking the media, check how the media is tracking from the supply spool to the takeup spool. The sides of the media should be parallel to the sides of the printer, with no wrinkling or buckling. If necessary, reload the media. See "Loading Media" on page 3-20 for instructions.
- ◆ Verify that the print head carriage is at the proper height. See "Adjusting the Print Head Height" on page 3-16 for instructions.
- ◆ One or more of the ink supply boxes may have lost vacuum, which prevents the ink cartridge from filling. See "Filling Depleted Cartridges and Resetting Vacuum" on page 3-13 for instructions.

## 6. Is the carriage hitting the media?

- ◆ Be sure the media is installed straight.
- ◆ Extend the media to the front of the platen before starting to print.
- ◆ If small portions of media are lifting off the platen, make sure the vacuum fans are set to "high". If the problem persists, raise the head height.
- ◆ When running plastic media, the vacuum may need to be reduced.

---

## Diagnostics

The printer includes a series of self-diagnostic tests designed to help ColorSpan Technical Support solve printer hardware problems. If one of the tests encounters an error, and error message appears, which includes:

- ◆ Error code - always write down this code for future reference by ColorSpan Technical Support.
- ◆ Brief description of the error
- ◆ A series of buttons that allow you to respond to the error. In some cases, you can ignore the error or enter a further diagnostic routine. In other cases, you must restart the printer.

---

---

---

---

# APPENDIX B

---

## Technical Specifications

This chapter lists the printer's specifications and information about ordering supplies.

---

## Specifications

### General

---

<b>Dimensions (Assembled)</b>	<b>52-inch model:</b> Height: 50.5 inches (128 cm) Depth: 33 inches (84 cm) Length: 102 inches (259 cm) <b>62-inch model:</b> Height: 50.5 inches (128 cm) Depth: 33 inches (84 cm) Length: 112 inches (310 cm)
<b>Weight (Assembled)</b>	52-inch model: 245 pounds (111 kg) 62-inch model: 265 pounds (120 kg)
<b>Electrical Power</b>	100-120 VAC, 50-60 Hz (maximum), 4.0 A (printer), 13.2 A (heater) 200-240 VAC, 50-60 Hz (maximum), 9 A (printer and heater) Power supply automatically switches voltage, see "Connecting Power and VideoNet" on page 1-11 for detailed electrical requirements
<b>Temperature</b>	Storage: 0–120° F (-17–49° C) Operating: 60–90° F (16–32° C)
<b>Relative Humidity</b>	Storage: 10–80%, non-condensing Operating: 10–80%, non-condensing, 40–60% optimum Built-in humidity sensing automatically adjusts printing speed to ensure adequate drying for the combination of media and ink selected
<b>Approvals</b>	Safety: UL, TUV, c-UL Emissions: FCC-A, CE, VCCI-1

---



## Performance

Mode	Color Set	Passes	Speed (ft <sup>2</sup> /hr)	Resolution
<b>High Speed</b>	1 x 4 (CMYK)	2*, 4, 6, 8	—	600 dpi
	2 x 4	2*	150	600 dpi
		4	104	
		6	70	
		8	52	
3 x 4**	3*, 3, 6	—	600 dpi	
<b>Gamut+</b>	1 x 6 (CMYKOG, CMYKRB, CMYKOB)	2*, 4, 6, 8	—	600 dpi
	2 x 6**	2*, 4, 6, 8	—	600 dpi
	1 x 8 (CMYKOGRB)	2*	75	600 dpi
		4	52	
		6	35	
8		26		
<b>HiRes</b>	1 x 6 (C2M2YK)	2*	75	1200 dpi
		4	52	(apparent)
		6	35	
		8	26	
	2 x 6**	2*, 4, 6, 8	—	1200 dpi (apparent)
<b>HiRes+</b>	1 x 8 (C2M2YKOG, C2M2YKRB, C2M2YKOB)	2*	75	1200 dpi
		4	52	(apparent)
		6	35	
		8	26	
<b>Film Quality</b>	1 x 8 (C3M3YK)	4	52	1800 dpi
		6	35	(apparent)
		8	26	
<b>12 Color</b>	1 x 12** (C3M3YKOGRB)	2*, 4, 6, 8	—	1800 dpi (apparent)

Print speeds vary with humidity conditions and media/ink combinations.

\* No jet replacement.

\*\* 12-head option is available for purchase from ColorSpan.

<b>Humidity Compensation</b>	Slows printing in high-humidity environments (within specifications) to improve drying.
<b>Heated Drying</b>	Available as an option for purchase from ColorSpan.
<b>Motorized Takeup</b>	Available as an option for purchase from ColorSpan.
<b>Maximum Print Width</b>	51.5 inches (131 cm)
<b>Cut-Sheet Media</b>	Printer can accommodate cut-sheet paper or rigid media up to 1/8 inch (3 mm) thick. Any media to be printed must have an inkjet coating.

## Supported Ink and Media

Genuine ColorMark® inks and media have been tested and selected for optimal performance on ColorSpan printers. They are also supported by the ColorMark Color Management System for optimal color matching. Additional inks and media may be supported. Inks are available in a variety of dye-based and pigment-based formulations. Certain ink and media combinations are not supported. Consult ColorSpan or your ColorSpan representative for details.

## Supported ColorMark Ink Sets

<b>Four-Color Printing</b>	4-Color set: Cyan, Magenta, Yellow, Black
<b>Six-Color Printing</b>	<p><b>Gamut+™</b>  HiFi Set: Cyan, Magenta, Yellow, Black, Orange, Green. Provides striking green and orange tones.</p> <p>R&amp;B Set: Cyan, Magenta, Yellow, Black, Red, Blue. Provides key colors most frequently requested by corporate clients for logos</p> <p>Advantage Set: Cyan, Magenta, Yellow, Black, Orange, Blue. Provides the widest gamut.</p> <p><b>HiRes</b>  Multidensity Set: Cyan, Magenta, Yellow, Black, Medium Cyan, Medium Magenta</p>

<b>Eight-Color Printing</b>	<b>Film Quality</b> Multidensity Set: Cyan, Magenta, Yellow, Black, Medium Cyan, Medium Magenta, Light Cyan, Light Magenta  <b>HiRes+</b> Multidensity Set: Cyan, Magenta, Yellow, Black, Medium Cyan, Medium Magenta plus choice of two of four additional colors: Red, Blue, Orange, or Green.
<b>Twelve-Color Printing*</b>	Multidensity Set: Cyan, Magenta, Yellow, Black, Medium Cyan, Medium Magenta, Light Cyan, Light Magenta, Red, Blue, Orange, Green

\* Support for twelve-head printing is available as an option for purchase from ColorSpan.

EPIC is a trademark of Kimberly-Clark Corporation.

### Supported ColorMark Media

<b>Papers</b>	Satin Photobase PXS Paper Glossy Photobase PXG Paper Gloss Photopaper
<b>Films</b>	Endura • Chrome™ Backlit Film White Opaque Film
<b>FineArt™ Media</b>	FineArt UltraColor Canvas FineArt Perma • Chrome™ Paper
<b>Fabric Banner Media</b>	EPIC Cotton Poplin Banner EPIC Polyester Poplin Banner EPIC Polyester Georgette Banner
<b>Outdoor Media</b>	Universal Adhesive Vinyl Universal Photobase Perma • Chrome WaterFast™ Vinyl WaterFast Banner Vinyl Perforated Window Vinyl WaterFast Banner Tyvek FIRST 4-Year Vinyl

Not all supported media are listed. Contact your ColorSpan representative for an updated listing.



---

# Index



3x Mode 2-7  
4 Color Mode 2-8

## A

Access Print Heads 2-5  
Access Service Station 2-5  
AutoJet Calibration 4-2  
AutoSet Calibration 1-18, 2-6, 4-2  
    Quality Check Mode 2-8, 4-5  
AutoSet Summary 2-7  
AutoTune Scheduling 2-6, 4-5, 4-6  
    Quality Check Mode 4-5

## B

Bidirectional Calibration 4-9  
Bidirectional Registration 2-6, 4-2  
Big Ink Packs  
    installing 3-6  
    removing 3-10

## C

Calibrating the printer 4-1  
Calibration 2-6, 4-1  
    AutoJet 4-2  
    AutoSet 1-18, 2-6, 4-2  
    AutoTune 2-6  
    Bidirectional Registration 2-6, 4-2, 4-9  
    color 4-16  
    Expert Options 4-8  
    Head Registration 2-6, 4-11  
    Paper Feed 4-6

    Quality Check Mode 4-5  
    X-Y 4-2  
Change Media 2-5  
Cleaning  
    print heads 3-11  
    service station 3-14  
Color calibration 4-16  
ColorMark Profiler  
    installing 3-6  
Control panel  
    3x Mode 2-7  
    4 Color Mode 2-8  
    Access Print Heads 2-5  
    Access Service Station 2-5  
    AutoSet Summary 2-7  
    Calibrate Printer 2-6  
    Change Media 2-5  
    Customize Settings 2-7  
    Display Humidity 2-9  
    Dryer 2-7  
    Dryer Fan 2-7  
    Ethernet ID 2-9  
    Field Service 2-9  
    Manual Jet Mapping 2-6  
    navigation keys 2-3  
    overview 2-2  
    Prime 2-5  
    Printer Info 2-9  
    printing status 2-4  
    Quality Check Mode 2-8  
    Restore All Defaults 2-8  
    Service Station 2-7  
    Side Gutters 2-7  
    Software Version 2-9  
    Space Between Prints 2-7  
    Takeup Direction 2-7  
    Takeup On/Off 2-4  
    Top Gutters 2-7  
    Total RAM 2-9  
    Units 2-7  
    Vacuum Fan Speed 2-7  
Conventions vii  
Customize Settings 2-7  
Cut-sheet media 1-18, 2-5, B-4  
Cutter 3-23

# D

Diagnostics A-4  
Display Humidity 2-9  
Dryer 2-7, 3-23  
Dryer Fan 2-7  
Drying Fans 2-9

# E

Electrical requirements 1-2  
Embedded software version 2-9  
Environmental requirements 1-2  
Ethernet 2-9  
Ethernet ID 2-9  
Expert Calibration Options 4-8

# F

FCC statement iv  
Field service menu 2-9

# G

Gutter patterns 2-7

# H

Head height adjustment 3-16  
description 1-18  
Head Registration 2-6, 4-11  
Humidity sensor 1-18, 2-9

# I

Ink cartridge  
cleaning 3-11  
handling tips 3-7  
installing 3-7  
Ink dryer 3-23  
Inks  
installing 3-6  
Installation Checklist 1-5

# J

Jet replacement 3-3

# L

Link 2-9  
Load Media Sheet 2-5  
Loading inks 3-6  
Loading media 3-20

# M

Manual Jet Mapping 2-6  
Media  
cutting 3-23  
loading 3-20  
unloading 3-23  
Media dryer 3-23  
Media spool 3-20  
Media width 1-18, 2-5

# N

Network link 2-9

# O

Operating environment 1-2

Ordering supplies B-6

# P

Paper Feed Calibration 4-6

Parts list 1-7

Parts overview 1-15

Prime 2-5

Print heads

accessing 2-5

cleaning 3-11

Print modes 3-2

Profiler

installing 3-6

# Q

Quality Check Mode 2-8, 4-5

# R

Regulatory statements iv

Related manuals vi

Relative humidity sensor 1-18, 2-9

Resetting cartridge vacuum 3-13

Restore All Defaults 2-8

# S

Safety warnings 1-4, 1-6, 1-9, 1-11

Service Station 2-7

Service station

accessing 2-5

cleaning 3-14

Side Gutters 2-7

Software Version 2-9

Space Between Prints 2-7

Specifications B-1

Straight-through media path 1-18, 2-5, B-4

Supplies and accessories B-6

# T

Takeup Direction 2-7

Takeup Motor Status 2-9

Technical Support A-6

Top Gutters 2-7

Total RAM 2-9

Troubleshooting A-1

# U

Units 2-7

Unloading media 3-23

Unpacking and Assembly 1-6

# V

Vacuum

resetting cartridge 3-13

Vacuum Fan Speed 2-7

Variable Mode Printing 3-2



# W

Warnings 1-4, 1-6, 1-9, 1-11

Workflow overview 1-14

# X

X-Y Calibration 4-2



## Free Manuals Download Website

<http://myh66.com>

<http://usermanuals.us>

<http://www.somanuals.com>

<http://www.4manuals.cc>

<http://www.manual-lib.com>

<http://www.404manual.com>

<http://www.luxmanual.com>

<http://aubethermostatmanual.com>

Golf course search by state

<http://golfingnear.com>

Email search by domain

<http://emailbydomain.com>

Auto manuals search

<http://auto.somanuals.com>

TV manuals search

<http://tv.somanuals.com>