

use

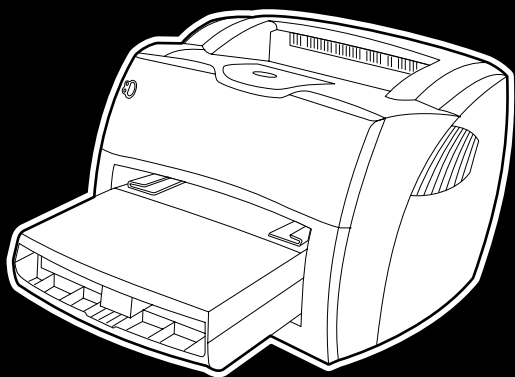

hp LaserJet 1005 series



i n v e n t

HP LaserJet 1005 Series Printer

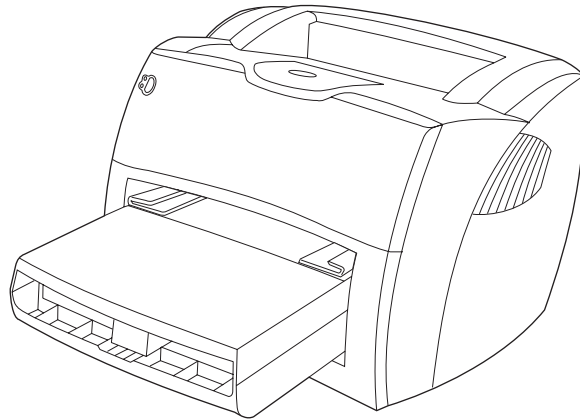

User Guide

© Copyright Hewlett-Packard Company 2003

All Rights Reserved. Reproduction, adaptation, or translation without prior written permission is prohibited, except as allowed under the copyright laws.

A user of the Hewlett-Packard printer associated with this user guide is granted a license to: a) print hard copies of this user guide for PERSONAL, INTERNAL or COMPANY use subject to the restriction not to sell, re-sell or otherwise distribute the hard copies; and b) place an electronic copy of this user guide on a network server, provided access to the electronic copy is limited to PERSONAL, INTERNAL users of the Hewlett-Packard printer associated with this user guide.

Publication number: Q2676-90906
Edition 1, 1/2003

Warranty

The information contained in this document is subject to change without notice.

Hewlett-Packard makes no warranty of any kind with respect to this information. HEWLETT-PACKARD SPECIFICALLY DISCLAIMS THE IMPLIED WARRANTY OF MERCHANTABILITY AND FITNESS FOR A PARTICULAR PURPOSE.

Hewlett-Packard shall not be liable for any direct, indirect, incidental, consequential, or other damage alleged in connection with the furnishing or use of this information.

Trademark Credits

Microsoft®, MS Windows, Windows®, and MS-DOS® are U.S. registered trademarks of Microsoft Corporation.

ENERGY STAR® is a U.S. registered mark of the United States Environmental Protection Agency.

Netscape is a U.S. trademark of Netscape Communications Corporation.

Zenographics is a U.S. trademark of Zenographics, Incorporated.

All other products mentioned herein may be trademarks of their respective companies.

Content

1 Getting started

Review the package contents	8
Prepare the location	8
Regulate the environment	9
Install the printer software	9
Open the print cartridge door	10
Remove the left cover	10
Connect the printer cable	10
Prepare the print cartridge	11
Install the print cartridge	11
Load the paper input tray	12
Connect the power cord	12
Troubleshooting the printer	13
Installation is complete	13

2 Getting to know the printer

Identifying the printer's components	16
Status lights	17
Printer paper input tray	17
Printer media guides	18
Printer output paths	18
Print cartridge door	19
Turning the power off	20
Understanding voltage conversions	20

3 Media

Choosing paper and other media	22
Optimizing print quality for media types	22
Loading media into the paper input tray	23
Specific types of media	23
Printing transparencies and labels	24
Printing envelopes	25
Printing letterhead and preprinted forms	26
Printing custom-sized media and card stock	27

4 Printing tasks

Accessing the printer properties (driver) and help	30
Printer properties (driver)	30
Printer properties online help	30
Printing watermarks	31
Printing multiple pages on a single sheet of media (N-up printing)	31
Canceling a print job	32
Understanding print quality settings	32
Using EconoMode (Save Toner)	32

5 Managing the print cartridge

Using HP print cartridges	34
HP policy on non-HP print cartridges	34
Storing print cartridges	34
Print cartridge life expectancy	34
Recycling print cartridges	34
Saving toner	34
Redistributing toner	35
Changing the print cartridge	36

6 Troubleshooting the printer

Finding the solution	38
Pages did not print	38
Pages printed, but there was a problem	38
Software is installed, but pages did not print.	38
Status light patterns	39
Error messages on the screen	41
Media handling problems	42
Printed page is different than what appeared on screen.	43
Printer software problems	44
Improving print quality	45
Cleaning the printer	48
Cleaning the printer media path	50
Clearing printer media jams.	51
Changing the pickup roller.	53
Cleaning the pickup roller	55
Changing the printer separation pad	56

7 Service and support

Availability	60
Hardware service.	60
Extended warranty.	60
Guidelines for repacking the printer.	60
Service information form	61
Hewlett-Packard Support.	62
European Customer Support Center.	62
Online services	62
Obtaining software utilities and electronic information	63
HP SupportPack	63
Worldwide sales and service offices	64

Appendix A Printer specifications

Specifications	66
FCC compliance	68
Environmental Product Stewardship Program.	69
Protecting the environment	69
Material Safety Data Sheet	70
Regulatory statements.	71
Laser safety statement	71
Declaration of Conformity	71
Laser statement for Finland	72

Appendix B Media specifications

Printer media specifications	74
Supported media sizes (printer)	74
Guidelines for using media	75
Paper	75
Labels	76
Transparencies	76
Envelopes	76
Card stock and heavy media	77

Appendix C Warranty and licensing

Hewlett-Packard software license agreement	80
Hewlett-Packard limited warranty statement	81
Limited warranty for print cartridge life	83

Appendix D Accessories and ordering information

Appendix E Installing shared printers

Index

1 Getting started

This chapter provides the following instructions for installing the software and setting up the printer:

- [Review the package contents](#)
- [Prepare the location](#)
- [Regulate the environment](#)
- [Install the printer software](#)
- [Open the print cartridge door](#)
- [Remove the left cover](#)
- [Connect the printer cable](#)
- [Prepare the print cartridge](#)
- [Install the print cartridge](#)
- [Load the paper input tray](#)
- [Connect the power cord](#)
- [Troubleshooting the printer](#)
- [Installation is complete](#)

Review the package contents

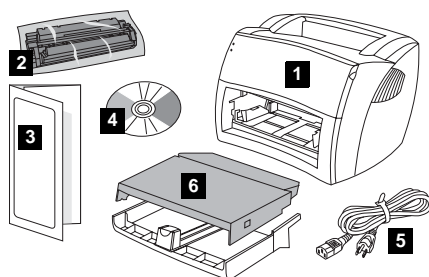

Make sure that all of the parts are included.

- 1 Printer
- 2 Print cartridge (in protective bag)
- 3 Getting Started Guide
- 4 Software and electronic user guide (on one CD-ROM)
- 5 Power cord
- 6 Paper input tray

Prepare the location

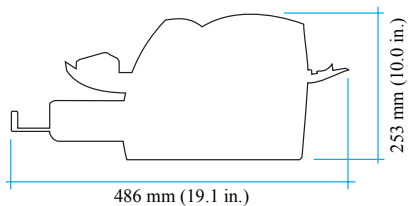

Place the printer on a sturdy, level surface. Allow space for ventilation. Allow space behind the printer for output from the straight-through output door.

Regulate the environment

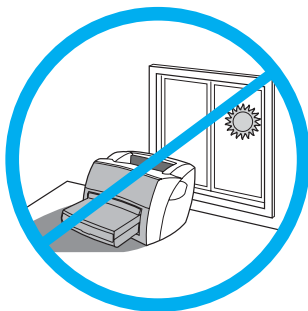

Do not place the printer in direct sunlight. Make sure that the environment is free from abrupt temperature or humidity changes.

- Temperature – 50° to 91° F (10° to 32.5° C)
- Relative humidity – 20% to 80%

Install the printer software

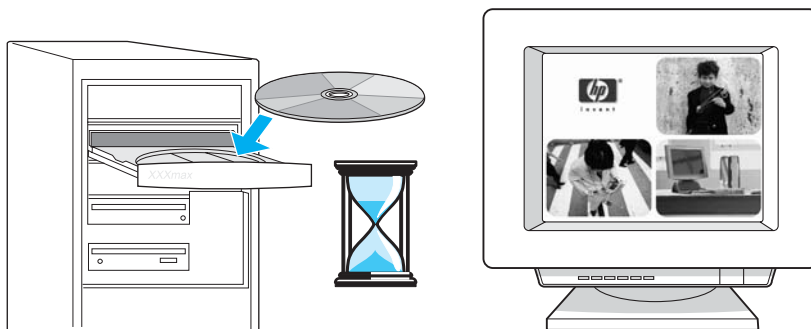

To install the printer software from the CD

- 1 Select **Install** from the autorun screen. If autorun does not occur, in the Windows system tray, click **Start**, click **Run**, type **x:\setup** (where **x** is the letter of the CD-ROM drive), and click **OK**.
- 2 Follow the instructions on the screen.

Open the print cartridge door

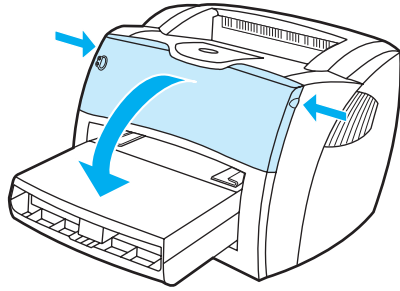

Firmly grasp the left and right sides, and pull the print cartridge door toward you.

Remove the left cover

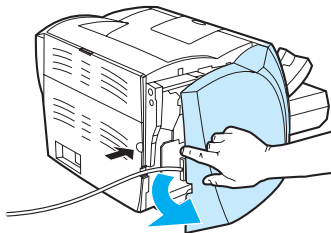

Pull out on the rear of the cover, and rotate it away from the printer.

Connect the printer cable

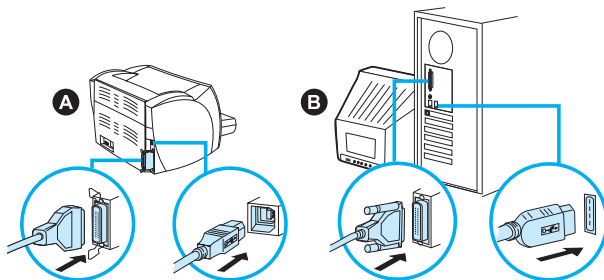

Plug the printer cable into the printer (A). Plug the printer cable into the PC (B).

Prepare the print cartridge

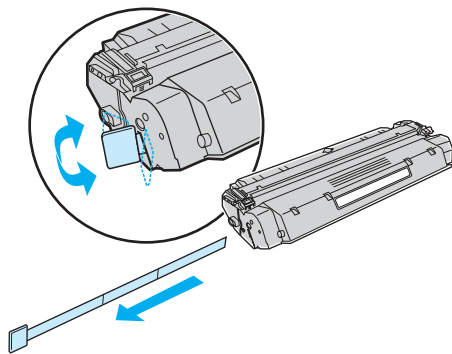

Remove the print cartridge from the plastic bag. To remove the mylar tape, break the tab on the left, and pull the tape completely out.

Install the print cartridge

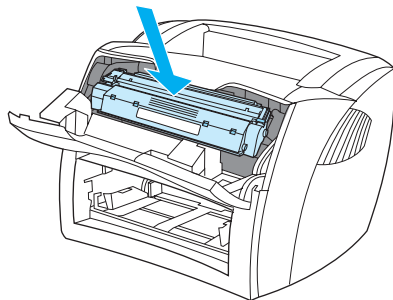

Insert the print cartridge into the printer, making sure that the print cartridge is in position.

Load the paper input tray

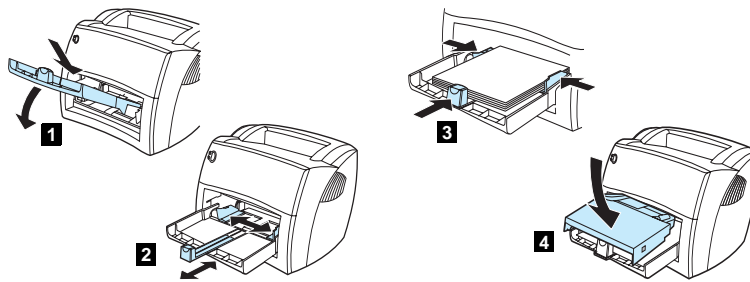

- 1 Slide the paper input tray in and down at an angle until it fits securely in the printer.
- 2 Slide the media guides out and back to accommodate the media.
- 3 Place the media in the paper input tray. Slide the media guides until they are flush with the media.
- 4 Install the paper input tray cover.

Connect the power cord

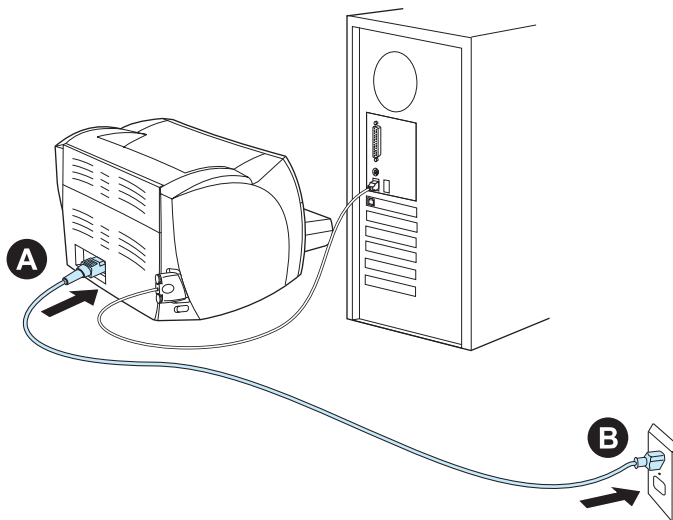

Plug the power cord into the printer (A). Plug the power cord into the power receptacle (B).

Troubleshooting the printer

-
-

If the top status light is on, the printer is ready to print.

-
-

If no status lights are on, check the power cord and the printer cable connections.

CAUTION

Before you connect the cable to the printer, always unplug the printer. Otherwise, the printer might be damaged.

Installation is complete

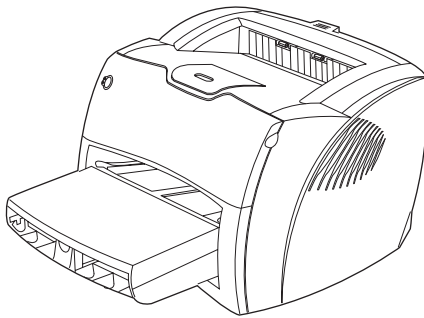

Congratulations! Your HP LaserJet 1005 Series Printer is ready to use. If you had any problems, see [Troubleshooting the printer](#) or go to HP's support Web site at <http://www.hp.com/support/lj1005>.

2 Getting to know the printer

This chapter provides information on the following topics:

- [Identifying the printer's components](#)
- [Turning the power off](#)
- [Understanding voltage conversions](#)

Identifying the printer's components

1. Status lights
2. Paper input tray
3. Long media support for the paper input tray
4. Side media guides for the paper input tray
5. Print cartridge door
6. Output bin
7. Long media extension (output bin)

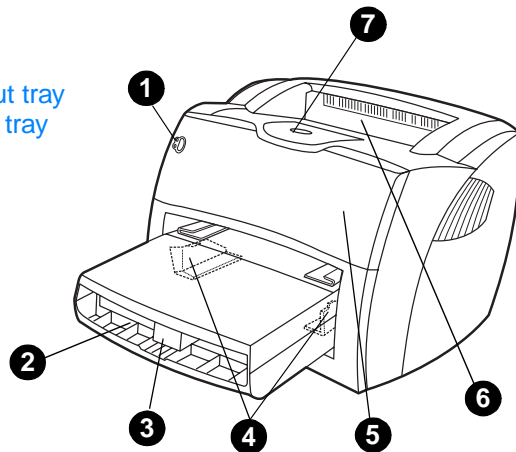

8. Media jam release levers
9. Straight-through output door
10. Power switch
11. Power receptacle
12. USB port
13. Parallel port
14. Left cover

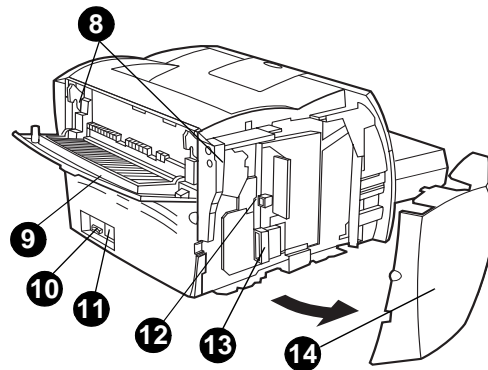

Status lights

The status lights produce patterns that identify the printer's status.

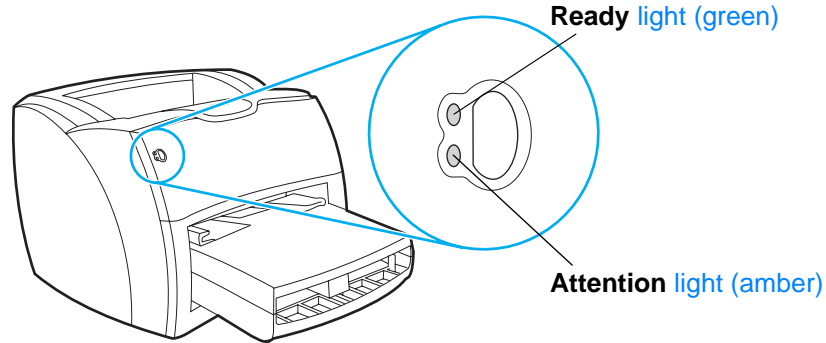

- **Ready light:** Indicates that the printer is ready to print or the printer is processing data.
- **Attention light:** Indicates that the paper input tray is empty, the print cartridge door is open, the print cartridge is missing, or another type of error occurred.

Note

See [Status light patterns](#) for a description of the light patterns.

Printer paper input tray

The enclosed paper input tray, located in front of the printer, holds up to 250 sheets of 20 lb (75 g/m²) paper, multiple envelopes, or other media.

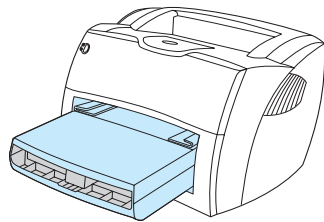

See [Media specifications](#) for more information about media types.

Printer media guides

The paper input tray has a long media support and side media guides. Media guides ensure that the media is correctly fed into the printer and that the print is not skewed (crooked on the media). When loading media, adjust the media guides to match the width and length of the media that you are using.

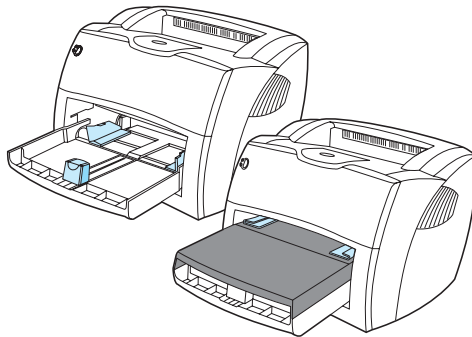

Printer output paths

Output bin

The output bin is located on the top of the printer. Printed media is collected here in the correct sequence when the straight-through output door is closed. Use the output bin when printing normal and large, collated documents.

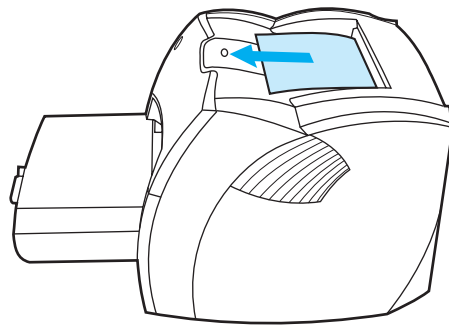

Straight-through output path

The straight-through output path is useful when you are printing envelopes, transparencies, heavy media, or any media that tends to curl when printed. Printed media exits in reverse order when the straight-through output door is open.

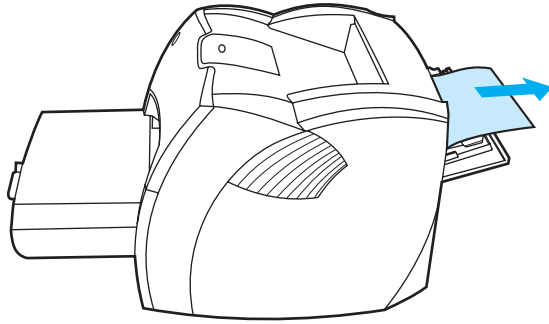

Note

Printed media does not stack when you use the straight-through output path. The media drops to the surface below unless you remove each sheet as it exits the printer.

Print cartridge door

The print cartridge door is located on the front of the printer. You must open the print cartridge door to access the print cartridge, clear jams, and clean the printer. To open the print cartridge door, firmly grasp the left and right sides, and pull the print cartridge door toward you.

Note

You will feel some resistance when you open the print cartridge door. Opening the print cartridge door conveniently lifts the print cartridge for easy removal.

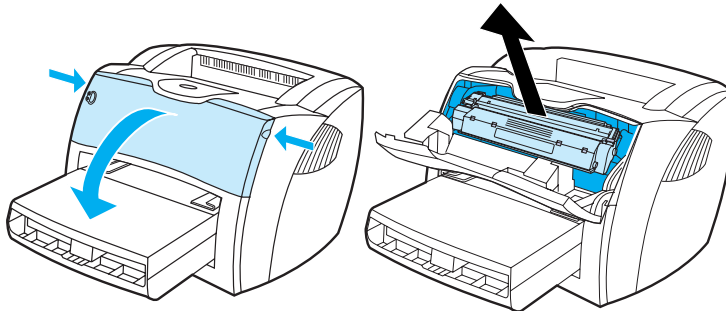

Turning the power off

You must unplug the printer to turn the power off.

WARNING!

To ensure your safety when working inside the printer for any reason, unplug the printer.

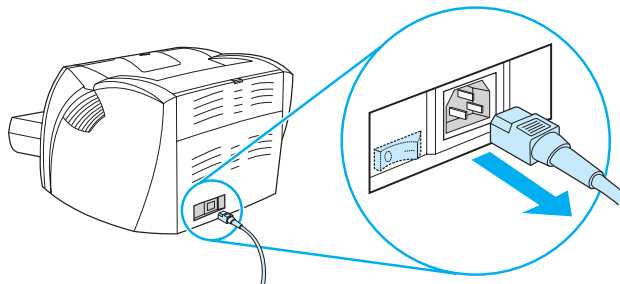

Understanding voltage conversions

Because of the different specifications, Hewlett-Packard does not offer a voltage conversion or support the voltage conversion of the U.S. version of the HP LaserJet family of printers for foreign use. If you plan on using the equipment outside of the United States, Hewlett-Packard advises you to purchase the products in the country/region where you will use them.

CAUTION

Check your printer's voltage requirement before you plug it in. If you plug a printer that requires 110-127 volts of power into a 220-240 voltage outlet, it will damage the printer.

3 Media

This chapter provides information on the following topics:

- [Choosing paper and other media](#)
- [Optimizing print quality for media types](#)
- [Loading media into the paper input tray](#)
- [Printing transparencies and labels](#)
- [Printing envelopes](#)
- [Printing letterhead and preprinted forms](#)
- [Printing custom-sized media and card stock](#)

Choosing paper and other media

HP LaserJet printers produce excellent print quality documents. You can print on a variety of media, such as paper (including up to 100% recycled fiber content paper), envelopes, labels, transparencies, and custom-sized media. The following are the supported media sizes:

- **Minimum:** 76 by 127 mm (3 by 5 in.)
- **Maximum:** 216 by 356 mm (8.5 by 14 in.)

Properties such as weight, grain, and moisture content are important factors that affect printer performance and quality. To achieve the best possible print quality, only use high-quality media designed for laser printers. See [Printer media specifications](#) for detailed paper and media specifications.

Note

Always test a sample of the media before you purchase large quantities. The media supplier should understand the requirements specified in the *Guidelines for Paper and Other Print Media* (HP part number 5963-7863). See [Printer media specifications](#) for more information.

Optimizing print quality for media types

The temperature of the printer's engine fuser affects the quality of your printed documents. Different types of media require different engine fuser temperatures to optimize the print quality. You can specify the type of media that you are using to print in the printer driver. This changes the engine fuser to the temperature that is appropriate for that media.

To change the media type in the printer driver

- 1 Access the printer properties. See [Printer properties \(driver\)](#) for instructions.
- 2 Click the **Paper** tab.
- 3 Select the media type from the **Optimize for** drop-down list.
- 4 Click **OK**.

Note

Printing speeds are automatically reduced when printing special-sized media.

Loading media into the paper input tray

The paper input tray holds up to 250 pages of 20 lb (75 g/m²) paper or fewer pages of heavier media (25 mm or less stack). Load media with the top forward and the side to be printed facing up. To prevent jams and skewing, always adjust the side media guides and long media support.

CAUTION

If you try to print on media that is wrinkled, folded, or damaged in any way, a jam might occur. See [Printer media specifications](#) for more information.

Note

When you add new media, make sure that you remove all of the media from the paper input tray and straighten the stack of new media. This helps prevent multiple sheets of media from feeding through the printer at one time, reducing media jams.

Specific types of media

- **Transparencies and labels:** Load transparencies and labels with the top forward and the side to be printed facing up. See [Printing transparencies and labels](#) for more information.
- **Envelopes:** Load envelopes with the narrow, stamp side forward and the side to be printed facing up. See [Printing envelopes](#) for more information.
- **Letterhead and preprinted forms:** Load letterhead and preprinted forms with the top forward and the side to be printed facing up. See [Printing letterhead and preprinted forms](#) for more information.
- **Custom-sized media and card stock:** Load custom-sized media and card stock with the narrow side forward and the side to be printed facing up. See [Printing custom-sized media and card stock](#) for more information.

Printing transparencies and labels

Only use transparencies and labels that are recommended for laser printers, such as HP transparency film and HP LaserJet labels. See [Printer media specifications](#) for more information.

CAUTION

Inspect the media to make sure that it is not wrinkled or curled and that it does not have any torn edges or missing labels.

CAUTION

Do not use labels that have exposed backing. Labels can peel off of sheets that have spaces between the labels, causing serious jams.

To print transparencies or labels

- 1 Open the straight-through output door.
- 2 Load the media in the paper input tray. Make sure that the top of the media is forward and the side to be printed (rough side) is facing up.
- 3 Adjust the media guides.
- 4 Access the printer properties. See [Printer properties \(driver\)](#) for instructions. Click the **Paper** tab, select **Transparency** or **Labels** from the **Optimize for** drop-down list, and click **OK**.
- 5 Print the document. To prevent the media from sticking together, remove the media from the back of the printer as it prints, and place the printed pages on a flat surface.

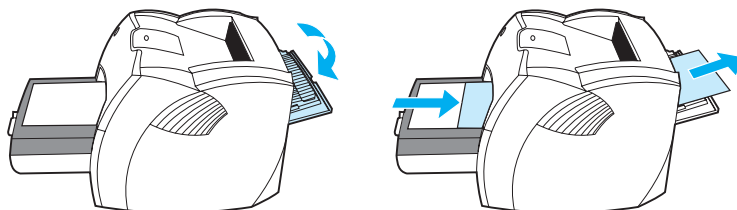

Printing envelopes

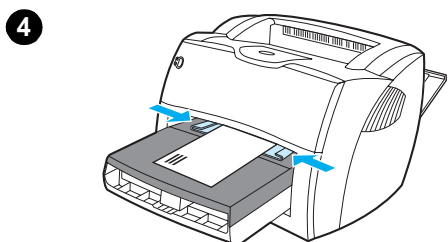
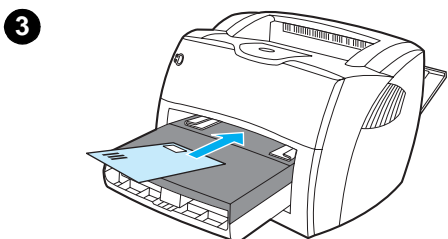
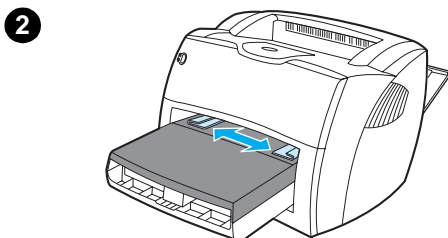
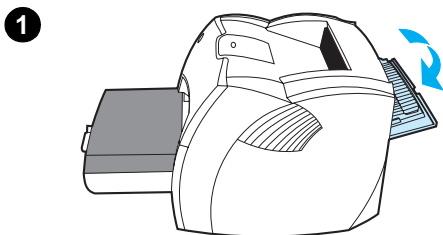

Only use envelopes that are recommended for laser printers. See [Printer media specifications](#) for more information.

- 1 To prevent the envelopes from curling as they print, open the straight-through output door.
- 2 Before loading the envelopes, slide the media guides outward so that they are slightly wider than the envelopes.
- 3 Place the envelopes with the stamp end forward and the side to be printed facing up.

Note

If the envelopes have a flap on the short edge, feed that edge into the printer first.

- 4 Adjust the media guides to the length and width of the envelopes. Access the printer properties. See [Printer properties \(driver\)](#) for instructions. Click the **Paper** tab, select **Envelope** from the **Optimize for** drop-down list, and click **OK**.

Printing letterhead and preprinted forms

To print letterhead or preprinted forms

- 1 Load the media with the top forward and the side to be printed facing up. Adjust the media guides to fit the width of the media.
- 2 Access the printer properties. See [Printer properties \(driver\)](#) for instructions. Click the **Paper** tab, select the appropriate media from the **Optimize for** drop-down list, and click **OK**.
- 3 Print the document.

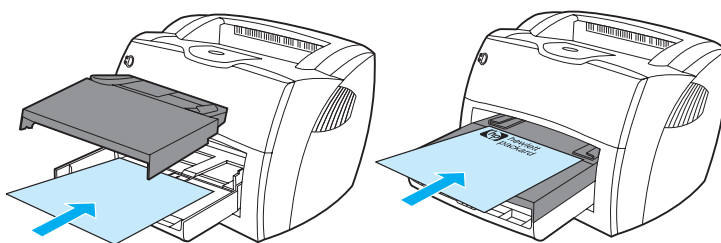

Note

To print a single-page cover letter on letterhead followed by a multiple-page document, load the standard media in the paper input tray. Place a sheet of letterhead on top of the standard media. The printer automatically prints the letterhead first.

Printing custom-sized media and card stock

The HP LaserJet 1005 Series Printer can print on custom-sized media or card stock between 76 by 127 mm (3 by 5 in.) and 216 by 356 mm (8.5 by 14 in.).

CAUTION

Make sure that the media is not stuck together before you load it.

To print on custom-sized media or card stock

- 1 Open the straight-through output door.
- 2 Load the media with the narrow side forward and the side to be printed facing up. Adjust the media guides to fit the media.
- 3 Select the correct media size in the printer settings. (Software settings can override printer properties.)
- 4 Access the printer properties. See [Printer properties \(driver\)](#) for instructions. Click the **Paper** tab, select the appropriate media from the **Optimize for** drop-down list, and click **OK**.
- 5 Print the document.

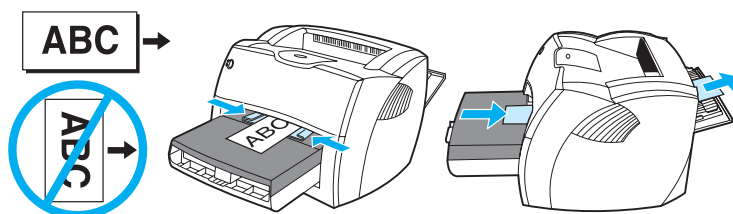

4 Printing tasks

This chapter provides information on the following topics:

- [Accessing the printer properties \(driver\) and help](#)
- [Printing watermarks](#)
- [Printing multiple pages on a single sheet of media \(N-up printing\)](#)
- [Canceling a print job](#)
- [Understanding print quality settings](#)
- [Using EconoMode \(Save Toner\)](#)

Accessing the printer properties (driver) and help

This section provides information on the following topics:

- [Printer properties \(driver\)](#)
- [Printer properties online help](#)

Printer properties (driver)

Printer properties control the printer. You can change the default settings, such as media size and type, printing multiple pages on a single sheet of media (N-up printing), resolution, and watermarks. You can access the printer properties in the following ways:

- Through the software application that you are using to print. This only changes the settings for the current software application.
- Through the Windows® operating system. This changes the default settings for all future print jobs.

Note

Because many software applications use a different method of accessing the printer properties, the following section describes the most common methods used in Windows 9x, 2000, Millennium, NT 4.0, and Windows XP.

Windows 9x, 2000, Millennium, and NT 4.0

- **Change the settings only for the current software application:** From within the software application, on the **File** menu, click **Print**, and click **Properties**. (Although the steps can vary between software applications, this is the most common method.)
- **Change the default settings for all future print jobs:** In the Windows system tray, click **Start**, select **Settings**, and click **Printers**. Right-click the printer icon that you want to change, and click **Properties**. (Many of the features in Windows NT 4.0 are also in the **Document Defaults** menu.)

Windows XP

To change the default settings for all future print jobs, perform the following steps:

- 1 In the Windows system tray, click **Start**, and click **Control Panel**.
- 2 Double-click **Printers and Other Hardware**.
- 3 Click **Printers and Faxes**.
- 4 Right-click the HP LaserJet 1005 Series Printer icon.
- 5 Click **Properties**.
- 6 Change the settings, and click **OK**.

Printer properties online help

The printer properties (driver) online help includes specific information about the functions in the printer properties. This online help guides you through the process of changing your printer's default settings.

To access the printer properties help system, open the printer driver, click the **Printer Properties** tab, and click **Help**.

Printing watermarks

You can use the watermark option to print text “underneath” (in the background) the text of an existing document. For example, you might want to have *Draft* or *Confidential* printed in large gray letters diagonally across the first page or all of the pages of a document.

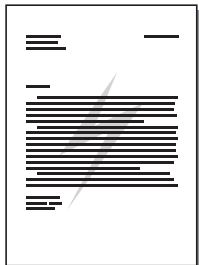

To access the watermark feature

- 1 From the software application, access the printer properties. See [Printer properties \(driver\)](#) for instructions.
- 2 Click the **Effects** tab, and specify the type of watermark that you want to print on your document.
- 3 Click **OK**.

Printing multiple pages on a single sheet of media (N-up printing)

You can select the number of pages that you want to print on a single sheet of media. If you choose to print more than one page per sheet, the pages appear smaller and are arranged on the sheet in the order that they would otherwise be printed. You can specify up to 9 pages per sheet of media.

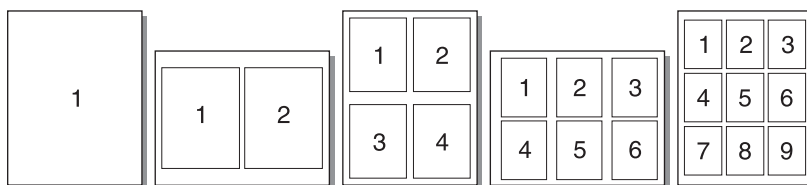

To access the multiple pages per sheet feature

- 1 From the software application, access the printer properties. See [Printer properties \(driver\)](#) for instructions.
- 2 Click the **Finishing** tab.
- 3 Type the number of pages per sheet in the **Pages per Sheet** box.
- 4 To print borders around each page, select **Print Page Borders**.
- 5 To specify the order that you want the pages printed on the page, select the appropriate option from the **Page Order** drop-down list.
- 6 Click **OK**.

Canceling a print job

You can cancel a print job from a software application or a print queue.

To stop the printer immediately, remove the remaining media from the printer. After the printer stops, use one of the following options:

- **Software application:** Typically, a dialog box appears briefly on your screen, allowing you to cancel the print job.
- **Windows print queue:** If a print job is waiting in a print queue (computer memory) or print spooler, you can delete the job from the **Printer** screen.

If the status lights continue to blink after you cancel a print job, the computer is still sending the job to the printer. Either delete the job from the print queue or wait until the computer finishes sending data. The printer will return to the Ready state.

Understanding print quality settings

Print quality settings affect how light or dark the print is on the page and the style that the graphics are printed. You can also use the print quality settings to optimize the print quality for a specific media type. See [Optimizing print quality for media types](#) for more information.

You can change the settings in the printer properties to accommodate the types of jobs you are printing. The following are the print quality options:

- **Best Quality:** This option prints at 600 dpi and provides the best print quality. This is the default setting.
- **300 dpi:** This option prints at a slightly reduced resolution so that the job can print faster.
- **Custom:** You can use this option to specify your own custom print quality settings.
- **EconoMode (Save Toner):** This option prints using less toner. This option is useful when you are printing drafts.

To change the print quality settings

- 1 Access the printer properties. See [Printer properties \(driver\)](#) for instructions.
- 2 Click the **Finishing** tab.
- 3 Select the **Print Quality** option.
- 4 To view and change the output and graphic settings for the option that you selected, click **Details**.

Using EconoMode (Save Toner)

EconoMode is an excellent way to extend the life of your print cartridge. EconoMode uses substantially less toner than normal printing. The printed image is much lighter, but it is adequate for printing drafts or proofs.

To enable EconoMode, access the printer properties. See [Printer properties \(driver\)](#) for instructions. Click the **Finishing** tab, select **EconoMode (Save Toner)**, and click **OK**.

5 Managing the print cartridge

This chapter provides information on the following topics:

- [Using HP print cartridges](#)
- [Storing print cartridges](#)
- [Print cartridge life expectancy](#)
- [Recycling print cartridges](#)
- [Saving toner](#)
- [Redistributing toner](#)
- [Changing the print cartridge](#)

Using HP print cartridges

HP policy on non-HP print cartridges

Hewlett-Packard Company cannot recommend the use of non-HP print cartridges, either new, refilled, or remanufactured. Since they are not HP products, Hewlett-Packard cannot influence their design or control their quality. Service or repair that is required as a result of using non-HP print cartridges will not be covered under the printer warranty.

Note

The warranty does not apply to defects resulting from software, interfacing, or parts not supplied by Hewlett-Packard.

Storing print cartridges

Do not remove the print cartridge from its package until you are ready to use it. The shelf life of a print cartridge in an unopened package is approximately 2.5 years. The shelf life of a print cartridge in an opened package is approximately 6 months.

CAUTION

To prevent damage to the print cartridge, do not expose it to light.

Print cartridge life expectancy

The life of the print cartridge depends on the amount of toner that your print jobs require. When printing text at 5% coverage, the standard print cartridge (C7115A) lasts an average of 2,500 pages. This assumes that you set the print density to 3 and disable EconoMode. (These are the default settings.)

Recycling print cartridges

To reduce landfill waste, Hewlett-Packard has adopted a recycling program for empty print cartridges. A postage-paid shipping label is inside the new HP LaserJet print cartridge box. Since 1990, the HP Printing Supplies Environmental Program has collected more than 48 million used HP LaserJet print cartridges that otherwise might have been discarded in the world's landfills. To join this recycling effort, follow the instructions provided in the new print cartridge box.

To install a new HP print cartridge, see [Changing the print cartridge](#) or follow the instructions included in the print cartridge box. See the recycling information on the print cartridge box and the [HP Printing Supplies Environmental Program](#) included in the print cartridge box.

Saving toner

While in EconoMode, the printer uses less toner on each page. Selecting this option will extend the life of the print cartridge and reduce your cost per page, but it will reduce print quality. See [Using EconoMode \(Save Toner\)](#) for more information.

Redistributing toner

1

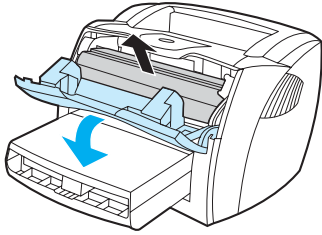

2

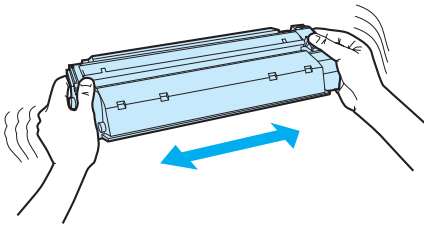

3

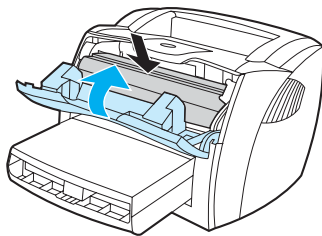

When toner is low, faded or light areas appear on the printed page. You might be able to temporarily improve print quality by redistributing the toner, which means that you might be able to finish the current print job before replacing the print cartridge.

Note

You will feel some resistance when you open the print cartridge door. Opening the print cartridge door conveniently lifts the print cartridge for removal.

-
- 1 Open the print cartridge door, and remove the print cartridge from the printer.

CAUTION

To prevent damage, do not expose the print cartridge to light. Cover it with a sheet of media.

-
- 2 To redistribute the toner, gently shake the print cartridge from side to side.

CAUTION

If toner gets on your clothing, wipe the toner off with a dry cloth, and wash the clothing in cold water. *Hot water will permanently set the toner into the fabric.*

-
- 3 Reinsert the print cartridge into the printer, and close the print cartridge door.

If the print is still light, install a new print cartridge. See [Changing the print cartridge](#) for instructions.

Changing the print cartridge

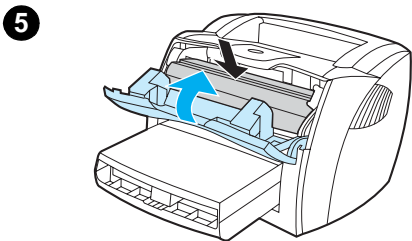
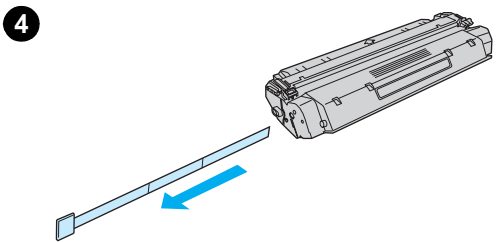
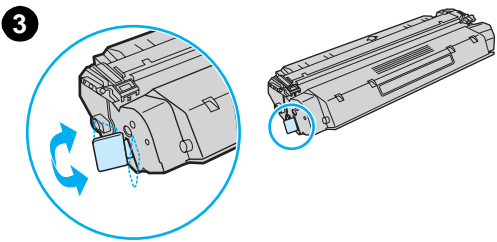
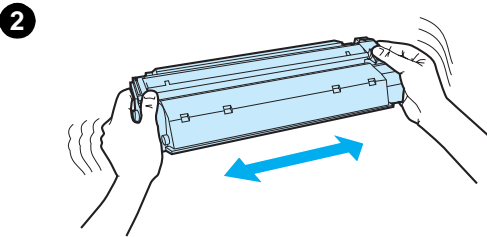
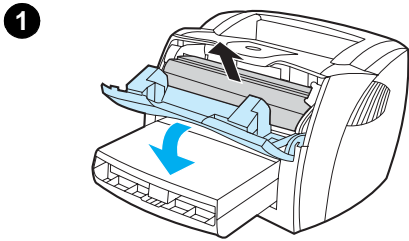

Note

You will feel some resistance when you open the print cartridge door. Opening the print cartridge door conveniently lifts the print cartridge for removal.

- 1 Open the print cartridge door, and remove the old print cartridge. See [Recycling print cartridges](#) or the recycling information inside the print cartridge box.
-

CAUTION

To prevent damage, do not expose the print cartridge to light. Cover it with a piece of media.

- 2 Remove the new print cartridge from the packaging, and gently shake it from side to side to distribute the toner evenly inside the cartridge.
 - 3 Bend the tab on the left side of the cartridge to break it loose.
 - 4 Pull the tab until all of the tape is removed from the cartridge. Put the tab in the print cartridge box to return for recycling.
 - 5 Insert the print cartridge in the printer, making sure that the print cartridge is in position. Close the print cartridge door.
-

CAUTION

If toner gets on your clothing, wipe the toner off with a dry cloth, and wash the clothing in cold water. *Hot water will permanently set the toner into the fabric.*

6 Troubleshooting the printer

This chapter provides information on the following topics:

- [Finding the solution](#)
- [Improving print quality](#)
- [Cleaning the printer](#)
- [Clearing printer media jams](#)
- [Changing the pickup roller](#)
- [Cleaning the pickup roller](#)
- [Changing the printer separation pad](#)

Note

See Hewlett-Packard's Web site for software and printer driver updates, frequently asked questions, and additional troubleshooting information. See [Online services](#) for the appropriate Web address.

Finding the solution

You can use this section to find the solution to common printer problems.

Pages did not print

- **Status light patterns:** What status light pattern is displayed on the printer? See [Status light patterns](#) for more information.
- **Error messages on screen:** Is there a message on the screen? See [Error messages on the screen](#) for more information.
- **Media handling:** Is media being pulled into the printer incorrectly? Are there media jams? See [Media handling problems](#) for more information.

Pages printed, but there was a problem



- **The print quality was poor:** See [Improving print quality](#) for more information.
- **The printed pages do not always appear the same as on the screen (print preview):** See [Printed page is different than what appeared on screen](#) for more information.
- **The printer settings were inappropriate for the media:** See [Media handling problems](#) for more information.

Software is installed, but pages did not print

Is the printer driver icon available? Is the printer in Ready mode? Can you select the printer in the **Print** dialog? See [Printer software problems](#) for more information.







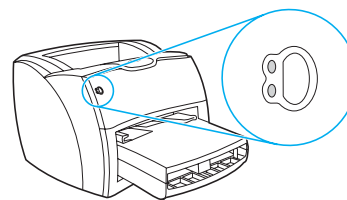

Status light patterns

Status light legend



-  Symbol for "light off"
-  Symbol for "light on"
-  Symbol for "light blinking"



Status light patterns

Status lights	Condition of the printer	Action
 	Ready The printer is ready to print.	No action is necessary.
 	Processing The printer is receiving or processing data.	Wait for the job to print.
	Cleaning Mode/Engine test A cleaning page or engine test page is printing.	<ul style="list-style-type: none"> ● Wait until the cleaning page is finished printing and the printer is in Ready mode. This could take up to 2 minutes. ● Wait until the engine test page is finished printing and the printer is in Ready mode.
 	Out of memory The printer is out of memory.	The page you are printing might be too complex for the printer's memory capacity. Try lowering the resolution. See Understanding print quality settings for more information.
 	Door open, media out, no print cartridge, media jam, or media jam levers are down The printer is in an error state that requires operator intervention or help.	Check the following: <ul style="list-style-type: none"> ● The print cartridge door is completely closed. ● Media is loaded. See Loading media into the paper input tray for instructions. ● The print cartridge is correctly installed in the printer. See Changing the print cartridge for instructions. ● There is no media jam. See Clearing printer media jams for instructions. ● The media jam levers are in the upright position.

Status light patterns (continued)

Status lights	Condition of the printer	Action
	Printer initialization A printer initialization is taking place.	No action is necessary.
	Fatal error Both lights are on.	<ul style="list-style-type: none">● Unplug the printer for 5 minutes, and then plug it back in.● If the printer still has an error, contact HP Support. See Service and support.
	Printer cable is not connected or there is no power Both lights are off.	<ul style="list-style-type: none">● Make sure that there is power.● Unplug both ends of the power cord, and plug them back in.● Unplug the power cord, disconnect both ends of the printer cable, reconnect both ends of the printer cable, and plug the power cord back in. <p>CAUTION Before you connect the cable to the printer, always unplug the printer. Otherwise, the printer might be damaged.</p>

Error messages on the screen

Error messages on the screen

Error message	Solution
Printer not responding	<p>Check the following:</p> <ul style="list-style-type: none">● The Ready light is on.● The power cord and printer cable are correctly connected. <p>CAUTION Before you connect the cable to the printer, always unplug the printer. Otherwise, the printer might be damaged.</p>
Cannot access port (in use by another application)	<p>Try the following:</p> <ul style="list-style-type: none">● Reboot the computer.● Make sure that you are only running one software application at a time.
Illegal operation/General protection fault/Spool 32 error	<p>A problem with your computer system resources (memory or hard disk) occurred in Windows. To clear this error, restart the computer.</p> <p>To help prevent this error from occurring in the future, use some or all of the following recommendations:</p> <ul style="list-style-type: none">● Run fewer applications at the same time. Close applications that you are not using instead of minimizing them. Programs such as screen savers, virus checkers, status software, fax/answering software, and menu programs use the resources that the computer might need to print.● Avoid memory-intensive tasks such as sending a fax or running a video clip while printing.● Delete all temp (file_name.tmp) files from the Temp subdirectories, such as C:\Windows\Temp.● Print at a lower resolution.

Media handling problems

Media handling problems

Problem	Solution
Media jam	<ul style="list-style-type: none">● See Clearing printer media jams for more information.● Make sure that you are printing with media that meets specifications. See Printer media specifications for more information.● Make sure that you are printing with media that is not wrinkled, folded, or damaged.● Make sure that the printer is clean. See Cleaning the printer media path for more information.● If you are printing to the straight-through output path, close and open the door again to make sure that the media jam release levers are closed.
Print is skewed (crooked)	<ul style="list-style-type: none">● See Page skew for more information.● Adjust the media guides to the width and length of the media that you are using and try reprinting. See Printer media guides or Loading media into the paper input tray for more information.
More than one sheet of media feeds through the printer at one time	<ul style="list-style-type: none">● The paper input tray might be too full. See Loading media into the paper input tray for more information.● Make sure that the media is not wrinkled, folded, or damaged.● The printer separation pad might be worn. See Changing the printer separation pad for more information.
Printer does not pull media from the paper input tray	The pickup roller might be dirty or damaged. See Cleaning the pickup roller or Changing the pickup roller for instructions.
Printer curled the media	<ul style="list-style-type: none">● See Curl or wave for more information.● Open the straight-through output door to print straight through. See Printer output paths or Media for more information.
The printed media does not exit to the correct path	Open or close the straight-through output door to reflect the output path that you want to use. See Printer output paths for more information.
Print job is extremely slow	<p>The maximum speed of the printer is 14 pages per minute. The print job might be very complex. Try the following:</p> <ul style="list-style-type: none">● Reduce the complexity of the document (for example, reduce the number of multiple graphics).● Access the printer properties in the printer driver. See Printer properties (driver) for instructions. Click the Paper tab, select Plain Paper from the Optimize for drop-down list, and click OK. <p>Note This may cause toner to fuse improperly if you are using heavy media.</p> <ul style="list-style-type: none">● Narrow media or heavy media will slow printing. Use normal media.● Print speed is based on the PC processor speed, the amount of memory, and the amount of hard disk space available on the PC. Try increasing these components.

Printed page is different than what appeared on screen

Printed page problems

Problem	Solution
Garbled, incorrect, or incomplete text	<p>The printer cable might be loose or defective. Try the following:</p> <ul style="list-style-type: none">● Try printing a job that you know works.● If possible, attach the printer cable and printer to another computer, and try printing a job that you know works.● Unplug the power cord, disconnect the printer cable at both ends, reconnect the printer cable at both ends, and plug the power cord back in. <p>CAUTION Before you connect the cable to the printer, always unplug the printer. Otherwise, the printer might be damaged.</p> <p>The wrong printer driver might have been selected when the software was installed. Make sure that HP LaserJet 1005 Series Printer is selected in the printer properties.</p> <p>There might be a problem with the software application. Try printing from another software application.</p>
Missing graphics or text, or blank pages	<ul style="list-style-type: none">● Make sure that the file does not contain blank pages.● The sealing tape might still be in the print cartridge. Remove the print cartridge, and pull out the sealing tape. Reinstall the print cartridge. See Changing the print cartridge for instructions.● The graphic settings in the printer properties might not be correct for the type of job that you are printing. Try a different graphic setting in the printer properties. See Printer properties (driver) for more information.
Page format is different than on another printer	<p>If you used an older or different printer driver (printer software) to create the document or the printer properties settings in the software are different, the page format might change when you try to print using the new printer driver or settings. To help eliminate this problem, change the resolution, media size, font settings, and other settings. See Printer properties (driver) for more information.</p>
Graphics quality	<p>The graphic settings might be unsuitable for the print job. Check the graphic settings, such as resolution, in the printer properties and adjust them as necessary. See Printer properties (driver) for more information.</p>

Printer software problems

Printer software problems

Problem	Solution
A printer driver for the HP LaserJet 1005 Series Printer is not visible in the Printer folder.	<ul style="list-style-type: none">● Reinstall the printer software. In the Windows system tray, click Start, select Programs, select HP LaserJet 1005 Series Printer, and click Uninstall. Unplug the power cord from the printer. Install the printer software from the CD-ROM. Plug the power cord back into the printer. Note Close any applications that are running. To close an application that has an icon in the system tray, right-click the icon, and select Close or Disable.● Try plugging the printer cable into a different port on the PC.● If you are trying to print to a shared printer, in the Windows system tray, click Start, select Settings, and click Printers. Double-click the Add Printer icon. Follow the instructions in the Add Printer Wizard. See Installing shared printers for more information.
An error message was displayed during the software installation	<ul style="list-style-type: none">● Reinstall the printer software. In the Windows system tray, click Start, select Programs, select HP LaserJet 1005 Series Printer, and click Uninstall. Unplug the power cord from the printer. Install the printer software from the CD-ROM. Plug the power cord back into the printer. Note Close any applications that are running. To close an application that has an icon in the system tray, right-click the icon, and select Close or Disable.● Check the amount of free space on the drive where you are installing the printer software. If necessary, free up as much space as you can, and reinstall the printer software.● If necessary, run the Disk Defragmenter, and reinstall the printer software.
The printer is in Ready mode, but nothing prints	<ul style="list-style-type: none">● Reinstall the printer software. In the Windows system tray, click Start, select Programs, select HP LaserJet 1005 Series Printer, and click Uninstall. Unplug the power cord from the printer. Install the printer software from the CD-ROM. Plug the power cord back into the printer. Note Close any applications that are running. To close an application that has an icon in the system tray, right-click the icon, and select Close or Disable.● Print an engine test page.

Improving print quality

This section provides information about identifying and correcting print defects.

Light print or fade

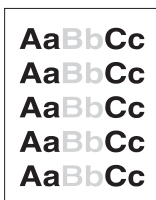

- The toner supply is low. See [Managing the print cartridge](#) for more information.
- The media might not meet Hewlett-Packard's media specifications (for example, the media is too moist or too rough). See [Printer media specifications](#) for more information.
- If the whole page is light, the print density adjustment is too light or EconoMode might be turned on. Access the printer properties. See [Printer properties \(driver\)](#) for instructions. Click the **Configure** tab, and adjust the **Print Density** setting. Click the **Finishing** tab, and clear the **EconoMode (Save Toner)** check box. See [Saving toner](#) for more information.

Toner specks



- The media might not meet Hewlett-Packard's media specifications (for example, the media is too moist or too rough). See [Printer media specifications](#) for more information.
- The printer might need to be cleaned. See [Cleaning the printer](#) or [Cleaning the printer media path](#) for instructions.

Dropouts



- A single sheet of media might be defective. Try reprinting the job.
- The media's moisture content is uneven or the media has moist spots on the surface. Try printing with new media. See [Printer media specifications](#) for more information.
- The media lot is bad. The manufacturing processes can cause some areas to reject toner. Try a different type or brand of media.
- The print cartridge might be defective. See [Managing the print cartridge](#) for more information.

Vertical lines

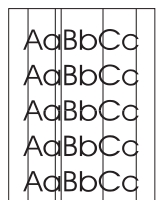

- Make sure that the paper input tray cover is in place.
- The photosensitive drum inside the print cartridge has probably been scratched. Install a new HP print cartridge. See [Changing the print cartridge](#) for instructions.

Gray background



- Make sure that the paper input tray cover is in place.
- Access the printer properties. See [Printer properties \(driver\)](#) for instructions. Click the **Configure** tab, and decrease the **Print Density** setting. This decreases the amount of background shading.
- Change the media to a lighter basis weight. See [Printer media specifications](#) for more information.
- Check the printer's environment. Very dry (low humidity) conditions can increase the amount of background shading.
- Install a new HP print cartridge. See [Changing the print cartridge](#) for instructions.



Toner smear

- If toner smears appear on the leading edge of the media, the media guides might be dirty. Wipe the media guides with a dry, lint-free cloth. See [Identifying the printer's components](#) or [Cleaning the printer](#) for more information.
- Check the media type and quality.
- Try installing a new HP print cartridge. See [Changing the print cartridge](#) for instructions.
- The fuser temperature might be too low. Access the printer properties. See [Printer properties \(driver\)](#) for instructions. Click the **Paper** tab, and make sure that you have selected the appropriate media from the **Optimize for** drop-down list.

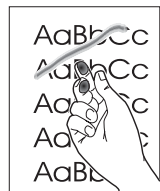

Loose toner

- Clean the inside of the printer. See [Cleaning the printer](#) for instructions.
- Check the media type and quality. See [Printer media specifications](#) for more information.
- Try installing a new HP print cartridge. See [Changing the print cartridge](#) for instructions.
- Access the printer properties. See [Printer properties \(driver\)](#) for instructions. Click the **Paper** tab, and make sure that you have selected the appropriate media from the **Optimize for** drop-down list.
- Plug the printer directly into an AC outlet instead of into a power strip.



Vertical repetitive defects

- The print cartridge might be damaged. If a repetitive mark occurs at the same spot on the page, install a new HP print cartridge. See [Changing the print cartridge](#) for instructions.
- The internal parts might have toner on them. See [Cleaning the printer](#) for more information. If the defects occur on the back of the page, the problem will probably correct itself after a few more printed pages.
- Access the printer properties. See [Printer properties \(driver\)](#) for instructions. Click the **Paper** tab, and make sure that you have selected the appropriate media from the **Optimize for** drop-down list.

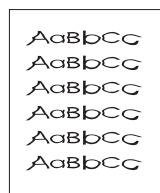

Improperly formed characters

- If characters are improperly formed, producing hollow images, the media stock might be too slick. Try a different media. See [Printer media specifications](#) for more information.
- If characters are improperly formed, producing a wavy effect, the printer might need service. Print the Windows test page. If the characters are improperly formed, contact an HP-authorized dealer or service representative. See [Service and support](#) for more information.



Page skew

- Make sure that the media is loaded correctly and the media guides are not too tight or too loose against the media stack. See [Loading media into the paper input tray](#) for more information.
- The paper input tray might be too full. See [Loading media into the paper input tray](#) for more information.
- Check the media type and quality. See [Printer media specifications](#) for more information.

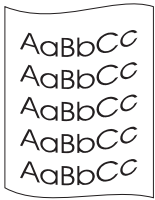

Curl or wave

- Check the media type and quality. Both high temperature and humidity cause media to curl. See [Printer media specifications](#) for more information.
- The media might have been in the paper input tray too long. Turn over the stack of media in the tray. Also, try rotating the media 180° in the paper input tray.
- Open the straight-through output door, and try printing straight through. See [Printer output paths](#) for more information.
- The fuser temperature might be too high. Access the printer properties. See [Printer properties \(driver\)](#) for instructions. Click the **Paper** tab, and make sure that you have selected the appropriate media from the **Optimize for** drop-down list.



Wrinkles or creases

- Make sure that the media is loaded properly. See [Loading media into the paper input tray](#) for more information.
- Check the media type and quality. See [Printer media specifications](#) for more information.
- Open the straight-through output door, and try printing straight through. See [Printer output paths](#) for more information.
- Turn over the stack of media in the tray. Also, try rotating the media 180° in the paper input tray.

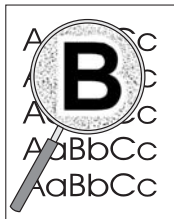

Toner scatter outline

- Access the printer properties. See [Printer properties \(driver\)](#) for instructions. Click the **Configure** tab, and select **On** in **Transfer Setting**.
- If large amounts of toner have scattered around the characters, the media might be resisting the toner. (A small amount of toner scatter is normal for laser printing.) Try a different media type. See [Printer media specifications](#) for more information.
- Turn over the stack of media in the tray.
- Use media designed for laser printers. See [Printer media specifications](#) for more information.

Cleaning the printer

During the printing process, media, toner, and dust particles can accumulate inside the printer. Over time, this buildup can cause print quality problems, such as toner specks or smearing. To correct and prevent these types of problems, you can clean the print cartridge area and the printer media path. See the following sections for more information:

- [Cleaning the print cartridge area](#)
- [Cleaning the printer media path](#)

Cleaning the print cartridge area

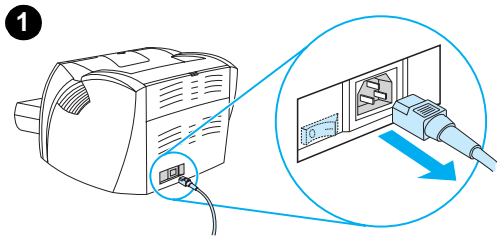

You do not need to clean the print cartridge area often. However, cleaning this area can improve the quality of your printed sheets.

- 1 Unplug the power cord, and wait for the printer to cool.
- 2 Open the print cartridge door, and remove the print cartridge.

CAUTION

To prevent damage, do not expose the print cartridge to light. Cover the print cartridge if necessary. Also, do not touch the black sponge transfer roller inside the printer. By doing so, you can damage the printer.

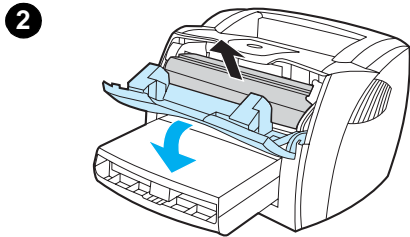

- 3 With a dry, lint-free cloth, wipe any residue from the media path area and the print cartridge cavity.
- 4 Replace the print cartridge, and close the print cartridge door.
- 5 Plug the power cord back into the printer.

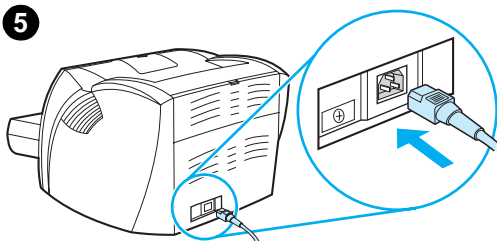
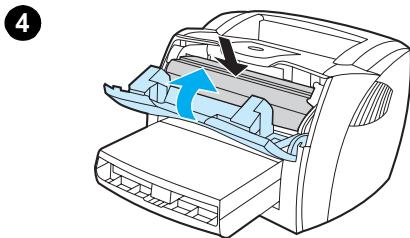
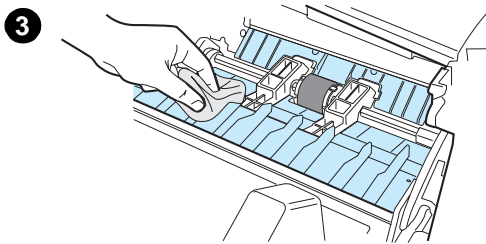

Cleaning the printer media path

If you are experiencing toner specks or dots on the printouts, you can use the HP LaserJet cleaning utility to remove excess media and toner particles that can accumulate on the fuser assembly and rollers. Cleaning the media path might extend the life of the printer.



Note

For best results use a sheet of transparency. If you do not have any transparencies, you can use copier grade media (18 to 24 lb. or 70 to 90 g/m²) with a smooth surface.

- 1 Make sure that the printer is idle and the Ready light is on.
- 2 Load the media in the paper input tray.
- 3 Access the printer properties. See [Printer properties \(driver\)](#) for instructions. Click the **Configure** tab, and click **Start** in **Cleaning Page**.

The cleaning process takes approximately 2 minutes.

Clearing printer media jams

Occasionally, media becomes jammed during a print job. Some of the causes include the following:

- The paper input tray is loaded improperly or it is too full. See [Loading media into the paper input tray](#) for more information.
- The media does not meet HP specifications. See [Printer media specifications](#) for more information.

Note

When you add new media, always remove all of the media from the paper input tray and straighten the stack of new media. This helps prevent multiple sheets of media from feeding through the printer at one time, reducing media jams.

You are notified of a media jam by an error in the software and the printer status lights. See [Status light patterns](#) for more information.

Typical media jam locations

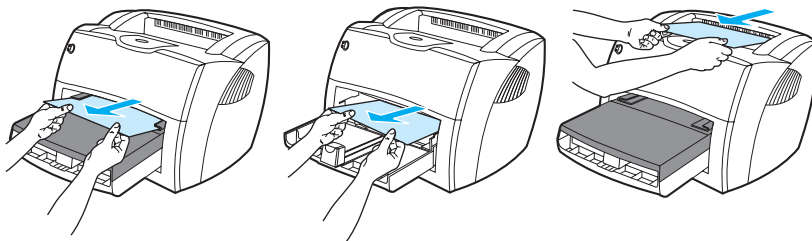

- **Print cartridge area:** See [Removing a jammed page](#) for instructions.
- **Paper input tray areas:** If the page is still sticking out of the paper input tray, gently try to remove it from the paper input tray without tearing the page. If you feel resistance, see [Removing a jammed page](#) for instructions.
- **Output paths:** If the page is sticking out of the output bin, gently try to remove it without tearing the page. If you feel resistance, see [Removing a jammed page](#) for instructions.

Note

There might be loose toner in the printer after a media jam. This toner clears up after a few sheets print.

Removing a jammed page

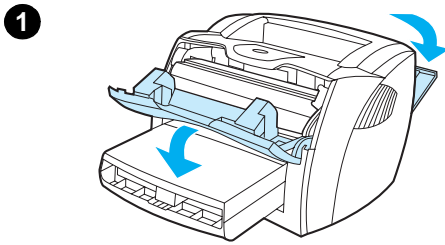

CAUTION

Media jams might result in loose toner on the page. If toner gets on your clothing, wipe the toner off with a dry cloth, and wash the clothing in cold water. *Hot water will permanently set the toner into the fabric.*

- 1 Open the print cartridge door and the straight-through output door.
- 2 Rotate the media jam release levers downward.

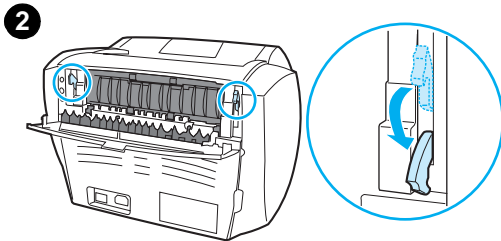

CAUTION

To prevent damage to the print cartridge, do not expose it to light.

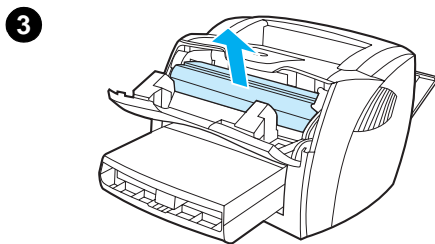

- 3 Remove the print cartridge, and place it aside.
- 4 With both hands, grasp the side of the media that is most visible (this includes the middle), and carefully pull it free from the printer. Make sure that you check for jams in the print cartridge area (A) and the straight-through output path (B).
- 5 When you have removed the jammed media, replace the print cartridge, and close the print cartridge door and the straight-through output door.

Note

The media jam release levers automatically close when you close the straight-through output door.

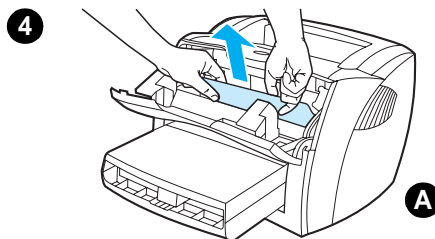

After clearing a media jam, you might need to unplug the printer, and plug it back in.

Note

When you add new media, remove all of the media from the paper input tray, and straighten the stack of new media.

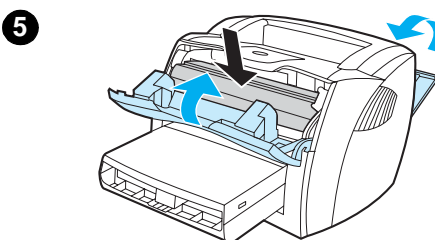
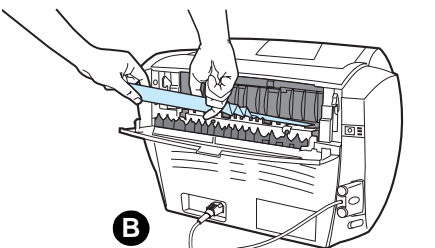

Changing the pickup roller

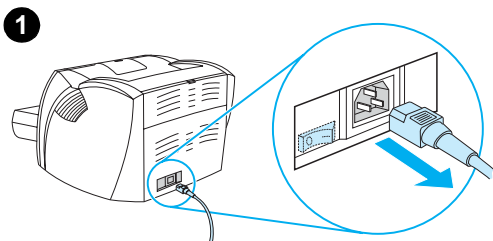

If the printer regularly mispicks (no media feeds through or more than one sheet feeds through), you might need to change or clean the pickup roller. See [Accessories and ordering information](#) to order a new pickup roller.

CAUTION

Failure to complete this procedure might damage the printer.

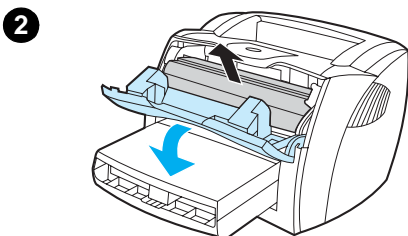

- 1 Unplug the power cord from the printer, and allow the printer to cool.
- 2 Open the print cartridge door, and remove the print cartridge.
- 3 Find the pickup roller.
- 4 Release the small, white tabs on either side of the pickup roller, and rotate the pickup roller toward the front.
- 5 Gently pull the pickup roller up and out.
- 6 Position the new or cleaned part in the slot of the previous pickup roller. See [Cleaning the pickup roller](#) for instructions.

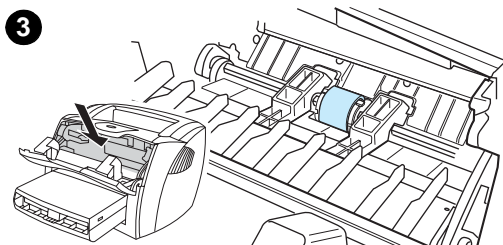

Note

Circular and rectangular pegs on each side prevent you from incorrectly positioning the pickup roller.

Continued on next page.

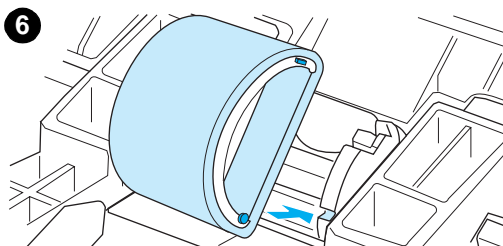
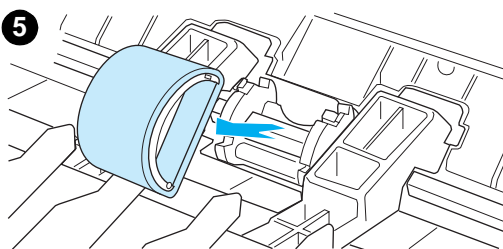
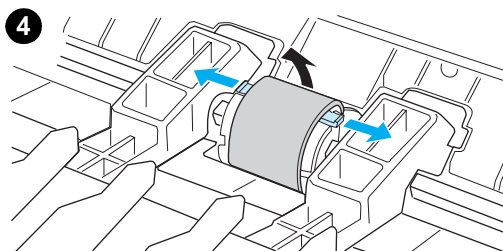

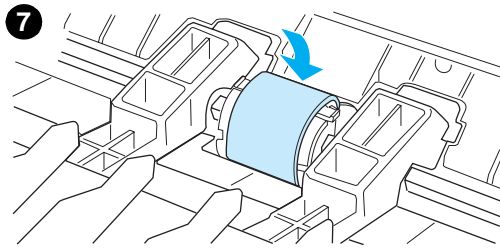

- 7 Rotate the top of the new pickup roller away from you until both sides snap into place.
- 8 Reinstall the print cartridge, and close the print cartridge door.
- 9 Plug the printer in to turn it back on.

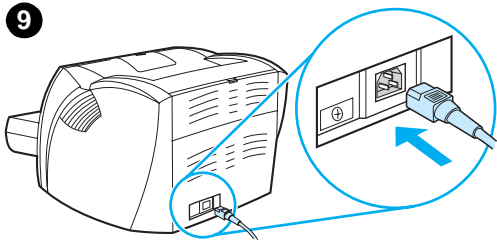
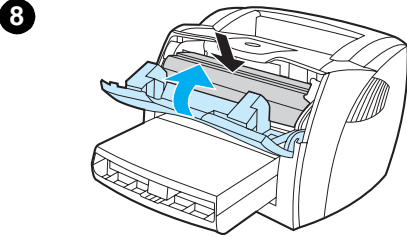

Cleaning the pickup roller

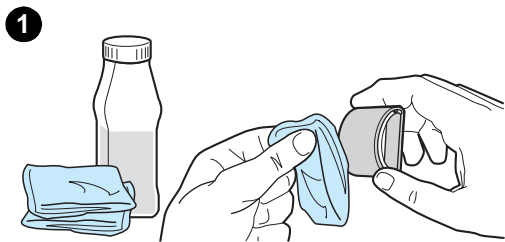

You can clean the pickup roller rather than replace it.

Remove the pickup roller as described in steps 1 through 5 of [Changing the pickup roller](#).

- 1 Dab a lint-free cloth in isopropyl alcohol, and scrub the roller.

WARNING!

Alcohol is flammable. Keep the alcohol and cloth away from an open flame. Before you close the printer and plug in the power cord, allow the alcohol to dry completely.

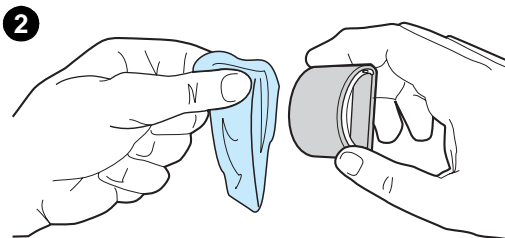

- 2 Using a dry, lint-free cloth, wipe the pickup roller to remove loosened dirt.

- 3 Allow the pickup roller to dry completely before you reinstall it in the printer (see steps 6 through 9 of [Changing the pickup roller](#)).

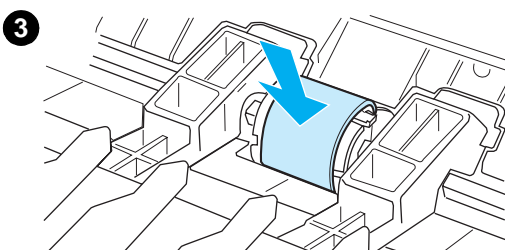

Changing the printer separation pad

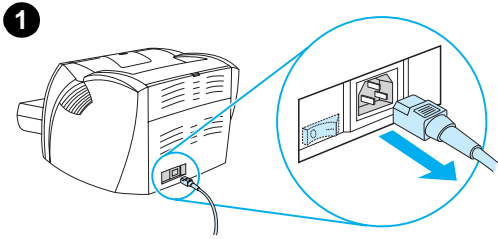

Note

Before you change the separation pad, clean the pickup roller. See [Cleaning the pickup roller](#) for instructions.

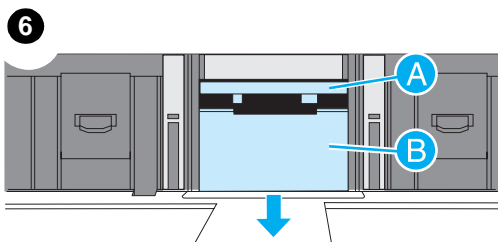
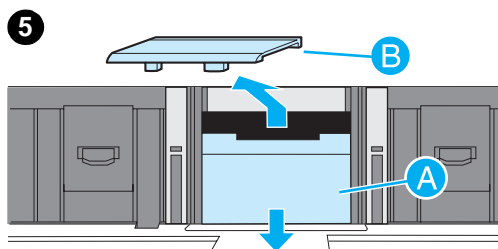
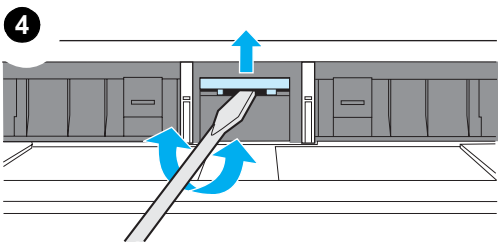
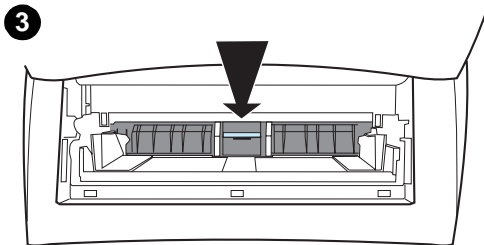
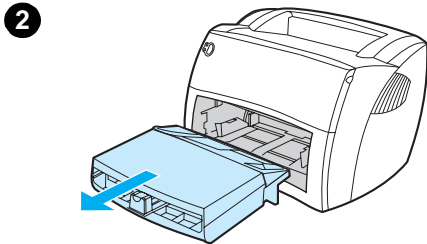

If the paper input tray feeds more than one page at a time, you might need to change the printer separation pad. Recurring feed problems indicate that the printer separation pad is worn. See [Accessories and ordering information](#) to order a new printer separation pad.

- 1 Unplug the power cord from the printer, and allow the printer to cool.
- 2 Remove the paper input tray.
- 3 Find the blue separation pad.
- 4 To pry the separation pad up from the spring-loaded base, insert a flat-edged screwdriver in the slot under the separation pad, and twist until the tabs are free.
- 5 With one hand, reach in through the opening, and push the spring-loaded base down (A). With the other hand, pull the separation pad up (B).
- 6 With one hand, position the new separation pad in the slot of the previous separation pad (A). With the other hand, reach through the paper input tray opening, and push the spring-loaded base down (B).

Note

The tab on the right is larger to help you position it correctly.

Continued on next page.

7

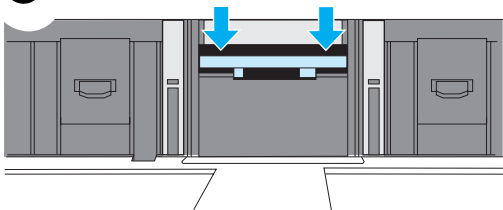

7 Snap both sides of the separation pad firmly into place.

CAUTION

Make sure that the separation pad is straight and that there is no space between the separation pad and the spring-loaded base. If the separation pad is not straight or you see space on one side, remove the separation pad, make sure that the larger tab is on the right, reinsert the separation pad, and snap both sides into place.

8

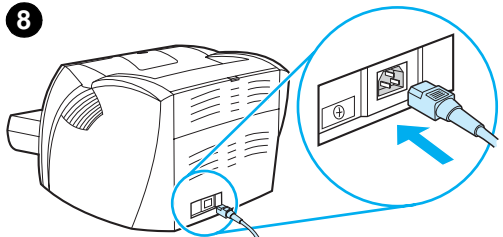

8 Reinsert the pickup roller, print cartridge, and paper input tray. Plug the printer in to turn it back on.

7 Service and support

This chapter provides information on the following topics:

- [Availability](#)
- [Hardware service](#)
- [Extended warranty](#)
- [Guidelines for repacking the printer](#)
- [Service information form](#)
- [Hewlett-Packard Support](#)
- [Worldwide sales and service offices](#)

Availability

Hewlett-Packard provides a variety of service and support options around the world. The availability of these programs varies depending on your location.

Hardware service

The warranty for the HP LaserJet 1005 Series Printer varies depending on the date and country/region of purchase.

For products that require service under the warranty, customers should call the customer support center in their country/region. See [Hewlett-Packard Support](#) for more information.

Hewlett-Packard will choose one of the following methods to fulfill the warranty:

- Repair the product.
- Provide customer-replaceable parts for the customer to repair the unit.
- Replace the product with a remanufactured unit.
- Replace the product with a new or remanufactured product of equal or greater functionality.
- Refund the purchase price.
- Require that the customer return the unit to an authorized service provider.

Extended warranty

HP SupportPack provides coverage for the HP product and all HP-supplied internal components. HP SupportPack can provide Express Exchange or onsite service. The customer must purchase HP SupportPack within 90 days of the HP product purchase. For more support information, go to the following HP Web site: <http://www.hp.com/support/lj1005>

or contact the Customer Care Service and Support group; see [Hewlett-Packard Support](#) for the appropriate phone numbers and information.

Guidelines for repacking the printer

Use the following guidelines when repacking the printer:

- If possible, include print samples and 5 to 10 sheets of paper or other media that did not print correctly.
- Remove and keep any cables, trays, and optional accessories installed in the printer.
- Remove and keep the print cartridge.

CAUTION

To prevent damage to the print cartridge, store the print cartridge in its original packing material or store it so that it is not exposed to light.

- If possible, use the original shipping container and packing material. *Shipping damage as a result of inadequate packing is your responsibility.* If you have already disposed of the printer's packing material, contact a local mailing service for information on repacking the printer.
- Include a completed copy of the service information form. See [Service information form](#).
- Hewlett-Packard recommends that you insure the equipment for shipment.

Service information form

Service information form

Who is returning the equipment?

Date:

Person to contact:

Phone:

Alternate contact:

Phone:

Return shipping address:

Special shipping instructions:

What is being sent?

Model number:

Serial number:

Please attach any relevant printouts when returning equipment. **Do not** ship accessories that are not required to complete the repair (for example, media trays, manuals, and cleaning supplies)

What needs to be done?

1. Describe the conditions of the failure (What was the failure? What were you doing when the failure occurred? What software were you running? Can you make the failure reoccur?)

2. If the failure is intermittent, how much time elapses between failures?

3. Is the unit connected to any of the following? (Please provide manufacturer and model numbers.)

Personal Computer:

Modem:

Network:

4. Additional comments:

Hewlett-Packard Support

Thank you for your purchase. Along with your product, you receive a variety of support services from Hewlett-Packard and our support partners that are designed to give you the results you need, quickly and professionally.

Please have the model number, serial number, date of purchase, and description of the problem ready for the HP Support representative.

The following support information is available:

- [European Customer Support Center](#)
- [Online services](#)
- [Obtaining software utilities and electronic information](#)
- [HP SupportPack](#)

European Customer Support Center

language and in-country/region options available

Open Monday through Friday 8:30-18:00 Central European Time (CET)

In many European countries/regions, HP provides toll-free telephone support service during the warranty period. However, some of the phone numbers listed below may not be toll-free. Please refer to Support Web Page <http://www.hp.com/cpso-support/guide/psd/cscemea.html> for any associated fees. By calling a telephone number listed on the Support Web Page, you will be connected to a responsive team waiting to help you. If you require support after the warranty has expired, you can receive support for a fee through the same telephone number. The fee is charged on a per-incident basis. When calling Hewlett-Packard, have the following information ready: product name and serial number, date of purchase, and description of the problem.

Online services

For 24-hour access to information over your modem, we suggest the following services.

World Wide Web URL

You can obtain printer drivers, updated HP printer software, and product and support information from the following sites:

in the U.S.	http://www.hp.com/support/lj1005_software
in Europe	http://www.hp.com

You can obtain printer drivers from the following sites:

in Korea	http://www.hp.co.kr
in Taiwan	http://www.hp.com.tw
or the local driver Web site	http://www.dds.com.tw

America Online

America Online/Bertelsmann is available in the U.S., France, Germany, and U.K. Printer drivers, updated HP printer software, and support documentation to help answer your questions about which HP products are available. Use Keyword HP to start the tour or call 1-800-827-6364 and use preferred customer #1118 to subscribe. In Europe, call the following numbers:

Austria	0222 58 58 485
France	++353 1 704 90 00
Germany	0180 531 31 64
Switzerland	0848 80 10 11
United Kingdom	0800 279 1234

CompuServe™

Printer drivers, updated HP printer software, and interactive sharing of technical information with other members are available on CompuServe's "HP User's forums" (GO HP), or call 1-800-524-3388 and ask for representative #51 to subscribe. (CompuServe is also available in the U.K., France, Belgium, Switzerland, Germany, and Austria.)

Obtaining software utilities and electronic information

You can obtain printer drivers from the following locations.

U.S. and Canada

Phone:	(805) 257-5565
Mail:	Hewlett-Packard Co. P.O. Box 1754 Greeley, CO 80632 U.S.A.
Fax:	(805) 257-6866

Australia, New Zealand, and India

For Australia and New Zealand, call (61) (2) 565-6099. For India, call (91) (11) 682-6035.

Europe

In the U.K., call (44) (142) 986-5511. For Ireland and outside of the U.K., call (44) (142) 986-5511.

HP SupportPack

Contact your authorized dealer, or use the following Web site:

<http://www.hpexpress-services.com/shop/application>

Worldwide sales and service offices

Before calling a Hewlett-Packard Sales and Service office, make sure that you contact the appropriate Customer Support Center number listed in [Hewlett-Packard Support](#). Do not return products to Hewlett-Packard Sales and Service offices.

To find the phone number for the Sales and Service office in your country/region, go to <http://www.hp.com>. From the main Web page, select your country/region, and follow the links to Contact HP and Office Locations.

A Printer specifications

This chapter provides information on the following topics:

- [Specifications](#)
- [FCC compliance](#)
- [Environmental Product Stewardship Program](#)
- [Material Safety Data Sheet](#)
- [Regulatory statements](#)

Specifications

Environmental specifications

Operating environment	Printer plugged into an AC outlet: <ul style="list-style-type: none">● Temperature: 10° C to 32.5° C (50° F to 90.5° F)● Humidity: 20% to 80% (no condensation) Install in a well-ventilated area.
-----------------------	---

Storage environment	Printer unplugged from an AC outlet: <ul style="list-style-type: none">● Temperature: 0° C to 40° C (32° F to 104° F)● Humidity: 10% to 80% (no condensation)
---------------------	--

Acoustics

Noise level	During printing: 6.1 Bels (A) sound power level (per ISO 9296) (HP LaserJet 1005 Series Printer tested at 14 ppm) <ul style="list-style-type: none">● Sound pressure level (bystander position): 48 dB● Sound pressure level (operator position): 56 dB During standby (power save): silent
-------------	---

Electrical specifications

Power requirements	<ul style="list-style-type: none">● 110-127Vac (+/-10%), 50/60 Hz (+/-2) or <ul style="list-style-type: none">● 220-240Vac (+/-10%), 50/60 Hz (+/-2)
--------------------	---

Power consumption	<ul style="list-style-type: none">● During printing: 285 watts (average)● During standby (power save): less than 10 watts
-------------------	--

Physical specifications

Dimensions	<ul style="list-style-type: none">● Width: 415 mm (16.3 in.)● Depth: 486 mm (19.1 in.)● Height: 253 mm (10.0 in.)
------------	---

Weight (cartridge installed)	7.3 kg (16.1 lb)
------------------------------	------------------

Printer capacities and ratings

Print speed	<ul style="list-style-type: none">● 14 pages per minute● First page out in less than 10 seconds
Paper input tray capacity	250 sheets of regular weight 20 lb (75 g/m ²) paper or up to 30 envelopes
Output bin capacity	125 sheets of regular weight 20 lb (75 g/m ²) paper
Minimum media size	76 x 127 mm (3 x 5 in.)
Maximum media size	216 x 356 mm (8.5 x 14 in.)
Media weight	<ul style="list-style-type: none">● Output bin – 60 to 105 g/m² (16 to 28 lbs)● Straight through media path – 60 to 163 g/m² (16 to 43 lbs)
Base memory	1 MB of RAM
Print resolution	600 dots per inch (dpi)
Duty cycle	7,000 single-sided pages per month
PCL	Level 5e via DOS applications running in a Windows DOS shell

Port availability

USB	Compatible with the USB 2.0 specification
Parallel	1284

FCC compliance

This equipment has been tested and found to comply with the limits for a Class B digital device, pursuant to Part 15 of the FCC rules. These limits are designed to provide reasonable protection against harmful interference in a residential installation. This equipment generates, uses, and can radiate radio frequency energy. If it is not installed and used in accordance with the instructions, it may cause harmful interference to radio communications. However, there is no guarantee that interference will not occur in a particular installation. If this equipment does cause harmful interference to radio or television reception, which can be determined by turning the equipment off and on, the user is encouraged to try to correct the interference by one or more of the following measures:

- Reorient or relocate the receiving antenna.
- Increase separation between equipment and receiver.
- Connect equipment to an outlet on a circuit different from that to which the receiver is located.
- Consult your dealer or an experienced radio/TV technician.

Note

Any changes or modifications to the printer that are not expressly approved by Hewlett-Packard could void the user's authority to operate this equipment.

Use of a shielded interface cable is required to comply with the Class B limits of Part 15 of FCC rules.

Environmental Product Stewardship Program

Protecting the environment

Hewlett-Packard Company is committed to providing quality products in an environmentally sound manner. This product has been designed with several attributes to minimize the impact on our environment.

Ozone production

This product generates no appreciable ozone gas (O₃).

Energy consumption

Energy usage drops significantly while in PowerSave mode, which saves money without affecting the high performance of this product. This product qualifies for ENERGY STAR[®], which is a voluntary program to encourage the development of energy-efficient office products.



ENERGY STAR[®] is a U.S. registered mark of the United States Environmental Protection Agency. As an ENERGY STAR[®] partner, Hewlett-Packard Company has determined that this product meets ENERGY STAR[®] Guidelines for energy efficiency. For more information, see <http://www.energystar.gov/>.

Toner consumption

EconoMode uses significantly less toner, which might extend the life of the print cartridge.

Media use

This product's N-up printing (multiple pages printed on one page) feature can reduce media usage and the resulting demands on natural resources.

Plastics

Plastic parts over 25 grams are marked according to international standards that enhance the ability to identify plastics for recycling purposes at the end of the product's life.

HP LaserJet printing supplies

In many countries/regions, this product's printing supplies (such as print cartridge, drum, and fuser) can be returned to Hewlett-Packard through the HP Printing Supplies Environmental Program. This easy-to-use, free take-back program is available in over 25 countries/regions. Multi-lingual program information and instructions are included in every new HP Print Cartridge and Consumables box.

HP Printing Supplies Environmental Program

Since 1990, the HP Printing Supplies Environmental Program has collected more than 48 million used print cartridges that otherwise might have been discarded in the world's landfills. The HP LaserJet print cartridges go to a collection center and are shipped in bulk to our resource and recovery partners who disassemble the print cartridge. Remaining materials are separated and converted into raw materials for use by other industries to make a variety of useful products.

U.S. returns

For a more environmentally responsible return of used print cartridges and consumables, Hewlett-Packard encourages you to use bulk returns. Simply bundle two or more print cartridges together and use the single, prepaid, pre-addressed UPS label that is supplied in the package. For more information in the U.S., call 1-800-340-2445 or visit the HP LaserJet Supplies Web site at http://www.hp.com/sbso/product/supplies/whybuy_recyc.html.

Non-U.S. recycling returns

Non-U.S. customers should call the local HP Sales and Service Office or visit the following Web site for more information regarding availability of the HP Printing Supplies Environmental Program. http://www.hp.com/sbso/product/supplies/whybuy_recyc.html

Media

This printer is suited for the use of recycled media when the media meets the guidelines in the *Guideline for Paper and Other Print Media*. See [Accessories and ordering information](#) for ordering information. This product is suitable for the use of recycled media according to DIN 19 309.

Material Safety Data Sheet

You can obtain Material Safety Data Sheets (MSDS) by contacting the HP LaserJet Supplies Web site at <http://www.hp.com/go/msds>.

Declaration of Conformity	
according to ISO/IEC Guide 22 and EN 45014	
Manufacturer's Name:	Hewlett-Packard Company
Manufacturer's Address:	11311 Chinden Boulevard Boise, Idaho 83714-1021, USA
declares that the product	
Product Name:	HP LaserJet 1005 Series Printer
Model Number:	Q2676A
Product Options:	ALL
conforms to the following Product Specifications:	
Safety:	IEC 60950:1991+A1+A2+A3+A4 / EN 60950:1992+A1+A2+A3+A4+A11 GB4943-1995 IEC 60825-1:1993 +A1/ EN 60825-1:1994+A11 Class 1 Laser/LED Product
EMC:	CISPR 22:1997 / EN 55022:1998 Class B ¹ EN 61000-3-2:1995 EN 61000-3-3:1995 EN 55024:1998 FCC Title 47 CFR, Part 15 Class B ² / ICES-002, Issue 2 / GB9254-88
Supplementary Information:	
The product herewith complies with the requirements of the EMC Directive 89/336/EEC and the Low Voltage Directive 73/23/EEC, and carries the CE-Marking accordingly.	
1) The product was tested in a typical configuration with Hewlett-Packard Personal Computer Systems.	
2) This Device complies with Part 15 of the FCC Rules. Operation is subject to the following two conditions: (1) this device may not cause harmful interference, and (2) this device must accept any interference received, including interference that may cause undesired operation.	
Boise, Idaho USA January 1, 2003	
For Regulatory Topics ONLY, contact:	
European Contact:	Your Local Hewlett-Packard Sales and Service Office or Hewlett-Packard GmbH, Department HQ-TRE / Standards Europe, Herrenberger Straße 110-140, D-71034 Böblingen (FAX: +49-7031-14-3143)
USA Contact:	Product Regulations Manager, Hewlett-Packard Company, PO Box 15, Mail Stop 160, Boise, Idaho 83707-0015 (Phone: 208-396-6000)

Laser safety statement

The Center for Devices and Radiological Health (CDRH) of the U.S. Food and Drug Administration has implemented regulations for laser products manufactured since August 1, 1976. Compliance is mandatory for products marketed in the United States. The printer is certified as a "Class 1" laser product under the U.S. Department of Health and Human Services (DHHS) Radiation Performance Standard according to the Radiation Control for Health and Safety Act of 1968.

Since radiation emitted inside the printer is completely confined within protective housings and external covers, the laser beam cannot escape during any phase of normal user operation.

WARNING!

Using controls, making adjustments, or performing procedures other than those specified in this user guide could result in exposure to hazardous radiation.

Laser statement for Finland

LASERTURVALLISUUS

LUOKAN 1 LASERLAITE

KLASS 1 LASER APPARAT

HP LaserJet 1005 -laserkirjoitin on käyttäjän kannalta turvallinen luokan 1 laserlaite. Normaalisissa käytössä kirjoittimen suojakotelointi estää lasersäteen pääsyn laitteen ulkopuolelle.

Laitteen turvallisuusluokka on määritetty standardin EN 60825-1 (1993) mukaisesti.

VAROITUS!

Laitteen käyttäminen muulla kuin käyttöohjeessa mainitulla tavalla saattaa altistaa käyttäjän turvallisuusluokan 1 ylittävälle näkymättömälle lasersäteilylle.

VARNING!

Om apparaten används på annat sätt än i bruksanvisning specificerats, kan användaren utsättas för osynlig laserstrålning, som överskrider gränsen för laserklass 1.

HUOLTO

HP LaserJet 1005 -kirjoittimen sisällä ei ole käyttäjän huollettavissa olevia kohteita. Laitteen saa avata ja huoltaa ainoastaan sen huoltamiseen koulutettu henkilö. Tällaiseksi huoltotoimenpiteeksi ei katsota väriainekasetin vaihtamista, paperiradan puhdistusta tai muita käyttäjän käsikirjassa lueteltuja, käyttäjän tehtäväksi tarkoitettuja ylläpitotoimia, jotka voidaan suorittaa ilman erikoistyökaluja.

VARO!

Mikäli kirjoittimen suojakotelo avataan, olet alttiina näkymättömälle lasersäteilylle laitteen ollessa toiminnassa. Älä katso säteeseen.

VARNING!

Om laserprinterns skyddshölje öppnas då apparaten är i funktion, utsättas användaren för osynlig laserstrålning. Betrakta ej strålen.

Tiedot laitteessa käytettävän laserdiodin säteilyominaisuuksista:

Aallonpituus 770-795 nm

Teho 5 mW

Luokan 3B laser

B Media specifications

This chapter provides information on the following topics:

- [Printer media specifications](#)
- [Supported media sizes \(printer\)](#)
- [Guidelines for using media](#)

Printer media specifications

HP LaserJet printers produce excellent print quality. The printer accepts a variety of media, such as cut-sheet paper (including recycled paper), envelopes, labels, transparencies, vellum, and custom-sized media. Properties such as weight, grain, and moisture content are important factors affecting printer performance and output quality.

The printer can use a variety of paper and other print media in accordance with the guidelines in this user guide. Media that does not meet these guidelines might cause the following problems:

- Poor print quality
- Increased media jams
- Premature wear on the printer, requiring repair

For best results, use only HP brand paper and print media. Hewlett-Packard Company cannot recommend the use of other brands. Because they are not HP products, Hewlett-Packard cannot influence or control their quality.

It is possible for media to meet all of the guidelines in this user guide and still not produce satisfactory results. This might be the result of improper handling, unacceptable temperature and humidity levels, or other variables over which Hewlett-Packard has no control.

Before you purchase a large quantity of media, make sure that it meets the requirements specified in this user guide and in *Guidelines for Paper and Other Print Media*. (See [Accessories and ordering information](#) for more information about ordering the guidelines.) Always test media before you purchase a large quantity.

CAUTION

Using media that does not meet Hewlett-Packard's specifications might cause problems for the printer, requiring repair. This repair is not covered by the Hewlett-Packard warranty or service agreements.

Supported media sizes (printer)

The following are the supported media sizes:

- **Minimum:** 76 x 127 mm (3 x 5 in.)
- **Maximum:** 216 x 356 mm (8.5 x 14 in.)

Guidelines for using media

Paper

For best results, use conventional 20 lb (75 g/m²) paper. Make sure that the paper is of good quality and free of cuts, nicks, tears, spots, loose particles, dust, wrinkles, voids, and curled or bent edges.

If you are unsure about what type of paper you are loading (such as bond or recycled), check the label on the package of paper.

Some paper causes print quality problems, jamming, or damage to the printer.

Paper usage

Symptom	Problem with paper	Solution
Poor print quality or toner adhesion. Problems with feeding.	Too moist, too rough, too smooth, or embossed. Faulty paper lot.	Try another kind of paper: between 100-250 Sheffield and 4 to 6% moisture content.
Dropouts, jamming, or curling.	Stored improperly.	Store paper flat in its moisture-proof wrapping.
Increased gray background shading.	Might be too heavy.	Use a lighter weight paper.
Excessive curling. Problems with feeding.	Too moist, wrong grain direction, or short-grain construction.	Use long-grain paper. Print using the straight-through output path.
Jamming or damage to the printer.	Cutouts or perforations.	Do not use paper with cutouts or perforations.
Problems with feeding.	Ragged edges.	Use good quality paper.

Note

Do not use letterhead that is printed with low-temperature inks, such as those used in some types of thermography.

Do not use raised letterhead.

The printer uses heat and pressure to fuse toner to the paper. Make sure that any colored paper or preprinted forms use inks that are compatible with the printer temperature (200° C or 392° F for 0.1 second).

Labels

When selecting labels, consider the quality of the following components:

- **Adhesives:** The adhesive material should be stable at 200° C (392° F), the printer's maximum temperature.
- **Arrangement:** Only use labels that do not have exposed backing between them. Labels can peel off of sheets that have spaces between the labels, causing serious jams.
- **Curl:** Prior to printing, labels must lie flat with no more than 13 mm (0.5 in.) of curl in any direction.
- **Condition:** Do not use labels with wrinkles, bubbles, or other indications of separation.

Transparencies

Transparencies must be able to withstand 200° C (392° F), the printer's maximum temperature.

Envelopes

Envelope construction

Envelope construction is critical. Envelope fold lines can vary considerably, not only between manufacturers, but also within a box from the same manufacturer. Successful printing on envelopes depends on the quality of the envelopes. When selecting envelopes, consider the following components:

- **Weight:** The weight of the envelope paper should not exceed 28 lb (105 g/m²), or jamming might result.
- **Construction:** Prior to printing, envelopes should lie flat with less than 6 mm (0.25 in.) curl and should not contain air. Envelopes that trap air may cause problems.
- **Condition:** Make sure that the envelopes are not wrinkled, nicked, or otherwise damaged.
- **Sizes:** From 90 x 160 mm (3.5 x 6.3 in.) to 178 x 254 mm (7 x 10 in.).

Envelopes with double-side seams

An envelope with double-side-seam construction has vertical seams at both ends of the envelope rather than diagonal seams. This style might be more likely to wrinkle. Make sure that the seam extends all the way to the corner of the envelope as shown in the following illustration:

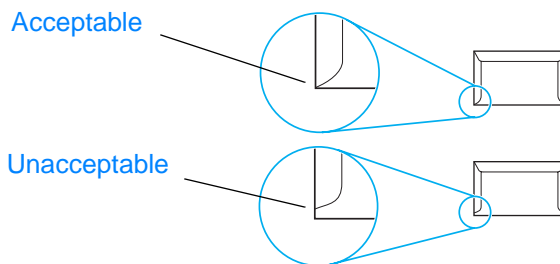

Envelopes with adhesive strips or flaps

Envelopes with a peel-off adhesive strip or with more than one flap that folds over to seal must use adhesives compatible with the heat and pressure in the printer: 200° C (392° F). The extra flaps and strips might cause wrinkling, creasing, or jams.

Envelope storage

Proper storage of envelopes contributes to good print quality. You should store envelopes flat. If air is trapped in an envelope, creating an air bubble, the envelope might wrinkle during printing.

Card stock and heavy media

You can print many types of card stock from the paper input tray, including index cards and postcards. Some card stock performs better than others because its construction is better suited for feeding through a laser printer.

For optimum printer performance, do not use media that is heavier than 42 lb (157 g/m²). Media that is too heavy might cause misfeeds, stacking problems, media jams, poor toner fusing, poor print quality, or excessive mechanical wear.

Note

You might be able to print on heavier media if you do not fill the paper input tray to capacity and if you use media with a smoothness rating of 100-180 Sheffield.

Card stock construction

- **Smoothness:** 36 to 42 lb (135 to 157 g/m²) card stock should have a smoothness rating of 100-180 Sheffield. 16 to 36 lb (60 to 135 g/m²) card stock should have a smoothness rating of 100-250 Sheffield.
- **Construction:** Card stock should lie flat with less than 5 mm (0.2 in.) of curl.
- **Condition:** Make sure that the card stock is not wrinkled, nicked, or otherwise damaged.
- **Sizes:** Only use card stock within the following size ranges:
 - **Minimum:** 76 x 127 mm (3 x 5 in.)
 - **Maximum:** 216 x 356 mm (8.5 x 14.0 in.)

Card stock guidelines

- If the card stock curls or jams, print using the straight-through output path.
- Set margins at least 2 mm (0.08 in.) away from the edges.

C Warranty and licensing

This chapter provides information on the following topics:

- [Hewlett-Packard software license agreement](#)
- [Hewlett-Packard limited warranty statement](#)
- [Limited warranty for print cartridge life](#)

Hewlett-Packard software license agreement

ATTENTION: USE OF THE SOFTWARE IS SUBJECT TO THE HP SOFTWARE LICENSE TERMS SET FORTH BELOW. USING THE SOFTWARE INDICATES YOUR ACCEPTANCE OF THESE LICENSE TERMS.

HP SOFTWARE LICENSE TERMS

The following License Terms govern your use of the accompanying Software unless you have a separate signed agreement with Hewlett-Packard.

License Grant. Hewlett-Packard grants you a license to use one copy of the Software. "Use" means storing, loading, installing, executing, or displaying the Software. You may not modify the Software or disable any licensing or control features of the Software. If the Software is licensed for "concurrent use," you may not allow more than the maximum number of authorized users to Use the Software concurrently.

Ownership. The Software is owned and copyrighted by Hewlett-Packard or its third-party suppliers. Your license confers no title to, or ownership in, the Software and is not a sale of any rights in the Software. Hewlett-Packard's third-party suppliers may protect their rights in the event of any violation of these License Terms.

Copies and Adaptations. You may only make copies or adaptations of the Software for archival purposes or when copying or adaptation is an essential step in the authorized Use of the Software. You must reproduce all copyright notices in the original Software on all copies or adaptations. You may not copy the Software onto any public network.

No Disassembly or Decryption. You may not disassemble or decompile the Software unless HP's prior written consent is obtained. In some jurisdictions, HP's consent may not be required for limited disassembly or decompilation. Upon request, you will provide HP with reasonably detailed information regarding any disassembly or decompilation. You may not decrypt the Software unless decryption is a necessary part of the operation of the Software.

Transfer. Your license will automatically terminate upon any transfer of the Software. Upon transfer, you must deliver the Software, including any copies and related documentation, to the transferee. The transferee must accept these License Terms as a condition to the transfer.

Termination. HP may terminate your license upon notice for failure to comply with any of these License Terms. Upon termination, you must immediately destroy the Software, together with all copies, adaptations, and merged portions in any form.

Export Requirements. You may not export or re-export the Software or any copy or adaptation in violation of any applicable laws or regulations.

U.S. Government Restricted Rights. The Software and any accompanying documentation have been developed entirely at private expense. They are delivered and licensed as "commercial computer software" as defined in DFARS 252.227-7013 (Oct 1988), DFARS 252.211-7015 (May 1991), or DFARS 252.227-7014 (Jun 1995), as a "commercial item" as defined in FAR 2.101(a) (Jun 1987), or as "Restricted computer software" as defined in FAR 52.227-19 (Jun 1987) (or any equivalent agency regulation or contract clause), whichever is applicable. You have only those rights provided for such Software and any accompanying documentation by the applicable DFARS or FAR clause or the HP standard software agreement for the product involved.

Hewlett-Packard limited warranty statement

DURATION OF WARRANTY:

One year from date of purchase.

The warranty for the HP LaserJet 1005 Series Printer varies depending on the date and country/region of purchase.

For products that require service under the warranty, customers should call the customer support center in their country/region. See [Hewlett-Packard Support](#) for more information. Hewlett-packard will choose one of the following methods to fulfill the warranty:

- Repair the product.
- Provide customer-replaceable parts for the customer to repair the unit.
- Replace the product with a remanufactured unit.
- Replace the product with a new or remanufactured product of equal or greater functionality.
- Refund the purchase price.
- Require that the customer return the unit to an authorized service provider.

1. HP warrants to you, the end-user customer, that HP hardware, accessories, and supplies, will be free from defects in materials and workmanship after the date of purchase, for the period specified above. The customer is responsible for maintaining proof of date of purchase. If HP receives notice of such defects during the warranty period, HP will, at its option, either repair or replace products which prove to be defective. Any replacement products may be either new or like-new, provided that it has functionality at least equal to that of the product being replaced.
2. HP warrants to you that HP software will not fail to execute its programming instructions after the date of purchase, for the period specified above, due to defects in material and workmanship when properly installed and used. If HP receives notice of such defects during the warranty period, HP will replace software media which does not execute its programming instructions due to such defects.
3. HP does not warrant that the operation of HP products will be uninterrupted or error free. If HP is unable, within a reasonable time, to repair or replace any product to a condition as warranted, you will be entitled to a refund of the purchase price upon prompt return of the product.
4. HP products may contain remanufactured parts equivalent to a new in performance or may have been subject to incidental use.
5. Warranty does not apply to defects resulting from (a) improper or inadequate maintenance or calibration, (b) software, interfacing, parts or supplies not supplied by HP, (c) unauthorized modification or misuse, (d) operation outside of the published environmental specifications for the product, or (d) improper site preparation or maintenance.
6. **HP MAKES NO OTHER EXPRESS WARRANTY OR CONDITION WHETHER WRITTEN OR ORAL. TO THE EXTENT ALLOWED BY LOCAL LAW, ANY IMPLIED WARRANTY OR CONDITION OR MERCHANTABILITY, SATISFACTORY QUALITY, OR FITNESS FOR A PARTICULAR PURPOSE IS LIMITED TO THE DURATION OF THE EXPRESS WARRANTY SET FORTH ABOVE.** Some countries/regions, states or provinces do not allow limitations on the duration of an implied warranty, so the above limitation or exclusion might not apply to you. This warranty gives you specific legal rights and you might also have other rights that vary from country/region to country/region, state to state, or province to province.

7. TO THE EXTENT ALLOWED BY LOCAL LAW, THE REMEDIES IN THIS WARRANTY STATEMENT ARE YOUR SOLE AND EXCLUSIVE REMEDIES. EXCEPT AS INDICATED ABOVE, IN NO EVENT WILL HP OR ITS SUPPLIERS BE LIABLE FOR LOSS OF DATA OR FOR DIRECT, SPECIAL, INCIDENTAL, CONSEQUENTIAL (INCLUDING LOST PROFIT OR DATA), OR OTHER DAMAGE, WHETHER BASED IN CONTRACT, TORT, OR OTHERWISE. Some countries/regions, states or provinces do not allow the exclusion or limitation of incidental or consequential damages, so the above limitation or exclusion may not apply to you.

FOR CONSUMER TRANSACTIONS IN AUSTRALIA AND NEW ZEALAND; THE WARRANTY TERMS CONTAINED IN THIS STATEMENT, EXCEPT TO THE EXTENT LAWFULLY PERMITTED, DO NOT EXCLUDE, RESTRICT OR MODIFY AND ARE IN ADDITION TO THE MANDATORY STATUTORY RIGHTS APPLICABLE TO THE SALE OF THIS PRODUCT TO YOU.

Limited warranty for print cartridge life

Note

The following warranty applies to the print cartridge that came with this printer.

HP print cartridges are warranted to be free from defects in materials and workmanship until the HP toner is depleted. The warranty covers any defects or malfunctions in a new HP print cartridge.

How long does the coverage last?

The coverage lasts until the HP toner is depleted, at which time the warranty expires.

How do I know when the HP toner is running out?

The HP toner is depleted when faded or light type appears on the printed page.

What will Hewlett-Packard do?

Hewlett-Packard will, at its option, either replace products that prove to be defective or refund the purchase price. If possible, please attach a printout sample illustrating what the defective print cartridge is printing.

What does this warranty not cover?

The warranty does not cover print cartridges that have been refilled or are emptied, abused, misused, or tampered with in any way.

How do I return the faulty print cartridge?

In the event that the print cartridge proves to be defective, complete the Service Information Form and attach a print sample illustrating the defect. Return the form and print cartridge to the place of purchase, where the print cartridge will be replaced.

How does State, Province, or Country/Region Law apply?

This limited warranty gives you specific legal rights, and you may also have other rights which vary from state to state, province to province, or country/region to country/region. This limited warranty is the sole warranty on the HP print cartridge and supersedes any other warranty relating to this product.

IN NO EVENT SHALL HEWLETT-PACKARD COMPANY BE LIABLE FOR ANY INCIDENTAL, CONSEQUENTIAL, SPECIAL, INDIRECT, PUNITIVE, OR EXEMPLARY DAMAGES OR LOST PROFITS FROM ANY BREACH OF THIS WARRANTY OR OTHERWISE.

FOR CONSUMER TRANSACTIONS IN AUSTRALIA AND NEW ZEALAND; THE WARRANTY TERMS CONTAINED IN THIS STATEMENT, EXCEPT TO THE EXTENT LAWFULLY PERMITTED, DO NOT EXCLUDE, RESTRICT OR MODIFY AND ARE IN ADDITION TO THE MANDATORY STATUTORY RIGHTS APPLICABLE TO THE SALE OF THIS PRODUCT TO YOU.

D Accessories and ordering information

You can increase the printer's capabilities with optional accessories and supplies. Use accessories and supplies specifically designed for the HP LaserJet 1005 Series Printer to ensure optimum performance.

Ordering information

	Item	Description or use	Order number
Printing supplies	HP Multipurpose paper	HP brand paper for a variety of uses (1 box of 10 reams, 500 sheets each). To order a sample, in the U.S., call 1-800-471-4701.	HPM1120
	HP LaserJet paper	Premium HP brand paper for use with HP LaserJet printers (1 box of 10 reams, 500 sheets each). To order a sample, in the U.S., call 1-800-471-4701.	HPJ1124
	HP LaserJet transparency film	HP brand transparency film for use with HP LaserJet monochrome printers.	92296T (letter) 92296U (A4)
Print cartridges	UltraPrecise print cartridges	Replacement print cartridges for the HP LaserJet 1005 Series Printer. 2,500 page cartridge	 C7115A
Supplementary documentation	<i>Guidelines for Paper and Other Print Media</i>	A guide to using paper and other print media with HP LaserJet printers.	5963-7863

Ordering information (continued)

	Item	Description or use	Order number
Replacement parts	Media pickup roller	Used to pick the media from the paper input tray and advance it through the printer.	RF0-1008CN
	Paper input tray	Used to hold media for the printer.	RG0-1013-000CN
	Paper input tray cover	Used to cover the media in the paper input tray.	RG0-1014-000CN
	Separation pad for the printer	Used to keep multiple sheets from feeding through the printer path.	RF0-1007CN

E Installing shared printers

Windows sharing allows other network users to print to the HP LaserJet 1005 Series Printer. To enable Windows sharing, see the operating system's documentation. Once the printer is shared, you must install the printer drivers on all of the computers that will print to the printer.

Note

You can perform the following procedure on Windows 9x, 2000, Millennium, XP, or NT 4.0. You might need the HP LaserJet 1005 Series Printer software CD-ROM to complete this procedure.

To install the printer drivers on a network computer, perform the following steps:

- 1 In the Windows system tray, click **Start**, select **Settings**, and click **Printers**.
- 2 Double-click the **Add Printer** icon.
- 3 In the Add Printer Wizard, click **Next**.
- 4 Follow the instructions on the screen.
- 5 When asked if the printer is a local or network printer, select **Network Printer**.
- 6 To find the printer, click **Browse**, find the HP LaserJet 1005 Series Printer on the network, and click **OK**.
- 7 When prompted, print a test page to ensure that the printer driver is installed properly.

Index

A

- Accessories
 - ordering information 85
- Acoustics 66
- America Online
 - accessing support services 63

C

- Canceling print jobs 32
- Card stock
 - guidelines for using 77
 - printing 27
- Cleaning
 - media path 50
 - pickup roller 55
 - printer 48
- Clearing media jams 51
- Components, printer 16
- CompuServe
 - accessing support services 63
- Custom-sized media
 - printing 27

D

- Declaration of Conformity 71
- Default settings
 - print quality 32
 - printer properties (driver) 30

E

- EconoMode 32
- Electrical specifications 66
- ENERGY STAR rating 69
- Envelopes
 - guidelines for using 76
 - printing 25
- Environmental Product Stewardship Program 69
- Environmental specifications 66
- Error messages
 - on screen 41
 - status light patterns 39
- European Customer Support Center 62
- Extended warranty 60

F

- FCC compliance 68
- Finland, laser statement 72

H

- Hardware
 - extended warranty 60
 - setting up 7
 - warranty 60
- Heavy media
 - guidelines for using 77
- Help, online 30
- HP Printing Supplies Environmental Program 70
- HP SupportPack 60, 63

I

- Image defects
 - creases 47
 - curled media 47
 - dropouts 45
 - faded print 45
 - gray background 45
 - improperly formed characters 46
 - light print 45
 - loose toner 46
 - page skew 46
 - toner scatter outline 47
 - toner smear 46
 - toner specks 45
 - vertical lines 45
 - vertical repetitive defects 46
 - wavy text 47
 - wrinkles 47
- Installing
 - shared printers 87
 - software 7

J

- Jams
 - clearing 51

L

- Labels
 - guidelines for using 76
 - printing 24
- Laser safety statement 71
- Laser statement for Finland 72
- Letterhead
 - printing 26
- License agreement, software 80
- Limited warranty statement 81

M

- Material safety data sheet 70
- Media
 - card stock, printing 27
 - choosing 22
 - custom-sized, printing 27
 - envelopes, printing 25
 - guidelines for using 75
 - labels, printing 24
 - letterhead, printing 26
 - loading 23
 - optimizing print quality 22
 - preprinted forms, printing 26
 - specifications 73
 - supported sizes and types 22
 - transparencies, printing 24
- Media guides 18
- Media handling problems 42
- Media jams
 - clearing 51
- Media path
 - cleaning 50

Multiple pages per sheet
printing 31

N

N-up printing 31

O

Online help
printer properties (driver) 30
Online support services 62
Ordering information 85
Output paths 18

P

Paper
choosing 22
guidelines for using 75
loading 23
optimizing print quality 22
specifications 73
supported sizes and types 22
Paper handling problems 42
Paper input tray 17
Part numbers 85
Physical specifications 66
Pickup roller
changing 53
cleaning 55
Port availability 67
Power
turning off 20
voltage conversions 20
Preprinted forms
printing 26
Print cartridge
changing 36
life expectancy 34
limited warranty statement 83
non-HP print cartridges 34
recycling 34
storing 34
Print cartridge area
cleaning 49
Print cartridge door 19
Print quality
optimizing 22
settings 32
troubleshooting 45
Printed page problems 43
Printer
capacities and ratings 67
cleaning 48
components 16
hardware set up 7
loading media 23
media guides 18
output paths 18
paper input tray 17
print cartridge door 19
software installation 7
specifications 66
status light patterns 39
status lights 17
troubleshooting 37
turning power off 20
voltage conversions 20
Printer drivers
obtaining 63

Printer properties (driver)
accessing 30
multiple pages per sheet 31
N-up printing 31
online help 30
print quality settings 32
watermarks 31
Printers, shared
installing 87
Printing
card stock 27
custom-sized media 27
envelopes 25
labels 24
letterhead 26
preprinted forms 26
transparencies 24
Printing tasks
canceling print jobs 32
multiple pages per sheet 31
N-up printing 31
watermarks 31

R

Recycling print cartridges 34
Regulatory statements 71

S

Sales office locations 64
Saving toner 32
Screen messages 41
Separation pad
changing 56
Service
availability 60
extended warranty 60
guidelines for repacking printer 60
hardware 60
information form 61
office locations 64
Settings
print quality 32
printer properties (driver) 30
Shared printers
installing 87
Software
installing 7
license agreement 80
troubleshooting 44
Software utilities
obtaining 63
Specifications
media 73
printer 66
Status light patterns 39
Status lights 17
Supplies
ordering information 85
Support
America Online 63
availability 60
CompuServe 63
European Customer Support Center 62
HP SupportPack 60, 63
obtaining printer drivers 63
online services 62
Web 62

T

Toner

- EconoMode 32
- redistributing 35

Transparencies

- guidelines for using 76
- printing 24

Troubleshooting

- error messages on screen 41
- finding solutions 38
- image defects 45
- media handling 42
- media jams 51
- print quality 45
- printed page problems 43
- printer 37
- software 44
- status light patterns 39

U

Utilities

- obtaining 63

V

- Voltage conversions 20

W

Warranty

- extended 60
- hardware service 60
- limited 81
- print cartridge 83

Watermarks 31

Web

- accessing support services 62



i n v e n t

copyright © 2003
Hewlett-Packard Company

www.hp.com



Q2676-90906

Free Manuals Download Website

<http://myh66.com>

<http://usermanuals.us>

<http://www.somanuals.com>

<http://www.4manuals.cc>

<http://www.manual-lib.com>

<http://www.404manual.com>

<http://www.luxmanual.com>

<http://aubethermostatmanual.com>

Golf course search by state

<http://golfingnear.com>

Email search by domain

<http://emailbydomain.com>

Auto manuals search

<http://auto.somanuals.com>

TV manuals search

<http://tv.somanuals.com>