



HP

LaserJet

2100

2100 M

2100 TN

Printers

User
Guide



HP LaserJet 2100, 2100 M, and 2100 TN Printers

User Guide ---

© Copyright Hewlett-Packard Company 1998

All Rights Reserved.
Reproduction, adaptation, or translation without prior written permission is prohibited, except as allowed under the copyright laws.

Publication number:

C4170-90901

First Edition, November 1998

Warranty

The information contained in this document is subject to change without notice.

Hewlett-Packard makes no warranty of any kind with respect to this information.

HEWLETT-PACKARD SPECIFICALLY DISCLAIMS THE IMPLIED WARRANTY OF MERCHANTABILITY AND FITNESS FOR A PARTICULAR PURPOSE.

Hewlett-Packard shall not be liable for any direct, indirect, incidental, consequential, or other damage alleged in connection with the furnishing or use of this information.

Trademark Credits

Adobe®, Acrobat®, PostScript®, and Adobe Photoshop® are trademarks of Adobe Systems Incorporated which may be registered in certain jurisdictions.

Arial®, Monotype®, and Times New Roman® are U.S. registered trademarks of the Monotype Corporation.

CompuServe™ is a U.S. trademark of CompuServe, Inc.

Helvetica™, Palatino™, Times™, and Times Roman™ are trademarks of Linotype AG and/or its subsidiaries in the U.S. and other countries.

Microsoft®, MS Windows, Windows®, and Windows NT® are U.S. registered trademarks of Microsoft Corporation.

LaserWriter® is a registered trademark of Apple Computer, Inc.

TrueType™ is a U.S. trademark of Apple Computer, Inc.

ENERGY STAR® is a U.S. registered service mark of the U.S. EPA.

Hewlett-Packard Company
11311 Chinden Boulevard
Boise, Idaho 83714 U.S.A.

HP Support (continued)

HP Service Information:	To locate HP-Authorized Dealers, call 1-800-243-9816 (U.S.) or 1-800-387-3867 (Canada).		
HP Service Agreements:	Call 1-800-835-4747 (U.S.) or 1-800-268-1221 (Canada). Extended Service 1-800-446-0522		
HP FIRST: HP FIRST Fax will deliver detailed troubleshooting information on common software and troubleshooting tips for your HP product. Call from any touch tone phone and request up to three documents per call. These documents will be sent to the fax of your choice.			
Australia	+61 (0) 3 9272 2627	Korea	+82 (0) 02 769 0543
Austria	0660-8218	Malaysia	+60 (0) 3 298 2478
Belgium (Dutch)	0800 1 1906	Netherlands	0800-0222420
Belgium (French)	0800 1 7043	New Zealand	+64 (0) 09 356 6642
Canada	1-800-333-1917	Norway	800-11319
China	+86 (0) 10 6505 5280	Portugal	05 05 313342
Denmark	800-10453	Philippines	+65 275 7251
English (outside of U.K.)	+31 20 681 5792	Singapore	+65 275 7251
Finland	800-13134	Spain	900-993123
France	0800-905900	Sweden	020-79-5743
Germany	0130-810061	Switzerland (German)	0800-551527
Hong Kong	852-2506-2422	Switzerland (French)	0800-551526
Hungary	(36) (1) 252-4647	Taiwan	(886) (2) 719-5589
India	+91 (0) 11 682 6031	Thailand	+66 (0) 2 661 3511
Indonesia	+62 (0) 21 352 2044	United Kingdom	0800-960271
Italy	1678-59020	United States	1-800-333-1917
Japan	+81 (0) 3 3335 8622		

Customer Support Worldwide

<p>Customer Support and Product Repair Assistance for the U.S. and Canada:</p> <p>(Refer to the service and support chapter of this user guide for additional product repair information.)</p>	<p>Call (1) (208) 323-2551 Monday through Friday from 6 am to 10 pm, Saturday 9 am to 4 pm (Mountain Time) free of charge during the warranty period. However, your standard long-distance phone charges still apply. Have your system nearby and your serial number ready when calling.</p> <p>If you know your printer needs repair, call 1-800-243-9816 to locate your nearest HP-Authorized service provider, or call 208-223-2551 for HP centralized service dispatch.</p> <p>Post-warranty telephone assistance is available to answer your product questions. Call (1) (900) 555-1500 (\$2.50* per minute, U.S. only) or call 1-800-999-1148 (\$25* per call, Visa or MasterCard, U.S. and Canada) Monday through Friday from 7 am to 6 pm and Saturday from 9 am to 3 pm (Mountain Time). <i>Charges begin only when you connect with a support technician. *Prices subject to change.</i></p>
<p>European Customer Support Center Language and In-Country Options Available Open Monday through Friday 8:30–18:00 CET</p>	
<p>HP provides a free telephone support service during the warranty period. By calling a telephone number listed below, you will be connected to a responsive team waiting to help you. If you require support after your warranty has expired, you can receive support for a fee through the same telephone number. The fee is charged on a per-incident basis. When calling HP, have the following information ready: product name and serial number, date of purchase, and description of the problem.</p>	
<p>English Ireland: (353) (1) 662-5525 U.K.: (44) (171) 512-5202 International: (44) (171) 512-5202</p> <p>Dutch Belgium: (32) (2) 626-8806 Netherlands: (31) (20) 606-8751</p> <p>French France: (33) (01) 43-62-3434 Belgium: (32) (2) 626-8807 Switzerland: (41) (84) 880-1111</p>	<p>German Germany: (49) (180) 525-8143 Austria: (43) (1) 0660-6386</p> <p>Norwegian Norway: (47) 2211-6299</p> <p>Danish Denmark: (45) 3929-4099</p> <p>Finnish Finland: (358) (9) 0203-47288</p> <p>Swedish Sweden: (46) (8) 619-2170</p> <p>Italian Italy: (39) (2) 264-10350</p> <p>Spanish Spain: (34) (90) 232-1123</p> <p>Portuguese Portugal: (351) (1) 441-7199</p>

Customer Support Worldwide (continued)

In-country support numbers:		If you require support after your warranty has expired, additional product repair services, or if your country is not listed below, see "Worldwide Sales and Service Offices."	
Argentina	787-8080	Japan	(81) (3) 3335-8333
Australia	(61) (3) 272-8000	Malaysia	(60) (3) 295-2566
Brazil	022-829-6612	Mexico (Mexico City)	01 800-22147
Canada	(1) (208) 323-2551	Mexico (outside Mexico City)	01 800-90529
China	(86) (10) 65053888-5959	New Zealand	(64) (9) 356-6640
Chile	800-360999	Philippines	(63) (2) 894-1451
Czech Republic	(42) (2) 471-7321	Poland	(48) (22) 37-5065
Greece	(30) (1) 689-6411	Portugal	(351) (1) 301-7330
Hong Kong	(852) 800-96-7729	Russia	(7) (95) 923-5001
Hungary	(36) (1) 343-0310	Singapore	(65) 272-5300
India	(91) (11) 682-6035	Taiwan	(886) (02) 717-0055
	(91) (11) 682-6069	Thailand	+66 (0) 2 661-4011
Indonesia	(62) (21) 350-3408	Turkey	(90) (1) 224-5925
Korea	(82) (2) 3270-0700		
Korea outside Seoul, call	(82) (080) 999-0700		

Contents

1 Printer Basics

Getting to Know the Printer	1
Printer Features	2
Printer Software	4
Windows Installation	5
Software for Windows	6
HP JetSend (CD-ROM - Windows 9x/NT 4.0 only)	9
Macintosh Installation	10
Software For Macintosh Computers	11
DOS Installation	12
Using the Remote Control Panel	12
Software Installation Tips	13
Control Panel	15
Button Usage	15
Light Patterns	16
Control Panel Light Messages	16
Startup	16
Ready	16
Processing	17
Data	17
Manual Feed with Pause	17
Paper Out	18
Paper Out (requested tray)	18
Attention	18
Continuable Error	19
Service Error	19
Accessory Error	19
Printing with the Infrared Port (Wireless Printing)	20
Printing Instructions	21
Interface Ports	22
Accessories and Ordering Information	23

2 Printing Tasks

Overview	27
Preparing for Printing	28
Purchasing Paper and Other Media	28
Media Input Options	29
Tray 1 Media Sizes	29
Tray 2 and Optional Tray 3 Paper Sizes	30
Loading Media into Tray 1	31

Reloading Media into Tray 2 or Optional Tray 3	32
Changing Paper Size in Tray 2 or Optional Tray 3	33
Printing Tasks	35
Printing on Envelopes	35
Printing on Labels	37
Printing on Transparencies	38
Printing on Custom-Sized Media or Cardstock	39
Printing on Both Sides of Media (Manual Duplexing)	40
Printing on Special Media	42
Canceling a Print Job	43
Software Tasks	44
Accessing the Printer Driver	44
Using the Printer Driver Help	45
Creating and Using Watermarks	46
Printing Multiple Pages on One Sheet of Paper (N-up Printing)	50
Setting a Custom Paper Size	52
Creating and Using Quick Sets	54
Using EconoMode	56
Choosing Print Quality Settings	58
Using Reduce/Enlarge Options	60
Selecting a Paper Source	62
Using REt	63
Restoring Default Printer Driver Settings	65
Printing on Different Paper for the First Page	66
Tray Locking	68

3 Printer Tips and Maintenance

Overview	69
Managing the UltraPrecise Toner Cartridge	70
HP Policy on Non-HP Toner Cartridges	70
Toner Cartridge Storage	70
Toner Cartridge Life Expectancy	70
Recycling Toner Cartridges	70
Redistributing the Toner	71
Cleaning the Printer	73
Using the Printer Cleaning Processes	73
Starting the Cleaning Process	74
Internal Cleaning Procedure	75

4 Problem Solving

Overview	77
Troubleshooting Checklist	78
Troubleshooting General Printing Problems	80
Printing Special Pages	84
Demo Page	84
Configuration Page	84

Cleaning Process	84
Font List	84
Clearing Paper Jams	85
Paper Jam: Toner Cartridge Area	86
Paper Jam: Tray 2 or Optional Tray 3 Paper Feed Area	88
Paper Jam: Output Areas	89
Paper Jam: Removing Torn Pieces of Paper	90
Solving Print Quality Problems	91
Print Quality Checklist	91
Image Defect Examples	92
Infrared Printing Problems	97
Troubleshooting Error Messages	99
Paper Out	99
Attention	100
Continuable Error	100
Service Error	101
Accessory Error	101
Secondary Light Patterns	102
Network Problems	107
Common Windows Problems	108
Common Macintosh Problems	110
Selecting an Alternate PPD	113
Troubleshooting PS Errors	114

5 Service and Support

Availability	117
HP Express Exchange	117
Guidelines for Repacking the Printer	118
Service Information Form	119
HP Maintenance Agreements	120
On-Site Service Agreements	120
Hewlett-Packard Limited Warranty Statement	121
Limited Warranty for Toner Cartridge Life	123
Worldwide Sales and Service Offices	124

Appendix A Specifications

Printer Specifications	129
FCC Regulations	131
Environmental Product Stewardship Program	132
Protecting the Environment	132
Material Safety Data Sheet	134
Regulatory Statements	135
Declaration of Conformity	135
Laser Safety Statement	136
Canadian DOC Regulations	136
LED Safety	136

VCCI Statement (Japan)	137
Korean EMI Statement	137
Laser Statement for Finland	137

Appendix B Media Specifications

Overview	139
Supported Sizes of Paper	140
Guidelines for Using Paper	142
Paper Specifications	143
Printing and Paper Storage Environment	144
Envelopes	145
Envelopes with Double Side Seams	146
Envelopes with Adhesive Strips or Flaps	146
Envelope Margins	147
Envelope Storage	147
Labels	148
Label Construction	148
Transparencies	149

Appendix C Printer Memory and Expansion

Overview	151
Printer Memory	152
Installing Memory	153
Checking Memory Installation	155
Installing an HP JetDirect EIO Card	156

Appendix D Printer Commands

Overview	157
Understanding PCL Printer Command Syntax	158
Combining Escape Sequences	160
Entering Escape Characters	160
Selecting PCL Fonts	161

Index

1

Printer Basics

Getting to Know the Printer

This chapter provides information in the following areas:

- Printer Features
- Printer Software
- Control Panel
- Printing with the Infrared Port (Wireless Printing)
- Interface Ports
- Accessories and Ordering Information

Printer Features

Fast Print Speed

- 10 pages-per-minute printing (with Intel 80960JD RISC-based formatter).

Excellent Print Quality

- True 1200 x 1200 dots per inch (dpi) text and graphics.
- Resolution Enhancement technology (REt) adjusts the size and placement of each dot on the page to produce smooth angles, curves, and edges (600 dpi only).
- Adjustable settings to optimize print quality.
- The HP UltraPrecise toner cartridge has a finer toner formulation which provides sharper text and graphics

Flexible Paper Handling

- Adjustable Tray 1 for letterhead, envelopes, labels, transparencies, custom-sized media, postcards, and heavy paper. See “Loading Media into Tray 1” on page 31.
- Adjustable Tray 2 or an optional 250-Sheet Input Tray (Tray 3) for standard sizes of paper. See “Reloading Media into Tray 2 or Optional Tray 3” on page 32.
- Two output bins: select either the top output bin or the rear output bin for the most convenient output location.
- Straight-through paper path capability from Tray 1 to the rear output bin.

Expandability

- Optional Tray 3 with a 250-sheet capacity to increase the time before it is necessary to add paper.
- Enhanced Input Output (EIO) cards. See “Interface Ports” on page 22.
- Dual In-line memory module (DIMM) slots for adding memory.
- PostScript™ Level 2 Emulation (PS) DIMM adds PS printing. Factory installed on the 2100 M and 2100 TN.

PCL Printer Language and Fonts

- Fast printing performance, built-in Intellifont and TrueType scaling technologies, built-in HP-GL/2 vector graphics, and advanced imaging capabilities are benefits of the PCL 6 printer language. This also includes 45 scalable TrueType fonts and one bitmapped Line Printer Font.

PS Language and Fonts

- The HP LaserJet 2100 M and 2100 TN printers include the HP PS Level 2 printer language emulation with 35 built-in PS language fonts.

-
- Automatic Language Switching**
- When optional printer languages (such as PS emulation) are installed, the printer automatically determines and switches to the appropriate language for the print job.
-
- Wireless Infrared Printing**
- Fast infrared (IR) printing when printing from an IrDA-compliant device, such as a laptop, notebook computer, or a Personal Digital Assistant (PDA).
 - JetSend IR enabled devices can also use the IR port.
-
- Interface Connections**
- Bidirectional ECP type-B parallel port (IEEE-1284 compliant)
 - LocalTalk port
 - EIO Slot
 - Wireless Infrared port (IrDA compliant)
-
- Networking**
- The printer provides an EIO Slot for HP JetDirect 600 N print servers for fast and easy connectivity.
 - Use in Workgroups to provide flexibility, fast printing through the network, and remote management.
-
- Enhanced Memory and Memory Expansion**
- The HP LaserJet 2100 printer comes with 4 MB of memory and can be expanded to 52 MB with the three available memory (DIMM) slots. Most documents can be printed using the standard amount of printer memory through the aid of Memory Enhancement technology (MEt). MEt automatically compresses data, virtually doubling the printer's memory and allowing more complex printing with available memory.
 - The HP LaserJet 2100 M and 2100 TN printers come with 8 MB of memory and can be expanded to 40 MB with the two available memory (DIMM) slots. The third slot is used for the HP PS language DIMM.
-
- Energy Savings**
- The printer automatically conserves electricity by substantially reducing power consumption when not printing.
 - As an ENERGY STAR partner, Hewlett-Packard Company has determined that this product meets ENERGY STAR guidelines for energy efficiency.
-
- Economical Printing**
- EconoMode (600 dpi only), manual duplexing, and N-up printing let you save paper, toner, and time.
 - For tips on reducing the amount of paper use or extending the life of the toner cartridge, see "Printing Tasks" starting on page 35.

Printer Software

The printer comes with helpful software including printer drivers and optional software. The printer drivers (Windows) and PPDs (Macintosh and Windows) provided must be installed to take full advantage of the printer's features.

This section provides information in the following areas:

- Printer Software Installation Instructions
- Overview of Printing System Components
- Printer Software Installation Tips

Once you have followed the installation instructions and loaded the software, refer to the printer software tasks on page 44 on how to get the most out of your printer.

Note

HP software is not available in all languages.

Check the ReadMe file provided on the compact disc or floppy disk for additional software included and supported languages. The most recent drivers, additional drivers, and other software are available from the Internet and other sources. If you do not have access to the Internet, see the HP Support pages at the front of this user guide to obtain the most recent software.

The HP LaserJet 2100 Series printer comes with drivers for the following platforms and operating environments. Find your operating system and follow the instructions to start the installation.

- "Windows Installation" on page 5
- "Macintosh Installation" on page 10 (HP LaserJet 2100 M)
- "DOS Installation" on page 12

Windows Installation

1. Run the install program by following the instructions for your Windows version.

Windows Version	To start installation:
Windows 9x/NT 4.0	<ol style="list-style-type: none">a. Place compact disc in the CD-ROM drive. Install will start automatically.b. Follow the on-screen instructions. If the CD-ROM drive does not automatically run: Select Run from the Start menu, and type <code>x:\setup</code> in the Open box (where x is the drive letter for the CD-ROM drive). Then follow the remaining installation instructions.
Windows 3.x	<ol style="list-style-type: none">a. Place the compact disc in the CD-ROM drive.b. From the File menu, select Run.c. Type <code>x:\setup</code> (where x is the drive letter of your CD-ROM drive).d. Follow the on-screen instructions.

Note

If you don't have a CD-ROM drive, see page 13 for instructions.

2. Select installation type. The installer provides three options for software installation.

- **Typical** (recommended method): This option loads printer drivers, screen fonts, HP FontSmart, an uninstaller, and a configuration utility that will allow you to control all printing aspects.
- **Minimal** (for laptops and minimal installation): This option loads only the required printer driver and screen fonts.
- **Custom** (for experienced users and network administrators): This option allows you to choose which components will be installed. The installation program will prompt you to select the software items you wish to install. You must install at least one printer driver to use your printer.

3. Register your printer with HP.

If you have access to the World Wide Web, please take a moment to complete the registration for your HP LaserJet 2100 at the following website:

http://www.hp.com/go/lj2100_register

This will help Hewlett-Packard better provide support for your printer. After registering, you will have the option to receive valuable business tools. Hewlett-Packard will not contact you or send you information unless you explicitly approve it during the registration process. You may also register with the reply card included with your printer.

Software for Windows

Printer Drivers

Printer drivers access the printer's features and allow the computer to communicate with the printer. Choose a printer driver based on the way you use the printer.

- Use the PCL 6 driver to take full advantage of the printer's features. Unless complete backward compatibility with previous PCL drivers or older printers is necessary, the PCL 6 driver is recommended.
- Use the PCL 5e driver if you need print results to look consistent with those from older HP LaserJet printers. Certain features are not available in this driver. (Do not use the PCL 5e driver provided with this printer with older printers.)
- Use the PS driver for compatibility with PS needs. Certain printer features are not available in this driver.

If your printer has PS capabilities, the printer automatically switches between PS emulation and PCL printer languages depending on the driver you have selected.

Each printer driver has help screens that can be activated from the Help button, the F1 key, or a question mark symbol in the upper right corner of the printer driver (depending on the Windows operating system used). These help screens give detailed information about the specific driver. Printer driver help is separate from the software application help.

Note

For driver only or OEM setup, see the Readme on the installation CD.

HP FontSmart

Access HP FontSmart from the HP LaserJet folder or through the Start menu. HP FontSmart is a font management utility (for Windows only) which does the following:

- Installs, uninstalls, and deletes fonts.
- Manages fonts inside a single window by allowing you to drag-and-drop.
- Shows the matching screen fonts for the internal fonts in the printer.

HP LaserJet Configuration Utility (Windows 9x/NT 4.0 only)

The HP LaserJet configuration utility manages printer default settings. It allows you to access many of the printer's features, including:

- Printing PCL and PS test, font, and demo pages.
- Selecting page setup defaults.
- Choosing custom settings, such as reprint or tray locking.
- Setting resource options, such as IO buffering.

HP JetAdmin (CD-ROM only)

HP JetAdmin is designed to be used primarily by network administrators who are responsible for installing, configuring, troubleshooting, and maintaining printers and other devices on the network. Users may also use the status messages reported by HP JetAdmin to perform common troubleshooting (paper jams, paper out, etc.) and to confirm the current status of the printer on the network. HP JetAdmin can be accessed by clicking the Start button, pointing to Settings, and then clicking Control Panel in Windows 9x and Windows NT 4.0, or from the HP JetAdmin Utilities program group folder in Windows 3.x. Use HP JetAdmin to do the following:

- Install, configure, and manage printers on a network that are connected with a HP JetDirect 600 N print server.
- Perform in-depth diagnostics on the printer and network.

The HP JetAdmin software works on the following network systems:

- Windows NT
- Windows 9x
- SunOS*
- Novell NetWare

- Windows NT
- HP-UX*
- Windows 3.x (Requires Novell NetWare Server)
- Windows 9x
- Solaris*
- OS/2*

*The software for these systems is not included on the compact disc with the printer, but is available from the Internet. If you do not have access to the Internet, see the HP Support pages at the front of this user guide to obtain this software.

Note

Network Administrators: If the printer is attached to a network, before you can print, the printer must be configured for that network using HP JetAdmin or similar network software.

HP JetSend (CD-ROM - Windows 9x/NT 4.0 only)

HP JetSend is a new technology from Hewlett-Packard that allows devices to communicate with each other simply and directly. HP JetSend is built into your printer, allowing it to receive information from any JetSend-enabled sending device anywhere on your network, whether in the same office, or at a remote location. Your printer also has infrared capabilities, allowing it to receive information from any JetSend-enabled infrared device. Examples of JetSend sending devices include PC's or laptops running JetSend software, or scanners with JetSend built in. JetSend uses simple IP addressing between networked devices, and "Point and shoot" between infrared devices.

Visit the JetSend web site (www.jetsend.hp.com) for additional information on JetSend and JetSend software for the PC. JetSend allows you to exchange intra-company documents directly between PCs and between PCs and any JetSend-enabled printer, without the problems of incompatible software applications or versions. JetSend software will allow your colleagues to create documents on their PCs and send copies directly to this printer without any device-specific drivers or configuration difficulties.

You can visit the JetSend web site to learn which other devices are available to communicate easily and directly with your JetSend-enabled printer.

How the JetSend Communications Technology Works

Networked Devices

To use the JetSend capability between networked devices (1) print a configuration page to find your JetSend IP address and (2) give your address to anyone who wishes to send information to your printer via JetSend.

From a JetSend sending device, a person only needs to enter the IP address of the printer and press "send."

Infrared Devices

To use the JetSend infrared capability, simply (1) line up the infrared sensors between the sending and receiving devices, and (2) choose the "send" option on the sending device.

The devices, because they have JetSend in them, will automatically negotiate the best possible outcome.

HP JetSend Software is not currently available for the Macintosh.

Macintosh Installation

1. **Run the install program by placing the compact disc in the CD-ROM drive. The installation window will appear on the desktop. Select the correct language and double-click the installer icon.**

Note

Virus protection must be turned off prior to starting the installation program.

The compact disc contains software for many international locales. Once you select the installation language and double-click Install in the desired language, the installation screen will appear in that language.

2. **Select installation type. The installer provides two options for software installation.**
 - **Typical** (recommended method): This option loads the PPD, screen fonts, and a utility that controls all printing aspects.
 - **Custom** (for experienced users and network administrators): This option allows you to choose which components will be installed. The installation program will prompt you to select the software items you wish to install.

3. **Register your printer with HP.**

If you have access to the World Wide Web, please take a moment to complete the registration for your HP LaserJet 2100 at the following website:

http://www.hp.com/go/lj2100_register

This will help Hewlett-Packard better provide support for your printer. After registering, you will have the option to receive valuable business tools. Hewlett-Packard will not contact you or send you information unless you explicitly approve it during the registration process. You may also register with the reply card included with your printer.

Note

The Apple LaserWriter 8 driver must be installed to use the PPD. To make best use of the features of the printer, use the version of the LaserWriter driver included on the CD.

Software For Macintosh Computers

PostScript Printer Description Files (PPDs)

PPDs, in combination with the LaserWriter driver, access the printer features and allow the computer to communicate with the printer. An installation program for the PPDs, LaserWriter driver, and other software is provided on the compact disc.

HP LaserJet Utility

HP LaserJet Utility allows control over features that are not available in the driver. The illustrated screens make selecting printer features from the Macintosh computer easier than ever. Use the HP LaserJet Utility to do the following:

- Name the printer, assign it to a zone on the network, download files and fonts, and change most of the printer settings.
- Set a password for the printer.
- From the computer, lock out functions on the printer to prevent unauthorized access.

DOS Installation

DOS Remote Control Panel

1. Place the compact disc in the CD-ROM drive.
2. From the DOS prompt, type `x:` (where `x` is the drive letter of the CD-ROM drive), and press Enter.
3. Change to the appropriate language directory (for example: `cd\english`).
4. Type `install` and press Enter.

If DOS applications are going to be used with the printer and the DOS Remote Control Panel was *not* installed, the AUTOEXEC.BAT file needs to be modified to prevent communication timeout errors. To modify the AUTOEXEC.BAT file, use any DOS editor, or any word-processing program that edits ASCII text files, and follow the instructions below.

For DOS versions 4.0 and later, add:

```
MODE LPT1: , , B
```

For DOS versions earlier than 4.0, add:

```
MODE LPT1: , , P
```

Note

The preceding examples assume you are using printer port LPT1. If you are using LPT2 or LPT3, replace LPT1 in the preceding examples with the appropriate printer port number.

Using the Remote Control Panel

The Remote Control Panel (RCP) enables you to change printer settings if the DOS software application does not support the printer feature you want to use. To start the RCP from DOS, follow these steps:

1. Make sure that the RCP is in the computer's path statement. This can be checked by typing `PATH` at a DOS prompt at the root directory and pressing Enter. If the Remote Control Panel directory is not in the path statement, change to the default directory `C:\HPLJUTIL`.
2. At the DOS prompt, type `RCP` and press Enter.
3. For additional information, select Help.

Software Installation Tips

I do not have a CD-ROM drive.

If you have access to another computer with a CD-ROM drive, you can use the MakeDisk utility in Windows to create the disks you need for the installation. Follow the first step of the installation instructions, and choose MakeDisk to create the disks.

If you have internet access, you can download drivers from the World Wide Web or HP's FTP servers. The driver web page is:

<http://www.software.hp.com>

For non-U.S. customers only: Use the floppy disk(s) supplied with the printer to install the software.

If you do not have disks, see "HP Support" in the front of this guide for ordering information.

How do I access printer features?

Some printer features, such as custom paper sizes and page orientation, may be available through your application settings. Use application settings, if available, because they override printer driver settings.

Access advanced printer features through your printer driver. See "Software Tasks" on page 44 for instructions on using specific printer driver features.

What additional drivers and software upgrades are available to me?

The latest printer drivers and printing software for HP LaserJet printers are available on the World Wide Web (<http://www.software.hp.com>). Check the "Readme" file for additional release information.

What other software is available to me?

See “Printer Software” on page 4 for descriptions of the optional printing system software available for installation.

Note

Check the ReadMe file provided on the compact disc for additional software included and supported languages. The most recent drivers, additional drivers, and other software are available from the Internet and other sources. If you do not have access to the Internet, see the HP Support pages at the front of this user guide to obtain the most recent software.

How do I remove the printing software?

In Windows, after installation, the Uninstall icon in the HP LaserJet program group allows you to select and remove any or all of the Windows HP printing system components.

Starting the Uninstaller:

1. In the HP LaserJet Program Group, double-click the Uninstall icon.
2. Click Next.
3. Select the HP printing system components you want to uninstall.
4. Click OK.
5. Follow the prompts.

Control Panel

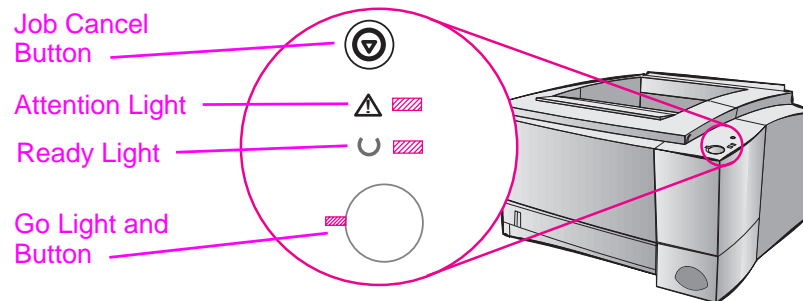

Button Usage

The printer has two buttons: **JOB CANCEL** and **Go**.

Job Cancel

Press **JOB CANCEL** to cancel a job the printer is currently printing. The control panel lights will cycle while the print job is cleared from both the printer and the computer, and then return to ready. This may take some time, depending on the size of the print job.

- If **JOB CANCEL** is accidentally pushed, the job must be reprinted. There is no undo function.
- If **JOB CANCEL** is pushed when the printer is idle, the top panel status lights will cycle, but nothing else will happen.

Go

- Press **Go** to resume printing when the printer is paused or when unprinted data is still in the printer.
- Press **Go** to clear some printer errors.
- Press **Go** to print a demo page. The printer must be in the ready state.

Light Patterns

Light patterns provide both status and error messages. The lights can be in any one of the following states:



Control Panel Light Messages

The following control panel messages indicate various conditions of the printer in preparation for, or during, printing. If the Attention light is on, the printer is experiencing an error. See “Troubleshooting Error Messages” on page 99.

Startup

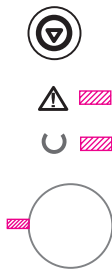

The Go, Ready, and Attention lights cycle one after another.



The buttons have no effect until the printer is ready.

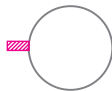

Ready

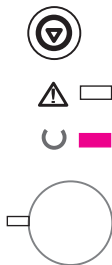

The Ready light is on and the printer is ready to print.



No action is needed.



Pressing the Go Button will print a demo page.



Processing

The printer is receiving or processing data.



Pressing **JOB CANCEL** cancels the current job. One or two pages may print as the printer clears the print job. The printer will return to the ready state after the job has been canceled.

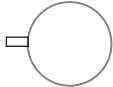

Data

The Ready light is blinking and the Go light is on.



Data is in the printer memory waiting to be printed. Pressing the **Go** button prints from Tray 1 or from another tray if Tray 1 is empty and the paper size is supported in the other Tray.



Pressing the **JOB CANCEL** button cancels the current job and the printer returns to ready.

Manual Feed with Pause



The Go light is blinking. Pressing the **Go** button prints from Tray 1 or from another tray if Tray 1 is empty.



Pressing the **JOB CANCEL** button cancels the current job and the printer returns to ready.





Paper Out

The attention light is on.

The printer is out of paper. The attention light will stay on until paper is added.

Pressing the **GO** or **JOB CANCEL** button has no effect.



Paper Out (requested tray)

The **Go** light is on.

The requested tray is out of paper. Adding paper to the requested tray causes the printer to start the print job from that tray.

Pressing the **Go** button prints from another tray.

Pressing the **JOB CANCEL** button cancels the current job.

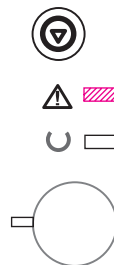

Attention

The printer requires attention for one of the following circumstances:

- door open
- toner cartridge missing
- paper jam

Pressing the **Go** button causes the printer to attempt to clear the paper jam.

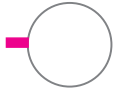

Continuable Error

Pressing the **Go** button causes the printer to attempt to recover from the error and print whatever it can. If the recovery is unsuccessful, the printer will return to the continuable error state. See “Continuable Error” on page 100.

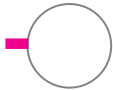

Service Error

The printer has experienced an error and cannot recover. All of the lights are on. See “Service Error” on page 101.



Accessory Error

The printer has experienced an error and cannot recover. All of the lights are blinking in unison. See “Accessory Error” on page 101.

Printing with the Infrared Port (Wireless Printing)

The infrared (IR) port is located on the lower right corner of the printer. This port is compliant with the specifications determined by the Infrared Data Association (IrDA). On the right side of the IR port is a status light that indicates when the port is active. The IR port transmits data at speeds of up to 4 MB per second. When the IR connection is established, the IR status light comes on. If the connection is broken, or when the print job is complete, the IR status light goes off.

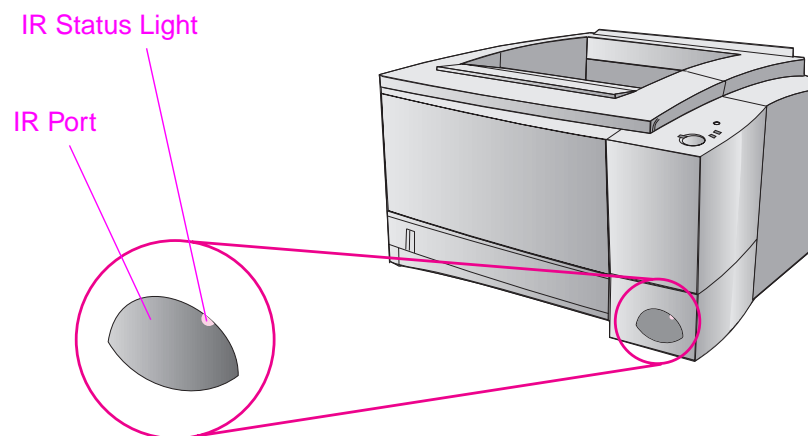

To use the IR port, you need the following:

- A computer or Personal Digital Assistant (PDA) equipped with an IrDA-compliant IR port.
- An infrared port driver that allows printing from the computer to the printer using the IR port and the IrDA communication protocol.
- A printer driver to generate data that the printer can print.

Note

Check with your hardware or operating system manufacturer for the correct port driver.

Printing Instructions

1. Make sure the printer is in ready state (Ready light on).
2. Align an IrDA-compliant computer within 1 meter (3 feet) of the IR port. Ensure that the ports are facing each other with no more than a 15° angle to either the left and right or above and below. Send the print job from the computer. The IR status light will turn on when the connection has been made.

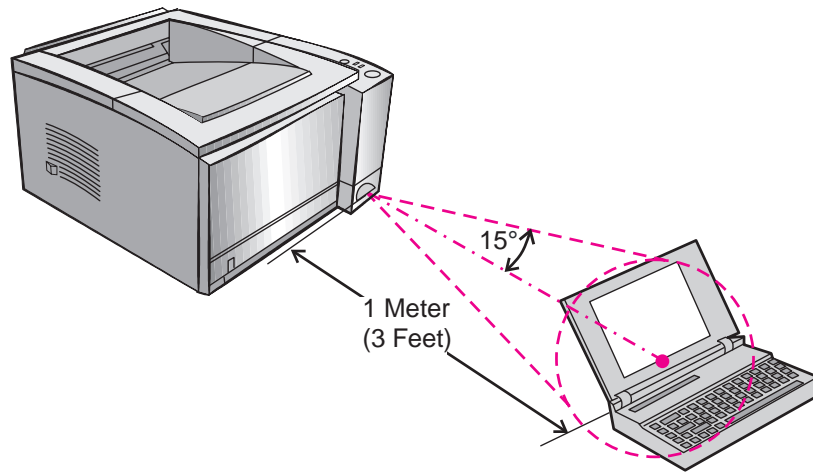

Interface Ports

The HP LaserJet 2100 and the 2100 M printers include two interface ports: an IEEE-1284 parallel and a LocalTalk port.

The HP LaserJet 2100 TN printer also includes an HP JetDirect 600 N print server card that includes a 10Base-T (RJ-45) port.

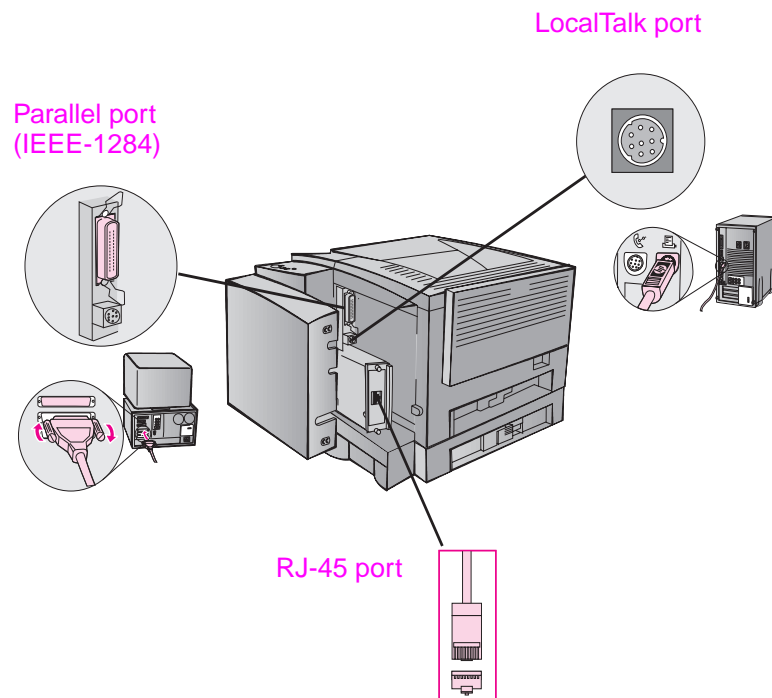

Accessories and Ordering Information

The following list of accessories was current at the time of printing. Ordering information and availability of the accessories may change during the life of the printers.

Accessories		
Option	Description or Use	Part Number
Toner Cartridge		
Toner cartridge	UltraPrecise toner cartridge Pallet Quantity	C4096A C4097A
Memory and Language		
Memory upgrades	The HP LaserJet 2100 printer comes with 4 MB of memory and can be expanded to 52 MB with the 3 available memory (DIMM) slots. The HP LaserJet 2100 M and 2100 TN printers come with 8 MB of memory and can be expanded to 40 M1B with the 2 available memory (DIMM) slots.	4 MB C4135A 8 MB C4136A 16 MB C4137A
HP PS DIMM	The PS DIMM includes 4 MB of memory. This comes installed in the HP LaserJet 2100 M and 2100 TN printers.	C3098A

Accessories (continued)

Option	Description or Use	Part Number
---------------	---------------------------	--------------------

Cable and Interface Accessories

HP JetDirect 600 N EIO Print servers	Ethernet (10Base-T)	J3110A
	Ethernet (10Base-T,10Base2 LocalTalk)	J3111A
	TokenRing (RJ-45 and DB9)	J3112A
	Fast Ethernet (10/100Base-TX, RJ-45)	J3113A
Parallel Cables (IEEE-1284)	A=host computer connector (A-type)	2 Meter A to B C2950A
	B=large printer connector (B-type)	3 Meter A to B C2951A
LocalTalk Network Kit for Macintosh	Connect to a LocalTalk Network	92215N
Serial printer cable for Macintosh	Connect to a Macintosh computer	92215S

Paper Handling Accessories

250-Sheet Input Tray (Tray 3) and Feeder Unit	Tray (for Letter, Executive, Legal, A4, A5, B5 (ISO), B5 (JIS), and 8.5 by 13 inch paper sizes) The optional Tray 3 comes with the 2100 TN printer.	C4793A
Tray 2 or optional Tray 3 replacement	Tray (for Letter, Executive, Legal, A4, A5, B5 (ISO), B5 (JIS), and 8.5 by 13 inch paper sizes)	RG5-4137

Media Accessories

HP Multi-purpose Paper	HP brand paper for a variety of uses (1 box of 10 reams, 500 sheets each). To order a sample, in the U.S. call 1-800-471-4701.	HPM1120
HP LaserJet Paper	Premium HP brand paper for use with HP LaserJet printers (1 box of 10 reams, 500 sheets each). To order a sample, in the U.S. call 1-800-471-4701.	HPJ1124

Accessories (continued)

Option	Description or Use	Part Number
HP LaserJet Labels	Letter (8.5 by 11 in.) white labels Letter (8.5 by 11 in.) clear labels A4 (210 by 297 mm) white labels A4 (210 by 297 mm) clear labels	Call an authorized HP dealer for label sizes and availability.
Transparency Film	Letter (8.5 by 11 in.) transparency film A4 (210 by 297 mm) transparency film	92296T 92296U

Supplementary Documentation

<i>HP LaserJet Printer Family Paper Specification Guide</i>	A guide to using paper and other print media with HP LaserJet printers	5040-9092
<i>HP LaserJet 2100, 2100 M, and 2100 TN Printers User Guide</i>	An additional copy of this user guide	C4170-90901

To order HP LaserJet accessories and options see the "Worldwide Sales and Service Offices" on page 124 for authorized HP dealers.

2 Printing Tasks

Overview

This chapter explains your printing options and gives common printing tasks:

- Preparing for Printing
- Media Input Options
- Loading Media into Tray 1
- Reloading Media into Tray 2 or Optional Tray 3
- Changing Paper Size in Tray 2 or Optional Tray 3
- Printing Tasks
- Canceling a Print Job
- Software Tasks

Preparing for Printing

Purchasing Paper and Other Media

HP LaserJet printers produce excellent print quality documents. You can print on a variety of print media, such as paper (including up to 100% recycled fiber content paper), envelopes, labels, overhead transparencies, and custom-sized media. Properties such as weight, grain, and moisture content are important factors affecting printer performance and output quality.

To achieve the best possible print quality, use only high-quality, copier-grade paper. See Appendix B for more detailed media specifications.

Note

Always test a sample of paper before purchasing large quantities. Your paper supplier should understand the requirements specified in the *HP LaserJet Printer Family Paper Specification Guide*. See “Supplementary Documentation” on page 25.

Media Input Options

The printer comes with two paper trays. By default, the printer draws first from Tray 1. If Tray 1 is empty, the printer draws from Tray 2 (or optional Tray 3 if it is installed).

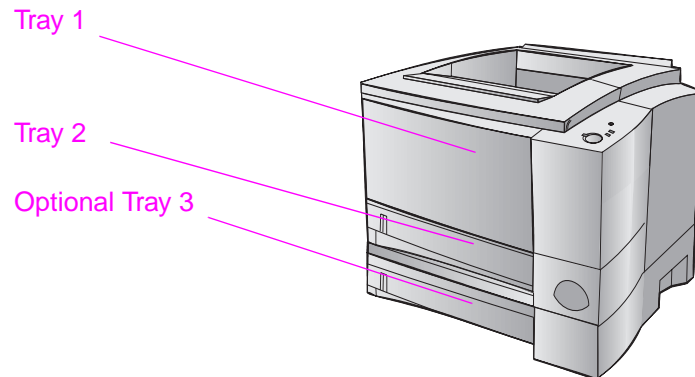

Tray 1 Media Sizes

Tray 1 adjusts for sizes from 76 by 127 mm (3 by 5 in.) to a legal-size sheet, 216 by 356 mm (8.5 by 14 in.). Tray 1 should be used when printing:

- Envelopes (see page 35)
- Labels (see page 37)
- Transparencies (see page 38)
- Custom-sized media or cardstock (see page 39)
- Postcards (see page 39)

Tray 2 and Optional Tray 3 Paper Sizes

Tray 2 and optional Tray 3 have settings for the following paper sizes:

- A4
- A5
- B5 (ISO and JIS)
- Letter
- Legal
- Executive
- 8.5 by 13 in.

See “Changing Paper Size in Tray 2 or Optional Tray 3” on page 33 to change the paper size. See “Supported Sizes of Paper” on page 140 for specific dimensions.

CAUTION

Use only paper from Tray 2 or optional Tray 3. Other types of printable media may jam if printed from Tray 2 or optional Tray 3.

Loading Media into Tray 1

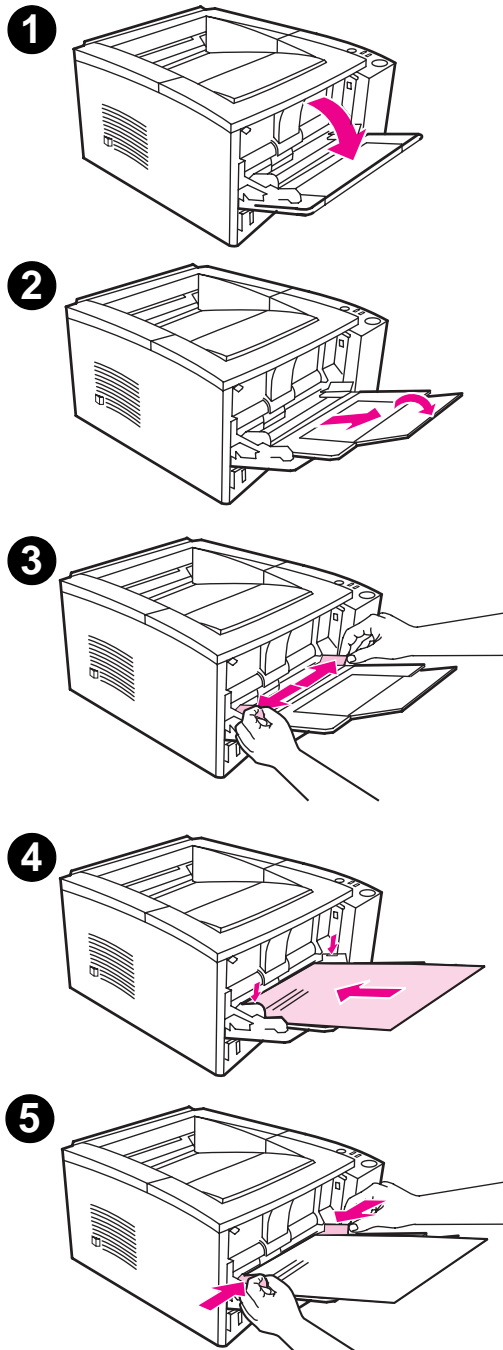

Tray 1 (multi-purpose) holds up to 100 sheets of paper or up to 10 envelopes.

- 1 Open Tray 1 by pulling the front cover down.
- 2 Slide out the plastic tray extender. If the media being loaded is longer than 229 mm (9 in.), also flip open the tray extender.
- 3 Slide the paper width guides slightly wider than the media.
- 4 Place media into the tray (short-edge in, print-side up). The media should be centered between the paper width guides and under the tabs on the paper width guides.
- 5 Slide the paper width guides inward until they lightly touch the media stack on both sides without bending it. Make sure the media fits under the tabs on the paper width guides.

Note

Do not add media to Tray 1 while the printer is printing. This could cause a paper jam.

For preprinted material, see "Letterhead or Preprinted Forms Orientation" on page 42.

Reloading Media into Tray 2 or Optional Tray 3

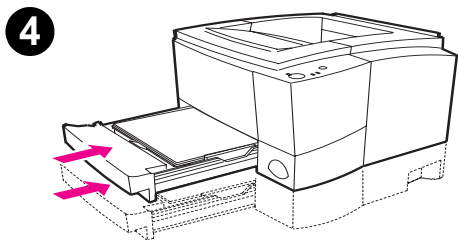
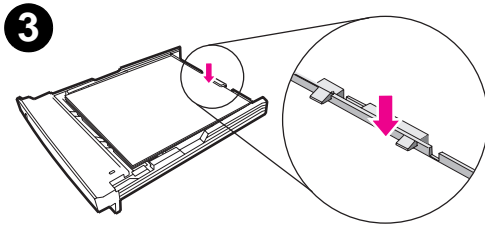
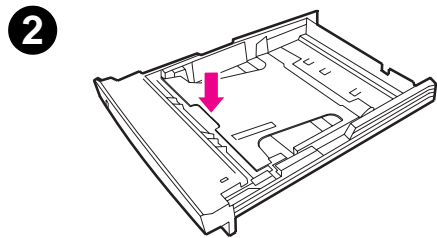
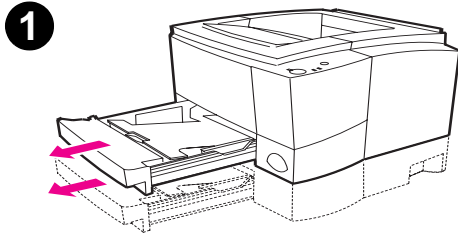

- 1 Pull the desired tray out of the printer.
- 2 Push down on the metal paper lift plate to lock it in place.
- 3 Add the media and make sure it is flat in the tray at all four corners. Keep the media below the height tabs on the paper length guide in the rear of the tray.
- 4 Slide the tray back into the printer.

Note

Whenever you remove a tray from the printer, always push down the metal paper lift plate before you put it back. The metal paper lift plate releases and lifts the paper up when you push the tray into the printer.

Changing Paper Size in Tray 2 or Optional Tray 3

1

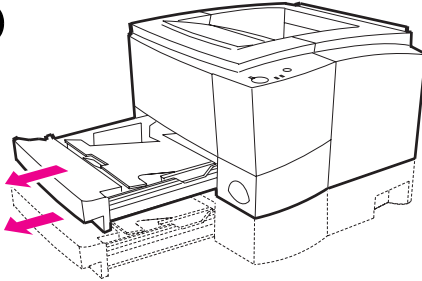

- 1 Pull the desired tray out of the printer and remove any paper.
- 2 Press on the blue tab on the rear paper length guide to adjust for the paper length.
- 3 Adjust the paper length guide so the pointer matches the desired paper size.
- 4 Move the side width guides outward as far as possible.
- 5 Push down on the metal lift plate to lock it in place.

2

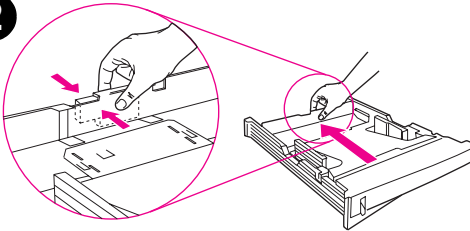

3

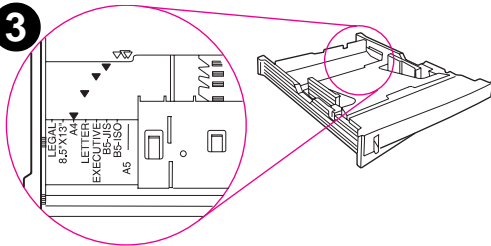

4

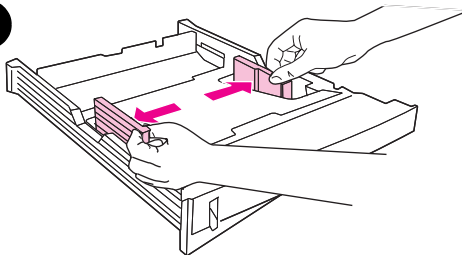

5

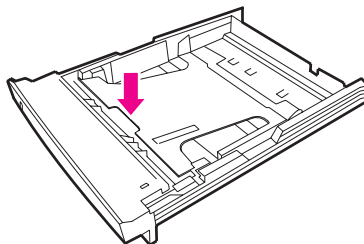

Continued on next page.

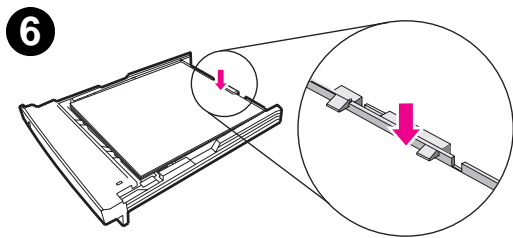

6 Load up to 250 sheets into the paper tray. Make sure the paper is flat in the tray at all four corners. Keep the media below the height tabs on the paper length guide in the rear of the tray.

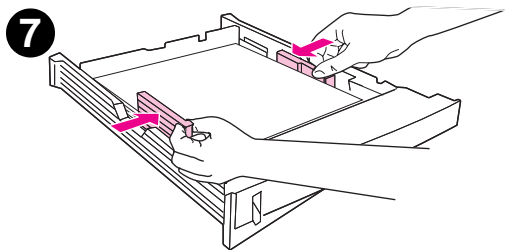

7 Move the paper width guides inward so they touch the media on each side. The paper width guides will click into place for all sizes supported by the tray.

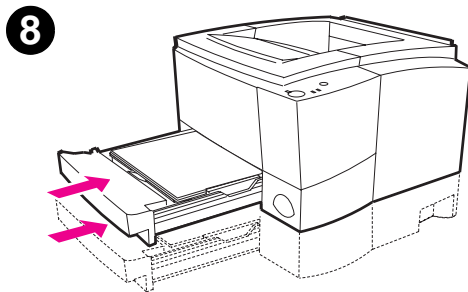

8 Slide the tray back into the printer.

Printing Tasks

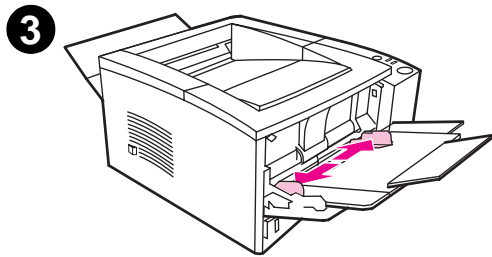
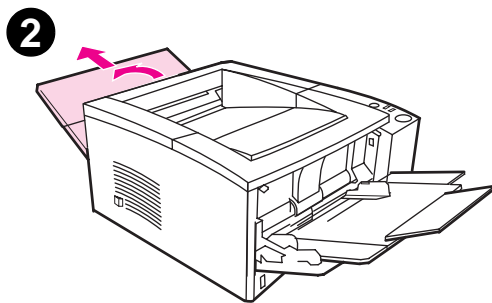
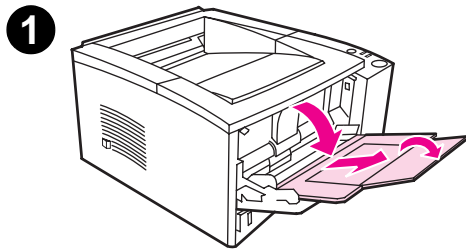

Printing on Envelopes

CAUTION

Before you load envelopes in Tray 1, make sure they are undamaged and are not stuck together. Never use envelopes with clasps, snaps, windows, coated linings, self-stick adhesives, or other synthetic materials. See Appendix B for media specifications.

- 1 Open Tray 1 by pulling the front cover down.
 - 2 Open the rear output bin by pulling down on the top section of the bin. Slide out the extender until it extends fully.
-

Note

Using the rear output bin reduces envelope curl.

- 3 Slide the width guides on Tray 1 outward slightly wider than the media.

Continued on next page.

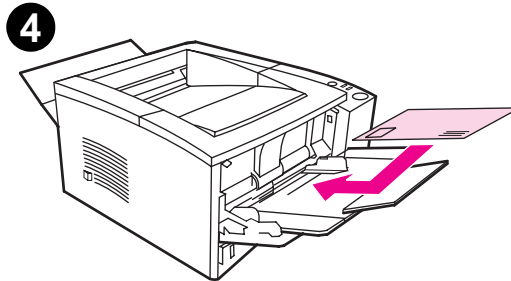

4 Place the envelopes into the tray short-edge in, print-side up. The stamp end must enter the printer first.

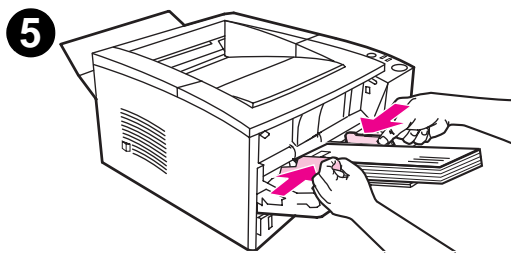

5 Slide the width guides inward until they lightly touch the envelope stack without bending it. The envelopes should be centered between the paper guides and under the tabs on the paper width guides.

Note

If the envelope has a flap on the short edge, this edge must enter the printer first.

You may experience some paper jams when using any media with a length less 178 mm (7 in.). This may be caused by paper that has been effected by environmental conditions. For optimum performance, make sure you are storing and handling the paper correctly. Please refer to "Printing and Paper Storage Environment" on page 144. Using media from another manufacturer may also help.

Printing on Labels

Only use labels recommended for laser printers, such as HP LaserJet labels. See “Labels” on page 148 for specifications.

- Print labels from Tray 1.
- Load labels print-side up.
- Use the rear output tray for labels.
- Remove label sheet from the output bin as they are printed to prevent them from sticking together.

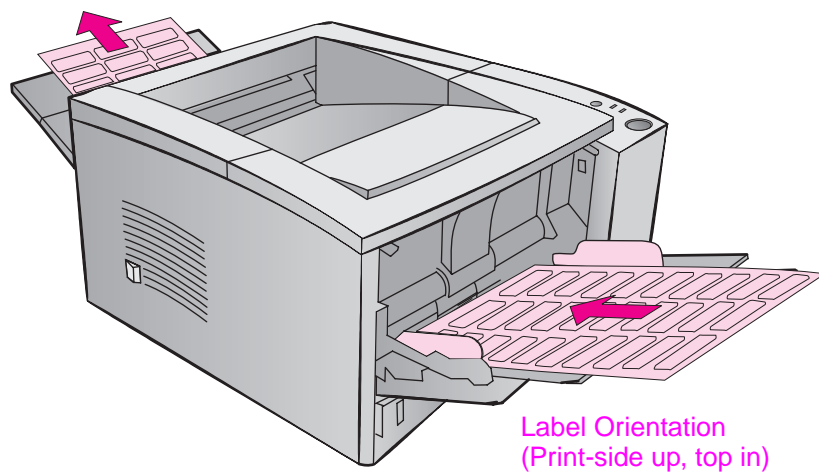

- Do not use labels that are separating from the backing sheet or are wrinkled or damaged in any way.
- Do not use label sheets with the backing sheet exposed or partially used label sheets.
- Do not feed a sheet of labels through the printer more than once. The adhesive backing is designed for one pass through the printer.

CAUTION

If a sheet of labels becomes jammed in the printer, remove the toner cartridge and then see “Clearing Paper Jams” on page 85 to remove the jammed labels.

Printing on Transparencies

Only use transparencies recommended for use in laser printers, such as HP transparency film. Ordering information is located on page 25. Appendix B lists transparency specifications on page 149.

- Print transparencies from Tray 1.
- Use the top output tray to reduce curling (this is for transparencies only; for other media use rear output tray to reduce curling).
- To prevent transparencies from sticking together, remove any transparencies in the output tray as they are printed.
- Place transparencies on a flat surface after removing them from the printer.

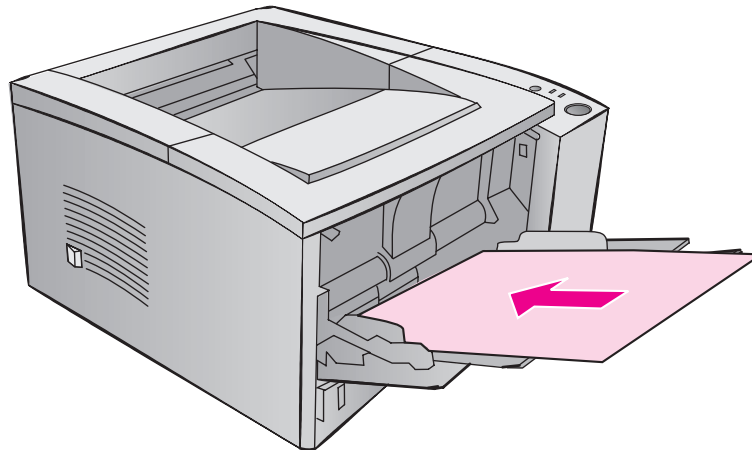

Printing on Custom-Sized Media or Cardstock

Postcards, 3 by 5 in. (index) cards, and other custom-sized media can be printed from Tray 1. The minimum media size is 76 by 127 mm (3 by 5 in.) and the maximum media size is 216 by 356 mm (8.5 by 14 in.).

Note

You may experience some paper jams when using any media with a length less 178 mm (7 in.). This may be caused by paper that has been effected by environmental conditions. For optimum performance, make sure you are storing and handling the paper correctly. Please refer to “Printing and Paper Storage Environment” on page 144. Using media from another manufacturer may also help.

Custom-Sized Media and Cardstock Guidelines:

- Always insert the short-edge first into Tray 1. If you want to print in landscape mode, make this selection through your software. Inserting paper long-edge first may cause a paper jam.
- Use the rear output tray to reduce curl.
- Do not print on media smaller than 76 mm wide (3 in.) or 127 mm (5 in.) long.
- Set margins at least 6.4 mm (.25 in.) away from the edges of the media in the software application.

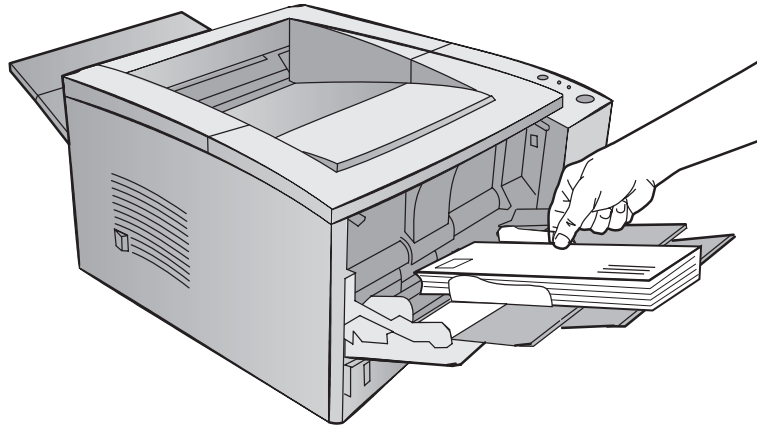

See Appendix B starting on page 139 for media specifications.

Printing on Both Sides of Media (Manual Duplexing)

- Print the first side of the media as you would normally.
- Print the second side from Tray 1, making sure the printed side is facing down with the top-edge toward the printer.
- The PS Windows 9x and the Windows NT 4.0 printer driver as well as some software applications include “odd pages” and “even pages” printing. To use this option, flip down the rear output bin so that the paper will be stacked in the correct order. Print the even pages first as you would normally. Next, put the stack with the blank side up, top-edge toward the printer in Tray 1. Close the rear bin and print the odd pages.

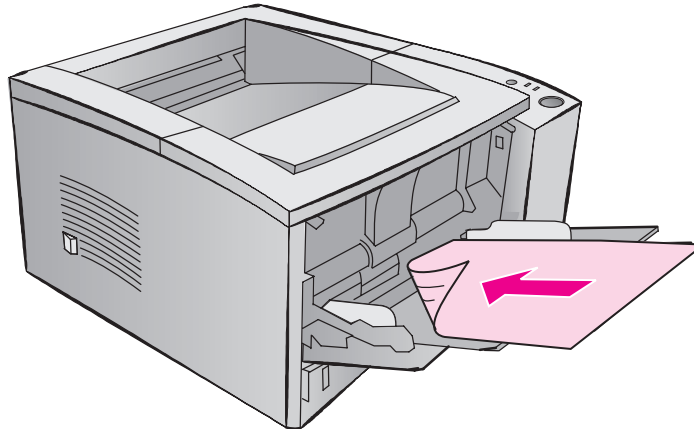

Note

When the second side is printing, you may experience a higher frequency of paper misfeeds, paper jams, and multi-feeds. Using the rear output bin may reduce these problems. The print quality may be different on the second side of the media.

Long and Short Edge Manual Duplexing

There are two ways to manually duplex, long edge or short edge binding. Long edge manual duplexing prints your document on both sides of the page with the binding on the long edge. Short edge duplexing prints the page with the binding on the short edge.

Long edge binding: Print the second side from Tray 1, making sure the printed side is facing down with the top-edge toward the printer.

Short edge binding: Print the second side from Tray 1, making sure the printed side is facing down with the bottom-edge toward the printer.

Printing on Special Media

Letterhead or Preprinted Forms Orientation

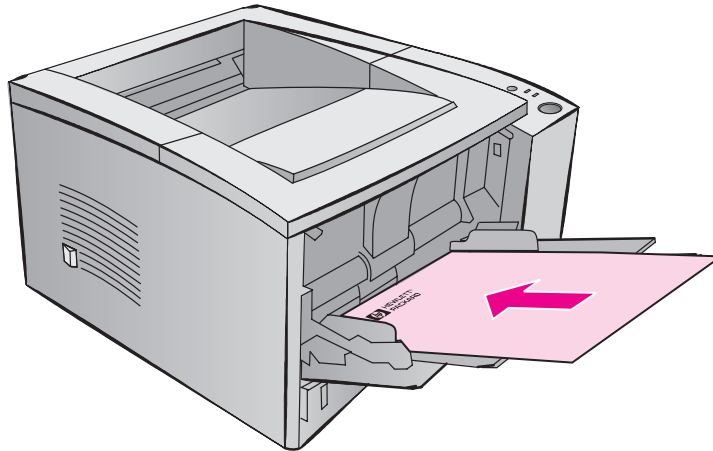

Tray 1 letterhead orientation: print-side up, top-edge toward the printer.

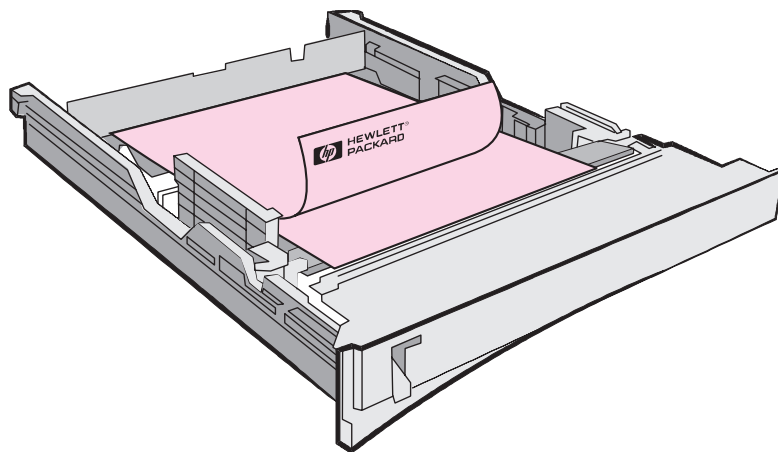

Tray 2 or optional Tray 3 letterhead orientation: print-side down, top-edge toward you.

Canceling a Print Job

A print job can be stopped from a software application, a print queue, or the **JOB CANCEL** button.

- If the printer has not started printing, first try to cancel the job within the software application that sent the print job.
- If the print job is waiting in a print queue or print spooler such as the Print Manager in Windows 3.1 or Print Monitor in Mac, delete the job there.
- If the print job is already printing, press the printer **JOB CANCEL** button. The printer will finish printing any pages that are already moving through the printer and delete the rest of the print job.

If the control panel status lights continue to cycle after a job has been canceled the computer is still sending the job to the printer. Either delete the job from the print queue or wait until the computer has finished sending data. The printer will return to Ready (Go light on).

Job Cancel Tips

Pressing **JOB CANCEL** cancels only the current job in the printer. If more than one print job is in printer memory, **JOB CANCEL** must be pressed once for each job.

Software Tasks

This section lists the common printing tasks that are controlled through the printer software. Some printer drivers do not support all printer features. Use the PCL 6 printer driver to take full advantage of all the printer's features, including:

- Watermarks
- Custom Paper Size
- EconoMode
- Reduce/Enlarge
- Resolution Enhancement technology (REt)
- Quick Sets
- Custom Print Quality Settings
- Selecting Paper Source
- Restoring Defaults
- Printing Multiple Pages on One Sheet of paper (N-up printing)

Accessing the Printer Driver

After installation, you can access the printer driver through the operating system or from your software application. Although access to the printer driver from your software applications may vary, the printer driver is usually accessed from the File menu.

Note

The method for accessing a printer driver is the same, no matter which printer driver you are using.

Accessing the Driver

Operating System	Temporarily Change Settings (from a software application)	Change Default Settings (across all applications)
Windows 9x/NT 4.0	From the File menu, click Print, and then click Properties. (The actual steps can vary; this is the most common method.)	Click the Start button, point to Settings, and then click Printers. Right-click the printer icon, and choose Properties. Many of the features in NT 4.0 printer drivers are also located on the Document Defaults menu.
Windows 3.x	From the File menu, click Print, click Printers, and then click Options. (The actual steps can vary; this is the most common method.)	From the Windows control panel, double-click Printers, highlight the printer, and click Setup.
Macintosh LaserWriter 8.3	From the File menu, select Print, and click Options.	From the File menu, select Print, and click Options. Click Save to save your changes.
Macintosh LaserWriter 8.4 and higher	From the File menu, select Print. Click the pop-up for options you wish to change.	From the File menu, select Print. Click the pop-up for options you wish to change. Click Save to save your changes.

Using the Printer Driver Help

Each printer driver has help screens that can be activated from the Help button in the printer driver. These help screens give detailed information about the specific driver being used. Printer driver help is separate from the software application help.

Creating and Using Watermarks

The Watermark options allow you to specify that text be placed “underneath” (in the background) of an existing document. For example, you may want to have large gray letters reading “draft” or “confidential” placed diagonally across the first page or all pages of a document.

Note

Watermarks are available only with the HP PCL 6 (Windows), Windows NT 4.0 PS, and LaserWriter printer drivers.

Watermarks

Printer Driver	Procedure
PCL 6 (Windows 3.1/9x)	<p>To use an existing watermark</p> <ol style="list-style-type: none">1. Access the printer driver.2. From the Effects tab, click the Watermarks drop-down list.3. Click the desired watermark.4. Click First Page Only, if desired.5. Click OK. <p>To create or edit a watermark</p> <ol style="list-style-type: none">1. Access the printer driver.2. From the Effects tab, click Edit.3. In the Watermark Details window, select the watermark you want to edit, or click New.4. Select the desired watermark options.5. Click OK.6. From the Effects tab, click First Page Only, if desired.7. Click OK. <p>To stop printing the watermark, click “none” in the Watermarks drop-down list.</p>

Watermarks (continued)

Printer Driver	Procedure
PCL 6 (Windows NT 4.0)	<p>To use an existing watermark</p> <ol style="list-style-type: none">1. Click the Start button, point to Settings, then click Printers. Right-click the printer icon and choose Document Defaults.2. From the Effects tab, click the Watermarks drop-down list.3. Click the desired watermark.4. Click First Page Only, if desired.5. Click OK. <p>To stop printing the watermark, click "none" in the Watermarks drop-down list.</p> <p>To create or edit a watermark</p> <p>If you are running the printer driver from the server, you need administrator rights to save new watermarks.</p> <ol style="list-style-type: none">1. Click the Start button, point to Settings, then click Printers. Right-click the printer icon and choose Document Defaults.2. From the Effects tab, click Edit.3. In the Watermark Details window, select the watermark you want to edit, or click New.4. Select the desired watermark options.5. Click OK.6. From the Effects tab, click First Page Only, if desired.7. Click OK. <p>To stop printing the watermark, click "none" in the Watermarks drop-down list.</p>

Watermarks (continued)

Printer Driver	Procedure
Windows NT 4.0 PS	<p>To use an existing watermark</p> <ol style="list-style-type: none">1. Access the printer driver.2. From the Advanced tab, click Document Options, then Printer Features to expand their subentries.3. Click on each desired Watermark option (Watermark, Watermark Font, Watermark Size, Watermark Angle, Watermark Style, and Print Watermark) and select the desired setting for each option.4. Click OK. <p>To stop printing the watermark, click Watermark and select "none" in the Change 'Watermark' Setting box.</p> <p>The Windows NT 4.0 PS printer driver does not support user-defined watermarks. If you want to create a watermark, use the HP PCL 6 printer driver.</p>
Windows 9x PS	<p>To use an existing watermark</p> <ol style="list-style-type: none">1. Access the printer driver.2. From the Device Options tab, click on each desired Watermark option (Watermark, Watermark Font, Watermark Size, Watermark Angle, Watermark Style, and Print Watermark) and select the desired setting for each option.3. Click OK. <p>To stop printing the watermark, click Watermark and select "none" in the Change 'Watermark' Setting box.</p> <p>The Windows 9x PS printer driver does not support user-defined watermarks. If you want to create a watermark, use the HP PCL 6 printer driver.</p>
Macintosh LaserWriter 8.3	<ol style="list-style-type: none">1. Select Page Setup from the File menu.2. Select Options.3. Click the pop-up for each desired watermark option and select the desired setting.4. Click OK. <p>To stop printing watermarks, select "None" or "Printer's default" from the Watermark/Overlay pop-up.</p>

Watermarks (continued)

Printer Driver	Procedure
Macintosh LaserWriter 8.4 and higher	<ol style="list-style-type: none">1. Select Page Setup from the File menu.2. Click the pop-up and select Watermark/Overlay.3. Click on each desired watermark option and select the desired setting. To use your own text, type text in the custom text box.4. Click print. <p>To stop printing watermarks, select "None" in the layer option.</p>

Printing Multiple Pages on One Sheet of Paper (N-up Printing)

You can select the number of pages you want to print on a single sheet of paper. If you choose to print more than one page per sheet, the pages will appear decreased in size and arranged on the sheet. You can specify up to 9 pages.

N-up Printing

Printer Driver	Procedure
PCL 6 (Windows 3.1/9x)	<ol style="list-style-type: none">1. Access the printer driver.2. From the Finishing tab, click Pages per Sheet.3. Enter the number of pages you want to print per sheet (1, 2, 4, or 9).4. Click Print Page Borders if you want to print a border around each page on the sheet. Print Page Borders is enabled only if Pages per Sheet is set to 2, 4, or 9.5. Click OK.
PCL 6 (Windows NT 4.0)	<ol style="list-style-type: none">1. Access the printer driver.2. From the Finishing tab, click Pages per Sheet.3. Enter the number of pages you want to print per sheet (1, 2, 4, or 9).4. Click Print Page Borders if you want to print a border around each page on the sheet. Print Page Borders is enabled only if Pages per Sheet is set to 2, 4, or 9.5. Click OK.
Windows 9x PS	<ol style="list-style-type: none">1. Access the printer driver.2. From the Paper tab, click 1-, 2-, or 4-up.3. Click OK.

N-up Printing (continued)

Printer Driver	Procedure
Windows NT 4.0 PS	<ol style="list-style-type: none">1. Access the printer driver.2. From the Advanced tab, click Document Options, then Printer Features to expand their subentries.3. Click Pages per Sheet.4. Select the desired option (1, 2, 4, 6, 9, or 16) in the Change 'Pages per Sheet' Setting box. Select the Pages per Sheet orientation to match the orientation of your document. For example, a landscape presentation printed at 4 pages per sheet would use the 4 (Landscape) Pages per Sheet setting.5. Click OK.
Macintosh LaserWriter 8.3	<ol style="list-style-type: none">1. Select Page Setup from the File menu.2. Select Layout.3. Select the desired option (1, 2, or 4).4. Click OK.
Macintosh LaserWriter 8.4 and higher	<ol style="list-style-type: none">1. Select Print from the File menu.2. Select Layout.3. Select the desired option (1, 2, 4, 6, 9, or 16).4. Click OK.

Setting a Custom Paper Size

Use the Custom Paper feature to print on paper sizes other than standard sizes.

Custom Paper Size

Printer Driver	Procedure
PCL 6 (Windows 3.1/9x)	<ol style="list-style-type: none">1. Access the printer driver.2. From the Paper tab, click Custom.3. From the Custom Paper Size window, type the name of the custom paper size.4. Click the desired unit of measure (millimeters or inches). <p>If you enter a size that is too small or too large, the driver will automatically adjust the size for you.</p> <ol style="list-style-type: none">5. Enter the custom paper size length and width.6. Click OK. <p>You can save up to five custom paper sizes for reuse.</p>
Windows NT 4.0	<p>The Windows NT printer drivers do not support custom paper sizes. You may access custom sizes through the operating system.</p> <ol style="list-style-type: none">1. Click the Start button, point to Settings, then click Printers.2. From the File menu, click Server Properties.3. From the Forms tab, click Create New Form.4. Set the custom paper size and margins.5. Click OK.

Custom Paper Size (continued)

Printer Driver	Procedure
Windows 9x PS	<ol style="list-style-type: none">1. Access the printer driver.2. From the Paper tab, scroll to the right of the Paper Size box and click Custom Page.3. Click the Custom button.4. From the Custom-Defined Size window, type the name of the custom paper size.5. Click the desired unit of measure (millimeters or inches).6. Enter the custom paper size length and width.7. Click OK. <p>You can save up to three custom paper sizes for reuse.</p>
Macintosh LaserWriter 8.3	<ol style="list-style-type: none">1. Select Page Setup from the File menu.2. Select Custom.3. Click the paper image to select the paper size.
Macintosh LaserWriter 8.4	<p>The 8.4 version does not support this option. Use the 8.3 version to use custom paper sizes, or check with Apple for updated drivers.</p>
Macintosh LaserWriter 8.5 and higher	<ol style="list-style-type: none">1. Select Page Setup from the File menu.2. Select Custom page Sizes from the Page attributes pop-up.3. Select New to create custom page sizes or select Edit for existing custom pages.4. Click OK.

Creating and Using Quick Sets

Quick Sets allow you to save the current driver settings (for example, page orientation, n-up printing or paper source) for reuse. For convenience, Quick Sets can be selected and saved from most printer driver tabs. You can also restore printer driver default settings by selecting Defaults from the Quick Sets drop-down list.

Note

Quick Sets are available only with the HP PCL 6 printer driver for Windows.

Quick Sets

Printer Driver	Procedure
PCL 6 (Windows 3.1/9x)	Creating Quick Sets <ol style="list-style-type: none">1. Access the printer driver.2. Select the desired print settings.3. In the Quick Sets box, type a name for the selected settings (for example "Quarterly Report" or "My Project Status").4. Click Save.5. When you save Quick Sets, all current driver settings are saved. The printer driver will now remember these settings.6. Click OK. Using Quick Sets <ol style="list-style-type: none">1. Access the printer driver.2. Select the desired item from the Quick Sets drop-down list.3. Click OK. The printer is now set to print according to the settings in the Quick Sets you selected.

Quick Sets (continued)

Printer Driver	Procedure
PCL 6 (Windows NT 4.0)	<p data-bbox="760 457 963 478">Creating Quick Sets</p> <p data-bbox="760 499 1284 548">If you are running the printer driver from the server, you need administrator rights to save new Quick Sets.</p> <ol data-bbox="760 569 1295 926" style="list-style-type: none"><li data-bbox="760 569 1295 674">1. Click the Start button, point to Settings, then click Printers. Right-click the printer icon and choose Document Defaults. You can save Quick Sets from any tab.<li data-bbox="760 684 1110 705">2. Select the desired print settings.<li data-bbox="760 716 1295 800">3. In the Quick Sets box, type a name for the selected settings (for example "Quarterly Report" or "My Project Status").<li data-bbox="760 810 1295 894">4. Click Save. When you save Quick Sets, all current driver settings are saved. The printer driver will now remember these settings.<li data-bbox="760 905 894 926">5. Click OK. <p data-bbox="760 978 935 999">Using Quick Sets</p> <ol data-bbox="760 1020 1276 1140" style="list-style-type: none"><li data-bbox="760 1020 1040 1041">1. Access the printer driver.<li data-bbox="760 1052 1276 1104">2. Select the desired item from the Quick Sets drop-down list.<li data-bbox="760 1115 894 1136">3. Click OK.

Using EconoMode

EconoMode (Save Toner) allows the printer to use less toner on each page. Selecting this option will extend the life of your toner cartridge and reduce your cost per page, but will reduce print quality. This setting is not available with 1200 dpi settings.

EconoMode

Printer Driver	Procedure
PCL 6 (Windows 3.1/9x)	<ol style="list-style-type: none">1. Access the printer driver.2. From the Finishing tab, click EconoMode (Save Toner). If the box is checked, EconoMode is enabled. If the box is empty, EconoMode is disabled.3. Click OK.
PCL 6 (Windows NT 4.0)	<ol style="list-style-type: none">1. Click the Start button, point to Settings, then click Printers. Right-click the printer icon and choose Document Defaults.2. From the Finishing tab, click EconoMode (Save Toner). If the box is checked, EconoMode is enabled. If the box is empty, EconoMode is disabled.3. Click OK.
Windows 9x PS	<ol style="list-style-type: none">1. Access the printer driver.2. From the Device Options tab, click EconoMode.3. Select the desired EconoMode option in the Change Setting in EconoMode drop-down list.4. Click OK.
Windows NT 4.0 PS	<ol style="list-style-type: none">1. Access the printer driver.2. From the Advanced tab, click Document Options, then Printer Features to expand their subentries.3. Click EconoMode.4. Select the desired EconoMode option in the Change 'EconoMode' Setting box.5. Click OK.

EconoMode (continued)

Printer Driver	Procedure
Macintosh LaserWriter 8.3	<ol style="list-style-type: none">1. Select Print from the File menu.2. Click Options.3. Select the desired EconoMode setting.4. Click OK.
Macintosh LaserWriter 8.4 and higher	<ol style="list-style-type: none">1. Select Print from the File menu.2. Click the popup for print options and select Imaging Options.3. In the Imaging Options dialog, select the desired EconoMode setting.4. Click Print.

Choosing Print Quality Settings

The printer's default print quality setting is Best Quality, which uses 1200 dpi to provide the best combination of print speed and print quality. If you need advanced print quality, you can choose custom settings.

Resolution Options:

- **Best Quality** (default) - 1200 dpi for the best print quality.
- **Faster Printing** - 600 dpi, alternate resolution for complex graphics or faster output.
- **Custom** - Allows you to specify print quality settings.

Note

Changing resolution may change the formatting of your text.

Choosing Print Quality Settings

Printer Driver	Procedure
PCL 6 (Windows 3.1/9x)	<ol style="list-style-type: none">1. Access the printer driver.2. From the Finishing tab, click Custom, then Details.3. In the Print Quality Details window, select the desired resolution setting.4. Click OK.
PCL 6 (Windows NT 4.0)	<ol style="list-style-type: none">1. Click the Start button, point to Settings, then click Printers. Right-click the printer icon and choose Document Defaults.2. From the Finishing tab, click Custom, then Details.3. In the Print Quality Details window, select the desired resolution setting.4. Click OK.
Windows 9x PS	<ol style="list-style-type: none">1. Access the printer driver.2. From the Graphics tab, select the desired resolution setting.3. Click OK.

Choosing Print Quality Settings (continued)

Printer Driver	Procedure
Windows NT 4.0 PS	<ol style="list-style-type: none">1. Access the printer driver.2. From the Advanced tab, click Graphics to expand its subentries.3. Click Resolution.4. Select the desired Resolution option in the Change 'Resolution' Setting box. (1200 is the same as best quality in the PCL 6 printer driver.)5. Click OK.
Macintosh LaserWriter 8.3	<ol style="list-style-type: none">1. Select Print from the File menu.2. Click Options.3. In the Print Options dialog, select the desired Print Resolution setting.4. Click OK.
Macintosh LaserWriter 8.4 and higher	<ol style="list-style-type: none">1. Select Print from the File menu.2. Click the pop-up for print options and select Resolution Options.3. In the Resolution Options dialog box, select the desired setting.4. Click Print.

Using Reduce/Enlarge Options

Reduce/Enlarge options allow you to scale your document to a percent of its normal size. You can also choose to scale your document to fit on letter- or A4-size paper.

Reduce/Enlarge

Printer Driver	Procedure
PCL 6 (Windows 3.1/9x)	<ol style="list-style-type: none">1. Access the printer driver.2. From the Effects tab, type the percentage by which you want to reduce or enlarge your document or click Fit to Letter Size or click Fit to A4 Size.3. Click OK.
PCL 6 (Windows NT 4.0)	<ol style="list-style-type: none">1. Click the Start button, point to Settings, then click Printers. Right-click the printer icon and choose Document Defaults.2. From the Effects tab, type the percentage by which you want to reduce or enlarge your document.3. Click OK.
Windows 9x PS	<p>To reduce or enlarge your document</p> <ol style="list-style-type: none">1. Access the printer driver.2. From the Graphics tab, type the percentage by which you want to reduce or enlarge your document in the Scaling box.3. Click OK. <p>To fit your document to letter- or A4-size paper</p> <ol style="list-style-type: none">1. Access the printer driver.2. From the Device Options tab, click Fit to Page.3. Select the desired Fit to Page option in the Change Setting for: drop-down list.4. Click OK.

Reduce/Enlarge (continued)

Printer Driver	Procedure
Windows NT 4.0 PS	<p>To reduce or enlarge your document</p> <ol style="list-style-type: none">1. Access the printer driver.2. From the Advanced tab, click Graphics to expand its subentries.3. Click Scaling.4. Type the percentage by which you want to reduce or enlarge your document in the Change 'Scaling' Setting box.5. Click OK. <p>To fit your document to letter- or A4-size paper</p> <p>This setting works for all paper sizes in the Windows NT 4.0 PS printer driver.</p> <ol style="list-style-type: none">1. Access the printer driver.2. From the Advanced tab, click Document Options, then Printer Features to expand their subentries.3. Click Fit to Page.4. Select the desired option in the Change 'Fit to Page' Setting box.5. Click OK.
Macintosh LaserWriter 8.3	<ol style="list-style-type: none">1. Select Page Setup from the File menu.2. Select Reduce/Enlarge.3. Select the desired settings.4. Click OK.
Macintosh LaserWriter 8.4 and higher	<ol style="list-style-type: none">1. Select Page Setup from the File menu.2. Select Scale.3. Select the desired settings.4. Click OK.

Selecting a Paper Source

If your application supports printing paper by source, make the selections from your application. Application settings override printer driver settings.

Selecting Paper Source

Printer Driver	Procedure
PCL 6 (Windows 3.1/9x)	<ol style="list-style-type: none">1. Access the printer driver.2. From the Paper tab, select the desired Source of paper.3. Click OK.
PCL 6 (Windows NT 4.0)	<ol style="list-style-type: none">1. Click the Start button, point to Settings, then click Printers. Right-click the printer icon and choose Document Defaults.2. From the Paper tab, select the desired Source of paper.3. Click OK.
Windows 9x PS	<ol style="list-style-type: none">1. Access the printer driver.2. From the Paper tab, select the desired Paper Source option in the Paper Source drop-down list.3. Click OK.
Windows NT 4.0 PS	<ol style="list-style-type: none">1. Access the printer driver.2. From the Page Setup tab, select the desired paper source from the Paper Source drop-down list.3. Click OK.
Macintosh LaserWriter 8.3	<ol style="list-style-type: none">1. Select Print from the File menu.2. Choose paper source.3. Select the desired selection.4. Click OK.
Macintosh LaserWriter 8.4 and higher	<ol style="list-style-type: none">1. Select Print from the File menu.2. Click the Paper Source pop-up.3. Select the desired source.4. Click Print.

Using REt

When REt (Resolution Enhancement technology) is on, it refines the print quality of characters by smoothing out jagged edges that can occur on the angles and curves of a printed image. Choose Off if graphics, particularly scanned images, are not printing clearly.

Note

REt is disabled when 1200 dpi settings are selected.

REt

Printer Driver	Procedure
PCL 6 (Windows 3.1/9x)	<ol style="list-style-type: none">1. Access the printer driver.2. From the Finishing tab, click Custom, then Details.3. In the Print Quality Details window, select the REt desired option (On or Off).4. Click OK.
PCL 6 (Windows NT 4.0)	<ol style="list-style-type: none">1. Click the Start button, point to Settings, then click Printers. Right-click the printer icon and choose Document Defaults.2. From the Finishing tab, click Custom, then Details.3. In the Print Quality Details window, select the REt desired option (On or Off).4. Click OK.
Windows NT 4.0 PS	<ol style="list-style-type: none">1. Access the printer driver.2. From the Advanced tab, click Document Options, then Printer Features to expand their subentries.3. Click Resolution Enhancement.4. Select the desired Resolution Enhancement option in the Change 'Resolution Enhancement' Setting box.5. Click OK.

REt (continued)

Printer Driver	Procedure
Windows 9x PS	<ol style="list-style-type: none">1. Access the printer driver.2. From the Device Options tab, select the desired Resolution Enhancement option from the Printer Features drop-down list.3. Select the desired Resolution Enhancement option in the Change setting for 'Resolution Enhancement' drop-down list.4. Click OK.
Macintosh LaserWriter 8.3	<ol style="list-style-type: none">1. Select Print from the File menu.2. Click Options.3. In the Print Options dialog, select the desired Resolution Enhancement setting.4. Click OK.
Macintosh LaserWriter 8.4 and higher	<ol style="list-style-type: none">1. Select Print from the File menu.2. Click the pop-up for print options and select Resolution Options.3. In the Resolution Options dialog box, select the desired Resolution Enhancement setting.4. Click Print.

Restoring Default Printer Driver Settings

Restoring Defaults

Printer Driver	Procedure
PCL 6 (Windows 3.1/9x)	<ol style="list-style-type: none">1. Access the printer driver.2. In the Quick Sets box, click Defaults
PCL 6 (Windows NT 4.0)	<ol style="list-style-type: none">1. Click the Start button, point to Settings, then click Printers. Right-click the printer icon and choose Document Defaults.2. In the Quick Sets box, click Defaults
Windows 9x PS	<ol style="list-style-type: none">1. Access the printer driver.2. Click the Restore Defaults button for each tab where you want to restore default settings.
Windows NT 4.0 PS	The Windows NT 4.0 PS printer driver invokes default settings when an application is started. To restore default printer settings without restarting your application, select another printer driver, then select the Windows NT 4.0 PS printer driver.
Macintosh LaserWriter 8.3	To restore default printer driver settings, delete the "LaserWriter 8 Prefs" file in the Preferences folder in the System folder.
Macintosh LaserWriter 8.4 and higher	<ol style="list-style-type: none">1. Open the Preferences folder.2. Open the Printing Prefs folder.3. Open the Parsed PPD folder.4. In the Parsed PPD Folder, delete the file with the same name as the printer. For example, for a printer called HP LaserJet 2100 M, delete the file HP LaserJet 2100 M.PPD in the following path: HD:System Folder:Preferences:Printing Prefs:Parsed PPD Folder:HP LaserJet 2100 M

Printing on Different Paper for the First Page

Note

Printing on different paper for the first page of a print job is available only with the HP PCL 6 printer and Macintosh LaserWriter driver.

Some applications may also have this feature. Check with the application's help file.

Printing on Different Paper for the First Page

Printer Driver	Procedure
PCL 6 (Windows 3.1/9x)	<ol style="list-style-type: none">1. Access the printer driver.2. From the Paper tab, select the desired paper for the first page of your print job.3. Click Use different paper for first page.4. Click the Other Pages tab.5. Select the desired paper source for the other pages of your print job.
PCL 6 (Windows NT 4.0)	<ol style="list-style-type: none">1. Click the Start button, point to Settings, then click Printers. Right-click the printer icon and choose Document Defaults.2. From the Paper tab, select the desired paper for the first page of your print job.3. Click Use different paper for first page.4. Click the Other Pages tab.5. Select the desired paper source for the other pages of your print job.

Printing on Different Paper for the First Page (continued)

Printer Driver	Procedure
Macintosh LaserWriter 8.3	<ol style="list-style-type: none">1. Select Print from the File menu.2. Select First From and then select the desired tray for the first page from the pop-up menu.3. Select the tray for the rest of the job from the Remaining From pop-up menu.
Macintosh LaserWriter 8.4 and higher	<ol style="list-style-type: none">1. Select Print from the File menu.2. Select First Page From and then select the desired tray for the first page from the pop-up menu.3. Select the tray for the rest of the job from the Remaining From pop-up menu.

Note

The paper size for all pages of the print job must be the same in the driver.

Tray Locking

Tray Locking is a feature that allows you to “lock” a tray so that the only time the printer will draw from that tray is when it is specifically requested. This is useful when you want to put special paper in a tray, such as letterhead. For example, if you are using “First Available Tray,” for the paper source and you lock Tray 1, the printer will only draw from the remaining trays, either Tray 2 or optional Tray 3, if it is installed. You can still print from the locked tray, but you must specify the source.

Note

The feature will not allow you to lock all the trays. One tray must be “unlocked.”

Tray Locking

Printer Utility	Procedure
Windows	<ol style="list-style-type: none">1. Run the HP LaserJet configuration utility or JetAdmin.2. From the Custom tab, select the tray you wish to lock.
Macintosh	<ol style="list-style-type: none">1. Run the HP LaserJet Utility.2. From the Settings Panel, select Input Trays.3. Click on the tray you want to lock.

3 Printer Tips and Maintenance

Overview

This chapter provides suggestions for high-quality and economical printing. It also lists special maintenance tasks for the toner cartridge and the printer.

- Managing the UltraPrecise Toner Cartridge
- Redistributing the Toner
- Cleaning the Printer
- Using the Printer Cleaning Processes

Managing the UltraPrecise Toner Cartridge

HP Policy on Non-HP Toner Cartridges

Hewlett-Packard Company cannot recommend use of non-HP toner cartridges, either new, refilled, or remanufactured. Because they are not HP products, HP cannot influence their design or control their quality.

Toner Cartridge Storage

Do not remove the toner cartridge from its package until you are ready to use it. The shelf life of a cartridge in an unopened package is approximately 2.5 years. The shelf life of a cartridge in an opened package is approximately 6 months.

CAUTION

To prevent damage to the toner cartridge, do not expose it to light for more than a few minutes.

Toner Cartridge Life Expectancy

The life of the toner cartridge depends on the amount of toner that print jobs require. When printing text at 5% coverage, an HP LaserJet 2100 toner cartridge lasts an average of 5,000 pages. This assumes the print density is set to 3 and EconoMode is off. (These are the default settings.)

Recycling Toner Cartridges

To install a new HP toner cartridge and recycle the used cartridge, follow the instructions included in the new toner cartridge box.

See "HP Toner Cartridges" on page 133.

Redistributing the Toner

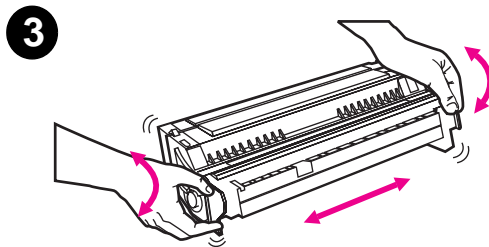
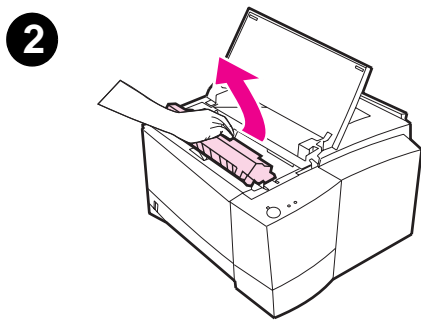
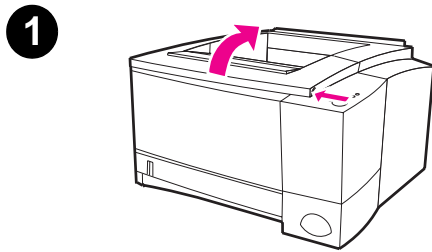

When toner is low, faded or light areas may appear on a printed page. You may be able to temporarily improve print quality by redistributing the toner. The following procedure may allow you to finish the current print job before replacing the toner cartridge.

- 1 Open the top cover.
- 2 Remove the toner cartridge from the printer.

WARNING!

Avoid reaching too far into the printer. The adjacent fusing area may be hot!

CAUTION

To prevent damage, do not expose the toner cartridge to light for more than a few minutes.

- 3 Rotate the toner cartridge and gently shake from side to side to redistribute the toner. (Do not tip the cartridge on end, or it might leak.)

Continued on next page.

4

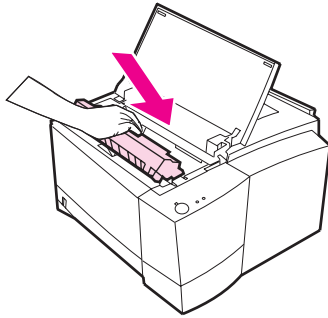

Note

If toner gets on your clothing, wipe it off with a dry cloth and wash clothing in cold water. (Hot water sets toner into fabric.)

- 4 Reinsert the toner cartridge into the printer and close the top cover.

If the print remains light, install a new toner cartridge. (Follow the instructions provided with the new toner cartridge.)

Cleaning the Printer

To maintain print quality, follow the cleaning procedures on the following pages every time the toner cartridge is changed or whenever print quality problems occur. As much as possible, keep the printer free from dust and debris.

- Clean the outside of the printer with a lightly water-dampened cloth.
- Clean the inside with a dry, lint-free cloth.

CAUTION

Do not use ammonia-based cleaners on or around the printer. While cleaning the printer, be careful not to touch the transfer roller (located underneath the toner cartridge). Skin oils on the roller can cause print quality problems.

Using the Printer Cleaning Processes

During the printing process, paper, toner and dust particles can accumulate inside the printer. Over time, this buildup can cause print quality problems such as toner specks or smearing. This printer has two cleaning modes that can correct and prevent these types of problems.

Note

In order for the engine cleaning page to work properly, print the page on copier-grade paper, not bond or rough paper.

Engine Cleaning

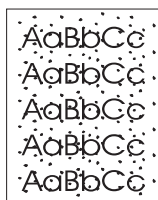

This process uses copier-grade paper from Tray 2 to remove dust and toner from the paper path. Use this process if you are experiencing toner specks or dots on printouts. This process will provide a blank page which should be discarded. See "Starting the Cleaning Process" on page 74.

Toner Cartridge Cleaning

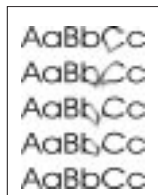

This process cleans the drum inside the toner cartridge. Use this process if you are experiencing blurred, faded or smeared printouts. This process will take about 10 minutes. See "Starting the Cleaning Process" on page 74.

Note

Make sure the toner cartridge is not empty when using the toner cartridge cleaning. A near empty toner cartridge may also cause print defects. This 10-minute process consumes toner and if used often can reduce toner cartridge life.

Starting the Cleaning Process

1. Make sure the printer is turned on and in the ready state. Make sure there is paper loaded in Tray 2.
2. Press and hold the **Go** and **Job Cancel** buttons until all lights flash. This will take about 10 seconds. Release the buttons when the lights flash.
3. For engine cleaning, press the **Go** button,
or
for cartridge cleaning, press the **Job Cancel** button.
4. Discard the blank page produced from the engine cleaning process.

Note

The cartridge cleaning process takes about 10 minutes. To stop the toner cartridge cleaning process, turn the printer off.

Internal Cleaning Procedure

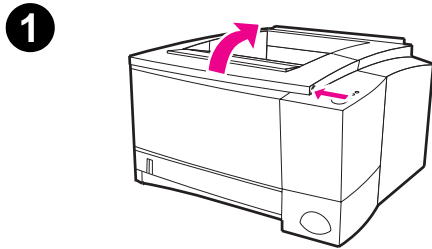

Over time, particles of toner and paper will begin to accumulate inside the printer. This may cause print quality problems during printing. Cleaning the printer will eliminate or reduce these problems.

WARNING!

Before cleaning the printer, turn the printer off and unplug the power cable.

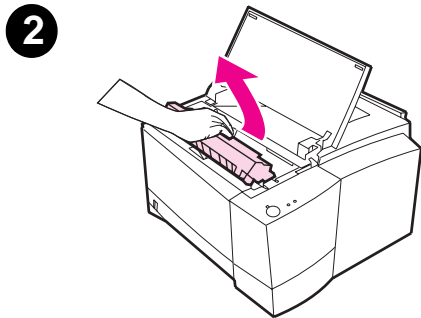

- 1 Open the top cover.
 - 2 Remove the toner cartridge.
-

CAUTION

To prevent damage, do not expose the toner cartridge to light for more than a few minutes. Place a piece of paper over the top of the toner cartridge to shield it while it is out of the printer.

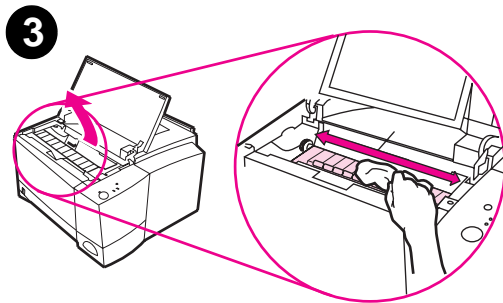

- 3 With a dry, lint-free cloth, wipe any residue from the paper path area and the toner cartridge cavity.
- 4 Replace the toner cartridge and close the top cover. Plug in the power cable, and turn the printer on.

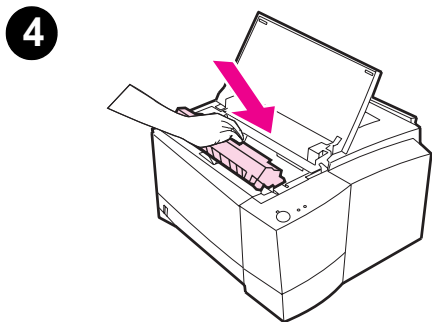

4 Problem Solving

Overview

This chapter helps you troubleshoot printer problems in the following areas:

- Troubleshooting Checklist
- Troubleshooting General Printing Problems
- Printing Special Pages
- Clearing Paper Jams
- Solving Print Quality Problems
- Infrared Printing Problems
- Troubleshooting Error Messages
- Secondary Light Patterns
- Network Problems
- Common Windows Problems
- Common Macintosh Problems
- Troubleshooting PS Errors

Troubleshooting Checklist

If the printer is not responding properly, complete the following checklist in order. If the printer does not pass a step, follow the corresponding troubleshooting suggestions.

Troubleshooting Checklist

Make sure the printer Ready light is on.	If no lights are on, check the power cord connections. Check the power switch. Check the power source by plugging into another outlet. If other lights are on, go to “Troubleshooting Error Messages” on page 99.
Press Go to print a demo page to verify that the printer is feeding paper correctly.	If a demo page does not print, check the paper supply in Tray 2 or Tray 3. If the page jams in the printer, go to “Clearing Paper Jams” on page 85. If the printer prints, but you get an error message, go to “Troubleshooting Error Messages” on page 99.
Check the demo page to see if it printed correctly.	If there is a print quality problem, go to “Solving Print Quality Problems” on page 91.

Troubleshooting Checklist (continued)

Print a short document from a software application to verify the computer and printer are connected and are communicating correctly.

If the page does not print, check the cable connection between the printer and computer. Make sure you are using the proper cable.

Check the print queue or print spooler (print monitor in Mac) to see if the printer has been paused.

Check the software application to make sure you are using the proper printer driver and port. If the page is interrupted during printing, go to "Troubleshooting General Printing Problems" on page 80.

If completing the checklist did not diagnose the problem with the printer, check the following troubleshooting sections:

- "Troubleshooting General Printing Problems" on page 80
- "Infrared Printing Problems" on page 97
- "Troubleshooting Error Messages" on page 99
- "Secondary Light Patterns" on page 102
- "Network Problems" on page 107
- "Common Windows Problems" on page 108
- "Common Macintosh Problems" on page 110
- "Troubleshooting PS Errors" on page 114

Troubleshooting General Printing Problems

Troubleshooting General Printing Problems

Symptom	Possible Cause	Solution
Printer selects media from the wrong tray.	The tray selection in the software application may be incorrect.	<p>For many software applications, the paper tray selection is found under the Page Setup menu within the application.</p> <p>Remove any media in other trays to make the printer select from the desired tray.</p> <p>For Macintosh, use the LaserJet Utility to change the priority of the tray.</p>
Print job is extremely slow.	<p>The job may be very complex.</p> <p>The maximum speed of 10 pages per minute cannot be exceeded even when more memory is added.</p>	Reduce the complexity of the page or try adjusting the print quality settings. If this problem occurs frequently, add memory to the printer.
Pages print, but are totally blank.	<p>The sealing tape may still be in the toner cartridge.</p> <p>The file may have blank pages.</p>	<p>Remove the toner cartridge and pull out the sealing tape. Re-install the toner cartridge. Check the printer by pressing GO to print a demo page.</p> <p>Check file to make sure that it does not contain blank pages.</p>

Troubleshooting General Printing Problems (continued)

Symptom	Possible Cause	Solution
The printer prints, but the text is wrong, garbled, or incomplete.	The parallel cable is loose or defective.	Disconnect the parallel cable and reconnect it. Try a print job you know works. If possible, attach the cable and printer to another computer and try a print job that you know works. Finally, try a new IEEE-1284 compliant cable or a LocalTalk cable (Mac).
	The printer is on a network or sharing device and is not receiving a clear signal.	Disconnect the printer from the network and attach it directly to a computer with a parallel cable. Print a job that you know works. If it prints properly, check with your network administrator.
	The wrong driver was selected in the software.	Check the software's printer selection menu to make sure that the HP LaserJet 2100 is selected.
	The software application is malfunctioning.	Try printing a job from another application.
	The operating system is malfunctioning.	If printing from Windows (any version), exit to a DOS prompt and verify functionality with the following command: At a C:\prompt, type <code>Dir LPT1</code> then press enter. (This assumes you are connected to LPT1). If the Go light comes on, press the Go button to print and eject the page.
The printer does not respond when "print" is selected in the software.	The printer may be in manual feed mode (Go Light Blinking). Add paper to Tray 1 and press and release the Go button.	

Troubleshooting General Printing Problems (continued)

Symptom	Possible Cause	Solution
	The parallel cable between the computer and the printer is not connected properly.	Disconnect and reconnect the parallel cable.
	The parallel cable is defective.	If possible, attach the cable to another computer and print a job you know works. You may also try using a different parallel cable (IEEE-1284 Compliant) or LocalTalk cable (Mac).
	The wrong printer was selected in the software.	Check the software printer selection menu to make sure that the HP LaserJet 2100 is selected.
	The software for the printer is not configured for the printer port.	Check the software's printer selection menu to make sure it is accessing the correct port. If the computer has more than one parallel port, make sure the printer is attached to the correct one.
	The printer is on a network and is not receiving a signal.	Disconnect the printer from the network and attach it directly to a computer with a parallel cable. Print a job you know works. If it prints properly, check with your network administrator.
	The printer is not receiving power.	If no lights are on, check the power cord connections. Check the power switch. Check the power source.

Troubleshooting General Printing Problems (continued)

Symptom	Possible Cause	Solution
The printer does not respond when "print" is selected in the software.	The printer is malfunctioning.	Check the lights on the printer to determine if the printer is indicating an error.
The Attention light stays on.	The printer is out of paper.	Add paper to the printer.
	Paper trays are installed incorrectly.	Make sure that Tray 2 or optional Tray 3 are pushed in all the way.
The Attention light is blinking	The top cover of the printer is open.	Close the top cover securely.
	The toner cartridge is missing or not installed correctly.	Make sure the toner cartridge is installed. Try removing the cartridge and re-installing it.
	There is a paper jam in the printer.	See "Clearing Paper Jams" on page 85.

Printing Special Pages

There are special pages within the memory of the printer that will help you to diagnose and learn about problems with your printer.

Demo Page

To print the demo page, press the **Go** button when the printer is ready.

Configuration Page

The configuration page lists many of the current settings and properties of the printer. To print the configuration page, press and release the **Go** and **JOB CANCEL** buttons simultaneously when the printer is ready. If you have an EIO card installed, a second page will print listing all of the EIO information.

Cleaning Process

The printer has two cleaning processes, Engine and Toner Cartridge cleaning. These clean internal areas including the paper path and the toner cartridge. The Engine cleaning process produces a blank page that should be discarded. See “Using the Printer Cleaning Processes” on page 73.

Font List

To print a font list, use either HP FontSmart (Windows) or the HP LaserJet Utility (Macintosh).

Clearing Paper Jams

Occasionally, paper can become jammed during a print job. Some of the causes include:

- Paper trays loaded improperly or overfilled.
- Tray 2 or optional Tray 3 is removed during a print job.
- Top cover is opened during a print job.
- Media that does not meet HP specifications is used. See “Media Specifications” on page 139.
- Media that is outside of the supported size range is used. See “Media Specifications” on page 139.

Find and remove the jammed paper using the instructions on the following pages. If the location of the paper jam is not obvious, look first in the toner cartridge area.

Paper jams can occur at three locations:

- Tray 2 or optional Tray 3 paper feed area.
- Toner cartridge area.
- Output areas.

Note

Loose toner may remain in the printer after a paper jam. This should clear after a few sheets have printed. See “Loose Toner” on page 94.

1

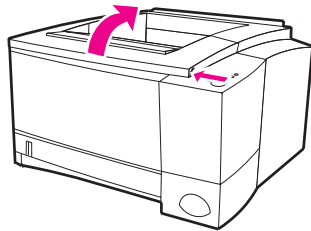

2

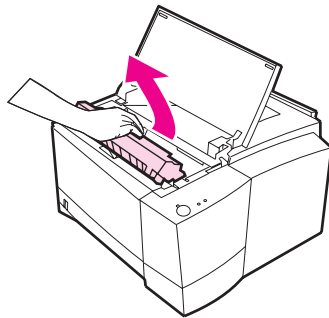

3

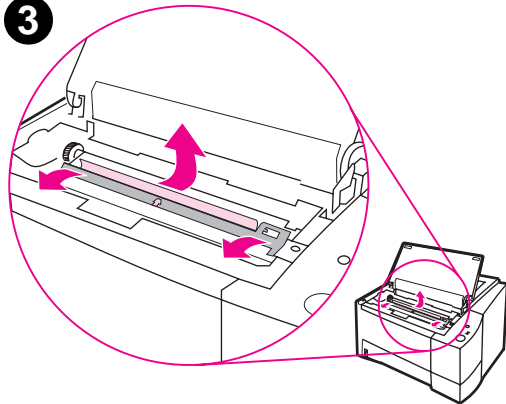

Paper Jam: Toner Cartridge Area

- 1 Open the top cover.

CAUTION

Paper jams in this area may result in loose toner on the page. If you get any toner on your clothes, wash them in cold water because hot water will set the toner into the fabric.

- 2 Remove the toner cartridge.

CAUTION

To prevent damage, do not expose the toner cartridge to light for more than a few minutes. Place a piece of paper over the top of the toner cartridge to shield it while it is out of the printer.

- 3 Carefully lift up the registration plate. If the leading edge of the paper is visible, gently pull the paper toward the rear of the printer to remove it from the printer.

Continued on next page.

4

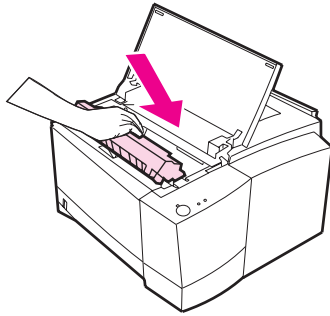

Note

If the paper is too difficult to remove or has already entered the output area, remove the jam as described for the output areas on page 89.

- 4 When the jammed paper has been removed, gently flip down the registration plate. Replace the toner cartridge and shut the top cover.
-

Note

If the toner cartridge is difficult to re-install, make sure the registration plate has been flipped back down into position.

If the Attention light does not go out, there is still jammed paper inside the printer. Check the paper feed or output areas.

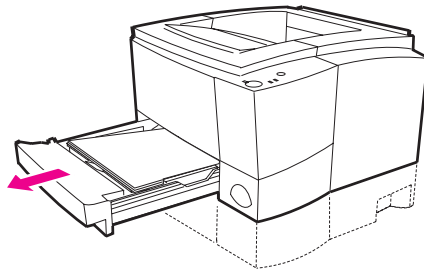
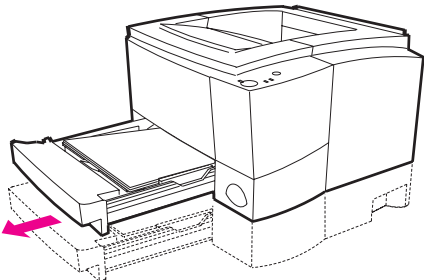
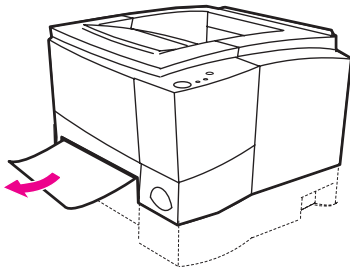
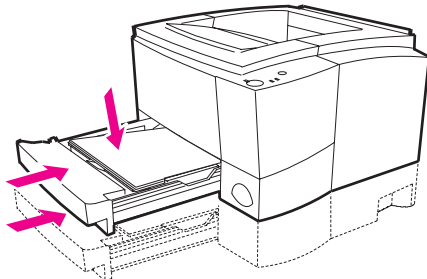
1**2****3****4**

Paper Jam: Tray 2 or Optional Tray 3 Paper Feed Area

Note

If paper has entered the toner cartridge area, follow the instructions on page 86. It is easier to remove paper from the toner cartridge area than the paper feed area.

- 1 Slide out Tray 2 to expose the jammed paper.
 - 2 Remove any misfed paper by pulling it out by the visible edge. Make sure that all of the paper is aligned in the tray. If Tray 3 is installed, remove any misfed paper and make sure that all of the paper is aligned in that tray.
 - 3 If the paper is jammed in the paper feed area and cannot be accessed from the toner cartridge area, grasp the paper and carefully pull it free from the printer.
 - 4 Push the paper down to lock the metal paper lift plate into place and slide the tray back into the printer.
-

Note

If the Attention light does not go out, there is still jammed paper inside the printer. Check the toner cartridge and rear output areas for paper jams.

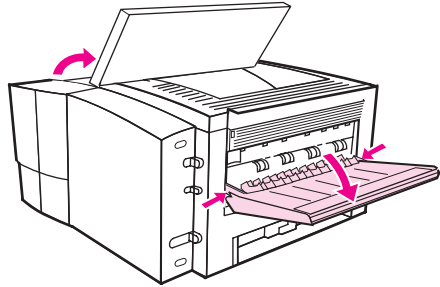
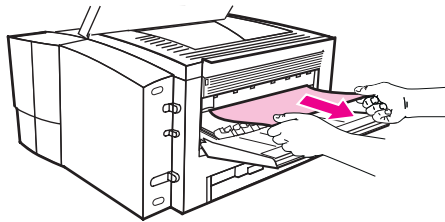
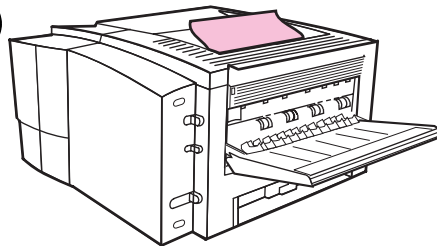
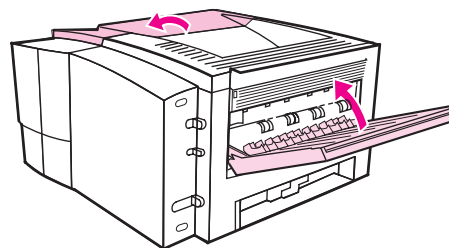
1**2****3****4**

Paper Jam: Output Areas

CAUTION

Paper jams in this area may result in loose toner on the page. If you get any toner on your clothes, wash them in cold water because hot water will set the toner into the fabric.

- 1 Open the top cover and remove the toner cartridge. Open the rear output bin.

Note

It is necessary to open the top cover in order to release the rear output gearing for easy paper removal.

- 2 If the leading edge of the paper is not visible or barely visible in the cartridge area, carefully pull the leading edge out of the printer from the rear output opening using both hands. Carefully remove the rest of the jammed paper from the printer.
- 3 If the paper is almost completely visible from the top output bin, pull the remaining paper carefully out of the printer.
- 4 Re-install the toner cartridge. Close the top cover and the rear output bin.

Note

If the Attention light does not go out, there is still jammed paper inside the printer. Check the paper feed and the toner cartridge areas for paper jams.

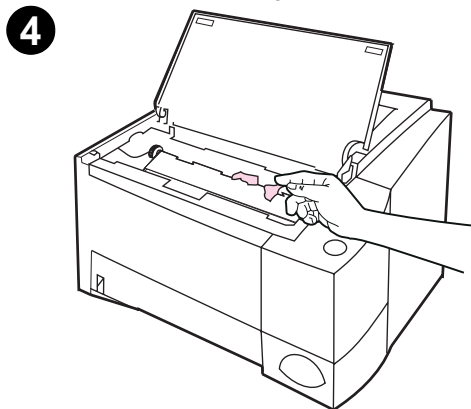
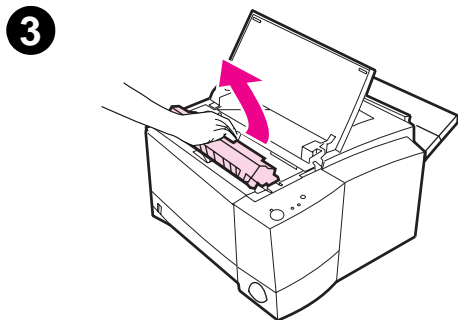
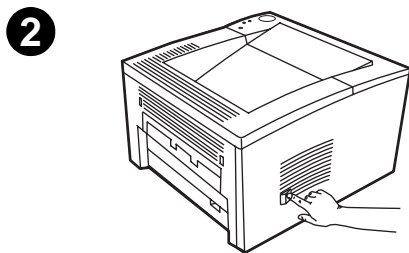
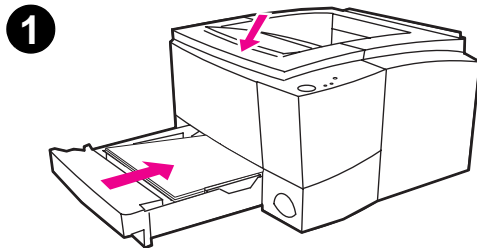

Paper Jam: Removing Torn Pieces of Paper

Sometimes a piece of jammed paper can tear when being removed. Use the following procedure to remove any small pieces of paper left in the printer.

- 1 Make sure the toner cartridge is installed, the top cover is closed, and Tray 2 and optional Tray 3 (if installed) are completely pushed into the printer.
- 2 Turn the printer off and then back on. As the printer restarts, the rollers will advance the piece(s) of paper.
- 3 Open the top cover and remove the toner cartridge. Open the rear output bin.
- 4 Remove the piece(s) of paper.

If the paper cannot be removed by hand, repeat steps 1 through 4. Reinstall the toner cartridge when all the paper has been removed. Close the top cover and the rear output bin.

Solving Print Quality Problems

Print Quality Checklist

General print quality problems can be solved by following the checklist below.

- Check the printer driver to make sure you are using the best available print quality option (see page 58).
- Redistribute the toner in the toner cartridge (see page 71).
- Clean the inside of the printer (see page 73).
- Check the paper type and quality (see page 139).
- Adjust the print density from the software (see page 58).
- Check to make sure EconoMode is off in the software (see page 56).
- Troubleshooting General Printing Problems (see page 80).
- Install a new HP toner cartridge, then check print quality again. See instructions provided with the toner cartridge.

Image Defect Examples

The examples below depict letter-size paper that has passed through the printer short-edge first. The following pages list the typical cause and solution for each of these examples.

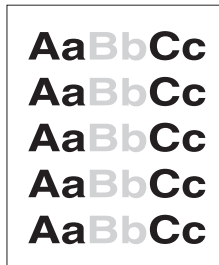

Light Print or Fade

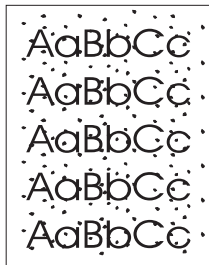

Toner Specks



Dropouts

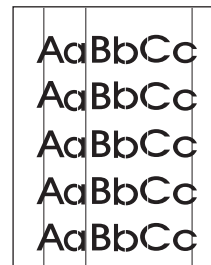

Vertical Lines



Gray Background

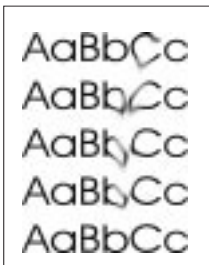

Toner Smear

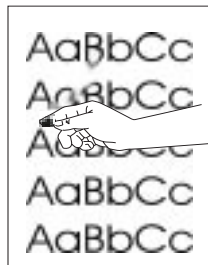

Loose Toner

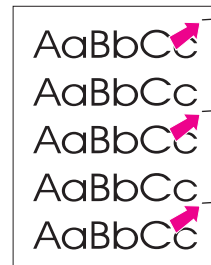

Vertical Repetitive Defects

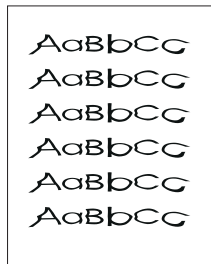

Misformed Characters

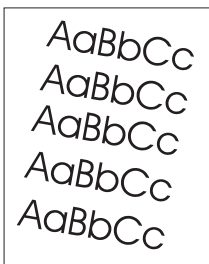

Page Skew

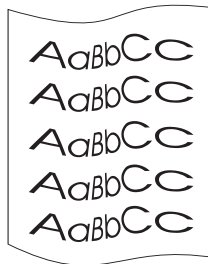

Curl or Wave

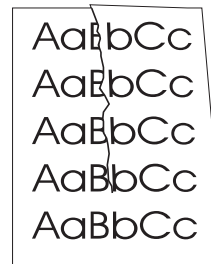

Wrinkles or Creases

Light Print or Fade

If a vertical white streak or faded area appears on the page:

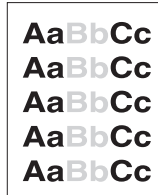

- The toner supply is low. You may be able to temporarily extend the toner cartridge life. See “Redistributing the Toner” on page 71. If this does not improve the print quality, install a new HP toner cartridge.
- The paper may not meet HP’s paper specifications (for example, the paper is too moist or too rough). See “Media Specifications” on page 139.
- If the whole page is light, the print density adjustment is too light or EconoMode may be on. Adjust the print density and EconoMode within the software driver. See “Using EconoMode” on page 56.
- A combination of faded and smeared defects may indicate that the cartridge needs cleaning. See “Toner Cartridge Cleaning” on page 73.

Toner Specks



- The paper may not meet HP’s paper specifications (for example, the paper is too moist or too rough). See “Media Specifications” on page 139.
- The transfer roller may be dirty. See “Internal Cleaning Procedure” on page 75.
- The paper path may need cleaning. See “Engine Cleaning” on page 73.

Dropouts

If faded areas, generally rounded, occur randomly on the page:



- A single sheet of paper may be defective. Try reprinting the job.
- The moisture content of the paper is uneven or the paper has moist spots on its surface. Try paper from a different source. See “Media Specifications” on page 139.
- The paper lot is bad. The manufacturing processes can cause some areas to reject toner. Try a different kind or brand of paper. See “Media Specifications” on page 139.
- The toner cartridge may be defective. See “Vertical Repetitive Defects” on page 95.
- If these steps do not correct the problem, contact an HP-authorized dealer or service representative.

Vertical Lines

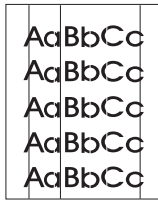

If black or white vertical streaks appear on the page:

- The photosensitive drum inside the toner cartridge has probably been scratched. Install a new HP toner cartridge.

Gray Background



If the amount of background toner shading becomes unacceptable, the procedures described below may help to clear the condition:

- Decrease the density setting. This will decrease the amount of background shading.
- Change the paper to a lighter basis weight. See “Media Specifications” on page 139.
- Check the printer’s environment; very dry (low humidity) conditions can increase the amount of background shading.
- Install a new HP toner cartridge.

Toner Smear



- If toner smears appear on the leading edge of the paper, the paper guides are dirty. See “Internal Cleaning Procedure” on page 75.
- A combination of faded and smeared defects may indicate that the cartridge needs cleaning. See “Toner Cartridge Cleaning” on page 73.
- Check the paper type and quality. See “Media Specifications” on page 139.
- Try installing a new HP toner cartridge.

Loose Toner

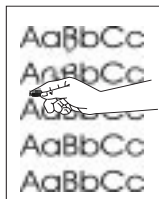

- Clean the inside of the printer. See “Internal Cleaning Procedure” on page 75.
- Check the paper type and quality. See “Media Specifications” on page 139.
- Try installing a new HP toner cartridge.

Vertical Repetitive Defects



If marks repeatedly appear on the printed side of the page at even intervals:

- The toner cartridge may be damaged. The circumference of the toner cartridge drum is 94 mm (3.7 in.). If a repetitive mark occurs every 94 mm (3.7 in.) on the page, install a new HP toner cartridge.
- Internal parts may have toner on them. If the defects occur on the back of the page, the problem will likely correct itself after a few more pages.
- The fusing assembly may be damaged. Contact an HP-approved service technician.

Misformed Characters

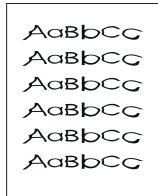

- If characters are improperly formed, producing hollow images, the paper stock may be too slick. Try a different paper. See “Media Specifications” on page 139.
- If characters are improperly formed, producing a wavy effect, the laser scanner may need service. Verify that it also occurs on a demo page by pressing **Go** when the printer is ready. If you need service, contact an HP-authorized dealer or service representative. See “Hewlett-Packard Limited Warranty Statement” on page 121.

Page Skew

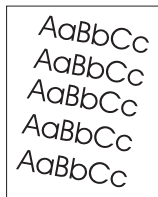

- Check the paper type and quality. See “Media Specifications” on page 139.
- Make sure the paper or other media is loaded correctly and that the guides are not too tight or too loose against the paper stack.

Curl or Wave

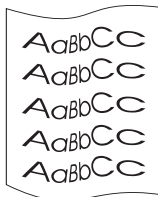

- Check the paper type and quality. Both high temperature and humidity will cause paper curl. See “Media Specifications” on page 139.
- Turn over the stack of paper in the tray. Also try rotating the paper 180° in the input tray.
- Open the rear door and try printing to the rear output bin.

Wrinkles or Creases



- Make sure that paper is loaded properly.
- Check the paper type and quality. See “Media Specifications” on page 139.
- Open the rear door and try printing to the rear output bin.
- Turn over the stack of paper in the tray or try rotating the paper 180° in the input tray.

Hint

If the page is totally blank (all white) check to make sure the sealing tape is removed from the toner cartridge and ensure that the toner cartridge is installed correctly.

Infrared Printing Problems

Infrared Printing Problems

Symptom	Possible Cause	Solution
The connection cannot be established or the transmission seems to be taking longer than usual.	Computer is not IrDA-compliant.	Make sure the computer you are using is IrDA-compliant; look for an IrDA symbol on the device or refer to the computer's manual.
	IR Driver is not installed on your computer or Personal Digital Assistant (PDA).	Make sure the operating system on the computer includes an IR driver and your application is using an HP LaserJet 2100 series printer driver. Keep in mind that complex pages take longer to print. HP does not supply the IR driver for the computer port. The IR driver is available through the hardware or operating system manufacturers. Contact your hardware or software tech support to obtain a driver.
	Computer and printer are not positioned properly.	Make sure you have positioned the device within the range of operation and that no objects, such as a finger, paper, books, or bright light are interfering with the connection. Also make sure the two IR ports are clean (free from dirt and grease).

Infrared Printing Problems (continued)

Symptom	Possible Cause	Solution
The connection cannot be established or the transmission seems to be taking longer than usual (continued).	Bright lights are interfering with the signal.	Make sure that no bright light is shining directly into either IR port. Bright light of any kind (sunlight, incandescent light, fluorescent light, or light from an infrared remote control, such as those used for TVs and VCRs) shining directly into one of the IR ports may cause interference. Position the device closer to the IR port on the printer.
The printer prints only part of a page or document.	The connection has been interrupted during transmission.	IrDA-compliant devices are designed to recover from temporary connection interruptions. Re-establish the connection. (Depending on the device you are using, it can take anywhere from 3 to 40 seconds to re-establish the connection.)
The print job has been properly sent to the printer, but the printer will not print.	The connection may have been disrupted or broken.	If the connection is broken before the print job has started, the printer may not print any of the job. If the Data (middle) light is on, press JOB CANCEL to clear the printer memory. Position the device within the range of operation and print the job again.
The IR status light turns off during transmission.	The connection may have been broken.	If the Data (middle) light is on, press JOB CANCEL to clear the printer memory. Position the device within the range of operation and print the job again.

Troubleshooting Error Messages

When the printer experiences an error, the control panel will indicate the error message by five light patterns. Find the light pattern below that matches the printer light pattern and follow the recommendations to troubleshoot the error. Some error messages will signal a secondary light message that will indicate what type of error is occurring. See “Secondary Light Patterns” on page 102.

Note

Common status light patterns are described on page 16.

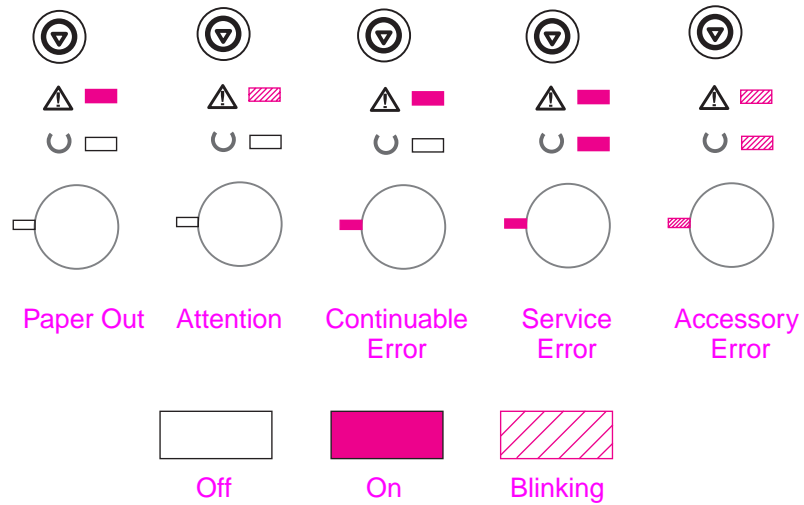

Paper Out

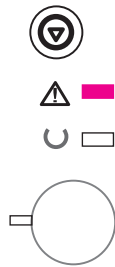

The printer is out of paper in the requested tray. Filling the trays with paper will cancel this message and allow you to continue with the print job.

Attention

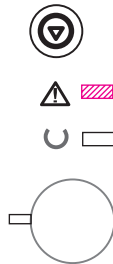

There are three possible causes that will display the Attention light pattern:

- Door open
- Toner cartridge missing
- Paper jam

After the cause of the problem has been addressed, pressing the **Go** button will cause the printer to attempt to recover from the cause of the error. If there is a paper jam, the printer will attempt to clear the jam. If the printer is unsuccessful, it will continue to display the Attention message until the cause is remedied.

Pressing the **JOB CANCEL** button will cancel the print job and the printer will return to Ready unless there is a paper jam still in the printer. See “Clearing Paper Jams” on page 85.

Continuable Error

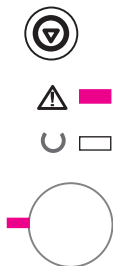

An error has occurred that has caused the printer to halt the current print job. Pressing the **Go** button causes the printer to attempt to recover from the error and print whatever data it can. If the attempt to recover from the error is successful, the Ready light will blink while the printer completes the job. If the printer cannot recover, it will display the Continuable Error message.

Pressing the **JOB CANCEL** button will cancel the print job and the printer will return to ready if the cause of the error has been fixed.

Pressing the **Go** and **JOB CANCEL** buttons simultaneously and then releasing the buttons will cause the printer to display a secondary light pattern that will indicate the error code corresponding to the current error condition. See “Continuable Error” on page 102.

Service Error



An error has occurred that has caused the printer to halt the current print job. Pressing the **GO** button or the **JOB CANCEL** button with this message has no effect.



To clear the error, turn the printer off and then on again. If the problem persists, leave the printer off for 15 minutes to reset the formatter. If the problem continues, contact HP Service.

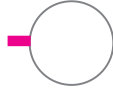

Accessory Error



An error has occurred with one of the accessories, either the EIO port or the DIMM slots, that has caused the printer to halt the current print job. Pressing the **GO** button or the **JOB CANCEL** button with this message has no effect.



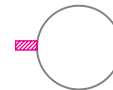

Pressing the **GO** and **JOB CANCEL** buttons simultaneously and then releasing the buttons will cause the printer to display a secondary light pattern that will indicate the error code corresponding to the current error condition. See "Accessory Error" on page 105.



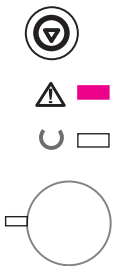
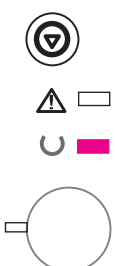

Secondary Light Patterns

Continuable Error

Type of Error	Light Pattern	Recommended Action
Memory Overflow		<p>The printer memory is full. Press Go to resume printing. If you lose some data, try to free some printer memory by removing any unnecessary fonts, macros, or any data currently in printer memory. If you continue to lose data, you may need to add more printer memory. For a temporary solution, simplify the image or print at a 600-dpi resolution.</p>
Temporary Engine Error		<p>The printer has experienced a temporary engine error. Reset the printer by briefly turning the printer off and back on again.</p>
Print Overrun		<p>The print job was too complex for available printer memory. Press Go to resume printing. If you lose some data, you may need to add more printer memory. For a temporary solution, simplify the image or print at a 600-dpi resolution.</p>

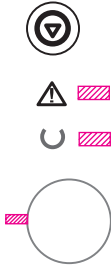

Continuable Error (continued)

Type of Error	Light Pattern	Recommended Action
IO Error		The cable between the printer and computer has a bad connection or the cable is of poor quality. Check the cable connections to see if they are secure. Make sure you are using a high-quality cable.
Temporary Error		The printer has experienced a temporary error. Reset the printer by briefly turning the printer off and back on again.
NVRAM Error		The nonvolatile memory (NVRAM) is temporarily full. Press Go to clear the message. Check the printer settings to ensure they are correct. If the problem persists, contact your dealer or HP service representative.

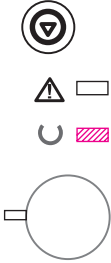
Continuable Error (continued)

Type of Error	Light Pattern	Recommended Action
EIO Error		The printer has experienced a temporary EIO error. Reset the printer by turning the printer off and back on again.

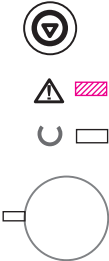
Accessory Error

Type of Error	Light Pattern	Recommended Action
EIO Port Error		Remove the accessory from the EIO Port or DIMM Slot indicated by the error to continue printing.
DIMM Slot 1 Error		Remove the accessory from the EIO Port or DIMM Slot indicated by the error to continue printing.
DIMM Slot 2 Error		Remove the accessory from the EIO Port or DIMM Slot indicated by the error to continue printing.

Accessory Error (continued)

Type of Error	Light Pattern	Recommended Action
DIMM Slot 3 Error		Remove the accessory from the EIO Port or DIMM Slot indicated by the error to continue printing.

Network Problems

You are experiencing shared printer problems.

- Print a Configuration page. If an HP JetDirect EIO print server is installed, printing a Configuration page will also print a second page that will show the network settings and status.
- Try printing the job from another computer.
- To verify if a printer works with a computer, connect it directly to a computer with a parallel cable. Print a document from an application that has printed correctly in the past. If this works, then there may be a problem with the network.
- Contact your network administrator for assistance.

Common Windows Problems

Common Windows Problems

Symptom	Possible Cause	Solution
Windows message during installation reads: "File in Use."		Quit all software. Remove all software from the StartUp Group, then restart Windows. Reinstall the printer drivers.
Error Message: "Error Writing to LPTx" in Windows 9x.		<p>Make sure the cables are connected correctly, the printer is on, and the Ready (front) light is on.</p> <p>If bi-directional communication is not turned on in the driver, it will also cause this message.</p> <p>Click on Start, Settings, Printers. Right click on the HP LaserJet 2100 driver and select Properties. Click on Details, Port Settings. Remove check from "Check Port State before Printing" box. Click OK. Click on Spool Settings. Select "Print Directly to Printer." Click OK. Try printing again.</p>
Error Message: "General Protection Fault" "Exception OE" "Spool32" "Illegal Operation"		<p>Close all other applications, reboot Windows, and try again.</p> <p>Switch the printer driver. If the HP LaserJet 2100 Series PCL 6 Driver is selected, switch to another printer driver such as an HP LaserJet 2100 Series PCL 5e Driver or a Microsoft Driver.</p>

Common Windows Problems (continued)

Symptom	Possible Cause	Solution
Error Message: "General Protection Fault" "Exception OE" "Spool32" "Illegal Operation" (Continued)		Delete all temp files from the Temp sub-directory. You can determine the name of the directory by editing the AUTOEXEC.BAT file and looking for the statement "Set Temp =." The name after this statement is the temp directory. It is usually C:\temp by default, but can be redefined. Refer to Microsoft Windows 3.x, 9x, or NT 4.0 documentation that came with your PC for further information on Windows error messages.

Common Macintosh Problems

Macintosh Problems

Symptom	Possible Cause	Solution
Problems in the Chooser		
Printer driver icon does not appear in the Chooser.	Software not installed correctly.	<p>The LaserWriter driver should be present as a part of the Mac OS. Make sure that the LaserWriter driver is in the Extensions folder within the systems folder. If not, install the LaserWriter driver component from the installation CD.</p> <p>Make sure you are using a high-quality cable.</p> <p>Make sure the printer is on the correct network. Select the Network or AppleTalk Control Panel from Control Panels in the Apple menu and then choose the correct network.</p>
Printer name does not appear in the "Select a PostScript Printer" box in the Chooser.		<p>Make sure the cables are connected correctly, the printer is on, and the Ready (front) light is on.</p> <p>Make sure the correct printer driver has been selected in the Chooser.</p> <p>If the printer resides on a network with multiple zones, make sure the correct zone is selected in the "AppleTalk Zones" box in the Chooser.</p>

Macintosh Problems (continued)

Symptom	Possible Cause	Solution
		Make sure the printer has been chosen in the Chooser by printing a self-test. (Simultaneously press Go and JOB CANCEL .) Check the AppleTalk name of the printer displayed on the self-test page.
		Make sure AppleTalk is on. (The button next to Active is selected in the Chooser.) You may need to restart the computer to activate the change.
The printer driver does not automatically set up your selected printer even though you clicked Auto Setup in the Chooser.		Reinstall the printer software. See "Macintosh Installation" on page 10. Select an alternate PPD.

Printing Errors

A print job was not sent to your desired printer.	Another printer with the same or similar name may have received your print job.	Rename the printer using the HP LaserJet Utility, making sure that all devices have unique names.
You cannot use the computer while the printer is printing.	Background Printing has not been selected.	LaserWriter 8.3 Turn Background Printing on in the Chooser. Status messages will now be redirected to the Print Monitor allowing you to continue working while the computer is processing data to be sent to the printer. LaserWriter 8.4 and higher Turn Background Printing on by selecting File, Print Desktop, and Background Printing.

Macintosh Problems (continued)

Symptom	Possible Cause	Solution
An encapsulated PostScript (EPS) file does not print with the correct fonts.	This problem occurs with some software applications.	Try downloading the fonts contained in the EPS file to the printer before printing.
Your document is not printing with New York, Geneva, or Monaco.		Select Options in the Page Setup dialog box to deselect substituted fonts.

Selecting an Alternate PPD

1. Open the Chooser from the Apple menu.
2. Click the LaserWriter icon.
3. If you are on a network with multiple zones, select the zone in the AppleTalk Zones box where the printer is located.
4. Click the printer name you want to use in the Select a PostScript Printer box. (Double-clicking will immediately generate the next few steps.)
5. Click Setup... (This button may read Create for first-time setup.)
6. Click Select PPD....
7. Find the desired PPD in the list and click Select. If the desired PPD is not listed, choose one of the following options:
 - Select a PPD for a printer with similar features.
 - Select a PPD from another folder.
 - Select the generic PPD by clicking Use Generic. The generic PPD allows you to print, but limits your access to printer features.
8. In the Setup dialog box, click Select, and then click OK to return to the Chooser.

Note

If you manually select a PPD, an icon might not appear next to the selected printer in the Select a PostScript Printer box. In the Chooser, click Setup, click Printer Info, and then click Update Info to bring up the icon.

9. Close the Chooser.

Renaming the Printer

If you are going to rename the printer, do this before selecting the printer in the Chooser. If you rename the printer after selecting it in the Chooser, you will have to go back into the Chooser and reselect it.

Use the Set Printer Name feature in the HP LaserJet Utility to rename the printer.

Troubleshooting PS Errors

The following situations are PS language specific and may occur when several printer languages are being used.

Note

To receive a printed or screen displayed message when PS errors occur, open the Print Options dialog box and click the desired selection next to the PS Errors section.

PS Errors

Symptom	Possible Cause	Solution
The job prints in Courier (the printer's default typeface) instead of the typeface you requested.	The requested typeface is not downloaded. A personality switch may have been performed to print a PCL job just before the PS printing job was received.	Download the desired font and send the print job again. Verify the type and location of the font. Download to printer if applicable. Check with the software documentation.
A legal page prints with clipped margins.	Print job too complex.	You may need to print your job at 600 dots per inch, reduce the complexity of the page, or install more memory.
A PS error page prints.	Print job may not be PS.	Make sure the print job is a PS job. Check to see whether the software application expected a setup or PS header file to be sent to the printer.

Specific Errors

Limit Check Error	Print job too complex.	You may need to print your job at 600 dots per inch, reduce the complexity of the page, or install more memory.
-------------------	------------------------	---

PS Errors (continued)

Symptom	Possible Cause	Solution
VM Error	Font Error	Select unlimited downloadable fonts from printer driver.
Range Check	Font Error	Select unlimited downloadable fonts from printer driver.

5

Service and Support

Availability

HP provides a variety of service and support options around the world. Availability of these programs will vary depending upon your location.

HP Express Exchange

1. The customer contacts the local HP Customer Support Center listed in the product documentation. A technician troubleshoots the situation and determines whether the printer has actually failed. If so, the technician refers the customer to the HP Service Center.
2. A representative from the service center requests product and customer information. In some regions, collateral may also be requested.
3. HP ships a refurbished replacement unit to arrive the next day. (Geographic distance might prevent next-day shipping.)
4. The customer sends the defective printer to Hewlett-Packard at HP's expense.

Customers with on-site support service provided by HP should work directly with the local Customer Support Center instead of following the steps outlined here.

Exchanged units carry the remainder of the original unit's warranty or 90 days, whichever is greater. The faster turnaround from HP Express Exchange minimizes downtime over traditional service programs that require you to ship the failed unit to the manufacturer, and then wait for it to be repaired and returned. Because HP pays the shipping charges, you incur no hidden costs for the service.

Guidelines for Repacking the Printer

- Remove and retain any DIMMs (dual in-line memory modules) installed in the printer.
- Remove and retain any cables and optional accessories installed in the printer.

CAUTION

Static electricity can damage DIMMs. When handling DIMMs, either wear an antistatic wrist strap or frequently touch the surface of the DIMMs' antistatic package, then touch bare metal on the printer. To remove the DIMMs see "Installing Memory" on page 153.

- Remove and retain the toner cartridge.

CAUTION

To prevent damage to the toner cartridge, store the cartridge in its original packing material, or store it so that it is not exposed to light.

- Use the original shipping container and packing material, if possible. (Shipping damage as a result of inadequate packing is the customer's responsibility.) If you have already disposed of the printer's packing material, contact a local mailing service for information on repacking the printer.
- If possible, include print samples and 50-100 sheets of paper or other media that did not print correctly.
- Include a completed copy of the Service Information Form on page 119.
- HP recommends insuring the equipment for shipment.

Service Information Form

WHO IS RETURNING THE EQUIPMENT?		Date: _____
Person to contact:		Phone: () _____
Alternate contact:		Phone: () _____
Return shipping address:	Special shipping instructions:	
WHAT IS BEING SENT?		
Model name:	Model number:	Serial number:
Please attach any relevant printouts when returning equipment. DO NOT ship accessories (manuals, cleaning supplies, etc.) that are not required to complete the repair.		
WHAT NEEDS TO BE DONE? (Attach a separate sheet if necessary.)		
1. Describe the conditions of the failure. (What was the failure? What were you doing when the failure occurred? What software were you running? Is the failure repeatable?)		
2. If the failure is intermittent, how much time elapses between failures?		
3. Is the unit connected to any of the following? (Give manufacturer and model number.)		
Personal computer:	Modem:	Network:
4. Additional comments:		
HOW WILL YOU PAY FOR THE REPAIR?		
<input type="checkbox"/> Under warranty	Purchase/received date: _____ (Enclose proof of purchase or receiving document with original received date.)	
<input type="checkbox"/> Maintenance contract number:	_____	
<input type="checkbox"/> Purchase order number:	_____	
Except for contract and warranty service, a purchase order number and/or authorized signature must accompany any request for service. If standard repair prices do not apply, a minimum purchase order is required. Standard repair prices can be obtained by contacting an HP-authorized Repair Center.		
Authorized signature: _____	Phone: _____	
Billing address:	Special billing instructions:	

HP Maintenance Agreements

HP has several types of maintenance agreements that meet a wide range of support needs. Maintenance agreements are not part of the standard warranty. Support services vary by area. Check with your local HP dealer to determine the services available to you.

On-Site Service Agreements

To provide you with the level of support best suited to your needs, HP has on-site service agreements with three response times:

Priority On-Site Service

This agreement provides 4-hour service response to your site for calls made during normal HP business hours.

Next-Day On-Site Service

This agreement provides support by the next working day following a service request. Extended coverage hours and extended travel beyond HP's designated service zones are available on most on-site agreements (for additional charges).

Weekly (Volume) On-Site Service

This agreement provides scheduled weekly on-site visits for organizations with many HP products. This agreement is designated for sites using 25 or more workstation products, including printers, plotters, computers, and disk drives.

Hewlett-Packard Limited Warranty Statement

HP PRODUCT	DURATION OF WARRANTY
HP LaserJet 2100, 2100 M, 2100 TN	1 year, Return to Authorized Service Center

1. HP warrants to you, the end-user customer, that HP hardware, accessories, and supplies, will be free from defects in materials and workmanship after the date of purchase, for the period specified above. If HP receives notice of such defects during the warranty period, HP will, at its option, either repair or replace products which prove to be defective. Replacement products may be either new or like-new.
2. HP warrants to you that HP software will not fail to execute its programming instructions after the date of purchase, for the period specified above, due to defects in material and workmanship when properly installed and used. If HP receives notice of such defects during the warranty period, HP will replace software media which does not execute its programming instructions due to such defects.
3. HP does not warrant that the operation of HP products will be uninterrupted or error free. If HP is unable, within a reasonable time, to repair or replace any product to a condition as warranted, you will be entitled to a refund of the purchase price upon prompt return of the product.
4. HP products may contain remanufactured parts equivalent to a new in performance or may have been subject to incidental use.
5. Warranty does not apply to defects resulting from (a) improper or inadequate maintenance or calibration, (b) software, interfacing, parts or supplies not supplied by HP, (c) unauthorized modification or misuse, (d) operation outside of the published environmental specifications for the product, or (e) improper site preparation or maintenance.
6. HP MAKES NO OTHER EXPRESS WARRANTY OR CONDITION WHETHER WRITTEN OR ORAL. TO THE EXTENT ALLOWED BY LOCAL LAW, ANY IMPLIED WARRANTY OR CONDITION OR MERCHANTABILITY, SATISFACTORY QUALITY, OR FITNESS FOR A PARTICULAR PURPOSE IS LIMITED TO THE DURATION OF THE EXPRESS WARRANTY SET FORTH ABOVE. Some countries, states or provinces do not allow limitations on the duration of an implied warranty, so the above limitation or exclusion might not apply to you. This warranty gives you specific legal rights and you might also have other rights that vary from country to country, state to state, or province to province.

7. TO THE EXTENT ALLOWED BY LOCAL LAW, THE REMEDIES IN THIS WARRANTY STATEMENT ARE YOUR SOLE AND EXCLUSIVE REMEDIES. EXCEPT AS INDICATED ABOVE, IN NO EVENT WILL HP OR ITS SUPPLIERS BE LIABLE FOR LOSS OF DATA OR FOR DIRECT, SPECIAL, INCIDENTAL, CONSEQUENTIAL (INCLUDING LOST PROFIT OR DATA), OR OTHER DAMAGE, WHETHER BASED IN CONTRACT, TORT, OR OTHERWISE. Some countries, states or provinces do not allow the exclusion or limitation of incidental or consequential damages, so the above limitation or exclusion may not apply to you.
8. FOR CONSUMER TRANSACTIONS IN AUSTRALIA AND NEW ZEALAND; THE WARRANTY TERMS CONTAINED IN THIS STATEMENT, EXCEPT TO THE EXTENT LAWFULLY PERMITTED, DO NOT EXCLUDE, RESTRICT OR MODIFY AND ARE IN ADDITION TO THE MANDATORY STATUTORY RIGHTS APPLICABLE TO THE SALE OF THIS PRODUCT TO YOU.

Limited Warranty for Toner Cartridge Life

Note

The warranty below applies to the toner cartridge that came with this printer.

HP toner cartridges are warranted to be free from defects in materials and workmanship until the HP toner is depleted. The warranty covers any defects or malfunctions in a new Hewlett-Packard toner cartridge.

How long does the coverage last?

The coverage lasts until the HP toner is depleted, at which time the warranty expires.

How do I know when the HP toner is running out?

The HP toner is depleted when faded or light type appears on the printed page.

What will HP do?

HP will, at HP's option, either replace products which prove to be defective or refund the purchase price. If possible, please attach a printout sample illustrating what the defective cartridge is printing.

What does this warranty not cover?

The warranty does not cover cartridges which have been refilled, are emptied, are abused, are misused, or are tampered with in any way.

How do I return the faulty cartridge?

In the event the cartridge proves to be defective, complete the Service Information Form and attach a print sample illustrating the defect. Return the form and cartridge to the place of purchase, where the cartridge will be replaced.

How does State, Province or Country Law apply?

This limited warranty gives you specific legal rights, and you may also have other rights which vary from state to state, province to province, or country to country. This limited warranty is the sole warranty on the HP toner cartridge and supersedes any other warranty relating to this product.

FOR CONSUMER TRANSACTIONS IN AUSTRALIA AND NEW ZEALAND; THE WARRANTY TERMS CONTAINED IN THIS STATEMENT, EXCEPT TO THE EXTENT LAWFULLY PERMITTED, DO NOT EXCLUDE, RESTRICT OR MODIFY AND ARE IN ADDITION TO THE MANDATORY STATUTORY RIGHTS APPLICABLE TO THE SALE OF THIS PRODUCT TO YOU.

IN NO EVENT SHALL HEWLETT-PACKARD COMPANY BE LIABLE FOR ANY INCIDENTAL, CONSEQUENTIAL, SPECIAL, INDIRECT, PUNITIVE, OR EXEMPLARY DAMAGES OR LOST PROFITS FROM ANY BREACH OF THIS WARRANTY OR OTHERWISE.

Worldwide Sales and Service Offices

Note

Before calling an HP Sales and Service office, be sure to contact the appropriate Customer Support Center number listed in the "HP Support" section. Products should not be returned to these offices. Product return information is also available through the appropriate Customer Support Center in "HP Support" in the front of this guide.

Argentina

Hewlett-Packard Argentina S.A.
Montañeses 2140/50/60
1428 Buenos Aires
Phone: (54) (1) 787-7100
Fax: (54) (1) 787-7213

Australia

Hewlett-Packard Australia Ltd.
31-41 Joseph Street
Blackburn, VIC 3130
Phone: (61) (3) 272-2895
Fax: (61) (3) 898-7831
Hardware Repair Center:
Phone: (61) (3) 272-8000
Extended Warranty Support:
Phone: (61) (3) 272-2577
Customer Information Center:
Phone: (61) (3) 272-8000

Austria

Hewlett-Packard GmbH
Lieblgasse 1
A-1222 Vienna
Phone: (43) (1) 25000-555
Fax: (43) (1) 25000-500

Belgium

Hewlett-Packard Belgium S.A. NV
Boulevard de la Woluwe-Woluwedal
100-102
B-1200 Brussels
Phone: (32) (2) 778-31-11
Fax: (32) (2) 763-06-13

Brazil

Edisa Hewlett-Packard SA
Alameda Rio Negro 750
06454-050 Alphaville - Barueri-SP
Phone: (55) (11)- 7296-8000

Canada

Hewlett-Packard (Canada) Ltd.
17500 Trans Canada Highway
South Service Road
Kirkland, Québec H9J 2X8
Phone: (1) (514) 697-4232
Fax: (1) (514) 697-6941

Hewlett-Packard (Canada) Ltd.
5150 Spectrum Way
Mississauga, Ontario L4W 5G1
Phone: (1) (905) 206-4725
Fax: (1) (905) 206-4739

Chile

Hewlett-Packard de Chile
Avenida Andres Bello 2777 of. 1
Los Condes
Santiago, Chile

China

China Hewlett-Packard Co. Ltd.
Level 5, West Wing Office
China World Trade Center
No. 1, Jian Guo Men Wai Avenue
Beijing 100004
Phone: (86) (10) 6505-3888,x. 5450
Fax: (86) (10) 6505-1033
Hardware Repair Center and Extended
Warranty Support:
Phone: (86) (10) 6262-5666x. 6101/2
(86) (10) 6261-4167

Colombia

Hewlett-Packard Colombia
Calle 100 No. 8A -55
Torre C Oficina 309
Bogotá, Colombia

Czech Republic

Hewlett-Packard s. r. o.
Novodvorská 82
CZ-14200 Praha 4
Phone: (42) (2) 613-07111
Fax: (42) (2) 471-7611

Denmark

Hewlett-Packard A/S
Kongevejen 25
DK-3460 Birkerød
Denmark
Phone: (45)3929 4099
Fax: (45) 4281-5810

Far East Region

Hewlett-Packard Asia Pacific Ltd.
17-21/F Shell Tower, Times Square
1 Matheson Street, Causeway Bay
Hong Kong
Phone: (852) 2599-7777
Fax: (852) 2506-9261
Hardware Repair Center:
Phone: (852) 2599-7000
Extended Warranty Support:
Phone: (852) 2599-7000
Customer Information Center:
Phone: (852) 2599-7066

Finland

Hewlett-Packard Oy
Piispankalliontie 17
FIN-02200 Espoo
Phone: (358) (9) 887-21
Fax: (358) (9) 887-2477

France

Hewlett-Packard France
42 Quai du Point du Jour
F-92659 Boulogne Cedex
Phone: (33) (146) 10-1700
Fax: (33) (146) 10-1705

Germany

Hewlett-Packard GmbH
Herrenberger Straße 130
71034 Böblingen
Phone: (49) (180) 532-6222
(49) (180) 525-8143
Fax: (49) (180) 531-6122

Greece

Hewlett-Packard Hellas
62, Kifissias Avenue
GR-15125 Maroussi
Phone: (30) (1) 689-6411
Fax: (30) (1) 689-6508

Hungary

Hewlett-Packard Magyarország Kft.
Erzsébet királyné útja 1/c.
H-1146 Budapest
Phone: (36) (1) 343-0550
Fax: (36) (1) 122-3692
Hardware Repair Center:
Phone: (36) (1) 343-0312
Customer Information Center:
Phone: (36) (1) 343-0310

India

Hewlett-Packard India Ltd.
Paharpur Business Centre
21 Nehru Place
New Delhi 110 019
Phone: (91) (11) 647-2311
Fax: (91) (11) 646-1117
Hardware Repair Center and Extended
Warranty Support:
Phone: (91) (11) 642-5073
(91) (11) 682-6042

Italy

Hewlett-Packard Italiana SpA
Via Giuseppe di Vittorio, 9
Cernusco Sul Naviglio
I-20063 (Milano)
Phone: (39) (2) 921-21
Fax: (39) (2) 921-04473

Japan

Hewlett-Packard Japan, Ltd.
3-29-21 Takaido-higashi
Suginami-ku, Tokyo 168
Phone: (81) (3) 3335-8333
Fax: (81) (3) 3335-8338
Hardware Repair Center:
Phone: (81) (4) 7355-6660
Fax: (81) (4) 7352-1848

Korea

Hewlett-Packard Korea
25-12,
Yoido-dong, Youngdeungpo-ku
Seoul 150-010
Phone: (82) (2) 769-0114
Fax: (82) (2) 784-7084
Hardware Repair Center:
Phone: (82) (2) 3270-0700
(82) (2) 707-2174 (DeskJet)
(82) (2) 3270-0710 (Hardware)
Extended Warranty Support:
Phone: (82) (2) 3770-0365 (Bench)
(82) (2) 769-0500 (Onsite)

Latin American Headquarters

5200 Blue Lagoon Drive Suite 950
Miami, FL 33126, USA
Phone: (1) (305) 267-4220

México

Hewlett-Packard de México, S.A. de C.V.
Prolongación Reforma No. 700
Lomas de Santa Fe
01210 México, D.F.
Phone: 01-800-22147
Outside Mexico City
Phone: 01 800-90529

Middle East/Africa

ISB HP Response Center
Hewlett-Packard S.A.
Rue de Veyrot 39
P.O. Box 364
CH-1217 Meyrin - Geneva
Switzerland
Phone: (41) (22) 780-4111

Netherlands

Hewlett-Packard Nederland
BV Startbaan 16
NL-1187 XR Amstelveen
Postbox 667
NL-1180 AR Amstelveen
Phone: (31) (020) 606-87-51
Fax: (31) (020) 547-7755

New Zealand

Hewlett-Packard (NZ) Limited
Ports of Auckland Building
Princes Wharf, Quay Street
P.O. Box 3860
Auckland
Phone: (64) (9) 356-6640
Fax: (64) (9) 356-6620
Hardware Repair Center and Extended
Warranty Support:
Phone: (64) (9) 0800-733547
Customer Information Center:
Phone: (64) (9) 0800-651651

Norway

Hewlett-Packard Norge A/S
Postboks 60 Skøyen
Drammensveien 169
N-0212 Oslo
Phone: (47) 2273-5600
Fax: (47) 2273-5610

Poland

Hewlett-Packard Polska
Al. Jerozolimskic 181
02-222 Warszawa
Phone: (48-22) 608-7700
Fax: (48-22) 608-7600

Russia

AO Hewlett-Packard
Business Complex Building #2
129223, Moskva, Prospekt Mira VVC
Phone: (7) (95) 928-6885
Fax: (7) (95) 974-7829

Singapore

Hewlett-Packard Singapore
(Sales) Pte Ltd
450 Alexandra Road
Singapore (119960)
Phone: (65)275-3888
Fax: (65)275-6839
Hardware Repair
Center and Customer
Information Center:
Phone: (65) 272-5300
Extended Warranty Support:
Phone: (65) 272-5333

Spain

Hewlett-Packard Española, S.A.
Carretera de la Coruña km 16.500
E-28230 Las Rozas, Madrid
Phone: (34) (1) 626-1600
Fax: (34) (1) 626-1830

Sweden

Hewlett-Packard Sverige AB
Skalholtsgatan 9
S-164 97 Kista
Phone: (46) (8) 444-2000
Fax: (46) (8) 444-2666

Switzerland

Hewlett-Packard (Schweiz) AG
In der Luberzen 29
CH-8902 Urdorf/Zürich
Phone: (41) (084) 880-11-11
Fax: (41) (1) 753-7700
Warranty Support:
0800-55-5353

Taiwan

Hewlett-Packard Taiwan Ltd.
8th Floor
337, Fu-Hsing North Road
Taipei, 10483
Phone: (886)(02)717-0055
FAX : (886)(02)514-0276
Hardware Repair Center, call:
North (886)(02) 717-9673
Central (886)(04) 327-0153
South (886)(080)733-733
Extended Warranty Support Contact:
Phone: (886)(02) 714-8882

Thailand

Hewlett-Packard (Thailand) Ltd.
23-25/f Vibulthani Tower II
2199 Rama 4 Rd, Klongton
Klintoey, Bangkok 10110
Thailand
Phone: (66) (2) 666-3900-34
Fax: (66) (2) 666-3935-37
Hardware Repair Center and Extended
Warranty Support Contact:
Phone: (66) (2) 661-3900 ext. 6001/ 6002
Customer Information Center:
Phone: (66) (2) 661-3900 ext. 3211
Fax: (66) (2) 661-3943

Turkey

Hewlett-Packard Company
Bilgisayar Ve ölçüm Sistemleri AS
19 Mayıs Caddesi Nova
Baran Plaza Kat: 12
80220 Sisli-Istanbul
Phone: (90) (212) 224-5925
Fax: (90) (212) 224-5939

United Kingdom

Hewlett-Packard Ltd.
Cain Road
Bracknell
Berkshire RG12 1HN
Phone: (44) (134) 436-9222
Fax: (44) (134) 436-3344

Venezuela

Hewlett-Packard de Venezuela S.A.
Los Ruices Norte
3A Transversal
Edificio Segre Caracas 1071
Phone: (58) (2) 239-4244
Fax: (58) (2) 239-3080

A Specifications

Printer Specifications

	HP LaserJet 2100	HP LaserJet 2100 with Optional Tray 3
Height	230 mm (9 in.)	309 mm (12.2 in.)
Width	406 mm (15.9 in.)	406 mm (15.9 in.)
Depth (body)	420 mm (16.5 in.)	420 mm (16.5 in.)
Weight (with toner cartridge)	11.5 kg (25.4 lbs)	14.4 kg (31.7 lbs)

Electrical Specifications	100-127V (+/- 10%) 50/60Hz (+/- 2Hz)	220-240V (+/- 10%) 50/60 Hz (+/- 2Hz)
Power Consumption (typical for HP LaserJet 2100 Series Printers)	During printing 225 W (average) During standby 12 W (instant power save) During power save mode 12 W During off mode 0W	During printing 225 W (average) During standby 14 W (instant power save) During power save mode 14 W During off mode 0W
Minimum recommended circuit capacity	5 Amps	2.5 Amps

WARNING!

Power requirements are based on the region where the printer is sold. Do not convert operating voltages. This may damage the printer and void the product warranty.

Environmental Specifications	Operating Printing	Storage/Standby
Temperature (printer and toner cartridge)	15° to 32.5° C (59° to 89° F)	-20° to 40° C (-4° to 104° F)
Relative humidity	10% to 80%	10% to 90%

**Acoustic Emissions
(Per ISO 9296)
(HP LaserJet 2100
at 10 ppm)**

	Operator Position	Bystander (1m)	Sound Power
Printing	L _{pAm} 55dB(A)	L _{pAm} 48dB(A)	L _{WA} d 6.2 bels(A)

Power Save

In this mode, the printer is essentially quiet.

See "Printer Features" on page 2 for additional performance and features specifications

FCC Regulations

This equipment has been tested and found to comply with the limits for a Class B digital device, pursuant to Part 15 of the FCC rules. These limits are designed to provide reasonable protection against harmful interference in a residential installation. This equipment generates, uses, and can radiate radio frequency energy. If this equipment is not installed and used in accordance with the instructions, it may cause harmful interference to radio communications. However, there is no guarantee that interference will not occur in a particular installation; the presence of interference can be determined by turning the equipment off and on. If this equipment does cause harmful interference to radio or television communications, the user is encouraged to try to correct the interference by one or more of the following measures:

- Reorient or relocate the receiving antenna.
- Increase distance between equipment and receiver.
- Connect equipment to an outlet on a circuit different from that to which the receiver is located.
- Consult your dealer or an experienced radio/television technician.

Note

Any changes or modifications to the printer that are not expressly approved by HP could void the user's authority to operate this equipment.

Use of a shielded interface cable is required to comply with the Class B limits of Part 15 of FCC rules.

Environmental Product Stewardship Program

Protecting the Environment

Hewlett-Packard Company is committed to providing quality products in an environmentally sound manner. This HP LaserJet printer has been designed with several attributes to minimize impacts on our environment.

This HP LaserJet printer eliminates:

Ozone Production

The printer uses charging rollers in the electrophotographic process and therefore generates no appreciable ozone gas (O₃).

This HP LaserJet printer design reduces:

Energy Consumption

Energy usage drops to as little as 12 W while in low-power (PowerSave) mode. Not only does this save natural resources, but it also saves money without affecting the high performance of this printer. This product qualifies for ENERGY STAR. ENERGY STAR is a voluntary program established to encourage the development of energy-efficient office products. ENERGY STAR is a U.S. registered service mark of the U.S. EPA.

As an ENERGY STAR partner, Hewlett-Packard Company has determined that this product meets ENERGY STAR Guidelines for energy efficiency.



Toner Consumption

EconoMode uses significantly less toner, which may extend the life of the toner cartridge.

Paper use

You can request for a number of pages of your document to be printed on one page of paper. This N-up printing practice and the printer's manual duplexing feature, two-sided printing, can reduce paper usage and the resulting demands on natural resources.

The design of this HP LaserJet printer facilitates the recycling of:

Plastics

Plastic parts have markings according to international standards that enhance the ability to identify plastics for recycling purposes at the end of the printer's life.

HP Toner Cartridges

In many countries, this product's toner cartridge/drum can be returned to HP through the HP Planet Partners LaserJet Toner Cartridge Recycling Program. This easy to use program is available in over 20 countries. Multi-lingual program information and instructions are included in every new HP Toner Cartridge box.

HP Planet Partners LaserJet Toner Cartridge Recycling Program Information: Since 1990, the HP LaserJet Toner Cartridge Recycling Program has collected more than 12 million used toner cartridges that otherwise may have been discarded in the world's landfills. The HP LaserJet toner cartridges go to a collection center and then they are bulk shipped to our recycling partners who disassemble the cartridge parts for recycling. After a thorough quality inspection, minor parts such as nuts, screws, and clips are reclaimed for use in new cartridges. Remaining materials are separated and converted into raw materials for use by other industries to make a variety of useful products. Over 95% by weight of each returned cartridge is reclaimed for recycling. For more information in the U.S., call (1) (800) (340-2445) or visit the HP LaserJet Supplies website at <http://www.ljsupplies.com/planetpartners/>. Non-US customers can call the local HP Sales and Service Office for further information regarding the HP Planet Partners LaserJet Toner Cartridge Recycling Program.

Paper

This printer is suited for the use of recycled papers when the paper meets the guidelines outlined in the *HP LaserJet Printer Family Paper Specifications Guide*. See page 25 for ordering information. This printer is suitable for the use of recycled paper according to DIN 19 309.

Material Safety Data Sheet

The Toner Cartridge/Drum MSDS can be obtained by contacting the HP LaserJet Supplies website at:

<http://ljsupplies.com/planetpartners/datasheets.html>

If you do not have access to the Internet, call the U.S. HP FIRST (Fax Information Retrieval Service Technology) at (1) (800) 231-9300. Use Index number 7 for a listing of the Toner Cartridge/Drum Material/Chemical Safety Data Sheets. Non-US customers should refer to the front of this manual for appropriate phone numbers and information.

Regulatory Statements

Declaration of Conformity	
according to ISO/IEC Guide 22 and EN45014	
Manufacturer's Name:	Hewlett-Packard Company
Manufacturer's Address:	11311 Chinden Boulevard Boise, Idaho 83714-1021, USA
declares that the product	
Product Name:	HP LaserJet 2100, 2100 M, 2100 TN
Model Number:	C4170A, C4171A, C4172A, C4793A
Product Options:	ALL
conforms to the following Product Specifications:	
Safety:	IEC 950:1991+A1+A2+A3 / EN 60950:1992+A1+A2+A3 IEC 825-1:1993 / EN 60825-1:1994 Class 1 (Laser/LED)
EMC:	CISPR 22:1993+A1 / EN 55022:1994 Class B ¹ EN 50082-1:1992 IEC 801-2:1991 / prEN 55024-2:1992 - 4 kV CD, 8 kV AD IEC 801-3:1984 / prEN 55024-3:1991 - 3 V/m IEC 801-4:1988 / prEN 55024-4:1992 - 0.5 kV Signal Lines 1.0 kV Power Lines IEC 1000-3-2:1995 / EN61000-3-2:1995 IEC 1000-3-3:1994 / EN61000-3.3:1995 FCC Title 47 CFR, Part 15 Class B ²) / ICES-003, Issue 2 / VCCI-2 ¹) AS / NZS 3548:1992 / CISPR 22:1993 Class B ¹)
Supplementary Information:	
The product herewith complies with the requirements of the following Directives and carries the CE-marking accordingly: the EMC directive 89/336/EEC the Low-Voltage Directive 73/23/EEC The product was tested in a typical configuration with Hewlett-Packard Personal Computer Systems. This Device complies with Part 15 of the FCC Rules. Operation is subject to the following two conditions: (1) this device may not cause harmful interference, and (2) this device must accept any interference received, including interference that may cause undesired operation.	
For Compliance Information ONLY, contact:	
Australia Contact:	Product Regulations Manager, Hewlett-Packard Australia Ltd., 31-41 Joseph Street, Blackburn, Victoria 3130, Australia
European Contact:	Your Local Hewlett-Packard Sales and Service Office or Hewlett-Packard GmbH, Department HQ-TRE / Standards Europe, Herrenberger Straße 130, D-71034 Böblingen (FAX: +49-7031-14-3143)
USA Contact:	Product Regulations Manager, Hewlett-Packard Company, PO Box 15 Mail Stop 160, Boise, ID 83707-0015 (Phone: 208-396-6000)

Laser Safety Statement

The Center for Devices and Radiological Health (CDRH) of the U.S. Food and Drug Administration has implemented regulations for laser products manufactured since August 1, 1976. Compliance is mandatory for products marketed in the United States. The printer is certified as a "Class 1" laser product under the U.S. Department of Health and Human Services (DHHS) Radiation Performance Standard according to the Radiation Control for Health and Safety Act of 1968.

Since radiation emitted inside the printer is completely confined within protective housings and external covers, the laser beam cannot escape during any phase of normal user operation.

WARNING!

Using controls, making adjustments, or performing procedures other than those specified in this user guide may result in exposure to hazardous radiation.

Canadian DOC Regulations

Complies with Canadian EMC Class B requirements.

«Conforme à la classe B des normes canadiennes de compatibilité électromagnétiques «CEM».»

LED Safety

The infrared port on the front panel of this printer is classified as a Class 1 LED (Light Emitting Diode) device according to International Standard IEC 825-1 (EN 60825-1). This device is not considered harmful, but the following precautions are recommended.

- If the printer requires service, contact an authorized HP service center.
- Do not attempt to make any adjustments of the printer.
- Avoid direct eye exposure to the infrared LED beam.
- Be aware that the beam is invisible light and cannot be seen.
- Do not attempt to view the infrared LED beam with any type of optical device.

VCCI Statement (Japan)

この装置は、情報処理装置等電波障害自主規制協議会(VCCI)の基準に基づくクラスB情報技術装置です。この装置は、家庭環境で使用することを目的としていますが、この装置がラジオやテレビジョン受信機に近接して使用されると、受信障害を引き起こすことがあります。
取り扱い説明書に従って正しい取り扱いをして下さい。

Korean EMI Statement

사용자 안내문 (B 급 기기)

이 기기는 비업무용으로 전자파장해검정을 받은 기기로서, 주거지역에서는 물론 모든 지역에서 사용할 수 있습니다.

Laser Statement for Finland

LASERTURVALLISUUS

LUOKAN 1 LASERLAITE

KLASS 1 LASER APPARAT

HP LaserJet 2100 -laserkirjoitin on käyttäjän kannalta turvallinen luokan 1 laserlaite. Normaalisissa käytössä kirjoittimen suojakotelointi estää lasersäteiden pääsyn laitteen ulkopuolelle.

Laitteen turvallisuusluokka on määritetty standardin EN 60825-1 (1993) mukaisesti.

VAROITUS!

Laitteen käyttäminen muulla kuin käyttöohjeessa mainitulla tavalla saattaa altistaa käyttäjän turvallisuusluokan 1 ylittävälle näkymättömälle lasersäteilylle.

VARNING!

Om apparaten används på annat sätt än i bruksanvisning specificerats, kan användaren utsättas för osynlig laserstrålning, som överskrider gränsen för laserklass 1.

HUOLTO

HP LaserJet 2100 -kirjoittimen sisällä ei ole käyttäjän huollettavissa olevia kohteita. Laitteen saa avata ja huoltaa ainoastaan sen huoltamiseen koulutettu henkilö. Tällaiseksi huoltotoimenpiteeksi ei

katsota väriainekasetin vaihtamista, paperiradan puhdistusta tai muita käyttäjän käsikirjassa lueteltuja, käyttäjän tehtäväksi tarkoitettuja ylläpitotoimia, jotka voidaan suorittaa ilman erikoistyökaluja.

VARO!

Mikäli kirjoittimen suojakotelo avataan, olet alttiina näkymättömälle lasersäteilylle laitteen ollessa toiminnassa. Älä katso säteeseen.

VARNING!

Om laserprinterns skyddshölje öppnas då apparaten är i funktion, utsätts användaren för osynlig laserstrålning. Betrakta ej strålen.

Tiedot laitteessa käytettävän laserdiodin säteilyominaisuuksista:

Aallonpituus 770-795 nm

Teho 5 mW

Luokan 3B laser

B

Media Specifications

Overview

This printer accepts a variety of media, such as cut-sheet paper (including up to 100% recycled fiber content paper), envelopes, labels, transparencies, and custom-size paper. Properties such as weight, composition, grain, and moisture content are important factors affecting printer performance and output quality. Paper that does not meet the guidelines outlined in this manual can cause the following problems:

- Poor print quality.
- Increased paper jams.
- Premature wear on the printer, requiring repair.

Note

Some paper may meet all of the guidelines in this manual and still not produce satisfactory results. This might be the result of improper handling, unacceptable temperature and humidity levels, or other variables over which Hewlett-Packard has no control.

Before purchasing large quantities of paper, make sure the paper meets the requirements specified in this user guide and in the *HP LaserJet Printer Family Paper Specification Guide*. (For ordering information, see page 25). Always test paper before buying large quantities.

CAUTION

Using paper that does not meet HP specifications may cause problems for the printer, requiring repair. This repair is not covered by the Hewlett-Packard warranty or service agreements.

Supported Sizes of Paper

Tray 1	Dimensions ^a	Weight	Capacity ^b
Minimum Size (custom)	76 by 127 mm (3 by 5 in.)	60 to 163 g/m ² Bond (16 to 43 lb)	100 sheets of 80 g/m ² Bond (20 lb) paper
Maximum Size (custom)	216 by 356 mm (8.5 by 14 in.)		
Transparency	Same as minimum and maximum paper sizes listed above.	Thickness: .10 to .14 mm (0.0039 to 0.0055 in.)	75 typical
Labels ^c		Thickness: .10 to .14 mm (0.0039 to 0.0055 in.)	50 typical
Envelopes		Up to 90 g/m ² (16-24 lb)	up to 10

a. The printer supports a wide range of media sizes. Check the printer software for supported sizes. See "Printing on Custom-Sized Media or Cardstock" on page 39.

b. Capacity may vary depending on media weight and thickness, and environmental conditions.

c. Smoothness - 100 to 250 (Sheffield).

Note

You may experience some paper jams when using any media with a length less 178 mm (7 in.). This may be caused by paper that has been effected by environmental conditions. For optimum performance, make sure you are storing and handling the paper correctly. Please refer to "Printing and Paper Storage Environment" on page 144.

Tray 2 or Tray 3 Dimensions ^a		Weight	Capacity ^b
Letter	8.5 by 11 in. (216 by 279 mm)	16 to 28 lb Bond (60 to 105 g/m ²)	250 sheets of 20 lb Bond (80 g/m ²) paper
A4	210 by 297 mm (8.3 by 11.7 in.)		
Executive	7.3 by 10.5 in. (191 by 267 mm)		
Legal	8.5 by 14 in. (216 by 356 mm)		
B5 (ISO)	176 by 250 mm (6.9 by 9.9 in.)		
B5 (JIS)	182 by 257 mm (7.2 by 10 in.)		
A5	148 by 210 mm (5.8 by 8.2 in.)		
8.5 x 13 in.	216 by 330 mm (8.5 by 13 in.)		

a. The printer supports a wide range of media sizes. See "Printing on Custom-Sized Media or Cardstock" on page 39.

b. Capacity may vary depending on media weight and thickness, and environmental conditions.

Guidelines for Using Paper

For best results, use conventional 90 g/m² (24 lb) paper. Make sure the paper is of good quality, and free of cuts, nicks, tears, spots, loose particles, dust, wrinkles, voids, and curled or bent edges.

If you are unsure what type of paper you are loading (such as bond or recycled), check the label on the package of paper.

The following problems with paper cause print quality deviations, jamming, or even damage to the printer.

Symptom	Problem with Paper	Solution
Poor print quality or toner adhesion Problems with feeding	Too moist, too rough, too smooth, or embossed; faulty paper lot	Try another kind of paper, between 100-250 Sheffield, 4-6% moisture content
Dropouts, jamming, curl	Stored improperly	Store paper flat in its moisture-proof wrapping
Increased gray background shading/printer wear	Too heavy	Use lighter paper, open the rear output bin
Excessive curl problems with feeding	Too moist, wrong grain direction or short-grain construction	Open the rear output bin Use long-grain paper
Jamming, damage to printer	Cutouts or perforations	Do not use paper with cutouts or perforations
Problems with feeding	Ragged edges	Use good quality paper

Note

Do not use letterhead paper that is printed with low-temperature inks, such as those used in some types of thermography.

Do not use raised or embossed letterhead.

The printer uses heat and pressure to fuse toner to the paper. Make sure that any colored paper or preprinted forms use inks that are compatible with this fusing temperature (200° C or 392° F for 0.1 second).

Paper Specifications

Category	Specifications
Acid Content	5.5 pH to 8.0 pH
Caliper	.094-.18 mm (3.0-7.0 mils)
Curl in Ream	Flat within 5 mm (.02 in.)
Cut Edge Conditions	Cut with sharp blades with no visible fray.
Fusing Compatibility	Must not scorch, melt, offset, or release hazardous emissions when heated to 200° C (392° F) for .1 second.
Grain	Long Grain
Moisture Content	4% to 6% by weight
Smoothness	100-250 Sheffield

For complete paper specifications for all HP LaserJet printers, see the *HP LaserJet Printer Family Paper Specification Guide*.

Printing and Paper Storage Environment

Ideally, the printing and paper storage environment should be at or near room temperature, and not too dry or too humid. Remember paper is hygroscopic; it absorbs and loses moisture rapidly.

Heat works with humidity to damage paper. Heat causes the moisture in paper to evaporate, while cold causes it to condense on the sheets. Heating systems and air conditioners remove most of the humidity from a room. As paper is opened and used, it loses moisture, causing streaks and smudging. Humid weather or water coolers can cause the humidity to increase in a room. As paper is opened and used it absorbs any excess moisture, causing light print and dropouts. Also, as paper loses and gains moisture it can distort. This can cause paper jams.

As a result, paper storage and handling are as important as the paper-making process itself. Paper storage environmental conditions directly affect the feed operation.

Care should be taken not to purchase more paper than can be easily used in a short time (about 3 months). Paper stored for long periods may experience heat and moisture extremes, which can cause damage. Planning is important to prevent damage to a large supply of paper.

Unopened paper in sealed reams can remain stable for several months before use. Opened packages of paper have more potential for environmental damage, especially if they are not wrapped with a moisture-proof barrier.

The paper storage environment should be properly maintained to ensure optimum printer performance. The required condition is 20° to 24° C (68° to 75° F), with a relative humidity of 45% to 55%. The following guidelines should be helpful when evaluating the paper's storage environment:

- Paper should be stored at or near room temperature.
- The air should not be too dry or too humid (due to the hygroscopic properties of paper).
- The best way to store an opened ream of paper is to rewrap it tightly in its moisture-proof wrapping. If the printer environment is subject to extremes, unwrap only the amount of paper to be used during the day's operation to prevent unwanted moisture changes.

Envelopes

Envelope construction is critical. Envelope fold lines can vary considerably, not only between manufacturers, but also within a box from the same manufacturer. Successful printing on envelopes depends upon the quality of the envelopes. When selecting envelopes, consider the following components:

- **Weight:** The weight of the envelope paper should not exceed 105 g/m² (24 lb) or jamming may occur.
- **Construction:** Prior to printing, envelopes should lie flat with less than 6 mm (0.25 in.) curl, and should not contain air.
- **Condition:** Envelopes should not be wrinkled, nicked, or otherwise damaged.
- **Temperature:** You should use envelopes that are compatible with the heat and pressure of the printer.
- **Size:** You should use only envelopes within the following size ranges.

	Minimum	Maximum
Tray 1	76 by 127 mm (3 by 5 in.)	216 by 356 mm (8.5 by 14 in.)

Note

Use only Tray 1 to print envelopes.

You may experience some paper jams when using any media with a length less 178 mm (7 in.). This may be caused by paper that has been effected by environmental conditions. For optimum performance, make sure you are storing and handling the paper correctly. Please refer to "Printing and Paper Storage Environment" on page 144.

Envelopes with Double Side Seams

Double side-seam construction has vertical seams at both ends of the envelope rather than diagonal seams. This style may be more likely to wrinkle. Be sure the seam extends all the way to the corner of the envelope as illustrated below.

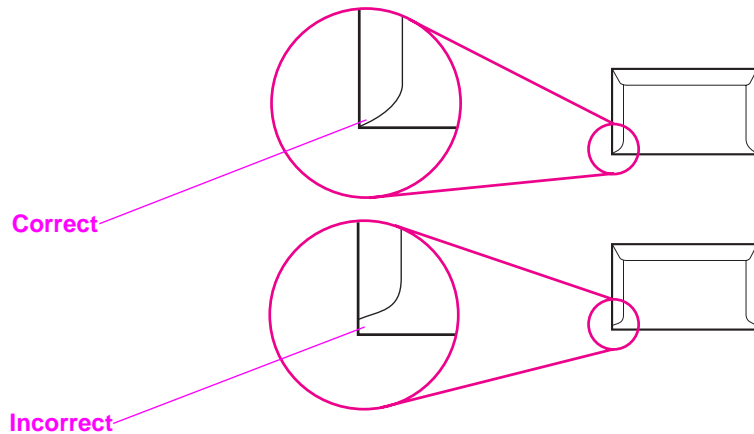

Envelopes with Adhesive Strips or Flaps

Envelopes with a peel-off adhesive strip or with more than one flap that folds over to seal must use adhesives compatible with the heat and pressure in the printer. The extra flaps and strips might cause wrinkling, creasing, or even jams and may even damage the fuser.

Envelope Margins

The following gives typical address margins for a commercial #10 or DL envelope.

Type of Address	Top Margin	Left Margin
Return address	15 mm (0.6 in.)	15 mm (0.6 in.)
Delivery address	51 mm (2 in.)	89 mm (3.5 in.)

Note

For the best print quality, position margins no closer than 15 mm (0.6 in.) from the edges of the envelope.

Avoid printing over the area where the envelope's seams meet.

Envelope Storage

Proper storage of envelopes helps contribute to print quality. Envelopes should be stored flat. If air is trapped in an envelope, creating an air bubble, then the envelope may wrinkle during printing.

See "Printing on Envelopes" on page 35.

Labels

CAUTION

To avoid damaging the printer, use only labels recommended for laser printers, such as HP-brand labels. (For ordering information, see page 25.)

To prevent serious jams, always use Tray 1 to print labels and always use the rear output bin.

Never print on the same sheet of labels more than once or print on a partial sheet of labels.

Label Construction

When selecting labels, consider the quality of each component:

- **Adhesives:** The adhesive material should be stable at 200° C (392° F), the printer's fusing temperature.
- **Arrangement:** Only use labels with no exposed backing between them. Labels can peel off sheets with spaces between the labels, causing serious jams.
- **Curl:** Prior to printing, labels must lie flat with no more than 13 mm (.5 in.) of curl in any direction.
- **Condition:** Do not use labels with wrinkles, bubbles, or other indications of separation.

See "Printing on Labels" on page 37.

Transparencies

Transparencies used in the printer must be able to withstand 200° C (392° F), the printer's fusing temperature.

CAUTION

To avoid damaging the printer, use only transparencies recommended for use in laser printers, such as HP-brand transparencies. (For ordering information, see page 25.)

See "Printing on Transparencies" on page 38.

C Printer Memory and Expansion

Overview

- Printer Memory
- Installing Memory
- Checking Memory Installation
- Installing an HP JetDirect EIO Card

Printer Memory

The printer has three dual in-line memory module (DIMM) slots for upgrading with:

- More printer memory. DIMMs are available in 4, 8, and 16 MB, for a maximum of 52 MB.
- DIMM-based accessory fonts, macros, and patterns.
- Other DIMM-based printer languages and printer options.

See “Accessories and Ordering Information” on page 23.

Note

Single in-line memory modules (SIMMs) used on previous HP LaserJet printers are not compatible with the printer.

You may want to add more memory to the printer if you often print complex graphics or PS documents, or use many downloaded fonts. To find out how much memory is installed in the printer, print a configuration page by pressing **Go** and **JOB CANCEL** while the printer is in the Ready state.

Installing Memory

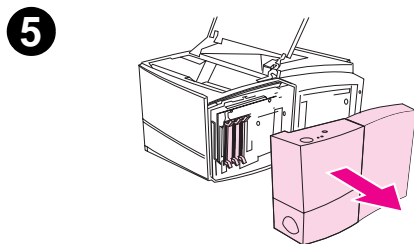
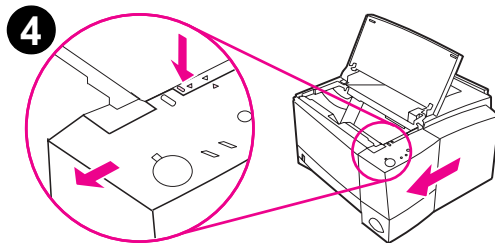
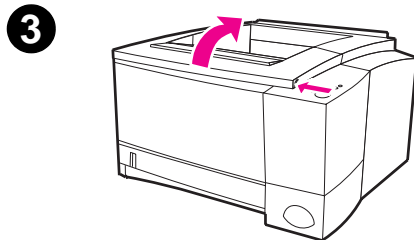
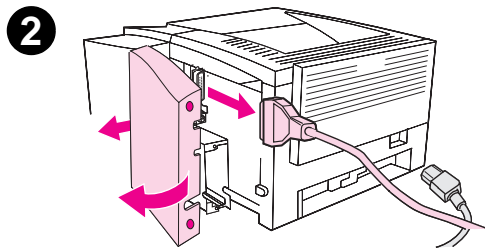
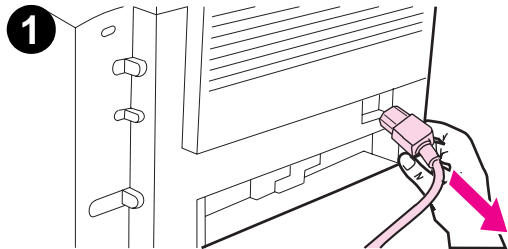

CAUTION

Static electricity can damage dual in-line memory modules (DIMMs). When handling DIMMs, either wear an antistatic wrist strap or frequently touch the surface of the DIMMs' antistatic package, then touch bare metal on the printer.

If you have not already done so, print a configuration page to find out how much memory is installed in the printer before adding more memory.

- 1 After the configuration page is printed, turn the printer off and disconnect the power cord.
- 2 Open the interface cable door by pressing on the release tabs. Disconnect all interface cables.
- 3 Open the top cover.
- 4 Press the release button and slide the right side panel forward until the alignment arrows line up.
- 5 Pull the panel away from the printer, exposing the available DIMM slots.

Continued on next page

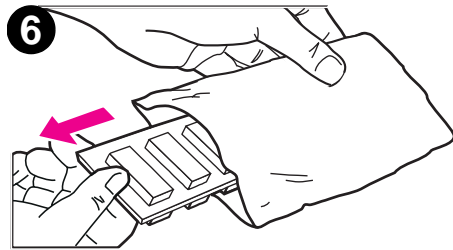

6 Remove the DIMM from the antistatic package.

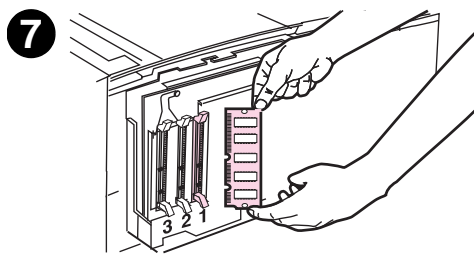

7 Holding the DIMM by the edges, align the notches on the DIMM with the DIMM slot. (Check that the locks on each side of the DIMM slot are open.)

Note

For best results use DIMM Slots in 1-2-3 order.

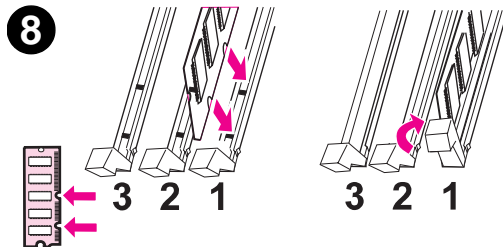

8 Press the DIMM straight into the slot (press firmly). Make sure the locks on each side of the DIMM snap inward into place. (To remove a DIMM, the locks must be released.)

Repeat steps 6, 7, and 8 for each DIMM being installed.

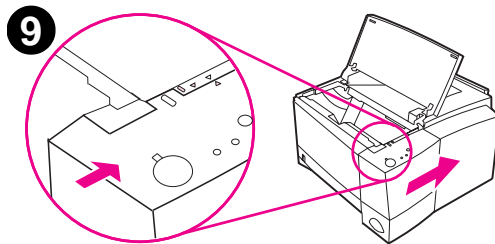

9 To replace the side panel, line up the alignment arrows and slide the panel backwards until the release button latches into place. Close the top cover.

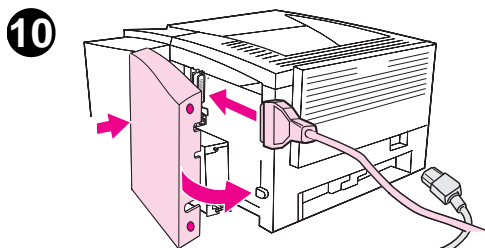

10 Reinstall the interface cable(s) and power cord. Turn the printer on.

Checking Memory Installation

To verify that DIMMs are installed correctly:

1. Turn the printer on. Check that the printer control panel displays the Ready light after the printer has gone through the startup sequence. If an error message appears, a DIMM may have been incorrectly installed. See “Troubleshooting Error Messages” on page 99.
2. Print a configuration page by pressing the **Go** and **Job Cancel** buttons simultaneously.
3. Check the memory section on the configuration page and compare it with the configuration page printed before the DIMM installation.

If the amount of recognized memory has not increased:

- The DIMM may not be installed correctly (repeat the installation procedure).
- Try another DIMM Slot.
- The DIMM may be defective (try a new DIMM).

Note

If you installed a printer language (personality), check the Installed Personalities and Options section on the configuration page. This area should list the new printer language.

Installing an HP JetDirect EIO Card

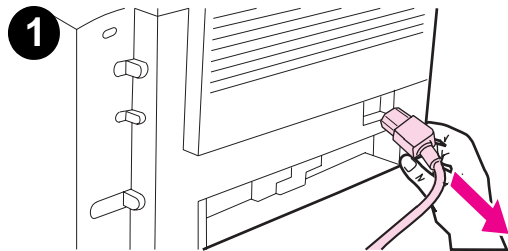

1 Turn the printer off, and disconnect the power cord.

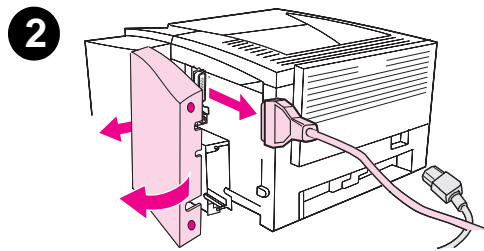

2 Open the interface cable door by pressing on the release tabs. Disconnect all interface cables.

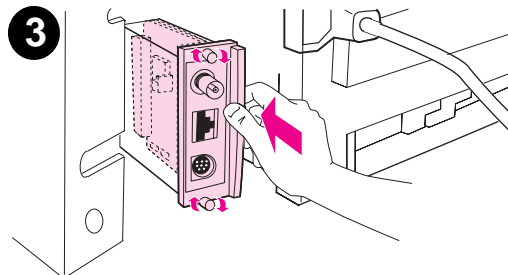

3 Locate the EIO Slot. Firmly insert the HP JetDirect EIO card into the EIO slot. Twist in the retaining screws.

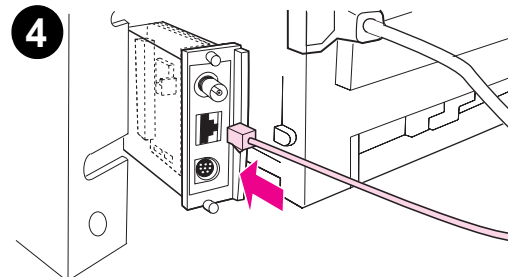

4 Attach the appropriate network cable to the EIO card.

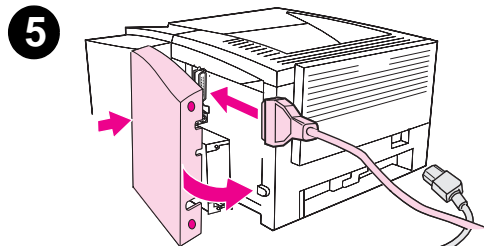

5 Reinstall the interface cable(s) power cord. Reinstall the interface cable door. Turn the printer on.

Note

Print a PCL configuration page to check that the HP JetDirect EIO card appears as an installed option.

D Printer Commands

Overview

Most software applications do not require you to enter printer commands. See your computer and software documentation to find the method for entering printer commands, if needed.

PCL

PCL printer commands tell the printer which tasks to perform or which fonts to use. This appendix provides a quick reference for users who are already familiar with PCL command structure.

The PCL 5e printer commands are backward-compatible with previous versions of PCL.

The PCL 6 printer commands take full advantage of the printer's features.

HP-GL/2

The printer has the ability to print vector graphics using the HP-GL/2 graphics language. Printing in the HP-GL/2 language requires that the printer leave PCL language and enter HP-GL/2 mode, which can be done by sending the proper PCL codes. Some software applications switch languages through their drivers.

PJL

HP's Printer Job Language (PJL) provides control above PCL and other printer languages. The four major functions provided by PJL are:

- printer language switching
- job separation
- printer configuration
- status readback from the printer

PJL commands may be used to change printer default settings

Note

The table at the end of this appendix contains commonly used PCL 5e commands. For a complete listing and explanation of how to use PCL, HP-GL/2, and PJL commands, order the *PCL/PJL Technical Reference Documentation Package*. See "Supplementary Documentation" on page 25.

To receive more information about printer commands via fax, call HP FIRST (Fax Information Retrieval Service Technology) and request an index for HP LaserJet printers. (See the HP Support pages at the front of this user guide.)

Understanding PCL Printer Command Syntax

Before using printer commands, compare these characters:

Lowercase l:	l	Uppercase O:	O
Number one:	1	Number 0:	0

Many printer commands use the lowercase letter l (l) and the number one (1), or the uppercase letter O (O) and the number zero (0). These characters may not appear on your screen as shown here. You must use the exact character and case specified for PCL printer commands.

The following illustration displays the elements of a typical printer command (in this instance, a command for page orientation).

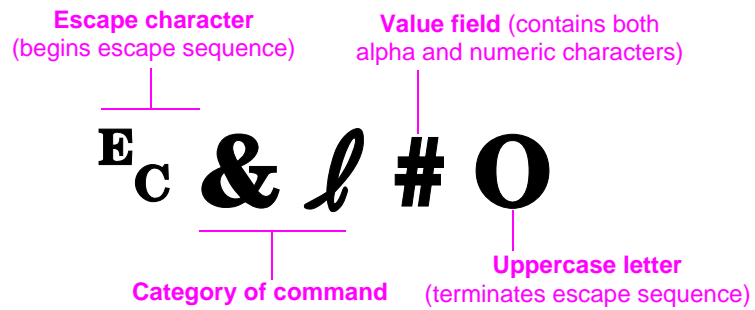

Combining Escape Sequences

Escape sequences may be combined into one escape sequence string. There are three important rules to follow when combining code:

1. For each escape sequence, the first two characters after the ? character must be the same.
2. When combining escape sequences, change the uppercase (termination) character in each individual escape sequence to lowercase.
3. The final character of the combined escape sequence must be uppercase.

The following escape sequence string would be sent to the printer to select legal paper, landscape orientation, and 8 lines per inch:

```
? &l 3A? &l 1O? &l 8D
```

The following escape sequence sends the same printer commands by combining them into a shorter sequence:

```
? &l 3a1o8D
```

Entering Escape Characters

Printer commands always begin with the escape character (?).

The following table shows how the escape character can be entered from various DOS software applications.

DOS Software Application	Entry	What Appears
Lotus 1-2-3	Type \027	027
WordPerfect for DOS	Type <27>	<27>
MS-DOS Edit	Hold down Ctrl-P, and press Esc	..
MS-DOS Edlin	Hold down Ctrl-V, release, then press [^[

Selecting PCL Fonts

PCL printer commands for selecting fonts can be found on the PCL Font List. A sample section is shown below. Notice the two variable boxes for symbol set and point size:

```
Univers Medium      Scale      <esc>(  <esc>(s1p  v0s0b4148T
```

These variables must be filled in or the printer will use defaults. For example, if you want a symbol set that contains line-draw characters, select the 10U (PC-8) or 12U (PC-850) symbol set. Other common symbol set codes are listed in the table on page 161.

Note

Fonts are either “fixed” or “proportional” in spacing. The printer contains both fixed fonts (Courier, Letter Gothic, and Lineprinter) and proportional fonts (CG Times, Arial®, Times New Roman®, and others).

Fixed-spaced fonts are generally used in applications such as spreadsheets and databases, where it is important for columns to line up vertically. Proportional-spaced fonts are generally used in text and word processing applications.

Common PCL Printer Commands

Function	Command	Options (#)
----------	---------	-------------

Job Control Commands

Reset	? E	n/a
Number of Copies	? &l #X	1 to 999

Common PCL Printer Commands (continued)

Function	Command	Options (#)
Page Control Commands		
Paper Source	? &l #H	0 = prints or ejects current page 1 = Tray 2 2 = manual feed, paper 3 = manual feed, envelope 4 = Tray 1 5 = Tray 3 7 = auto select
Paper Size	? &l #A	1 = Executive 2 = Letter 3 = Legal 4 = A5 5 = A4 6 = B5-JIS 8 = 8.5 X 13 9 = B5 (ISO) 71 = Postcard (single size) 72 = Postcard (round trip) 80 = Monarch 81 = Commercial 10 90 = DL 91 = International C5 100 = B5 101 = Custom
Orientation	? &l #O	0 = Portrait 1 = Landscape 2 = Reverse Portrait 3 = Reverse Landscape
Top Margin	? &l #E	# = number of lines
Text Length (bottom margin)	? &l #F	# = number of lines from top margin
Left Margin	? &a #L	# = column number
Right Margin	? &a #M	# = column number from left margin
Horizontal Motion Index	? &k#H	1/120-inch increments (compresses print horizontally)

Common PCL Printer Commands (continued)

Function	Command	Options (#)
Vertical Motion Index	? &I	#C 1/48-inch increments (compresses print vertically)
Line Spacing	? &I	#D # = lines per inch (1, 2, 3, 4, 5, 6, 12, 16, 24, 48)
Perforation Skip	? &I	#L 0 = disable 1 = enable

Cursor Positioning

Vertical Position (Rows)	? &a#R	# = row number
Vertical Position (Dots)	? *p#Y	# = dot number (300 dots = 1 inch)
Vertical Position (Decipoints)	? &a#V	# = decipoint number (720 decipoints = 1 inch)
Horizontal Position (Columns)	? &a#C	# = column number
Horizontal Position (Dots)	? *p#X	# = dot number (300 dots = 1 inch)
Horizontal Position (Decipoints)	? &a#H	# = decipoint number (720 decipoints = 1 inch)

Programming Hints

End of Line Wrap	? &s#C	0 = Enable 1 = Disable
Display Functions On	? Y	n/a
Display Functions Off	? Z	n/a

Common PCL Printer Commands (continued)

Function	Command	Options (#)
Language Selection		
Enter PCL Mode	? %A	0 = Use previous PCL cursor position 1 = Use current HP-GL/2 pen position
Enter HP-GL/2 Mode	? %B	0 = Use previous HP-GL/2 pen position 1 = Use current PCL cursor position
Font Selection		
Symbol Sets	? (#	8U = HP Roman-8 Symbol Set 10U = IBM Layout (PC-8) (code page 437) Default Symbol Set 12U = IBM Layout for Europe (PC-850) (code page 850) 8M = Math-8 19U = Windows 3.1 Latin 1 9E = Windows 3.1 Latin 2 (commonly used in Eastern Europe) 5T = Windows 3.1 Latin 5 (commonly used in Turkey) 579L = Wingdings Font
Primary Spacing	? (s#P	0 = fixed 1 = proportional
Primary Pitch	? (s#H	# = characters/inch
Set Pitch Mode ^a	? &k#S	0 = 10 4 = 12 (elite) 2 = 16.5 - 16.7 (compressed)
Primary Height	? (s#V	# = points
Primary Style	? (s#S	0 = upright (solid) 1 = italic 4 = condensed 5 = condensed italic

Common PCL Printer Commands (continued)

Function	Command	Options (#)
Primary Stroke Wt.	? (s#B	0 = medium (book or text) 1 = semi bold 3 = bold 4 = extra bold
Typeface ^a	? (s#T	Print a PCL font list to view the command for each internal font.

a. The preferred method is to use the primary pitch command.

Index

Numerics

- 2-sided printing 40
- 3x5 cards
printing 39

A

- accessing the printer driver
44
- accessories 23
ordering 23–25
- acoustic emissions 130
- additional drivers,
obtaining 4

B

- background shading on
page 94
- basics, printer 1–22
- buttons 15
- buying paper 28

C

- canceling a print job 43
- cardstock 39
- characters improperly
formed 95
- checking memory
installation 155
- choosing driver 6
- cleaners
using on printer 73
- cleaning
engine 73
exterior 73
starting the cleaning
process 74
toner cartridge 73
- cleaning process 84
- clearing paper jams 85
- commands, printer 157–
165
escape sequences 160
selecting PCL fonts 161
syntax 158–160
- compact disc 4
- configuration page 84
- control panel 15
buttons 15

- light patterns 16
- locking 11
- troubleshooting 99
- custom sized paper 39

D

- deleting fonts 7
- demo page 84
- diagnostics, printer 7
- DIMM
checking installed
memory 155
ordering 23
upgrading 152
- documentation,
supplementary
ordering 25
- DOS Remote Control
Panel
accessing 12
- drivers
OEM setup, See
Readme on installation
disk.
setup 7
- drivers, printer
help software 6
selecting 6
switching languages 6
- dropouts 93
- duplex printing 40

E

- energy savings 3
- engine cleaning 73
- envelopes
orientation 35
printing on 35
specifications 145
- error messages 99
- escape sequences 160

F

- font list 84
- fonts
deleting 7
installing 7
- fonts, selecting PCL 161

- FontSmart
installing 7
managing fonts 7
- form feed
light message 17

G

- Go button 15
- graphics, vector 157

H

- help
online 6
printer driver 6
software 6
- Help button, in printer
driver 6
- help screens 6
- HP FontSmart
installing 7
managing fonts 7
- HP JetAdmin 7
- HP JetSend
installing 9
- HP LaserJet Utility
for Macintosh 11
- HP Printer Job Language
158
- HP worldwide sales and
service offices 124
- HP-GL/2 commands 157
- HP-UX 7

I

- image defect examples 92
- image defects
background shading on
page 94
dropouts 93
improperly formed
characters 95
repetitive defects
(vertical) 95
toner smearing on page
94
vertical lines on page 94
wavy characters 95
- index cards

- printing on 39
- infrared port
- printing with 21
- installing
 - fonts 7
 - FontSmart 7
 - JetSend 9
- installing printer memory 153–155
- internal cleaning procedure 75

J

- JetAdmin
 - networks compatible with 7
- JetSend
 - installing 9
- Job Cancel button 15

L

- label
 - orientation 37
- labels
 - specifications 148
- language switching 3
- languages
 - switching 6
- Laser Writer driver 11
- LaserJet Utility 11
- latest drivers, obtaining 4
- legal paper
 - loading in Tray 2 33
- letterhead
 - printing on 42
- light locations 15
- locking control panel 11

M

- Macintosh
 - printer drivers 11
 - printing errors 111
 - selecting alternate PPD 113
 - software for 11
 - troubleshooting 110
- maintenance
 - printer 69
- media accessories
 - ordering 24
- media input options 29
- media sizes
 - Tray 1 29
 - Tray 2 30
- memory

- checking installation 155
- expanding 153–155
- installing 153–155
- ordering 23
- upgrading printer's 152
- memory features 3
- MS Windows 3.1, 95, or NT
 - help 6
 - network software 7
 - software 7

N

- network administrator
 - software 7
- network issues
 - troubleshooting 107
- Novell Netware 7
- N-up printing 50

O

- online help 6
- overhead transparencies
 - specifications 149

P

- paper 139
 - 3-hole punch orientation 42
 - 3x5 cards 39
 - custom sized 39
 - guidelines 142
 - postcards 39
 - purchasing 28
 - size specifications 140
- paper handling
 - accessories
 - ordering 24
- paper handling features 2
- paper jam
 - areas 85
 - causes 85
 - output areas 89
 - toner cartridge area 86
 - Tray 2 paper feed area 88
- paper selection
 - default 29
- paper sizes
 - loading in Tray 2 33
 - maximum 29
 - minimum 29
- paper width guide
 - Tray 1 31
- part numbers 23
- PCL

- commands 157–165
 - selecting fonts 161
 - syntax 158–160
- PCL 5e drivers
 - function 6
- PCL 6 drivers
 - function 6
- PCL language features 2
- PJL commands 158
- postcards
 - printing 39
- PPDs
 - Macintosh 11
 - selecting alternate 113
- print defects
 - vertical on page 95
- print quality features 2
- print quality problems 91
- print speed 2
- printer
 - accessories 23
 - basics 1–22
 - checking installed
 - memory 155
 - cleaning 73
 - commands 157–165
 - diagnostics 7
 - drivers 6
 - drivers, Macintosh 11
 - help software 6
 - installing memory 153–155
 - maintenance 69
 - memory 153
 - redistributing toner 71
 - renaming 113
 - repacking 118
 - selecting drivers 6
 - service 117
 - software 4
 - syntax for commands 158–160
 - upgrading memory 152
- printer drivers
 - accessing 44
 - help software 6
 - software 7
 - windows 6
- printer features 2
- Printer Page Description Files, see PPDs
- printer settings
 - changing in DOS from RCP 12
- printing
 - canceling print job 43

- double sided 40
 - duplexing 40
 - envelopes 35
 - forms 42
 - labels 37
 - letterhead 42
 - multiple pages on one sheet 50
 - postcards 39
 - preparing for 28
 - quality guidelines 142
 - stopping print job 43
 - transparencies 38
 - with low toner 71
 - printing languages 6
 - printing problems
 - troubleshooting 80
 - problem solving checklist 78
 - Product Stewardship 132–134
 - memory expansion 153–155
 - paper
 - recycled paper 139
 - specifications 143
 - product return 117
 - warranty
 - standard 121–122
 - PS drivers
 - function 6
 - purchasing paper 28
- Q**
- quality, printer
 - toner cartridge 71
 - quality, printing
 - guidelines for 142
- R**
- redistributing toner 71
 - Remote Control Panel
 - accessing 12
 - renaming the printer 113
 - repacking the printer 118
- S**
- sales and service offices 124
 - selecting
 - alternate PPD 113
 - self-test page, see configuration page
 - service agreements 120
 - Setup
 - driver only 7
 - software
 - drivers 7
 - help for drivers 6
 - HP FontSmart, installing 7
 - HP JetSend, installing 9
 - HP LaserJet Utility for Macintosh 11
 - included with printer 4
 - Macintosh 11
 - Macintosh printer drivers 11
 - Windows 6, 7
 - Solaris 7
 - special pages
 - cleaning process 84
 - configuration page 84
 - demo page 84
 - font list 84
 - specifications
 - envelopes 145
 - labels 148
 - paper size 140
 - transparencies 149
 - Status Messages
 - Attention 18
 - Continuable Error 19
 - Data 17
 - Fatal Error 19
 - Manual Feed with Pause 17
 - Paper out 18
 - Paper out (requested tray) 18
 - processing 17
 - Ready 16
 - Startup 16
 - stopping a print job 43
 - Sun OS 7
 - supplementary
 - documentation
 - ordering 25
 - supplies
 - ordering 23–25
 - support 117
 - switching printer languages 6
- T**
- toner cartridge 70
 - cleaning 73
 - ordering 23
 - recycling 70
 - warranty 123
 - toner cleaning 73
 - toner smearing on page 94
 - transfer roller 73
 - transparencies
 - printing on 38
 - specifications 149
 - Tray 1
 - capacity 31
 - loading 31
 - media sizes 29
 - media types 29
 - opening 31
 - paper sizes 140
 - Tray 2
 - changing paper sizes 33
 - media sizes 30
 - paper sizes 140
 - tray, optional
 - paper sizes 140
 - troubleshooting
 - control panel lights 99
 - error messages 99
 - general printing
 - problems 80
 - Macintosh printing
 - problems 110
 - PS problems 114
 - troubleshooting checklist 78
 - TrueType fonts 7
- U**
- UNIX, see HP-UX
- V**
- vector graphics 157
 - vertical lines on page 94
- W**
- warranty
 - toner cartridge 123
 - wavy characters 95
 - Windows
 - help 6
 - network software 7
 - software 7
 - wireless printing
 - background information 20



Copyright© 1998
Hewlett-Packard Co.
Printed in USA

Manual Part No.
C4170-90901

* C41 70- 90901 *
* C41 70- 90901 *

C4170-90901



Printed on at least
50% Total Recycled Fiber with
at least 10% Post-Consumer Paper

Free Manuals Download Website

<http://myh66.com>

<http://usermanuals.us>

<http://www.somanuals.com>

<http://www.4manuals.cc>

<http://www.manual-lib.com>

<http://www.404manual.com>

<http://www.luxmanual.com>

<http://aubethermostatmanual.com>

Golf course search by state

<http://golfingnear.com>

Email search by domain

<http://emailbydomain.com>

Auto manuals search

<http://auto.somanuals.com>

TV manuals search

<http://tv.somanuals.com>