

HP

2500C/CM

Professional Series Color Printer



USER'S GUIDE

Acknowledgments

HP ColorSmart II, HP PhotoREt II and HP ZoomSmart Scaling Technology are trademarks of Hewlett-Packard Company.

Microsoft is a U.S. registered trademark of Microsoft Corporation.

Windows is a trademark of Microsoft Corporation.

Adobe is a U.S. registered trademark of Adobe Systems Incorporated.

PostScript 3 is a trademark of Adobe Systems Incorporated.

Notice

The information contained in this document is subject to change without notice.

Hewlett-Packard makes no warranty of any kind with regard to this material, including, but not limited to, the implied warranties of merchantability and fitness for a particular purpose.

Hewlett-Packard shall not be liable for errors contained herein or for incidental or consequential damages in connection with the furnishing, performance, or use of this material.

No part of this document may be photocopied, reproduced, or translated to another language without the prior written consent of Hewlett-Packard Company.

Edition 1 – February 1999

©Copyright 1999 by Hewlett-Packard Company
450 Alexandra Road
Singapore 119960
Singapore

Printer Basics

System Requirements	1
Printer Features and Benefits	1
Printer Parts and Locations	2
Control Panel Layout	2
Control Panel Keys	3
LEDs	3

Setting Up

Step 1 - Unpack the Printer	4
Step 2 - Remove All Tapes from the Printer	5
Step 3 - Connect Cables	5
Step 4 - Set LCD language Preference	6
Step 5 - Install Ink Cartridges	7
Step 6 - Install Printheads	8
Step 7 - Load Paper in Tray 2	9
Step 8 - Load Paper in Tray 3	11
Step 9 - Align Printheads	12
Step 10 - Install the Printer Software	13

Basic Printing Tasks

Loading the Trays	15
Loading Media in Tray 1	15
Loading Media in the Rear Manual Feed	16
Monitoring and Replacing Ink Cartridges	16
Replacing Printheads	17
Using the HP 2500C Series Printer Software	18
PCL Printer Software Components	18
Changing Print Settings	19
Changing Print Options	19
Using the Printer on a Network	19
Printing with Special Features and Options	19

Maintaining the Printer

Clean Printheads	21
Align Printheads	21
Calibrate Color	22

Installing the PostScript Module	22
Installing Additional Memory	25
LCD Messages	
Control Panel Menus	27
Overview	27
Paper Handling Menu	28
Diagnostics Menu	29
Information Menu	29
Self Test Menu	30
Print Quality Menu	30
Printing Menu	31
IO Menu	32
Resets Menu	32
Configuration Menu	33
MIO Menu	33
PostScript Menu	33
Understanding Printer Messages	34
Troubleshooting	
General Troubleshooting Tips	37
Non-Recoverable Error	38
Troubleshooting Feature in Toolbox	38
To use the troubleshooting feature in the HP 2500C Series Toolbox in Windows 95, 98 and NT 4.0	38
To use the troubleshooting feature in the HP 2500C Series Toolbox in Windows 3.1x	38
Printer does not Print	39
Partial or Blank Page Printed	39
Bad or Poor Print Quality	40
Text or Graphics are Cut Off	40
Garbage Printed	41
Clearing Paper Jams	41
Tips for Avoiding Paper Jams	42
Printhead Diagnostics	42
Understanding the Diagnostic Test	44
Customer Support	45
HP Supplies and Accessories	48
Printer Specifications	50
Minimum Printing Margins	54
Hewlett-Packard Limited Warranty Statement	55
Declaration of Conformity	57
Regulatory Notices	59

Congratulations on your purchase of an HP 2500C/CM Professional Series Color Printer.

System Requirements

Please ensure that you have the following computer setup:

Minimum:

Windows 3.1x: 486DX-66, 8MB RAM
Windows 95/98: 486DX-100, 8MB RAM
Windows NT 4.0/5.0: 486DX-100, 16MB RAM
Macintosh System 7.5.3 or later: 68040, 8MB RAM

Recommended:

Windows 3.1x: Pentium 150/166, 16MB RAM
Windows 95/98, Pentium 150/166, 16MB RAM
Windows NT 4.0, Pentium 150/166, 32MB RAM
Macintosh System 8 or later: Power PC, 16MB RAM

50MB Free HardDisk space for 11" x 17" or A3 size printing.

Graphics intensive files may require more disk space.

Printer Features and Benefits

Seamless Workgroup Integration with Robust Network Features

- The HP 2500C/CM Color Printer supports all major networking operating systems and protocol.
- Easy printer setup, configuration and network printing management with HP JetAdmin and WebJetAdmin.
- The HP 2500CM Printer supports Adobe PostScript 3 for true document portability.
- User-friendly LCD and Key Panel for easy printer configuration, status and error messaging and reduced MIS intervention.

Significant Cost Savings and Speed Gains with HP's New Modular Ink Delivery System (MIDS).

- New half-inch printheads print larger swathes to achieve significant speed gains of up to 9.5 ppm black, 7.5 ppm color.
- HP's new Modular Ink Delivery System communicates with a smart chip built into each printhead and ink cartridge to monitor ink levels and printhead life.
- Printing in color becomes more affordable with lower costs per page.

Exceeds your Workgroup's Color Expectations with HP PhotoREt II (up to 13"x19")

- PhotoREt II uses the smallest ink drop size to create more shades of color, smoother transitions between tones, and crisper-looking output on any paper.
- Prints up to 13"x19" / A3 oversize when you need it.

Printer Parts and Locations

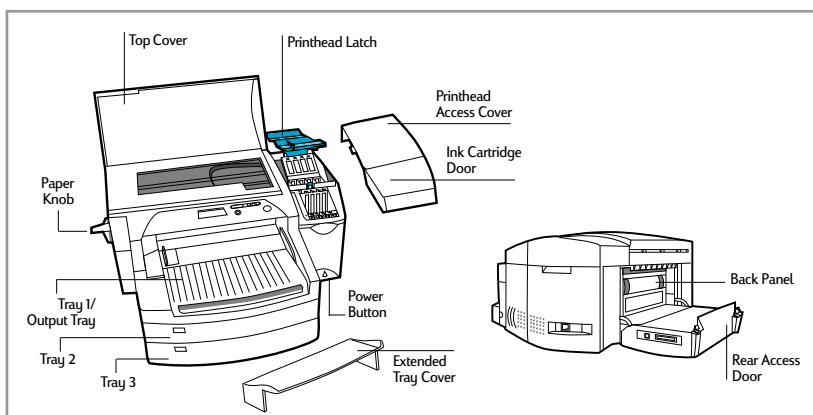

Control Panel Layout

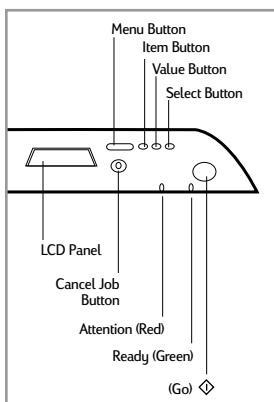

Control Panel Keys

◇ (Go)	<ul style="list-style-type: none"> Places the printer either online or offline. Allows the printer to resume printing after being offline. Clears most printer messages and places the printer online. Allows the printer to continue printing with a warning message such as TRAY x LOAD [TYPE] [SIZE] or UNEXPECTED PAPER SIZE. Exits the Control Panel menus. (To save a selected Control Panel setting, first press the [Select] button.) Displays non-recoverable error codes.
[Cancel Job]	Cancels the print job that the printer is processing. The time it takes to cancel depends on the size of the print job. (Press it only once.)
[Menu]	<p>Cycles through the Control Panel menus. To print a menu map from the Control Panel:</p> <ol style="list-style-type: none"> Press [Menu] until SELF TEST MENU appears. Press [Item] until PRINT MENU MAP appears. Press [Select] to print the menu map. <p>For information on each menu item, see LCD Messages.</p>
[Item]	Cycles through the selected menu's items.
[Value]	Cycles through the selected menu item's values.
[Select]	<ul style="list-style-type: none"> Saves the selected value for that item. An asterisk (*) appears next to the selection, indicating that it is the new default. Default settings remain when the printer is switched off or reset unless you reset all factory defaults from the [RESETS] menu. Prints the selected printer information page from the Control Panel.

LEDs

There are 2 lights or LEDs on the printer:

Led Indicators	Color	Function
Ready LED	Green	Is lit up when the printer is printing, in normal state, OR when it is online.
Attention LED	Red	<p>Blinks when the printer is in an error state, OR requires attention.</p> <p>For more information, see Troubleshooting section.</p>

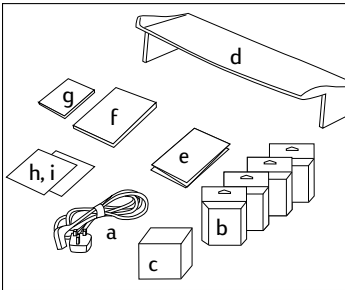

1. Check that the following items are included with the printer:
 - a. Power Cord
 - b. Four HP No. 10 Ink Cartridges (black, cyan, magenta and yellow)
 - c. Four HP No. 10 Printheads (black, cyan, magenta and yellow)
 - d. Extended Tray Cover
 - e. Setup Poster
 - f. Getting Started Guide
 - g. Quick Reference Guide
 - h. Starter CD
 - i. HP JetDirect CD (HP 2500CM printer only)

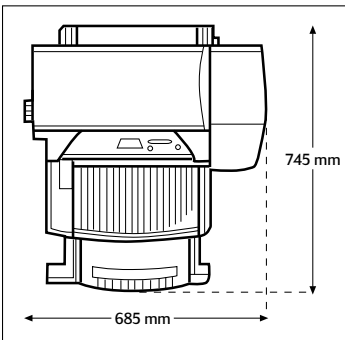

2. Prepare printer location.

The location requirements for the printer are:

 - A sturdy, level surface for placement
 - Space allowance around the printer
 - A well ventilated room
 - No exposure to direct sunlight or chemicals, including ammonia based cleaning solutions
 - Adequate power supply
 - A stable environment – no abrupt temperature or humidity changes
 - Relative humidity 20% to 80%
 - Room temperature 59° to 95°F (15° to 35°C)

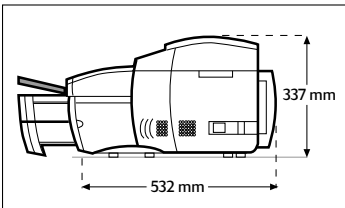

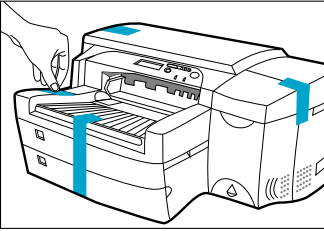
HP**2500C/CM****Step 2 - Remove All Tapes from the Printer**

1. Remove the four tapes securing the printer. Open the top cover and remove the fifth tape from the inside of the printer.

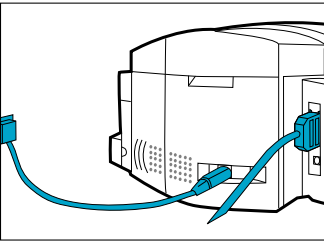
HP**2500C/CM****Step 3 - Connect Cables**

1. Ensure that the computer is turned off.
2. Plug the power connector firmly into the printer's power socket.
3. Plug the power plug into an electrical outlet.

To connect the printer directly to the computer:

1. Connect the printer end of the parallel cable firmly to the parallel port on the printer.
2. Snap both clips onto the notches on the connector.
3. Connect the computer end of the parallel port on your computer and tighten the screws on the connector.

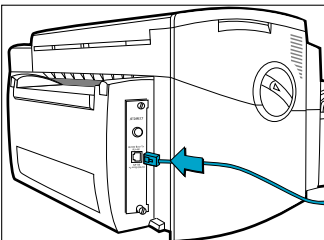

The HP 2500CM Professional Series Color Printer comes with a built-in HP JetDirect internal print server.

To connect the HP 2500CM printer to the network, plug the network cable into the network port on the print server. For more information on configuring the printer in a network environment, refer to the Network Guide which is available on your HP 2500C/CM Starter CD.

You can set the LCD Panel to display printer messages in one of the following languages:

- English
- German
- French
- Dutch
- Portuguese
- Italian
- Spanish
- Norwegian
- Finnish
- Swedish
- Danish
- Polish
- Czech
- Russian

To do so:

1. Ensure that the printer is turned off.
2. Press and hold [Menu] and turn on the printer.
3. Continue to hold down [Menu] until the LCD displays "LANG = X" (where "X" is the current language setting).
4. Press [Value] to scroll through the language list.
5. Press [Select] to choose and confirm your language selection.

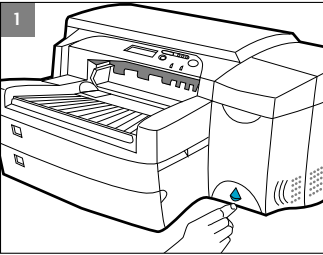

1. Press the Power button to turn on the printer.

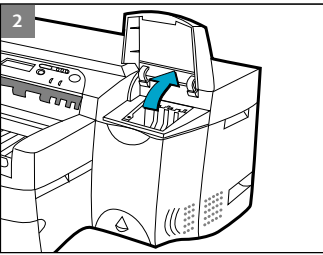

2. Lift to open the Ink Cartridge door.

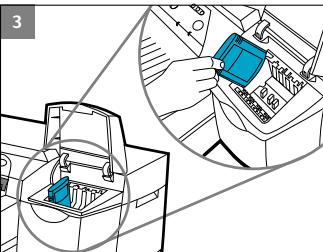

3. Remove all four ink cartridges from their packaging and insert each ink cartridge into its own color-coded slot. **Make sure that each cartridge is pressed firmly into place.**

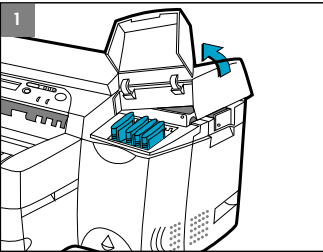

1. Make sure that the Ink Cartridge Door is open. Grasp the side of the Printhead Access Cover and lift up firmly to snap the cover open and completely remove it from the printer. You may have to use some force to open the cover.

Note: If the cradle cannot be found under the cover, it means that the tape securing the cradle has not been removed. Open the Top Cover, remove the tape securing the cradle, turn off the printer and turn on again.

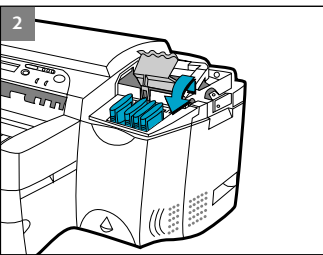

2. **Make sure the printer is turned ON.**

The cradle will move away slightly. Open the purple printhead latch by lifting the latch from the rear. Pull the latch forward and down to release the latch hook from the purple carriage lock. Then lift and push the latch toward the back of the printer.

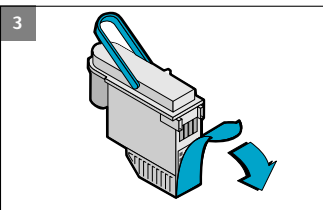

3. Remove each printhead from its package.
Remove the protective tape from each printhead.

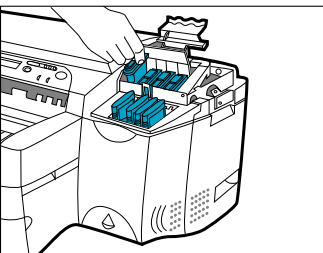

Insert each printhead into its own color-coded socket.
Push the printheads down firmly.

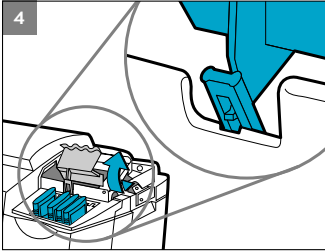

4. Close the printhead latch. Be sure that the hook on the printhead latch catches the carriage lock.

Note: You may have to use some force to close the printhead latch.

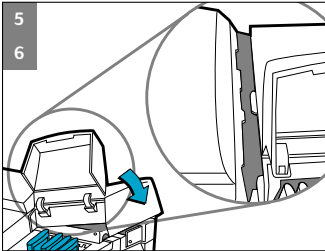

5. Ensure that the Ink Cartridge Door is lifted. Align the tabs of the cover with the tabs on the printer.
6. Lower and snap to close the cover.
7. Close the Ink Cartridge Door.

HP

2500C/CM

Step 7 - Load Paper in Tray 2

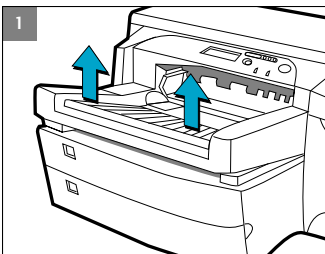

Note: Tray 2 is a fixed tray. Tray 1 has to be removed before Tray 2 can be accessed. Tray 2 is designed to hold up to 150 sheets of paper and can accommodate paper sizes such as Letter, A4, Legal, B4, A3, 11" x 17", 13" x 19" and 330 x 483 mm.

1. Remove Tray 1 and set it aside.

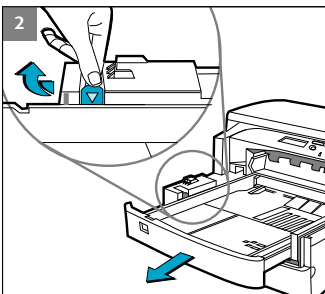

2. If you are loading paper sizes such as B4, A3, 11" x 17" and 330 x 483 mm, unlock the tray lock, extend the tray and re-lock the tray lock.

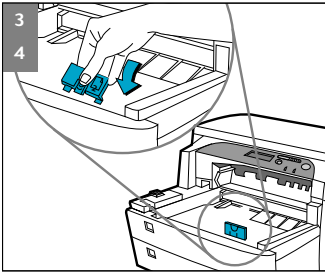

3. Unpack the Paper Length and Width guides.
4. Insert the Paper Length guide into the slot of the paper size you wish to load.

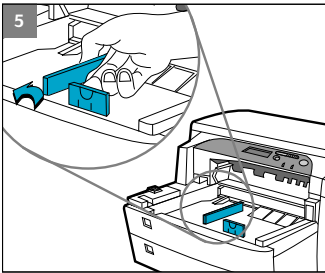

5. Insert the Paper Width guide into the slot of the paper size you wish to load.

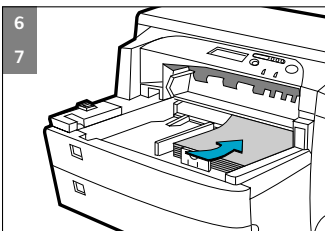

6. Insert paper, print side down into the printer.
7. Tap the left side of the stack of paper to ensure that it is flush against the right side of the tray.

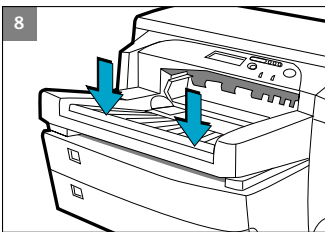

8. Replace Tray 1.

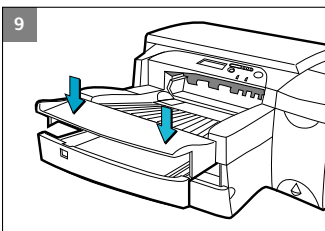

9. If Tray 2 is extended, place the Extended Tray Cover over the tray.
10. On the Control Panel, press [Menu] until PAPER HANDLING MENU appears.
11. Press [Item] to select TRAY 2 TYPE=
12. Press [Value] to select the media type you have loaded into the tray and press [Select].



[Click to see a video clip of the load Letter, A4 or Legal paper.](#)



[Click to see a video clip of the load B4, A3, 11" x 17", 13" x 19" or 330 x 483 mm paper.](#)

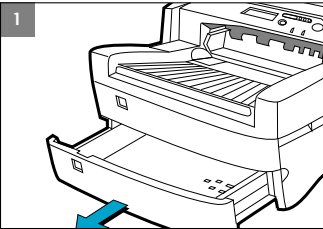

Note: Tray 3 is designed to hold up to 250 sheets of paper and can accommodate paper sizes such as Letter, A4, Legal, B4, A3, 11" x 17", 13" x 19" and 330 x 483 mm.

1. Grasp the sides of Tray 3 and pull it out of the printer.

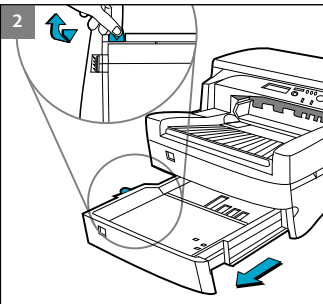

2. If you are loading paper sizes such as B4, A3, 11" x 17" and 330 x 483 mm, unlock the tray lock, extend the tray and re-lock the tray lock.

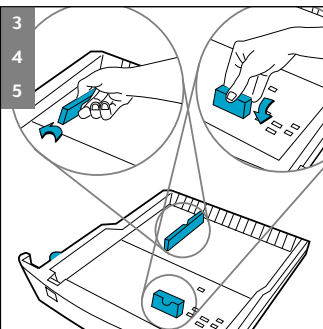

3. Unpack the Paper Length and Width guides.
4. Insert the Paper Length guide into the slot of the paper size you wish to load.
5. Insert the Paper Width guide into the slot of the paper size you wish to load.

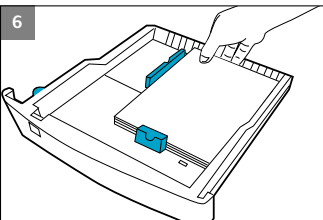

6. Load paper by aligning the paper edge to the Paper Length guide first. Tap the other end of the paper to ensure that the paper is properly loaded. Tap the left side of the stack of paper to ensure that it is flush against the right side of the tray.

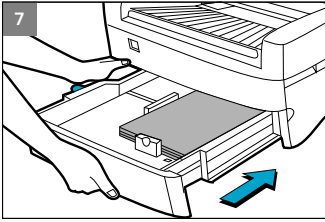

7. Re-insert Tray 3 into the printer.

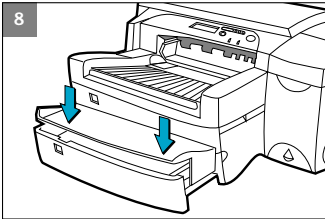

8. If Tray 3 is extended, place the Extended Tray Cover over the tray.
9. On the Control Panel, press [Menu] until PAPER HANDLING MENU appears.
10. Press [Item] to select TRAY 3 TYPE=
11. Press [Value] to select the media type you have loaded into the tray and press [Select].



[Click to see a video clip of the load Letter, A4 or Legal paper.](#)



[Click to see a video clip of the load B4, A3, 11" x 17", 13" x 19"](#)

HP

2500C/CM

Step 9 - Align Printheads

1. Press [Menu] until DIAGNOSTICS MENU appears.
2. Press [Item] until ALIGN PRNT-HDS appears.
3. Press [Select]
4. The printer will print a page with 5 sets of alignment patterns.
5. In each set (A, B, C, D, or E) select the most aligned (straightest) pair of lines (1, 2, 3, 4 or 5).
6. Enter the corresponding numbers in the Control Panel by pressing [Value].
7. When you have entered a value for a set, press [Item] to move to the next.
8. When you have finished entering the values, press [Select].
9. The printer will print a confirmation page consisting of 2 squares and a cross.
10. Check the confirmation page to see if the lines on the squares and the cross are aligned.
11. Re-align the printheads if the confirmation page is not satisfactory.

Before you can use the printer, you must install the printer software. To install the printer software, you need at least 8 MB of RAM and Microsoft Windows 3.1x, 95 or 98 installed in your computer.

To install the printer software in Windows NT 4.0, you need at least 16 MB of RAM and Windows NT 4.0 installed in your computer.

Installing the PCL Printer Software from the Starter CD into a PC

Note: The Starter CD includes a utility to easily copy the HP 2500C/CM software to 3.5-inch high-density diskettes as well as to copy files to a server. This allows you to use the diskettes to install the software on systems that do not have a CD-ROM drive.

1. Start Microsoft Windows and make sure no other Windows applications are running.
2. Insert the Starter CD into your CD-ROM drive. The installation program will run automatically.
3. Click the **Printer Driver** option followed by **Install** in the CD menu to install your printer software or **Download** to download the printer software to either a hard disk, network drive or floppy disks. If installation does not automatically run, follow the instructions below.

Installing PCL Printer Software from Floppy Disks (or the Starter CD, if the installation program does not run automatically)

1. Start Microsoft Windows and make sure no other Windows applications are running.
2. Insert Disk 1 into your computer's floppy drive (or the CD into the CD-ROM drive).
3. Select **File, Run** in Windows 3.1 or select **Start, Run** in Windows 95/98/NT 4.0.
4. At the Command Line Box,
 - For floppy disk installation, type the letter of your computer's floppy disk drive followed by `: \SETUP` (for example, `a:\setup`).
 - For CD installation, type the letter of your computer's CD-ROM drive followed by `: \INSTALL` (for example, `d:\install`).
5. Follow the instructions that appear on the screen to complete installation.

Customizing the Printer Software

You may choose to customize the printer software so that certain items or features such as Toolbox and bi-directional printing will be disabled the next time you install the printer software. This feature is useful if you want to install a customized configuration on several computers in a network.

To do this:

1. Download the printer software. During download, you will be asked if you wish to customize the printer software. If you choose not to, you may run the Installer Configuration Utility later by double-clicking on the HPINSCFG.EXE icon in the driver directory of the Starter CD.
2. Choose the options you wish to install.
3. Click OK.
4. The printer software will be installed according to this configuration the next time you run SETUP.EXE

Installing the PostScript Printer Software into a PC

Note: The PostScript Printer Software is available when you purchase a HP 2500CM Printer or the HP 2500C PostScript upgrade kit. For more information, see [HP Supplies and Accessories](#).

1. Start Microsoft Windows and make sure no other Windows applications are running.
2. Insert the **PostScript CD** into your CD-ROM drive.
3. Select **File, Run** in Windows 3.1 or select **Start, Run** in Windows 95/98/NT4.0.
4. At the Command Line Box, type the letter of your computer's CD-ROM drive followed by: **\INSTALL** (for example, d:\install).
5. Follow the instructions that appear on the screen to complete instructions.

Loading the Trays

The HP 2500C/CM Professional Series Color Printer has 3 paper trays and 1 Rear Manual Feed for superior paper handling capabilities.

Tray 1 - This tray holds up to 10 sheets of paper. It is recommended that you use this tray for media types and sizes that are seldom used.

Tray 2 - This tray holds up to 150 sheets of paper. It is recommended that you use this tray to hold paper that is commonly used.

[For instructions on how to load paper into Tray 2, see Step 7 in the Setting Up section.](#)

Tray 3 - This tray holds up to 250 sheets of paper. It is recommended that you use this tray to hold paper that is commonly used.

[For instructions on how to load paper into Tray 3, see Step 8 in the Setting Up section.](#)

Rear Manual Feed - The Rear Manual Feed is designed to provide a straight paper path for printing on thicker media (up to 0.3mm) such as cardstock or labels without bending. This paper path allows you to print only 1 sheet at a time.

Loading Media in Tray 1

1. Set your printer software to pick paper from Tray 1 and print your document.
[For more information on how to set your print settings, please refer to section on Changing Print Settings.](#)
2. After sending your print job to the printer, the LCD panel will display the message "TRAY 1 LOAD [TYPE] [SIZE]" where [TYPE] and [SIZE] are the media type and size as specified in your printer software.
3. Slide the paper width guide to its outermost position.
4. Insert up to 10 sheets of paper along the right side of Tray 1, print side down, until it stops.
5. Slide the paper width guide in until it stops at the edge of the paper.
6. Press the  button to print.

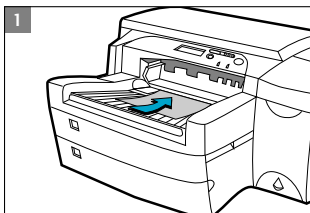

[Click to see a video clip of the above procedure.](#)

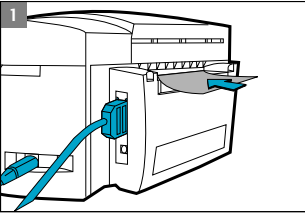

Loading Media in the Rear Manual Feed

1. Set your printer software to pick paper from Rear Manual Feed and print your document.
[For more information on how to set your print settings, please refer to the section on Changing Print Settings.](#)
2. After sending your print job to the printer, the LCD panel will display the message "MNL FEED LOAD [TYPE] [SIZE]" where [TYPE] and [SIZE] are the media type and size as specified in your printer software.
3. Insert the media into the Rear Manual Feed at the back of the printer, making sure that the edge of the sheet is aligned with the alignment mark on the left side of the slot. Wait for the printer to grip the media before releasing it.
4. Press  to start printing.



[Click to see a video clip of the above procedure.](#)

Monitoring and Replacing Ink Cartridges

The printer monitors and shows the amount of ink left in each ink cartridge on the LCD. When the ink in a particular ink cartridge is about to be used up, a warning message will appear on the LCD Panel. At this point, your ink cartridge will still have enough ink left in it for a few more print jobs. However, it is recommended that you get a replacement ready as soon as this warning message appears.

When the ink in a particular ink cartridge has fully run out, the LCD will display a message [X INK OUT, REPLACE CART] (where X is the color of the cartridge). When this happens, you will not be able to print until the corresponding cartridge is replaced.

To do this:

1. Lift to open the Ink Cartridge Door.

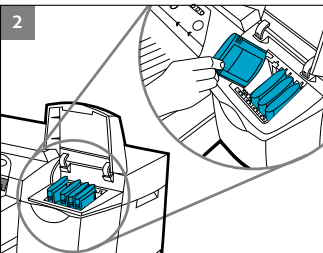
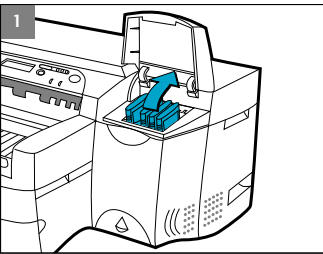

2. Remove the ink cartridge from its packaging and insert it into its own color-coded slot.
3. Push down the ink cartridge firmly.



[Click to see a video clip of the above procedure.](#)

Note:

Use only original No. 10 HP ink cartridges. The use of incompatible cartridges may disrupt the intricate printing system, potentially resulting in reduced print quality and even damaging the printer. HP does not guarantee non-HP cartridges or damage to the printer resulting from the use of non-HP cartridges. For more information on HP Supplies and Accessories, refer to page 48.

Replacing Printheads

If the printheads are faulty, the printer will show an error message and the printer will stop printing. When this happens, replace the printhead.

For more information, refer to the [Troubleshooting section](#).

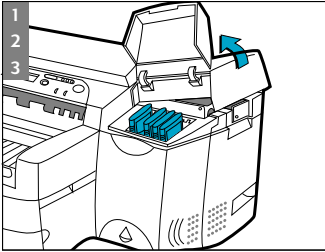

1. Ensure that the printer is on.
2. Open the Ink Cartridge Door.
3. Grasp the side of the Printhead Access Cover and lift firmly to snap the cover open and remove it from the printer. You may have to use some force to open the cover.

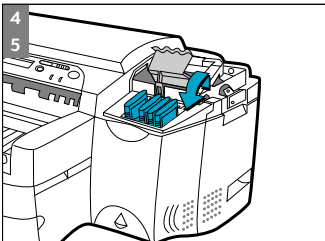

4. Release the printhead latch by pulling it towards you to unhook. Once unhooked, bring the latch towards the back of the printer.
5. Remove the damaged printhead by lifting it out of its socket.

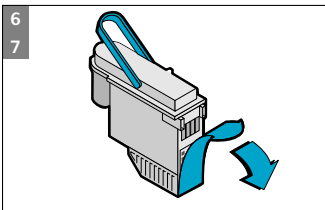

6. Remove the new printhead from its package.
7. Remove the protective tape from the printhead.

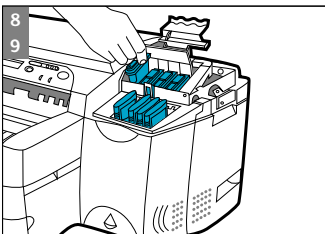

8. Insert the new printhead into its color-coded slot.
9. Push the printhead down firmly.

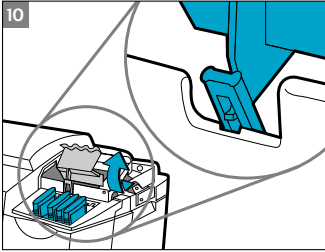

10. Close the printhead latch. Be sure that the hook on the printhead latch catches the carriage lock. You may have to use some force to close the printhead latch.

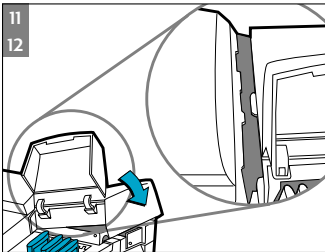

11. Ensure that the Ink Cartridge Door is lifted. Align the tabs of the cover with the tabs on the printer.
12. Lower and snap to close the cover.
13. Close the Ink Cartridge Door.
14. Align the printheads. [Refer to Step 9 – Align Printheads on page 12.](#)



[Click to see a video clip of the above procedure.](#)

Using the HP 2500C Series Printer Software

The HP 2500C Series color printer comes with 2 printer software that make printing from Windows-based programs faster and easier. The PCL driver is available for both the HP 2500C and the HP 2500CM printers. The PostScript driver is available for the HP 2500CM printer and is also found in the HP 2500C PostScript Upgrade Kit.

PCL Printer Software Components

The HP 2500C printer driver comes with the following components:

- **Toolbox** program provides access to all the information you need when using the printer. It also provides printer status information such as current print job and current print settings and the ability to cancel your print job.
- **Uninstaller** provides an easy and efficient way to uninstall the printer software and remove all entries pertaining to the printer software from the Windows registry.
- **Access HP Web Site** provides links to HP web sites for the latest printer software, product and support information.
- **WebReg** is an internet registration utility that allows you to register your printer through the Internet. Registration entitles you to receive prompt information about software upgrades and future HP products.

Changing Print Settings

Select Your Printer

To use your HP 2500 Series color printer, make sure that it is selected as the default printer.

In Windows 95, 98 or NT 4.0:

1. Click **Start**, select **Settings** followed by **Printers**.
2. Click the **HP 2500C Series Printer** icon to select it.
3. From the **File** menu, select **Set As Default**, then close the window.

In Windows 3.1

1. In the **Program Manager**, open the **Main** program group.
2. Double-click **Control Panel** to open it, then double-click **Printers**.
3. Select the **HP 2500C Series Printer** from the **Installed Printers** list, and then click **Set As Default Printer**.
4. Click **Close** and exit the Control Panel.

Changing Print Options

The HP 2500C Print Settings dialog box allows you to select printing options such as paper type and print quality that are not provided by the software application.

You can change the print settings for the current documents from your software program. This procedure will vary depending on the software program you are using.

1. Select either **Print**, **Print Setup** or **Printer Setup** from the **File** menu.
2. Click **Printer**, **Setup**, **Options** or **Properties** depending on your software application.
 - 3a. If you click **Printer** in step 2, you will need to click **Options**, then **Setup**.
 - 3b. If you click **Setup**, you will either see the HP Print Settings right away, or you will need to click **Options**.
 - 3c. If you click **Options**, you will need to click **Setup**.
 - 3d. If you click **Properties**, you will see the HP 2500C Print Settings dialog box right away.
4. Change the settings in the HP 2500C Print Settings dialog box.

Using the Printer on a Network

The HP 2500C Professional Series Color Printer has a slot where you may install one of the supported HP 2500C JetDirect MIO print servers.

Note:

- For a list of supported JetDirect MIO Print Servers, please refer to our web site at www.hp.com/go/hp2500.

Printing with Special Features and Options

The HP 2500C Series PCL printer driver allows you to create exciting and impactful documents easily. These features and options will help you to produce professional-looking documents like direct mailers, brochures, large spreadsheets, newsletters and extra large posters from your desktop.

HP ZoomSmart Scaling Technology

Allows you to automatically enlarge or reduce your printout.

Watermark

Allows you to create light-colored text that appears “behind” the document’s main text. When you print, the text appears faintly on the printout like the watermarks found on elegant stationery.

Mirror Image

Allows you to print a laterally inverted image of your page.

Print Page Border

Allows you to print dotted lines on the border of your document for cropping or marking purposes.

Billboard

Allows you to enlarge your page and prints sections of that page onto several sheets of paper to form a large poster. You may also use this feature to print a C or A-2 size document on 2 pieces of 11” x 17” or A3 size media by choosing the 1 x 2 option.

Handouts

Enables you to print 2, 4 or 8 pages of your document onto a single sheet of paper.

Booklet

Enables you to print 2 pages onto a single larger sheet and reorders the page sequencing so that the printouts can be folded in half to form a booklet.

2-sided Printing

Allows you to print on both sides of a page.

Select a Special Feature

1. Click on the Features tab in the print settings. [See Changing Print Settings.](#)
2. Select the required feature or option. You may only select one feature at a time and a combination of options.
[Note: Click on Help for explanations and descriptions of the various features and options.](#)
3. Change the necessary print settings and proceed to print your document.
[Note: For more information on printing using these special features, see the topic “Print with Special Features” on the “How Do I?” tab in the HP 2500C series Toolbox on your computer desktop.](#)

This section contains information on utilities for maintaining the printer. They include:

- Cleaning Printheads
- Aligning Printheads
- Calibrating Color

Clean Printheads

Whenever print quality noticeably decreases it is a good idea to perform the “Clean Printheads” utility either through the HP 2500C Toolbox on your computer or from the Control Panel on the printer. [Please refer to the Maintenance Tab of the Toolbox if you wish to clean the printheads from the Toolbox.](#)

The “Clean Printheads” utility consists of 3 levels of cleaning. Each level of cleaning uses some ink to clear the printheads. It is recommended that you start with Level 1 before proceeding to subsequent levels. Note that Level 3 takes the longest and uses the most ink.

To run the “Clean Printheads” utility through the Control Panel:

1. Press [Menu] until DIAGNOSTICS MENU appears.
2. Press [Item] to select either CLEAN PRNT-HDS LEVEL 1, 2 or 3.
3. Press [Select] to clean printheads.

Align Printheads

Although you may not notice misalignment in your printouts, it is recommended that you run the “Align Printheads” utility whenever the LCD displays the message “PRNT-HDS NOT ALIGNED”. This ensures that you have the best possible print quality.

You may align the printheads either through the Toolbox or from the Control Panel. Please refer to the Maintenance Tab of the Toolbox if you wish to align the printheads from the Toolbox.

To run the “Align Printheads” utility through the Control Panel:

1. Press [Menu] until DIAGNOSTICS MENU appears.
2. Press [Item] until ALIGN PRNT-HDS appears.
3. Press [Select].
4. The printer will print a page with 5 sets of alignment patterns.
5. In each set (A, B, C, D or E) select the most aligned (straightest) pair of lines (1, 2, 3, 4 or 5).
6. Enter the corresponding numbers in the Control Panel by pressing [Value].
7. When you have entered a value for a set, press [Item] to move to the next.

8. When you have finished entering the values press [Select].
9. The printer will print a confirmation page consisting of 2 squares and a cross.
10. Check the confirmation page to see if the lines on the squares and the cross are aligned.
11. Re-align the printheads if the confirmation page is not satisfactory.

Calibrate Color

If the color tints of your documents have shifted towards yellow, magenta or blue, run the “Calibrate Color” utility to balance the color tints. It is not advisable to calibrate color unless the shifts in color tints are visible.

To run the “Calibrate Color” utility:

1. Double-click on the HP 2500C Toolbox icon on your computer desktop.
2. Click on Maintenance tab.
3. Click on **Calibrate Color** and follow the instructions on the screen.

HP

2500C/CM

Installing the PostScript Module

The HP 2500CM Color Printer comes with the PostScript 3 module pre-installed. The HP 2500C Color Printer can be upgraded to a PostScript printer by installing the HP 2500C PostScript Upgrade Kit.

[See Supplies and Accessories.](#)

PostScript Printing Memory Requirements

The HP 2500C Color Printer has 4 MB of memory installed. After you install the PostScript Module, you will get an additional 8MB of memory.

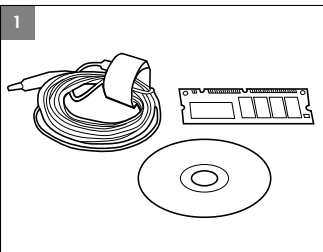

1. Put on the anti-static wrist strap and clip the other end to a grounded metal piece.

Note: Failure to do so may damage the printer or the memory module.

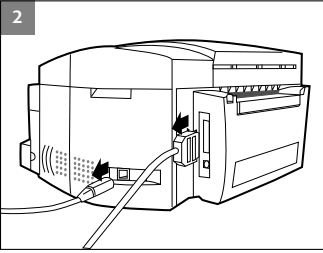

2. Switch off your printer and remove all cables from the back of the printer.

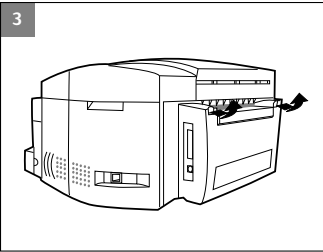

3. Lift up the 2 rear door latches to open the Rear Access Door.

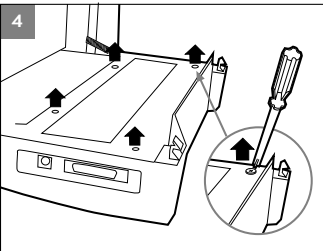

4. Loosen the 4 screws on the metal panel to remove it.

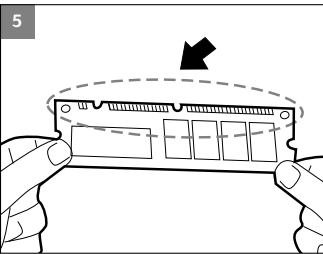

5. Remove the PostScript 3 Module from its package. DO NOT touch the metal connection points.

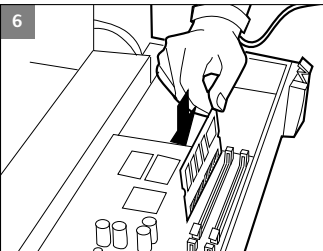

6. Position the PostScript 3 Module as shown in the illustration, and insert it into Slot 1 or 2.

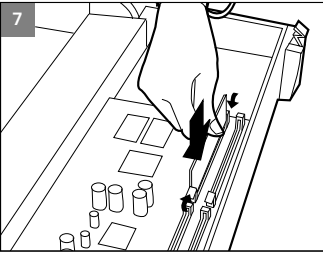

7. Push in the PostScript 3 Module until the 2 clips snap into place.

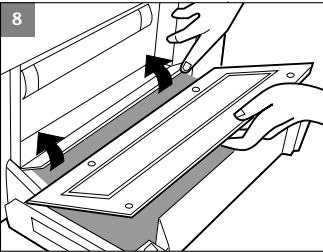

8. Lift the plastic flap, place the metal panel on the Rear Access Door and fasten the screws.

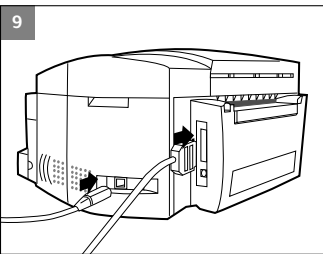

9. Reconnect all cables to the back of the printer and power ON the printer.

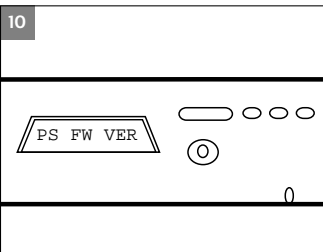

10. To verify installation of the PostScript 3 Module select the PostScript Firmware Version option in the Information Menu from the keypanel.

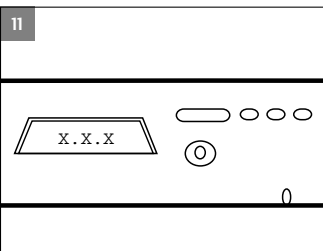

11. The installed PostScript Firmware Version is displayed on the LCD panel.

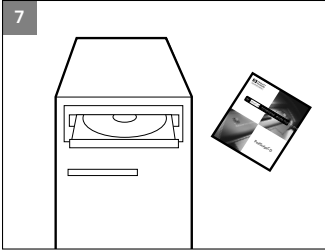

12. Install the PostScript 3 software from the accompanying CD. Refer to the back of the CD jacket for installation instructions.

HP

2500C/CM

Installing Additional Memory

If your printer has the PostScript module installed, you may install up to 64 MB of additional memory. See [Supplies and Accessories](#)

To do so:

1. Put on the anti-static wrist strap and clip the other end to a grounded metal piece.

Note: Failure to do so may damage the printer or the memory module.

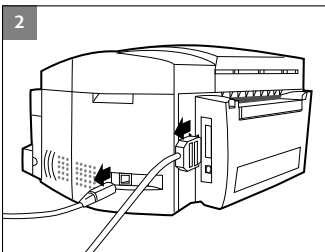
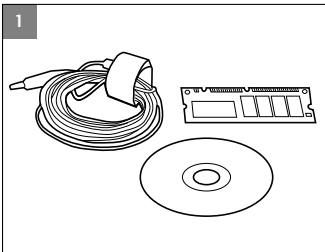

2. Switch off your printer and remove all cables from the back of the printer.

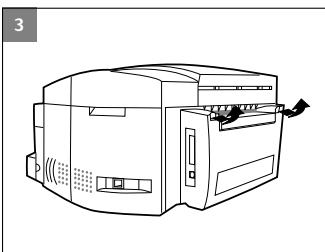

3. Lift up the 2 rear door latches to open the Rear Access Door.

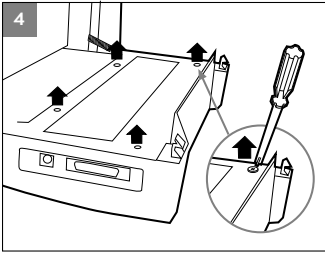

4. Loosen the 4 screws on the metal panel to remove it.

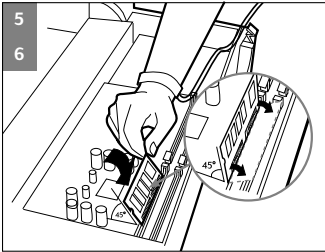

5. Insert the SIMM into SLOT 3 or 4 at a 45° angle.
6. Rotate the top of the SIMM until it is upright and clicks into position.

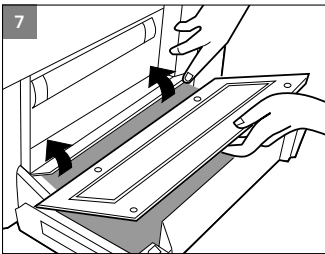

7. Lift the plastic flap, place the metal panel on the Rear Access Door and fasten the screws.

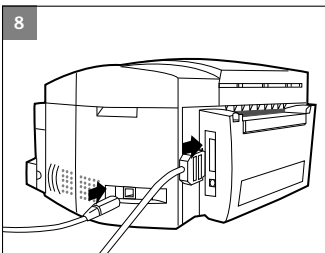

8. Reconnect all cables to the back of the printer and power ON the printer.

9. Press [MENU] until INFORMATION MENU appears. Press [ITEM] until CHECK TOTAL RAM SIZE appears and press [SELECT]. The LCD display should show the total amount of memory installed.

Control Panel Menus

Overview

You can perform most routine printing tasks from the computer through the printer driver. This is the most convenient way to change settings on the printer. See the Help files associated with the printer software, or for more information, [refer to the Windows Printing section](#).

You can also change the printer settings from the printer's Control Panel.

The following table lists the Menu items and possible values for the printer. Additional menu items can appear in the Control Panel, depending on the hardware modules installed in the printer.

Paper Handling Menu

Item	Values	Explanation
TRAY 2 TYPE=PLAIN	PLAIN HP INKJET/HEAVY HP PHOTO TRNSPRNCY/IRON RAPID TRNSPRNCY	<p>Set the value to correspond with the paper type currently loaded in Tray 2.</p> <p>PLAIN: Plain Paper</p> <p>HP INKJET/HEAVY: HP Premium Inkjet Paper or HP Premium Inkjet Heavyweight Paper</p> <p>HP PHOTO: HP Premium Photo Paper</p> <p>TRNSPRNCY/IRON: HP Premium Transparency Film or HP Iron-on T-shirt Transfers</p> <p>RAPID TRNSPRNCY: HP Premium Inkjet Rapid-Dry Transparencies.</p> <p>Note: It is not advisable to load the following combination of paper types in Tray 2 and Tray 3 at the same time:</p> <ul style="list-style-type: none"> • HP Premium Inkjet Paper and HP Premium Inkjet Heavyweight Paper • HP Premium Transparency Film and HP Iron-on T-shirt Transfer
TRAY 3 TYPE=PLAIN	PLAIN HP INKJET/HEAVY HP PHOTO TRNSPRNCY/IRON RAPID TRNSPRNCY	<p>Set the value to correspond with the paper type currently loaded in Tray 3.</p> <p>PLAIN: Plain Paper</p> <p>HP INKJET/HEAVY: HP Premium Inkjet Paper or HP Premium Inkjet Heavyweight Paper</p> <p>HP PHOTO: HP Premium Photo Paper</p> <p>TRNSPRNCY/IRON: HP Premium Transparency Film or HP Iron-on T-shirt Transfers</p> <p>Note: It is not advisable to load the following combination of paper types in Tray 2 and Tray 3 at the same time:</p> <ul style="list-style-type: none"> • HP Premium Inkjet Paper and HP Premium Inkjet Heavyweight Paper • HP Premium Transparency Film and HP Iron-on T-shirt Transfer

Diagnostics Menu

Item	Explanation
ALIGN PRNT-HDS	This item aligns the printheads to ensure the printout is of the best possible print quality. For more information see section on Align Printheads.
CLEAN PRNT-HD: LEVEL 1	This item cleans the printheads. Level 1 is the basic level and should be performed first. For more information see section on Clean Printheads.
CLEAN PRNT-HD: LEVEL 2	This item cleans the printheads. Level 2 is more thorough than Level 1, but it should be performed only when Level 1 cleaning does not solve the print quality problem. For more information see section on Clean Printheads.
CLEAN PRNT-HD: LEVEL 3	This item cleans the printheads. Level 3 is most thorough, but it should be performed only when Level 2 cleaning does not solve the print quality problem as it uses the most ink. For more information see section on Clean Printheads.
PERFORM TRAY 2 PAPER PATH TEST	This item performs a paper path test on Tray 2. When this is selected, the printer will pick paper from Tray 2 until all the paper has been ejected.
PERFORM TRAY 3 PAPER PATH TEST	This item performs a paper path test on Tray 3. When this is selected, the printer will pick paper from Tray 3 until all the paper has been ejected.
PERFORM TRAY 1 PAPER PATH TEST	This item performs a paper path test on Tray 1. When this is selected, the printer will pick paper from Tray 1 until all the paper has been ejected.

Information Menu

Item	Explanation
CHECK INK LEVEL	This item displays the amount of ink remaining in each ink cartridge.
BASE FW VER	This item displays the firmware version of the printer.
PS FW VER	This item displays the PostScript firmware version of the printer.
MIO FW VER	This item displays the MIO print server firmware version.
CHECK TOTAL RAM SIZE	This item displays the total amount of RAM installed in the printer.
SERVICE ID	This item displays the Service Identification Number of the printer. This number is needed when you call the HP Customer Care Center for support.

Self Test Menu

Item	Explanation
PRINT MENU MAP	The Menu Map shows the layout of the Control Panel menu items.
PRINT PS FONT LIST	The PS Font List shows all the PS fonts currently available to the printer.
PRINT DIAGNOSTIC PAGE	The Diagnostic Page shows general printer information and current network parameters.
PRINT EXT DIAGNOSTIC PAGE	The Extended Diagnostic Page shows printer information that is useful for troubleshooting.

Print Quality Menu

Item	Values	Explanation
PRINT QUALITY= NORMAL	NORMAL ECONOFAST BEST	<p>NORMAL: Normal mode delivers high quality output and is the recommended setting for speed and quality. Normal mode is the default setting for most paper types.</p> <p>ECONOFAST: Draft quality printing. EconoFast mode prints faster than Normal mode and delivers comparable output. Using EconoFast will also cut down on the frequency of replacing your ink cartridges because it uses less ink. EconoFast printing is available only when you select plain paper or transparency as the paper type.</p> <p>BEST: High quality printing. Best mode produces the highest print quality for all paper types. However, Best mode prints more slowly than Normal mode for most documents.</p>

Printing Menu

Item	Values	Explanation
PAPER=LETTER	LETTER LEGAL 13 x 19 A4 A3 11 x 17 JISB4	Set the paper size.
ORIENTATION= PORTRAIT	PORTRAIT LANDSCAPE	Determine the default orientation of print on the page. Note: It is best to set the page orientation from the printer software or software application.
APPEND CR TO LF=	NO YES	Select YES to append a carriage return to a line feed encountered in backward-compatible PCL jobs (pure text, no job control). Some environments indicate a new line using only the line feed control code. This option allows the user to append the required carriage return to each line feed.

IO Menu

Item	Values	Explanation
IN JOB TIMEOUT=15	5 to 300	Select the amount of time (in seconds) that the printer will wait within a print job before ending it. When the data from a print job fails to be sent to the printer completely, the printer will wait for the specified number of seconds. After that, it will abort the job and carry on to process the next print job. Press [Value] once to change the setting by increments of 1 or hold down [Value] to scroll.
OUT JOB TIMEOUT=15	0 to 300	Select the amount of time (in seconds) that the printer will wait for the next print job before switching to another port. This is useful especially when your printer is connected to 2 different ports such as the parallel port and the network port. Press [Value] once to change the setting by increments of 1 or hold down [Value] to scroll.
I/O CHANNEL TIMEOUT=120	0 to 300	Select the amount of time (in seconds) that the printer will receive data from a port before switching to the next port. When the printer is connected to different ports with data being sent to it simultaneously from these ports, the printer will be able to toggle between ports so that jobs sent through all ports will be given similar priority. Press [Value] once to change the setting by increments of 1 or hold down [Value] to scroll.

Resets Menu

Item	Explanation
RESET TO FACTORY SETTINGS	This item performs a simple reset and restores most of the factory (default) settings. This item also clears the input buffer for the active I/O.
RESET ACTIVE I/O CHANNEL	This item performs a simple reset and clears the input and output buffers (for the active I/Os only).
RESET ALL I/O CHANNELS	This item performs a simple reset and clears the input and output buffers for all I/Os.
RESET MIO TO FACTORY SETTINGS	This item resets the MIO print server and restores most of the factory (default) settings.

Configuration Menu

Item	Values	Explanation
PERSONALITY= AUTO	AUTO PCL PS	<p>Select the default printer language (personality). Possible values are determined by which valid languages are installed in the printer. For example, if you have the PS module installed, you will be able to select between AUTO, PCL or PS.</p> <p>Normally you should not change the printer language (the default is AUTO). If you change it to a specific printer language, the printer will not automatically switch from one language to another unless specific software commands are sent to the printer.</p>

MIO Menu





The MIO print server that is installed controls this menu and it varies accordingly. Please refer to the documentation that comes with the print server for more information.









PostScript Menu (for HP 2500CM printer or with the HP 2500C PostScript Upgrade Kit only)



Item	Values	Explanation
PRINT PS ERRORS= OFF	OFF ON	Select ON to print the PS error page when PS errors occur.
JAM RECOVERY= AUTO	AUTO ON OFF	<p>Determine how the printer behaves when a paper jam occurs.</p> <p>AUTO: The printer automatically selects the best mode for printer jam recovery (usually ON). This is the default setting.</p> <p>ON: The printer automatically reprints pages after a paper jam is cleared.</p> <p>OFF: The printer does not reprint pages following a paper jam. Printing performance might be increased with this setting.</p>
COPIES=1	1 to 99	Set the default number of copies by selecting any number from 1 to 99. Press [Value] once to change the setting by increments of 1 or hold down [Value] to scroll.

Understanding Printer Messages

Note: [] in the Message column indicate variables.

Message	Explanation	Solution
OFFLINE	The printer is offline.	Press  to set the printer online.
CANCELING JOB	The printer is canceling the current print job.	
[COLOR] INK OUT, REPLACE CART	One of the ink cartridges (black, cyan, magenta or yellow) is out of ink.	Replace the appropriate cartridge.
[COLOR] CART FAULTY, REPLACE	One of the ink cartridges (black, cyan, magenta or yellow) is faulty.	Replace the appropriate cartridge.
[COLOR] CART MISSING, INSERT	One of the ink cartridges (black, cyan, magenta or yellow) is missing.	Insert the appropriate cartridge.
[COLOR] PRNT-HD FAULTY, REPLACE	One of the printheads (black, cyan, magenta or yellow) is faulty.	Replace the appropriate printhead.
[COLOR] PRNT-HD MISSING, INSERT	One of the printheads (black, cyan, magenta or yellow) is missing.	Insert the appropriate printhead.
PRNT-HD ACCESS COVER OPEN	The Printhead Access Cover is open.	Close the cover and press  to resume printing.
TOP COVER OPEN	The Top Cover is open.	Close the cover and press  to resume printing.
PAPER JAM, OPEN TOP COVER	There is paper jammed in the printer.	Open the Top Cover to remove paper. When finished, close the Top Cover and press  to resume printing.
CARRIAGE JAM, OPEN TOP COVER	The Carriage is jammed.	Open the Top Cover to clear obstruction. When finished, close the Top Cover and press  to resume printing.
CARRIAGE JAM, OPEN ACC COVER	The Carriage is jammed.	Open the Printhead Access Cover to remove obstruction. When finished, close the Printhead Access Cover and align printheads.

LEFT BACK PANEL OUT	The left side of the Back Panel has not been inserted properly.	Open the Rear Access Door and ensure that the left side of the panel is properly installed.
RIGHT BACK PANEL OUT	The right side of the Back Panel has not been inserted properly.	Open the Rear Access Door and ensure that the right side of the panel is properly installed.
TRAY 2 PAPER GUIDE REMOVED	One of the Paper Guides in Tray 2 has been removed.	Insert the missing Paper Guide back into Tray 2.
TRAY 3 OPEN OR GUIDE REMOVED	Tray 3 is either open or one of its Paper Guides has been removed.	Ensure that both the Paper Guides are properly installed and that Tray 3 is inserted into the printer.
TRAY 1 LOAD [TYPE] [SIZE]	You have chosen to print from Tray 1 or the media you have selected differs from those in Trays 2 and 3.	Load the paper type and size as specified in the LCD panel and press  to continue printing. You may set the printer to print with existing media in Tray 2 or Tray 3 by either pressing [Value] or  without loading media in Tray 1.
MNL FEED LOAD [TYPE] [SIZE]	You have chosen to print through the Rear Manual Feed.	Load the paper type and size as specified in the LCD panel into the Rear Manual Feed located at the back of the printer and press  to continue printing.
TRAY (NUMBER) EMPTY, LOAD & PRESS	The specified tray is empty.	Load the paper size and type which this tray has been set up for. If you wish to change the paper size setting of this tray, please refer to section on Load Paper .
USE [TYPE] [SIZE] INSTEAD?	The media you have chosen differs from those in Trays 2 and 3 and you have either pressed [Value] or  without loading media in Tray 1.	Press  to print or [Value] to select other options.
PRESS  TO CONTINUE	To continue your present task, press the  button.	
MEDIA IN TRAY 1, REMOVE	The media in Tray 1 may not be the type or size that is specified in your current print job.	Remove the media in Tray 1 and press the  button to resume printing. If you wish to print through Tray 1, set your print setting to pick from Tray 1 and send the print job before putting media in Tray 1.

WRONG MEDIA TYPE, [ACTION]	The media type which the printer has detected is not the type specified in your print settings.	Do one of the following: <ul style="list-style-type: none"> • Press  to continue printing. • Load the correct media and press  . • Cancel the current print job by pressing the [Cancel Print] button.
UNEXPECTED PAPER SIZE	The specified paper size is different from the paper size in the selected input tray. The output was truncated to fit the paper in the printer. Some output may have been lost.	Reload the correct media into the tray and print again.
PRNT-HDS NOT ALIGNED	The printheads have not been aligned. For best print quality, align the printheads before the next print job.	Align the printheads. For instructions see Align Printheads.
NON HP [COLOR] CART	A non-HP ink cartridge has been detected. HP does not guarantee non-HP cartridges. The use of incompatible cartridges may disrupt the intricate printing system, potentially resulting in reduced print quality and even damaging the printer.	Use original HP ink cartridges.
[COLOR] CART NEAR EXPIRY	One of the ink cartridges (black, cyan, magenta or yellow) is near expiry. To obtain optimum print quality, it is recommended that you do not use expired ink cartridges.	Be prepared to replace the mentioned color ink cartridge.
[COLOR] PRNT-HD NEAR EXPIRY	One of the printheads (black,cyan, magenta or yellow) is near expiry. To obtain optimum print quality, it is recommended that you do not use expired printheads.	Be prepared to replace the mentioned printhead.
[COLOR] INK LOW	One of the ink cartridges (black, cyan, magenta or yellow) is low on ink. You may still continue to print with this cartridge until the ink has totally run out.	Be prepared to replace the mentioned color ink cartridge.

ROTATE, REINSERT [NUMBER] PG TO TRAY [NUMBER]	The printer has finished printing one side of a 2-sided document. The pages need to be reloaded for printing to resume.	Remove the stated number of pages from Tray 1, rotate the pages and reload them into the specified tray, print side. Press \diamond to continue printing. You can set the printer to pick from Tray 1 by loading the paper into Tray 1 and pressing \diamond .
REINSERT [NUMBER] PG TO TRAY [NUMBER]	The printer has finished printing one side of a 2-sided document. The pages need to be reloaded for printing to resume.	Remove the stated number of pages from Tray 1 and reload them into the specified tray, print side down. Press \diamond to continue printing. You can set the printer to pick from Tray 1 by loading the paper into Tray 1 and pressing \diamond .

HP	2500C/CM	Troubleshooting
-----------	-----------------	------------------------

This chapter documents the different troubleshooting tools and steps that can be used to assist you in diagnosing and solving most printer problems.

General Troubleshooting Tips

1. Check the printer LCD panel. If the printer LCD panel displays a Recoverable error message refer to [Understanding Printer Messages](#) for instructions on how to resolve the problem.

LCD Error Type	Example	Function
Recoverable	Offline, INK LOW, etc.	Refer to Understanding Printer Messages for information on how to resolve such errors.
Non-Recoverable	ERROR CODE: XXXX	Your printer may have a hardware problem. Turn off the printer wait for a few seconds and then turn it on again. If the message persists, call HP.

2. Check the LEDs on the printer. If the red LED is blinking, this means that the printer is in an error state or it requires attention. If both the LEDs are blinking, the printer is in a non-recoverable error state.

Non-Recoverable Error

If the LCD panel displays a non-recoverable error message or if the printer is in a non-recoverable error state:

1. Turn off your printer by pressing the Power button. Remove all cables and wait for about 10 seconds. Reconnect the cables and power on the printer.
2. If the printer powers on and recovers from the error state, you should see the message "READY" on the LCD panel.
3. Make sure that the tapes covering the ink nozzles and electrical contacts on all the printheads have been removed.

[For information on how to remove the tapes, see section on Replacing Printheads.](#)

4. If the error persists we recommend that you call HP for assistance. Please have the following information ready:
 - the model
 - the printer serial number
 - the error code number

Troubleshooting Feature in Toolbox

If a printing problem occurs, you can use the online troubleshooting feature built into your HP 2500C Series Toolbox. In the Toolbox, click the Troubleshooting tab. The troubleshooting information in the HP 2500C Series Toolbox is designed to help you diagnose and solve most printing problems that can occur.

To use the troubleshooting feature in the HP 2500C Series Toolbox in Windows 95, 98 and NT 4.0:

1. Double-click the HP 2500C Series Toolbox icon on your computer desktop or click on **Start**, select **Programs**, followed by **HP 2500C Series** program group, followed by **HP 2500C Toolbox**.
2. Click on the Troubleshooting tab, then follow the instructions on your computer screen.

To use the troubleshooting feature in the HP 2500C Series Toolbox in Windows 3.1x:

1. Double-click the HP 2500C Series Toolbox icon in the HP 2500C Series Printer program group.
2. Click on the Troubleshooting tab, then follow the instructions on your computer screen.

The following is a summary of the troubleshooting tips found in the Toolbox:

Printer does not Print

- **Check the power**
Make sure the power cord is connected firmly to the printer and to a working outlet, and that the printer is turned ON. The green Ready LED should be lit and the LCD should display "READY".
- **Check printer setup**
Make sure your HP 2500C Series printer is selected as the current or default printer.
- **Check printer port selection**
Make sure that the correct port is selected and that the printer is connected to your printer properly. If your printer is connected to a switch box, make sure that you have selected the correct switch. If your printer is on a network, ensure that you have mapped to the correct port.
- **Print a Diagnostic Page**
Printing a Diagnostic Page will verify if the printer is functioning properly. To print the diagnostic page:
 1. Press [Menu] until SELF TEST MENU appears
 2. Press [Item] until PRINT DIAGNOSTIC PAGE appears.
 3. Press [Select] to print the diagnostic page.
- **Check network setup**
If your printer is shared on a network, make sure that it is properly setup in the network environment. See the Network Guide as well as the documentation provided by your network vendors.
- **Check for paper feed problem**
Make sure that paper is loaded correctly in the trays and that paper is not jammed in the printer. Check the printer LCD panel for paper jam messages. [See section on Load Paper.](#)
If paper is jammed in the printer, [see section on Clearing Paper Jams.](#)

Partial or Blank Page Printed

- **Check the printhead for tape**
New printheads are shipped with a protective tape that covers the nozzles. Make sure that the protective tape covering each printhead is removed.
- **Check printer setup**
Make sure your HP 2500C Series printer is selected as the current or default printer.

- **Tray 3 pulled out during printing.**
If Tray 3 is pulled out of the printer when it is printing, the job will be canceled and the page will be ejected. Wait until the page has been printed and ejected from the printer before removing the tray.

Bad or Poor Print Quality

- **Check print quality setting**
Check the printer setting which you have selected for this print job in the printer software. While the EconoFast settings print faster and uses less ink, it may cause text to appear faded or colors to appear dull. Select Normal or Best Print Quality in the HP print settings dialog box.
[See “Change print settings” on the “How do I?” tab in the HP 2500C Series Printer Toolbox.](#)
- **Check paper type setting**
When printing on transparencies or other special media types, select the corresponding media type in the HP print settings dialog box.
[See “Print on various paper types and sizes” on the “How do I?” tab in the HP 2500C Series Printer Toolbox.](#)
- **Clean printheads**
Whenever print quality deteriorates, it is advisable to clean the printheads.
[See section on Clean Printheads for instructions.](#)

Text or Graphics are Cut Off

- **Check margin settings**
If the text or graphics are cut off at the edges of the page, make sure the margin settings for the document do not exceed the printable area of your printer. [For information on the printer margins for the various supported paper sizes see Minimum Printing Margins.](#)
- **Check page orientation**
The page orientation that you have selected may not be correct for the document you are printing. Check your print settings and try printing again.
- **Tray 3 pulled out during printing.**
If Tray 3 is pulled out of the printer when it is printing, the job will be canceled and the page will be ejected. Wait until the page has been printed and ejected from the printer before removing the tray.

Garbage Printed

- **Check cable connection**
Check that the printer and/or network cables are securely connected to the printer. If you are using a parallel cable, ensure that it is also firmly connected to the computer.
- **Check printer setup**
Make sure your HP 2500C Series printer is selected as the current or default printer.
- **Check document file**
Your document may be corrupted. Try printing another file from the same software application.
- **Disable bi-directional communication or stop sharing printer port with another device**
A probable cause for this problem is that there is a conflict between the printer and other port sharing devices such as zip drives or scanners.

If you are running Windows 3.1, do not share the printer port with another device.

If you are running Windows 95, 98 or NT 4.0, disable bi-directional printing.

Clearing Paper Jams

If paper is jammed in the printer, follow these instructions to clear the jam:

1. Remove all media from trays 1, 2 and 3. Pull out any paper that is visibly stuck.

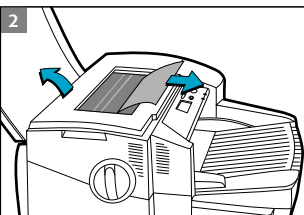
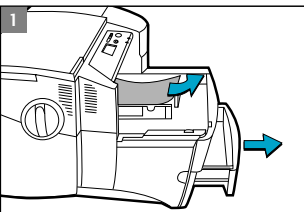

2. Lift the Top Cover and pull out any paper that may be stuck.

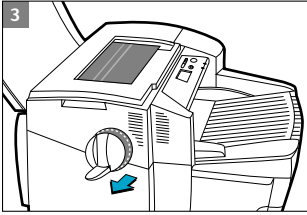

3. If you are unable to free the jammed paper, pull out the handle of the Paper Knob, pull the knob away from the printer and rotate to remove the paper.

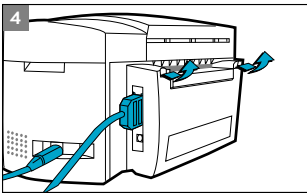
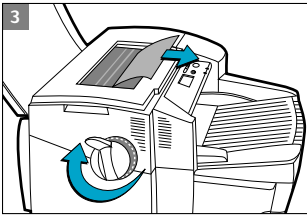

4. If the LCD still reports a paper jam, go to the back of the printer and lower the Rear Access Door by lifting the two rear door latches.
5. Remove the Back Panel by pressing the two catches inwards.
6. Pull out any paper that may be stuck inside.
7. Replace the Back Panel and make sure it fits securely.
8. Close the Rear Access Door and turn on the printer.



[Click to see a video clip of the above procedure.](#)

Tips for Avoiding Paper Jams

- Make sure nothing is blocking the paper paths.
- Do not overload the trays. Tray 1 holds up to 10 sheets of paper; Tray 2 holds up to 150 sheets and Tray 3 holds up to 250 sheets.
- Load the paper correctly.
- Do not use paper that is curled or crumpled.

Printhead Diagnostics

When the LCD Panel displays the message "PRNT-HD DIAG PRESS ", it means that one or more of the printheads may be faulty. You will need to diagnose which printhead is faulty and replace it before you can continue printing.

This process requires you to remove all the printheads and then re-inserting one printhead at a time in the sequence of black, cyan, magenta and yellow.

To diagnose the faulty printhead:











1. Open the Printhead Access Cover and unlock the printhead latch.
2. Remove the cyan, magenta and yellow printheads and close the Printhead Access Cover.
3. The LCD Panel will display the message "DETECTING..." as it checks the printhead.
4. If the message "B PRNT-HD FAULTY, PRESS \diamond " appears, it means that the black printhead is faulty. If this happens, press the \diamond button. Remove the Printhead Access Cover and replace with a new black printhead. Fasten the printhead latch and close the Printhead Access Cover to verify that the new printhead is working. If the message "B PRNT-HD OK, PRESS \diamond " appears, it means that the black printhead is working.
5. Follow the sequence found in step 4 with each of the remaining printheads to verify functionality.
6. Isolate the faulty printhead by this method, and replace it with a new one.

The Diagnostic Test page is a valuable tool for troubleshooting. This will help verify if the printer is working.

To print a Diagnostic Test:

1. Press [Menu] until SELF TEST MENU appears
2. Press [Item] until PRINT DIAGNOSTIC PAGE appears.
3. Press [Select] to print the diagnostic page.

The Diagnostic Test page looks like this:

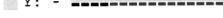
= A	B =			
HP 2500C Series Diagnostic Test				
<hr/>				
 Printer Information 1				
Model: HP 2500C Series				
Version: 5.1.0				
S/N Printer: XXXXXXXXXX , Carriage:				
Service ID#: 890				
Optional Paper Tray Installed: Yes				
Pages Printed: 87				
 Built-in Bitmap Fonts 2				
Proportional	Available Point Sizes			
CGTimes	5,6,7,8,10,12,14			
CGTimes <i>Italic</i>	5,6,7,8,10,12,14			
Univers	5,6,7,8,10,12,14			
Univers <i>Italic</i>	5,6,10,12			
Fixed-Pitch	Available Point Sizes	Available Pitches		
Courier	6,12,24	5,10,16,67,20		
Courier <i>Italic</i>	6,12,24	5,10,20		
Letter Gothic	6,12,24	6,12,24		
Letter Gothic	4,75,9,5,19	16,67		
Letter Gothic <i>Italic</i>	6,12,24	6,12,24		
 Printhead Information 3				
Pages Printed (approximate)	B: 0	C: 0	M: 0	Y: 0
Nozzles Disabled (<3 OK)	B: 0	C: 0	M: 0	Y: 0
Printhead Status				
 B: -	+ HP No.10			
 C: -	+ HP No.10			
 M: -	+ HP No.10			
 Y: -	+ HP No.10			
 Ink Cartridge Information 4				
Pages Printed (approximate)	B: 75	C: 25	M: 175	Y: 50
Ink Cartridge Level				
 B: -	+ HP No.10			
 C: -	+ HP No.10			
 M: -	+ HP No.10			
 Y: -	+ HP No.10			
= C				D =

The Diagnostic Test page is divided into four sections:

Item	Description
1	Printer Information shows general printer information such as Firmware version number, Model and Service ID.
2	Built-in Bitmap Fonts shows the type of fonts that is resident in your printer. This is different from the TrueType fonts that are installed in your computer.
3	Printhead Information monitors and displays the status of your printhead. If these bars are printed properly, it shows that the printheads are in working order.
4	Ink Cartridge Information displays the amount of ink left in each ink cartridge.

HP

2500C/CM

Customer Support

HP FIRST

HP FIRST is an automated information fax retrieval service which provides toll-free, 24-hour technical information to you by fax. Call HP FIRST at the following telephone numbers:

For US and Canada	(800) 333-1917
For customers in Europe:	
U.K.	0800 96 02 71
For service in English outside U.K.	+ 31 20 681 5792
Austria	0600 8128
Belgium (Dutch)	0800 11906
Belgium (French)	0800 17043
Denmark	800 10453
Finland	800 13134
France	0800 905900
Germany	0130 810061
Italy	1678 59020
Norway	800 11 319
Portugal	05 05 31 33 42
Spain	900 993123
Sweden	020 795743
Switzerland (French)	0800 551 526
Switzerland (German)	0800 551 527
The Netherlands	0800 022 2420

For customers in Asia-Pacific

Australia	613 9272 2627
China	86 10 6564 5735
Hong Kong	2506 2422
India	9111 622 6420
Indonesia	21-352 2044
Korea	822 769 0543
Malaysia	03 298 2478
New Zealand	64 09 356 6642
Philippines	(65) 275 7251
Singapore	275 7251
Taiwan	(02) 719 5589
Thailand	662 661 3511

The HP Customer Care Center can be reached at any of the following numbers.

For U.S. (208) 323-2551

For Canada (905) 206-4663

For Latin America

Argentina	(541) 787 4061/69
Brazil	55 11 709 1444
Chile	562 800 360999
Mexico city	01-800-22147000/1-800-9052900
Mexico Guadalajara	(525) 264 2075
Mexico Monterey	91800 22147
Venezuela	582 239 5664

For Europe

Africa/Middle East	41 22/780 71 11
Austria	0660 6386
Belgium (Dutch)	02 6268806
Belgium (French)	02 6268807
Czech Republic	42 (2) 471 7327
Denmark	3929 4099
Finland	203 47288
France	01 43 62 34 34
Germany	180 5258 143
Greece	0168 96 411
Hungary	36 (1) 252 4505
Ireland	01662 5525
Italy	02 264 10350
Norway	22 11 6299
Poland	48 22 37 50 65
Portugal	01 441 7199
Russia	7095 923 50 01

Spain	902 321 123
Sweden	08 619 2170
Switzerland	0848 80 11 11
The Netherlands	020 606 8751
Turkey	90 1 224 59 25
United Kingdom	0171 512 5202

For Asia-Pacific

Australia	(61-3) 9272-8000
China	86 10 6564 5959
Hong Kong	800 96 7729
India	9111 682 6035
Indonesia	21 350 3408
Korea	(82-2) 3270-0700
Malaysia	03 295 2566
New Zealand	09 356-6640
Philippines	2 867 3551
Singapore	272 5300
Taiwan	866-2-7170055
Thailand	02 661 4011
Vietnam	8823 4530

Number	Description
	Accessories
C3289A	HP 2500C PostScript Upgrade Kit
C2950A	IEEE 1284-Compliant Parallel Cable 2m
C2951A	IEEE 1284-Compliant Parallel Cable 3m
C4543A	HP 64 MB (2 x 32 MB) 60ns EDO SIMM
C3648A	HP 32 MB (2 x 16 MB) 60ns EDO SIMM
C3647A	HP 16 MB (2 x 8 MB) 60ns EDO SIMM
	Any HP JetDirect MIO print server cards
	Printheads
C4800A	HP Black No.10 Printhead
C4801A	HP Cyan No.10 Printhead
C4802A	HP Magenta No.10 Printhead
C4803A	HP Yellow No.10 Printhead
	Ink Cartridges
C4844A	HP No.10 Large Black Ink Cartridge
C4841A	HP No.10 Cyan Ink Cartridge
C4842A	HP No.10 Yellow Ink Cartridge
C4843A	HP No.10 Magenta Ink Cartridge
	HP Bright White Inkjet Paper
C1857A	US B-size, 200 sheets: 11 x 17 in.
C1858A	A3, 200 sheets: 297 x 420 mm
C1824A	US Letter, 500 sheets: 8.5 x 11 in.
C1825A	A4, 500 sheets: 210 x 297 mm
	HP Premium Inkjet Paper
C1855A	US B-size, 100 sheets: 11 x 17 in.
C1856A	A3, 100 sheets: 297 x 420 mm
51634Y	US Letter, 200 sheets: 8.5 x 11 in.
51634Z	A4, 200 sheets: 210 x 297 mm
	HP Premium Inkjet Heavyweight Paper
C1852A	US Letter, 100 sheets: 8.5 x 11 in.
C1853A	A4, 100 sheets: 210 x 297 mm

	HP Premium Photo Paper
C6058A	US B-size, 100 sheets: 11 x 17 in.
C6059A	A3, 20 sheets: 297 x 420 mm
C6039A	US Letter, 15 sheets: 8.5 x 11 in.
C6040A	A4 (European), 15 sheets: 210 x 297 mm
C6043A	A4 (Asian), 15 sheets: 210 x 297 mm
	HP Premium Transparency Film
C3834A	US Letter, 50 sheets: 8.5 x 11 in.
C3828A	US Letter, 20 sheets: 8.5 x 11 in.
C3835A	A4, 50 sheets: 210 x 297 mm
C3832A	A4, 20 sheets: 210 x 297 mm
	HP Premium Inkjet Rapid-Dry Transparencies
C6051A	US Letter, 50 sheets: 8.5 x 11 in.
C6053A	A4, 50 sheets: 210 x 297 mm
	HP Iron-On T-Shirt Transfers
C6049A	US Letter, 10 sheets: 8.5 x 11 in.
C6050A	A4, 10 sheets: 210 x 297 mm
	HP Greeting Card Paper
C1812A	US Letter, 20 sheets, 20 envelopes
C6042A	A4, 20 sheets, 20 envelopes
	HP White Labels
92296A	1" x 2 5/8" Addressing Labels
92296B	1 1/3" x 4" Addressing Labels
92296C	1" x 4" Addressing Labels
92296D	2" x 4" Shipping Labels
92296E	3 1/3" x 4" Shipping Labels
92296F	1/2" x 1 3/4" Return Address Labels
92296K	8 1/2" x 11" White Full Sheet Labels
92296L	99.1 x 38.1 mm Addressing Labels
92296M	99.1 x 33.8 mm Addressing Labels
92296N	63.5 x 38.1 mm Addressing Labels
92296P	100 x 51 mm Addressing Labels
92296R	199.6 x 289 mm, Full Sheet Labels
C4296A	99.1 x 67.7 mm, Parcel Labels
C4297A	63.5 x 46.6 mm Addressing Labels

Print Method	Plain paper drop on-demand thermal inkjet printing		
Print Speed ¹ Black	Black Text	Letter / A4	11 x 17 / A3
	Econofast Mode	9.5 ppm	5.5 ppm
	Normal Mode	8 ppm	4 ppm
	Best Mode	8 ppm	4 ppm
Print Speed ¹ Color	Color Highlights	Letter / A4	11 x 17 / A3
	Econofast Mode	9.5 ppm	5 ppm
	Normal Mode	6.5 ppm	3.8 ppm
	Best Mode	6 ppm	3.4 ppm
	Mixed Text & Graphics	Letter / A4	11 x 17 / A3
	Econofast Mode	7.5 ppm	4.5 ppm
	Normal Mode	3.5 ppm	2 ppm
	Best Mode	1.4 ppm	1 ppm
	Full Page Color Highlights	Letter / A4	11 x 17 / A3
	Econofast Mode	3.5 ppm	1.5 ppm
	Normal Mode	1.8 ppm	0.8 ppm
	Best Mode	0.4 ppm	0.3 ppm
	¹ Approximate figures. Exact speed is dependent on the system configuration, software program, and document complexity		
Black Resolution	Up to 600x600 dpi		
Color Resolution	PhotoREt II for photo quality		
Printhead Nozzles	304 black, 912 color (304 per color printhead)		
Printer Command Language	HP PCL 3 enhanced Adobe® PostScript® 3™ (with HP 2500CM only)		
Font Capability	HP FontSmart v2.5 (110 TrueType fonts for Windows) HP FontSmart software provides easy-to-use font management capabilities 136 PostScript fonts with Adobe PostScript 3 (Euro \$ symbol supported)		
Memory	HP 2500C 4 MB standard RAM HP 2500CM 12 MB standard RAM Two 72-pin SIMM slots for additional memory (EDO, 60ns) expansion up to a total of 76 MB		

<p>Connectivity / Network Management</p>	<p>HP 2500C Network-capable printer for DOS and Windows environments HP PCL 3 Windows Driver Support for Windows NT 4.0, Windows 3.1x/95/98 Centronics parallel, IEEE 1284 compliant One network interface slot accepts optional HP MIO Print Servers with support for Novell Netware, Microsoft LAN Manager, Windows for Workgroups, Windows NT, IBM LAN Server, Unix environment</p> <p>HP2500CM Network-ready printer for DOS and Windows environments. HP PCL 3 Windows Driver Support for Windows NT 4.0, Windows 3.1x/95/98 Centronics parallel, IEEE 1284 compliant HP MIO 10/100T/BNC print server with support for Novell Netware Microsoft LAN Manager, Windows for Workgroups, Windows NT, IBM LAN Server, Unix environment Supports networking protocols IPX/SPX, TCP/IP, DLC/LLC, and NetBEUI Adobe PostScript 3 drivers for Windows Automatic switching between languages and ports.</p> <p>HP JetAdmin printer management software provides easy printer setup, configuration and management. Latest versions available from HP's web site (http://www.hp.com/go/jetadmin) HP WebJetAdmin printer management software available from HP's web site (http://www.hp.com/go/webjetadmin) for simple installation, configuration and management from a common web browser.</p>
<p>Paper Handling</p>	<p>Standard input capacity of 400 sheets through two trays of 150 sheet and 250 sheet capacity. Standard output capacity of 150 sheets (face-up) Rear Manual Feed – single sheet only Tray 1 (Input / Output Tray) – Sheets: up to 10, Cards: up to 4 Tray 2 (Upper Tray) – Sheets: up to 150, Cards: up to 60 Tray 3 (Lower Tray) – Sheets: up to 250 All input paths handle standard media sizes (as listed on page 15) up to 13" x 19" (Super A3) Additionally, Tray 1 and the Rear Manual Feed support media sizes from 4" x 6" (101.6 mm x 152.4 mm) to 13" x 19" (330 mm x 483 mm) Built-in media size sensors prevents printing on the wrong media size.</p>

Paper Size Handling	Minimum Width: 76.2 mm (4 in.) x 127.0 mm (6 in.) Maximum Width: 330 mm (13 in.) x 483 mm (19 in.)
Maximum Print Area	PCL: 320 mm (12.61 in.) x 470 mm (18.49 in.) on 13 in. x 19 in. media PostScript: 289.56 mm (11.4 in.) x 441.96 mm (17.4 in.) or 302.26 mm (11.9 in.) x 426.72 mm (16.8 in.) on 13 in. x 19 in. media.
Recommended Media Weight	All input paths handle the following paper weights with the rear straight-through paper path handling up to 0.3mm thickness of paper Paper: 60 to 135 g/m ² (16 to 36 lb. Bond) Cards: 110 to 200 g/m ² (110 lb. Index) Straight-through path: up to 0.3 mm thickness (0.012 in.) or 220 g/m ² (110 lb. Index)
Smart Software Features	Built-in printer software features: HP ZoomSmart scaling technology, Billboard, Handout (N-up printing), Mirror, Watermark, Print Preview, Quick Sets, laserJet Margin Emulation, 2-sided Printing, Booklet
Media Size/Type	Paper: Super B 13 x 19 in. (330 x 483 mm), U.S. Tabloid 11 x 17 in., U.S. Legal 8.5 x 14 in., U.S. Letter 8.5 x 11 in., Executive 7.25 x 10.5 in., Statement 5.5 x 8.5 in., European Super A3 330 x 493 mm*, European A3 297 x 420 mm, A4 210 x 297 mm, European A5 148.5 x 210 mm*, European A6 105 x 148.5 mm*, B4 257 x 364 mm, European B5 182 x 257 mm*, Custom* Transparencies: U.S. Letter 8.5 x 11 in., European A4 210 x 297 mm Cards: U.S. Index card 4 x 6 in., Index card 5 x 8 in.; European A6 card 105 x 148.5 mm; Postcard 100 x 148 mm Labels: U.S. Labels, 8.5 x 11 in.; European A4 labels, 210 x 297 mm * These media sizes are only supported in Tray 1 and the Rear Manual Feed
Control Panel	Intuitive operation and complete, easy-to-understand messages Two-line LCD display and 2 LEDs Buttons: ⬠ (Go), Job Cancel, Menu, Item, Value, Select Indicators: Attention, Ready Messages can be displayed in 14 languages: English, French, Italian, German, Spanish, Portuguese, Dutch, Norwegian, Finnish, Swedish, Danish, Polish, Czech and Russian
Operating Environment	Operating temperature: 5° to 40°C (41° to 104°F) Recommended operating conditions: 15° to 35°C (59° to 95°F) Storage temperature: -40° to 60°C (-4° to 140°F) Relative Humidity: 20 to 80% RH non-condensing Noise levels per ISO 9614-1: Sound Pressure, LwAM 62 dB(A)

Power Supply	Built-in Universal Power Supply
Power Requirements	Input Voltage 100 – 240 AC (±10%), 50/60 Hz (±3 Hz)
Power Consumption	Less than 2 watts when off, 8 watts maximum non-printing, 35 watts average printing, 65 watts printing
Dimensions	With paper tray closed 685 mm (26.97 in.) W x 610 mm (24.02 in.) D x 337 mm (13.27 in.) H With paper tray fully extended 685 mm (26.97 in.) W x 745 mm (29.33 in.) D x 337 mm (13.27 in.) H Desk Space Required 685 mm (26.97 in.) W x 532 (20.94 in.) D
Weight	26.5 kg (58.48 lb.) without ink cartridges and printheads 27.0 kg (59.2 lb.) with ink cartridges and printheads
Reliability & Estimated Usage	12,000 pages/month
System Requirements	Minimum: Windows 3.1x: 486DX-66, 8 MB RAM Windows 95/98: 486DX-100, 8 MB RAM Windows NT 4.0: 486DX-100, 16 MB RAM Recommended: Windows 3.1x: Pentium 150/166, 16 MB RAM Windows 95/98, Pentium 150/166, 16 MB RAM Windows NT 4.0, Pentium 150/166, 32 MB RAM 50 MB Free HardDisk space for 11 x 17 or A3 size printing. Graphics intensive files may require more disk space.
Warranty	1 year on site warranty
Year 2000 Compliance	HP 2500C series printers are Year 2000 compliant
Product Certifications	Safety Certifications: CCIB (China), CSA (Canada), PSB (Singapore), UL (USA), NOMI(Mexico), TUV-GS (Germany), SABS (South Africa), JUN (Korea), LS (Lithuania), EEI (Estonia) EMI Certifications: FCC Class B when used with a Class B computing device (USA), FCC Part 15B Class A when connected to Local Area Network (LAN) Devices, CTICK (Australia & New Zealand), VCCI (Japan), CE (European Union), B mark (Poland), GOST (Russia), BCIQ (Taiwan), RRL (Korea) Pantone Calibrated

The following are the minimum printer margins for the various supported paper sizes when printing with the PCL driver. Please note that these margins are based on portrait orientation.

Paper Size	Left Margin	Right Margin	Top Margin	Bottom Margin
US Letter	0.25" 6.35mm	0.25" 6.35mm	0.117" 2.97mm	0.5" 12.7mm
11" x 17"	0.26" 6.6mm	0.26" 6.6mm	0.117" 2.97mm	0.5" 12.7mm
A4	0.133" 3.38mm	0.133" 3.38mm	0.117" 2.97mm	0.5" 12.7mm
A3	0.205" 5.2mm	0.205" 5.2mm	0.117" 2.97mm	0.5" 12.7mm
B4	0.205" 5.2mm	0.205" 5.2mm	0.117" 2.97mm	0.5" 12.7mm
Legal	0.25" 6.25mm	0.25" 6.25mm	0.117" 2.97mm	0.5" 12.7mm
Executive	0.252" 6.4mm	0.252" 6.4mm	0.117" 2.97mm	0.5" 12.7mm
A5	0.127" 3.2mm	0.127" 3.2mm	0.117" 2.97mm	0.5" 12.7mm
B5	0.128" 3.23mm	0.128" 3.23mm	0.117" 2.97mm	0.5" 12.7mm
4" x 6" Index Card	0.133" 3.38mm	0.133" 3.38mm	0.117" 2.97mm	0.5" 12.7mm
5" x 8" Index Card	0.127" 3.2mm	0.127" 3.2mm	0.117" 2.97mm	0.5" 12.7mm
A6 Card	0.133" 3.38mm	0.133" 3.38mm	0.117" 2.97mm	0.5" 12.7mm
13" x 19"	0.207" 5.26mm	0.207" 5.26mm	0.117" 2.97mm	0.5" 12.7mm
Statement	0.203" 5.25mm	0.203" 5.25mm	0.117" 2.97mm	0.5" 12.7mm
Custom (3.94" x 5.83" to 13" x 19") or (100 x 148mm to 330 x 483mm)	0.137" 3.48mm	0.137" 3.48mm	0.117" 2.97mm	0.5" 12.7mm

Note:

The minimum printer margins when printing with the PostScript driver is the same as that of the PCL driver except for the following:

Paper Size	Left Margin	Right Margin	Top Margin	Bottom Margin
13" x 19"	0.8" 20.32mm	0.8" 20.32mm	0.8" 20.32mm	0.8" 20.32mm
330 x 483mm	0.55" 13.97mm	0.55" 13.97mm	1.1" 27.94mm	1.1" 27.94mm
Custom	0.137" 3.48mm	0.137" 3.48mm	0.117" 2.97mm	0.5" 2.97mm

HP

2500C/CM

Hewlett-Packard Limited Warranty Statement

HP Product

Duration of Limited Warranty

Software

90 Days

Ink Cartridges

90 Days

Printheads

1 Year

Printer

1 Year

A. Extent of Limited Warranty

1. Hewlett-Packard (HP) warrants to the end-user customer that the HP products specified above will be free from defects in materials and workmanship for the duration specified above, which duration begins on the date of purchase by the customer.
Customer is responsible for maintaining proof of date of purchase.
2. For software products, HP's limited warranty applies only to a failure to execute programming instructions. HP does not warrant that the operation of any product will be uninterrupted or error free.
3. HP's limited warranty covers only those defects which arise as a result of normal use of the product, and do not apply to any:
 - a. Improper or inadequate maintenance or modification;
 - b. Software, interfacing, media, parts, or supplies not provided or supported by HP; or
 - c. Operation outside the product's specifications.
4. For HP printer products, the use of a non-HP ink cartridge or a refilled ink cartridge does not affect either the warranty to the customer or any HP support contract with the customer. However, if printer failure or damage is attributable to the use of a non-HP or refilled ink cartridge, HP will charge its standard time and materials charges to service the printer for the particular failure or damage.

5. If HP receives, during the applicable warranty period, notice of a defect in any software, media, or ink cartridge product which is covered by HP's warranty, HP shall replace the defective product. If HP receives, during the applicable warranty period, notice of a defect in any hardware product which is covered by HP's warranty, HP shall either repair or replace the defective product, at HP's option.
6. If HP is unable to repair or replace, as applicable, a defective product which is covered by HP's warranty, HP shall, within a reasonable time after being notified of the defect, refund the purchase price for the product.
7. HP shall have no obligation to repair, replace, or refund until the customer returns the defective product to HP.
8. Any replacement product may be either new or like-new, provided that it has functionality at least equal to that of the product being replaced.
9. HP's limited warranty is valid in any country where the covered HP product is distributed by HP except for the Middle-East, Africa, Argentina, Brazil, Mexico, Venezuela, and France's "Départements D'Outre-Mer"; for those excepted areas, the warranty is valid only in the country of purchase. Contracts for additional warranty services, such as on-site service, may be available for any authorized HP service facility where the listed HP product is distributed by HP or an authorized importer.

B. Limitations of Warranty

1. TO THE EXTENT ALLOWED BY LOCAL LAW, NEITHER HP NOR ITS THIRD PARTY SUPPLIERS MAKE ANY OTHER WARRANTY OR CONDITION OF ANY KIND, WHETHER EXPRESS OR IMPLIED, WITH RESPECT TO THE HP PRODUCTS, AND SPECIFICALLY DISCLAIM THE IMPLIED WARRANTIES OR CONDITIONS OF MERCHANTABILITY, SATISFACTORY QUALITY, AND FITNESS FOR A PARTICULAR PURPOSE.

C. Limitations of Liability

1. To the extent allowed by local law, the remedies provided in this Warranty Statement are the customer's sole and exclusive remedies.
2. TO THE EXTENT ALLOWED BY LOCAL LAW, EXCEPT FOR THE OBLIGATIONS SPECIFICALLY SET FORTH IN THIS WARRANTY STATEMENT, IN NO EVENT SHALL HP OR ITS THIRD PARTY SUPPLIERS BE LIABLE FOR DIRECT, INDIRECT, SPECIAL, INCIDENTAL, OR CONSEQUENTIAL DAMAGES, WHETHER BASED ON CONTRACT, TORT, OR ANY OTHER LEGAL THEORY AND WHETHER ADVISED OF THE POSSIBILITY OF SUCH DAMAGES.

D. Local Law

1. This Warranty Statement gives the customer specific legal rights. The customer may also have other rights which vary from state to state in the United States, from province to province in Canada, and from country to country elsewhere in the world.

2. To the extent that this Warranty Statement is inconsistent with local law, this Warranty Statement shall be deemed modified to be consistent with such local law. Under such local law, certain disclaimers and limitations of this Warranty Statement may not apply to the customer. For example, some states in the United States, as well as some governments outside the United States (including provinces in Canada), may:
 - a. Preclude the disclaimers and limitations in this Warranty Statement from limiting the statutory rights of a consumer (e.g. the United Kingdom);
 - b. Otherwise restrict the ability of a manufacturer to enforce such disclaimers or limitations; or
 - c. Grant the customer additional warranty rights, specify the duration of implied warranties which the manufacturer cannot disclaim, or not allow limitations on the duration of implied warranties.

3. FOR CONSUMER TRANSACTIONS IN AUSTRALIA AND NEW ZEALAND, THE TERMS IN THIS WARRANTY STATEMENT, EXCEPT TO THE EXTENT LAWFULLY PERMITTED, DO NOT EXCLUDE, RESTRICT, OR MODIFY, AND ARE IN ADDITION TO, THE MANDATORY STATUTORY RIGHTS APPLICABLE TO THE SALE OF HP PRODUCTS TO SUCH CUSTOMERS.

DECLARATION OF CONFORMITY

according to ISO/IEC Guide 22 and EN 45014

Manufacturer's Name: Hewlett-Packard Singapore (Pte) Ltd
Manufacturer's Address: Asia Hardcopy Manufacturing Operation
 20 Gul Way, Singapore 629196

declares, that the product

Product Name: HP2500C, HP2500Cse, HP2500Cxi, HP2500CM*
Model Number: C2684A, C2686A, C2687A, C2685A
Product Options: All

conforms to the following Product Specifications:

Safety: IEC 950: 1991 + A1 + A2 + A3 + A4/ EN 60950: 1992 + A1 + A2 + A3 + A4
 IEC825-1: 1993 / EN 60825-1:1994 class I for LEDs

EMC: CISPR 22: 1993 Class B / EN 55022: 1994 Class B
 CISPR 22: 1993 Class A / EN 55022: 1994 Class A*
 IEN 50082-1: 1992
 IEC 801-2: 1991 / prEN 55024-2: 1992, 4kV CD, 8kV AD
 IEC 801-3: 1984 / prEN 55024-3: 1991, 3 V/m
 IEC 801-4: 1988 / prEN 55024-4: 1992, 0.5kV Signal Lines, 1kV Power Lines
 IEC 1000-3-2: 1995 / EN61000-3-2: 1995
 IEC 1000-3-3: 1994 / EN61000-3-3: 1995
 FCC Title 47 CFR, Part 15 Class B / VCCI-2
 FCC Title 47 CFR, Part 15 Class A / VCCI-1*
 AS / NZS 3548:1995/ ICES-003, Issue 2

Supplementary Information:

- (1) The product herewith complies with the requirements of the Low Voltage Directive 73/23/EEC and the EMC Directive 89/336/EEC, and carries the CE Marking accordingly.
- (2) The product was tested in a typical configuration with Hewlett Packard personal computer systems.
- (3) This Device complies with Part 15 of the FCC Rules. Operation is subject to the following two conditions: (1) this device may not cause harmful interference, and (2) this device must accept any interference received, including interference that may cause undesired operation.
 *This printer contains Local Area Network (LAN) options. When the interface cable is attached to either of the IEEE802.3 connectors, the printer meets the requirements of CISPR 22: 1993 Class A / EN 55022: 1994 Class A

Singapore, August 1998

Chan Kum Yew, Quality Manager

Australia Contact: Product Regulations Manager, Hewlett-Packard Australia Ltd, 31-41 Joseph Street,
 Blackburn, Victoria 3130, Australia

European Contact: Your Local Hewlett-Packard Sales and Service Office or Hewlett-Packard GmbH, Department
 HQ-TRE / Standards Europe, Herrenberger Straße 130, D-71034 Böblingen (FAX: +49-7031-14-3143)

USA Contact: Corporate Product Regulations Manager, Hewlett-Packard Company, 3000 Hanover Street,
 Palo Alto, CA 94304 (Phone: 415-857-1501)

Power Cord Statement

The power cord cannot be repaired. If it is defective it should be discarded or returned to the supplier.

LEDs Classification

CLASS 1 LED PRODUCT
LED KLASSE 1
APPARECCHIO LED DI CLASSE 1
PRODUCT KLASY 1 Z DIODAMI ĆEWHECYMYI LEE
Appareil à Diode Electroluminescente de Classe 1
ZAŘÍZENÍ LED TŘÍY 1
KLASS 1 LED APPARAT
LUOKAN 1 LED

Energy Consumption

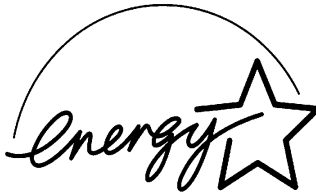

この記号は、環境部環境基準等電器検査自主規制協議会（VCCI）の基準に基づいた省エネルギー技術の表示です。この記号は、節電推進で使用することを目的としています。この記号がラベルやパッケージの電線に貼付して使用されると、電線損傷を引き起こすことがあります。取り扱い説明書に従って正しい取り扱いをして下さい。

Energy Star is a US registered service mark of United States Environmental Protection Agency

Safety Information



WARNING

Always follow basic safety precautions when using this product to reduce risk of injury from fire or electric shock.

1. Read and understand instructions in the User's Guide.
2. Observe all warnings and instructions marked on the product.
3. Unplug this product from wall outlets before cleaning.
4. Do not install product or use this product near water, or when you are wet.
5. Install the product securely on a stable surface.
6. Install the product in a protected location where no one can step on or trip over the line cord, and the line cord will not be damaged.
7. If the product does not operate normally, see "Troubleshooting" section in the User's Guide.



©Copyright 1999
Hewlett-Packard Company

450 Alexandra Road
Singapore 119960
Singapore.
<http://www.hp.com/go/hp2500>

Free Manuals Download Website

<http://myh66.com>

<http://usermanuals.us>

<http://www.somanuals.com>

<http://www.4manuals.cc>

<http://www.manual-lib.com>

<http://www.404manual.com>

<http://www.luxmanual.com>

<http://aubethermostatmanual.com>

Golf course search by state

<http://golfingnear.com>

Email search by domain

<http://emailbydomain.com>

Auto manuals search

<http://auto.somanuals.com>

TV manuals search

<http://tv.somanuals.com>