

# Hewlett-Packard 9875A Cartridge Tape Unit

## Installation and Operating

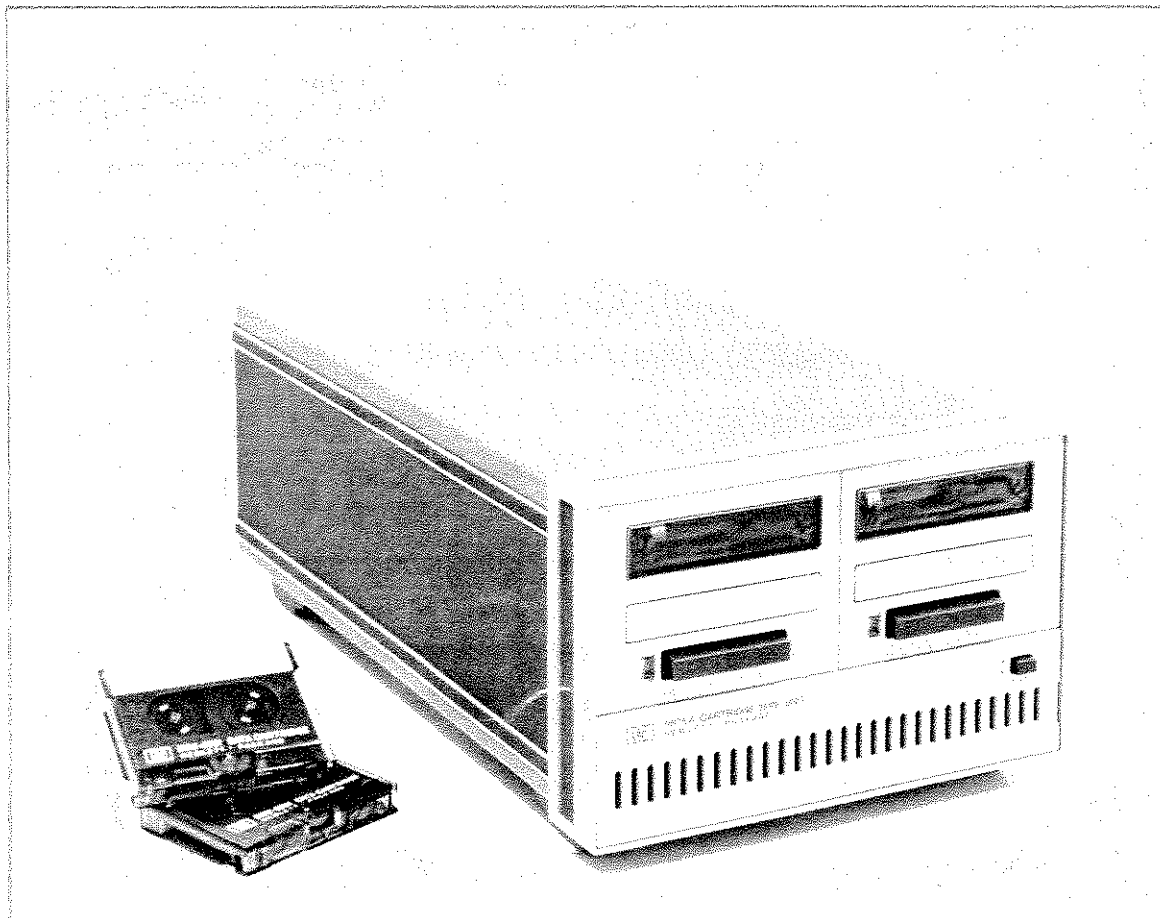

HEWLETT  PACKARD

### Warranty Statement

Hewlett-Packard products are warranted against defects in materials and workmanship. For Hewlett-Packard Calculator Products Divisions products sold in the U.S.A. and Canada, this warranty applies for ninety (90) days from date of delivery.\* Hewlett-Packard will, at its option, repair or replace equipment which proves to be defective during the warranty period. This warranty includes labor, parts and surface travel costs, if any. Equipment returned to Hewlett-Packard for repair must be shipped freight prepaid. Repairs necessitated by misuse of the equipment, or by hardware, software, or interfacing not provided by Hewlett-Packard are not covered by this warranty.

NO OTHER WARRANTY IS EXPRESSED OR IMPLIED, INCLUDING, BUT NOT LIMITED TO, THE IMPLIED WARRANTIES OF MERCHANTABILITY AND FITNESS FOR A PARTICULAR PURPOSE. HEWLETT-PACKARD SHALL NOT BE LIABLE FOR CONSEQUENTIAL DAMAGES.

\*For other countries, contact your local Sales and Service Office to determine warranty terms.

# 9875A Cartridge Tape Unit

## Installation and Operating

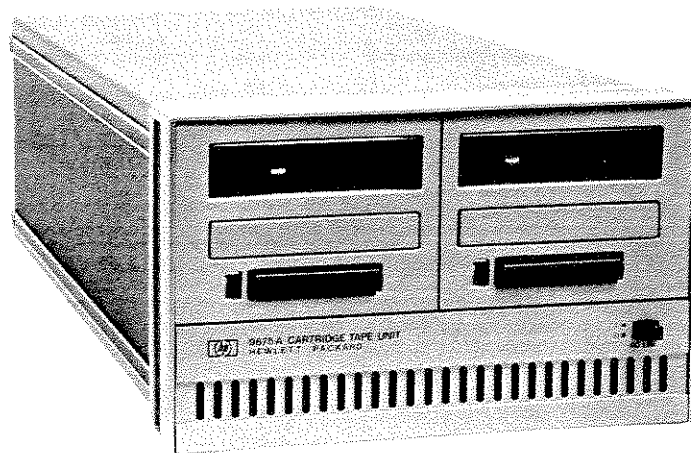

HP System 45 Desktop Computer  
9875A Cartridge Tape Unit

Hewlett-Packard Calculator Products Division  
P.O. Box 301, Loveland, Colorado 80537  
(For World-wide Sales and Service Offices see back of manual.)  
Copyright by Hewlett-Packard Company 1978

# Table of Contents

## Chapter 1: General Information

## Chapter 2: Installation

Cartridge Tape Unit Inspection Procedures .....	5
Equipment Supplied .....	5
Grounding Requirements .....	6
Power Requirements .....	6
Power Cords .....	6
Line Voltage .....	7
Fuses .....	8
Rack Mounting .....	8
Interface Connection .....	10
Cartridge Tape Unit Address Code .....	10
Power On Procedure .....	12
Tape Cartridge .....	13
Inserting and Removing the Cartridge .....	14
Cartridge Tape Unit Care .....	14
Magnetic Tape Head .....	14
Tape Cartridge .....	15
Conditioning the Tape .....	16
Respooling the Tape .....	16
Self Test .....	17
Self Test Procedure .....	17

## Chapter 3: HP Interface Bus

HP-IB System Terms .....	21
Interface Bus Concepts .....	22
Message Concepts .....	23
Addressing .....	24

## Chapter 4: Tape Format

Tracks .....	27
Files .....	27
Records .....	28
File Identifier Record .....	30
End of Valid Data Mark .....	30

## Chapter 5: Syntax

The HP 9875A Command Set .....	31
Syntax Guidelines .....	33
Automatic Verify .....	34
End of Data List .....	34
Find End of Valid Data .....	37
Find File .....	37
Identify File .....	38
Identify Record .....	39
Input Mask .....	40
Mark File .....	41
Mark Record .....	43
Output Error .....	44
Output Status .....	45
Read File .....	46
Read File Identifier .....	47
Read Record .....	47
Rewind .....	48
Select Drive .....	48
Store File .....	49
Store File Identifier .....	49
Store Record .....	50
Self Test .....	50
Time Interval .....	51
Write File .....	51
Write Record .....	53

## Chapter 6: Operation

Theory of Operation .....	55
Errors .....	56
Initialized Condition .....	57
Polling .....	57
Serial Poll .....	57
Parallel Poll .....	57
Normal Operation .....	58
Marking Files .....	58
Handling Errors .....	59

Storing Data .....	60
Premarked Files .....	60
Non-Premarked Files .....	61
Reading Data .....	62
Error Interrupt Routine .....	62
Input/Output of Data .....	63
Buffer Status Identifier .....	63
Self-Identify Mode .....	64
Primary Address .....	64
Device Identity Code .....	65
Device Specified Jump .....	66
Listen Only/Talk Only Mode .....	66
Listen Only .....	66
Talk Only .....	68
Programmable LO/TO .....	68
Tape Life .....	69

#### Appendices

A. Glossary .....	71
B. Bus Message Implementation .....	75
C. HP-IB Worksheet .....	85
D. Index .....	87
E. Sales and Service Offices .....	93
F. Status and Errors .....	95

#### Figures

1-1 Cartridge Tape Unit Front Panel .....	2
1-2 Cartridge Tape Unit Rear Panel .....	2
2-1 Power Cords .....	7
2-2 Nominal Line Voltage Settings .....	8
2-3 Rack Mounting Adaption .....	9
2-4 Connecting the Interface .....	10
2-5 Setting the Address Switches .....	12
2-6 Self Test Switch Off .....	12
2-7 Enabling Power to the CTU .....	13
2-8 Tape Cartridge Write Protection .....	13
2-9 Inserting the Tape Cartridge .....	14
2-10 Cleaning the Read/Write Head .....	15
2-11 Tape Cartridge .....	17
2-12 Self Test Switch On .....	18

3-1	Typical HP-IB System .....	22
4-1	File Geometry .....	27
4-2	Record Geometry .....	28
4-3	Header Geometry .....	29
4-4	End of Valid Data Mark (EVD) .....	30
5-1	File Size Interaction .....	42
6-1	Self-Identify Switch .....	65
6-2	Listen Only Address Switch Setting .....	66
6-3	Talk Only Address Switch Setting .....	68

#### Tables

1.	Equipment Supplied .....	5
2.	Rack Mounting Parts .....	9
3.	HP-IB Interfaces .....	10
4.	Available Bus Addresses and Codes .....	11
5.	Implemented Messages .....	24
6.	Parameter Output Format .....	31
7.	Command Syntax .....	32
8.	Initialized Conditions .....	33
9.	EOD Characters .....	35
10.	Continuous Output Specifier .....	36
11.	Available Conditions for SRQ and Affirmative Parallel Poll Response .....	40
12.	Output Error Parameters .....	44
13.	Programming Techniques Manuals .....	55
14.	Parallel Poll Response .....	57
15.	Buffer Status Identifier .....	64

## 9875A Cartridge Tape Unit Specifications

Read Speed and Write Speed:	559 mm/sec. (22 in./sec.)
Search Speed:	2286 mm/sec. (90 in./sec.)
Average Transfer Rate:	1500 bytes/sec.
(between controller and tape)	
Maximum Transfer Rate:	7000 bytes/sec.
(between controller and 9875A data buffer)	
End to End Search Time:	19 seconds
Number of Tracks:	2 (implemented as 1 logical track)

### CARTRIDGE

Tape:	DC-100
Usable Tape Length:	42.67 metres (140 ft.)
Bit Density:	1600 Flux reversals/in.
Data Capacity:	225K bytes/cartridge (dependent on tape organization)
Coding:	Delta-distance

### POWER REQUIREMENTS

Source:	100V +6% -13%	selected by rear panel switches
	120V +6% -13%	
	220V +6% -13%	
	240V +6% -13%	
Frequency:	48 Hz to 66 Hz	
Consumption:	100V/800 mA	
	120V/680 mA	
	220V/380 mA	
	240V/345 mA	



## SIZE / WEIGHT

Height:	132.6 mm (5.22 in.)
Width:	212.3 mm (8.35 in.)
Depth:	345.4 mm (13.60 in.)
Net Weight:	6.5 Kg (14.3 lb.) 1 drive; 6.9 Kg (15.2 lb.) 2 drives
Shipping Weight:	10.5 Kg (23.1 lb.) 1 drives; 10.9 Kg (24 lb.) 2 drives

## ENVIRONMENTAL RANGE

Temperature:	5°C to 40°C
Relative Humidity:	20% to 80% non-condensing

# Chapter 1

## General Information

This manual provides the installation and operating information for the HP 9875A Cartridge Tape Unit (CTU).

The cartridge tape unit is an HP Interface Bus (HP-IB)<sup>1</sup> compatible device, that can be used for data logging, data base storage and program storage with HP-IB compatible controllers.

The HP 9875A Cartridge Tape Unit provides data storage capability by writing data on and reading data from a magnetic tape (HP P/N 9162-0061). Option 001 provides the cartridge tape unit with a second tape transport system.

You should be thoroughly familiar with the appropriate Input/Output (I/O) procedures for your controller before using the HP 9875A Cartridge Tape Unit.

If you are not familiar with magnetic tape terminology, refer to the glossary in Appendix A.

<sup>1</sup> The HP-IB is Hewlett-Packard's implementation of IEEE standard 488-1975.

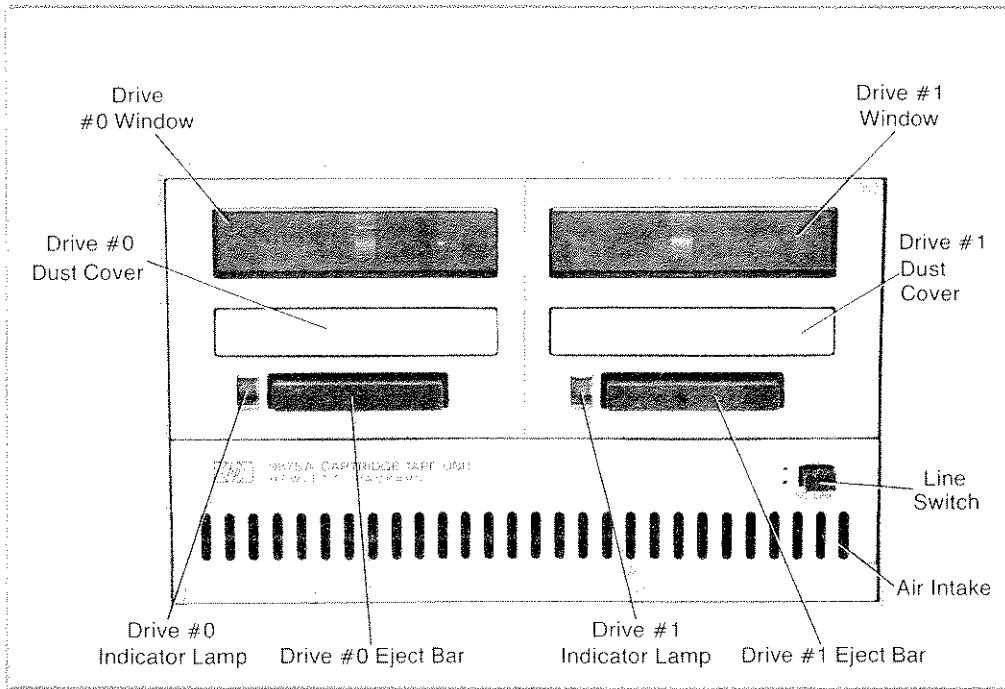

Figure 1-1: Cartridge Tape Unit Front Panel

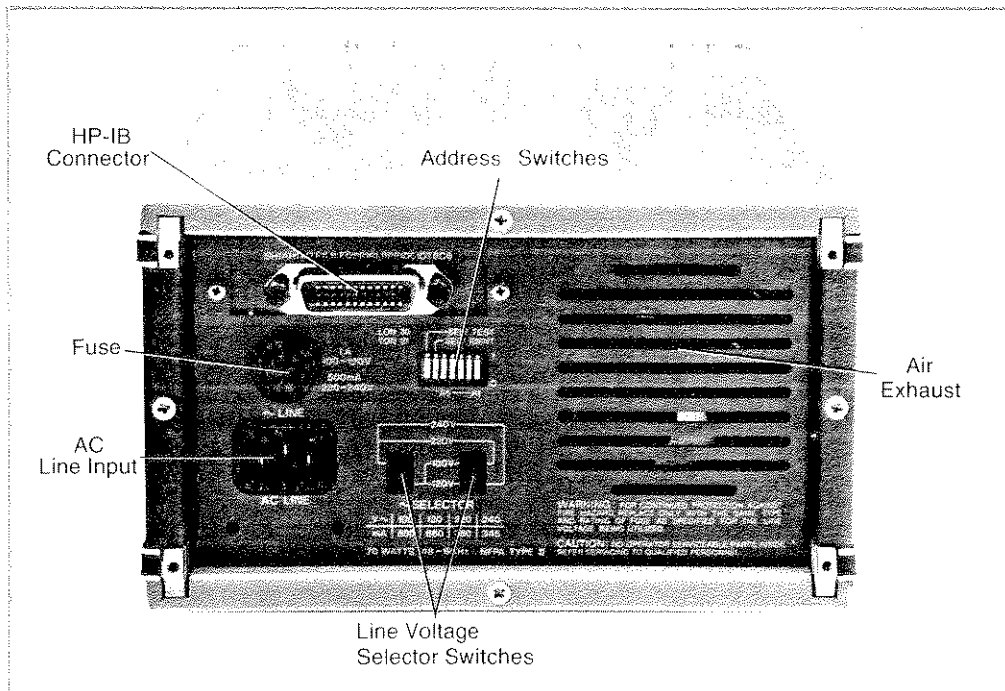

Figure 1-2: Cartridge Tape Unit Rear Panel

When you buy a Hewlett-Packard peripheral, service is an important factor. If you are to get maximum use from your machine, it must be in good working order. An HP Maintenance Agreement is the best way to keep your machine in optimum running condition.

Consider these important advantages –

- **Fixed Cost** – The cost is the same regardless of the number of calls, so it is a figure that you can budget.
- **Priority Service** – Your Maintenance Agreement assures that you receive priority treatment, within an agreed upon response time.
- **On-Site Service** – There is no need to package your equipment and return it to HP. Fast and efficient modular replacement at your location saves you both time and money.
- **A Complete Package** – A single charge covers labor, parts, and transportation.
- **Regular Maintenance** – Periodic visits are included, per factory recommendations, to keep your equipment in optimum operating condition.
- **Individualized Agreements** – Each Maintenance Agreement is tailored to support your equipment configuration and your requirements.

After considering these advantages, we are sure you can see how a Maintenance Agreement is an important and cost-effective investment.

For more information, please contact your local HP Sales and Service Office. The HP Sales and Service Offices are listed in Appendix E.

To help us in preparing new manuals, there is a questionnaire in the back of this manual. Your feedback is our only way of evaluating the relevance of our manuals to our customers.

Your answers to the five questions can assist us in producing better, more useful manuals. After using this manual, please complete the questionnaire and mail it. The postage is prepaid. Thank you.

# Chapter 2

## Installation

This section contains the installation and connection procedures for the HP 9875A Cartridge Tape Unit (CTU).

### Cartridge Tape Unit Inspection Procedures

The individual parts of your cartridge tape unit were thoroughly inspected before they were shipped to you. The cartridge tape unit should be in good operating order. Carefully check the cartridge tape unit, the HP-IB cable and other items for any physical damage sustained in transit. Notify your nearest HP Sales and Service Office and file a claim with the carrier if any such damage has occurred.

Please check to ensure that you have received all of the items which you ordered and that the cartridge tape unit has the correct options installed for your system. Refer to the table on this page and check that you have received all of your equipment.

If you have any difficulties with your system, if it is not operating properly or if any items are missing, please contact the HP Sales and Service Office nearest you. A listing of the Sales and Service Offices can be found in Appendix E.

### Equipment Supplied

The following items are packaged with the HP 9875A Cartridge Tape Unit:

	H/P part number
Operating Manual	09875-90000
Tape Cartridge	9162-0061
Tape Head Cleaner	8500-1251
Spare Fuses	
1A	2110-0007
.5A	2110-0202

Power Cord (Appropriate cord supplied, based on origin of sale order).

Table 1: Equipment Supplied

## Grounding Requirements

To protect operating personnel, the National Electronic Manufacturers' Association (NEMA) recommends that the cartridge tape unit be properly grounded. The cartridge tape unit is equipped with a three conductor power cable which, when connected to an appropriate power receptacle, grounds the cartridge tape unit. To preserve this protection feature, do not operate the cartridge tape unit from an AC power outlet which has no ground connection.

## Power Requirements

The HP 9875A Cartridge Tape Unit has the following power requirements:

Line Voltage	100 VAC, 120 VAC, 220 VAC, 240 VAC,	} +6%, -13%
Line Frequency:	48 to 66 Hertz	
Power Consumption:	100 V @ 800 mA 120 V @ 680 mA 220 V @ 380 mA 240 V @ 350 mA	

## Power Cords

Power Cords supplied by HP will have polarities matched to the power input socket on the cartridge tape unit, as shown in Figure 2-1.

L – Line or Active Conductor (also called “line” or “hot”)

N = Neutral or Identified Connector

E = Earth or Safety Ground

---

### WARNING

IF IT IS NECESSARY TO REPLACE THE POWER CORD, THE REPLACEMENT CORD MUST HAVE THE SAME POLARITY AS THE ORIGINAL. OTHERWISE A SAFETY HAZARD FROM ELECTRICAL SHOCK TO PERSONNEL, WHICH COULD RESULT IN INJURY OR DEATH, MIGHT EXIST. IN ADDITION, THE EQUIPMENT COULD BE SEVERELY DAMAGED IF EVEN A RELATIVELY MINOR INTERNAL FAILURE OCCURRED.

---

Power cords with different plugs are available for the cartridge tape unit; the part number of each cord is shown below. Each plug has a ground connector. The cord packaged with each cartridge tape unit depends upon where that cartridge tape unit is to be delivered. If your cartridge tape unit has the wrong power cord for your area, please contact your nearest HP Sales and Service Office.

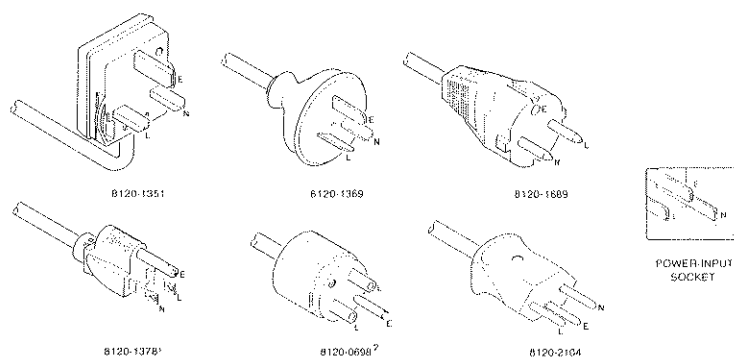

**Figure 2-1: Power Cords**

- 1 UL and CSA approved for use in the United States of America and Canada with cartridge tape units set for either 100 or 120 VAC operation.
- 2 UL and CSA approved for use in the United States of America and Canada with cartridge tape units set for either 220 or 240 VAC operation.

## Line Voltage

The HP 9875A Cartridge Tape Unit must be set for the powerline voltage in your area. The figure below shows the correct settings for each nominal line voltage. If it is necessary to alter the setting of either switch, turn power off to the cartridge tape unit and insert the tip of a small screwdriver into the slot on the switch. Slide the switch so that the position of the slot corresponds to the desired voltage as shown in Figure 2-2.

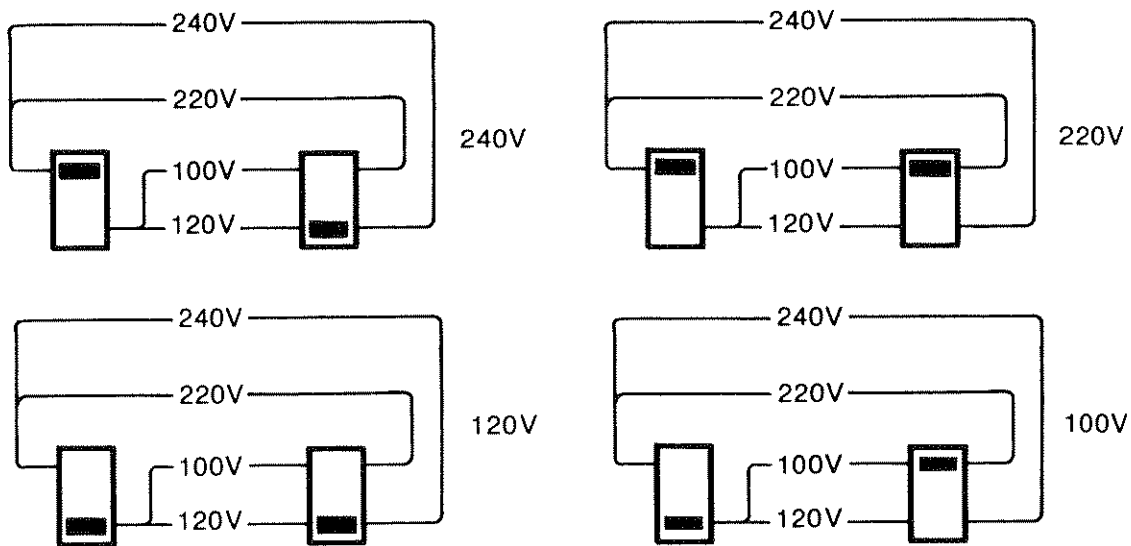

Figure 2-2: Nominal Line Voltage Settings

## Fuses

The cartridge tape unit uses the following line fuses:

Line Voltage	Fuse	Part Number
100 or 120 VAC	1A	2110-0007
220 or 240 VAC	.5A	2110-0202

### WARNING

TO AVOID THE POSSIBILITY OF SERIOUS INJURY, DISCONNECT THE AC POWER CORD BEFORE REMOVING OR INSTALLING A FUSE.

To change the fuse, first disconnect the power cord to the cartridge tape unit. Then remove the fuse cap by pressing inward while twisting it counterclockwise. Remove the fuse from the cap and insert the correct replacement fuse (either end) into the cap. Finally put the fuse and cap back into the holder. Press on the cap and twist it clockwise until it locks into place.

## Rack Mounting

The HP 9875A Cartridge Tape Unit can be adapted for rack mounting installation. Your particular rack mounting installation may require that you select the bus address (page 11) before rack mounting the cartridge tape unit.



The additional parts which are required for rack mounting are:

**Table 2: Rack Mounting Parts**

Half-Module Rack Assembly (Option 002) (09875-80002)		
Part Number	TQ	Description
2510-0193	4	Screws 8-32 x $\frac{3}{8}$ " P.H.
5020-8862	1	Rack Mounting Flange (5 $\frac{1}{4}$ " )
5061-0006	1	Half Module Rack Adapter (5 $\frac{1}{4}$ " )

Side By Side Rack Assembly <sup>1</sup>		
Part Number	TQ	Description
0050-0515	4	Front Horizontal Lock Links
0050-0516	2	Rear Horizontal Lock Links
2510-0192	4	Screws 8-32 x $\frac{1}{4}$ " F.H.
2510-0193	4	Screws 8-32 x $\frac{3}{8}$ " P.H.
2360-0360	4	Screws 6-32 x $\frac{7}{16}$ " F.H.
5020-8862	2	Rack Mounting Flange (5 $\frac{1}{4}$ " )

<sup>1</sup> This configuration is possible only when mounting cabinets of equal depth together.

The rack mounting adaption is shown in Figure 2-3.

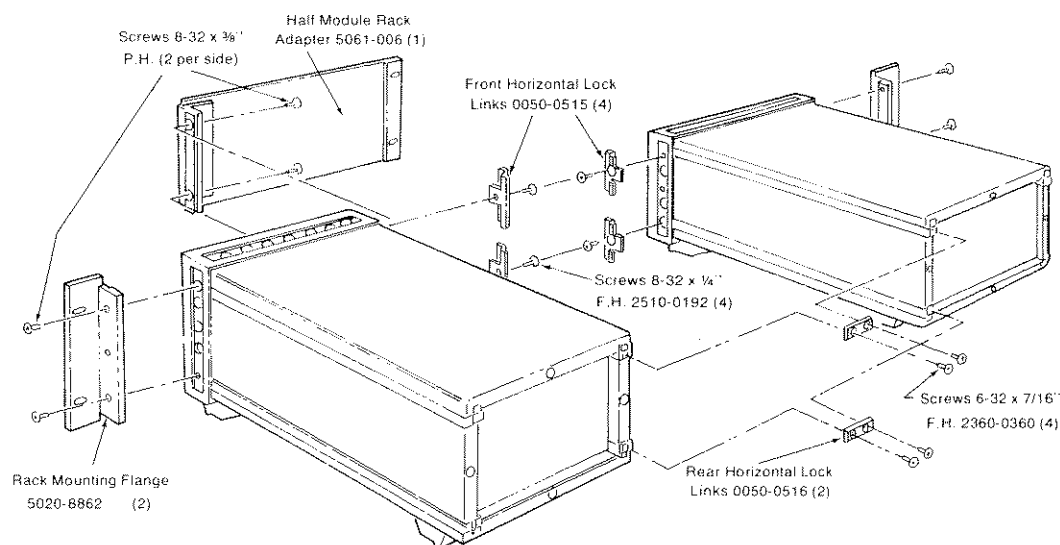

**Figure 2-3: Rack Mounting Adaption**

<sup>1</sup> Units can be mounted together only when cabinets are of equal depth.

## Interface Connection

### CAUTION

THE CTU AND THE INTERFACE SYSTEM (CONTROLLER AND ALL INTERCONNECTED DEVICES) MUST HAVE THE POWER SWITCHED OFF BEFORE CONNECTING THE INTERFACE. FAILURE TO DO THIS CAN RESULT IN DAMAGE TO THE EQUIPMENT.

The HP 9875A Cartridge Tape Unit is connected to the controller via the HP-IB. The following interfaces are used to connect the HP 9875A Cartridge Tape Unit to HP Desktop Computers and Controllers. The interface should be connected to the cartridge tape unit as shown in the photo (Figure 2-4).

**Table 3: HP-IB Interfaces**

Interface	Controller
HP 98135A	9815A
HP 98034A	9825A
HP 59405A Opt. 30	9830A, 9820A, 9821A
HP 98034A	9831A
HP 98034A	9845A

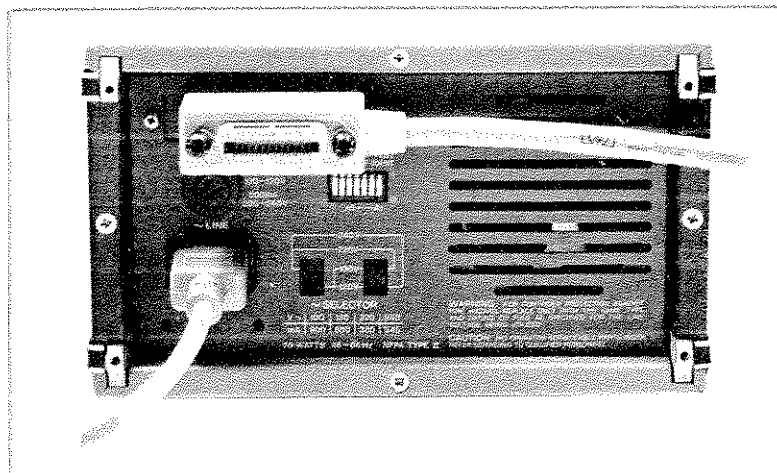

**Figure 2-4: Connecting the Interface**

### Cartridge Tape Unit Address Code

Since each HP-IB system can have as many as 15 devices connected to it, each device must be set to a specific address code.

The cartridge tape unit can be set to any one of 30 HP-IB addresses ranging from 0 through 29. (Address 30 is reserved for Listen Only Mode; Address 31 is reserved for Talk Only Mode.) Each address can be selected by setting the switches on the cartridge tape unit rear panel. Set the switches to the appropriate binary bit positions for the particular address desired. A complete listing of available bit positions is shown in Table 4.

The cartridge tape unit is set to an address code of 4 at the factory. Check your cartridge tape unit for the proper switch positions.

**Table 4: Available Bus Addresses and Codes**

Address Characters		Address Switch Settings					Address Codes
Listen	Talk	(5)	(4)	(3)	(2)	(1)	decimal
SP	@	0	0	0	0	0	0
!	A	0	0	0	0	1	1
"	B	0	0	0	1	0	2
#	C	0	0	0	1	1	3
\$	D	0	0	1	0	0	4 ← preset
%	E	0	0	1	0	1	5
&	F	0	0	1	1	0	6
'	G	0	0	1	1	1	7
(	H	0	1	0	0	0	8
)	I	0	1	0	0	1	9
*	J	0	1	0	1	0	10
+	K	0	1	0	1	1	11
,	L	0	1	1	0	0	12
-	M	0	1	1	0	1	13
.	N	0	1	1	1	0	14
/	O	0	1	1	1	1	15
0	P	1	0	0	0	0	16
1	Q	1	0	0	0	1	17
2	R	1	0	0	1	0	18
3	S	1	0	0	1	1	19
4	T	1	0	1	0	0	20
5	U	1	0	1	0	1	21
6	V	1	0	1	1	0	22
7	W	1	0	1	1	1	23
8	X	1	1	0	0	0	24
9	Y	1	1	0	0	1	25
:	Z	1	1	0	1	0	26
;	[	1	1	0	1	1	27
<	]	1	1	1	0	0	28
=	^	1	1	1	0	1	29
?	_	1	1	1	1	0	30 ← listen only
		1	1	1	1	1	31 ← talk only

Both the Interface Select Code and the Cartridge Tape Unit Address Code should be entered on your HP-IB worksheet in Appendix C. This worksheet enables you to keep track of all the address settings for your interface system.

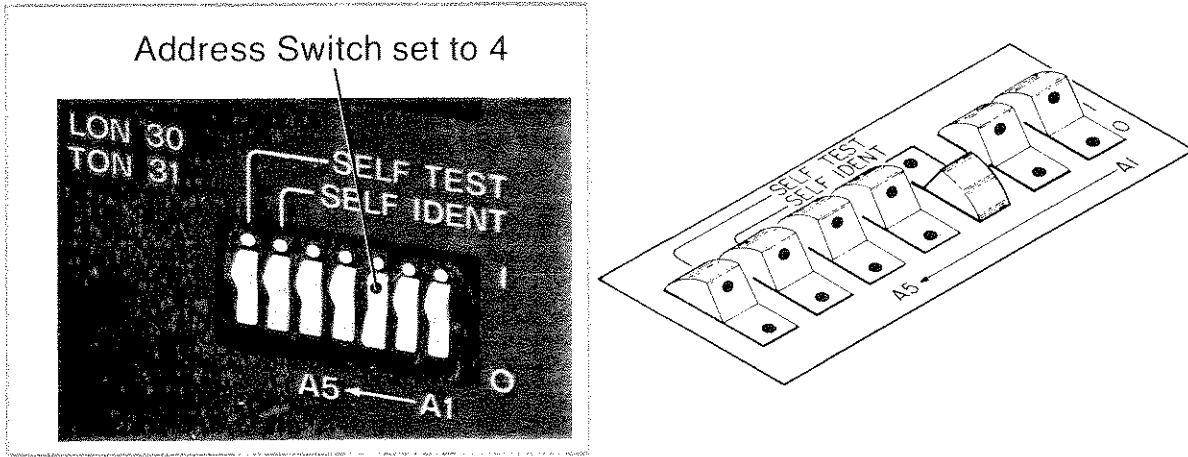

Figure 2-5: Setting the Address Switches

## Power On Procedure

1. Verify that the line voltage switch settings are correct.
2. Verify that the proper fuse is installed.
3. Verify that the self-test switch is off unless you are conducting a self-test. The self-test switch is shown in the photo below (Figure 2-6).

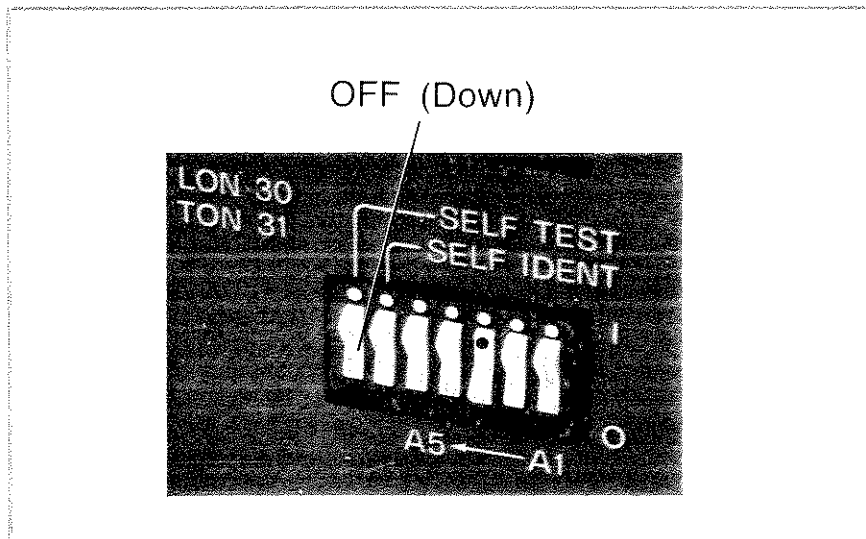

Figure 2-6: Self Test Switch OFF

4. Verify that the power cord is connected to the CTU and the outlet.
5. Enable power by depressing the switch on the front panel (Figure 2-7).
6. Verify that one of the front panel lamps is lit. If it is flashing, refer to the Self Test in this chapter.

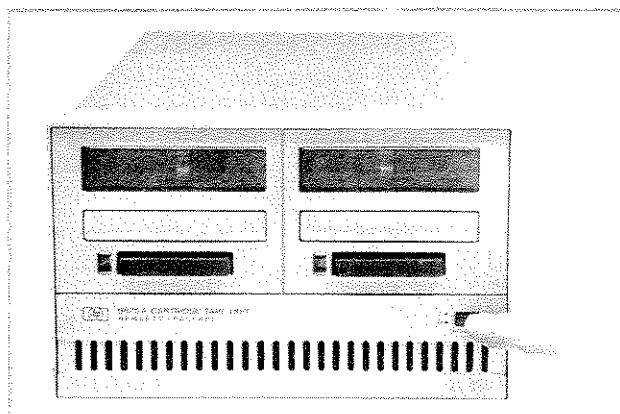

Figure 2-7: Enabling Power to the CTU

## Tape Cartridge

The tape cartridge is shown in the photo below.

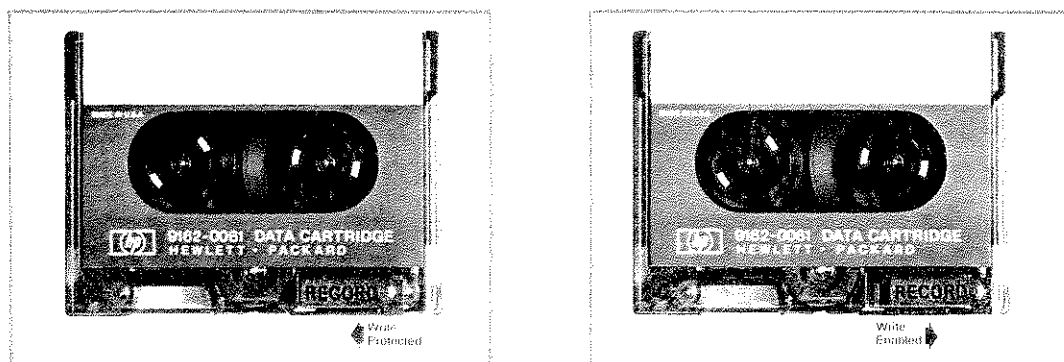
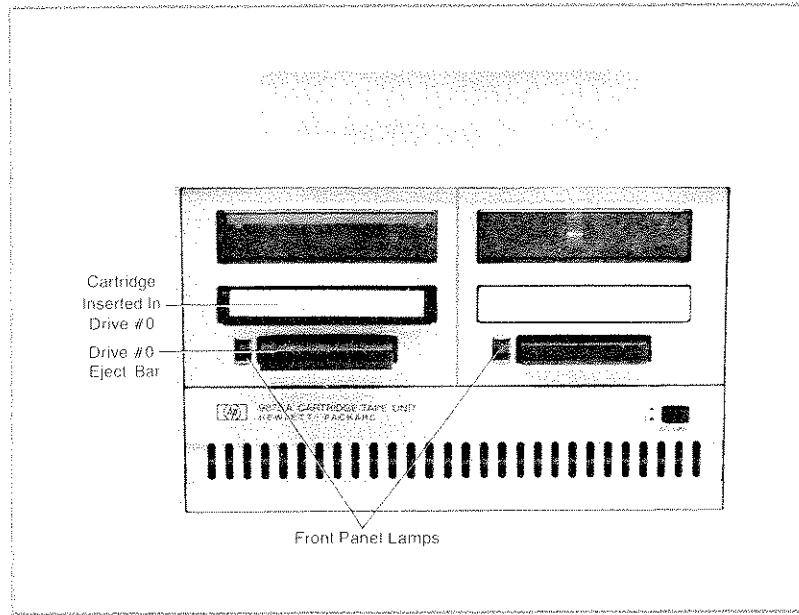

Figure 2-8: Tape Cartridge Write Protection

The cartridge has a write protect tab. When the tab is slid all the way in the direction of the arrow data can be recorded on the tape. When the tab is slid all the way against the direction of the arrow, data cannot be recorded on the tape. This is referred to as being “write protected”.

## Inserting and Removing the Cartridge

Insert the tape cartridge so that the label on the cartridge faces the window in the front panel, as shown in the photo below.



**Figure 2-9: Inserting the Tape Cartridge**

The cartridge can be removed from the drive by pressing the eject bar.

The front panel lamps are used to indicate which tape drive is selected. A flashing front panel lamp indicates that the CTU is in an error condition. Refer to the section on Handling Errors in Chapter 6.

## Cartridge Tape Unit Care

The HP 9875A Cartridge Tape Unit should be periodically cleaned.

Dirt and dust are by far the greatest cause of cartridge related errors. Several basic precautions can reduce such problems substantially.

### Magnetic Tape Head

To ensure the reliability of tape operation, it is recommended that the tape head be cleaned after every eight hours of tape operations. It's a good idea to clean the tape head before making important recordings.

The tape head is cleaned as follows:

1. Remove the tape cartridge if installed.
2. Clean the tape head with a cotton swab that has been dampened with head cleaning solution (HP P/N 8500-1251). Wipe the top of the head a few times with the cotton swab. Remove any other dust that has accumulated in the vicinity of the tape head.

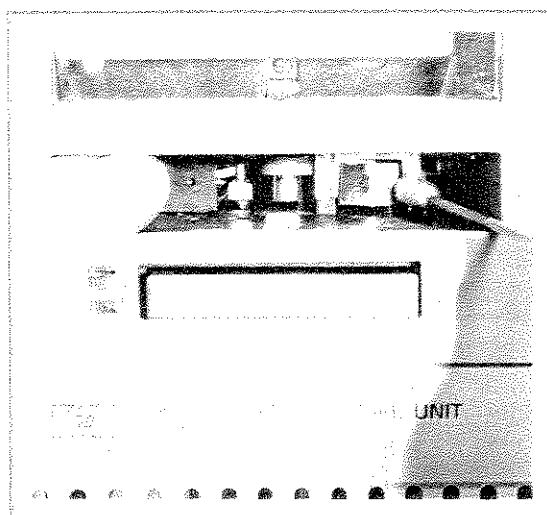

Figure 2-10: Cleaning the Read/Write Head

## Tape Care

### Tape Cartridge

1. Rewind the cartridge after each use
2. Keep the tape transport door clean.
3. Keep the cartridge in the plastic container supplied with it.

Two other factors can affect the reliability of the tape cartridge. Strong magnetic fields can erase data and programs stored on the cartridge. Physical damage to the tape, such as wrinkled or folded tape can also cause write and read problems. Since loss of data can be an inconvenience at best, and a disaster at worst, you should always maintain a back-up copy for critical programs or data on a separate tape cartridge.

## Conditioning The Tape

Repeated operations over a short length of tape (usually less than 4000 bytes or 1.5m (5 ft.)) can cause slack (extreme changes in temperature can also cause this). The outer layer of tape can slip and rub on the cartridge, causing damage to the tape. If tape drive operation continues, the tape may jam and be ruined.

---

### NOTE

This problem is most likely to occur if exclusive use is made of one file or two adjacent files near the beginning or end of tape.

---

If a particular application requires such operation, this slack can be prevented by conditioning the tape periodically. Conditioning the tape can be done by executing a FE instruction, followed by a RW instruction. The FE and RW instructions are explained in Chapter 5.

## Respooling the Tape

If the tape unwinds completely from one of the reels, refer to Figure 2-11 using the following procedure to rethread the tape.

1. Remove the 4 screws holding the cartridge cover and remove the cover.
2. Thread the tape around the guides as shown in the figure.
3. With the tape extended almost to the drive belt, moisten the end of the tape so that it will stick to the take-up reel.

Use a pencil (or other sharp instrument) to guide the tape between the drive belt and the take-up reel. Keeping the tape taut, wind the tape onto the take-up reel using the pencil.

As you wind the tape onto the reel, ensure that there is no slack in the tape. If the tape is not tight, repeat the operation. Be sure the tape follows the hub around for the first turn.

Wind at least 20 turns of tape onto the reel by turning the drive roller. If any rollers creep up away from the plate, press them back again.



Reassemble the cartridge.

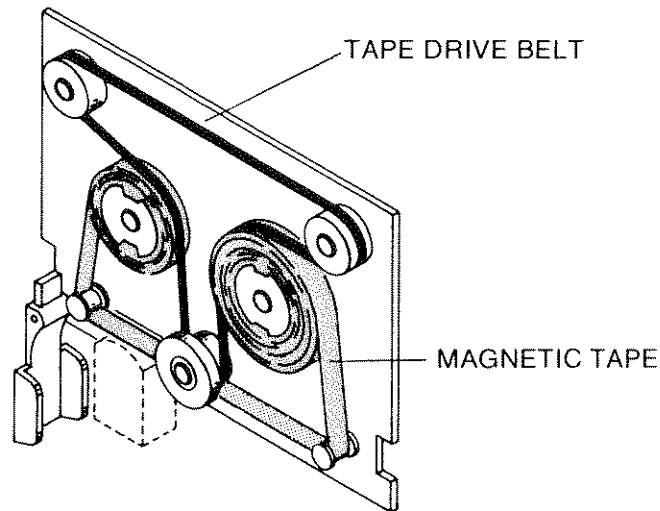

Figure 2-11: Tape Cartridge

## Self Test

The Self Test is used to verify proper operation of the CTU. Whenever power is applied to the CTU, the CTU automatically conducts a test of the internal electronic circuitry.

The read/write tape circuitry can only be tested by inserting a tape cartridge into the CTU. A dual-drive CTU requires that a tape cartridge be inserted in each tape drive.

### Self Test Procedure

1. Turn power off to the CTU.
2. Insert a tape cartridge (preferably blank) into each tape drive of the CTU. The record protect tab must be positioned so that data can be recorded on the tape (tab slid in the direction of the arrow). The Self Test records data on the tape. Therefore you should use a tape which does not contain any important data.

3. Set the Self Test switch on the rear panel of the CTU on, as shown in the photo.

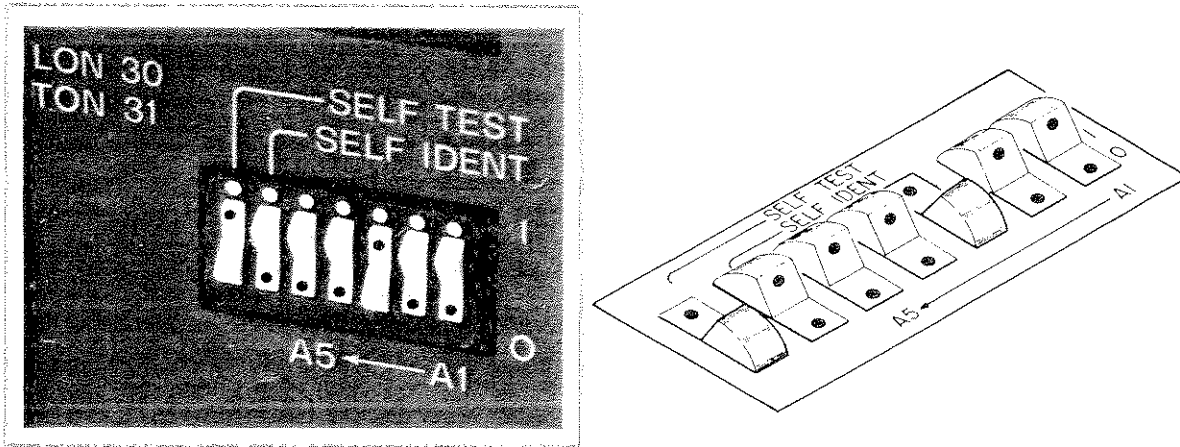

Figure 2-12: Self Test Switch On

4. Turn power on to the CTU.

The test results are displayed by the lamps on the front panel of the CTU. If the CTU has failed the Self Test, a front panel lamp flashes.

A common error during the Self Test occurs when the cartridge is write protected, or is not installed in the CTU while the CTU is running the Self Test. If either of these two conditions exist, correct them and re-run the Self Test.

Another source of Self Test failure is a defective tape. Re-running the test with a new tape may be all that is required to verify the operation of the CTU.

If the indicator lamp is still flashing, contact your nearest HP Sales and Service Office.

A more comprehensive testing of your system (controller and interface) can be accomplished by using your controller to output the Self Test and Output Error commands. The Self Test command is explained in Chapter 5, Syntax.

A detailed listing of the Self Test results is found in Chapter 5, under the Output Error command.

---

**NOTE**

The self test switch must be switched off for normal operation of the CTU. If the self test is not off, the CTU ~~can only respond to the OE and OS commands.~~ *cannot respond to commands.*

---

## Chapter 3

# HP-Interface Bus

### Overview of the HP-Interface Bus

The HP Interface Bus (HP-IB) is Hewlett-Packard's implementation of the IEEE standard 488-1975. The HP-IB provides an interconnecting channel for data transfer between devices on the HP-IB.

The following is a definition of the terms and concepts used to describe HP-IB (bus) system operations.

#### HP-IB System Terms

1. **Addressing** – The characters sent by a controlling device specifying which device sends information on the bus and which device(s) receives that information.
2. **Byte** – A unit of information consisting of 8 binary digits (bits).
3. **Device** – Any unit that is compatible with the IEEE Standard 488-1975.
4. **Device Dependent** – A response to information sent on the HP-IB that is characteristic of an individual device's design and may vary from device to device.
5. **Operator** – The person that operates either the system or any device in the system.
6. **Polling** – The process typically used by a controller to locate a device that needs to interact with the controller. There are two types of polling:
  - **Serial Poll** – This method obtains one byte of operational information about an individual device in the system. The process must be repeated for each device from which information is desired.
  - **Parallel Poll** – This method obtains information about a group of devices simultaneously.

## Interface Bus Concepts

Devices which communicate along the interface bus can be classified into three basic categories:

1. **Talkers** – Devices which **send** information on the bus when they have been addressed.
2. **Listeners** – Devices which **receive** information sent on the bus when they have been addressed.
3. **Controllers** – Devices that can specify the talker and listeners for an information transfer. Controllers can be categorized as one of two types:
  - **Active Controller** – The current controlling device on the bus.
  - **System Controller** – The controller that can take priority control of the bus even if it is not the current active controller. Although each bus system can have only one system controller, the system can have any number of devices capable of being the active controller.

A typical HP-IB System is shown below.

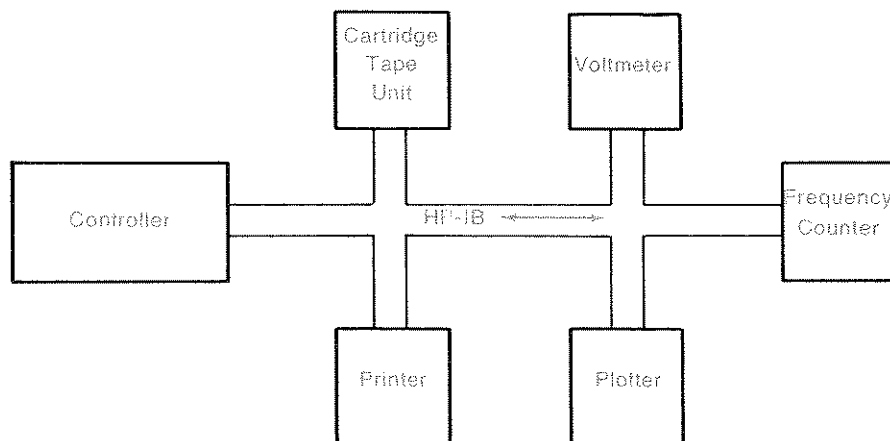

Figure 3-1: Typical HP-IB System

## Message Concepts

Devices which communicate along the interface bus are transferring quantities of information. The transfer of information can be from one device to another device, or from one device to more than one device. These quantities of information can easily be thought of as “messages”.

In turn, the messages can be classified into twelve types. The HP 9875A Cartridge Tape Unit is capable of implementing only six of the twelve interface messages. The six implemented messages are screened in the following explanations. The six implemented messages are also listed in Table 5. This information is also entered on the HP-IB worksheet in Appendix C.

1. **The Data Message.** This is the actual information which is sent from one talker to one or more listeners along the interface bus.
2. **The Trigger Message.** This message causes the listening device(s) to perform a device-dependent action.
3. **The Clear Message.** This message causes either the listening device(s) or all of the devices on the bus to return to their predefined device-dependent states.
4. **The Remote Message.** This message causes listening devices to switch from local front-panel control to remote program control.
5. **The Local Message.** This message clears the **Remote Message** from the listening device(s) and returns the device(s) to local front-panel control.
6. **The Local Lockout Message.** This message prevents a device operator from manually inhibiting remote program control.
7. **The Clear Lockout and Set Local Message.** This message causes all devices on the bus to be removed from **Local Lockout** and revert to **Local**. This message also clears the **Remote Message** for all devices on the bus.
8. **The Require Service Message.** A device can send this message at any time to signify that the device needs some type of interaction with the controller. This message is cleared by the device's **Status Byte Message** if the device no longer requires service.
9. **The Status Byte Message.** A byte that represents the status of a single device on the bus. One bit indicates whether the device sent a **Require Service Message** and the remaining bits indicate operational conditions defined by the device. This byte is sent from a talking device in response to a serial poll operation performed by a controller.
10. **The Status Bit Message.** A byte that represents the operational conditions of a group of devices on the bus. Each device responds on a particular bit of the byte thus identifying a device-dependent condition. This bit is typically sent by devices in response to a parallel poll operation.

The Status Bit Message can also be used by a controller to specify the particular bit and logic level that a device will respond with when a parallel poll operation is performed. Thus more than one device can respond on the same bit.

11. **The Pass Control Message.** This transfers the bus management responsibilities from the active controller to another controller.
12. **The Abort Message.** The system controller sends this message to unconditionally assume control of the bus from the active controller. This message terminates all bus communications but does not implement a **Clear Message**.

These messages represent the full implementation of all HP-IB system capabilities. Each device in a system, may be designed to use only the messages that are applicable to its purpose in the system. It is important for you to be aware of the HP-IB functions implemented on each device connected to your HP-IB system to ensure the operational compatibility of the system. (The IEEE equivalent flowcharts of these messages may be found in Appendix B.)

**Table 5: Implemented Messages**

Implemented	Capability	Not Implemented
Data	S & R	Trigger
Clear	R	Local
Require Service	S	Remote
Status Byte	S	Local Lockout
Status Bit	S	Clear Lockout and Set Local
Abort	R	Pass Control

S = Send Only  
R = Receive Only  
S & R = Send and Receive

## Bus Protocol Addressing

The commands for the cartridge tape unit are transmitted along the interface in the following form:

Bus Address Parameters	(Command) Data	Terminator (EOC)
---------------------------	-------------------	---------------------

The Bus Address Parameters specify where the data is originating (talker) and the destination where the data is being received (listener). Some controllers automatically send the proper transfer parameter for origination or destination depending upon the type of message which is being sent. You should refer to your controller's operating manual to determine if any additional transfer parameters need to be sent.

The command consists of three things: a two-letter mnemonic, parameters if needed, and an EOC which terminates the command (the end of command character).

The EOC accepted by the CTU can be one of three things:

1. An ASCII Linefeed (LF).
2. An ASCII Semi-colon (;).
3. An interface EOI sent with the last byte of the command.

After a controller has addressed the CTU to listen, the command is sent to the CTU as the data portion of the message. In this example it is

$\frac{\text{'FF'}}{\text{Command}}$	$\frac{\text{'1,2'}}{\text{Parameter Field}}$	$\frac{\text{LF}}{\text{Terminator}}$
--------------------------------------	---	---------------------------------------

This data is interpreted by the CTU as a Find File command. The parameter field specifies that the tape should be positioned at file 1, record 2. The LF is output by the controller as the command terminator.

The command is sent in ASCII code and the command is a two-letter mnemonic (either upper or lowercase).



# Chapter 4

## Tape Format

The cartridge tape unit stores data on the magnetic tape cartridge in HP's Standard Interchange Format (SIF). This format has been implemented to allow data to be exchanged between devices which use magnetic tape cartridges as a storage medium.

The Standard Interchange Format is based on the concepts of Files and Records.

### Tracks

There are two physical tracks available for recording data on the cartridge. The HP 9875A treats the two physical tracks as one logical track. An end of valid data mark is used to indicate the logical end of the tape.

### Files

Data is stored in logical structures called "Files". Each file is comprised of smaller units called "Records".

A tape cartridge can contain up to 2047 files, depending on the file size. Each file may contain up to 4096 records.

The geometry of a tape file is shown in Figure 4-1.

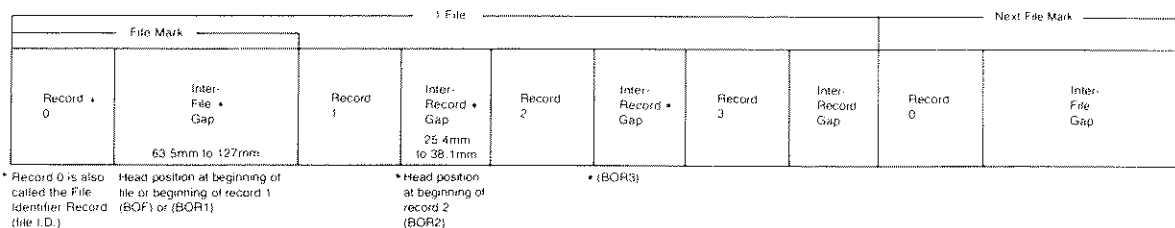

Figure 4-1: File Geometry

A File is comprised of the File mark and the File body.

The File Identifier Record and the Interfile Gap compromise the File Mark. A File Mark is found at the beginning of each file on the tape.

The File body is comprised of records and inter-record gaps.

## Records

Records are “subsets” of files. Each record can store up to 256 bytes of data. The record geometry is shown in Figure 4-2.

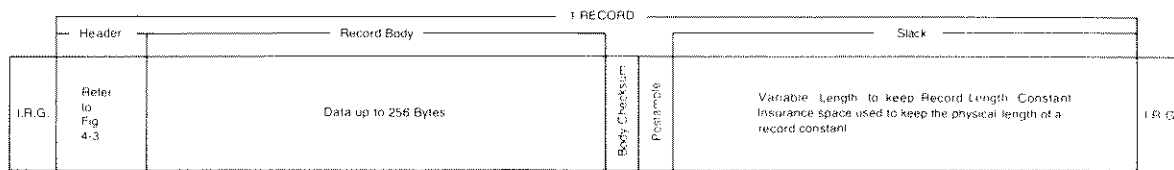

**Figure 4-2 : Record Geometry**

All records within a File must have the same absolute length. There are two types of records, “non-updateable” and “updateable”.

A record with its absolute size equalling zero cannot have its contents changed. This defines a “non-updateable” record. It is possible to have the absolute size equal zero and the used size be a non-zero value. An “updateable” record is a record whose contents can be changed.

The Record header contains the “bookkeeping” for each record of data stored on the tape.

The physical record number is the binary equivalent of the record number’s decimal value. All records are numbered sequentially.

The Record Body is the area where the data is recorded. The Body Checksum is a sum of the number of words in the record body.

The Postamble is an arbitrary word which is not intended to be read.

The Slack area is an area which maintains a uniform record length. It compensates for the record body length, speed variations and insurance space to maintain the overall record length. There is no Slack in a non-updateable record.

The Slack is followed by the Inter-Record Gap (IRG). The IRG is a gap of 25.4mm to 38.1mm which can be followed by either another record, a file mark or the End of Valid Data Mark.

The record header is shown in Figure 4-3.

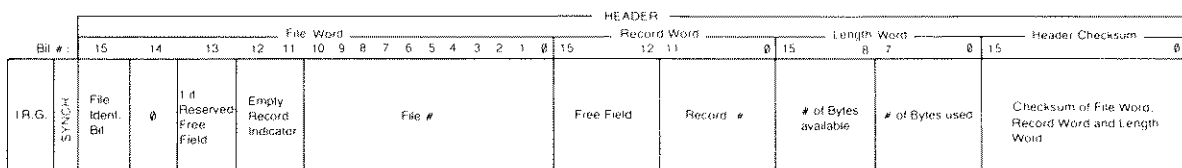

**Figure 4-3: Header Geometry**

The file word consists of the file number (bits 0–10), the empty record indicator (bits 11 and 12), the reserved bit (bit 13), bit 14 is always 0, and the file identifier bit (bit 15).

The file number is the numeric value of the file number in binary form.

The empty record indicator can be one of two types as shown below.

Bit 12	Bit 11	
0	0	Empty. The record body should not be read.
0	1	Not empty.
1	0	Not empty.
1	1	Not empty.

The reserved bit indicates that the free-field pattern in the record word has been reserved for a particular instrument. The reserved bit may be used to indicate that the data contained in a record has product specific meaning. Tapes recorded on the CTU have this bit set to “0”.

The file identifier bit is used to identify a file identifier record. If the file identifier bit is a “1”, this signifies that the record is a file identifier record.

The Record Word consists of the physical record number (bits 0 through 11) and the free-field (bits 12 through 15). The record number is the binary equivalent of its numeric value. In a file identifier record, this number is 0. The free-field provides four bits which, if reserved, indicate that the tape was written by a particular device. The CTU does not reserve the free field. Data written by a device using a reserved free field pattern is processed the same as non reserved data by the CTU. The free field pattern may be used for storing an additional four bit pattern, at your convenience.

The length word is divided into the number of bytes used (bits 0 through 7) and the absolute number of bytes available in the record (bits 8 through 15).

The Header Checksum is a checksum of the three (file word + record word + length) previous words.

### File Identifier Record

The File Identifier Header is record #0 of a file. It is similar in structure to the Record Header shown in Figure 4-3. The File Identifier Header is followed by the interfile gap.

The Record Header is identical to the File Identifier Header with the following exception:

the File Identifier bit is a “0” for a record instead of a “1” for a File Identifier Header.

### End of Valid Data Mark

The End of Valid Data Mark (EVD) signifies the logical end of a tape. No accessible data can exist after the EVD.

The EVD is a 317mm gap after the last record on the tape, as shown in Figure 4-4. There is only one EVD mark per tape.

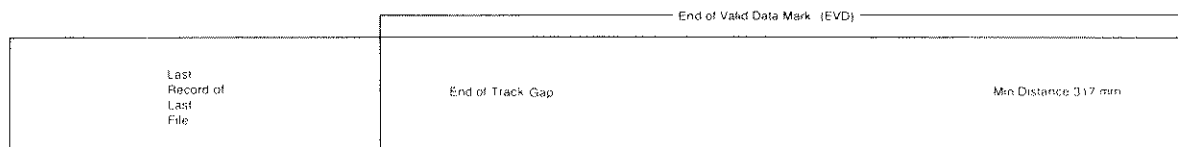

Figure 4-4 : End of Valid Data Mark (EVD)

# Chapter 5

## Syntax

### The HP 9875A Command Set

The Cartridge Tape Unit (CTU) responds to 23 commands. Each of these commands belongs to one of four categories.

1. Immediate Execution (IE)
2. Data Input (DI)
3. Data Output (DO)
4. Parameter Output (PO)

An immediate execution command is one in which after the command is received and executed, the CTU is ready for its next command.

A data input command is one in which after the command is received and executed, the CTU is ready to receive a data list which is to be stored on the tape cartridge.

A data output command is one in which after the command is received and executed, the CTU is ready to output a previously stored data list to a device.

A parameter output command is one in which after the command is received and executed, the CTU is ready to output parameters to the controller. These parameters contain coded information that relates to the condition of the CTU or the tape.

**Table 6: Parameter Output Format**

<b>Field Width</b>	<b>Inter-Parameter Delimiter</b>	<b>Parameter List Delimiter</b>
5 characters per parameters. Parameters are sent with leading spaces.	comma	carriage return/ linefeed

You have the option of reading all, some, or none of the parameters which are returned by the CTU in a parameter output command. The only stipulation is that if you are interested in reading a parameter, you must read all parameters which precede it.

For example, if you only want to read the fifth parameter being returned, you must also read parameters one through four or an error condition may occur.

A listing of the command syntax is shown in Table 7.

**Table 7: Command Syntax**

Command	Total Number of Parameters	Description	Type
AV	1 (1)	Enables or disables Auto Verification of recorded data list	IE
ED	3 (3)	Changes EOD terminator	IE
FE	0	Finds end of recorded data on tape	IE
FF	2 (1)	Finds specified file & record	IE
IF	1 (1)	Identifies file (3 parameters returned)	PO
IM	2 (2)	Sets require service and parallel poll response mask	IE
IR	1 (1)	Identifies Record (5 parameters returned)	PO
MF	5 (3)	Reserves file space on tape	IE
MR	2 (2)	Reserves record recording space on tape	IE
OE	0	Returns error codes and self test results (5 parameters returned)	PO
OS	0	Returns status byte value (1 parameter returned)	PO
RF	1 (1)	Reads contents of specified file	DO
RI	1 (1)	Reads contents of File I.D. record (record 0) of specified file	DO
RR	1 (1)	Reads contents of specified record	DO
RW	0	Rewinds the tape	IE
SD	1 (1)	Specifies a drive for commands to apply to	IE
SF	1 (1)	Stores contents of the following data list into the specified file	DI
SI	1 (1)	Stores contents of the following data list into File ID (Record 0) of the specified file	DI
SR	1 (1)	Stores contents of the following data list into the specified record	DI
ST	0	Initiates self-test	IE
TI	1 (1)	Specifies a time interval for use with data input/output commands	IE
WF	0	Creates a file and stores the following data list into it	DI
WR	0	Creates a record and stores the following data list into it	DI

(1) Number in parentheses is the number of optional parameters. Refer to syntax explanation for detailed information.

## Syntax Guidelines

The following general conventions apply to the syntax which is listed in this manual.

- AB** – all items shown in color must be entered as shown.
- [       ] – all items in square brackets are optional and explained in the text following the syntax.

The CTU is designed so that the command mnemonics can be either uppercase (AB) or lowercase (ab) characters and still be processed.

Any numeric parameters must be sent in fixed point notation. The CTU truncates any fractions that are sent in fixed point format. The CTU does not accept floating point values as parameters.

Any optional parameter can be skipped by sending an ASCII comma. Whenever a parameter is skipped the CTU uses the default value for that parameter.

At power on, or after a device clear message, the following conditions apply to the CTU.

**Table 8: Initialized Conditions**

Autoverify mode	disabled
End of Command Character	ASCII LF or Semi-colon
End of Data List Character	ASCII LF
Parallel Poll Response Mask	0
Require Service Mask	0
Select Drive	tape drive 0
Time Interval	off

Since this cartridge tape unit may be used with any HP-IB compatible controller, a typical usage example is given for each command. The examples are written for the cartridge tape unit (CTU). The controller's condition is not referred to in the examples. The examples are structured as shown below, using the following acronyms.

Cartridge Tape Unit (CTU)	Talker (T)
End of Command Character (EOC)	Listener (L)
End of Data List Character (EOD)	

(CTU-L) "RW" (EOC)

This example shows that the cartridge tape unit is the listener. The command is RW (rewind), and the controller is sending the end of command character at the end of the message.

## Automatic Verify

“AV [P1]”

Command: Immediate Execution

Parameter: 0 disables verify, 1 enables verify (optional)

Parameter Limits: P1 minimum 0, maximum 1, default 0

The Automatic Verify (AV) instruction sets a mode which allows you to verify that a block of information has been stored correctly on the tape. AV causes the CTU to execute a read after writing a record of data and compare the data on tape with the contents of the CTU's memory. The read is performed under more stringent electrical requirements, to ensure that the tape will pass subsequent read operations.

The AV mode reduces the effective recording speed by a factor of approximately 3.

(CTU-L) “AV 1” (EOC)

This example enables the AV mode.

## End of Data List

“ED[P1][,P2][,P3]”

Command Type: Immediate Execution

Parameter: P1 decimal value of the ASCII character

P2 number of bytes being sent in a data list

P3 continuous output specifier

Parameter Limits: P1 minimum 0, maximum 256, default 10 (ASCII Linefeed)

P2 minimum 0, maximum 65,535, default 0

P3 minimum 0, maximum 1, default 0

The End of Data List character (EOD) is used to signify that a data list is complete. This data list can either be input to the CTU or output from the CTU. The ED command allows you to specify an eight bit ASCII character which terminates the data list. At power on and after initialization, the CTU uses the decimal 10 (ASCII linefeed) as its EOD.

While decimal 256 is not an eight bit character, the use of it as the EOD requires that all data lists be terminated by an interface EOI message. Any transmission of an interface EOI with a character terminates the data list.



Care should be exercised in choosing an EOD character. If your EOD character appears as data in the data list, the CTU accepts the character and terminates the input of the data list at that point. A list of available characters for use as the EOD can be found in Table 9.

**Table 9: EOD Characters**

ASCII Char.	EQUIVALENT FORMS			ASCII Char.	EQUIVALENT FORMS			ASCII Char.	EQUIVALENT FORMS			ASCII Char.	EQUIVALENT FORMS		
	Binary	Octal	Dec		Binary	Octal	Dec		Binary	Octal	Dec		Binary	Octal	Dec
NULL	00000000	000	0	space	00100000	040	32	@	01000000	100	64		01100000	140	96
SOH	00000001	001	1	!	00100001	041	33	A	01000001	101	65	a	01100001	141	97
STX	00000010	002	2	"	00100010	042	34	B	01000010	102	66	b	01100010	142	98
ETX	00000011	003	3	#	00100011	043	35	C	01000011	103	67	c	01100011	143	99
EOT	00000100	004	4	\$	00100100	044	36	D	01000100	104	68	d	01100100	144	100
ENQ	00000101	005	5	%	00100101	045	37	E	01000101	105	69	e	01100101	145	101
ACK	00000110	006	6	&	00100110	046	38	F	01000110	106	70	f	01100110	146	102
BELL	00000111	007	7	'	00100111	047	39	G	01000111	107	71	g	01100111	147	103
BS	00001000	010	8	(	00101000	050	40	H	01001000	110	72	h	01101000	150	104
HT	00001001	011	9	)	00101001	051	41	I	01001001	111	73	i	01101001	151	105
LF	00001010	012	10	*	00101010	052	42	J	01001010	112	74	j	01101010	152	106
V <sub>tab</sub>	00001011	013	11	+	00101011	053	43	K	01001011	113	75	k	01101011	153	107
FF	00001100	014	12	,	00101100	054	44	L	01001100	114	76	l	01101100	154	108
CR	00001101	015	13	--	00101101	055	45	M	01001101	115	77	m	01101101	155	109
SO	00001110	016	14	.	00101110	056	46	N	01001110	116	78	n	01101110	156	110
SI	00001111	017	15	/	00101111	057	47	O	01001111	117	79	o	01101111	157	111
DLE	00010000	020	16	0	00110000	060	48	P	01010000	120	80	p	01110000	160	112
DC <sub>1</sub>	00010001	021	17	1	00110001	061	49	Q	01010001	121	81	q	01110001	161	113
DC <sub>2</sub>	00010010	022	18	2	00110010	062	50	R	01010010	122	82	r	01110010	162	114
DC <sub>3</sub>	00010011	023	19	3	00110011	063	51	S	01010011	123	83	s	01110011	163	115
DC <sub>4</sub>	00010100	024	20	4	00110100	064	52	T	01010100	124	84	t	01110100	164	116
NAK	00010101	025	21	5	00110101	065	53	U	01010101	125	85	u	01110101	165	117
SYNC	00010110	026	22	6	00110110	066	54	V	01010110	126	86	v	01110110	166	118
ETB	00010111	027	23	7	00110111	067	55	W	01010111	127	87	w	01110111	167	119
CAN	00011000	030	24	8	00111000	070	56	X	01011000	130	88	x	01111000	170	120
EM	00011001	031	25	9	00111001	071	57	Y	01011001	131	89	y	01111001	171	121
SUB	00011010	032	26	:	00111010	072	58	Z	01011010	132	90	z	01111010	172	122
ESC	00011011	033	27	;	00111011	073	59		01011011	133	91	⌋	01111011	173	123
FS	00011100	034	28	!	00111100	074	60	\	01011100	134	92		01111100	174	124
GS	00011101	035	29	=	00111101	075	61	]	01011101	135	93		01111101	175	125
RS	00011110	036	30	~	00111110	076	62	^	01011110	136	94	~	01111110	176	126
US	00011111	037	31	?	00111111	077	63	_	01011111	137	95	DEL	01111111	177	127

The EOD character is not stored on tape. It is possible to store a data list using an EOD character and then read the data list using a different EOD character.

The byte count parameter provides an alternate method of terminating the input data list. The byte count value is compared to the number of bytes which have been received by the CTU. When the values are equal, the input of the data list is terminated and the CTU becomes ready for the next command. If the byte count parameter value is 0, the byte count feature is turned off.

The CTU terminates an input data list whenever one of the following three conditions is met:

1. The EOD character is received.
2. The byte count is reached.
3. An EOI message is received by the CTU.

When the CTU is sending a data list to the interface, the EOD character is added at the end of the data list. This can cause an error if the device which is receiving (the listener) the data list does not input the EOD character.

The Continuous Output Specifier allows the CTU to handle a request for data from a device without disabling the interface when there is no data ready to be sent. A value of 0 disables the continuous output specifier. A value of 1 enables the continuous output specifier.

If the Continuous Output Specifier is on, the CTU returns the EOD character (with the EOI message set) for each request of data by a listener. Data may still be transmitted along the interface, but the CTU has generated an unexpected byte requested error.

If the Continuous Output Specifier is off, the CTU does not return a byte. The interface is disabled for data transfer by the CTU not responding to the handshake.

Table 10 summarizes the Continuous Output Specifier action.

**Table 10: Continuous Output Specifier**

Continuous Output Specifier	Character Returned	Interface Status	Next Action by Controller
On	EOD Character	Data can be transmitted	Recover from error
Off	No Character	Data cannot be transmitted	Abort message to interface

(CTU-L) "ED 125, 256, 1" (EOC)

This example sets the ASCII character } as the EOD character for data lists being either input to the CTU or output from the CTU. The byte count for input data lists is set to 256 bytes. The Continuous Output Specifier is on.

## Find End of Valid Data

"FE"

Parameters: None

Command Type: Immediate Execution

The Find End of Valid Data (FE) command positions the tape at the end of valid data mark (EVD). You can now reserve space for data or write data on unused portions of tape without destroying previously recorded information.

The EVD position is not the physical end of the tape, but rather the end of recorded data. There is only one EVD position on a tape at any given time. After executing an FE command, the current file is not defined.

(CTU-L) "FE" (EOC)

This example causes the CTU to find the end of valid data mark on the tape.

## Find File

"FF P1 [, P2]"

Command Type: Immediate Execution

Parameters: P1 file number

P2 record number (optional)

Parameter Limits: P1 minimum 0, maximum 2047

P2 minimum 0, maximum 4095, default 1

The Find File (FF) command positions the tape at a specified location. This location can be specified by both the file number and the record number.

In both cases, the tape is positioned at the beginning of the file or the beginning of the record as specified. The file number must be specified, or an error (mandatory parameter is not specified) occurs. If you do not specify a record number, the tape is positioned at the BOR position of record 1.

If you specify record 0, the tape is positioned at the beginning of the file identifier record.

(CTU-L) 'FF 2,4' (EOC)

This example positions the tape at the beginning of record 4 in file 2.

## Identify File

'IF [P1]'

Command Type: Parameter Output

Parameter: P1 file number

Parameter Limits: minimum 1, maximum 2047, default current file number.

The Identify File (IF) command is a parameter output command which identifies a file by three parameters. The parameters returned are:

- the file number
- the number of records in the file
- the absolute number of bytes per record

If you do not specify a file number then the file which is currently available is identified. The parameters which are returned follow the same format as the other parameter output commands. The format is shown in Table 6 on page 31.

The IF command positions the tape at the beginning of the next file. If the file identified is the last file on tape, the tape is positioned at the EVD mark.

Executing an IF command without a parameter after executing a FE command returns the next available file number.

(CTU-L) 'IF 4' (EOC)

(CTU-T) parameter list (CR-LF)

If the values returned were 4, 300, 50 respectively, then you would have identified file #4, with 300 records each having 50 bytes.

## Identify Record

“IR [P1]”

Command type: Parameter Output

Parameter: P1 record number

Parameter Limits: P1 minimum 1, maximum 4095, default current record number (current file is assumed).

The Identify Record (IR) command is a parameter output command that identifies a record within a file by returning five parameters. The parameters have the same format as the other parameter output instructions. This format is shown in Table 6, page 31.

The five parameters returned are:

1. the record number
2. the file number
3. the absolute size of the record in bytes
4. the used size of the record in bytes
5. the free field contents

If you do not specify a record number, the record which is currently available is identified. The IR command positions the tape at the next BOR. If the record identified is the last record on the tape, the tape is positioned at the EVD mark.

(CTU-L) “IR4” (EOC)

(CTU-T) parameter list (CR-LF)

In this example, record 4 of the current file is being identified.

For this example, suppose the parameter list returns these values 4, 2, 256, 200, 0. This would mean that File 2, Record 4 has an absolute size of 256 bytes with 200 bytes of data currently recorded in it. The free field contents are 0.

---

### NOTE

The returned free field parameter is an encoded parameter. A value from 0 to 15 indicates that the free field pattern is not reserved. A value greater than 15 indicates a reserved free field pattern. It is necessary to subtract 16 from a value greater than 15 to determine the actual free field pattern.

---

If the returned free field parameter is 16 or greater (reserved bit is set to "1"), special data reduction techniques may be required to achieve meaningful interchange of data from the identified record.

## Input Mask

"IM [P1][, P2]"

Command Type: Immediate Execution

Parameter: P1 require service mask (decimal equivalent value)

P2 parallel poll response mask (decimal equivalent value)

Parameter Limits: P1 minimum 0, maximum 255, default 0

P2 minimum 0, maximum 255, default P1

The Input Mask (IM) command allows the CTU to send the require service message and to respond affirmatively to a parallel poll operation.

The require service mask can be set so that when a specific condition(s) occurs, the CTU sends the require service message to the controller.

**Table 11: Available Conditions for SRQ and Affirmative Parallel Poll Response**

Decimal Value	Condition
1.	Data buffer empty
2.	Data buffer full
4.	Ready for next command
8.	Initialized
32.	Error

(CTU-L) "IM 32, 36" (EOC)

This example allows the CTU to request service when a status value of 32 (the error indication) occurs. The CTU is set to respond to a parallel poll on condition 4 or condition 32 (ready for next command or error).

## Mark File

“MF [P1, P2 [,P3] [,P4] [,P5]”

Command Type: Immediate Execution

Parameters: P1 number of files to be marked

P2 number of records per file

P3 number of bytes per record (optional)

P4 number of bytes in the File I.D. record (optional)

P5 free field pattern (optional)

Parameter Limits: P1 minimum 1, maximum 2047

P2 minimum 0, maximum 4095

P3 minimum 1, maximum 256, default 256

P4 minimum 0, maximum 256, default 0

P5 minimum 0, maximum 15, default 0

The Mark File (MF) command reserves space on the tape cartridge where data is to be stored. Before executing the MF command, the tape must be positioned at a legal starting point. The legal starting points are:

1. BOF
2. RW
3. EVD

This can be accomplished by executing a RW command for an empty tape or a FE command for a tape which contains recorded information. The tape must not be write protected.

If you wish to remark an existing file, remember that the MF command places an EVD mark after marking the last file. The EVD mark makes any data following the EVD mark inaccessible.

For example, if you had this structure on tape:

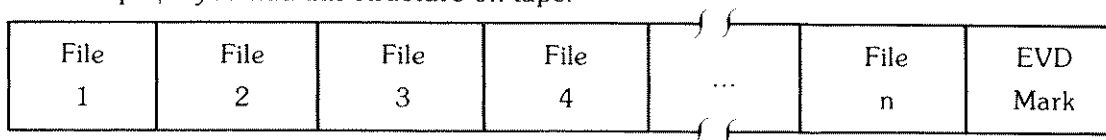

and remarked File 2, the new structure would be

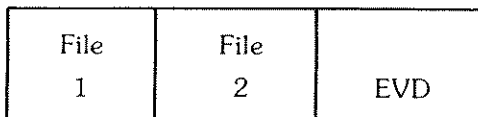

with the contents of Files 3 through n being lost

Since there is a limited area of tape available for recording information, there are finite limits to tape capacity. The tape capacity is function of record length and the number of files marked. Figure 5-1 shows the relationship of these parameters.

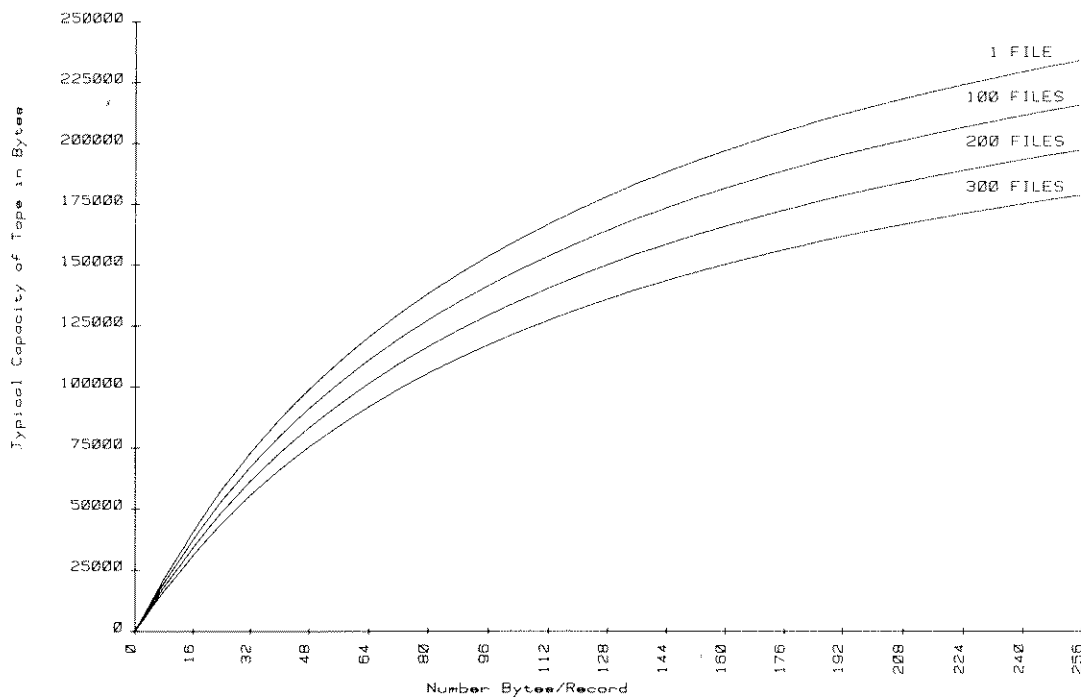

**Figure 5-1: File Size Interaction**

The number of files to be marked determines how many new files you have available for storage.

The number of records per file determines how many records each new file has available for storing data.

The number of bytes per record determines the amount of storage space available per record. Not using this parameter sets the record length to its maximum (256 bytes). The number of records per file multiplied by the number of bytes per record determines the number of bytes per file. The CTU makes the number of bytes per record even by rounding up odd numbers. For example, specifying 11 bytes per record reserves 12 bytes in a record.



The number of bytes per identifier record (record 0) reserves space for the file identifier record. The file identifier can be used for recording remarks about a file or naming the file for use in directory access. The values for this parameter are from zero to 256 bytes. If you do not specify a value, or if you specify 0, space is not reserved for the file identifier record body.

The free field pattern is a four-bit binary code (0 to 15). If you do not specify a value, 0 is recorded in the free field. You may find the free field pattern useful for recording a four-bit code (such as the date or test run) to further help identify your data.

(CTU-L) ‘MF 15, 25, 100, 256, 8’ (EOC)

This example marks 15 files having twenty-five, 100-byte records. The file identifier record (record 0) has 256 bytes reserved for remarks and the free field pattern is 8 (binary 1000).

You may wish to mark a file mark by executing MF 1, 0. This allows you to incrementally add records by using the MR command.

## Mark Record

‘MR [P1][, P2]’

Command Type: Immediate Execution

Parameters: P1 number of records to be marked (optional)

P2 contents of the free field (optional)

Parameter Limits: P1 minimum 1, maximum 4095, default 1

P2 minimum 0, maximum 15, default 0

The Mark Record (MR) command is similar to the MF command except that you are reserving record space on an existing file. The tape must be positioned at either a BOF or the EVD mark prior to executing the MR command. The record(s) to be marked is the current file. If the tape is positioned at the EVD, the data is added to the end of the last file.

When the tape is positioned at a BOF, the record length is set at 256 bytes per record. When positioned at the EVD mark, the record length is the same as the rest of the records in the file.

The number of records parameter specifies the number of records which are going to be recorded. The free field parameter allows you to mark the free field as in the MF command.

The MR command requires the tape to be positioned at either the EVD mark or at a BOF position.

(CTU-L) "MR 200" (EOC)

This example shows how 200 records are added to a file.

The MR command records an EVD mark at the end of the last record added. As with the MF command, any data which exists after the EVD mark is inaccessible.

## Output Error

"OE"

Command Type: Parameter Output

The Output Error (OE) command performs two actions. First, it returns five parameters from the CTU. These parameters have the same format as shown in Table 6 page 31. The parameters are a coded representation of the error condition(s) and test results present in the CTU.

Secondly, the OE command clears the error(s) from the CTU, allowing the CTU to respond normally to all subsequent commands. (Bit 5 in the status byte is set to 0.)

The OE values (parameters 1 and 2) are cumulative. The test results (parameters 3, 4 and 5) are the results of the last self test.

**Table 12: Output Error Parameters**

### Error Code #1 (First Parameter Returned)

0. No error or test passed
1. Cartridge out or file not found.
2. Cartridge is write protected or record not found.
4. Drive not present or internal temperature is too high.
8. Verify failed or unknown/illegal tape position.
16. File/record overflow or attempt to read an empty file/record.
32. Body checksum error or attempt to store, write or mark a non-updateable record.
64. Header checksum error or end of tape.
128. Servo or hardware failure.

**Error Code #2 (Second Parameter Returned)**

- 0. No error.
- 1. Unexpected byte received.
- 2. Unexpected byte requested.
- 4. Illegal character in parameter list.
- 8. Mandatory parameter is not specified.
- 16. Too many parameters specified.
- 32. Parameter is out of limits.
- 64. Syntax error.

**Electronics Test Result (Third Parameter Returned)**

0	Electronics Test Passed
Non-0 value	Electronics Test Failed

**Drive 0 Test Result (Fourth Parameter Returned)**

Test result values are the same as Error Code #1

**Drive 1 Test Result (Fifth Parameter Returned)**

Test result values are the same as Error Code #1

(CTU-L) "OE" (EOC)  
 (CTU-T) parameter list (CR-LF)

**Output Status**

"OS"

Command Type: Parameter Output

The Output Status (OS) command allows the controller to check the state of seven internal conditions of the CTU. The CTU returns the status byte value as the parameter. The parameter format is the same as the other parameter output commands. The format is shown in Table 6, page 31.

This status byte is also returned as the response to a serial poll.

The status byte value is cumulative. For example, if drive #1 is selected and an error occurs, the value is 160.

The decimal equivalent values for the parameter are:

	<b>Status byte</b>
1. data buffer empty	bit 0
2. data buffer full	bit 1
4. ready for next instruction	bit 2
8. initialized (set only after power on or device clear) <sup>1</sup> .	bit 3
16. not used (always 0)	bit 4
32. error	bit 5
64. require service (SRQ)	bit 6
128. drive #1 selected	bit 7

<sup>1</sup> This condition can be used to detect a momentary interruption of power to the CTU.

(CTU-L) "OS" (EOC)  
 (CTU-T) parameter (CR-LF)

When the CTU receives the OS command, the CTU can resume operation. This allows you to clear the CTU of an error so the CTU can operate without sending a device clear which resets the CTU. The error code is not returned until an OE command is executed.

## Read File

"RF [P1]"

Command Type: Data Output  
 Parameter: P1 file number (optional)  
 Parameter Limits: minimum 1, maximum 2047, default current file number

The Read File (RF) command allows you to read information which has been stored or written in a file. You may optionally specify the file number from which the information is read. If you do not specify a file number, the data is read from the file which is currently available. At rewind and end of valid data, the current file is not defined.

(CTU-L) "RF 4" (EOC)  
 (CTU-T) data list (EOD)

In this example, the contents of file 4 are ready to be output by the CTU. The tape is positioned at the next BOF after executing a RF command.

## Read File Identifier

“RI [P1]”

Command Type: Data Output

Parameter: P1 file number (optional)

Parameter Limits: minimum 1, maximum 2047, default current file I.D.

The Read File Identifier (RI) command reads the contents of the file identifier record (record 0).

(CTU-L) “RI4” (EOC)

(CTU-T) data list (EOD)

In this example the contents of the file identifier record for file #4 is being read. The tape is positioned at BOR 1 after executing this command.

## Read Record

“RR [P1]”

Command Type: Data Output

Parameter: P1 record number (optional)

Parameter Limits: minimum 0, maximum 4095, default current record number.

The Read Record (RR) command allows you to read information from an existing record. The tape must be positioned in the file which contains the desired record prior to executing the RR instruction. If the record number is not specified, the information is read from the record which is currently available.

(CTU-L) “RR 3” (EOC)

(CTU-T) data list (EOD)

This example reads the information which is stored in record 3 of the current file. The CTU is ready to output a data list.

After a RR command, the tape is positioned at the next BOR.

If you continue executing RR commands through a file until you encounter record 0 of the next file, a file overflow error (error code 1, value of 16) results.

If the BOR position is at the EVD mark or the beginning of the next file and the next command does not specify an optional parameter, a file overflow error results.

## Rewind

“RW”

Command Type: Immediate Execution

The Rewind (RW) command rewinds the tape cartridge. After an RW command, the current file number is not defined.

(CTU-L) “RW” (EOC)

This example causes the CTU to rewind the tape cartridge.

## Select Drive

“SD [P1]”

Command Type: Immediate Execution

Parameter: P1 specified drive number (optional)

Parameter Limits: minimum 0, maximum 1, default 0

The Select Drive (SD) command allows the selection of either drive on any CTU that is equipped with Option 001, multiple tape drives. Once a drive is selected, all subsequent commands apply to that drive. The currently selected drive is indicated by the illuminated front panel lamp.

The SD instruction remains in effect until another SD instruction is executed or the CTU is cleared by either “Device Clear” message or a power off/power on cycle. When the SD command is executed, the old transport retains its current tape position while the newly selected transport verifies the position of the tape.

(CTU-L) “SD 1” (EOC)

This example selects tape drive #1.

Attempting to select drive 1 on a CTU which has only drive 0 results in a transport not present error (error code 1, value of 4).

## Store File

“SF [P1]”

Command Type: Data Input

Parameter: P1 file number (optional)

Parameter Limits: minimum 1, maximum 2047, default current file number

The Store File (SF) command allows you to store data into an existing reserved file. You may optionally specify the file number which is going to have the data stored in it. If you do not specify a parameter for the file number, the data is stored in the file which is currently available.

After execution of the SF command, the CTU is in the data input mode. The CTU is ready to input and store a data list. The tape is positioned at the next BOF after receiving the data list.

(CTU-L) “SF 3” (EOC)

(CTU-L) data list (EOD)

This example stores a data list in file 3.

## Store File Identifier

“SI [P1]”

Command Type: Data Input

Parameter: P1 file number (optional)

Parameter Limits: minimum 0, maximum 2047, default 0 (current file)

The Store File Identifier (SI) command stores information into a specified file at record #0. The file identifier can be used for recording remarks about a file or naming the file.

Before storing a data list into the file identifier record, space in the file identifier record must be created. This is done by using the MF command, and P4 in the parameter list. Refer to page 41 for further information.

(CTU-L) “SI 4” (EOC)

(CTU-L) data list (EOD)

After the execution of this SI command the CTU is ready to input a data list and store it into record 0 of file number 4. The tape is positioned at BOF 4 after receiving the data list.

## Store Record

“SR [P1]”

Command Type: Data Input

Parameter: P1 record number (optional)

Parameter Limits: minimum 0, maximum 4095, default 0-(current record) *number*

The Store Record (SR) command allows you to store information into an existing record. The tape must be positioned at the file which the information is to be stored in prior to executing the SR instruction. If you do not specify a record number, the information is stored in the record which is currently available.

(CTU-L) “SR 3” (EOC)

(CTU-L) data list (EOD)

After the execution of the SR command, the CTU is ready to input and store a data list into the specified record.

After the data list has been stored, the tape is positioned at the BOR for the next record. If this position is at the EVD mark or the beginning of the next file and the next command applies to the current record, a file overflow error results.

## Self Test

“ST”

Command Type: Immediate Execution

The Self Test command is used to verify that the CTU is operational. The self test tests the electronics and the read/write circuitry for each drive. The self test is implemented and the results are obtained by using the two instructions – Self Test (ST) and Output Error (OE).

(CTU-L) “ST” (EOC)

The self test procedure records data on the tapes which are installed in the drives, to test the drive read/write circuitry. This test records data over any existing data on the tape. Therefore you should verify that the tape cartridge which is being used in the self test does not contain any valuable data.



A common error which can occur during the self test is that the cartridge is write protected, or is not being installed in the CTU while the CTU is performing the self test. If either of these two conditions exist, correct them before executing the ST command.

Another source of self test failure is a defective tape. Re-running the test with a new tape may be all that is required to verify the operation of the CTU.

If the indicator lamp is flashing after the self test, contact your nearest HP Sales and Service Office.

## Time Interval

'TI [P1]'

Command Type: Immediate Execution

Parameter: P1 time interval in seconds (optional)

Parameter Limits: minimum 0, maximum 65,535, default 0 (no delay)

The Time Interval (TI) command is used to allow the CTU to set a time interval between inputting or outputting data. This command is very useful for pacing the interface when the CTU is being used as a data logger.

The parameter is any integer value between zero and 65,535. This results in a time interval delay which ranges from no delay to 18 hours 12 minutes 15 seconds.

The operating cycle of this command causes the CTU to input (or output) data until a linefeed is received (or sent). When the linefeed is received (or sent), the CTU stops inputting (or outputting) data and initiates its time interval delay. After waiting the specified amount of time, the CTU repeats its operating cycle.

(CTU-L) "TI 15" (EOC)

This example allows the CTU to input or output data at 15 second intervals.

## Write File

'WF'

Command Type: Data Input

The Write File (WF) command writes a new file and stores data on the tape cartridge with the same command. While this instruction is similar to executing an MF command followed by a SF command, there are certain trade-offs.

The MF command allows you to create more than one file at a time; the WF command allows you to create only one file per WF command.

The WF command actually stores data, while the MF command does not.

Both the WF and MF commands can write over previously recorded data.

The time it takes to execute a WF command is significantly less than the time it takes to execute a SF command.

Information which is recorded in files that were created by the MF and WF commands are updateable.

The MF command allows you to select how many records per file are to be recorded; the WF command uses as many records as are needed to contain the data.

The MF command allows you to select how many bytes are to be recorded in each record. The WF command uses 256-byte records.

The WF command places an EVD mark on the tape at the end of the file. Any data which is on the tape that occupies space beyond the area where the WF command is executed cannot be accessed after the WF command is executed. Because of this, the WF command should only be executed after verifying that the WF command is not going to make any data inaccessible. This keeps the WF command from destroying previously recorded data.

The WF command writes a file identifier record with a record length of 0. After RW or FE its file number is the last file number prior to the WF file +1. For example, if the file number prior to the WF file is 15, then the file number of the WF is 16 (15+1). At a BOF, its file number is the current file number.

(CTU-L) "WF" (EOC)

(CTR-L) data list (EOD)

After the execution of the WF command, the CTU is ready to input and store a data list.

It is possible to create a file mark by sending a WF command followed by the EOD character as the first character in the data list. This enables you to incrementally write a file using the WR command.

## Write Record

“WR”

Command Type: Data Input

The Write Record (WR) command is the record level counterpart of the WF command. The WR command stores and appends information onto an existing file.

As with the WF instruction, executing a WR command is faster than executing a MF command followed by a SR command. The record length is the same as the other records in the file.

The WR command may only be executed if the tape is positioned at the EVD or a BOF position. Any other position results in an illegal position error. When the tape is positioned at the EVD, the record length is equal to the preceding record's absolute length. When the tape is positioned at a BOF, the record length is fixed at 256 bytes per record.

(CTU-L) “WR” (EOC)  
(CTU-L) data list (EOD)

After executing the WR command the CTU is ready to input and store a data list.

If the data list is greater than the record length, a record overflow error occurs.

As with the WF command, the WR command places an EVD mark on the tape after writing the record. Any data which exists on the tape after the EVD mark is no longer accessible by the CTU.

# Chapter 6

## Operation

While it is not possible to give example programs which show the Cartridge Tape Unit (CTU) being used with all controllers, general purpose flowcharts are included in this section to enable you to use the CTU.

If you have an HP computer or computing controller, Programming Techniques manuals have been written for your device. Refer to Table 13 for the appropriate part number.

**Table 13: Programming Techniques Manuals**

Controller	Part Number
9815A	98130-90011
9825A	09825-90075
9831A	09831-90075
System 45	09845-90675

### Theory of Operation

The CTU is a device which responds to commands and inputs and outputs data lists.

If the command is not terminated with an End of Command character (EOC), the CTU does not execute the command.

The acceptable terminators for the commands are:

1. ASCII Semi-colon (decimal 59)

or

2. ASCII linefeed (decimal 10)

or

3. EOI sent with the last byte.

Input data lists must be terminated with the End of Data List character (EOD), or an error can be generated in the CTU. (Error code 2, value of 2, unexepected byte requested.)

---

**NOTE**

If an input data list is not terminated with an EOD character, all subsequent commands to the CTU are stored as part of the data list.

---

The acceptable terminators for the data lists are:

1. ASCII linefeed (decimal 10) unless changed by the ED command.
2. EOI sent with the last byte.

An EOD which is sent to the CTU is not recorded on the tape.

An EOD is added to the end of a output data list by the CTU. This EOD must be read by the device receiving the data list, or an error may result. (Error code 2, value of 1, unexpected byte received.)

When an error is generated the CTU responds to only two commands, OS and OE. All other commands are ignored. For this reason, it is necessary to frequently check the CTU for error conditions. The CTU responds to a serial poll at any time, making this a convenient method of checking for error conditions.

An OS command returns the values shown in Appendix F.

If an error has occurred, the CTU must receive an OE command so you may determine what kind of an error occurred. However, after receiving the OS command the CTU is ready to resume operation. If you resume operation, the error values remain in the CTU's error code registers until either an OE command is received, a device clear is received, or until power is removed from the CTU.

The OE command returns the error codes shown in Appendix F. The OE command resets the CTU's error code values to 0. At this point, you can determine whether you want to re-run the program or continue depending upon the seriousness of the error.

## Initialized Condition

The following initialized conditions apply to the CTU whenever power is applied or the CTU receives a device clear through the interface.

Autoverify Mode	Disabled
End of Command Character	ASCII LF or ASCII Semicolon
End of Data List terminator	ASCII LF
Drive Selected	Tape drive 0
Time Interval	Off

If you have changed any of these conditions during the execution of a program, they reset to the states shown above.

## Polling

The CTU responds to both serial and parallel polling.

### Serial Poll

The CTU responds to a serial poll with the values shown in Appendix F.

### Parallel Poll

If the CTU is set to an address between 0 and 7, the CTU is automatically configured to respond affirmatively to a parallel poll as shown in Table 14. If the CTU's address is 8 or above, the CTU must be configured by an IEEE parallel poll configure message.

**Table 14: Parallel Poll Response**

CTU Address	Parallel Poll Response Line
0	DIO 8
1	DIO 7
2	DIO 6
3	DIO 5
4	DIO 4
5	DIO 3
6	DIO 2
7	DIO 1
8 or above	Not responding unless configured

The CTU can respond affirmatively to a parallel poll if the IM command parameter P2 is a non zero value and the enabled condition is true.

## Normal Operation

To store data, you have two choices of operation.

1. Mark files on the tape and then store data into the premarked files.
2. Store data into non-premarked files.

## Marking Files

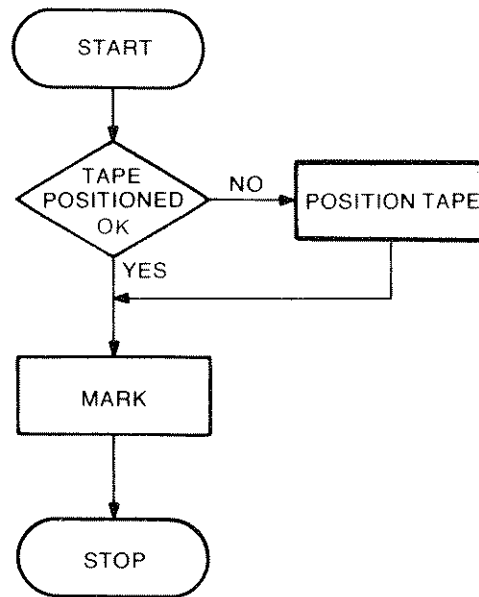

The tape should be positioned by:

1. Executing a RW command to mark at the beginning of a tape.
2. Executing a FE command to preserve data recorded on a tape.

Marking files or records results in an EVD mark being placed on the tape after the command is executed. This means if you remark a file located between files (tape is positioned with an FF command), all remaining files are inaccessible.

For example, if you had this structure on tape.

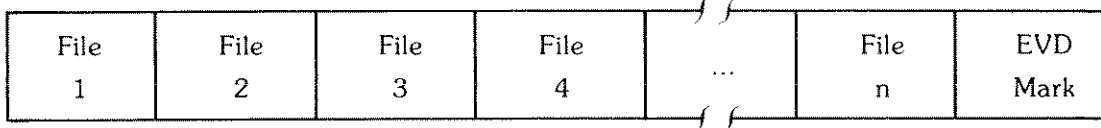

and remarked File 2, the new structure would be

File 1	File 2	EVD
-----------	-----------	-----

with the contents of Files 3 through n being lost

If an error occurs (front panel lamp is flashing), data input and output stops. The CTU responds only to an OE or OS command.

Errors can be detected by interrupt service routines, or by periodic polling of the CTU.

If your controller does not handle interrupts, then you may have to perform polling your bus frequently through a program, to determine when an error occurs.

## Handling Errors

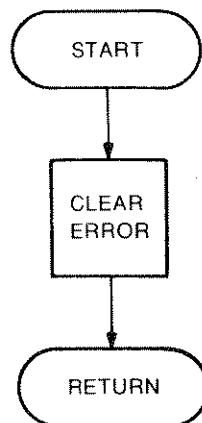

Errors are cleared by any of these three commands:

1. OS
2. OE
3. Device Clear

The OS command allows the CTU to return to normal operation. The error codes are not returned from the CTU. The error code values remain in the CTU.

Executing an OS or OE while the CTU is expecting to input or output a data list generates either an error condition or erroneous data being recorded on the tape.



The OE command allows the CTU to return to normal operation. The error codes are returned from the CTU. The OE command is the only command which returns the error code values.

A device clear allows the CTU to return to normal operation. All device selectable characteristics are set to power-on conditions. (Refer to page 57). It may be necessary to reconfigure the CTU after a device clear.

## Storing Data

### Premarked Files

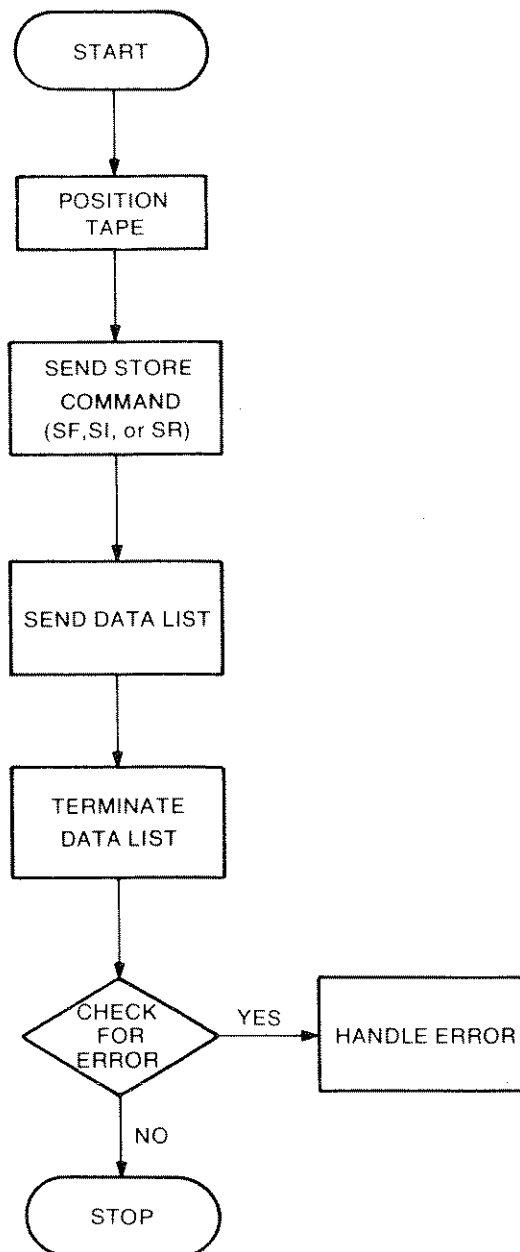

Commands which specify a file number execute an implied FF command to position the tape. These commands include IF, RF, RI, SF and SI.

The store command may be either SF or SR or SI as needed. The data list must be terminated with the EOD character, exceeding a specified byte count, or by the EOI message.

The files and records must have been previously reserved by an MF or MR instruction.

## Non Premarked Files

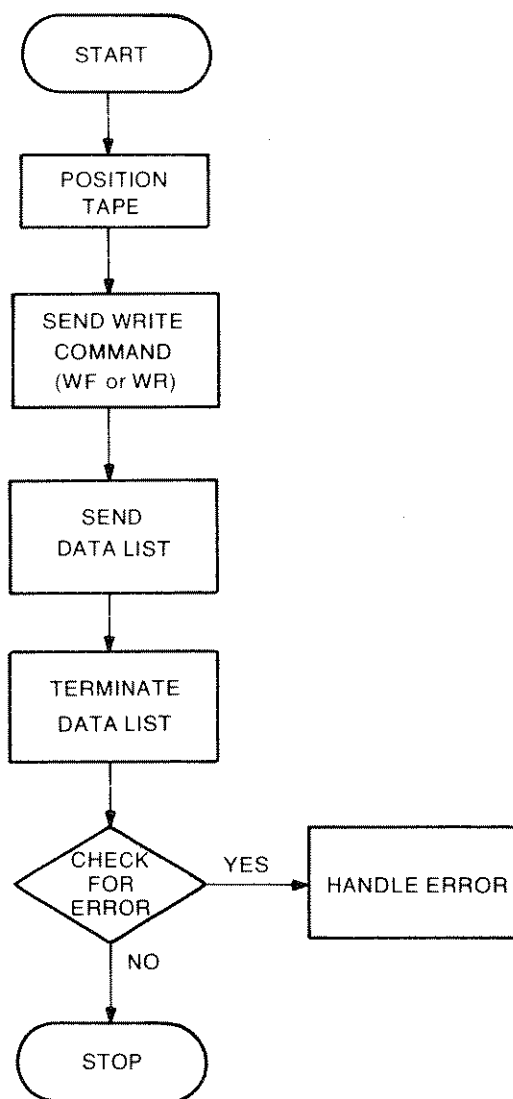

The legal tape positions for the WF command are after a RW command, after an FE command and or at a BOF. The legal tape positions for the WR command are after an FE command or at a BOF.

## Reading Data

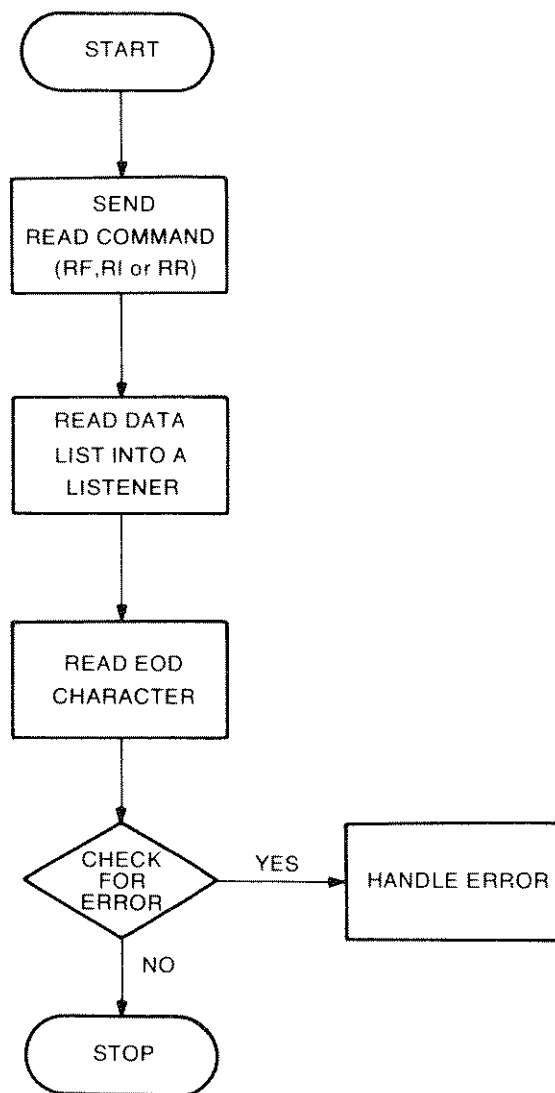

### Error Interrupt Routine

An error in the CTU can cause a loss of data. Since this is undesirable, you may want to configure your system to handle the error in this fashion.

1. Set the controller to handle an error (OE command) on an interface interrupt. (SRQ is very convenient for this.)
2. Enable the interface to interrupt the controller on SRQ from the CTU.
3. Enable the CTU to interrupt on error by using the IM command.

## Input / Output of Data

The CTU can be configured to interrupt when its buffer is empty or full, allowing data to be sent in and out in blocks at the higher burst transfer rate. The buffer length is equal to the absolute record length for input and the used record size for output.

1. Set controller to input (output) data on an interface interrupt.
2. Enable interface to interrupt the controller on SRQ from the CTU.
3. Enable the CTU to interrupt on either
  1. Buffer empty
  - or 2. Buffer fullby using the IM command.

## Buffer Status Identifier

The Buffer Status Identifier can be used to determine the number of bytes available in the CTU's buffer. This command can be executed at any time, similar to a serial poll.

To get the buffer status identifier, the following procedure is used.

1. Address the CTU to talk.
2. Send the secondary command 1 in octal.

The CTU is now ready to return its available buffer length. This buffer length is an eight-bit byte. The value of this byte is between 0 and 255.

The CTU returns the logical length of the buffer when this byte is read by the controller / device. The maximum value of the logical length of the buffer is equal to the number of bytes per record for a given file.

If the CTU is in the data output mode, the buffer status identifier byte value is equal to the used size of the buffer.

If the CTU is in the data input mode, the buffer status identifier byte value is equal to the available size of the buffer.

Table 15 gives examples of the buffer status identifier.

**Table 15: Buffer Status Identifier**

Data Input 256 bytes per record (logical length)

Number Of Bytes In Buffer	Value Of Byte Returned	Status Byte
0	0*	1 (buffer empty)
56	200	0 (neither buffer empty nor buffer full)
255	1	0 (neither buffer empty nor buffer full)
256	0	2 (buffer full)

Data Output 256 bytes per record (logical length)

Number Of Bytes In Buffer	Value Of Byte Returned	Status Byte
0	0	1 (buffer empty)
56	56	0 (neither buffer empty nor buffer full)
255	255	0 (neither buffer empty nor buffer full)
256	0*	2 (buffer full)

## Self-Identify Mode

The CTU is equipped with a self-identify mode for use in system with controllers that can send secondary commands.

The self-identify mode has two features:

1. The CTU is identified by its primary address.
2. The CTU is identified by a special 2 byte code.

### Primary Address

The primary address is the CTU's address. The address must be set to 0 through 7 to make use of the self-identify mode. First, turn off power to the CTU. Then to enable the self-identify mode, switch on the self-identify switch located on the rear panel as shown in Figure 6-1.

\*0 is returned here because the number 256 can not be represented in eight bits. The status byte condition indicates whether the buffer is empty or full.

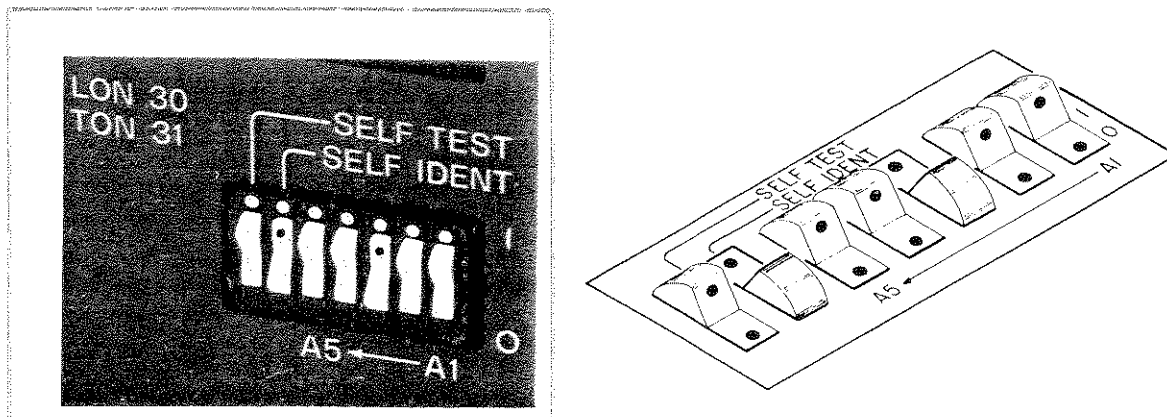

**Figure 6-1: Self-Identify Switch**

Next, enable power to the CTU. The CTU is now in the self-identify mode. In the self identify mode, whenever a power on or a device clear is received by the CTU, the CTU is automatically configured to respond affirmatively to a parallel poll. This response is the same as shown in Table 14. This response remains in effect as long as the initialized bit (bit 3) in the status byte is 1.

If the CTU's address is set to 8 or above, the CTU must be configured by a poll configure message to enable parallel poll response. This response to parallel poll is in addition to any parallel poll response mask which is set by the controller.

The self-identify mode remains in operation until the self-identify switch is set off and a device clear or power off occurs.

## Device Identity Code

The CTU can identify itself by a code which is unique to the HP 9875A. The code is a two-digit value. Each digit is composed of an eight-bit byte. The CTU's device identity code is a value of 1 for the first byte and 2 for the second byte.

To read the device identity code, the following procedure is executed.

1. Address device 31 as a talker (bus untalk message).
2. Send the secondary command. This command is the octal value of 140 to 175, dependent upon the primary address of the CTU. The command is 01 1xx xxx with xx xxx equal to the primary address of the CTU.
3. The CTU returns the two byte identity code.
4. The controller must read the two bytes.
5. Address device 30 to talk (this unaddresses the CTU).

## Device Specified Jump

The device specified jump (DSJ) is an action which returns a status byte from CTU. To execute a DSJ, the following procedure is used:

1. Address the CTU to talk at its primary address.
2. Send secondary command 16 in decimal.
3. The CTU returns the DSJ byte, as shown.

The DSJ clears the initialized bit (bit 3) in the status byte. This prohibits the CTU from its self-identify response to a parallel poll until the CTU has power reinitialized, or a device clear is received.

bit 0	bit 1	bit 2 thru bit 7
Ok if 0 Error if 1	initialized	not used

DSJ byte values

- 0 CTU is operational
- 1 Error condition in the CTU
- 2 CTU has been initialized

## Listen Only/Talk Only Mode

The CTU is equipped with a Listen Only/Talk Only mode (LO/TO). This mode allows the CTU to either input or output data along the bus without the need for a controller. This can be very useful for data logging operations.

### Listen Only

In the listen only mode, the CTU inputs a data list from a device which is outputting the data list (the talker).

To enable listen only mode, power should be turned off to the CTU.

After connecting the interface cable, set the address code switches to 30 as shown in Figure 6-2.

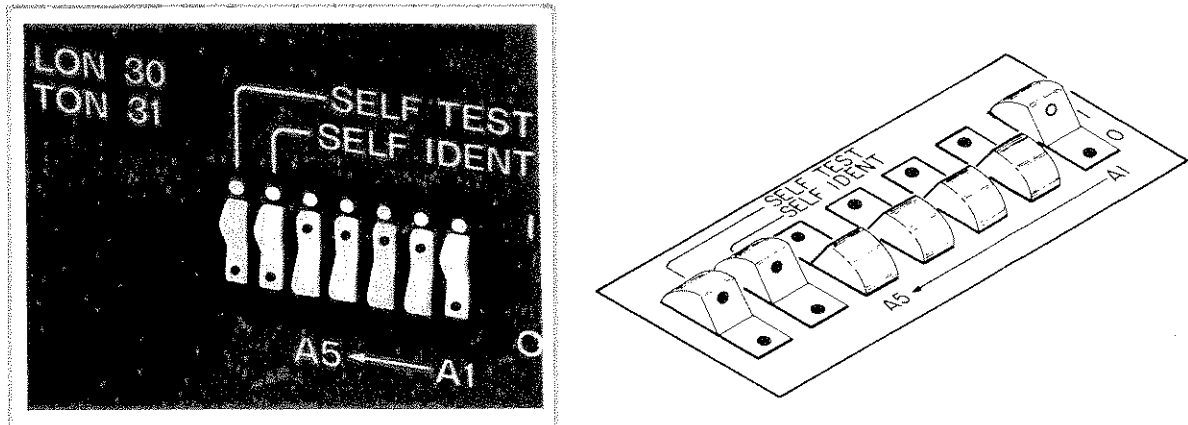

**Figure 6-2: Listen Only Address Switch Setting**

Next enable power to the CTU.

When a write enabled tape is inserted into drive 0 of the CTU the following sequence is executed:

1. The CTU executes a RW.
2. The CTU executes a WF command. The file number is 1. The CTU writes as many non-updateable records as needed to hold the data list.

The data list is recorded when:

1. 256 bytes of data are present in the CTU's buffer (buffer full).
- or
2. the contents of the CTU's buffer receives a linefeed (LF) character. This linefeed is recorded.

---

#### NOTE

The EOD character is not used in the listen only mode.

---

The LO data is not updateable. You can not store any different data into files written in the LO mode. This is done to achieve maximum data density on the tape. The used record length may be variable.

The CTU inputs data until the tape is full or power is switched off to the CTU. The CTU remains in the listen only mode until the address is changed from 30 and the power is turned off to the CTU.

---

#### NOTE

Make sure that the tape is stopped before power is switched off, or the last record of data may not be recorded.

---



## Talk Only

In the talk only mode, the CTU outputs a data list to a device which is receiving the data list (a listener).

To enable the talk only mode, power should be turned off to the CTU.

After connecting the interface cable, set the address code switches to 31 as shown in Figure 6-3.

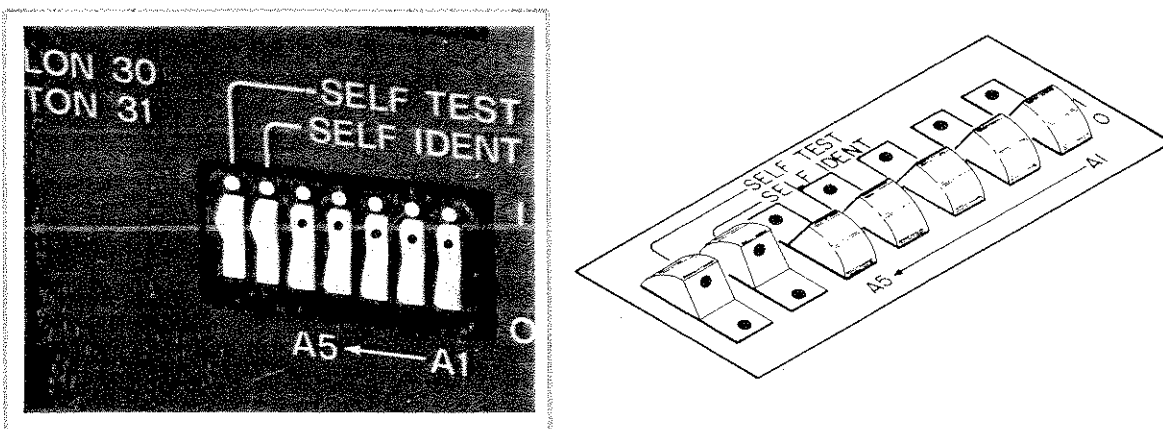

Figure 6-3: Talk Only Address Switch Setting

Next, enable power to the CTU. When a tape is inserted into drive 0, the CTU executes a RF 1.

The CTU outputs the data list until the file is completely read, or the address is changed from 31 and the power is turned off to the CTU.

## Programmable LO/TO

There is an additional feature of the CTU when it is in either LO or TO modes and in the self identify mode.

When both of these conditions are met, the CTU performs the following sequence before entering its LO/TO procedure.

1. After power on, the CTU reads record 1 of file #1.
2. If the CTU encounters one complete, legal command (mnemonic, parameter field and EOC terminator) the CTU executes that one command.
3. The CTU then waits until another cartridge has been inserted into the selected drive (the drive above the illuminated front panel lamp) before executing the LO/TO sequence.

This results in four useful commands being available for LO/TO operations. The commands are:

1. Auto Verify – to check the recorded contents of the tape (LO mode only).
2. End of Data List – to change the EOD character, or enable the byte count.
3. Select Drive – to use drive #1 in LO/TO operations.
4. Time Interval – to pace the interface in LO/TO operations.

If the CTU encounters an illegal command in record 1 of file #1, an error condition is generated. The CTU must be cleared of the error by an OS, OE or device clear before the CTU can resume normal operations.

## Tape Life

While typical tape life is expected to be between 50 and 100 hours (real operating time), the actual tape life will vary depending upon your work environment and the operation of your programs.

If during operation of programs, the Auto Verify mode begins detecting errors, the usable life of your tape is nearly up. It is recommended to keep a copy of all important tapes in case of tape failure.

# Appendix A

## Glossary

- BOF** The position reached when the tape is positioned at the Beginning of File (BOF).
- BOR** The position reached when the tape is positioned at the Beginning of Record (BOR).
- Cartridge** A magnetic tape medium. Specifically a tape cartridge with HP P/N 9162-0061.
- Checksum** A 16 bit word which is used for error detection. The value equals the arithmetic sum of the words before it. There are two checksums: Header Checksum and Body Checksum.
- Data Type** A code in bits 11, 12 of the File Word that indicates the type of data which is recorded.

Bit 12	Bit 11	
0	0	Empty (no data)
0	1	Not Empty
1	0	Not Empty
1	1	Not Empty

- Default** Value used when an optional parameter is not specified.
- End of Valid Data Mark** A mark on the tape consisting of the last record on the tape followed by an End of Track gap that signifies the end of data on the tape. This is the logical end of tape.
- File** A logical grouping of physical records which extends from its File Mark to the following File Mark or to the End of Valid Data Mark.
- File Identifier Record** The header of a file. It contains the file number, file size and checksum. (Usually Record #0).

File Mark	A mark on the tape consisting of the File Identifier Record and the Interfile Gap.
File Word	A 16 bit code that is found in the Record header. Bit 15 is the File Identifier Bit; bit 14 is 1; bit 13 is reserved; bits 11 and 12 are the Data Type Bits; bits 0 through 10 are the File Number.
Free Field	A four bit code which identifies a file that was recorded from a device with special characteristics.
Gap	A DC erased section of tape between physical records. SIF uses three types of gaps: the interfile gap, the interrecord gap and the end of track.
Header	The first several words of a physical record which identify that record. The two types of headers are: the File Identifier Record and the Record Header.
Interfile Gap	A gap from 63.5mm to 127mm in length (2.5 to 5 inches) that is between the File Identifier Record and the first record header.
Interrecord Gap	A gap of 25.4mm to 38.1mm (1 to 1.5 inches) that is between the records in a file.
Length Word	A 16 bit word in the Record Header. Bits 0 through 7 contain the number of bytes used; bits 8 through 15 contain the number of bytes available.
Marking	The process of dividing the tape into files, or of writing physical records on tape which are defined as empty before ever writing data in the records.
Non-updateable Record	A record on the cartridge whose contents cannot be changed.
Parameter	A parameter is a numeric value which modifies or delimits an instruction. Parameter can either be required or optional.
Physical Record	A block of contiguously recorded bits which extends from one gap to another. This includes the synchronization bits, header, record body, checksum, postamble and possible slack bits.
Postamble	An extra word which is written after the checksum to ensure that the checksum is readable.

Record Body	The portion of the physical record that contains the information to be exchanged. The record body consists of up to 128 sixteen bit words.
Record Word	A sixteen bit word consisting of bit 0 through 11 as the physical record number; bits 12 through 15 are the Free Field.
Slack	Extra words that are written at the end of a physical record to ensure that 128 words can be written in a record.
Synchronization Bits	A sequence of bits written at the beginning of each physical record to allow synchronization.
Track	A longitudinal area along the tape where a series of magnetic signals may be recorded.
Updateable Record	A record on tape whose contents can be changed by a SF, SR, WF, or WR command.
Word	A sequence of 16 adjacent bits.

## Appendix B

# Bus Message Implementation

The flowcharts presented here portray a typical way to implement the bus micro-operations for each message the CTU implements.

No single set of flow diagrams can represent exactly how the messages are to be transmitted since many options exist in terms of controller capabilities.

These micro-operations are referenced to the IEEE specification 488-1975.

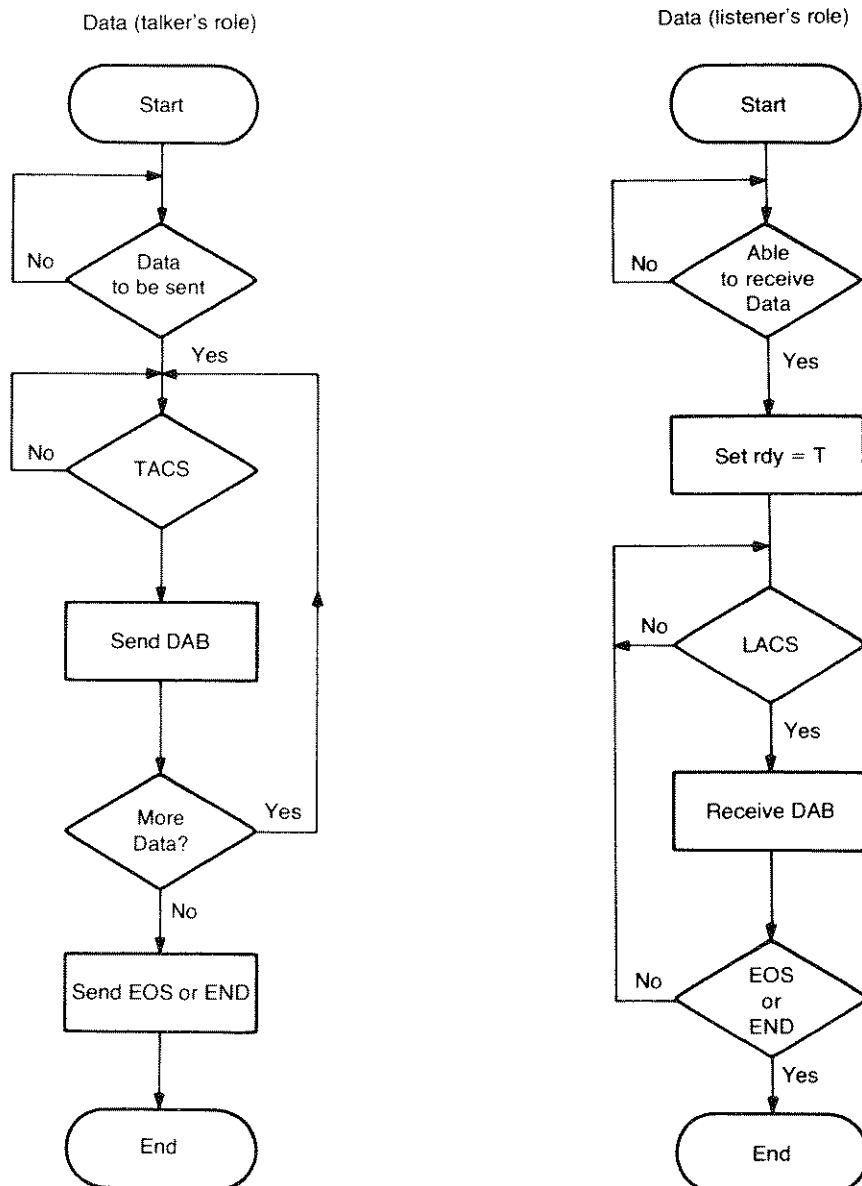

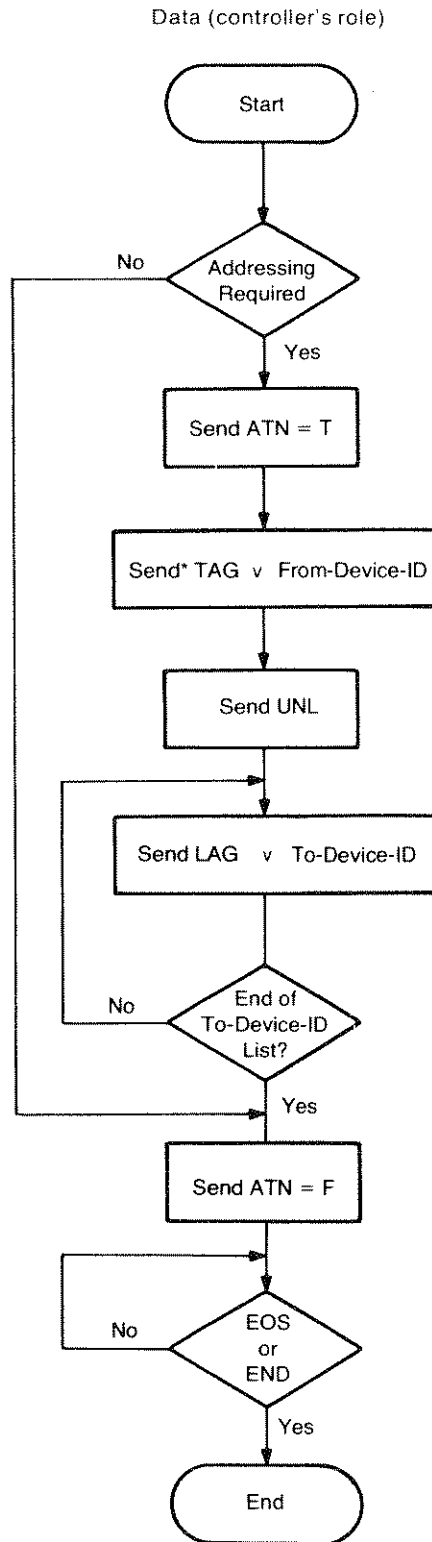

\*Send implies an entire handshake sequence for multi-line messages

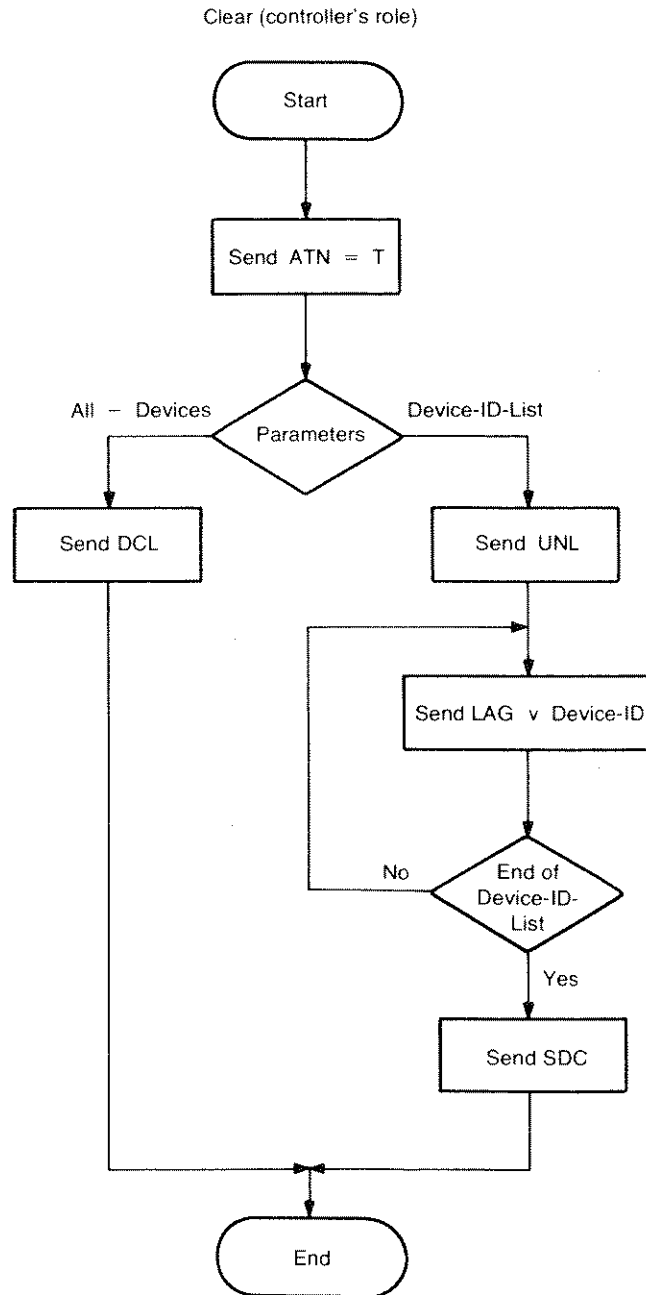



Require Service

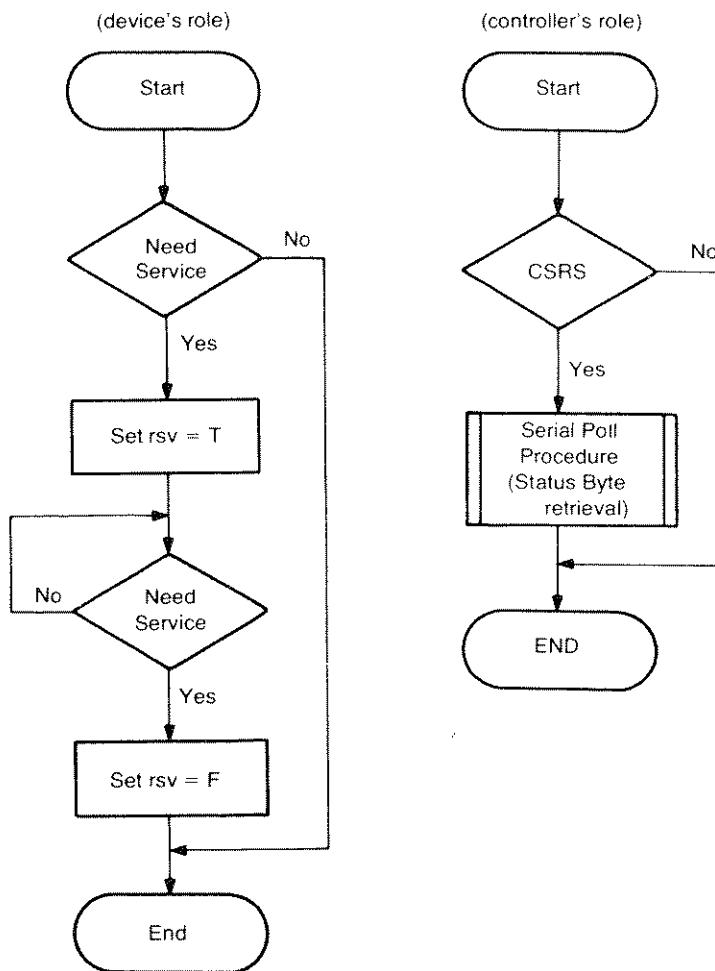

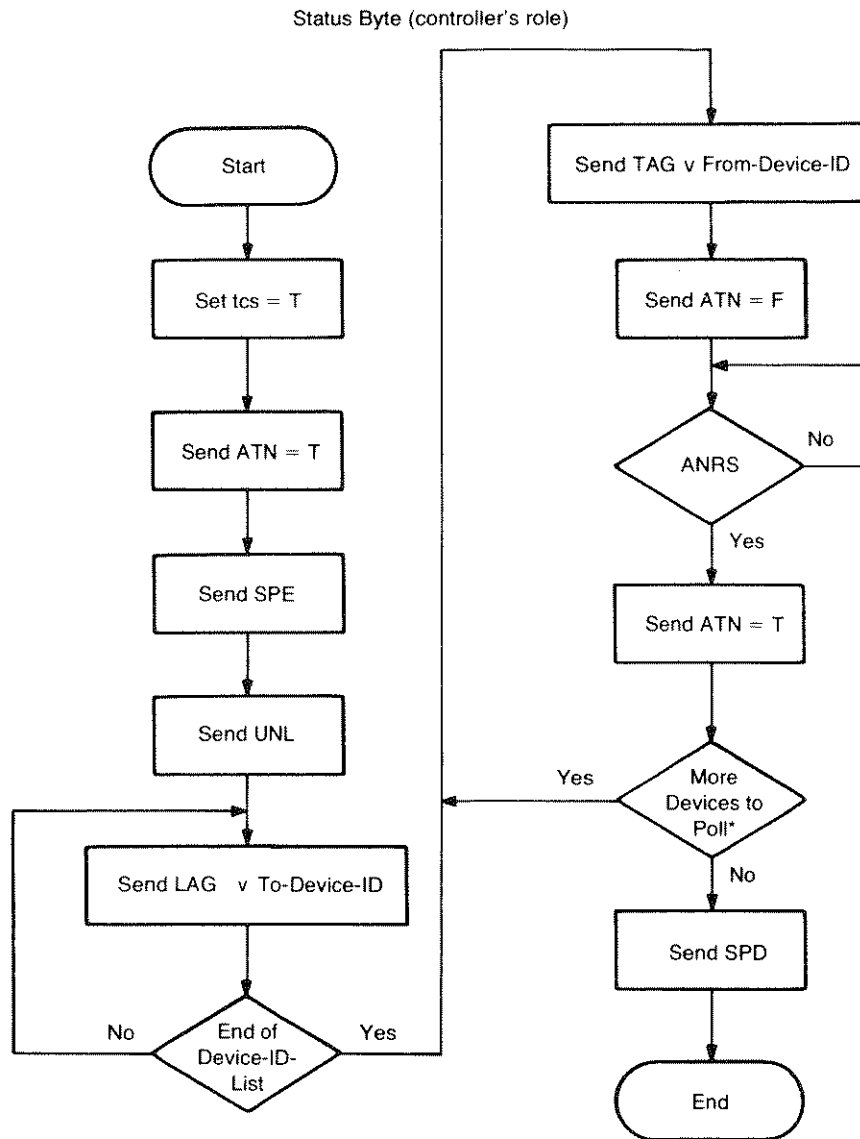

\*Status Bytes are usually received during a serial poll.  
 This algorithm represents a way to send Status Byte messages from a series of From-Device-ID's to a single To-Device-ID list.

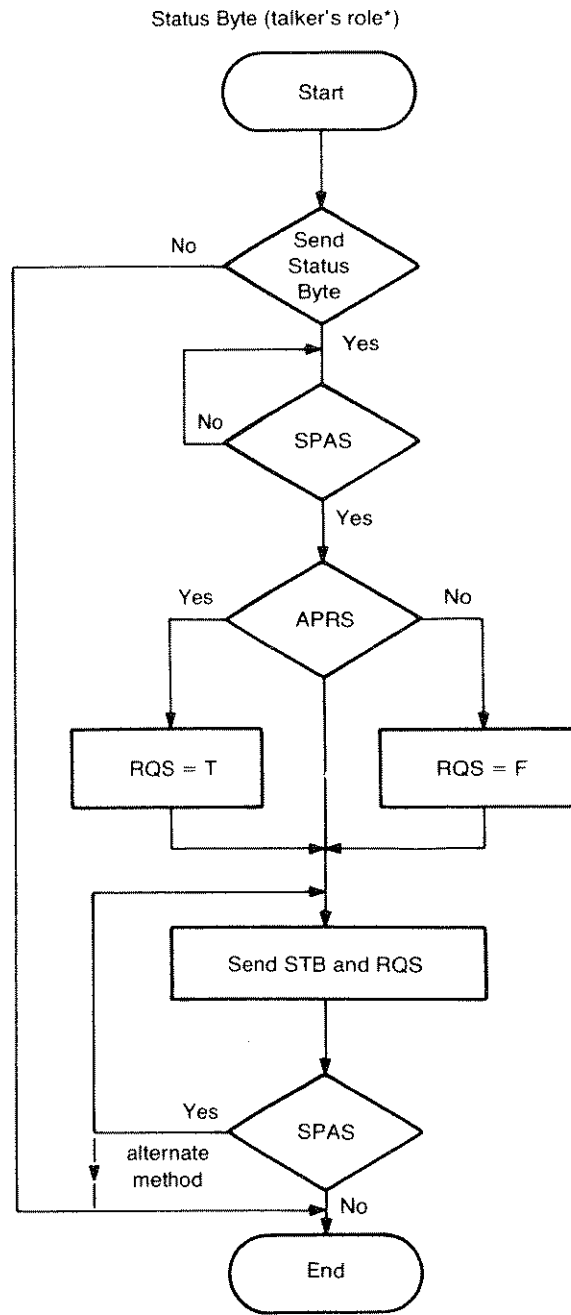

\*Listener's role in Status Byte message is similar to listener's role in Data message.

Status Bit (controller's role)

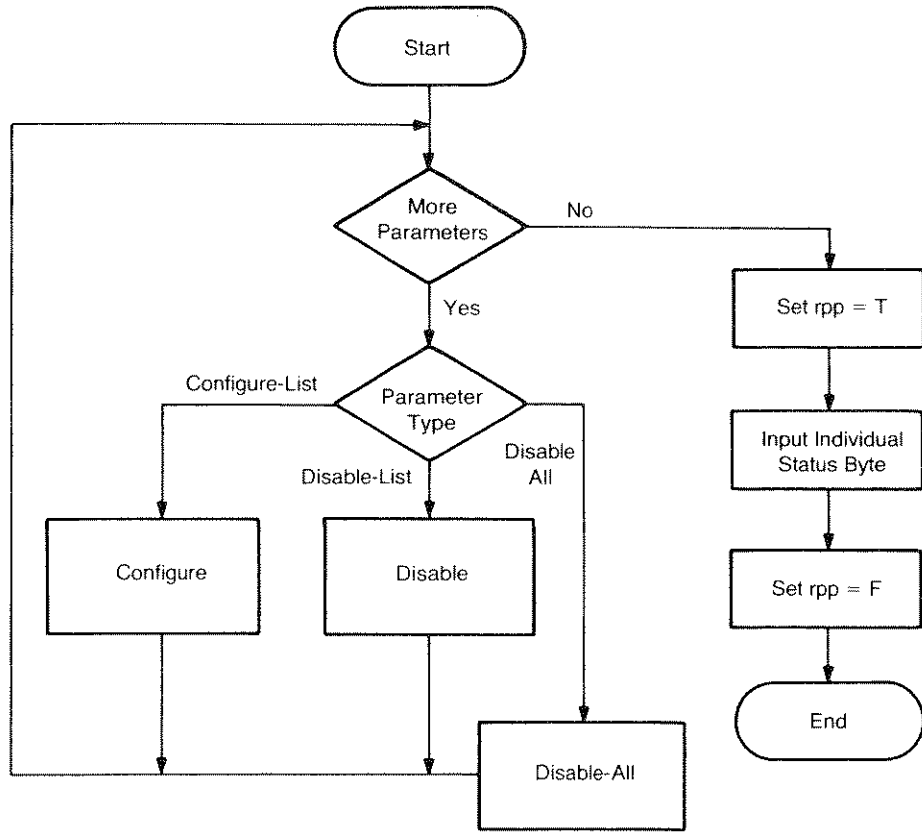

Status Bit (parameter setup)

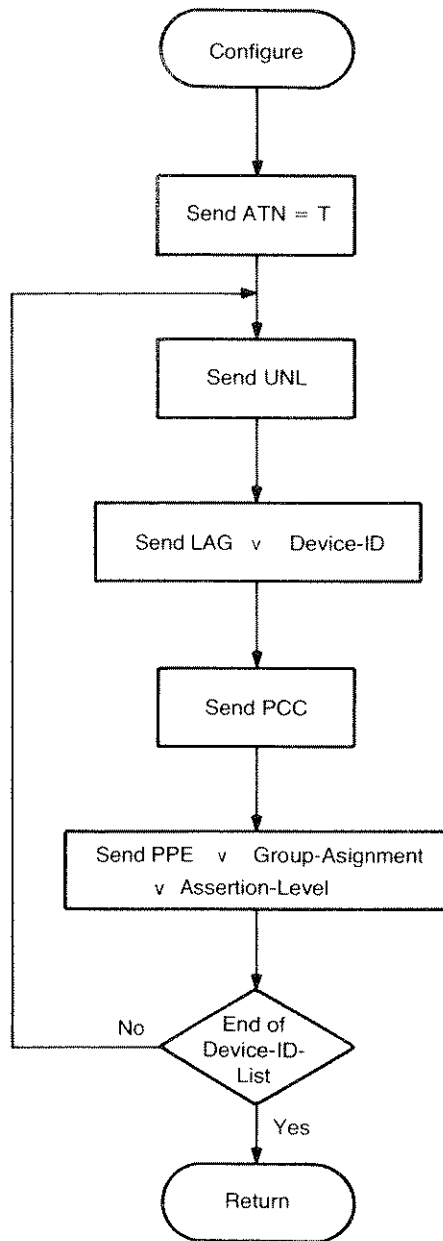

Status Bit Parameter Set Up  
(controller's role)

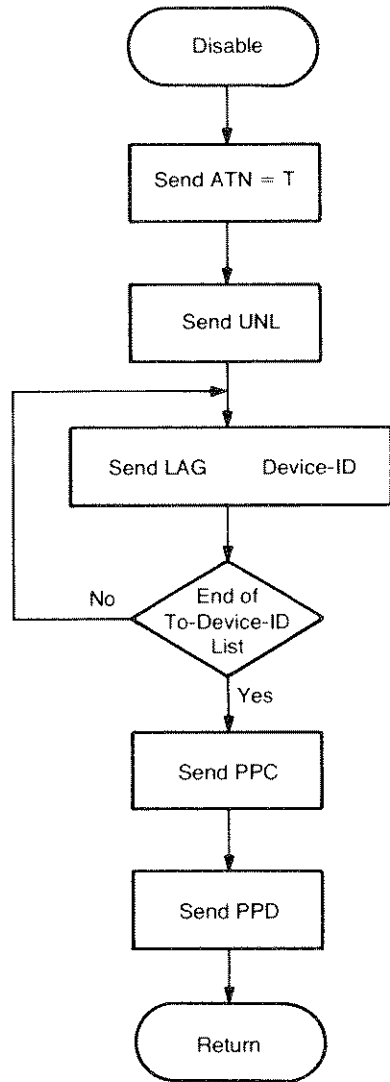

Status Bit (Device's role)

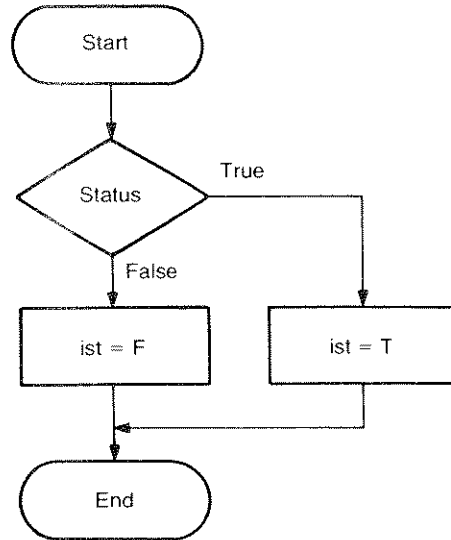

Disable-All (controller's role)

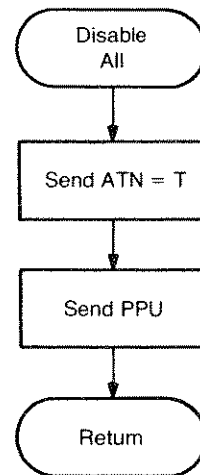

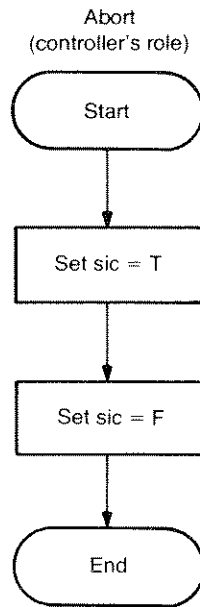

# Appendix D

## Index

### Subject Index

- a**
- Abort ..... 24,84
  - Absolute Length ..... 30,39
  - Active Controllers ..... 22
  - Address Code ..... 8,10,11,57
  - Address, Primary ..... 64
  - Addressing ..... 21
  - Affirmative Parallel Poll Response ..... 40,57
  - Automatic Verify ..... 34,57,69
  - AV ..... 32,34,57,69
- b**
- Beginning of File (BOF) ..... 27,41,43,  
46,49,52,53,71
  - Beginning of Record (BOR) ..... 27,38,  
47,50,71
  - Buffer Status Identifier ..... 63,64
  - Bus Concepts ..... 22
  - Bus Protocol ..... 24
  - Byte ..... 21
    - Count ..... 34,36,37,61
    - DSJ ..... 66
    - Status ..... 23,24,45,66,79,80
  - Bytes per Record ..... 38,41,42,43,53
- c**
- Care, Tape ..... 15
  - Cartridge
    - Insertion ..... 14
    - Removal ..... 14
  - Tape ..... 1,13,15,16,69,71
  - Checksum ..... 30,71
  - Cleaning, Tape Head ..... 14,15
  - Clear Lockout and Set Local Message ..... 23,24
  - Clear Message ..... 23,24,77
  - Clearing an Error Indication ..... 44,  
46,56,59
  - Clearing Errors ..... 44,46,56,59
  - Code, Device Identity ..... 65
  - Codes
    - Address ..... 8,10,11,57
    - Select ..... 8,10,11,57
  - Command
    - Set ..... 31,32
    - Syntax ..... 32
  - Command, Example ..... 33
  - Commands
    - Data Input ..... 31,32,49,50,51,53
    - Data Output ..... 31,32,46,47
    - Form ..... 24,25
    - Immediate Execution ..... 31,32,  
34,37,40,41,43,48,50,51
    - Parameter Output ..... 31,32,38,  
39,44,45
  - Concepts
    - Interface Bus ..... 22
    - Message ..... 23
  - Conditioning the Tape ..... 16
  - Connection, Interface ..... 10
  - Continuous Output Specifier ..... 36,37
  - Controllers
    - Active ..... 22
    - System ..... 22
  - Cords, Power ..... 6,7
  - Current File ..... 37,46,47,48,52



- Data
- Input Commands ..... **31,32,49,**  
50,51,53
  - Input/Output ..... 1,51,59,**63**
  - List ..... 34,46,47,49,53,**56**
  - Logging ..... 1,51,**66**
  - Message ..... **23,24,75,76**
  - Input Commands ..... 31,32,49,50,  
51,53
  - Output Commands ..... **31,32,46,47**
  - Default ..... **71**
  - Delay, Time ..... **51,67,69**
  - Device
    - Clear ..... 46,48,59,**60,69**
    - Dependent Action ..... **21**
    - Identity Code ..... **65**
    - Specified Jump (DSJ) ..... **66**
  - Drive
    - 0 Test Results ..... **45**
    - 1 Test Results ..... **45**
    - Selection ..... **48,57,69**
  - DSJ Byte ..... **66**
- ED ..... 32,33,**34,35,**  
36,56,57,67,69
- Electronics Test Result ..... **45**
- Empty Record Indicator ..... **29**
- End of
- Data List ..... 33,**34,35,36,**  
56,57,67,69
  - Tape (Logical) ..... **30**
  - Valid Data Mark (EVD) ... **30,37,41,43,**  
44,46,47,50,52,53,58,59,71
- EOD Character ..... 33,**34,35,36,37,53,**  
56,57,67,69
- EOI Message ..... 34,36,55,**61**
- Equipment Supplied ..... **5**
- Error
- Code 1 ..... **44**
  - Code 2 ..... **45**
  - Indication ..... 14,18,19,  
47,48,51,56,59
  - Interrupt Routine ..... **62**
- Errors
- Clearing ..... 44,46,56,59
  - Handling ..... 44,46,56,59
- FE ..... 32,**37,38,41,50,58,61**
- FF ..... 25,32,**37,38**
- File
- Body ..... **28**
  - Identifier Bit ..... 29,**30**
  - Header ..... **30**
  - Record ..... 28,30,41,**43,47,49,71**
  - Mark ..... 27,**28,43,53,72**
  - Number ..... **29,38,39,46,47,49**
  - Overflow ..... **44,47,50**
  - Size Interaction ..... **42**
  - Word ..... **29,72**
- File,
- Current ..... 37,46,47,48,**52**
  - Tape ..... **27,71**
- Files ..... 27,71
- Incremental Addition of ..... **52,53,**  
67
  - Marking ..... **58**
  - Non-premarked ..... **61**
  - Premarked ..... **60,61**
- Find
- End of Valid Data Command . **37,38,41,**  
50,58,61
  - File Command ..... 25,**37,38**
  - Free Field ..... 29,**30,39,40,41,43,72**
  - Front Panel Lamps ..... 13,**14,51**
  - Fuses ..... **5**
- Gap
- Interfile ..... **27,30,72**
  - Interrecord ..... 27,**29,72**
  - Glossary ..... **71**
  - Grounding Requirements ..... **6**

Handling Errors ..... 44,46,56,59  
 Head, Magnetic Tape ..... 14,15  
 Header  
   Checksum ..... 30,71  
   File Identifier ..... 30  
   Record ..... 28,30  
 HP-IB ..... 1,10,11,21,23,24,25  
   Interface ..... 10  
   System Terms ..... 21  
   Worksheet ..... 11,23,85

Identifier  
   Buffer Status ..... 63,64  
   File ..... 28,30,41,43,47,49,71  
   Record ..... 28,30,41,43,47,49,71  
 Identity Code, Device ..... 65  
 IF ..... 32,38  
 IM ..... 32,40  
 Immediate Execution commands ..... 31,32,  
   34,37,40,41,43,48,50,51  
 Indication, Errors ..... 14,18,19,47,48,  
   51,56,59  
 Initialized Conditions ..... 33,34,57  
 Input Mask ..... 40  
 Input/Output of Data ..... 1,51,59,63  
 Inserting the Cartridge ..... 14  
 Inspection Procedures ..... 5  
 Installation Procedures ..... 5  
 Interaction, File Size ..... 42  
 Interface Connection ..... 10  
 Interfile Gap ..... 27,30,72  
 Interrecord Gap ..... 27,29,72  
 Interrupt Service Routine ..... 59,62  
 Interval, Time ..... 51,57,69  
 IR ..... 32,39

Jump, Device Specified ..... 66

Lamps, Front Panel ..... 13,14,51  
 Legal Tape Positions ..... 41,43,61  
 Length Word ..... 30,72  
 Line Voltage ..... 7,8  
 Listen Only (LO) ..... 66,67,68,69  
 Listeners ..... 22,25  
 Local Lockout Message ..... 23,24  
 Local Message ..... 23,24  
 Logging, Data ..... 1,51,66  
 Logical End of Tape ..... 30

Magnetic Tape  
   Cartridge ..... 1,13,15,16,69,71  
   Head ..... 14,15  
 Mark  
   EVD ..... 30,37,41,43,44,46,47,  
     50,52,53,58,59,71  
   File ..... 27,28,72  
   File Command ..... 41,52,61  
   Record Command ..... 43,61  
 Marking Files ..... 41,58  
 Masks  
   Input ..... 40  
   Require Service ..... 40,62  
 Message Concepts ..... 23  
 MF ..... 32,41,52,61  
 Modes  
   Autoverify ..... 34,57,69  
   LO ..... 11,66,67,68,69  
   Self Identify ..... 64,65  
   TO ..... 11,68,69  
 Mounting Adaption, Rack ..... 8,9  
 MR ..... 32,43,61

Non-premarked Files ..... 61  
 Non-updateable Records ..... 28,72  
 Normal Operation ..... 58  
 Number, File ..... 29,38,39,46,47,49

- O**
- OE ..... 19,32,44,45,50,56,  
. 59,60,62,69
- Operation  
  Normal ..... 58  
  Theory of ..... 55
- Operator ..... 21
- Option 001 ..... 1,48
- OS ..... 32,45,56,59,69
- Output  
  Error Command ..... 19,44,45,50,56,  
    . 59,60,62,69
- Specifier, Continuous ..... 36,37
- Status Command ..... 45,56,59,69
- P**
- Panel Lamps, Front ..... 13,14,51
- Parallel Poll Response Lines ..... 57
- Parameter  
  List ..... 31,32,38,39,44  
  Output Commands ..... 31,44,45
- Parameters ..... 32,46,72
- Transfer ..... 25
- Pass Control Message ..... 24
- Physical Record Number ..... 28,39
- Polling  
  Parallel ..... 21,40,57  
  Serial ..... 21,45,56,57
- Postamble ..... 28,72
- Power  
  Cords ..... 6,7  
  On Procedure ..... 12  
  Requirements ..... 6
- Premarked Files ..... 60,61
- Primary Address ..... 64
- Procedures  
  Inspection ..... 5  
  Installation ..... 5
- Programmable LO/TO ..... 68,69
- Protocol, Bus ..... 24
- R**
- Rack Mounting ..... 8,9
- Read  
  File Command ..... 46,61,62  
  File Identifier Command ..... 47,61,62  
  Record Command ..... 47,61,62
- Record  
  Body ..... 28,73  
  Header ..... 28,30  
  Size ..... 38,41,42,43,53  
  Word ..... 30,73
- Record,  
  File Identifier ..... 28,41,43,47,49,71  
  Non-updateable ..... 28,72  
  Updateable ..... 28,73
- Records ..... 27,28
- Remote Message ..... 23,24
- Removal of the Cartridge ..... 14
- Require Service ..... 23,24,40,78  
  Mask ..... 40,62
- Requirements  
  Grounding ..... 6  
  Power ..... 6
- Reserved Bit ..... 29,40
- Reserving Tape Space ..... 41
- Response to  
  Parallel Poll ..... 40,57  
  Serial Poll ..... 45,56
- Respooling the Tape ..... 16
- Rewind Command ..... 41,46,48,  
. 50,58,61,67
- RF ..... 32,46,61,62
- RI ..... 32,47,61,62
- RR ..... 32,47,61,62
- RW ..... 32,41,46,48,50,58,61,67

- SD ..... 32,48,57,69
- Select
  - Code ..... 8,10,11,57
  - Drive Command ..... 48,57,69
- Self
  - Identify Mode ..... 64,65
  - Test
    - Procedure ..... 17,18,19
    - Switch ..... 12,18,19
    - Command ..... 50,51
- Serial Poll ..... 21,45,56,57
- SF ..... 32,49,52,60,61
- SI ..... 32,49,60,61
- Size, Absolute ..... 30,39
- Slack Area ..... 29,73
- Specifications ..... vii,viii
- Specifier, Continuous Output ..... 36,37
- SR ..... 32,50,53,60,61
- SRQ ..... 23,24,40,78
- ST ..... 32,50,51
- Standard Interchange Format (SIF)
  - ..... 27,28,29,30
- Status
  - Bit Message ..... 23,24,81,82,83
  - Byte ..... 23,24,45,66,79,80
  - Byte Message ..... 23,34
  - Byte Value ..... 45,46
  - Identifier, Buffer ..... 63,64
- Store
  - File Command ..... 49,52,60,61
  - File Identifier Record Command
    - ..... 49,60,61
  - Record Command ..... 50,53,60,61
- Syntax Guidelines ..... 33
- Syntax, Command ..... 32
- System Terms, HP-IB ..... 21
- Talk Only (TO) ..... 68,69
- Talkers ..... 22,25
- Tape
  - Care ..... 15
  - Cartridge ..... 1,13,15,16,69,71
  - Conditioning ..... 16
  - File ..... 27,71
  - Head Cleaning ..... 14,15
  - Life ..... 69
  - Respooling ..... 16
- Termination of Data List ..... 36
- Terminator, Command ..... 25
- Test
  - Procedure ..... 17,18,19
  - Results .....
    - Drive 0 ..... 45
    - Drive 1 ..... 45
    - Electronics ..... 45
- Testing R/W Circuitry ..... 17,50
- Theory of Operation ..... 55
- TI ..... 32,51,57,69
- Time Delay ..... 51
- Tracks ..... 27,73
- Transfer Parameters ..... 25
- Trigger Message ..... 23,24
- Typical Tape Capacity ..... 42
- Updateable Records ..... 28,73
- Verify, Automatic ..... 34,57,69
- Voltage
  - Line ..... 7,8
  - Selection ..... 7,8

## W

WF .....	32,52,53,67
Word	
File .....	29,72
Record .....	30,73
Worksheet, HP-IB .....	11,23,85
WR .....	32,53,67
Write	
Enabled .....	13,67
File Command .....	51,52,53,67
Protected .....	13
Record Command .....	53,67

# Appendix F

## Status and Errors

### Status Byte

(response to Serial Poll)

Bit 0	Bit 1	Bit 2	Bit 3	Bit 4	Bit 5	Bit 6	Bit 7
data buffer empty	data buffer full	ready for next instruction	initialized	always 0 (not used)	error	request service (SRQ)	drive # 1 selected

### Status Byte Value

1. data buffer empty
2. data buffer full
4. ready for next instruction
8. initialized (set only after power on or device clear) *or self test?*
16. not used (always 0)
32. error
64. require service (SRQ)
128. drive #1 selected

### Error Code #1 (First Parameter Returned)

0. No error or test passed
1. Cartridge out or file not found.
2. Cartridge is write protected or record not found.
4. Drive not present or internal temperature is too high.
8. Verify failed or illegal tape position.
16. File/record overflow or attempt to read an empty file/record.
32. Body checksum error or attempt to store, write or mark a non-updateable record.
64. Header checksum error or end of tape.
128. Servo or hardware failure.

## Error Code #2 (Second Parameter Returned)

0. No error.
1. Unexpected byte received.
2. Unexpected byte requested.
4. Illegal character in parameter list.
8. Mandatory parameter is not specified.
16. Too many parameters specified.
32. Parameter is out of limits.
64. Syntax error.

An unexpected byte received error is generated when the CTU is ready to output a data list, and it receives any type of data (data list or command).

An unexpected byte requested error is generated when the CTU is ready to input a data list, and it receives a data output command.

These errors may also occur because a data list (either input or output) was not terminated with the EOD character.

**SALES & SERVICE OFFICES**  
AFRICA, ASIA, AUSTRALIA

**Appendix E**

**ANGOLA**  
Telectra  
Empresa Técnica de Equipamentos Eléctricos, S.A. R.L.  
R. Barbosa Rodrigues 424 DT  
Cassa Postal 6467  
**Luanda**  
Tel 35515/6  
Cable: TFELECTRA Luanda

**HONG KONG**  
Schmidt & Co (Hong Kong) Ltd  
P.O. Box 297  
Connaught Centre  
39th Floor  
Connaught Road, Central  
**Hong Kong**  
Tel H 25291-5  
Telex 74766 SCHMC HK  
Cable: SCHMIDTGO Hong Kong

Blue Star Ltd  
1-1-117 1  
Sarajev Devi Road  
**Secunderabad 500 003**  
Tel 70126, 70127  
Cable: BLUEFR0ST  
Telex 459  
Blue Star Ltd  
2-34 Kordambakkam High Road  
**Madras 600034**  
Tel 82056  
Telex 641-379  
Cable: BLUESTAR  
Blue Star Ltd  
Nadhrat Mansions  
2nd Floor Bistapur  
**Jamshedpur 831 001**  
Tel 7383  
Cable: BLUESTAR  
Telex 240

Yokogawa-Hewlett-Packard Ltd  
Mitsui Bussan Building  
105, Chome-1 San-no-maru  
**Mito, Ibaragi 310**  
Tel 0297-25-7470  
Yokogawa-Hewlett-Packard Ltd  
Inoue Building  
1346-3, Asahi-cho, 1-chome  
**Atsugi, Kansai 243**  
Tel 0462-24-0452  
Yokogawa-Hewlett-Packard Ltd  
Kishira Building  
3rd Floor 20  
2-chome, Tsukuba  
**Kumagaya, Saitama 360**  
Tel 0485-24-6263

Hewlett-Packard (N.Z.) Ltd  
Palukanga Professional Centre  
267 Pakuranga Highway  
**Pakuranga**  
Tel 369-651  
Telex NZ 3839  
Cable: HEWPACK Auckland  
Analytical/Medical Only  
Medical Supplies N.Z. Ltd.  
Scientific Division  
45 Kelvin Gore Rd., Newmarket  
P.O. Box 1234  
**Auckland**  
Tel 75-289  
Telex 2958 MEDISUP  
Cable: DENTAL Auckland  
Analytical/Medical Only  
Medical Supplies N.Z. Ltd  
P.O. Box 1904  
147-161 Tory St  
**Wellington**  
Tel 650-799  
Telex 3656  
Cable: DENTAL Wellington  
Analytical/Medical Only  
Medical Supplies N.Z. Ltd  
P.O. Box 309  
239 Stanmore Road  
**Christchurch**  
Tel 892-019  
Cable: DENTAL Christchurch  
Analytical/Medical Only  
Medical Supplies N.Z. Ltd  
383 Great King Street  
P.O. Box 233  
**Dunedin**  
Tel 88-177  
Cable: DENTAL Dunedin

**PHILIPPINES**  
The Online Advanced Systems Corporation  
6th Floor, Yuju Co. Bldg  
560 Donato Paredes St.  
**Manila**  
Tel: 48-71-49, 48-68-53  
In Makati: 85-25-81, 85-34-91  
Telex 3274 ONLINE

**TAIWAN**  
Hewlett-Packard Far East Ltd.  
Taiwan Branch  
39 Chung Shiao West Road  
Sec. 1, 7th Floor  
**Taipei**  
Tel: 3819166-4  
Telex: 21824 HEWPACK  
Cable: HEWPACK TAIPEI  
Hewlett-Packard Far East Ltd  
Taiwan Branch  
88-2 Chung Cheng 3rd Road  
**Kaohsiung**  
Tel: (07) 242318-Kaohsiung  
Analytical Only  
San Kwang Instruments Co. Ltd.  
No. 20, Yang Sun Road  
**Taipei**  
Tel: 3715071-4 (5 lines)  
Telex: 22894 SANKWANG  
Cable: SANKWANG TAIPEI

**AUSTRALIA**  
Hewlett-Packard Australia Pty Ltd  
31-41 Joseph Street  
**Blackburn, Victoria 3130**  
P.O. Box 36  
**Doncaster East, Victoria 3109**  
Tel 89-6351  
Telex 31-024  
Cable: HEWPAARD Melbourne  
Hewlett-Packard Australia Pty Ltd  
31 Bridge Street  
**Pymble**  
New South Wales, 2073  
Tel 449-6566  
Telex 21561  
Cable: HEWPAARD Sydney  
Hewlett-Packard Australia Pty Ltd  
153 Greenhill Road  
**Parkside, S.A. 5063**  
Tel 272-5911  
Telex 82535 ADAL  
Cable: HEWPAARD Adelaide  
Hewlett-Packard Australia Pty Ltd  
141 Stirling Highway  
**Nedlands, W.A. 6009**  
Tel 86-5455  
Telex 93259 PERTH  
Cable: HEWPAARD PERTH  
Hewlett-Packard Australia Pty Ltd  
121 Wolongong Street  
**Fyshwick, A.C.T. 2609**  
Tel 95-2733  
Telex 62650 Canberra  
Cable: HEWPAARD CANBERRA  
Hewlett-Packard Australia Pty Ltd  
5th Floor  
Teachers Union Building  
495-499 Bourke Street  
**Spring Hill, 4000 Queensland**  
Tel 229-1544  
Cable: HEWPAARD Brisbane

**INDIA**  
Blue Star Ltd  
Kasturi Buildings  
Janshopp Tale Rd.  
**Bombay 400 020**  
Tel 29 50 21  
Cable: BLUEFR0ST  
Tel 2156  
Blue Star Ltd  
Salas  
4142 Nr Savarkar Marg  
Prabhadevi  
**Bombay 400 025**  
Tel 45 78 87  
Cable: BLUEFR0ST  
Blue Star Ltd  
Sahas  
4142 Nr Savarkar Marg  
Prabhadevi  
**Bombay 400 025**  
Tel 45 78 87  
Cable: BLUESTAR  
Blue Star Ltd  
Sahas  
4142 Nr Savarkar Marg  
Prabhadevi  
**Bombay 400 025**  
Tel 45 78 87  
Cable: BLUESTAR  
Blue Star Ltd  
Sahas  
4142 Nr Savarkar Marg  
Prabhadevi  
**Bombay 400 025**  
Tel 45 78 87  
Cable: BLUESTAR

**INDONESIA**  
BERCA Indonesia P I  
P.O. Box 498  
1st Floor JL. Cikini Raya 61  
**Jakarta**  
Tel: 56338, 40369, 49886  
Telex 42895  
Cable: BERCAON  
BERCA Indonesia P I  
63 Jl. Raya Gubeng  
**Surabaya**  
Tel 44309  
**ISRAEL**  
Electronics & Engineering Div  
of Motorola Israel Ltd.  
17, Kremenski Street  
P.O. Box 25018  
**Tel-Aviv**  
Tel 38973  
Telex 35659  
Cable: BASTEL Tel-Aviv  
**JAPAN**  
Yokogawa-Hewlett-Packard Ltd  
Ohashi Building  
59-1 Yoyogi 1-Chome  
Shibuya-ku, Tokyo 151  
Tel 03-370-7281/52  
Telex 232 2024YHP  
Cable: YHPMARKET TOK 23-724  
Yokogawa-Hewlett-Packard Ltd  
Seko Ibaraki Building  
2-8 Kasuga 2-chome, Ibaraki-shi  
**Osaka 567**  
Tel (0726) 23-1641  
Telex 5332-385 YHP OSAKA  
Yokogawa-Hewlett-Packard Ltd  
Nakano Building  
24 Kami Sasagawa-cho  
Nakamura-ku, Nagoya 450  
Tel (0521) 571-5171  
Yokogawa-Hewlett-Packard Ltd  
Tagawa Building  
2-24-1 Toriyama-cho  
Kanagawa-ku  
**Yokohama, 221**  
Tel 045-312-1252  
Telex 382-3204 YHP YOK

**KENYA**  
Technical Engineering Services  
4E A Ltd.  
P.O. Box 18311  
**Nairobi**  
Tel 55726, 556762  
Cable: PROTON  
Medical Only  
International Aeradio E A Ltd.  
P.O. Box 19012  
Nairobi Airport  
**Nairobi**  
Tel 336055-56  
Telex 22201-22301  
Cable: INTAERIO Nairobi  
**KOREA**  
Samsung Electronics Co., Ltd  
20th H. Dongbang Bldg 250 2-KA  
P.O. Box 2775  
Tangpyung-Ro, Chung-Ku  
**Seoul**  
Tel (231) 6811  
Telex 22575  
Cable: ELESTAR Seoul  
**MALAYSIA**  
Telex Muti Sdn Bhd  
2 Lorong 13/6A  
Section 13  
Petaling Jaya, Selangor  
Tel 54994 54985  
Telex MA 37605  
Protel Engineering  
P.O. Box 197  
Lot 258, Sialok Road  
Kuching, Sarawak  
Tel 2400  
Cable: PROTEL ENG  
**MOZAMBIQUE**  
A N Goncalves, Ltd  
162, 11 April 14 Av. D Luis  
Cassa Postal 107  
**Lourenco Marques**  
Tel 27091, 27114  
Telex 6-203 NEGOM MO  
Cable: NEGOM  
**NEW ZEALAND**  
Hewlett-Packard (N.Z.) Ltd  
P.O. Box 4443  
Courtney Place  
**Wellington**  
Tel 827-159  
Telex NZ 3839  
Cable: HEWPACK Wellington

**NIGERIA**  
The Electronics Instrumentations Ltd  
N68 720 Oyo Road  
Gbebe House  
P.M.B. 5402  
**Ibadan**  
Tel 61577  
Telex 630-6188 9  
Cable: THETEL Ibadan  
The Electronics Instrumentations Ltd  
144 Agege Motor Road, Mushin  
P.O. Box 8645  
**Lagos**  
Cable: THETEL Lagos  
**PAKISTAN**  
Mushko & Company, Ltd  
Bostan Chambers  
Abdullah Haroon Road  
**Karachi-3**  
Tel 511827, 512927  
Telex NEGOM  
Cable: COOPERATOR Karachi  
Mushko & Company, Ltd  
38B, Saleem Tower  
**Rawalpindi**  
Tel 41924  
Cable: TEMUS Rawalpindi

**RUSSIA**  
Hewlett-Packard Professional Centre  
267 Pakuranga Highway  
**Pakuranga**  
Tel 369-651  
Telex NZ 3839  
Cable: HEWPACK Auckland  
Analytical/Medical Only  
Medical Supplies N.Z. Ltd.  
Scientific Division  
45 Kelvin Gore Rd., Newmarket  
P.O. Box 1234  
**Auckland**  
Tel 75-289  
Telex 2958 MEDISUP  
Cable: DENTAL Auckland  
Analytical/Medical Only  
Medical Supplies N.Z. Ltd  
P.O. Box 1904  
147-161 Tory St  
**Wellington**  
Tel 650-799  
Telex 3656  
Cable: DENTAL Wellington  
Analytical/Medical Only  
Medical Supplies N.Z. Ltd  
P.O. Box 309  
239 Stanmore Road  
**Christchurch**  
Tel 892-019  
Cable: DENTAL Christchurch  
Analytical/Medical Only  
Medical Supplies N.Z. Ltd  
383 Great King Street  
P.O. Box 233  
**Dunedin**  
Tel 88-177  
Cable: DENTAL Dunedin

**SINGAPORE**  
Hewlett-Packard Singapore  
Tel 705251 (5 lines)  
Telex BH 4022  
**SOUTH AFRICA**  
Hewlett-Packard South Africa (Pty.) Ltd  
Private Bag, Wendywood  
Section 1, Transvaal 2144  
Hewlett-Packard Centre  
Dagbasi Street, Wendywood  
**Sandton, Transvaal 2144**  
Tel 802-104018  
Telex 8-4782  
Cable: HEWPACK JOHANNESBURG  
Service Department  
Hewlett-Packard South Africa (Pty.) Ltd  
P.O. Box 39325  
Grahamley Sandnes, 2018  
451 Wymberg Extension 3.  
**Sandton, 2001**  
Tel 630-6188 9  
Telex 8-2391  
Hewlett-Packard South Africa (Pty.) Ltd  
P.O. Box 170  
Howard Place, Cape Province, 7450  
Pine Park Center, Forest Drive.  
**Pretorius, Cape Province, 7405**  
Tel 53-7955 (bu 9)  
Cable 55-0006  
Service Department  
Hewlett-Packard South Africa (Pty.) Ltd  
P.O. Box 37099  
Overport, Durban 4067  
(Barby House)  
641 Ridge Road  
**Durban, 4001**  
Tel 88-7478  
Telex 6-7954

**TANZANIA**  
Medias Only  
International Aeradio E A. I. Ltd  
P.O. Box 861  
**Dar es Salaam**  
Tel 21251 Ext. 265  
Cable: SANKWANG TAIPEI

**THAILAND**  
UNIMESA Co., Ltd  
Ecom Research Building  
Bangkok Sukunvit 1  
**Bangkok**  
Tel 932887, 930338  
Cable: UNIMESA Bangkok  
**UGANDA**  
Medical Only  
International Aeradio E A. I. Ltd  
P.O. Box 2477  
**Kampala**  
Tel 54388  
Cable: INTAERIO Kampala  
**ZAMBIA**  
R. J. Tibary (Zambia) Ltd  
P.O. Box 2792  
**Lusaka**  
Tel 23793  
Cable: ARJAYTEL Lusaka

**OTHER AREAS NOT LISTED. CONTACT:**  
Hewlett-Packard Intercontinental  
3200 Hillview Ave  
Palo Alto, California 94304  
Tel (415) 493-1501  
TWX 910-373-1267  
Cable: HEWPACK Palo Alto  
Telex 034-8300, 034-8493

**OTHER AREAS NOT LISTED. CONTACT:**  
Hewlett-Packard Intercontinental  
3200 Hillview Ave  
Palo Alto, California 94304  
Tel (415) 493-1501  
TWX 910-373-1267  
Cable: HEWPACK Palo Alto  
Telex 034-8300, 034-8493

**OTHER AREAS NOT LISTED. CONTACT:**  
Hewlett-Packard Intercontinental  
3200 Hillview Ave  
Palo Alto, California 94304  
Tel (415) 493-1501  
TWX 910-373-1267  
Cable: HEWPACK Palo Alto  
Telex 034-8300, 034-8493

**OTHER AREAS NOT LISTED. CONTACT:**  
Hewlett-Packard Intercontinental  
3200 Hillview Ave  
Palo Alto, California 94304  
Tel (415) 493-1501  
TWX 910-373-1267  
Cable: HEWPACK Palo Alto  
Telex 034-8300, 034-8493

**CANADA**

**ALBERTA**  
Hewlett-Packard (Canada) Ltd  
11620A - 168 Street  
**Edmonton T5M 3T9**  
Tel (403) 452-3670  
Telex 610-831-2431 EDTH  
TWX 610-831-2431 EDTH  
Hewlett-Packard (Canada) Ltd  
915-42 Ave S.E., Suite 102  
**Calgary T2C 1Z1**  
Tel (403) 281-1672  
TWX: 610-821-6141

**BRITISH COLUMBIA**  
Hewlett-Packard (Canada) Ltd  
837 E. Cordova Street  
**Vancouver V6A 3R2**  
Tel (604) 254-9531  
Telex 610-922-5069 VCF  
**MANITOBA**  
Hewlett-Packard (Canada) Ltd  
513 Century St  
St. James  
**Winnipeg R3H 0L8**  
Tel (204) 786-7581  
Telex 610-671-3531

**NOVA SCOTIA**  
Hewlett-Packard (Canada) Ltd  
800 Woodlark Road  
P.O. Box 9331  
**Dartmouth B2Y 3Z8**  
Tel (902) 469-7800  
Telex 610-271-4482 1E4

**ONTARIO**  
Hewlett-Packard (Canada) Ltd  
1020 Morrison Dr  
**Ottawa K2H 8K7**  
Tel (613) 820-6483  
Telex 610-513-1636  
Hewlett-Packard (Canada) Ltd  
6877 Gateway Drive  
**Mississauga L4V 1M8**  
Tel (416) 678-9430  
Telex 610-492-4246

**QUEBEC**  
Hewlett-Packard (Canada) Ltd  
275 Hymus Blvd  
**Pointe Claire H9R 1G7**  
Tel (514) 691-4232  
Telex 610-423-3022  
Telex 05-821251 HPCL

**FOR CANADIAN AREAS NOT LISTED:**  
Contact Hewlett-Packard (Canada) Ltd in Mississauga

**FOR CANADIAN AREAS NOT LISTED:**  
Contact Hewlett-Packard (Canada) Ltd in Mississauga

**CENTRAL AND SOUTH AMERICA**

**ARGENTINA**  
Hewlett-Packard Argentina S.A.  
Av. Leandro N. Alem 822 - 12  
**1001 Buenos Aires**  
Tel 31-6663, 4.5.6 and 7  
Telex Public Booth N 9  
Cable: HEWPACK ARG

**BOLIVIA**  
Stambuk & Mark (Bolivia) Ltda  
Av. Mariscal, Santa Cruz 1342  
**La Paz**  
Tel 40626, 53163, 52421  
Telex 3560014  
Cable: BUKMAR

**BRAZIL**  
Hewlett-Packard do Brasil L.C. Ltda  
Avenida Rio Negro, 980  
Alphaville  
06400, Barro Preto, **Sao Paulo**  
Tel 429-2148-9, 429-2118-9  
Hewlett-Packard do Brasil L.C. Ltda  
Rua Padre Chagas, 32  
**90000-Porto Alegre-RS**  
Tel (0512) 22-2998, 22-5621  
Cable: HEWPACK porto Alegre

**BRAZIL**  
Hewlett-Packard do Brasil L.C. Ltda  
Avenida Rio Negro, 980  
Alphaville  
06400, Barro Preto, **Sao Paulo**  
Tel 429-2148-9, 429-2118-9  
Hewlett-Packard do Brasil L.C. Ltda  
Rua Padre Chagas, 32  
**90000-Porto Alegre-RS**  
Tel (0512) 22-2998, 22-5621  
Cable: HEWPACK porto Alegre

**BRAZIL**  
Hewlett-Packard do Brasil L.C. Ltda  
Avenida Rio Negro, 980  
Alphaville  
06400, Barro Preto, **Sao Paulo**  
Tel 429-2148-9, 429-2118-9  
Hewlett-Packard do Brasil L.C. Ltda  
Rua Padre Chagas, 32  
**90000-Porto Alegre-RS**  
Tel (0512) 22-2998, 22-5621  
Cable: HEWPACK porto Alegre

**BRAZIL**  
Hewlett-Packard do Brasil L.C. Ltda  
Avenida Rio Negro, 980  
Alphaville  
06400, Barro Preto, **Sao Paulo**  
Tel 429-2148-9, 429-2118-9  
Hewlett-Packard do Brasil L.C. Ltda  
Rua Padre Chagas, 32  
**90000-Porto Alegre-RS**  
Tel (0512) 22-2998, 22-5621  
Cable: HEWPACK porto Alegre

**BRAZIL**  
Hewlett-Packard do Brasil L.C. Ltda  
Avenida Rio Negro, 980  
Alphaville  
06400, Barro Preto, **Sao Paulo**  
Tel 429-2148-9, 429-2118-9  
Hewlett-Packard do Brasil L.C. Ltda  
Rua Padre Chagas, 32  
**90000-Porto Alegre-RS**  
Tel (0512) 22-2998, 22-5621  
Cable: HEWPACK porto Alegre

**BRAZIL**  
Hewlett-Packard do Brasil L.C. Ltda  
Avenida Rio Negro, 980  
Alphaville  
06400, Barro Preto, **Sao Paulo**  
Tel 429-2148-9, 429-2118-9  
Hewlett-Packard do Brasil L.C. Ltda  
Rua Padre Chagas, 32  
**90000-Porto Alegre-RS**  
Tel (0512) 22-2998, 22-5621  
Cable: HEWPACK porto Alegre

**BRAZIL**  
Hewlett-Packard do Brasil L.C. Ltda  
Avenida Rio Negro, 980  
Alphaville  
06400, Barro Preto, **Sao Paulo**  
Tel 429-2148-9, 429-2118-9  
Hewlett-Packard do Brasil L.C. Ltda  
Rua Padre Chagas, 32  
**90000-Porto Alegre-RS**  
Tel (0512) 22-2998, 22-5621  
Cable: HEWPACK porto Alegre

**BRAZIL**  
Hewlett-Packard do Brasil L.C. Ltda  
Avenida Rio Negro, 980  
Alphaville  
06400, Barro Preto, **Sao Paulo**  
Tel 429-2148-9, 429-2118-9  
Hewlett-Packard do Brasil L.C. Ltda  
Rua Padre Chagas, 32  
**90000-Porto Alegre-RS**  
Tel (0512) 22-2998, 22-5621  
Cable: HEWPACK porto Alegre

**BRAZIL**  
Hewlett-Packard do Brasil L.C. Ltda  
Avenida Rio Negro, 980  
Alphaville  
06400, Barro Preto, **Sao Paulo**  
Tel 429-2148-9, 429-2118-9  
Hewlett-Packard do Brasil L.C. Ltda  
Rua Padre Chagas, 32  
**90000-Porto Alegre-RS**  
Tel (0512) 22-2998, 22-5621  
Cable: HEWPACK porto Alegre

**BRAZIL**  
Hewlett-Packard do Brasil L.C. Ltda  
Avenida Rio Negro, 980  
Alphaville  
06400, Barro Preto, **Sao Paulo**  
Tel 429-2148-9, 429-2118-9  
Hewlett-Packard do Brasil L.C. Ltda  
Rua Padre Chagas, 32  
**90000-Porto Alegre-RS**  
Tel (0512) 22-2998, 22-5621  
Cable: HEWPACK porto Alegre

**BRAZIL**  
Hewlett-Packard do Brasil L.C. Ltda  
Avenida Rio Negro, 980  
Alphaville  
06400, Barro Preto, **Sao Paulo**  
Tel 429-2148-9, 429-2118-9  
Hewlett-Packard do Brasil L.C. Ltda  
Rua Padre Chagas, 32  
**90000-Porto Alegre-RS**  
Tel (0512) 22-2998, 22-5621  
Cable: HEWPACK porto Alegre

**BRAZIL**  
Hewlett-Packard do Brasil L.C. Ltda  
Avenida Rio Negro, 980  
Alphaville  
06400, Barro Preto, **Sao Paulo**  
Tel 429-2148-9, 429-2118-9  
Hewlett-Packard do Brasil L.C. Ltda  
Rua Padre Chagas, 32  
**90000-Porto Alegre-RS**  
Tel (0512) 22-2998, 22-5621  
Cable: HEWPACK porto Alegre



# EUROPE, NORTH AFRICA AND MIDDLE EAST

<b>94 AUSTRIA</b> Hewlett-Packard Ges m b H Händelska 52 P.O. box 7 A-1205 Vienna Tel: (0222) 351621 to 27 Cable: HEWPAK Vienna Telex: 75923 hewpak a	<b>Belgium</b> Hewlett-Packard Benelux S.A. v.v. Avenue de Col-Vert, 1 (Groenkraaglaan) B-1170 Brussels Tel: (02) 672 22 46 Cable: PALOEN Brussels Telex: 23 494 paloben brn	<b>CYPRUS</b> Kyproucs 19, Giorgiouos & Xeropoulos Rd P.O. Box 1152 CY-Nicosia Tel: 45628-29 Cable: KYPTRONICS PANDEHIS Telex: 3016	<b>CZECHOSLOVAKIA</b> Vývojová a Průmyslová Závádna Výzkumných Ústavů v Bechovicích CSSR 25097 Bechovice u Prahy Tel: 89 93 41 Telex: 121333	<b>France</b> Hewlett-Packard France Agence Régionale Le Saquin Chêne des Moulins B.P. 162 F-69130 Ecully Tel: (078) 23 25 Cable: HEWPAKFCU Telex: 31 06 17	<b>Germany</b> Hewlett-Packard France Agence Régionale Pérenité de la Cadrère Chêne de la Cadrère, 20 F-31300 Toulouse-Le Mirail Tel: (61) 40 11 32 Cable: HEWPAK 51957 Telex: 519957	<b>Greece</b> Hewlett-Packard France Agence Régionale Aéroport international de Marseille-Margonville F-13727 Margonville Tel: (91) 89 12 36 Cable: HEWPAK MARGN Telex: 410770	<b>Italy</b> Hewlett-Packard France Agence Régionale C3, Avenue de Rochester F-11714 Rennes Tel: (99) 36 33 21 Cable: HEWPAK 74912 Telex: 749912	<b>Spain</b> Hewlett-Packard France Agence Régionale 74, Avenue de la Robertsau F-67000 Strasbourg Tel: (88) 35 23 20 21 Tel: 890141 Cable: HEWPAK STRBG Telex: 310431	<b>Denmark</b> Hewlett-Packard A/S Bakvej 52 DK-3460 Birkerød Tel: (02) 81 66 48 Cable: HEWPAK AS Telex: 166 40 hpas Hewlett-Packard A/S Navnvej 1 DK-9600 Silkeborg Tel: (06) 82 71 66 Telex: 866 40 hpa Cable: HEWPAK AS	<b>Finland</b> Hewlett-Packard Oy Nankkoursentie 5 P.O. Box 6 SF-00211 Helsinki 21 Tel: (90) 692 303 Cable: HEWPAK OY Helsinki Telex: 12 1563 HEWPA SF	<b>France</b> Hewlett-Packard France Quartier de Courcouronnes Boite Postale No 6 F-91401 Orsay Cedex Tel: (1) 907 78 25 Cable: HEWPAK Orsay Telex: 60046	<b>Hungary</b> Hewlett-Packard GmbH Technisches Büro Budapest Emanuel-Loefer-Str. 1 (Seestadt) D-4000 Düsseldorf 11 Tel: (0211) 59711 Telex: 085/86 533 hpsd d Hewlett-Packard GmbH Technisches Büro Hamburg Wendensilassen 23 D-2000 Hamburg 1 Tel: (040) 24 13 93 Cable: HEWPAKSA Hamburg Telex: 21 63 032 hpsd d	<b>Italy</b> Hewlett-Packard GmbH Technisches Büro Hannover Am Grossmarkt 6 D-3000 Hannover-Kleefeld 91 Tel: (0511) 46 60 81 Tel: (092) 44 3759 Hewlett-Packard GmbH Technisches Büro Nürnberg Neumeyer Str. 9D D-8500 Nürnberg Tel: (0911) 56 30 83-85 Telex: 6623 860 Hewlett-Packard GmbH Technisches Büro München Unterhachinger Strasse 28 ISAR Center D-81017 Ottobrunn Tel: (089) 601 30 61 7 Cable: HEWPAKSA München Telex: 05/4965 Hewlett-Packard GmbH Technisches Büro Berlin Kendall Strasse 2-4 D-1000 Berlin 30 Tel: (030) 24 90 86 Telex: 18 3405 hpsd d	<b>Spain</b> Hewlett-Packard Italia S.p.A. Via Pietro Micone 40 Lang. Via Vesentini I-51000 Padova Tel: (49) 66 48 88 Telex: 41612 Hewpack Medical only Hewlett-Packard Italiana S.p.A. Via S. Agnolino, 7 I-51010 Pisa Tel: (050) 2 32 04 Telex: 32946 via Milano Hewlett-Packard Italiana S.p.A. Via G. Arimondi 10 I-00143 Roma Tel: (06) 54 69 67 Telex: 61514 Cable: HEWPAKITA Roma Hewlett-Packard Italiana S.p.A. Corso Giovanni Lanza 94 I-10130 Torino Tel: (011) 682245-659908 Medical-Calculators Only Hewlett-Packard Italiana S.p.A. Via Principe Acaia 43 G-G I-95126 Catania Tel: (095) 37 05 04 Hewlett-Packard Italiana S.p.A. Via Amerigo Vesputcio, 9 I-80142 Napoli Tel: (081) 33 77 11 Hewlett-Packard Italiana S.p.A. Via E. Mass, 9-8 I-40137 Bologna Tel: (051) 30 78 87	<b>United Kingdom</b> Hewlett-Packard Ltd King Street Lane GB-Winnerish, Wokingham Berks, RG31 5AR Tel: (0734) 78 47 74 Telex: 647178-848179	<b>Italy</b> Hewlett-Packard Italiana S.p.A. Via Amerigo Vesputcio 2 Casella postale 3645 I-20100 Milano Tel: (2) 6251 (10 lines) Cable: HEWPAKITA Milano Telex: 32046 Hewlett-Packard Italiana S.p.A. Via Pietro Micone 40 Lang. Via Vesentini I-51000 Padova Tel: (49) 66 48 88 Telex: 41612 Hewpack Medical only Hewlett-Packard Italiana S.p.A. Via S. Agnolino, 7 I-51010 Pisa Tel: (050) 2 32 04 Telex: 32946 via Milano Hewlett-Packard Italiana S.p.A. Via G. Arimondi 10 I-00143 Roma Tel: (06) 54 69 67 Telex: 61514 Cable: HEWPAKITA Roma Hewlett-Packard Italiana S.p.A. Corso Giovanni Lanza 94 I-10130 Torino Tel: (011) 682245-659908 Medical-Calculators Only Hewlett-Packard Italiana S.p.A. Via Principe Acaia 43 G-G I-95126 Catania Tel: (095) 37 05 04 Hewlett-Packard Italiana S.p.A. Via Amerigo Vesputcio, 9 I-80142 Napoli Tel: (081) 33 77 11 Hewlett-Packard Italiana S.p.A. Via E. Mass, 9-8 I-40137 Bologna Tel: (051) 30 78 87	<b>Norway</b> Hewlett-Packard Norge A/S Nesveien 13 NO-149 N-1344 Høstun Tel: (02) 83 83 60 Telex: 16621 hpnas n <b>Poland</b> Biuro Informacji Technicznej Hewlett-Packard Ul. Sławkowska 2 00-950 Warszawa Tel: 39680-3351-87 Telex: 81 24 53 hpa pl URBAN Zakład Doswadczenia Budowy Aparatury Naukowej Ul. Krasnej Mady Narutowew 51-55 00-808 Warszawa Tel: 36190 Telex: 81 46 48 Zakład Naprawcze Szpiztu Medycznego Plac Koszowy Paryskiej 6 90-007 Lodz Tel: 334-41, 337-83 <b>Portugal</b> Telefónica-Empresa Técnica de Equipamentos Eletrónicos S.A. e Lda Rua Rodrigo da Fonseca 103 P.O. Box 2531 P-Lisbon 1 Tel: (59) 68 60 72 Cable: TELEFTRA Lisbon Telex: 12598 Medical only Mundial InterCambio Mundial de Comércio S.A. e Lda Av. A de Aguiar 138 P.O. Box 2761 P-Lisbon Tel: (19) 61 21 31 7 Cable: INTERCAMBIO Lisbon <b>Rumania</b> Hewlett-Packard Reprezentanta Bd. M. Balcescu 16 Bucharest Tel: 158023 13885 Telex: 10440 I.R. e C. Industria de Pentru Industria St. Regenerie Usinilor de Calcul Bd.ul. piol. Doinilei Pompei 6 Bucharest-Sectorul 2 Tel: 12 64 30 Cable: VISCOUNT Telex: 11716 <b>Saudi Arabia</b> Modern Electronic Establishment King Abdul Aziz Str. (Head office) P.O. Box 1228 Jeddah Tel: 31173-332201 Cable: ELECTRA P.O. Box 2728 (Service center) Riyadh Tel: 62596-66232 Cable: RAOUFCI <b>Spain</b> Hewlett-Packard Española S.A. Jerez No. 3 E-Madrid 16 Tel: (1) 458 26 00 (10 lines) Telex: 23515 hps e Hewlett-Packard Española S.A. Málaga 21-23 E-Barcelona 17 Tel: (93) 203 6200 (15 lines) Telex: 52603 hpsde e Hewlett-Packard Española S.A. Av. Ramón y Cajal 1 Edificio Sevilla, planta 9. E-Seville 5 Tel: 64 44 54 58	<b>Sweden</b> Hewlett-Packard Sverige AB Engelshvagen 1-3 Fack S-161 29 Bromma 20 Tel: (08) 730 05 50 Cable: MEASUREMENTS Stockholm Tel: 10721 Hewlett-Packard Sverige AB Ostra Vintergatan 22 S-702 40 Örebro Tel: (019) 14 07 20 Hewlett-Packard Sverige AB Frolingsgatan 30 S-41 203 Vastra Frolunda Tel: (031) 49 09 50 Telex: 10721 Via Birmania Office <b>Switzerland</b> Hewlett-Packard (Schweiz) AG Zürcherstrasse 20 P.O. Box 307 CH-8952 Schlieren-Zürich Tel: (91) 730 52 43/730 18 21 Cable: HPAG CH Telex: 53933 hpag ch Hewlett-Packard (Schweiz) AG Dübener Platz 19 CH-1219 Le Lignon-Geneva Tel: (022) 96 03 22 Cable: HEWPAKAG Geneva Telex: 27 333 hpag ch <b>Syria</b> Medical/Calculator only Sawah & Co Place Arna B.P. 2308 SYR-Damascus Tel: 16367, 19697, 14268 Cable: SAWAH, Damascus Telex: 31583 <b>Turkey</b> Teknik Engineering Bureau P.O. Box 437 Beyluhu IR-Istanbul Tel: 49 40 40 Cable: TELEMTION Istanbul Telex: 25609 Medical only E. M. Muhendislik Kolektif Sirketi Adakale Sokak 41/6 TR-Ankara Tel: 175622 Analytical only Kiyas Ozyurek Muh. Mustafa Cad. No. 16/6 Kizilay TR-Ankara Tel: 25 03 09 Telex: 42576 Ozek tr <b>United Kingdom</b> Hewlett-Packard Ltd King Street Lane GB-Winnerish, Wokingham Berks, RG31 5AR Tel: (0734) 78 47 74 Cable: Hewlett London Telex: 647178-8 Hewlett-Packard Ltd Tadcaster House Navigation Road Atrincham Cheshire WA14 1NU Tel: (061) 926 6422 Cable: Hewpac Manchester Telex: 669068	<b>Hungary</b> Hewlett-Packard Ltd Lynon Court Breward Pass Drooley Road Halesowen West Midlands B62 8SD Tel: (021) 550 9911 Telex: 339105 Hewlett-Packard Ltd 610 Makro South Servicevehicles Centre Wear Industrial Estate Washington GB-New Town, County Durham Tel: Washington 454001 ext 57/58 Hewlett-Packard Ltd 10, Westley St GB-Castleford West Yorkshire WF10 1AE Tel: (01975) 50402 Telex: 557355 Hewlett-Packard Ltd 11, Wallace Way GB-Hitchin Herts Tel: (0452) 52824/56704 Telex: 825981 <b>USSR</b> Hewlett-Packard Representative Office USSR Pobedy Proletariats 4-17 KW 17 Moscow 101000 Tel: 294-2024 Telex: 7825 hewpak u <b>Yugoslavia</b> Ipsko-standard/Hewlett-Packard Mikloveska 38/VII 61000 Ljubljana Tel: 31 58 793/2 16 74 Telex: 31583	<b>Socialist Countries NOT SHOWN PLEASE CONTACT</b> Hewlett-Packard Ges m b H P.O. Box 7 A-1205 Vienna, Austria Tel: (0222) 35 16 23 to 27 Cable: HEWPAK Vienna Telex: 75923 hewpak a <b>Middle Eastern and Middle East Countries NOT SHOWN PLEASE CONTACT</b> Hewlett-Packard S.A. Mediterranean and Middle East Operations 35, Kerkiras Street P.O. Box 104 GR-Kifissia, Athens, Greece Tel: 8080537/359-429 Telex: 21 4588 Cable: HEWPAKSA Athens <b>FOR OTHER AREAS NOT LISTED CONTACT</b> Hewlett-Packard S.A. 7, rue de Bressou-Lan P.O. Box CH-1217 Meyrin 2 Geneva Switzerland Tel: (022) 82 70 00 Cable: HEWPAKSA Geneva Telex: 7 24 86
--	--	--	--	--	---	--	---	--	--	---	--	--	---	---	--	--	---	--	--	---

# UNITED STATES

<b>ALABAMA</b> 8290 Whitesburg Dr. S.E. P.O. Box 4207 Huntsville 35802 Tel: (205) 881-4591 Medical Only 728 W. Valley Ave. N Room 226 Birmingham 35209 Tel: (205) 942-2081 2	<b>Arizona</b> 2336 E. Marmonia St Phoenix 85034 Tel: (602) 244-1361 2424 East Aragon Rd Tucson 85706 Tel: (602) 294-3148 <b>Arkansas</b> Medical Service Only P.O. Box 5646 Boody Station Little Rock 72205 Tel: (501) 376-1844 <b>California</b> 1430 East Orangehorpe Ave Fullerton 92631 Tel: (714) 670-1000 3939 Lankershue Boulevard North Hollywood 91604 Tel: (818) 777-1282 TXW 916-499-2671 5305 Arizona Place Los Angeles 90045 Tel: (213) 649-2511 TXW 916-328-6147 <b>Los Angeles</b> Tel: (213) 776-7500 3003 Scott Boulevard Santa Clara 95050 Tel: (408) 249-7000 TXW 910-338-0519 <b>Ridgcrest</b> Tel: (714) 446-6165 646 W. North Market Blvd Sacramento 95834 Tel: (916) 929-7222	<b>Colorado</b> 5690 South Utelet Parkway Englewood 80110 Tel: (303) 771-3455 <b>CONNECTICUT</b> 12 Lumar Drive New Haven 06525 Tel: (203) 399-6551 TXW 719-465-2929 <b>FLORIDA</b> P.O. Box 24210 2806 W. Oakland Park Blvd Ft. Lauderdale 33311 Tel: (305) 731-2026 <b>Jacksonville</b> Medical Service Only P.O. Box 13910 6177 Lake Ellenor Dr. Orlando 32809 Tel: (305) 859-2906 P.O. Box 12826 Pensacola 32575 Tel: (904) 476-8422 <b>GEORGIA</b> P.O. Box 105005 Atlanta 30348 Tel: (404) 855-1500 TXW 810-766-4890 Medical Service Only *Augusta 30905 Tel: (404) 736-6982 P.O. Box 2103 Warner Robins 31098 Tel: (912) 922-0449 <b>HAWAII</b> 2675 So. King Street Honolulu 96814 Tel: (808) 955-4455 Telex: 723 705	<b>ILLINOIS</b> 5201 Tollview Dr Rolling meadows 60008 Tel: (312) 255-9800 TXW 910-687-2260 <b>INDIANA</b> 7301 North Sidelake Drive Indianapolis 46236 Tel: (317) 842-1090 TXW 816-260-1957 <b>KENTUCKY</b> Medical Only Atkinson Square 3901 Atkinson Dr Shelby 40218 Tel: (502) 456-1573 <b>LOUISIANA</b> P.O. Box 640 3229-39 Williams Boulevard Kenner 70063 Tel: (504) 443-6201 <b>MARYLAND</b> 6707 Whitestone Road Baltimore 21207 Tel: (301) 944-5400 TXW 710-862-9157 2 Choike Cherry Road Rockville 20850 Tel: (301) 948-0370 TXW 710-828-9684 <b>MASSACHUSETTS</b> 32 Hawthorn Ave Lexington 02173 Tel: (617) 861-8960 TXW 710-326-6904 <b>MICHIGAN</b> 2385 Research Drive Farmington Hills 48324 Tel: (313) 478-6400	<b>MINNESOTA</b> 5201 Prior Ave St. Paul 55113 Tel: (612) 636-0700 <b>MISSISSIPPI</b> *Jackson Medical Service Only Tel: (601) 982-9363 <b>MISSOURI</b> 11331 Colostate Ave Kansas City 64137 Tel: (816) 763-8000 TXW 910-771-2087 148 Weidon Parkway Maryland Heights 63043 Tel: (314) 967-1455 TXW 910-764-0833 <b>NEBRASKA</b> Medical Only 7171 Mercy Road South 68106 Tel: (402) 392-6948 <b>NEW JERSEY</b> W. 120 Century Rd Paramus 07652 Tel: (201) 265-5600 TXW 910-990-4951 Crystal Brook Professional Building Eatontown 07724 Tel: (201) 542-1394 <b>NEW MEXICO</b> P.O. Box 11632 Stations E 11300 Lomas Blvd. N.E. Albuquerque 87123 Tel: (505) 252-1330 TXW 910-989-1185 156 Wyatt Drive Las Cruces 88001 Tel: (955) 526-2484 TXW 910-983-0550	<b>NEW YORK</b> 6 Automation Lane Computer Park Albany 12205 Tel: (518) 458-1550 201 South Avenue Poughkeepsie 12601 Tel: (914) 454-7330 TXW 510-253-5981 39 Saginaw Drive Rochester 14673 Tel: (716) 473-9600 TXW 510-253-5981 5856 East Molloy Road Syracuse 13211 Tel: (315) 454-2486 TXW 710-541-0482 1 Crossways Park West Woodbury 11797 Tel: (516) 921-0300 TXW 710-990-4951 <b>NORTH CAROLINA</b> P.O. Box 5188 1923 North Main Street High Point 27652 Tel: (919) 885-8101 <b>OHIO</b> 10506 Sprague Road Cleveland 44130 Tel: (216) 243-7300 TXW 810-423-9430 330 Progress Rd Dayton 45449 Tel: (513) 859-8202 1041 Kingsmill Parkway Columbus 43279 Tel: (614) 436-1041 <b>OKLAHOMA</b> P.O. Box 32008 Oklahoma City 73132 Tel: (405) 771-0200 <b>OREGON</b> 17890 SW Lower Boones Ferry Road Tualatin 97062 Tel: (503) 620-3350	<b>PENNSYLVANIA</b> 111 Zeta Drive Pittsburgh 15238 Tel: (412) 782-0400 1021 8th Avenue King of Prussia Industrial Park King of Prussia 19406 Tel: (610) 265-7006 TXW 510-660-2670 <b>SOUTH CAROLINA</b> 6941 N. L. Trentholm Road Columbia 29260 Tel: (803) 786-6493 <b>TENNESSEE</b> * Knoxville Medical Service Only Tel: (615) 523-5922 1473 Madison Avenue Memphis 38104 Tel: (901) 274-7472 <b>Nashville</b> Medical Service Only Tel: (615) 244-5448 <b>TEXAS</b> P.O. Box 1270 201 F. Arapaho Rd Richardson 75080 Tel: (214) 231-6101 P.O. Box 27409 8300 Westpark Drive Houston 77057 Tel: (713) 781-6000 205 Billy Mitchell Road San Antonio 78226 Tel: (512) 434-8241 <b>UTAH</b> 2160 South 3270 West Street Salt Lake City 84119 Tel: (801) 487-0715	<b>VIRGINIA</b> P.O. Box 12778 No. 7 Roger Exec. Center Suite 217 Norfolk 23502 Tel: (804) 461-4025-6 P.O. Box 9669 2914 Huntington Springs Road Richmond 23288 Tel: (804) 285-3431 <b>WASHINGTON</b> Bellefield Office Plc 1203-114th Ave. S.E. Bellevue 98004 Tel: (206) 454-3971 TXW 910-443-2446 <b>*WEST VIRGINIA</b> Medical-Analytical Only Charleston Tel: (304) 345-1640 <b>WISCONSIN</b> 9604 West Lincoln Ave West Allis 53227 Tel: (414) 541-6550 <b>FOR U.S. AREAS NOT LISTED</b> Contact the regional office nearest you. Atlanta, Geneva, North Hollywood, Canton, MA, Rockville, Maryland, Rolling Meadows, Illinois. Their complete addresses are listed above. <b>*Service Only</b>
---	--	---	--	--	--	---	--



**BUSINESS REPLY MAIL**

NO POSTAGE STAMP NECESSARY IF MAILED IN THE UNITED STATES

POSTAGE WILL BE PAID BY

HEWLETT-PACKARD  
CALCULATOR PRODUCTS DIVISION  
POST OFFICE BOX 301  
LOVELAND, COLORADO 80537 U.S.A.

ATTN: Calculator Customer Support

FIRST CLASS  
PERMIT NO. 37  
LOVELAND, COLO.



## Free Manuals Download Website

<http://myh66.com>

<http://usermanuals.us>

<http://www.somanuals.com>

<http://www.4manuals.cc>

<http://www.manual-lib.com>

<http://www.404manual.com>

<http://www.luxmanual.com>

<http://aubethermostatmanual.com>

Golf course search by state

<http://golfingnear.com>

Email search by domain

<http://emailbydomain.com>

Auto manuals search

<http://auto.somanuals.com>

TV manuals search

<http://tv.somanuals.com>