

HP Designjet T1100 Printer Series Using your printer

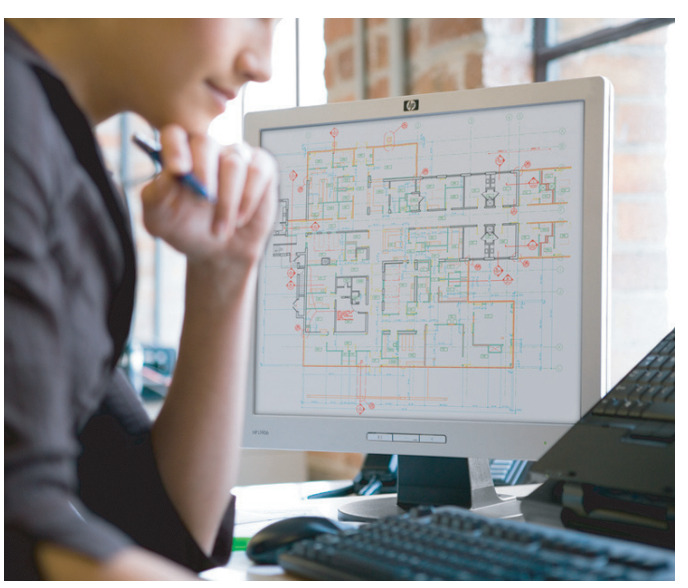

HP Designjet T1100 printer series

Using your printer



Legal notices

© 2007 Hewlett-Packard Development Company, L.P.

The information contained herein is subject to change without notice.

The only warranties for HP Products and services are set forth in the express warranty statement accompanying such products and services. Nothing herein should be construed as constituting an additional warranty. HP shall not be liable for technical or editorial errors or omissions contained herein.

Trademarks

Adobe®, Acrobat®, Adobe Photoshop®, and Adobe® PostScript® 3™ are trademarks of Adobe Systems Incorporated.

Corel® is a trademark or registered trademark of Corel Corporation or Corel Corporation Limited.

Energy Star® is a U.S. registered mark of the United States Environmental Protection Agency.

Microsoft® and Windows® are U.S. registered trademarks of Microsoft Corporation.

PANTONE® is Pantone, Inc.'s check-standard trademark for color.

Table of contents

1 Introduction

Safety precautions	2
HP Start-Up Kit	2
Using this guide	2
Introduction	2
Use and maintenance	3
Troubleshooting	3
Accessories, support, and specifications	3
Glossary	3
Index	3
Warnings and Cautions	3
The printer's main features	4
The printer's main components	4
Front view	5
Rear view	6
The front panel	6
Printer software	8
The printer's internal prints	8

2 Installing the software

Choose which connection method to use	12
Connect to a network (Windows)	12
Connect directly to a computer (Windows)	13
Printer sharing considerations	14
Uninstall the printer software (Windows)	14
Connect to a network (Mac OS)	14
Bonjour/Rendezvous connection	14
TCP/IP connection	16
Connect directly to a computer (Mac OS)	18
Sharing the printer	19
Uninstall the printer software (Mac OS)	19

3 Setting up the printer

Introduction	22
Handle paper conflicts	22
Turn nesting on and off	22
Turn usage information on and off	23
Turn alerts on and off	24
Set or delete the security password	24
Require account ID	25
Set Windows driver preferences	25

4 Personalizing the printer

Turn the printer on and off	28
Change the language of the front-panel display	29
Access HP Easy Printer Care (Windows) or HP Printer Utility (Mac OS)	29
Access the Embedded Web Server	30
Change the language of HP Easy Printer Care (Windows) or HP Printer Utility (Mac OS)	30
Change the language of the Embedded Web Server	30
Change the sleep mode setting	31
Turn the buzzer on and off	31
Change the front-panel display contrast	31
Change the units of measurement	31
Configure network settings	31
Change the graphic language setting	32

5 Paper handling

General advice	36
Load a roll onto the 24-inch spindle	36
Load a roll onto the 44-inch spindle	38
Load a roll into the 24-inch printer	41
Easy loading procedure	41
Paper menu procedure	44
Load a roll into the 44-inch printer	45
Easy loading procedure	45
Paper menu procedure	48
Unload a roll	49
Unload paper key procedure with paper on the roll	49
Paper menu procedure with paper on the roll	49
Roll out of paper procedure	50
Load a single sheet	50
Easy loading procedure	51
Paper menu procedure	52
Unload a single sheet	53
Unload paper key procedure	54
Paper menu procedure	54
View information about the paper	54
Paper profiles	55
Print on loaded paper	55
Maintain paper	55
Change the drying time	56
Turn the automatic cutter on and off	56
Feed and cut the paper	56

6 Printing

Create a print job	60
Using the Embedded Web Server to print files	60
Select print quality	61
Select paper size	61
Custom paper sizes	62
Select margins options	62
Print with shortcuts	63
Rescale a print	64
Change the treatment of overlapping lines	65
Preview a print	65

Print a draft	66
High-quality printing	66
If you have a high-resolution image	67
Print in gray shades	67
Print with no margins	67
Print with crop lines	68
Use paper economically	69
Nest jobs to save roll paper	69
When does the printer try to nest pages?	69
What pages can be nested?	70
Which pages qualify for nesting?	70
How long does the printer wait for another file?	70
Use ink economically	70

7 Color management

Introduction	74
How colors are represented	74
A summary of the color management process	74
Color calibration	74
Color management from printer drivers	75
Color management options	76
Printer emulation	76
Color adjustment options	77
Printing in color	77
Printing in grayscale	78
Color management from printer drivers (T1100ps only)	78
HP Professional PANTONE Emulation	78
Color emulation	79
CMYK color emulation	79
RGB color emulation	80
Color management from the Embedded Web Server	80
Submit Job options	80
Rendering intent	81
Perform black point compensation	81
Printing PANTONE swatch books	81
Color management from the front panel	82

8 Practical printing examples

Print a draft for revision with the correct scale	86
Using Adobe Acrobat	86
Print a project	88
Using Autodesk Design Review	88
Using Windows Explorer to print Autodesk Design Review files	89
Using AutoCAD	90
Using the Embedded Web Server to submit files	95
Using printer emulation	95
Using clip contents by margins	96
Print a presentation	96
Using AutoCAD	96
Using Adobe Photoshop	100
Print and scale from Microsoft Office	103
Using PowerPoint	104
Using Project	105

Using Excel	107
-------------------	-----

9 Job queue management

Job queue page	110
Job preview	110
Turn off the job queue	111
Select when to print a job in the queue	111
Identify a job in the queue	111
Prioritize a job in the queue	112
Delete a job from the queue	112
Reprint or copy a job in the queue	112
Job status messages	113
Remove a hold	113

10 Retrieving printer usage information

Get printer accounting information	116
Check printer usage statistics	116
Printer statistics with HP Easy Printer Care (Windows) or HP Printer Utility (Mac OS)	116
Printer statistics with the Embedded Web Server	116
Check ink and paper usage for a job	116
Ink and paper statistics with HP Easy Printer Care (Windows) or HP Printer Utility (Mac OS)	116
Ink and paper statistics with the Embedded Web Server	117

11 Handling ink cartridges and printheads

About the ink cartridges	120
Check the ink cartridges status	120
Ink menu procedure	120
HP Easy Printer Care (Windows) or HP Printer Utility (Mac OS) procedures	120
Remove an ink cartridge	121
Insert an ink cartridge	122
About the printheads	123
Check the printhead status	124
Remove a printhead	124
Insert a printhead	127

12 Maintaining the printer

Check printer status	132
Clean the exterior of the printer	132
Replace the cutter	132
Maintain the ink cartridges	137
Move or store the printer	137
Update the firmware	138
Update the software	138
Printer maintenance kits	138
Secure Disk Erase	139

13 Accessories

How to order supplies and accessories	142
Order ink supplies	142
Order paper	142

Order accessories	145
Introduction to the accessories	146
Stand	146
Spindle	146
Jetdirect print server	146

14 Troubleshooting paper issues

The paper cannot be loaded successfully	148
General unsuccessful roll load issues	148
Unsuccessful roll load with 24-inch printer	148
Unsuccessful roll load with 44-inch printer	149
Unsuccessful sheet load	149
Paper loading error messages	149
The paper type is not in the driver	150
Transparent or translucent paper	150
Glossy paper	150
Matte Paper	150
General purpose paper	151
Photographic paper	151
HP Banners with Tyvek®	151
Black ink is easily removed when touched	151
After printing, the paper has wrinkles or there is too much ink	151
The paper has jammed	152
The printer displays out of paper when paper is available	154
Prints do not fall nicely into the basket	154
The sheet stays in the printer when the print has been completed	154
The paper is cut when the print has been completed	155
The cutter does not cut well	155
The roll is loose on the spindle	155
A strip stays on the output tray and generates jams	155
Recalibrate the paper advance	155
Recalibrating the paper advance procedure	156
Return to default calibration	157

15 Troubleshooting print-quality issues

General advice	160
Print quality troubleshooting wizard	160
Horizontal lines across the image (banding)	161
Lines are too thick, too thin, or missing	162
Lines appear stepped or jagged	162
Lines print double or in the wrong colors	163
Lines are discontinuous	164
Lines are blurred	165
Line lengths are inaccurate	165
The whole image is blurry or grainy	166
The paper is not flat	166
The print is scuffed or scratched	167
Ink marks on the paper	167
Horizontal smears on the front of coated paper	167
Ink marks on the back of the paper	168
Black ink comes off when you touch the print	168
Edges of objects are stepped or not sharp	168
Edges of objects are darker than expected	169

Horizontal lines at the end of a cut sheet print	169
Vertical lines of different colors	169
White spots on the print	169
Colors are inaccurate	170
Color accuracy using EPS or PDF images in page layout applications	170
Colors are fading	171
The image is incomplete (clipped at the bottom)	171
The image is clipped	171
Some objects are missing from the printed image	172
A PDF file is clipped or objects are missing	172
The Image Diagnostics Print	172
Corrective action	174
If you still have a problem	175

16 Troubleshooting ink cartridge and printhead issues

Cannot insert an ink cartridge	178
Ink cartridge status messages	178
Cannot insert a printhead	178
The front-panel display recommends reseating or replacing a printhead	179
Clean the printheads	179
Clean the printhead drop detector	180
Align the printheads	182
Reinsert printheads procedure	183
Image Quality Maintenance menu procedure	183
Scanning errors during alignment	184
Printhead status messages	184

17 Troubleshooting general printer issues

The printer does not print	186
The printer seems slow	186
The printer printed on undesirable paper	186
Communication failures between computer and printer	187
Cannot access HP Easy Printer Care (Windows) or HP Printer Utility (Mac OS)	187
Cannot access the Embedded Web Server	188
Automatic file system check	188
An AutoCAD 2000 memory allocation error	189
No output when printing from Microsoft Visio 2003	189
Unavailable driver features when printing from QuarkXpress	189
Printer alerts	190

18 Front-panel error messages

19 HP Customer Care

Introduction	194
HP Professional Services	194
Knowledge Center	194
HP Start-Up Kit	194
HP Care Packs and Warranty Extensions	194
HP Installation	195
HP Instant Support	195
HP Proactive Support	195
Contact HP Support	196
Telephone numbers	196

20 Printer specifications

Functional specifications	200
Physical specifications	201
Memory specifications	201
Power specifications	201
Ecological specifications	201
Environmental specifications	202
Acoustic specifications	202

Glossary	203
-----------------------	------------

Index	205
--------------------	------------

1 Introduction

- [Safety precautions](#)
- [HP Start-Up Kit](#)
- [Using this guide](#)
- [The printer's main features](#)
- [The printer's main components](#)
- [The front panel](#)
- [Printer software](#)
- [The printer's internal prints](#)

Safety precautions

The following precautions ensure the proper use of the printer and prevent the printer from being damaged. Follow these precautions at all times.

- Use the power supply voltage specified on the nameplate. Avoid overloading the printer's electrical outlet with multiple devices.
- Ensure the printer is well-grounded. Failure to ground the printer may result in electrical shock, fire, and susceptibility to electromagnetic interference.
- Do not disassemble or repair the printer yourself. Contact your local HP Service Representative for service, see [Contact HP Support on page 196](#).
- Use only the electrical cord supplied by HP with the printer. Do not damage, cut, or repair the power cord. A damaged power cord has risk of fire and electric shock. Replace a damaged power cord with an HP-approved power cord.
- Do not allow metal or liquids (except those used in HP Cleaning Kits) to touch the internal parts of the printer. Doing so may cause fire, electric shock, or other serious hazards.
- Power OFF the printer and unplug the power cable from the power outlet in any of the following cases:
 - When placing your hands inside the printer
 - If there is smoke or an unusual smell coming from the printer
 - If the printer is making an unusual noise not heard during normal operation
 - A piece of metal or a liquid (not part of cleaning and maintenance routines) touches internal parts of the printer
 - During an electrical (thunder/lightning) storm
 - During a power failure.

HP Start-Up Kit

The HP Start-Up Kit is the CD or DVD that comes with your printer; it contains the printer's software and documentation, including introductory multimedia tutorials to help you to get a good first print.



NOTE: The HP Start-Up Kit is provided on CD in Japan, and on DVD elsewhere in the world. The rest of this guide will refer to the DVD version only.

Using this guide

Using your printer (on DVD) and the *Quick Reference Guide* (on paper) are organized into the following chapters. The most complete source of information is *Using your printer*.

Introduction

This chapter provides a brief introduction to the printer and its documentation for new users.

Use and maintenance

These chapters help you carry out normal printer procedures and include the following topics.

- [Installing the software on page 11](#)
- [Setting up the printer on page 21](#)
- [Personalizing the printer on page 27](#)
- [Paper handling on page 35](#)
- [Printing on page 59](#)
- [Color management on page 73](#)
- [Practical printing examples on page 85](#)
- [Job queue management on page 109](#)
- [Retrieving printer usage information on page 115](#)
- [Handling ink cartridges and printheads on page 119](#)
- [Maintaining the printer on page 131](#)

Troubleshooting

These chapters help you solve problems that may occur while printing and include the following topics.

- [Troubleshooting paper issues on page 147](#)
- [Troubleshooting print-quality issues on page 159](#)
- [Troubleshooting ink cartridge and printhead issues on page 177](#)
- [Troubleshooting general printer issues on page 185](#)
- [Front-panel error messages on page 191](#)

Accessories, support, and specifications

These chapters, [Accessories on page 141](#), [HP Customer Care on page 193](#), and [Printer specifications on page 199](#), contain reference information, including customer care, the printer specifications, and part numbers for paper types, ink supplies, and accessories.

Glossary

The [Glossary on page 203](#) contains definitions of printing and HP terms used in this documentation.

Index

In addition to the table of contents, there is an alphabetical index to help you to find topics quickly.

Warnings and Cautions

The following symbols are used in this manual to ensure the proper use of the printer and to prevent the printer from being damaged. Follow the instructions marked with these symbols.



WARNING! Failure to follow the guidelines marked with this symbol could result in serious personal injury or death.



CAUTION: Failure to follow the guidelines marked with this symbol could result in minor personal injury or damage to the product.

The printer's main features

Your printer is a color inkjet printer designed for printing high-quality images on paper up to 24 inches (61 cm) or 44 inches (1.12 m) wide depending on your printer's width. Some major features of the printer are shown below:

- Print resolution of up to 2400 × 1200 optimized dpi, from a 1200 × 1200 dpi input, using the **Best** print-quality option, the **Maximum Detail** option, and photo paper
- HP Easy Printer Care (Windows) and HP Printer Utility (Mac OS), see [Access HP Easy Printer Care \(Windows\) or HP Printer Utility \(Mac OS\) on page 29](#), provide an easy-to-use interface including:
 - Job management, see [Job queue management on page 109](#)
 - Calibration of printer
 - Access to the online HP Knowledge Center
- Accurate and consistent color reproduction with automatic color calibration
- Economode for printing economically
- Six-ink system
- Color emulations, see [Printer emulation on page 76](#)
- High productivity features such as job previewing and nesting using HP Easy Printer Care (Windows) or HP Printer Utility (Mac OS) or the printer's Embedded Web Server
- Ink and paper usage information available from the Web from the Embedded Web Server, see [Access the Embedded Web Server on page 30](#)
- Paper flexibility and automatic easy load, see [Paper handling on page 35](#), with information and profiles accessible from the front panel, HP Easy Printer Care (Windows), and HP Printer Utility (Mac OS)

The printer's main components

The following front and rear views of the printer illustrate the main components.

Front view

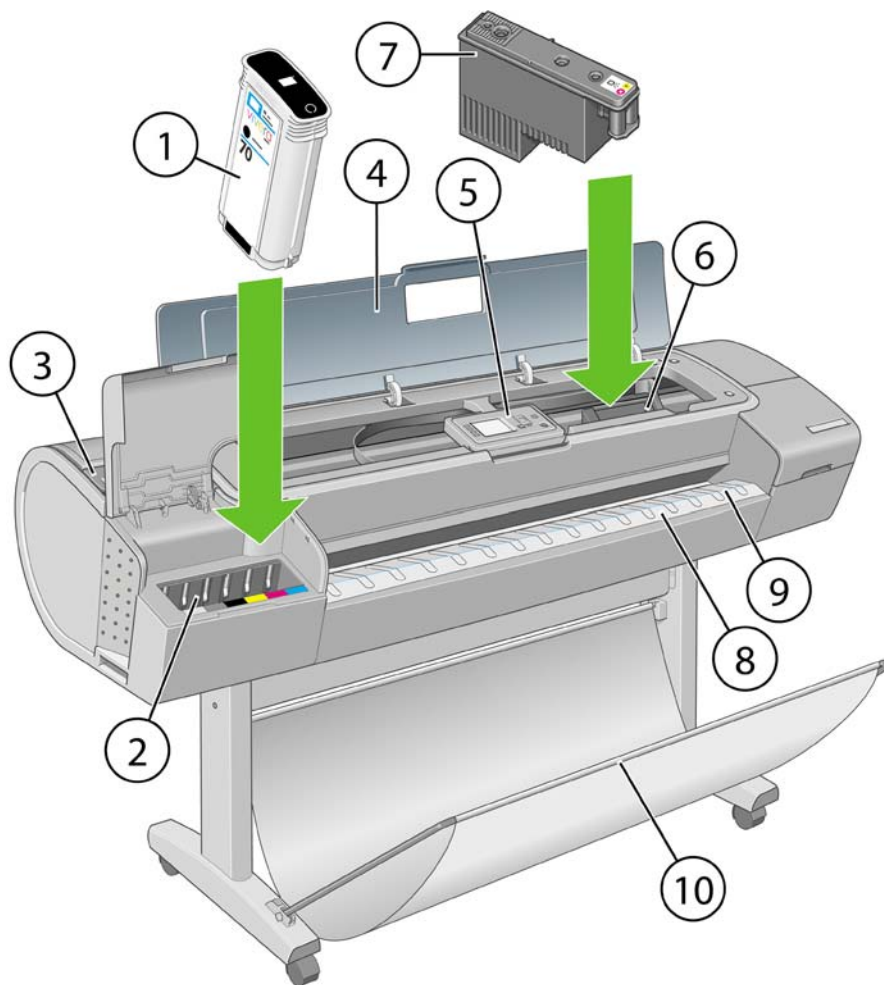

1. Ink cartridge
2. Ink cartridge slots
3. Blue lever
4. Window
5. Front panel
6. Printhead carriage
7. Printhead
8. Output tray
9. Paper alignment lines
10. Basket

Rear view

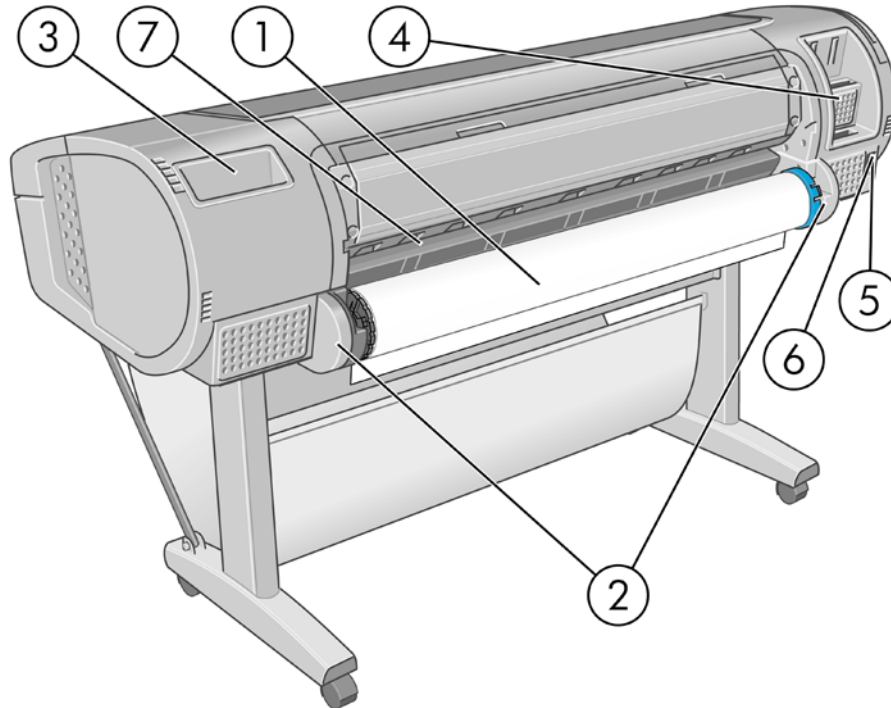

1. Spindle
2. Spindle holders
3. Quick Reference Guide holder
4. Sockets for communication cables and optional accessories
5. Hard power switch
6. Power cord plug in
7. Paper feeder

The front panel



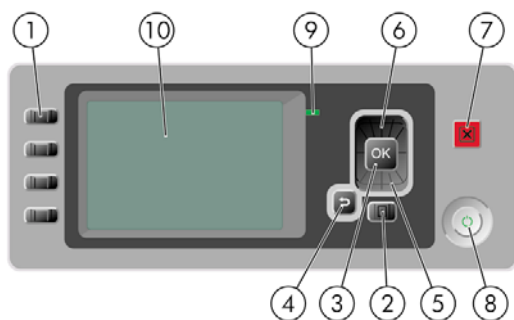

Your printer's front panel is located on the front of the printer, in the center. It has the following important functions:

- Assists you in troubleshooting issues
- Is used to perform certain procedures, such as cutting and unloading paper
- Displays helpful animations to guide you through procedures
- Displays up-to-date information about the status of the printer such as, the ink cartridges, the printheads, the paper, and the print jobs
- Displays warning and error messages, when appropriate, along with audio alerts to call attention to a warning or message
- Can be used to change the values of printer settings and thus change the operation of the printer. However, settings in the front panel are overridden by settings in the printer drivers, see [Installing the software on page 11](#)



The front panel has the following components:

1. **Direct access** keys:

- First key : View ink levels, see [Check the ink cartridges status on page 120](#)
- Second key : View loaded paper, see [View information about the paper on page 54](#)
- Third key : Unload paper, see [Unload a roll on page 49](#) and [Unload a single sheet on page 53](#)
- Fourth key : Form feed and cut, see [Feed and cut the paper on page 56](#)

2. **Menu** key - Press to return to the main menu of the front-panel display. If you are already on the main menu it will display the status screen.
3. **OK** key - To confirm an action while in a procedure or interaction. To enter in a submenu in the menu. To select a value when given an option.
4. **Back** key - To go to the previous step in a procedure or interaction. To go to the upper level, or leave the option in the menu, or when given an option.
5. **Down** key - To go down in a menu or option, or to decrease a value, for example when configuring the front-panel display contrast or the IP address.
6. **Up** key - To go up in a menu or option, or to increase a value, for example when configuring the front-panel display contrast or the IP address.
7. **Cancel** key - To abort a procedure or interaction.
8. **Power** key - To turn the printer off or on, it also has a light to indicate the printer's status. If the power key light is off the printer is off. If the power key light is blinking green, the printer is starting up. If the power key light is green on, the printer is on. If the power key light is amber on, the printer is in standby. If the power key light is blinking amber, the printer needs attention.
9. **LED** light - Indicates the printer's status. If the LED light is solid green, the printer is ready. If it is flashing green, the printer is busy. If it is solid amber, there is a system error. If it is flashing amber, the printer needs attention.
10. **Front-panel display** - Displays errors, warnings, and information on using your printer.

To **highlight** an item in the front-panel display, press the **Up** or **Down** key until the item is highlighted.

To **select** an item in the front-panel display, first highlight it and then press the **OK** key.

When this guide shows a series of front-panel display items like this: **Item1 > Item2 > Item3**, it means that you should select **Item1**, then select **Item2**, then select **Item3**.

Information about specific uses of the front panel can be found throughout this guide.

Printer software

The following software is provided with your printer:

- The RTL and HP-GL/2 driver for Windows
- PostScript driver, for HP Designjet T1100ps only
- The PCL3 raster driver for T1100
- The HP Easy Printer Care (Windows) or HP Printer Utility (Mac OS), see [Access HP Easy Printer Care \(Windows\) or HP Printer Utility \(Mac OS\) on page 29](#), allows you to:
 - Manage the job queue, see [Job queue management on page 109](#)
 - Manage the printer including color with the HP Color Center
 - Access the HP Knowledge Center
 - View the status of the ink cartridges, the printheads, and the paper
 - View job accounting information, see [Retrieving printer usage information on page 115](#)
 - Update the printer's firmware, see [Update the firmware on page 138](#)
 - Change various printer settings (in the Settings tab)
 - Perform calibrations and troubleshooting
- The Embedded Web Server, runs in the printer and enables you to use a Web browser on any computer to check ink levels and printer status, see [Access the Embedded Web Server on page 30](#).
- Autodesk Design Review

The printer's internal prints

The internal prints give various kinds of information about your printer. They can be requested from the front panel without using a computer.



CAUTION: Before requesting any internal print, make sure that paper is loaded (roll or sheet), and that the front panel displays the **Ready** message. The loaded paper should be at least A3 landscape (16.53 in or 42 cm wide); otherwise the print may be clipped.

To print any internal print, press the **Menu** key to return to the main menu, select the Internal Prints

menu icon , then select the internal print you want. The following internal prints are available.

- Demo prints: show some of the capabilities of the printer
 - Print black and white photo
 - Print color photo
 - Print color design demo
 - Print GIS map



NOTE: Demo prints are printed the same size as the loaded paper .

- Menu map: shows details of all the front-panel display menus
- Configuration: shows all the current front-panel display settings
- Usage report: shows estimates of the total number of prints, number of prints by paper type, number of prints by print-quality option, and total amount of ink used per color (the accuracy of these estimates is not guaranteed)
- HP-GL/2 palette: shows the color or grayscale definitions in the currently selected color palette
- Service information: provides information needed by service engineers
- PostScript font list: shows PostScript fonts available, for HP Designjet T1100ps only

2 Installing the software

- [Choose which connection method to use](#)
- [Connect to a network \(Windows\)](#)
- [Connect directly to a computer \(Windows\)](#)
- [Uninstall the printer software \(Windows\)](#)
- [Connect to a network \(Mac OS\)](#)
- [Connect directly to a computer \(Mac OS\)](#)
- [Uninstall the printer software \(Mac OS\)](#)

Choose which connection method to use

The following methods can be used to connect your printer.

Connection type	Speed	Cable length	Other factors
Gigabit Ethernet	Very fast; varies according to network traffic	Long (100 m=328 ft.)	Requires extra equipment (switches).
Jetdirect print server (optional accessory)	Moderate; varies according to network traffic	Long (100 m = 328 ft)	Requires extra equipment (switches) Provides additional features See http://www.hp.com/go/jetdirect/ for more details
USB 2.0	Very fast	Short (5 m = 16 ft)	A certified USB 2.0 cable is necessary for reliable communication.



NOTE: The speed of any network connection depends on all components used in the network, which can include network interface cards, hubs, routers, switches, and cables. If any one of these components cannot operate at high speed, you will have a low-speed connection. The speed of your network connection can also be affected by the total amount of traffic from other devices on the network.

Connect to a network (Windows)

Before you begin, check your equipment:

- The printer should be set up and on.
- The Ethernet hub or router should be on and functioning correctly.
- All computers on the network should be on and connected to the network.
- The printer should be connected to the network.

Now you can proceed to install the printer software and connect your printer:

1. Make a note of the IP address from the status screen on the printer's front panel (192.168.1.1 in this example):

Ready for paper

http://XXXX11
http://192.168.1.1

Press  to enter menu



2. Insert the *HP Start-Up Kit* DVD into your computer. If the DVD does not start automatically, run the START.EXE program in the root folder of the DVD.

3. Click **Install**. The printer drivers, HP Easy Printer Care, and HP Color Center are installed.
4. Follow the instructions on your screen to set up the printer. The following notes help you to understand the screens and make appropriate choices.
 - When asked how the printer is connected, select **Wired Networking**.
 - The configuration program looks for printers connected to your network. When the search is complete, a list of printers appears. Identify your printer by its IP address and select it from the list.
 - The configuration program analyzes the network and the printer. The program detects the network settings and suggests the settings to use when configuring the printer. It is not normally necessary to change any of these settings, but you can do so if you wish.

If your computer fails to find any printers on the network, the **Printer Not Found** window is displayed, which helps you to try to find your printer. If you have a firewall in operation; you may have to disable it temporarily in order to find the printer. You also have the options of searching for the printer by its URL, IP address, or MAC address.

Connect directly to a computer (Windows)

You can connect your printer directly to a computer without going through a network, by using the printer's built-in USB 2.0 socket (supported under Windows 2000, XP, and 2003 Server).



TIP: A USB connection may be faster than a network connection, but the cable is limited in length and it is more difficult to share the printer.

1. **Do not connect the computer to the printer yet.** You must first install the printer driver software on the computer, as follows.
2. Insert the *HP Start-Up Kit* DVD into your DVD drive. If the DVD does not start automatically, run the START.EXE program in the root folder of the DVD.
3. Click **Install**. The printer drivers, HP Easy Printer Care, and HP Color Center are installed.
4. Follow the instructions on your screen to set up the printer. The following notes help you to understand the screens and make appropriate choices.
 - When asked how the printer is connected, select **Connected directly to this computer**.
 - If you would like to share the printer with other people connected to your network, press the **Printer Properties** button in the **Ready to Install** window, then select the **Sharing** tab and enter the name under which the printer will be shared.
 - When prompted to do so, connect your computer to the printer with a certified USB cable. Ensure that the printer is turned on.



NOTE: You may complete the installation without connecting your printer if you prefer. To do so, check the box marked **I want to connect my printer after completing the setup wizard**.

NOTE: The use of non-certified USB cables can lead to connectivity problems. Only cables certified by the USB Implementor's Forum (<http://www.usb.org/>) should be used with this printer.

Printer sharing considerations

- HP Easy Printer Care must be installed on a computer before it can be used from that computer.
- Any other users sharing your directly connected printer will be able to send print jobs, but will not be able to receive information from the printer—which affects printer alerts, printer status reports, paper management, printer administration and troubleshooting.
- Any other users sharing your directly connected printer will be unable to use the printer's own print preview facility, although the application's print preview will still be available. See [Preview a print on page 65](#).



TIP: The best way to share the printer over a network is to connect the printer not to any computer, but to the network. See [Connect to a network \(Windows\) on page 12](#).

Uninstall the printer software (Windows)

1. Insert the *HP Start-Up Kit* DVD into your DVD drive. If the DVD does not start automatically, run the START.EXE program in the root folder of the DVD.
2. Select **Install**, and follow the instructions on your screen to uninstall the printer software.

Connect to a network (Mac OS)

You can connect your printer to a network under Mac OS X by using the following methods:

- Bonjour/Rendezvous
- TCP/IP



NOTE: The printer does not support AppleTalk.

Before you begin, check your equipment:

- The printer should be set up and on.
- The Ethernet hub or router should be on and functioning correctly.
- All computers on the network should be on and connected to the network.
- The printer should be connected to the network.

Now you can proceed to install the printer software and connect your printer.

Bonjour/Rendezvous connection

1. Go to your printer's front panel and select the Connectivity menu icon , then **Gigabit Ethernet > View configuration**. Note the mDNS service name of your printer.
2. Insert the *HP Start-Up Kit* DVD into your DVD drive.

3. Open the DVD icon on your desktop.



4. Open the **Install** icon for your printer (HP Designjet T1100ps or T1100).



5. Open the **Mac OS X HP Designjet Installer** icon.
6. Follow the instructions on your screen. You are recommended to use the **Easy Install** option.
7. The printer software is installed, including the printer driver, HP Printer Utility, and HP Color Center.
8. When the software has been installed, the HP Printer Setup Assistant starts automatically, to set up a connection to your printer. Follow the instructions on your screen.
9. When you reach the Select Printer screen, look for your printer's mDNS service name (which you noted in step 1) in the Printer Name column.

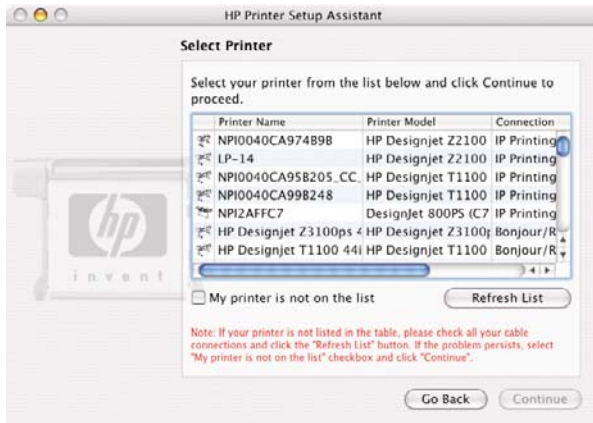

- If you find the right printer name, scroll sideways if necessary to see the Connection Type column, and check that it shows **Bonjour/Rendezvous**. Then highlight that line. Otherwise, continue searching further down the list.
- If you cannot find your printer name with a **Bonjour/Rendezvous** connection type, check the box **My printer is not in the list**.

Click **Continue**.

10. Continue following the instructions on the screen. When you reach the Printer Queue Created screen, click **Quit** to exit, or **Create New Queue** if you want to connect another printer to the network.
11. When the HP Printer Setup Assistant has finished, you can remove the DVD from the DVD drive.

If the printer driver is already installed, the HP Printer Setup Assistant can be run at any time from the DVD.

TCP/IP connection

1. Go to your printer's front panel and press the **Menu** key until you see the status screen.

Ready for paper

http://XXXX11
http://192.168.1.1

Press  to enter menu



Note the URL of your printer (http://XXXX11 in this example).

2. Insert the *HP Start-Up Kit* DVD into your DVD drive.

3. Open the DVD icon on your desktop.

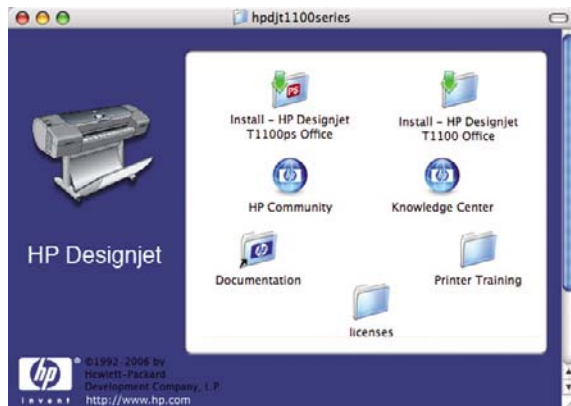

4. Open the **Install** icon for your printer (HP Designjet T1100ps or T1100).



5. Open the **Mac OS X HP Designjet Installer** icon.
6. Follow the instructions on your screen. You are recommended to use the **Easy Install** option.
7. The printer software is installed, including the printer driver, HP Printer Utility, and HP Color Center.
8. When the software has been installed, the HP Printer Setup Assistant starts automatically, to set up a connection to your printer. Follow the instructions on your screen.
9. When you reach the Select Printer screen, look for your printer's URL (which you noted in step 1) in the Printer Name column.
 - If you find the right printer name, scroll sideways if necessary to see the Connection Type column, and check that it shows **IP Printing**. Then highlight that line. Otherwise, continue searching further down the list.
 - If you cannot find your printer name with an **IP Printing** connection type, check the box **My printer is not in the list**.

Click **Continue**.

10. Continue following the instructions on the screen. When you reach the Printer Queue Created screen, click **Quit** to exit, or **Create New Queue** if you want to connect another printer to the network.
11. When the HP Printer Setup Assistant has finished, you can remove the DVD from the DVD drive.

If the printer driver is already installed, the HP Printer Setup Assistant can be run at any time from the DVD.

Connect directly to a computer (Mac OS)

You can connect your printer directly to a computer without going through a network, by using the printer's built-in USB 2.0 socket.

1. Make sure the printer is either turned off, or disconnected from the computer.
2. Insert the *HP Start-Up Kit DVD* into your DVD drive.
3. Open the DVD icon on your desktop.

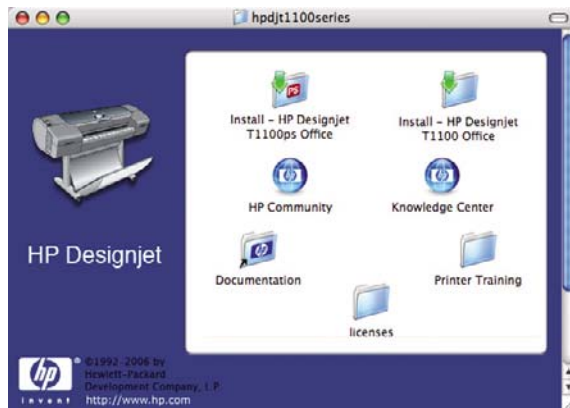

4. Open the **Install** icon for your printer (HP Designjet T1100ps or T1100).



5. Open the **Mac OS X HP Designjet Installer** icon.
6. Follow the instructions on your screen. You are recommended to use the **Easy Install** option.
7. The printer software is installed, including the printer driver, HP Printer Utility, and HP Color Center.
8. When the software has been installed, the HP Printer Setup Assistant starts automatically, to set up a connection to your printer.
9. Make sure that the printer is turned on and connected to the computer with a certified USB cable.



NOTE: The use of non-certified USB cables can lead to connectivity problems. Only cables certified by the USB Implementor's Forum (<http://www.usb.org/>) should be used with this printer.

10. In the HP Printer Setup Assistant, click **Continue**.
11. In the list of printers that appears, select the entry that uses the connection type USB, and click **Continue**.

12. The following screen displays information about your printer's installation, where the name of the printer can be modified. Make any changes you wish to make, and click **Continue**.
13. Your printer is now connected. In the Printer Queue Created screen, click **Quit** to exit, or **Create New Queue** if you want to connect another printer.
14. When the HP Printer Setup Assistant has finished, you can remove the DVD from the DVD drive.

If the printer driver is already installed, the HP Printer Setup Assistant can be run at any time from the DVD.

Sharing the printer



NOTE: Printer sharing between users is supported under Mac OS X 10.2 and later.

If your computer is connected to a network, you can make your directly connected printer available to other computers on the same network.

1. Double-click the System Preferences icon on the Dock menu bar on your desktop.
2. Enable printer sharing by going to **Sharing > Services > Printer Sharing**.
3. Your printer now automatically appears in the list of shared printers displayed by any other computer running Mac OS and connected to your local network.



NOTE: Any other users wishing to share your printer must install the printer software on their own computers.

Any other users sharing your directly connected printer will be able to send print jobs, but will not be able to receive information from the printer—which affects printer alerts, printer status reports, paper management, printer administration and troubleshooting.

Mac OS 10.2 users need to enable the **Show printers connected to other computers** option in the Print Center Preferences window in order to see shared printers. To open the Print Center Preferences window, select **Preferences** from the **Print Center** menu.

You may find that sharing your directly connected printer with other users will slow down your computer unacceptably.



TIP: The best way to share the printer over a network is to connect the printer not to any computer, but to the network. See [Connect to a network \(Mac OS\) on page 14](#).

Uninstall the printer software (Mac OS)

1. Insert the *HP Start-Up Kit* DVD into your DVD drive.

2. Open the DVD icon on your desktop.



3. Open the **Install** icon for your printer (HP Designjet T1100ps or T1100).



4. Open the **Mac OS X HP Designjet Installer** icon.
5. Select **Uninstall**, and follow the instructions on your screen to uninstall the printer software.

3 Setting up the printer

- [Introduction](#)
- [Handle paper conflicts](#)
- [Turn nesting on and off](#)
- [Turn usage information on and off](#)
- [Turn alerts on and off](#)
- [Set or delete the security password](#)
- [Require account ID](#)
- [Set Windows driver preferences](#)

Introduction



This chapter describes various printer settings that the printer administrator may wish to control as soon as a new printer is assembled and ready for use.

Handle paper conflicts

If the paper currently loaded in the printer is not suitable for a particular job, the printer can either put the job on hold until some suitable paper is loaded, or it can ignore the problem and print the job on the unsuitable paper. There are several ways in which the loaded paper may be considered unsuitable:

- The paper type is not as specified for the job
- The paper source (roll or sheet) is not as specified for the job
- The paper size is smaller than specified for the job

You can set the printer's behavior in such cases from the front panel.

- Select the Setup menu icon , then **Job management > Select paper mismatch action > Put on hold** if you want such jobs to be put on hold. The printer will send an alert whenever a job is put on hold.
- Select the Setup menu icon , then **Job management > Select paper mismatch action > Print anyway** if you want such jobs to print on whatever paper is loaded.

When a job is put on hold for paper, it is kept in the printer queue until some suitable paper is loaded. Meanwhile, other jobs with different requirements can continue printing.

Turn nesting on and off

Nesting means automatically printing images or document pages side by side on the paper when feasible, rather than one after the other. This is done to avoid wasting paper. See [Nest jobs to save roll paper on page 69](#).

To turn nesting on or off:

- **In HP Easy Printer Care for Windows:** select **Settings > Job Management > Nest**.
- **In HP Printer Utility for Mac OS:** select **Configuration > Printer Settings > Configure Printer Settings > Job Management > Nest**.
- **In the Embedded Web Server:** select **Setup > Printer settings > Job management > Nest**.
- **Using the front panel:** select the Setup menu icon , then **Job management > Nest options > Enable nesting**.

In each case, you will see the following options:

- **In order:** pages are nested in the order in which they are sent to the printer. The nested pages are printed as soon as one of three conditions is met:
 - The next page will not fit on the same row as the other pages already nested.
 - No page has been sent to the printer during the specified wait time.
 - The next page is incompatible with the pages already nested (see [Nest jobs to save roll paper on page 69](#)).
- **Optimized order:** pages are not necessarily nested in the order in which they are sent to the printer. When it receives an incompatible page, the printer holds it and waits for compatible pages to complete the nest. The nested pages are printed as soon as one of three conditions is met:
 - The next page will not fit on the same row as the other pages already nested.
 - No page has been sent to the printer during the specified wait time.
 - The incompatible-page queue is full. The printer can queue up to six incompatible pages while nesting compatible pages. If it receives a seventh incompatible page, the nest is printed as it is.
- **Off:** nesting is disabled.

The nesting wait time can be set at the front panel: Setup menu icon , **Job management > Nest options > Select wait time.**



TIP: **Optimized order** uses the minimum amount of paper; however, it may take longer to print because the printer waits for compatible pages to arrive.

Turn usage information on and off

The printer can send usage information periodically by e-mail. You can request this in the following ways:

- **In HP Easy Printer Care for Windows:** select **Settings > Accounting.**
- **In HP Printer Utility for Mac OS:** select **Configuration > Printer Settings > Configure Printer Settings > Accounting.**
- **In the Embedded Web Server:** select **Setup > Printer settings > Accounting.**

In each case, you must set the following options:

- **Send accounting files:** On
- **Send accounting files to:** a valid e-mail address
- **Send accounting files every:** choose a number of days (1–60) or a number of prints (1–500)

You must also ensure that the e-mail server has been configured. To configure the e-mail server using the Embedded Web Server, select **Setup > E-mail server**, and fill in the following fields:

- **SMTP server:** the IP address of the outgoing mail server (SMTP) that will process all e-mail messages from the printer. If the mail server requires authentication, e-mail notifications will not work.
- **Printer e-mail address:** each e-mail message sent by the printer must include a return address, which does not need to be a real, functional E-mail address, but it should be unique, so that recipients of the message can identify the printer that sent it.

Turn alerts on and off

Printer alerts warn you when there is a printer problem that you can correct by taking action, or when one of your printing jobs changes its status. The alerts are displayed by the printer's front panel, by HP Easy Printer Care under Windows or HP Printer Utility under Mac OS, by the printer driver, and by the Embedded Web Server.

You can tell the printer which kinds of alerts you would like to see (if any). To access the alert settings:

- Select **Alert Settings** in the Device List page of HP Easy Printer Care or HP Printer Utility.
- Select **Alert Settings** in any alert page displayed by HP Easy Printer Care.
- Right-click the HP Easy Printer Care system tray icon, and select **Alert Settings**.

You can change the settings in the following ways:

- Turn all alerts on or off.
- Turn job status alerts on or off.
- Turn on or off printer alerts for problems that stop the printer from printing.
- Turn on or off printer alerts for problems that do not stop the printer from printing.
- Turn on printer alerts in all circumstances, or only when you are trying to print to the printer affected by the problem.

Set or delete the security password

From the Embedded Web Server, you can select **Setup > Security** to set (or delete) a security password that restricts access to the following printer functions and settings.

- Cancel, delete, or preview a job in the job queue
- Delete a stored job
- Clear accounting information
- Change the printer settings on the Setup page
- Update the printer's firmware and paper profiles

Once a password has been set, no-one can perform any of these operations without providing the password.

If you forget the password, you can delete the current password from the front panel: select the

Connectivity menu icon , then **Advanced > Embedded Web Server > Reset EWS password**.

Access to the Networking page is protected by a different password (the administrator's password). To reset the administrator's password, you need to reset the whole input/output configuration. Using the front panel, select the Connectivity menu icon , then select your connection method (e.g. **Gigabit Ethernet**), then **Restore factory settings**.



NOTE: This will reset the whole input/output configuration, the printer will reset to the DHCP configuration method and its IP address could change.

Require account ID

If you want to keep records of printer usage by different user accounts, you can set your printer to require an account ID for each job.

- **In HP Easy Printer Care for Windows:** select **Settings > Accounting > Require account ID**.
- **In HP Printer Utility for Mac OS:** select **Configuration > Printer Settings > Configure Printer Settings > Accounting > Require account ID**.

If this setting is turned on, the account ID field will be mandatory and jobs with no account ID will be kept "on hold for accounting".

The account ID can be set in the printer driver when sending the job. If the job is set "on hold for accounting" by the printer, you can introduce the account ID in HP Easy Printer Care or HP Printer Utility by going to the **Job Center > Job Queue** and clicking the job that is on hold. A window with a text box will be displayed and you can enter the account ID into it.

Set Windows driver preferences

You can change some default settings in your printer driver according to your own preferences, for instance to set color emulation or paper-saving options. To do this, press the **Start** button on your computer's screen, then select **Printers and Faxes**. In the Printers and Faxes window, right-click on your printer's icon, and select **Printing Preferences**. Any settings you change in the Printing Preferences window will be saved as default values.

4 Personalizing the printer

- [Turn the printer on and off](#)
- [Change the language of the front-panel display](#)
- [Access HP Easy Printer Care \(Windows\) or HP Printer Utility \(Mac OS\)](#)
- [Access the Embedded Web Server](#)
- [Change the language of HP Easy Printer Care \(Windows\) or HP Printer Utility \(Mac OS\)](#)
- [Change the language of the Embedded Web Server](#)
- [Change the sleep mode setting](#)
- [Turn the buzzer on and off](#)
- [Change the front-panel display contrast](#)
- [Change the units of measurement](#)
- [Configure network settings](#)
- [Change the graphic language setting](#)

Turn the printer on and off



TIP: The printer is Energy Star compliant and can be left powered on without wasting energy. Leaving it on improves response time and overall system reliability. When the printer has not been used for a certain period of time (30 minutes by default), it saves power by going into sleep mode. However, any interaction with the printer's front-panel display returns it to active mode, and it can resume printing immediately. To change the sleep mode time, see [Change the sleep mode setting on page 31](#).



NOTE: In sleep mode, the printer performs maintenance service to the printheads from time-to-time. This avoids long preparation times after long idle periods. Therefore, it is strongly recommended to leave the printer powered on or in sleep mode to avoid wasting ink and time.

The printer has three levels of power consumption.

- Plugged in: the power cord is plugged into the back of the printer
- Switched on: the switch at the back of the printer is in the on position
- Powered on: the **Power** key on the front panel shows a green light

If you wish to turn the printer on or off or reset the printer, the normal and recommended method is to use the **Power** key on the front panel.



However, if you plan to store the printer indefinitely or the **Power** key does not seem to work, you are recommended to power it off using the **Power** key, and then also switch off the power switch at the rear.

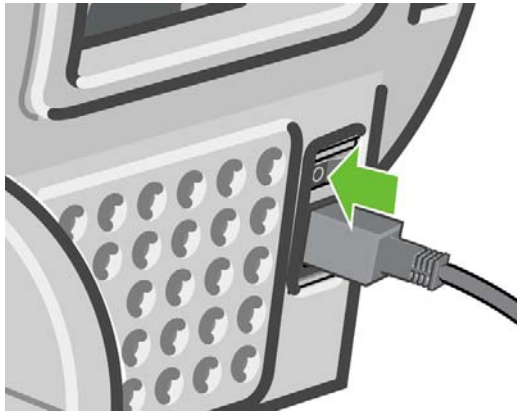

To turn it back on, use the power switch at the rear.

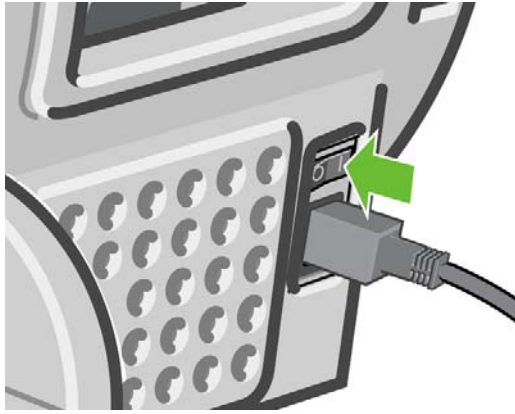

When the printer is powered back on, it takes about three minutes to initialize and check and prepare the printheads. Preparing the printheads takes about one minute and 15 seconds. However, if the printer has been off for six weeks or more, preparing the printheads could take up to 45 minutes.

Change the language of the front-panel display

There are two possible ways to change the language of the front-panel menus and messages.

- If you can understand the current front-panel display language, press the **Menu** key to return to the main menu and select the Setup menu icon , then **Front panel options > Select language**.
- If you cannot understand the current front-panel display language, start with the printer powered off. At the front panel, press the **OK** key and hold it down. While holding the **OK** key down, press the **Power** key and hold it down. Continue to hold down both keys until the green light on the right side of the front-panel display starts flashing, and then release both keys. You can expect a delay of about one second. If the green light starts flashing without any delay, you may need to start again.

Whichever method you used, the language selection menu should now appear on the front-panel display. Highlight your preferred language with the **Up** and **Down** keys, then press the **OK** key.

Access HP Easy Printer Care (Windows) or HP Printer Utility (Mac OS)

HP Easy Printer Care (Windows) or HP Printer Utility (Mac OS) enables you to manage your printer from a computer with a USB connection or TCP/IP.

- Under Windows, start HP Easy Printer Care from your desktop shortcut or from **Start > All Programs > Hewlett-Packard > HP Easy Printer Care > Start HP Easy Printer Care**. This launches HP Easy Printer Care showing the printers installed.
- Under Mac OS, launch the Mac Printer Utility by selecting **STARTUP_DISK > Library > Printers > hp > Utilities > HP Printer Utility**. This launches the HP Printer Selector where you need to add your printer by clicking **More Printers**.

Select your printer and click **Launch Utility**. This launches the HP Printer Utility.

If you have followed these instructions but failed to get through to HP Easy Printer Care (Windows) or HP Printer Utility (Mac OS), see [Cannot access HP Easy Printer Care \(Windows\) or HP Printer Utility \(Mac OS\) on page 187](#).

Access the Embedded Web Server

The Embedded Web Server enables you to manage your printer remotely using an ordinary Web browser running on any computer.



NOTE: To use the Embedded Web Server, you must have a TCP/IP connection to your printer.

The following browsers are known to be compatible with the Embedded Web Server:

- Internet Explorer 5.5 or later, for Windows
- Internet Explorer 5.1 or later, for Mac OS X
- Netscape Navigator 6.01 or later
- Mozilla 1.5 or later
- Mozilla Firefox 1.0 or later
- Safari

To access the Embedded Web Server on any computer, open your Web browser and give the address of your printer. You can find out the address of your printer (starting with **http:**) from the front-panel display, by looking at the status screen.

Ready for paper

http://XXXX11
http://192.168.1.1

Press  to enter
menu



If you have followed these instructions but failed to get through to the Embedded Web Server, see [Cannot access the Embedded Web Server on page 188](#).

Change the language of HP Easy Printer Care (Windows) or HP Printer Utility (Mac OS)

HP Easy Printer Care (Windows) or HP Printer Utility (Mac OS) can work in the following languages: English, Portuguese, Spanish, Catalan, French, Italian, German, Russian, Simplified Chinese, Traditional Chinese, Korean, and Japanese.

- Under Windows, select **Tools > Set Language** and select a language from the list.
- Under Mac OS, the language is changed as for any other application. In **System Preferences** select **International** and re-launch the application.

Change the language of the Embedded Web Server

The Embedded Web Server can work in the following languages: English, Portuguese, Spanish, Catalan, French, Italian, German, Russian, Simplified Chinese, Traditional Chinese, Korean, and Japanese. It uses whichever language you have specified in your Web browser's options. If you have specified a language that it cannot support, it works in English.

To change the language, you must change your Web browser's language setting. For example, in Internet Explorer version 6, go to the **Tools** menu and select **Internet Options, Languages**. Then ensure that the language you want is at the top of the list in the dialog box.

To complete the change, you must close and reopen your Web browser.

Change the sleep mode setting

If the printer is left switched on but unused for a certain period of time, it goes automatically into sleep mode to save power. The default is 30 minutes. To change the time the printer waits before it goes into

sleep mode, press the **Menu** key to return to the main menu and select the Setup menu icon , then **Front panel options > Sleep mode wait time**. Highlight the wait time you want and then press the **OK** key. You can set the time to 30, 60, 120, 150, 180, 210, or 240 minutes.

Turn the buzzer on and off

To turn the printer's buzzer on or off, press the **Menu** key to return to the main menu and select the

Setup menu icon , then **Front panel options > Enable buzzer**, and highlight on or off and press the **OK** key. By default, the buzzer is set to on.

Change the front-panel display contrast

To change the contrast of the front-panel display, select the Setup menu icon , then **Front panel options > Select display contrast**, and enter a value using the **Up** or **Down** key. Press the **OK** key to set the value. The default contrast is set to 50.

Change the units of measurement

To change the units of measurement in the front-panel display, select the Setup menu icon , then **Front panel options > Select units**, and select **English** or **Metric**. By default the units are set to metric.

Configure network settings

To configure the network settings from HP Easy Printer Care (Windows), select **Settings tab > Network Settings**. From HP Printer Utility (Mac OS), select **Configuration > Network Settings**. You can view and configure the following network settings.

- **IP Configuration method:** specify the way to set an IP address between BOOTP, DHCP, Auto IP, and Manual
- **Host name:** specify an IP name for the network device, the name may contain up to 32 ASCII characters
- **IP address:** specify the IP address on the print server, duplicate IP addresses on a TCP/IP network are not allowed



NOTE: If you change the current IP address and click Apply, the browser loses the current connection to the print server because it is pointing to the old address. To reconnect, browse to the new IP address.

- **Subnet mask:** specify a subnet mask, which is a 32-bit number applied to an IP address to determine which bits specify the network and subnet and which bits uniquely specify the node
- **Default gateway:** specify the IP address of a router or computer that is used to connect to other networks or sub-networks, if none exist, use the IP address of the computer or the IP address of the print server
- **Domain name:** specify the name of the DNS domain that the print server resides in, for example, support.hp.com, note that it does not include the host name; it is not the fully qualified domain name, such as printer1.support.hp.com
- **Idle timeout:** specify the number of seconds that an idle connection is allowed to remain open, 270 is the default value, if set to zero, the timeout is disabled and TCP/IP connections remain open until closed by the other node (such as a workstation) on the network
- **Default IP:** specify the IP address to use when the print server is unable to obtain an IP address from the network when powered on or when reconfigured to use BOOTP or DHCP
- **Send DHCP requests:** specify whether DHCP requests are transmitted when a legacy default IP address or a default Auto IP is assigned

To configure the same network settings from the front panel, press the **Menu** key to go to the main menu

and select the Connectivity menu icon , then **Gigabit Ethernet > Modify configuration**.

Change the graphic language setting





NOTE: You should not need to change the default graphic language setting (**Automatic**), and you are not recommended to do so.

Change the graphic language setting from the HP Easy Printer Care and HP Printer Utility applications with the following steps.

1. Under Windows, select the **Settings** tab then **Printer settings > Printing preferences**.

Under Mac OS, select **Configuration** then **Printer settings > Configure printer settings > Printing preferences**.

2. Select one of the following options.
 - Select **Automatic** to let the printer determine which type of file it is receiving. This setting works for most software applications.
 - Select **HP-GL/2** only if you are sending a file of that type directly to the printer, without going through a printer driver.
 - Select **CALS/G4** only if you are sending a file of that type directly to the printer, without going through a printer driver.
 - Select **PDF** only if you are sending a file of that type directly to the printer, without going through a printer driver (HP Designjet T1100ps only).
 - Select **PostScript** only if you are sending a file of that type directly to the printer, without going through a printer driver (HP Designjet T1100ps only).
 - Select **TIFF** only if you are sending a file of that type directly to the printer, without going through a printer driver (HP Designjet T1100ps only).
 - Select **JPEG** only if you are sending a file of that type directly to the printer, without going through a printer driver (HP Designjet T1100ps only).

You can change the graphic language setting from the front panel. Press the **Menu** key to return to the main menu the select the Setup menu icon , then **Printer preferences > Select graphic language**. Select the desired option and press the **OK** key to set the value. If you are using a USB connection, select the Setup menu icon , then **Printing preferences > PS > Select encoding > ASCII**.



NOTE: The setting selected through the HP Easy Printer Care (Windows) or HP Printer Utility (Mac OS) overrides the setting selected by the front panel.

5 Paper handling

- [General advice](#)
- [Load a roll onto the 24-inch spindle](#)
- [Load a roll onto the 44-inch spindle](#)
- [Load a roll into the 24-inch printer](#)
- [Load a roll into the 44-inch printer](#)
- [Unload a roll](#)
- [Load a single sheet](#)
- [Unload a single sheet](#)
- [View information about the paper](#)
- [Paper profiles](#)
- [Print on loaded paper](#)
- [Maintain paper](#)
- [Change the drying time](#)
- [Turn the automatic cutter on and off](#)
- [Feed and cut the paper](#)

General advice

-  **CAUTION:** Before starting a paper loading process, ensure you have enough room around the printer, both in front and behind.

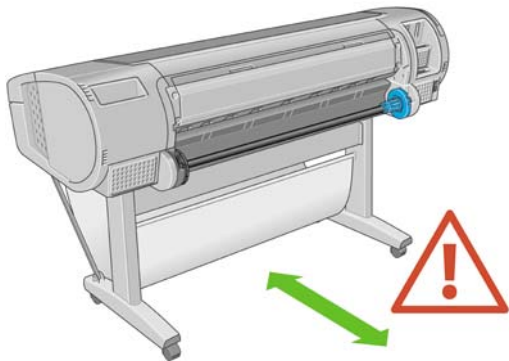

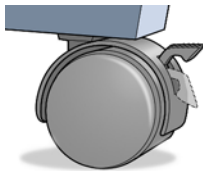

-  **CAUTION:** Make sure the printer wheels are locked (the brake lever is pressed down) to prevent the printer from moving.

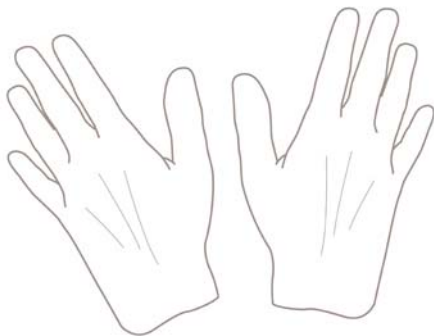

-  **CAUTION:** All paper must be 11 inches (28 cm) or longer. A4 and letter paper cannot be loaded landscape.

-  **TIP:** For photo paper wear cotton gloves to avoid transferring oils onto the paper.



-  **CAUTION:** Keep the basket closed throughout the loading process.

Load a roll onto the 24-inch spindle

-  **CAUTION:** Ensure the sheet tray is closed.

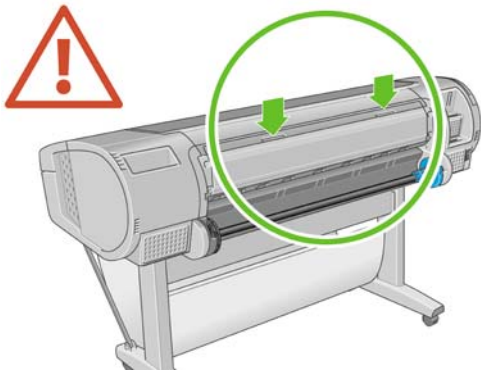

1. Remove the spindle from the printer one end at a time.



WARNING! Do not insert your fingers into the spindle supports during the removal process.

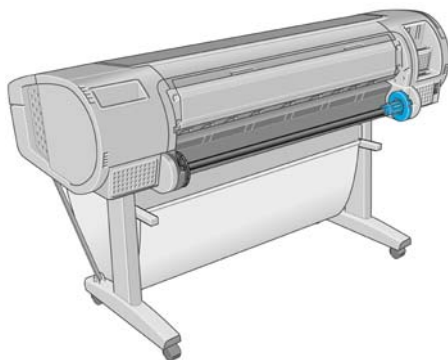

2. The spindle has a stop at each end to keep the roll in position. The blue stop can be removed to mount a new roll; it slides along the spindle to hold rolls of different widths. Remove the blue paper stop from the end of the spindle.



3. If your roll has a three-inch cardboard core, ensure that the core adaptors supplied with the printer have been installed.

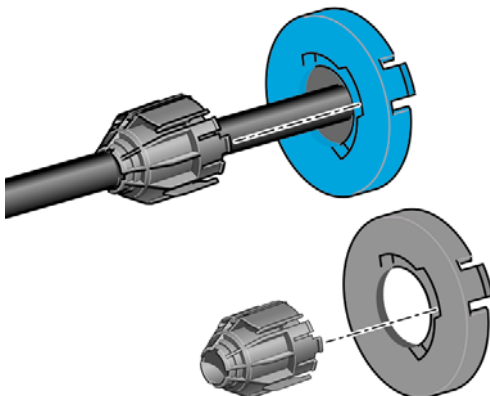

4. If the roll is long; rest the spindle horizontally on a table and load the roll on the table.



TIP: You may need two people to handle a large roll.

5. Slide the new roll onto the spindle. Make sure the paper type is oriented as shown. If it is not, remove the roll, turn it 180 degrees and slide it back on to the spindle. There are labels on the spindle showing the correct orientation.



NOTE: From the back of the printer, the blue stopper is inserted into the right-side holder.

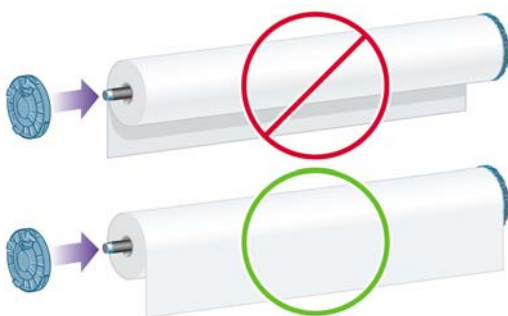

Ensure both ends of the roll are as close to the spindle stops as possible.

6. Put the blue paper stop on to the open end of the spindle, and push it towards the end of the roll.

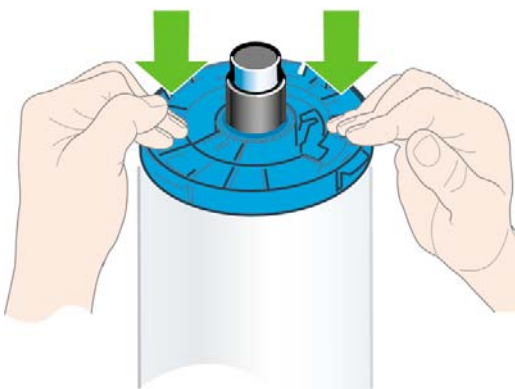

7. Ensure the blue paper stop is pushed in as far as it goes; until both ends are against the stoppers.

If you are a regular user of different paper types, you can change rolls more quickly if you preload rolls of different paper types on different spindles. Extra spindles are available for purchase, see [Accessories on page 141](#).

Load a roll onto the 44-inch spindle



CAUTION: Ensure the sheet tray is closed.

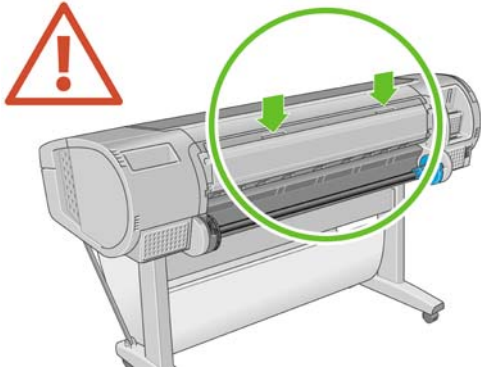

1. Remove the black end of the spindle from the printer, then the blue end.



CAUTION: Be sure to remove the black end first. Removing the blue end first could damage the black end.



WARNING! Do not insert your fingers into the spindle supports during the removal process.

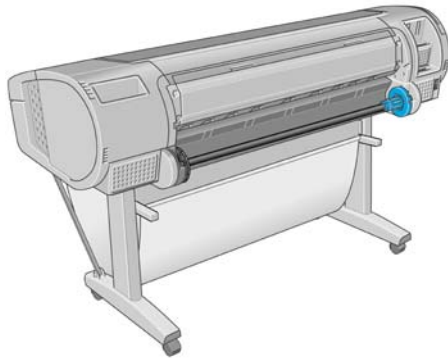

2. The spindle has a stop at each end to keep the roll in position. The blue stop can be removed to mount a new roll; it slides along the spindle to hold rolls of different widths. Remove the blue paper stop from the end of the spindle.



3. If your roll has a three-inch cardboard core, ensure that the core adaptors supplied with the printer have been installed.

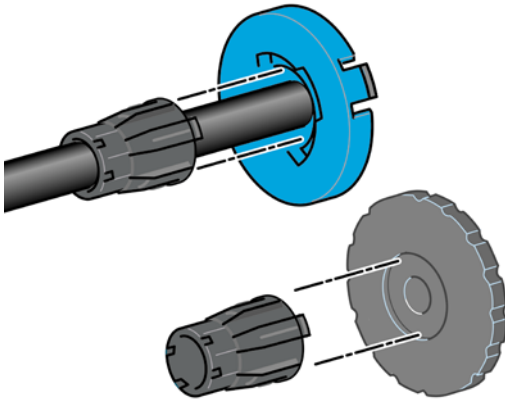

4. If the roll is long; rest the spindle horizontally on a table and load the roll on the table.



TIP: You may need two people to handle a large roll.

5. Slide the new roll onto the spindle. Make sure the paper type is oriented as shown. If it is not, remove the roll, turn it 180 degrees and slide it back on to the spindle. There are labels on the spindle showing the correct orientation.



NOTE: From the back of the printer, the blue stopper is inserted into the right-side holder.

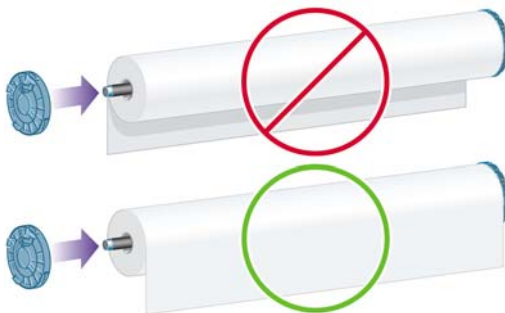

Ensure both ends of the roll are as close to the spindle stops as possible.

6. Put the blue paper stop on to the open end of the spindle, and push it towards the end of the roll.

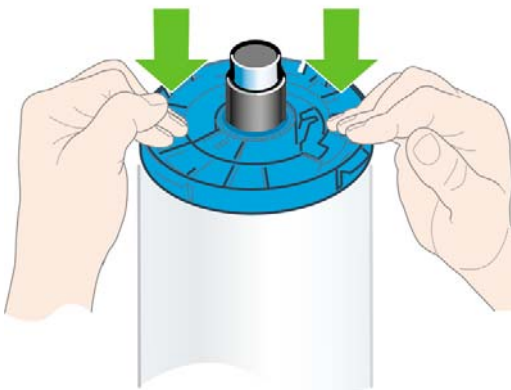

7. Ensure the blue paper stop is pushed in as far as it goes; until both ends are against the stoppers.

If you are a regular user of different paper types, you can change rolls more quickly if you preload rolls of different paper types on different spindles. Extra spindles are available for purchase, see [Accessories on page 141](#).

Load a roll into the 24-inch printer

There are two ways to load a roll. The easy loading procedure is recommended.



CAUTION: To start these procedures you must have a roll loaded on the spindle. See [Load a roll onto the 24-inch spindle on page 36](#).

Easy loading procedure

1. Standing behind the printer, rest the spindle's black end on the left side roll holder. Do not put the end completely into the roll holder.

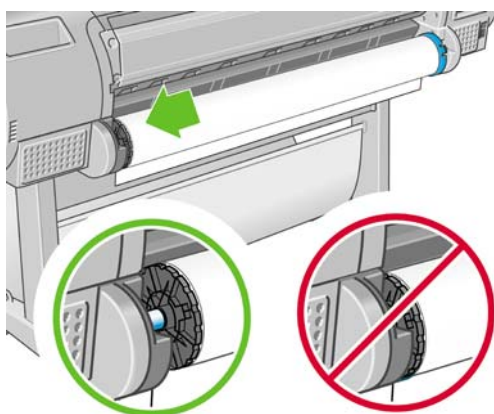

2. Rest the blue end of the spindle on the right side roll holder.

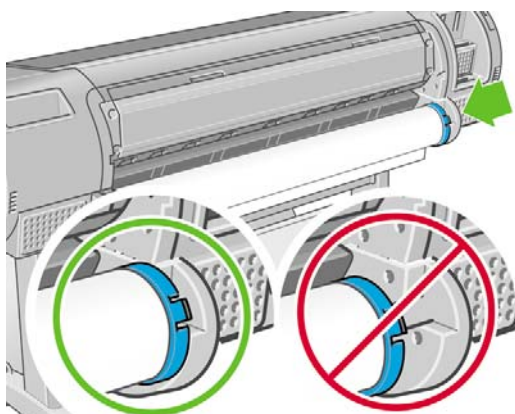

3. With both hands, push the spindle into both roll holders at the same time. The spindle snaps into place.

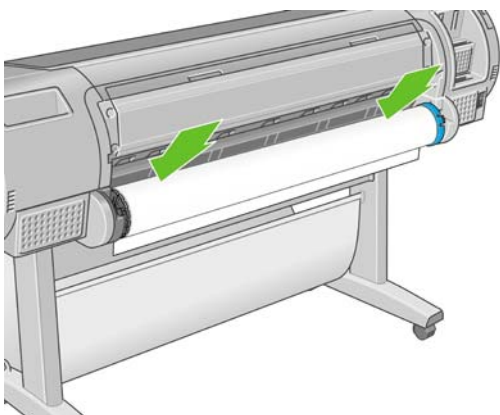

4. If the edge of the roll is not straight or torn (sometimes due to tape used to hold end of the roll), pull paper slightly beyond the cutting groove and use a cutter to cut a straight edge.

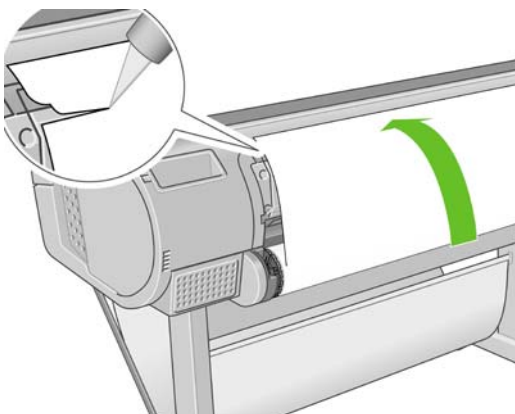

TIP: Cut the paper as straight as possible, as uneven paper does not load correctly.

5. Insert the edge of the paper into the feeder.



WARNING! Do not push your fingers inside the printer's paper path.

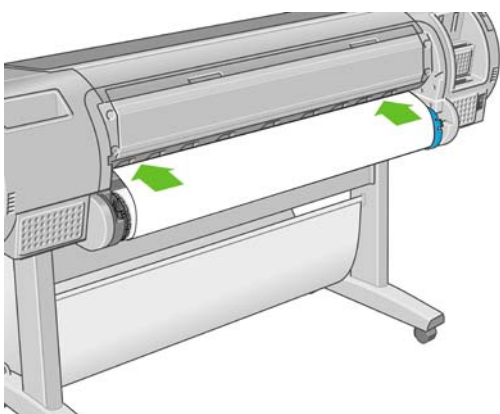

6. Roll the spindle into the feeder until you feel resistance. The printer detects the paper and feeds it automatically into the printer.

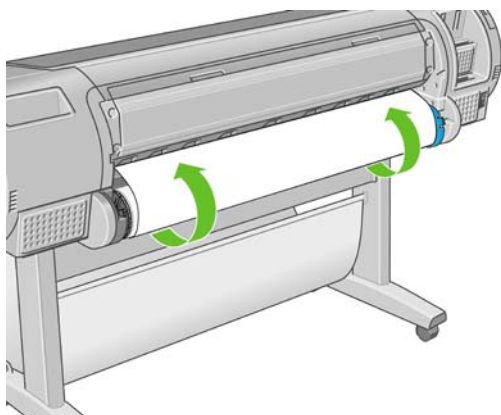

7. Once the paper is fed into the printer, the front-panel display asks if you are loading a roll or a sheet. Select **Roll** with the **Up** and **Down** keys and press **OK**.
8. Select your paper category and type.

Select paper category

- ▶ Bond and Coated Paper
- ▶ Photo Paper
- ▶ Film
- ▶ Technical Paper
- ▶ Backlit material
- ▶ Self-Adhesive material



TIP: If you have loaded a paper type whose name does not appear in the paper list, see [The paper type is not in the driver on page 150](#).

9. The printer checks the alignment and measures the width.
10. Look at the front panel; you may find some instructions there.
11. When the roll is aligned, the front panel displays the **Ready** message and the printer is ready to print. If the roll is not aligned, follow the instructions on the front-panel display.
12. If the paper is loose on the roll, lightly rewind from the end of the spindle until tight.

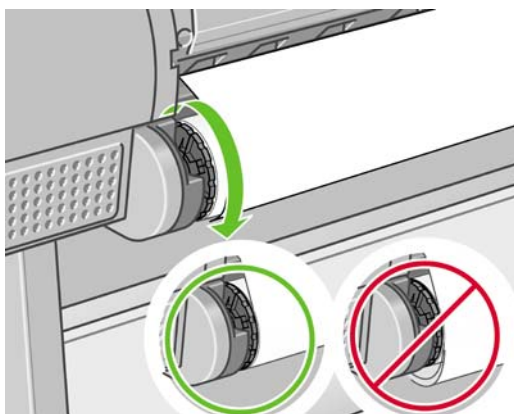



NOTE: If you have an unexpected issue at any stage of the paper loading process, see [The paper cannot be loaded successfully on page 148](#).



TIP: When prints fall into the basket, they can be torn or get ink marks from other prints. To avoid this, catch your prints as they are cut from the roll and do not stack prints in the basket. You can also turn off the automatic cutter, see [Turn the automatic cutter on and off](#)

[on page 56](#), and release your print using the [Form feed and cut key](#) .

Paper menu procedure

As an alternative you can use the paper menu to start the paper loading process.

1. Follow steps one through four of the [Easy loading procedure on page 41](#).
2. Press the **Menu** key to return to the main menu, select the Paper menu icon .
3. Select **Paper load**.

Paper

```
▣ Paper load
▣ Unload paper
▣ View loaded paper
▣ Change loaded paper type
▣ Paper types list
```

4. Select **Load roll**.

Paper load

```
▣ Load roll
▣ Load sheet
```

5. Select your paper category and type.

Select paper category

- ▶ Bond and Coated Paper
- ▶ Photo Paper
- ▶ Film
- ▶ Technical Paper
- ▶ Backlit material
- ▶ Self-Adhesive material



TIP: If you have loaded a paper type whose name does not appear in the paper list, see [The paper type is not in the driver on page 150](#).

6. Continue with step five of the easy loading process, skipping steps eight and nine.



TIP: When prints fall into the basket, they can be torn or get ink marks from other prints. To avoid this, catch your prints as they are cut from the roll and do not stack prints in the basket. You can also turn off the automatic cutter, see [Turn the automatic cutter on and off](#)

[on page 56](#), and release your print using the **Form feed and cut** key .

Load a roll into the 44-inch printer

There are two ways to load a roll. The easy loading procedure is recommended.



CAUTION: To start these procedures you must have a roll loaded on the spindle. See [Load a roll onto the 24-inch spindle on page 36](#).

Easy loading procedure

1. Standing behind the printer, rest the spindle's black end on the left side roll holder. Do not put the end completely into the roll holder.

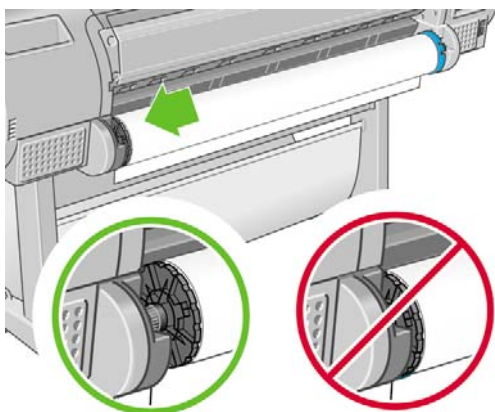

2. Rest the blue end of the spindle on the right side roll holder.

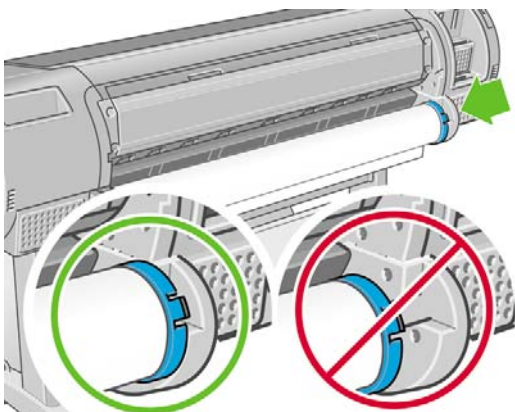

3. With both hands, push the spindle into both roll holders at the same time. The spindle snaps into place.

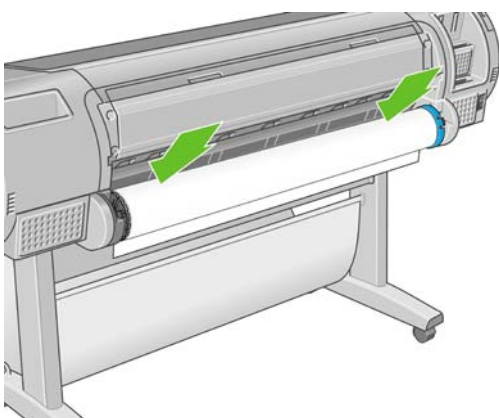

4. If the edge of the roll is not straight or torn (sometimes due to tape used to hold end of the roll), pull paper slightly beyond the cutting groove and use a cutter to cut a straight edge.

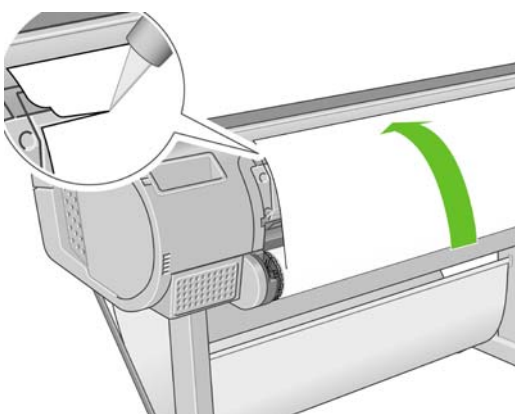

TIP: Cut the paper as straight as possible, as uneven paper does not load correctly.

5. Insert the edge of the paper into the feeder.



WARNING! Do not push your fingers inside the printer's paper path.

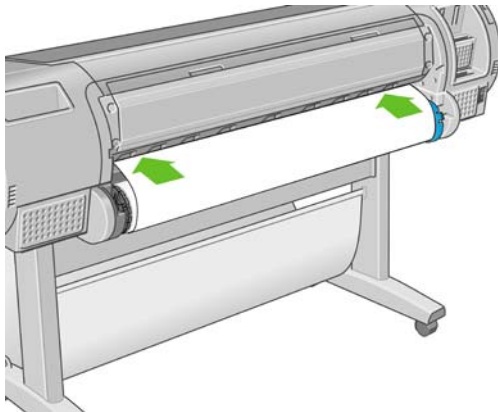

6. Roll the spindle into the feeder until you feel resistance. The printer detects the paper and feeds it automatically into the printer.

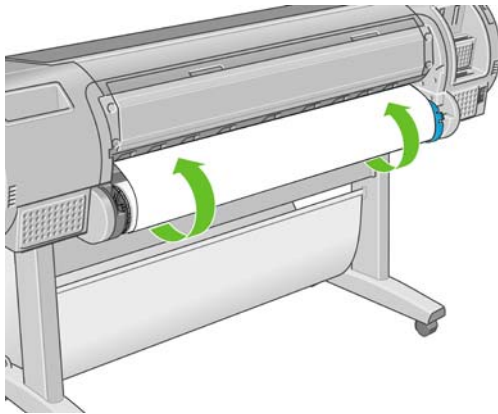

7. Once the paper is fed into the printer, the front-panel display asks if you are loading a roll or a sheet. Select **Roll** with the **Up** and **Down** keys and press **OK**.
8. Select your paper category and type.

```
Select paper category
├─ Bond and Coated Paper
├─ Photo Paper
├─ Film
├─ Technical Paper
├─ Backlit material
└─ Self-Adhesive material
```



TIP: If you have loaded a paper type whose name does not appear in the paper list, see [The paper type is not in the driver on page 150](#).

9. The printer checks the alignment and measures the width.

10. Look at the front panel; you may find some instructions there.
11. When the roll is aligned, the front panel displays the **Ready** message and the printer is ready to print. If the roll is not aligned, follow the instructions on the front-panel display.



NOTE: If you have an unexpected issue at any stage of the paper loading process, see [The paper cannot be loaded successfully on page 148](#).



TIP: When prints fall into the basket, they can be torn or get ink marks from other prints. To avoid this, catch your prints as they are cut from the roll and do not stack prints in the basket. You can also turn off the automatic cutter, see [Turn the automatic cutter on and off](#)

[on page 56](#), and release your print using the **Form feed and cut** key .

Paper menu procedure

As an alternative you can use the paper menu to start the paper loading process.

1. Follow steps one through four of the [Easy loading procedure on page 45](#).
2. Press the **Menu** key to return to the main menu, select the Paper menu icon .
3. Select **Paper load**.

Paper

- Paper load
- Unload paper
- View loaded paper
- Change loaded paper type
- Paper types list

4. Select **Load roll**.

Paper load

- Load roll
- Load sheet

5. Select your paper category and type.

Select paper category

- ▶ Bond and Coated Paper
- ▶ Photo Paper
- ▶ Film
- ▶ Technical Paper
- ▶ Backlit material
- ▶ Self-Adhesive material



TIP: If you have loaded a paper type whose name does not appear in the paper list, see [The paper type is not in the driver on page 150](#).

6. Continue with step five of the easy loading process, skipping steps eight and nine.



TIP: When prints fall into the basket, they can be torn or get ink marks from other prints. To avoid this, catch your prints as they are cut from the roll and do not stack prints in the basket. You can also turn off the automatic cutter, see [Turn the automatic cutter on and off](#)

[on page 56](#), and release your print using the **Form feed and cut** key .

Unload a roll

Before unloading a roll, check whether there is paper on the roll or if the roll is out of paper, and follow the appropriate procedure as described below.

Unload paper key procedure with paper on the roll

If there is paper on the roll, use the following procedure.

1. Press the **Unload paper** key  on the front panel.
2. When prompted by the front-panel display, lift the blue lever on the left.
3. When prompted by the front-panel display, lightly rewind the paper from the end of the spindle until removed from the printer.
4. When prompted by the front-panel display, lower the blue lever.

Paper menu procedure with paper on the roll

If there is paper on the roll, you can also start the process from the paper menu in the front panel's main menu.

1. Press the **Menu** key to return to the main menu, select the Paper menu icon .

2. Select **Unload paper**.

```
Paper
-----
▣ Paper load
▶ Unload paper
▶ View loaded paper
▣ Change loaded paper type
▣ Paper types list
```

3. Continue from step two of the **Unload paper** key process.

Roll out of paper procedure

If the end of the paper is no longer attached to the roll use the following procedure.

1. If you have already started the unload process, press the **Cancel** key on the front panel to cancel that procedure.
2. Lift the blue lever on the left. If the front panel displays a warning about the lever, ignore it.
3. Pull out the paper from the printer. Pull from wherever the paper is accessible; the back of the printer is recommended.
4. Lower the blue lever.
5. If the front panel displays a warning message, press the **OK** key to clear it.

Load a single sheet

There are two ways to load a sheet. The easy loading procedure is recommended.



CAUTION: Any loaded roll or sheet must be unloaded before loading a sheet, see [Unload a roll on page 49](#), and [Unload a single sheet on page 53](#).

CAUTION: For sheets thicker than 0.5mm, you must have space behind the printer equal to the length of the sheet.

Easy loading procedure

1. Standing in front of the printer, open the sheet tray. If the sheet is long, extend the tray.



TIP: If the tray is difficult to open, try opening from behind the printer.

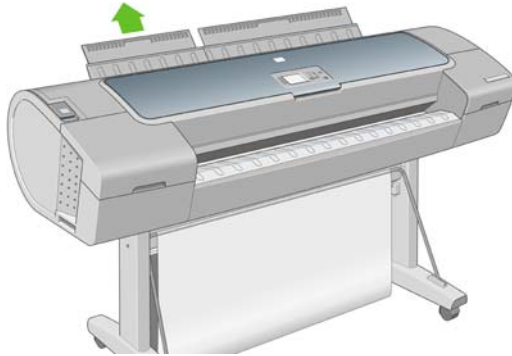

NOTE: The extensions are seven cm and snap in place.

2. Insert the sheet into the feeder. Load your sheet aligned with the load line and insert until the paper will not continue, with thicker sheets you feel resistance. The printer detects the sheet in three seconds. A countdown begins on the front-panel display.

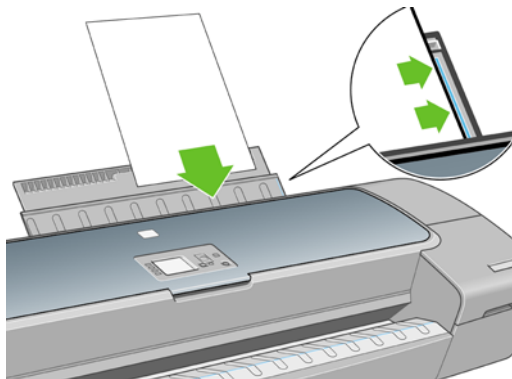

WARNING! Do not push your fingers inside the printer's paper path.

3. After the countdown, the paper feeds into the printer. Guide the sheet into the printer; this is especially important with thicker papers.
4. The front-panel display asks if you are loading a roll or a sheet. Select **Sheet** with the **Up** and **Down** keys.



NOTE: If you select roll, the sheet will not load.

5. Enter your paper category and type.

Select paper category

- ▶ Bond and Coated Paper
- ▶ Photo Paper
- ▶ Film
- ▶ Technical Paper
- ▶ Backlit material
- ▶ Self-Adhesive material



TIP: If you have loaded a paper type whose name does not appear in the paper list, see [The paper type is not in the driver on page 150](#).

6. The printer checks the alignment and measures the sheet.

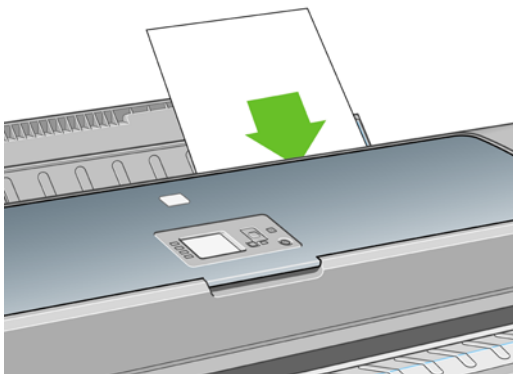

NOTE: Depending on the length of the sheet, it feeds out the front of the printer.

7. If the paper has been loaded successfully, the front panel displays the **Ready** message and the printer ready to print. If the paper is not straight, follow the instructions on the front-panel display.



NOTE: When correctly loaded, the sheet is in the back of the printer.

NOTE: If you have an unexpected problem at any stage of the paper loading process, see [The paper cannot be loaded successfully on page 148](#).

Paper menu procedure

As an alternative you can use the paper menu to start the paper loading process

1. Perform step one of the easy loading procedure.
2. Press the **Menu** key to return to the main menu and select the Paper menu icon .

3. Select **Paper load**.

Paper

- ▣ Paper load
- ▣ Unload paper
- ▣ View loaded paper
- ▣ Change loaded paper type
- ▣ Paper types list

4. Select **Load sheet**.

Paper load

- ▣ Load roll
- ▣ Load sheet



CAUTION: If you select roll, the sheet will not load.

5. Select your paper category and type.

Select paper category

- ▶ Bond and Coated Paper
- ▶ Photo Paper
- ▶ Film
- ▶ Technical Paper
- ▶ Backlit material
- ▶ Self-Adhesive material



TIP: If you have loaded a paper type whose name does not appear in the paper list, see [The paper type is not in the driver on page 150](#).

6. Continue with step two of the easy loading procedure, skipping steps four and five.

Unload a single sheet

To unload a single sheet after printing, you can simply pull the sheet free from the front of the printer.

To unload a sheet without printing, use the **Unload paper** key  or the paper menu procedure.

Unload paper key procedure

1. Press the **Unload paper** key  on the front panel.
2. The sheet unloads out the front of the printer, either catch it manually or allow it to fall in the basket.

Paper menu procedure

You can also unload a sheet from the paper menu.

1. Press the **Menu** key to return to the main menu and select the Paper menu icon .
2. Select **Unload paper**. The sheet unloads out of the front of the printer, either catch it manually or allow it to fall in the basket.

```
Paper
-----
▣ Paper load
▶ Unload paper
▶ View loaded paper
▣ Change loaded paper type
▣ Paper types list
```

View information about the paper

To view the loaded paper information, press the **View loaded paper** key  on the front panel.

You can also select the Paper menu icon  and then **View loaded paper**.

The following information is displayed on the front panel:

- Roll or sheet status
- Paper manufacturer's name
- Paper type you have selected
- Width of the paper in millimeters (estimated)
- Length of the sheet in millimeters (estimated)
- Color calibration status
- Paper advance calibration status

If no paper is loaded, the message **Out of paper** is displayed.

The same information (apart from the manufacturer's name) is displayed in HP Easy Printer Care and HP Printer Utility on the Supplies page.



NOTE: Photo and coated paper requires careful handling, see [The print is scuffed or scratched on page 167](#).

Paper profiles

Each supported paper type has its own characteristics. For optimum print-quality, the printer changes the way it prints on each different paper type. For example, some may need more ink and some may require a longer drying time. So the printer must be given a description of the requirements of each paper type. This description is called the “media” or “paper” profile. The paper profile contains the ICC profile, which describes the color characteristics of the paper; it also contains information on other characteristics and requirements of the paper that are not directly related to color. Existing paper profiles for your printer are already installed in the printer’s software.

However, as it is inconvenient to scroll through a list of all paper types available, your printer only contains paper profiles for the most commonly used paper types. If you have a paper type for which your printer has no profile, you cannot select that paper type in the front-panel display.

There are two ways to assign a profile for a new paper type.

- Use a HP factory paper profile by selecting the closest category and type in the front panel, HP Easy Printer Care (Windows), or HP Printer Utility (Mac OS)



NOTE: Colors may not be accurate. This method is not recommended for high-quality prints.

- Download the correct paper profile from: <http://www.hp.com/go/designjet/downloads>



NOTE: HP only provides profiles for HP paper types. If you do not find the paper profile you want on the Web, you may find that it has been added to the latest firmware for your printer. You can check the firmware release notes for information, see [Update the firmware on page 138](#).

Print on loaded paper

To print a job on whichever paper is loaded in the printer, select **Any** in the Paper Type option of your printer driver.

- **In the Windows driver dialog:** select the Paper/Quality tab, then select **Any** in the Paper Type drop-down list.
- **In the Mac OS Print dialog (T1100):** select the Paper Type/Quality panel, then select **Any** in the Paper Type drop-down list.
- **In the Mac OS PS Print dialog (T1100ps):** select the Image Quality panel, then select **Any** in the Paper Type drop-down list.



NOTE: **Any** is the driver default.

Maintain paper

To maintain paper quality, follow the recommendations below.

- Store rolls covered by another piece of paper or cloth
- Store cut sheets covered and clean or brush them before loading them in the printer
- Clean input and output platens and cut sheet tray
- Always keep the window of your printer closed



NOTE: Photo and coated paper requires careful handling, see [The print is scuffed or scratched on page 167](#).

Change the drying time

You may wish to change the drying time setting to suit special printing conditions such as multiple prints where time is of higher importance or when you need to be sure ink is dry before handling.



Select the Setup menu icon , then **Print retrieval** > **Select drying time**. You can select:

- Extended, to set a longer than recommended time to ensure ink is completely dry
- Optimal, to set the default and recommended time for your selected paper
- Reduced, to set a shorter than recommended time when quality is of lower importance
- None, to disable the drying time and remove your print as soon as it finishes printing



CAUTION: If the ink is not dry when the print is removed it could leave ink in the output tray and marks on the print.



NOTE: If you cancel the drying time during a print, the printer may not feed and cut the paper right away due to the printhead maintenance, which runs in parallel. If the dry time is zero, the printer cuts the paper and then performs the printhead maintenance. However, if the dry time is greater than zero, the printer does not cut the paper until after the printhead maintenance has

completed, even if you press the **Form feed and cut** key .

Turn the automatic cutter on and off

To turn the printer's paper cutter on or off:

- From HP Easy Printer Care (Windows), select the **Settings** tab and change the **Cutter** option in **Printer Settings > Advanced**.
- From HP Printer Utility (Mac OS), select **Configuration > Printer Settings > Configure Printer Settings** and change the **Cutter** option.
- From the Embedded Web Server, select the **Setup** tab, then **Printer Settings > Advanced**, and change the **Cutter** option.
- Press the **Menu** key to return to the main menu, select the Setup menu icon , then **Printer Settings > Advanced** and change the cutter option.



NOTE: To cut rolled paper while the automatic cutter is disabled, see [Feed and cut the paper on page 56](#).

Feed and cut the paper

To feed and cut the paper when the automatic cutter has been disabled, press the **Form feed and cut** key  on the front panel. The paper advances and the printer makes a straight cut on the front edge.



TIP: If the printer is waiting to nest more pages, you can cancel the waiting time and print the available pages immediately by pressing the **Form feed and cut** key .



NOTE: The printer may not cut the paper directly after pressing the **Form feed and cut** key , as each time a print is printed the printheads are serviced and the paper cannot be cut until the process completes.

Remove the cut piece from the output tray.

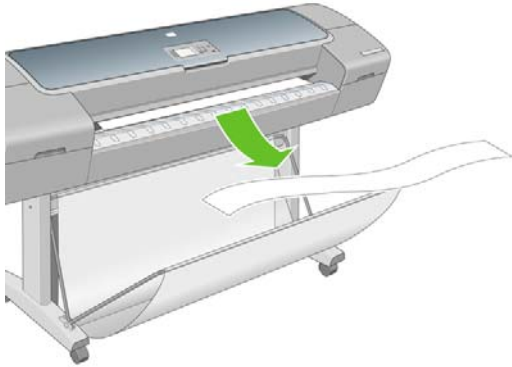

CAUTION: If strips or short prints are left in the output tray the printer could jam.



NOTE: Photo and coated paper requires careful handling, see [The print is scuffed or scratched on page 167](#).

6 Printing

- [Create a print job](#)
- [Select print quality](#)
- [Select paper size](#)
- [Select margins options](#)
- [Print with shortcuts](#)
- [Rescale a print](#)
- [Change the treatment of overlapping lines](#)
- [Preview a print](#)
- [Print a draft](#)
- [High-quality printing](#)
- [Print in gray shades](#)
- [Print with no margins](#)
- [Print with crop lines](#)
- [Use paper economically](#)
- [Nest jobs to save roll paper](#)
- [Use ink economically](#)

Create a print job

In order to print something, you must send it to the printer. This constitutes a print job, which is entered into the printer's print queue. There are two main ways of sending a print job to the printer:

- To print directly from a program, use the program's Print command as usual. When you select your HP Designjet printer, the printer driver is invoked to send your job to the printer.
- If you have a file that is already in a supported graphical format, you can use the Embedded Web Server to send it directly to the printer without going through a printer driver (see below).

Using the Embedded Web Server to print files

From HP Easy Printer Care or the Embedded Web Server, select **Job Center > Submit Job**. You will see the window below.

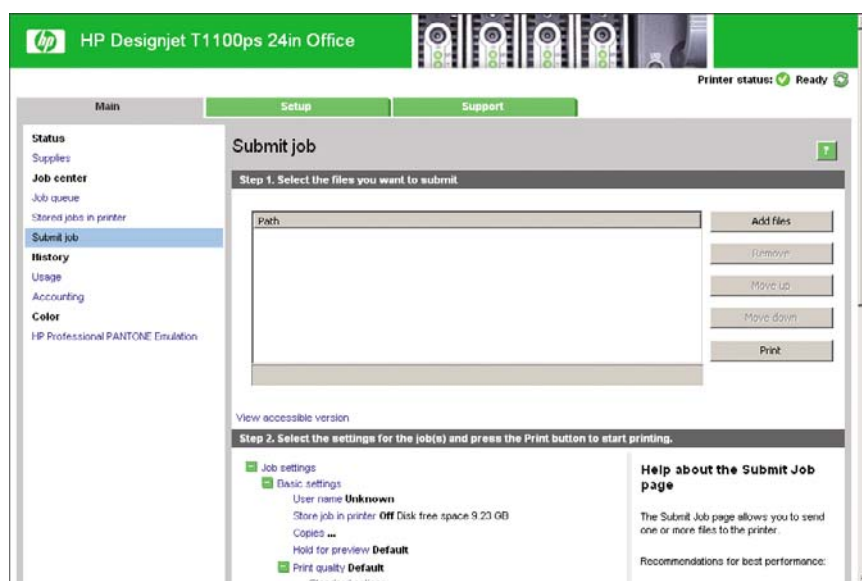

Press the **Add files** button to choose the files from your computer that you want to print. The files must be in one of the following formats:

- PDF (HP Designjet T1100ps only)
- PostScript (HP Designjet T1100ps only)
- TIFF (HP Designjet T1100ps only)
- JPEG (HP Designjet T1100ps only)
- HP-GL/2
- RTL
- CALS/G4



NOTE: When you print to a file, the file should be in one of the above formats, but its name may have an extension such as **.plt** or **.prn**.

If the files are not in one of these formats, they will not be printed successfully.

If the jobs have been generated with the appropriate settings (such as page size, rotation, resizing, and number of copies), you can just press the **Print** button and they will be sent to the printer.

If you need to specify printing settings, go to the **Job settings** section and select the options you need. Each option has explanatory text on the right, so that you can understand the behavior of each setting. Remember that, if you leave the setting as **Default**, the setting saved in the job will be used. If the job contains no setting, the setting in the printer will be used.

Select print quality

The printer has various print-quality options because best-quality printing requires some loss of speed, while fast printing implies some reduction in print quality.

Therefore, the standard print-quality selector is a slider that allows you to choose between quality and speed. With some paper types, you can choose a compromise position between the two.

Alternatively, you can select from the custom options: **Best**, **Normal**, and **Fast**. If you select **Fast**, you can also select **Economode**, which uses a lower rendering resolution and consumes less ink. It therefore increases printing speed even further, but reduces print quality. **Economode** can be selected only from the custom options (not from the slider).

There is also a supplementary custom option that may have an effect on print quality: **Maximum detail**. See [High-quality printing on page 66](#).



NOTE: In the Windows driver dialog, the rendering resolution for your job is displayed in the Custom Print Quality Options dialog box. In the Mac OS Print dialog, it is displayed in the **Summary** panel.

You can select print-quality options in the following ways:

- **In the Windows driver dialog:** go to the **Paper/Quality** tab and look at the Print Quality section. If you select **Standard Options**, you will see a simple slider with which you can select speed or quality. If you select **Custom Options**, you will see the more specific options described above.
- **In the Mac OS Print dialog (T1100):** go to the **Paper Type/Quality** panel and select **Paper**. If you select **Standard** quality options, you will see a simple slider with which you can select speed or quality. If you select **Custom** quality options, you will see the more specific options described above.
- **In the Mac OS Print dialog (T1100ps):** go to the **Image Quality** panel. If you select **Standard** quality options, you will see a simple slider with which you can select speed or quality. If you select **Custom** quality options, you will see the more specific options described above.
- **On the Embedded Web Server's Submit Job page:** select **Basic settings > Print quality**. If you then select **Standard options**, you can choose between **Speed** and **Quality**. If you select **Custom options**, you will see the more specific options described above.
- **Using the front panel:** select the Setup menu icon , then **Printing preferences > Print quality**.



NOTE: If the print quality is set from your computer, it overrides the print-quality setting in the front panel.



NOTE: You cannot change the print quality of pages that the printer is already receiving or has already received (even if they have not started to print yet).

Select paper size

The paper size can be specified in the following ways.



NOTE: The paper size specified here should be the paper size in which the document was created. It is possible to rescale the document to a different size for printing. See [Rescale a print on page 64](#).

- **In the Windows driver dialog:** select the **Paper/Quality** tab, then **Document Size**.
- **In the Mac OS Page Setup dialog:** select your printer from the **Format for** list, then select your paper size from the **Paper Size** list.
- **On the Embedded Web Server's Submit Job page:** select **Advanced settings > Paper > Page size > Standard**.
- **Using the front panel:** select the Setup menu icon , then **Printing preferences > Paper > Select paper size**.



NOTE: If the paper size is set from your computer, it overrides the paper size setting in the front panel.

Custom paper sizes

To choose a non-standard paper size not shown in the list of paper sizes:

- **Under Windows**, there are two different ways:
 - In the driver dialog, select **Custom** from the paper size list in the **Paper/Quality** tab, then specify the paper dimensions, then click **Save** to save your new paper size. To see your new custom size in the list of custom sizes, you need to exit the printer properties, then reenter them (and use the **More** button if necessary).
 - From the **Start** menu, select **Printers and Faxes**, then from the **File** menu select **Server Properties**. In the **Forms** tab, check the **Create a new form** box, specify the name and dimensions of the new form, then click **Save Form**.
- **Under Mac OS X 10.4:** select **Paper Size > Manage Custom Sizes** in the **Page Setup** dialog.
- **Under Mac OS X 10.2 or 10.3:** select **Settings > Custom Paper Size** from the **Page Setup** dialog.
- **On the Embedded Web Server's Submit Job page:** select **Advanced settings > Paper > Page size > Custom**.

Select margins options

By default, the printer leaves a 5 mm margin between the edges of your image and the edges of the paper (increased to 17 mm at the foot of cut-sheet paper). However, you can change this behavior in several ways.

- **In the Windows driver dialog:** select the **Paper/Quality** tab and then the **Margins/Layout** button.
- **In the Mac OS Print dialog (T1100):** select the **Paper Type/Quality** panel and then **Layout**.
- **In the Mac OS Print dialog (T1100ps):** select the **Finishing** panel and then **Layout**.
- **On the Embedded Web Server's Submit Job page:** select **Advanced settings > Paper > Layout/Margins**.

You will then see at least some of the following options.



NOTE: Under Mac OS, the available margins options depend on the paper size selected in the **Page Setup** dialog. For instance, for borderless printing you must select a paper size name that includes the words “no margins”.

- **Standard.** Your image will be printed on a page of the size you have selected, with a narrow margin between the edges of the image and the edges of the paper. The image should be small enough to fit between the margins.
- **Oversize.** Your image will be printed on a page slightly larger than the size you have selected. If you cut off the margins, you will be left with a page of the size you selected, with no margins remaining between your image and the edges of the paper.
- **Clip Contents By Margins.** Your image will be printed on a page of the size you have selected, with a narrow margin between the edges of the image and the edges of the paper. In this case, if the image is the same size as the page, the printer assumes that the extreme edges of the image are either white or unimportant, and do not need to be printed. This may be useful when your image already contains a border.
- **Borderless.** Your image will be printed on a page of the size you have selected, with no margins. The image is slightly enlarged to ensure that no margin is left between the edges of the image and the edges of the paper. If you select **Automatically by Printer**, this enlargement is done automatically. If you select **Manually in Application**, you must select a custom page size slightly larger than the page on which you intend to print. See also [Print with no margins on page 67](#).

Print with shortcuts

The printer driver provides many options that can be set to different values when printing a particular job. A printing shortcut stores the values of all these options that are appropriate for a particular kind of job, so that you can set them all with a single click. Some settings (such as paper size, paper source, and orientation) may be overridden by the values provided by your application.

To use a shortcut, select the **Printing Shortcuts** tab in the Windows driver dialog.



NOTE: Shortcuts are available only under Windows.

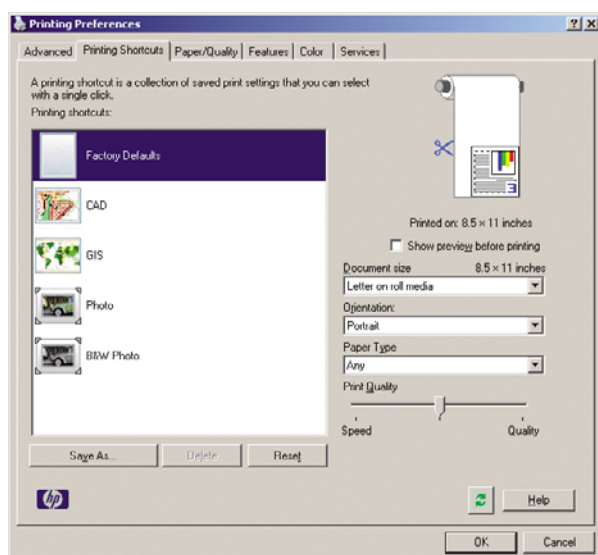

You can see a list of available shortcuts; select the one that matches the kind of job you want to print.

The driver options are now adjusted to suit your job. You can either print immediately, or examine the settings to check that you agree with them. If you like, you can select a shortcut and then change some of its settings manually.



TIP: Check at least the settings that you can see in the **Printing Shortcuts** tab: the document size, orientation, etc.

The Factory Defaults shortcut contains the printer's default settings. When you click on it, it sets all options to their default values.

Printing shortcuts can be customized to your particular needs. To create your own shortcut:

1. Select the shortcut that comes closest to satisfying your requirements.
2. Change any value in the **Printing Shortcuts** tab and/or other tabs.
3. Save the new printing shortcut.

If you decide later that you no longer want a shortcut, you can delete it.

Rescale a print

You can send an image to the printer at a certain size but tell the printer to rescale it to a different size (normally larger). This may be useful:

- If your software does not support large formats
- If your file is too large for the printer's memory—in this case, you can reduce the paper size in your software and then scale it up again using the front-panel option

You can rescale an image in the following ways:

- **In the Windows driver dialog:** select the **Effects** tab, then **Resizing options**.
 - The **Print document on** option adjusts the image size to the paper size you have selected. For example, if you have selected ISO A2 as the paper size and you print an A3-sized image, it is enlarged to fit the A2 paper. If the ISO A4 paper size is selected, the printer reduces a larger image to fit the A4 size.
 - The **% of normal size** option enlarges the printable area of the original paper size (the page minus the margins) by the percentage indicated, then adds the margins to create the output paper size.
- **In the Mac OS Print dialog (T1100):** select the **Paper Handling** panel, then **Scale to fit paper size**, and select the paper size to which you want to scale the image. If you want to increase the size of the image, make sure that the **Scale down only** box is unchecked.
- **In the Mac OS Print dialog (T1100ps):** select the **Finishing** panel, then **Print document on**, and select the paper size to which you want to scale the image. For example, if you have selected ISO A2 as the paper size and you print an A3-sized image, it is enlarged to fit the A2 paper. If the ISO A4 paper size is selected, the printer reduces a larger image to fit the A4 size.
- **On the Embedded Web Server's Submit Job page:** select **Advanced settings > Resizing**.
 - The **Standard** and **Custom** options adjust the image size to the standard or custom paper size you have selected. For example, if you have selected ISO A2 as the paper size and you print an A4-size image, it is enlarged to fit the A2 paper. If the ISO A3 paper size is selected, the printer reduces a larger image to fit the A3 size.
 - The **% of actual size** option enlarges the printable area of the original paper size (the page minus the margins) by the percentage indicated, then adds the margins to create the output paper size.
- **Using the front panel:** select the Setup menu icon , then **Printing preferences > Paper > Resize**.

If you are printing to a single sheet, you must ensure that the image can actually fit onto the sheet, otherwise the image will be clipped.

Change the treatment of overlapping lines



NOTE: This topic applies only when printing an HP-GL/2 job.

The merge option controls the overlapping lines in an image. There are two settings:

- Off: where the lines cross, only the color of the top line is printed.
- On: where the lines cross, the colors of the two lines merge.

To turn merge on, go to the front panel and select the Setup menu icon , then **Printing preferences > HP-GL/2 > Enable merge**. You can set the merge option from your software in some applications. Settings in your software override the front-panel settings.

Preview a print

Previewing a print on the screen allows you to check the layout of the print before printing, which may help you to avoid wasting paper and ink on a bad print.

- To preview a print under Windows, you have the following options:
 - Use your application's print preview option.
 - Check the **Show preview before printing** option, which you can find in the driver's **Printing Shortcuts** tab, **Paper/Quality** tab, and **Features** tab. When you later click the **Print** button, your job will be sent to the printer, which will display the print preview on your screen. You can use the preview to check the print settings and the layout of the image, and then click **Print** to proceed with printing or **Cancel** to cancel the job.
- To preview a print under Mac OS, you have the following options:
 - Use your application's print preview option.
 - Click the **Preview** button at the bottom of the Print dialog box. This is the basic print preview provided by Mac OS.
 - If you are using the PostScript driver (with the T1100ps), check the **Show print preview** option, which you can find in the driver's **Printing** dialog, in the **Finishing** panel. This preview is provided by the Embedded Web Server and will appear in a Web browser window.
 - If you are using the PCL driver (with the T1100), click the **PDF** button at the bottom of the Print dialog box, then click **HP Print Preview**. This provides a preview with more features, such as the ability to change paper size, paper type, and print quality, and to rotate the image.



NOTE: HP Print Preview is not available if you are using Adobe InDesign, Adobe Illustrator, Adobe Reader, or Apple Aperture.

- To preview a print using the Embedded Web Server, select **Basic settings > Hold for preview**.

Print a draft

You can specify fast draft-quality printing in the following ways:

- **In the Windows driver dialog:** go to the **Paper/Quality** tab and look at the Print Quality section. Move the print-quality slider to the extreme left ('Speed').
- **In the Mac OS Print dialog (T1100):** go to the **Paper Type/Quality** panel and select **Paper**, then move the print-quality slider to the extreme left ('Speed').
- **In the Mac OS Print dialog (T1100ps):** go to the **Image Quality** panel and move the print-quality slider to the extreme left ('Speed').
- **On the Embedded Web Server's Submit Job page:** select **Basic settings > Print quality > Standard options > Speed**.
- **Using the front panel:** select the Setup menu icon , then **Printing preferences > Print quality > Select quality level > Fast**.

You can specify even faster draft-quality printing by using Economode, as follows. This is intended mainly for documents containing only text and line drawings.

- **In the Windows driver dialog:** go to the **Paper/Quality** tab and look at the Print Quality section. Select **Custom Options**, then set the quality level to **Fast** and check the **Economode** box.
- **In the Mac OS Print dialog (T1100):** go to the **Paper Type/Quality** panel and select **Paper**, then set the quality options to **Custom**, set quality to **Fast**, and check the **Economode** box.
- **In the Mac OS Print dialog (T1100ps):** go to the **Image Quality** panel and set the quality options to **Custom**, then set quality to **Fast**, and check the **Economode** box.
- **On the Embedded Web Server's Submit Job page:** select **Basic settings > Print quality > Custom**. Set **Quality level** to **Fast**, and **Economode** to **On**.
- **Using the front panel:** select the Setup menu icon , then **Printing preferences > Print quality > Enable economode**.



NOTE: If the print quality is set from your computer, it overrides the print-quality setting in the front panel.

High-quality printing

You can specify high-quality printing in the following ways:

- **In the Windows driver dialog:** go to the **Paper/Quality** tab and look at the Print Quality section. Move the print-quality slider to the extreme right ('Quality').
- **In the Mac OS Print dialog (T1100):** go to the **Paper Type/Quality** panel and select **Paper**, then move the print-quality slider to the extreme right ('Quality').
- **In the Mac OS Print dialog (T1100ps):** go to the **Image Quality** panel and move the print-quality slider to the extreme right ('Quality').
- **On the Embedded Web Server's Submit Job page:** select **Basic settings > Print quality > Standard options > Quality**.
- **Using the front panel:** select the Setup menu icon , then **Printing preferences > Print quality > Select quality level > Best**.



NOTE: If the print quality is set from your computer, it overrides the print-quality setting in the front panel.

If you have a high-resolution image

If your image has a resolution greater than the rendering resolution (which you can see in the Custom Print Quality Options box under Windows), print sharpness may be improved by selecting the Maximum Detail option. This option is available only if you are printing on glossy paper and you have selected **Best** print quality.

- **In the driver dialog (Mac OS Print dialog):** select Custom instead of Standard print-quality options, then check the **Maximum Detail** box.
- **On the Embedded Web Server's Submit Job page:** select **Basic settings > Print quality > Custom**. Set **Quality level** to **Best**, and **Maximum detail** to **On**.
- **Using the front panel:** select the Setup menu icon , then **Printing preferences > Print quality > Enable maximum detail**.



NOTE: The Maximum Detail option results in slower printing with photo papers, but it does not increase the amount of ink used.

Print in gray shades

You can convert all colors in your image to shades of gray in the following ways:

- **In your application program:** many programs provide this option.
- **In the Windows driver dialog:** go to the **Color** tab and look at the Color Options section. Select **Print In Grayscale**. You can also select **Print in Pure black and white** if you want only black and white, without gray shades.
- **In the Mac OS Print dialog (T1100):** go to the **Paper Type/Quality** panel and select **Color**, then select **Print In Grayscale**. You can also select **Pure Black and White** if you want only black and white, without gray shades.
- **In the Mac OS Print dialog (T1100ps):** go to the **Color Options** panel and select **Print In Grayscale**. You can also select **Pure Black and White** if you want only black and white, without gray shades.
- **On the Embedded Web Server's Submit Job page:** select **Color > Print in Monochrome**.

Print with no margins

Printing with no margins (to the edges of the paper) is known as borderless printing. This can be done only on rolls of glossy paper.

In order to be sure of leaving no margins, the printer prints slightly past the edges of the paper. Any ink deposited outside the paper is absorbed by the sponge situated in the platen.

You can request printing with no margins in the following ways:

- **In the Windows driver dialog:** select the **Paper/Quality** tab and press the **Margins/Layout** button. Then select **Borderless**.
- **In the Mac OS Page Setup dialog (T1100):** select a paper size name that includes the words "no margins". Then, in the **Print** dialog, select **Paper Type/Quality > Layout > Borderless**.

- **In the Mac OS Page Setup dialog (T1100ps):** select a paper size name that includes the words “no margins”. Then, in the **Print** dialog, select **Finishing > Layout > Borderless**.
- **On the Embedded Web Server's Submit Job page:** select **Advanced settings > Paper > Layout/Margins > Borderless**.

When you select **Borderless**, you must also select one of the following Image Enlargement options:

- **Automatically by printer** means that the printer automatically enlarges your image slightly (normally by a few millimeters in each direction) in order to print over the edges of the paper.
- **Manually in application** means that you must enlarge the image yourself in your application, and select a custom paper size that is slightly larger than the actual paper size.



NOTE: If the first print job after loading paper is a borderless job, the printer may trim the leading edge of the paper before printing.

At the end of a borderless print, the printer normally cuts the print slightly inside the image area to ensure that the print is borderless. It then cuts the paper again so that no residual part of the image is included in the next print. However, if the job is cancelled, or if there is white space at the bottom of the image, only a single cut is made.

Print with crop lines

Crop lines indicate where the paper should be cut to reduce it to your selected page size. You can print crop lines with individual jobs in the following ways:

- **In the Windows driver dialog:** select the **Features** tab and then **Crop lines**.
- **In the Mac OS Print dialog (T1100):** select the **Paper Type/Quality** panel, then **Paper > Crop lines**.
- **In the Mac OS Print dialog (T1100ps):** select the **Finishing** panel, then **Crop lines**.
- **On the Embedded Web Server's Submit Job page:** select **Advanced settings > Roll options > Enable crop lines > Yes**.

Alternatively, you can choose to print crop lines with all jobs by default:

- **In the Embedded Web Server:** select **Setup > Printer settings > Job management > Use crop lines when printing > On**.
- **Using the front panel:** select the Setup menu icon , then **Printing preferences > Paper > Enable crop lines > On**.

To print crop lines with nested jobs (see [Nest jobs to save roll paper on page 69](#)), you must select a different option:

- **In the Embedded Web Server:** select **Setup > Printer settings > Job management > Use crop lines when nest is enabled > On**.
- **Using the front panel:** select the Setup menu icon , then **Job management > Nest options > Enable crop lines > On**.

Use paper economically

Here are some recommendations for making economical use of paper:

- If you are printing relatively small images or document pages, you can use nesting to print them side by side instead of one after another. See [Nest jobs to save roll paper on page 69](#).
- You may be able to save some roll paper by using the following options:
 - **In the Windows driver dialog:** select the **Features** tab and then **Remove top/bottom blank areas** and/or **Rotate by 90 degrees**.
 - **In the Mac OS Print dialog (T1100):** select the **Paper Type/Quality** panel, then **Paper**, then **Remove Top/Bottom Blank Areas**.
 - **In the Mac OS Print dialog (T1100ps):** select the **Finishing** panel, then **Remove Top/Bottom Blank Areas** and/or **Rotate by 90 degrees**.
 - **On the Embedded Web Server's Submit Job page:** select **Advanced settings > Roll options > Remove top/bottom blank areas** and/or **Rotate**.
- If you check the print preview on your computer before printing, you can sometimes avoid wasting paper on prints containing obvious mistakes. See [Preview a print on page 65](#).

Nest jobs to save roll paper

Nesting means automatically printing images or document pages side by side on the paper, rather than one after the other. This is done to avoid wasting paper.

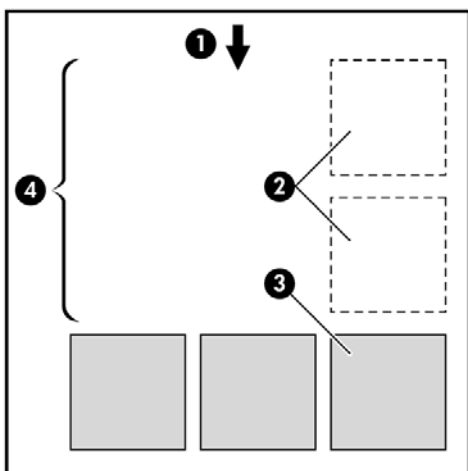

1. Direction of paper flow
2. Nesting off
3. Nesting on
4. Paper saved by nesting

When does the printer try to nest pages?

When both of the following are true:

- The printer is loaded with roll paper, not sheet paper.
- The printer's **Nest** option is not turned off. See [Turn nesting on and off on page 22](#).

What pages can be nested?

All pages can be nested, unless they are so large that two of them cannot fit side by side on the roll, or unless there are too many of them to fit into the remaining length of the roll. A single group of nested pages cannot be split between two rolls.

Which pages qualify for nesting?

In order to be in the same nest, the individual pages must be compatible in all of the following ways:

- All pages must have the same print quality setting (**Economode**, **Fast**, **Normal**, or **Best**).
- The **Maximum Detail** setting must be the same on all pages.
- The **Layout/Margins** setting must be the same for all pages.
- The **Mirror Image** setting must be the same for all pages.
- The **Rendering Intent** must be the same for all pages.
- The **Cutter** setting must be the same for all pages.
- The color adjustment settings must be the same for all pages. See [Color adjustment options on page 77](#).
- Pages must be all color, or all grayscale: not some in color and some in grayscale.
- All pages must be in one or other of the following two groups (the two groups cannot be mixed in the same nest):
 - HP-GL/2, RTL, CALS/G4
 - PostScript, PDF, TIFF, JPEG
- JPEG, TIFF, and CALS/G4 pages with resolutions greater than 300 dpi may not nest with other pages in some cases.

How long does the printer wait for another file?

So that the printer can make the best nest possible, it waits after a file has been received to check whether a subsequent page will nest with it or with pages already in the queue. This waiting period is the nest wait time; the factory default nest wait time is two minutes. This means that the printer waits for up to two minutes after the last file is received before printing the final nest. You can change this

waiting time from the printer's front panel: select the Setup menu icon , then **Job management options > Nest options > Select wait time**. The available range is 1 to 99 minutes.

While the printer is waiting for nesting to time out, it displays the remaining time on the front panel. You can print the nest (cancel the nest wait) by pressing the **Form feed and cut** key.

Use ink economically

Here are some recommendations for making economical use of ink.

- For draft prints, use plain paper and move the print-quality slider to the left end of the scale ('Speed'). For further economy, select custom print quality options, then select **Fast** and **Economode**.
- Clean the printheads only when needed, and clean only those printheads that need cleaning. Cleaning the printheads can be useful, but it uses a small amount of ink.

- Leave the printer permanently turned on so that it can maintain the printheads in good condition automatically. This regular printhead maintenance uses a small amount of ink. However, if it is not done, the printer may need to use much more ink later to restore the health of the printheads.
- Wide prints make more efficient use of ink than narrow prints, because printhead maintenance uses some ink, and its frequency is related to the number of passes made by the printheads. Therefore, nesting jobs can save ink as well as saving paper (see [Nest jobs to save roll paper on page 69](#)).

7 Color management

- [Introduction](#)
- [How colors are represented](#)
- [A summary of the color management process](#)
- [Color calibration](#)
- [Color management from printer drivers](#)
- [Color management from printer drivers \(T1100ps only\)](#)
- [Color management from the Embedded Web Server](#)
- [Color management from the front panel](#)

Introduction

HP Designjet T1100 printers have been engineered with advanced hardware and software features to ensure predictable and dependable results.

- Color calibration for consistent colors.
- One gray and two black inks provide neutral grays on all paper types.
- The Photo Black ink provides pure blacks when printing on photo papers.
- Color emulation of other HP Designjet printers.

How colors are represented

All devices that display color use a color model to represent color in numerical terms. Most monitors use the RGB (Red-Green-Blue) color model, while most printers use the CMYK (Cyan-Magenta-Yellow-black) color model.

An image can be converted from one color model to another, but in general the conversion is not perfect. Your printer uses the RGB color model: the same color model that is used by your monitor.

This simplifies but does not completely solve the problem of matching colors. Each device represents colors a little differently from another device, even if they use the same color model. However, software can adjust the colors in an image according to the characteristics of the particular device, using a color profile of the device, in order to achieve correct colors.

A summary of the color management process

To get the accurate and consistent colors that you want, you should follow these steps for each paper type that you use.

1. Color-calibrate the paper type, for consistent colors. Calibration should be repeated every now and then (see [Color calibration on page 74](#)). In addition, you may wish to calibrate immediately before a particularly important print job for which color consistency is vital.
2. When printing, select the correct color profile for the paper type you are using.

Color calibration

Color calibration enables your printer to produce consistent colors with the particular printheads, inks, and paper type that you are using, and under your particular environmental conditions. After color calibration, you can expect to get similar prints from any two different printers situated in different geographical locations.

Some paper types cannot be calibrated. For all other paper types, calibration should be done in any of the following circumstances:

- Whenever a printhead is replaced
- Whenever a new paper type is introduced that has not yet been calibrated with the current set of printheads
- Whenever the environmental conditions (temperature and humidity) change significantly

You can check the color calibration status of the currently loaded paper at any time by pressing the **View loaded paper** key on the front panel. The status may be one of the following:

- **PENDING:** the paper has not been calibrated.



NOTE: Whenever you update the printer's firmware, the color calibration status of all papers is reset to **PENDING**.

- **OBSOLETE:** the paper has been calibrated, but the calibration is now out of date because a printhead has been replaced, and should be repeated.
- **DONE:** the paper has been calibrated, and the calibration is up to date.
- **DISABLED:** this paper cannot be calibrated.



NOTE: Color calibration cannot be performed on plain paper, nor on any kind of transparent material.

You can also check the color calibration status by using HP Easy Printer Care (Windows) or HP Printer Utility (Mac OS).

You should calibrate a paper type before creating its color profile; however, you can later recalibrate without needing to recreate the color profile.

You can start color calibration in the following ways:

- From the printer alert that recommends calibration.
- From the HP Color Center: select **Calibrate Your Printer**.
- From the front panel: select the Image Quality Maintenance menu icon , then **Calibrate color**.

The calibration process is fully automatic and can be performed unattended after you have loaded paper of the type you wish to calibrate—which should be A3 or any larger size.

The process takes about 3–5 minutes and consists of the following steps.

1. A calibration chart is printed, which contains patches of each ink used in your printer.

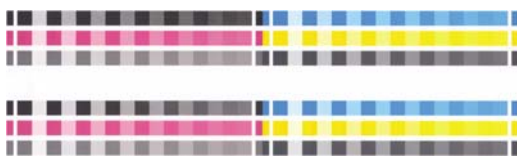

2. The chart is allowed to dry for a period of time that depends on the paper type, so that the colors have time to stabilize.
3. The chart is scanned and measured.
4. From the measurements, the printer calculates the necessary correction factors to apply for consistent color printing on that paper type. It also calculates the maximum amount of each ink that can be applied to the paper.

Color management from printer drivers

These facilities are available for the HP Designjet T1100 and T1100ps printers.

Color management options

The aim of color management is to reproduce colors as accurately as possible on all devices: so that, when you print an image, you see very similar colors as when you view the same image on your monitor.

There are two basic approaches to color management for your printer:

- **Application-Managed Colors:** in this case your application program must convert the colors of your image to the color space of your printer and paper type, using the ICC profile embedded in the image and the ICC profile of your printer and paper type.
- **Printer-Managed Colors:** in this case your application program sends your image to the printer without any color conversion, and the printer converts the colors to its own color space. The details of this process depend on the graphics language that you are using.
 - **PostScript:** the PostScript interpreter module inside the printer performs the color conversion using the profiles stored in the printer and any additional profiles sent with the PostScript job. This kind of color management is done when you are using the PostScript driver and you specify printer color management or when you send a PostScript, PDF, TIFF, or JPEG file directly to the printer through the Embedded Web Server. In either case you have to select the profiles to use as default (in case the job doesn't specify any) and the rendering intent to apply.
 - **Non-PostScript (PCL, RTL, HP-GL/2):** the color management is done using a set of stored color tables. ICC profiles are not used. This method is somewhat less versatile than the previous methods, but is a little simpler and faster, and can produce good results with standard HP paper types. This kind of color management is done when you are using a non-PostScript driver and you specify printer color management, or when you send a PCL, RTL, or HP-GL/2 file directly to the printer through the Embedded Web Server.



NOTE: There are only two color spaces that the printer can convert to its own color space using the stored color tables: Adobe RGB and sRGB if you are using Windows, Adobe RGB and ColorSync if you are using Mac OS.

ColorSync is the Mac OS built-in Color Management System; so, in fact, when selecting ColorSync it is the built-in color management part of Mac OS that is performing the color management, and it is done based on the ICC profiles of specified paper type. ColorSync is available with the PCL driver only.

You are recommended to consult the Knowledge Center at http://www.hp.com/go/knowledge_center/djt1100/ to see how to use the color management options of your particular application.

To choose between **Application-Managed Colors** and **Printer-Managed Colors**:

- **In the Windows driver dialog:** select the **Color** tab.
- **In the Mac OS Print dialog (T1100):** select the **Paper Type/Quality** panel, then **Color**.
- **In the Mac OS Print dialog (T1100ps):** select the **Color Options** panel.
- **In some applications:** you can make this choice in the application.

Printer emulation

If you want to print a particular job and to see approximately the same colors that you would get from printing the same job on a different HP Designjet printer, you can use the emulation mode provided by your printer.



NOTE: This option is available only when printing an HP-GL/2, PostScript, or PDF job. It will work correctly only when printing on plain, coated, or heavyweight coated paper.

- **In the Windows HP-GL/2 or PostScript driver dialog:** select the **Color** tab, then **Printer Managed Colors**, then select **Printer Emulation** from the Source Profile list. You can then select from the Emulated Printer list.
- **In the Mac OS Print dialog (T1100):** select the **Paper Type/Quality** panel, then **Color > Printer Managed Colors > Emulated Printer**.
- **In the Mac OS Print dialog (T1100ps):** select the **Color Options** panel, then **Basic > Printer Emulation**.

Color adjustment options

The aim of color management is to print accurate colors. If you perform color management correctly, then you should be able to print accurate colors with no need of any manual color adjustments.

However, manual adjustments may be useful in the following situations:

- If your color management is not working correctly for some reason
- If you want colors that are subjectively pleasing rather than accurate

The printer driver provides different adjustment facilities depending on whether you are printing in color or in grayscale. If you are printing in pure black and white, there are no color adjustment options.

Printing in color

You can adjust the colors of your print in similar ways under Windows and Mac OS:

- **In the Windows driver dialog:** select the **Color** tab, ensure that the **Advanced Color Adjustments** box is checked, then press the **Settings** button beside it.
- **In the Mac OS Print dialog (T1100):** select the **Paper Type/Quality** panel, then **Lightness and Hue**.
- **In the Mac OS Print dialog (T1100ps):** select the **Color Options** panel, then **Lightness and Hue**.

Under either operating system, you will then be able to make adjustments using a lightness slider and three color sliders.

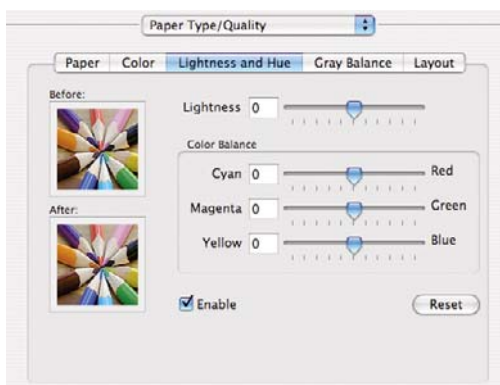

- The lightness slider simply makes the whole print lighter or darker.
- The color sliders can be used to fade or emphasize each of the primary colors in the print. The primary colors may be red, green, and blue; or cyan, magenta, and yellow; depending on the color model used in the image.

The **Reset** button restores each slider to its default central position.

Printing in grayscale

You can adjust the gray balance of your print in similar ways under Windows and Mac OS:

- **In the Windows driver dialog:** select the **Color** tab, ensure that the **Advanced Color Adjustments** box is checked, then press the **Settings** button beside it.
- **In the Mac OS Print dialog (T1100):** select the **Paper Type/Quality** panel, then **Gray balance**.
- **In the Mac OS Print dialog (T1100ps):** select the **Color Options** panel, then **Gray balance**.

Under either operating system, you will then be able to make adjustments using separate controls for highlights, midtones, and shadows.

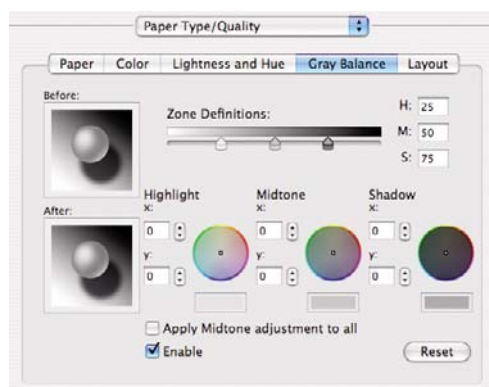

- The lightness slider simply makes the whole print lighter or darker. This slider is available under Windows in the same window as the other grayscale controls; it is available under Mac OS by selecting **Lightness and Hue**.
- The zone definition sliders can be used to define what you mean by highlight, midtone, and shadow.
- The other controls for highlight, midtone, and shadow can be used to adjust the gray balance of highlights, midtones, and shadows respectively.

The **Reset** button restores each control to its default setting.

Color management from printer drivers (T1100ps only)

This facility is available when printing on the HP Designjet T1100ps with the PostScript driver.

HP Professional PANTONE Emulation

When you use a named PANTONE color in an image, your application will normally send to the printer a CMYK or RGB approximation to that color. But the application does not take the printer or the paper type into account, it merely produces a generic approximation of the PANTONE color, which will look different on different printers and on different papers.

HP Professional PANTONE Emulation can do a much better job by taking into account the characteristics of the printer and the paper type. The results look as similar to the original PANTONE colors as is possible on a given printer using a given paper type. This technology is designed to produce emulations similar to those set up manually by prepress professionals.

To use HP Professional PANTONE Emulation, all you have to do is to turn it on. In fact, it is normally on by default.

- **In the Windows PostScript driver dialog:** go to the **Color** tab and select **HP Professional PANTONE Emulation**.
- **In the Mac OS Print dialog:** go to the **Color Options** panel and select **HP Professional PANTONE Emulation**.

You can also use the Embedded Web Server to print a swatch book showing emulations of PANTONE colors as made by your printer, together with a measure of the color difference (ΔE) between each emulation and the original PANTONE spot color. So HP Professional PANTONE Emulation not only provides the closest match that can be achieved on your printer; it also gives clear information on how close the emulation is to the original spot color. See [Printing PANTONE swatch books on page 81](#).

Color emulation

Your printer can emulate the color behavior of other devices: RGB devices such as monitors, and CMYK devices such as presses and printers.

You can set color emulation in the following ways:

- **In the Windows PostScript driver dialog:** select the **Color** tab, and **Printer Managed Colors**.
- **In the Mac OS Print dialog:** select the **Color Options** panel, and **Printer Managed Colors**.

For a good emulation, the printer needs a specification of the colors these devices can reproduce. The standard way of encapsulating such information is in ICC profiles. As part of the solution, we provide the most common standards for the different devices.

The options are as follows.

CMYK color emulation

A traditional workflow defines color in the CMYK space. For best results, the colors must be adjusted to the printer, because different printers will produce different colors from the same CMYK data. If the image file you are printing was not created specifically for your HP Designjet printer, it will require some readjustment, which can be done using one of the following options provided with your printer.

- **None (Native):** no emulation. The printer will use its default internal conversion from CMYK to RGB, without following any color standard. This does not imply that results will be bad
- **U.S. Web Coated (SWOP) 2** uses specifications designed to produce quality separations using U.S. inks under the following printing conditions: 300% total area of ink coverage, negative plate, coated publication-grade stock.
- **U.S. Web Uncoated 2** uses specifications designed to produce quality separations using U.S. inks under the following printing conditions: 260% total area of ink coverage, negative plate, uncoated white offset stock.
- **U.S. Sheetfed Coated 2** uses specifications designed to produce quality separations using U.S. inks under the following printing conditions: 350% total area of ink coverage, negative plate, bright white offset stock.
- **U.S. Sheetfed Uncoated 2** uses specifications designed to produce quality separations using U.S. inks under the following printing conditions: 260% total area of ink coverage, negative plate, uncoated white offset stock.
- **Europe ISO Coated FOGRA27** is designed to produce quality separations for standard ISO 12647 printing under the following printing conditions: 350% total ink coverage, positive film, coated paper.

- **Euroscale Uncoated 2** uses specifications designed to produce quality separations using Euroscale inks under the following printing conditions: 260% total area of ink coverage, positive plate, uncoated white offset stock.
- **Japan Web Coated (Ad)** uses specifications developed by the Japan Magazine Publisher Association for digital proofing of images in the Japanese magazine/advertising market.
- **Japan Color 2001 Coated** uses the Japan Color 2001 specification for type 3 (coated) paper. It is designed to produce quality separations using 350% total ink coverage, positive film, and coated paper.
- **Japan Color 2001 Uncoated** uses the Japan Color 2001 specification for type 4 (uncoated) paper. It is designed to produce quality separations using 310% total ink coverage, positive film, and uncoated paper.
- **Japan Color 2002 Newspaper** uses the Japan Color 2002 for Newspapers specification. It is designed to produce quality separations using 240% total ink coverage, positive film, and standard newsprint paper.
- **JMPA**: Japanese standard for offset press.
- **Toyo** is designed to produce quality separations for Toyo printing presses.
- **DIC** is designed to produce quality separations for Dainippon Ink Company printing presses.



NOTE: These options have no effect if the application is defining its own CMYK space, known as calibrated CMYK or CIEBasedDEFB in PostScript terminology.

RGB color emulation

Your printer is provided with the following color profiles:

- **None (Native)**: no emulation, for use when the color conversion is done by the application or operating system, and therefore the data arrive at the printer already color-managed.
- **sRGB IEC61966-2.1** emulates the characteristics of the average PC monitor. This standard space is endorsed by many hardware and software manufacturers, and is becoming the default color space for many scanners, printers, and software applications.
- **ColorMatch RGB** emulates the native color space of Radius Pressview monitors. This space provides a smaller gamut alternative to Adobe RGB (1998) for print production work.
- **Apple RGB** emulates the characteristics of the average Apple monitor, and is used by a variety of desktop publishing applications. Use this space for files that you plan to display on Apple monitors, or for working with old desktop publishing files.
- **Adobe RGB (1998)** provides a fairly large gamut of RGB colors. Use this space if you need to do print production work with a broad range of colors.

Color management from the Embedded Web Server

Submit Job options

When you send jobs to the printer using the Embedded Web Server's **Submit Job** page, you have the following color management options.

If you leave an option set to **Default**, the setting saved in the job will be used. If the job contains no setting, the front-panel setting in the printer will be used.

T1100 and T1100ps options

- **Color/Grayscale:** you can choose to print in color, in shades of gray, or in pure black and white.
- **Default RGB source profile:** you can choose from a selection of RGB source profiles recognized by the printer.
- **Printer emulation:** you can choose to emulate a different HP Designjet printer. Default: **Off** (no printer emulation).

T1100ps options (with PostScript or PDF jobs)

- **Default CMYK source profile:** you can choose from a selection of CMYK source profiles recognized by the printer. Default: **Europe ISO Coated FOGRA27**.
- **Rendering intent:** you can select the rendering intent.
- **Black point compensation:** you can turn black point compensation on or off.
- **HP Professional PANTONE Emulation:** you can turn HP Professional PANTONE Emulation on or off.

Rendering intent

Rendering intent is one of the settings used when doing a color transformation. As you probably know, some of the colors you want to print may not be reproducible by the printer. The rendering intent allows you to select one of four different ways of handling these so-called out-of-gamut colors.

- **Saturation (graphics):** best used for presentation graphics, charts, or images made up of bright, saturated colors.
- **Perceptual (images):** best used for photographs or images in which colors blend together. It tries to preserve the overall color appearance.
- **Relative colorimetric (proofing):** best used when you want to match a particular color. This method is mainly used for proofing. It guarantees that, if a color can be printed accurately, it will be printed accurately. The other methods will probably provide a more pleasing range of colors but do not guarantee that any particular color will be printed accurately. It maps the white of the input space to the white of the paper on which you are printing.
- **Absolute colorimetric (proofing):** the same as relative colorimetric, but without mapping the white. This rendering is also used mainly for proofing, where the goal is to simulate the output of one printer (including its white point).

Perform black point compensation

The black point compensation option controls whether to adjust for differences in black points when converting colors between color spaces. When this option is selected, the full dynamic range of the source space is mapped into the full dynamic range of the destination space. It can be very useful in preserving shadows when the black point of the source space is darker than that of the destination space. This option is allowed only when the **Relative colorimetric** rendering intent is selected (see [Rendering intent on page 81](#)).

Printing PANTONE swatch books

You can use the Embedded Web Server to print a swatch book showing emulations of PANTONE colors as made by your printer, together with a measure of the color difference (ΔE) between each emulation and the original PANTONE spot color.

To print a swatch book, select the Embedded Web Server's **Main** tab, then **HP Professional PANTONE Emulation**. Select the PANTONE stock to emulate, then the PANTONE colors that you want to print. When you have selected all the colors you want, press the **Print** button.



Color management from the front panel

You can color-calibrate the loaded paper type from the front panel by selecting the Image Quality Maintenance menu icon , then **Calibrate color**. See [Color calibration on page 74](#).

The other color options in the front panel can all be found by selecting the Setup menu icon , then **Printing preferences > Color**.



NOTE: These front panel settings can all be overridden by the printer driver or Embedded Web Server settings.

T1100 and T1100ps options

- **Color/Grayscale:** you can choose to print in color or in shades of gray. Default: **Print in color**.
- **Select RGB source profile:** you can choose from a selection of RGB source profiles recognized by the printer. Default: **sRGB (HP)**.
- **Emulate printer:** you can choose to emulate a different HP Designjet printer. Default: **None** (no printer emulation).



TIP: If you have old HP-GL/2 or PostScript files made for a different HP Designjet printer, you can send them to the printer and use the front panel to turn on the appropriate emulation mode.

T1100ps options (with PostScript or PDF jobs)

- **Select CMYK source profile:** you can choose from a selection of CMYK source profiles recognized by the printer. Default: **Europe ISO Coated FOGRA27**.
- **Select rendering intent:** you can select the rendering intent. Default: **Perceptual**.
- **Black point compensation:** you can turn black point compensation on or off. Default: **On**.
- **HP Professional PANTONE Emulation:** you can turn HP Professional PANTONE Emulation on or off. Default: **On**.

8 Practical printing examples

- [Print a draft for revision with the correct scale](#)
- [Print a project](#)
- [Print a presentation](#)
- [Print and scale from Microsoft Office](#)

Print a draft for revision with the correct scale

This section demonstrates how to print a draft for revision with the correct scale from Adobe Acrobat.

Using Adobe Acrobat

1. In the Acrobat window, bring the mouse cursor to the bottom left corner of the screen to check the plot size.

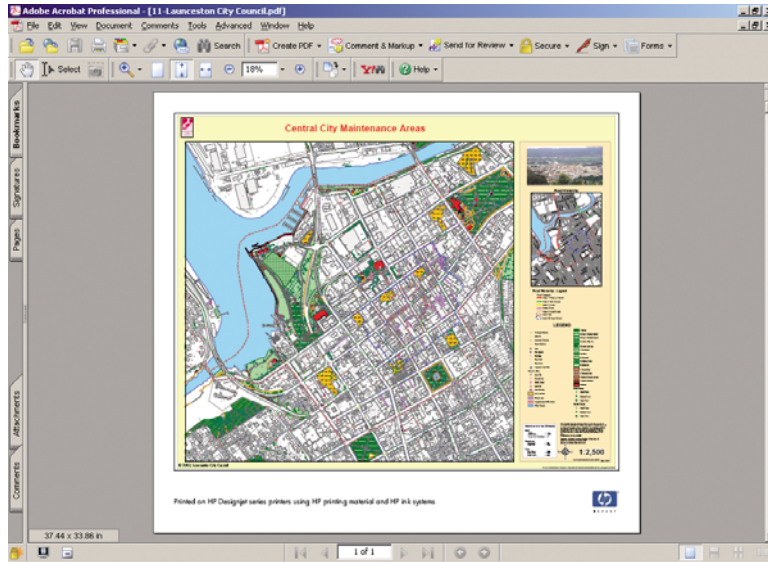

2. Select **File > Print**.

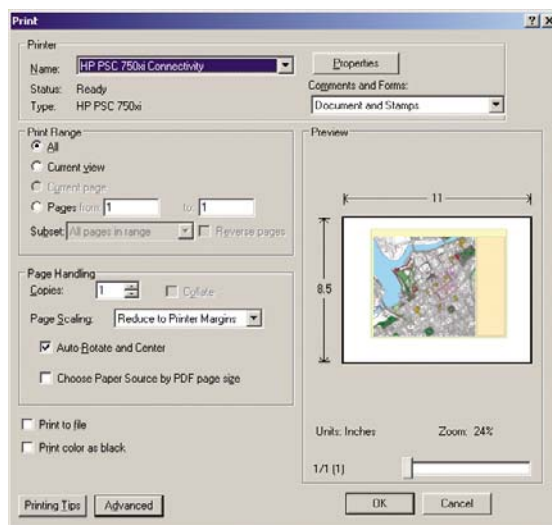

NOTE: The page size will **not** be automatically selected according to the drawing size.

- In order to keep the scale, set **Page Scaling** to **None** (which is not the default setting).

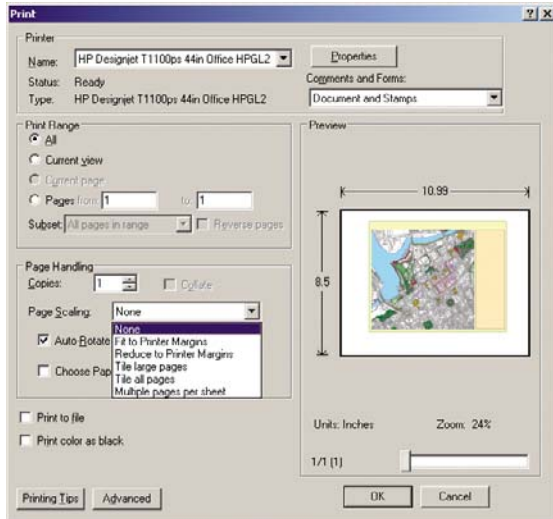

- Press the **Properties** button and then select the **Paper/Quality** tab.

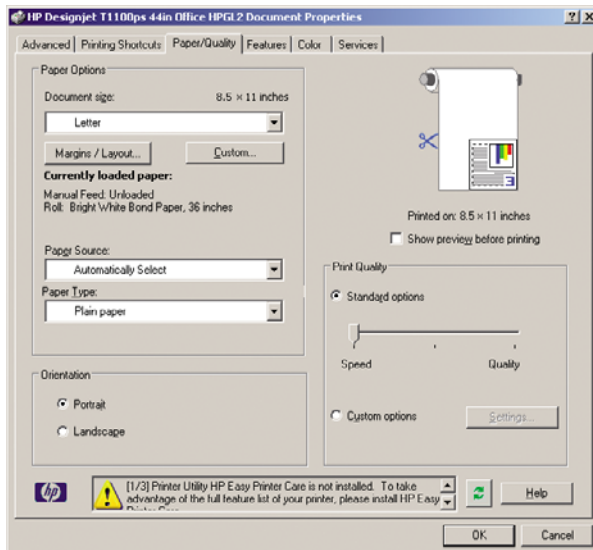

- Choose whatever **Document Size** and **Print Quality** you want to use. If you want to define a new custom paper size, press the **Custom** button.

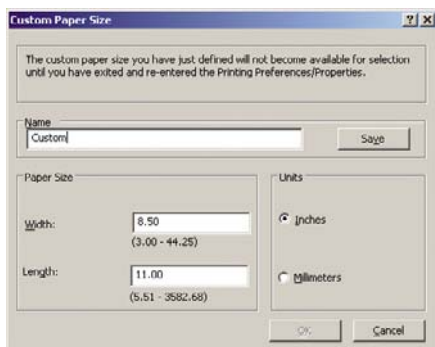

6. Select the **Features** tab, and then **Autorotate**.

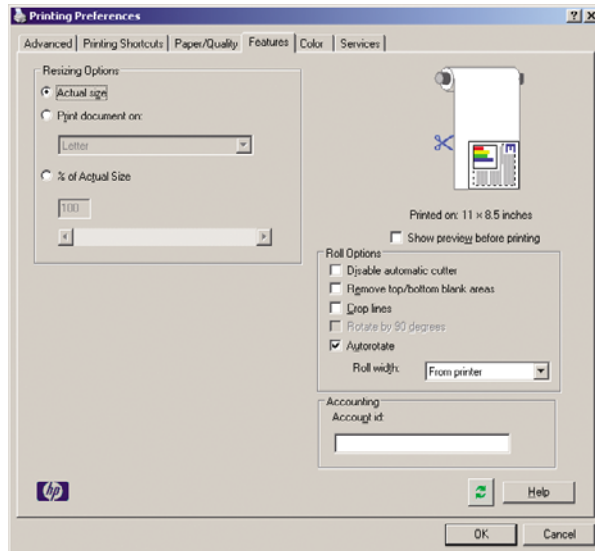

7. Click **OK**, and check that the print preview in the Print dialog box seems correct.

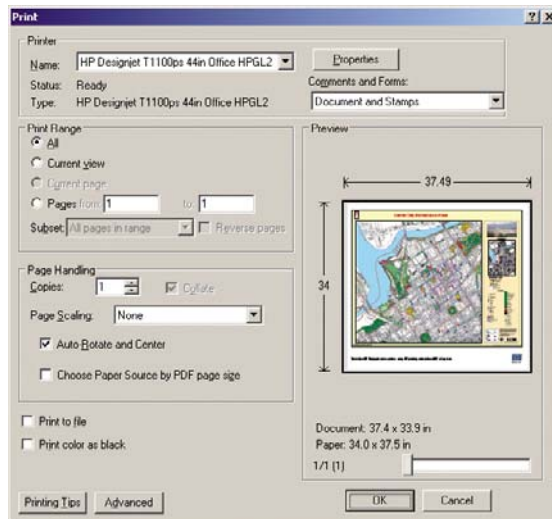

Print a project

This section demonstrates how to print a project from Autodesk Design Review, AutoCAD, and the printer's Embedded Web Server.

Using Autodesk Design Review

1. In Autodesk Design Review, select **File > Batch printing wizard**.

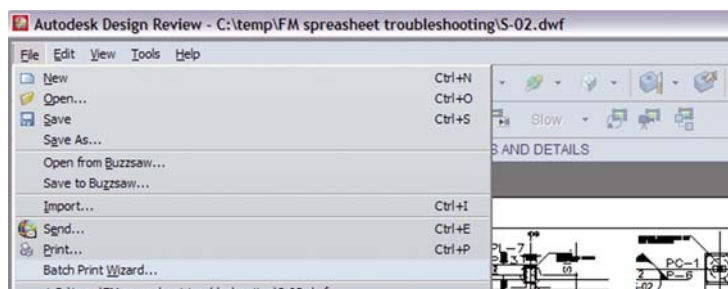

2. Press the **Next** button.

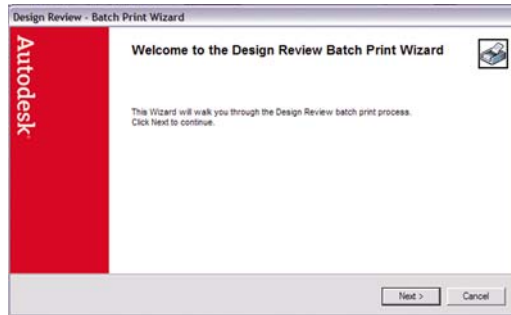

3. Select the files or folders that you want to print, select **Use HP Instant Printing**, and click **Next**.

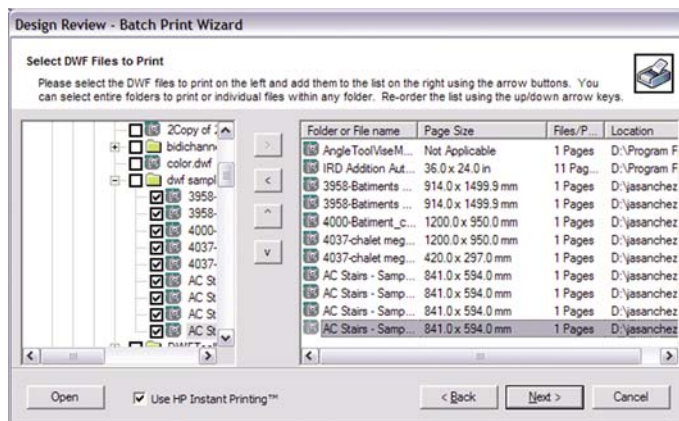

4. Select your printer and paper size, then click **OK**.

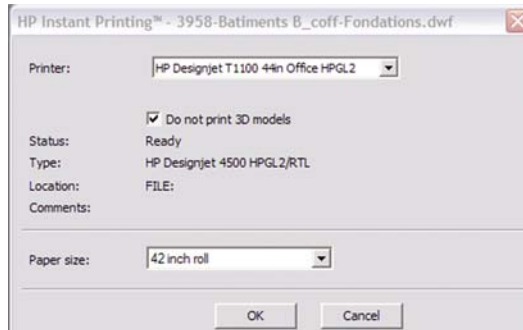

Using Windows Explorer to print Autodesk Design Review files

1. Highlight in Windows Explorer the files you want to print. Right-click on the group of files and select **Use HP Instant Printing**.

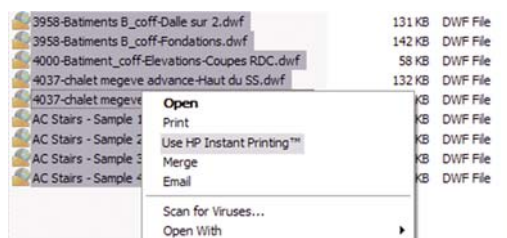

2. Select your printer and paper size, then click **OK**.

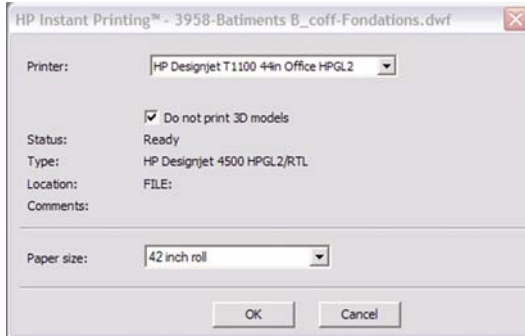

Using AutoCAD

1. The AutoCAD window shows the **Model** tab followed by a tab for each layout. Normally one of the layouts is printed rather than the model.

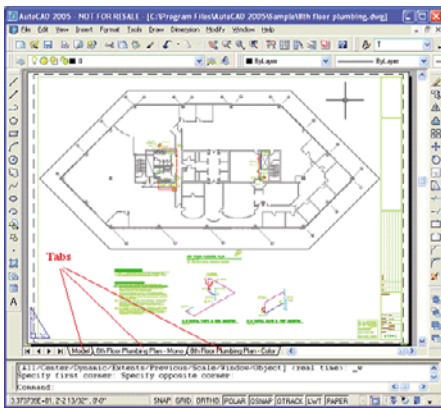

2. Select **File > Plot**.

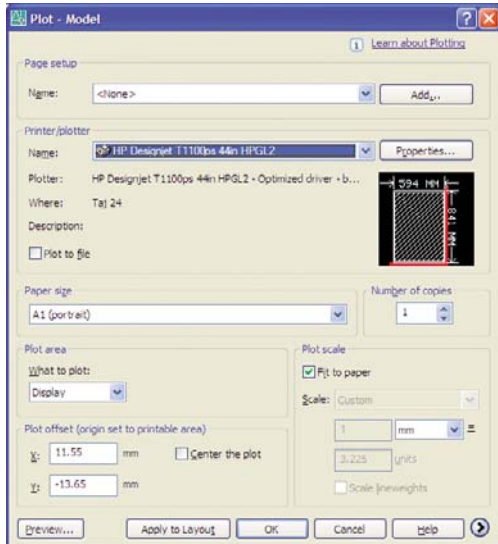

3. You can see further options by pressing the circular button in the lower right corner of the window.

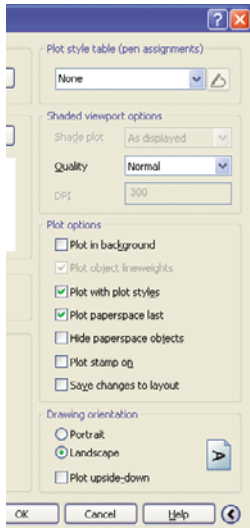

NOTE: The Quality option here does not refer to the final print quality but to the quality of AutoCAD viewport objects that are sent for printing.

4. Press the **Properties** button.

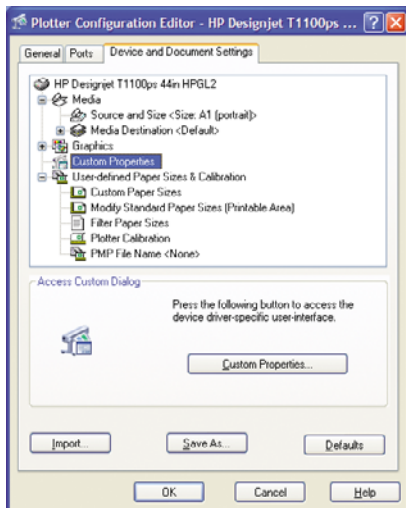

5. Select the **Device and Document Settings** tab, and press the **Custom Properties** button.

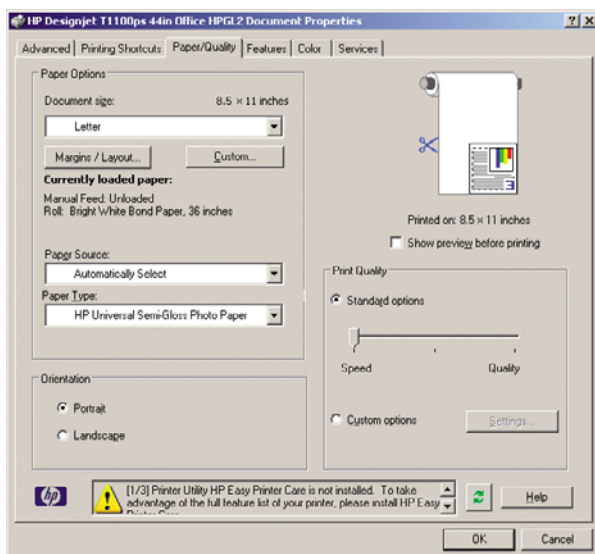

6. Select the **Paper/Quality** tab, then select the paper type that you intend to use.

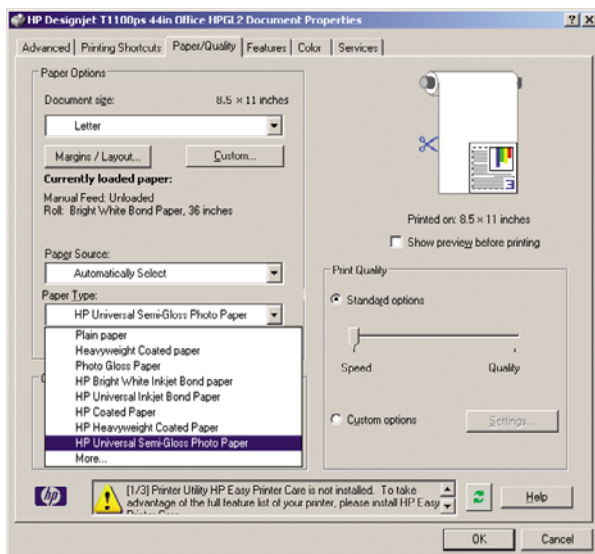

7. Select the print quality (your own choice between speed and quality of printing).

8. Select **Show preview before printing**.

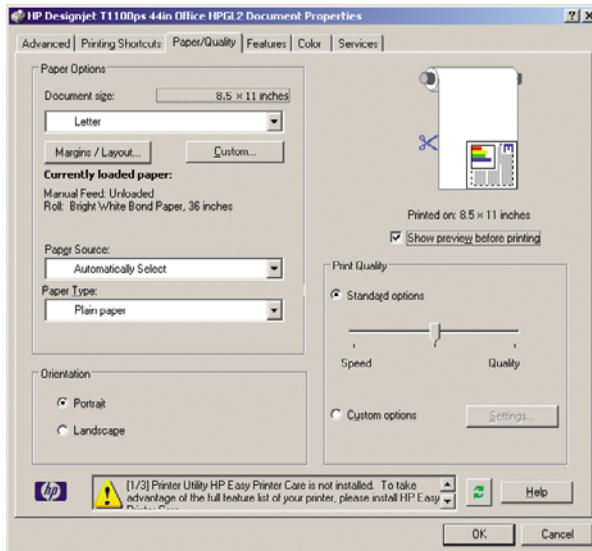

9. If you intend to print on roll paper, you must decide where the printer should cut the paper. Press the **Margins/Layout** button.

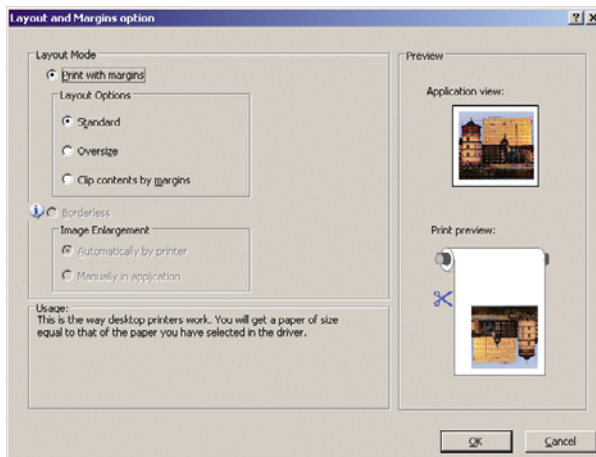

10. Select **Clip contents by margins**.

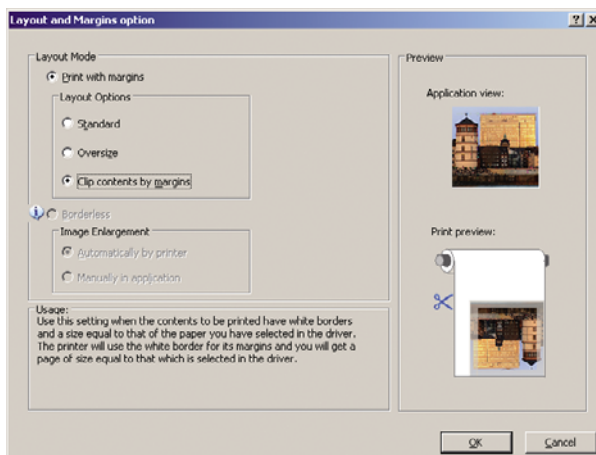

11. Select the **Features** tab, then select the **Autorotate** and **Crop lines** options. Autorotation can help to avoid wasting paper, and the crop lines will show you where to cut the paper after printing.

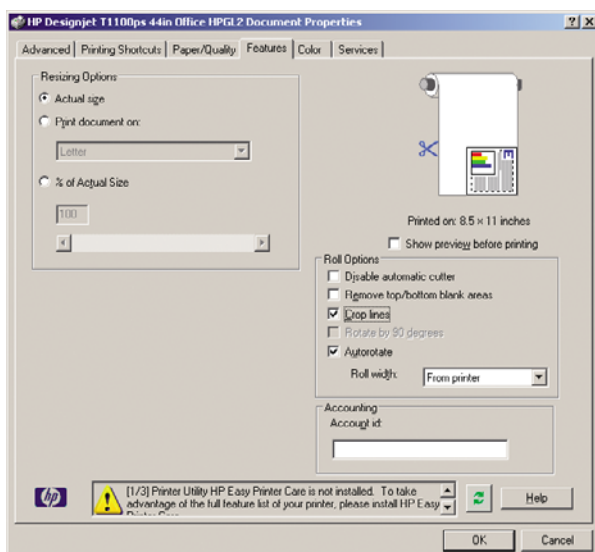

12. Press the **OK** button and save your configuration changes to a PC3 file.

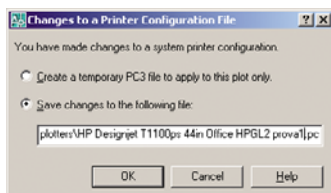

13. When you have pressed the **OK** button, the printer will construct a print preview.

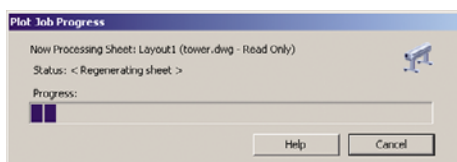

Preview in progress

Status: Waiting to receive the job...

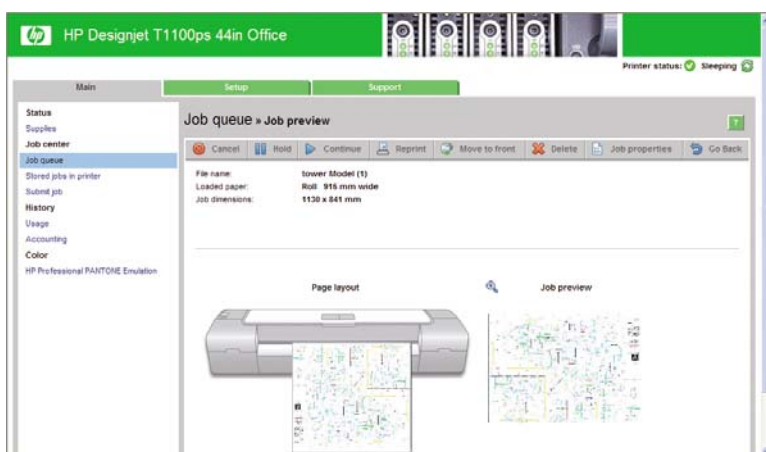

Using the Embedded Web Server to submit files

From HP Easy Printer Care or the Embedded Web Server, select **Job Center > Submit Job**. You will see the window below.

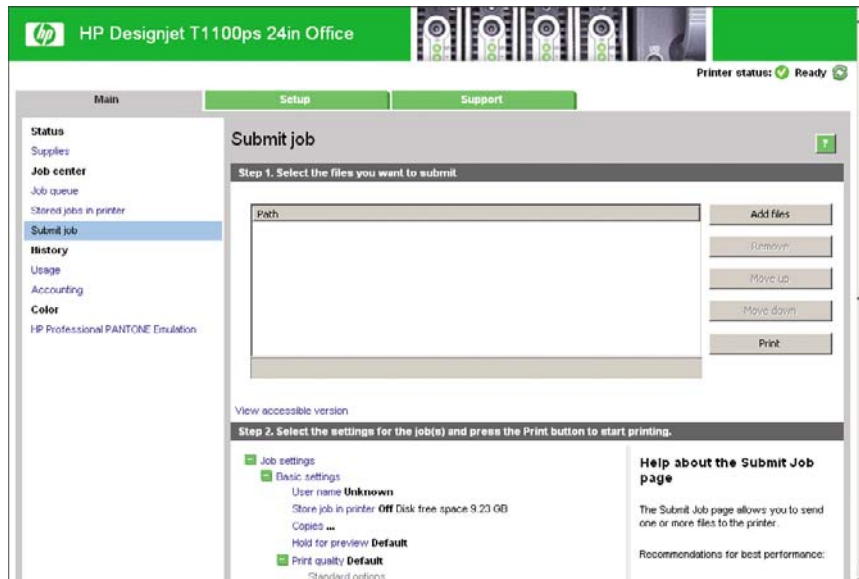

Press the **Add files** button to choose the files from your computer that you want to print. The files must be in one of the following formats:

- PDF (HP Designjet T1100ps only)
- PostScript (HP Designjet T1100ps only)
- TIFF (HP Designjet T1100ps only)
- JPEG (HP Designjet T1100ps only)
- HP-GL/2
- RTL
- CALS/G4



NOTE: When you print to a file, the file should be in one of the above formats, but its name may have an extension such as **.plt** or **.prn**.

If the files are not in one of these formats, they will not be printed successfully.

If the jobs have been generated with the appropriate settings (such as page size, rotation, resizing, and number of copies), you can just press the **Print** button and the project will be sent to the printer.

If you need to specify printing settings, go to the **Job settings** section and select the options you need. Each option has explanatory text on the right, so that you can understand the behavior of each setting. Remember that, if you leave the setting as **Default**, the setting saved in the job will be used. If the job contains no setting, the setting in the printer will be used.

Using printer emulation

Printer emulation can be requested by selecting **Advanced settings > Color > Color management > Printer emulation**.

You can select **Off** (no printer emulation) or the name of the printer model that you want to emulate.

This setting will apply to jobs that do not contain any printer emulation setting saved in the job.

Using clip contents by margins

You can select this margins option from **Advanced settings > Paper > Layout/Margins > Print with margins > Layout > Clip contents by margins**.

Use this option when the contents to be printed have white borders and a size equal to that of the paper you have selected. The printer will use the white border for its margins and you will get a page of size equal to that which is selected in the driver.

Print a presentation

This section demonstrates how to print a presentation from AutoCAD and from Photoshop.

Using AutoCAD

1. Open the AutoCAD file.
2. Select **Print from Layout**.
3. Select **File > Plot**.

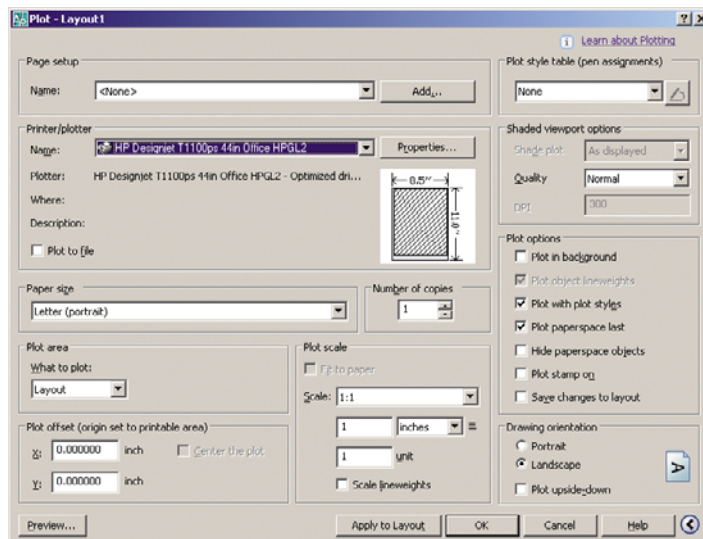

4. Ensure that the correct printer is selected, then press the **Properties** button.

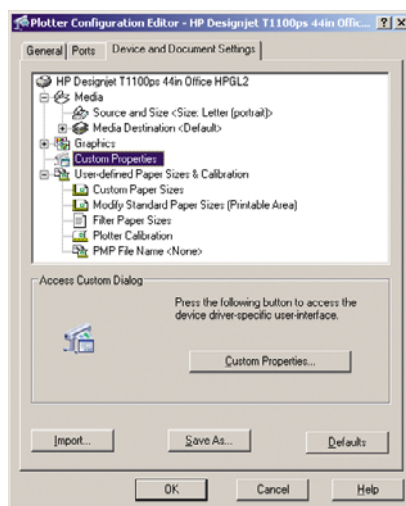

5. Select the **Device and Document Settings** tab, and press the **Custom Properties** button.

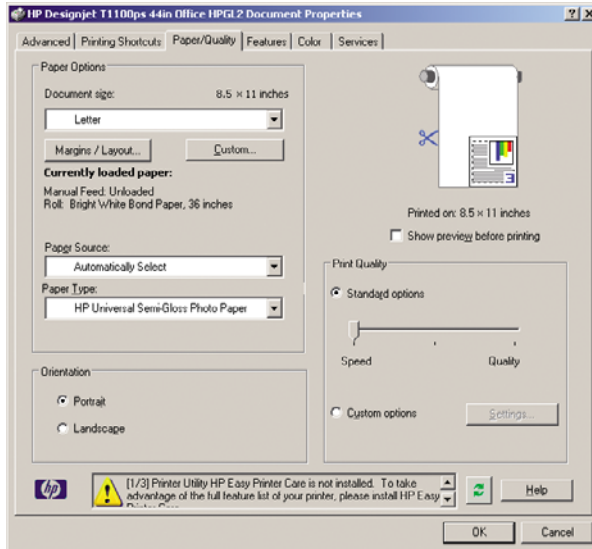

6. Select the **Paper/Quality** tab, then select the paper type that you intend to use.

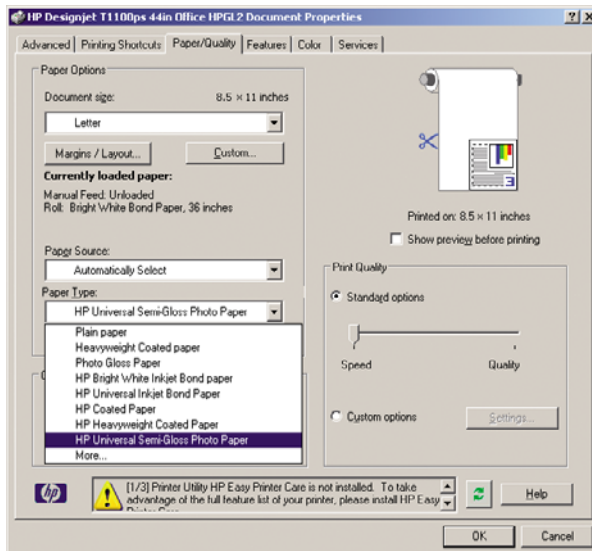

7. Select the print quality (your own choice between speed and quality of printing).

8. Select **Show preview before printing**.

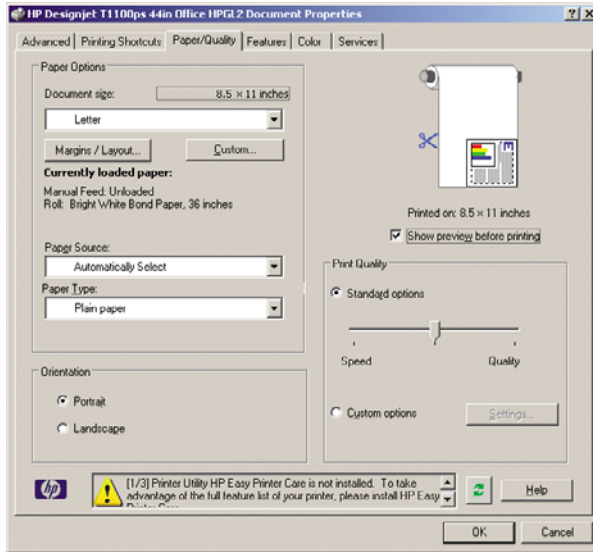

9. If you intend to print on roll paper, you must decide where the printer should cut the paper. Press the **Margins/Layout** button.

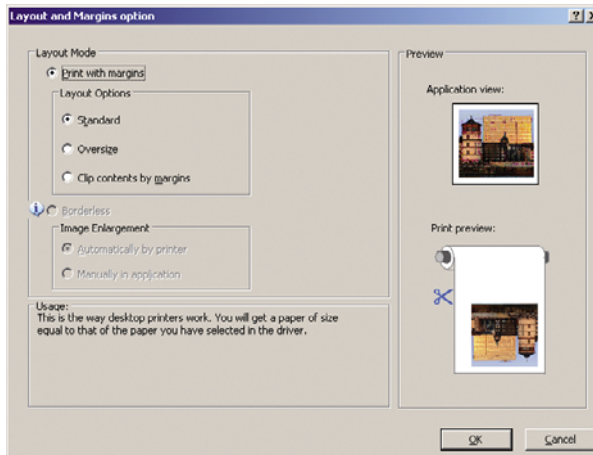

10. Select **Clip contents by margins**.

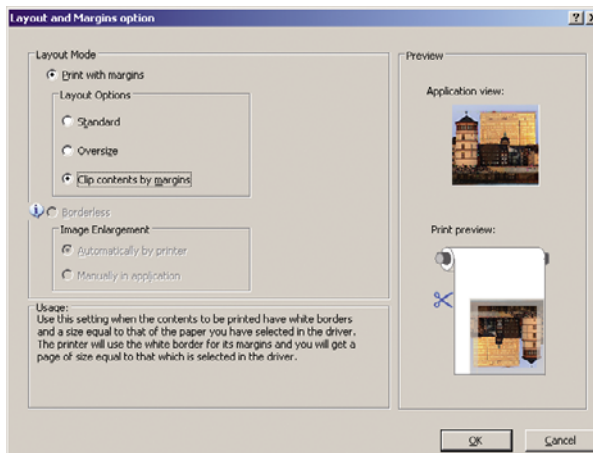

11. If you are using photo or glossy paper, you can select **Borderless** printing.

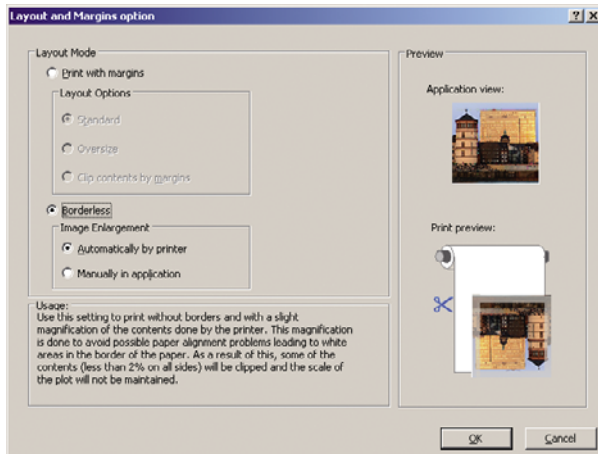

12. Select the **Features** tab, then select the **Autorotate** and **Crop lines** options. Autorotation can help to avoid wasting paper, and the crop lines will show you where to cut the paper after printing.

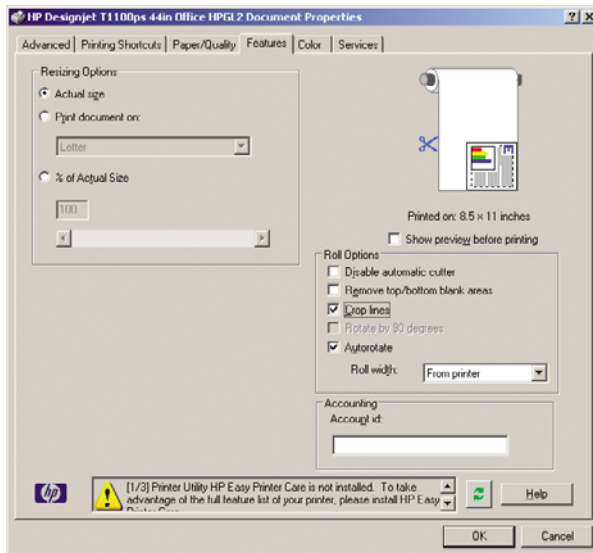

13. Press the **OK** button and save your configuration changes to a PC3 file.

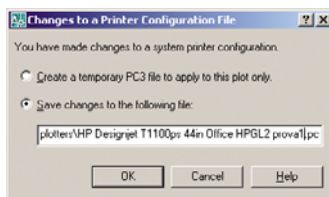

14. When you have pressed the **OK** button, the printer will construct a print preview.

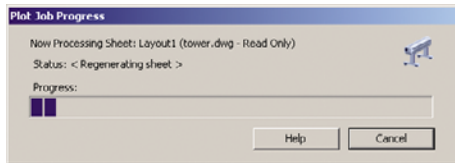

Preview in progress

Status: Waiting to receive the job...

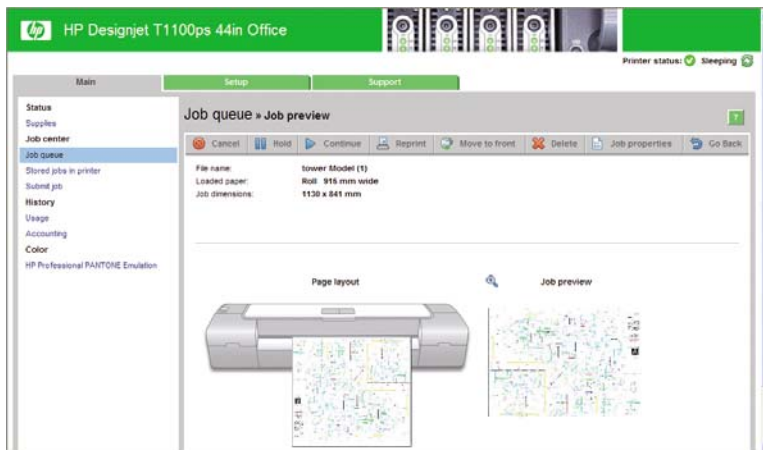

Using Adobe Photoshop

1. Select **File > Page Setup**, select your printer, and click **OK**.

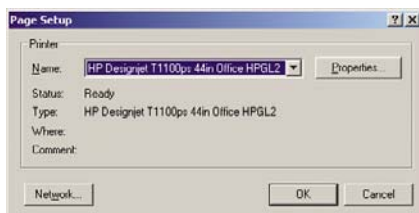

2. Choose from the available paper sizes.

If you do not find the paper size that you intend to use, select **Printer > Properties > Paper/Quality > Custom > Paper Size**. Enter the width, the length, and the name of your custom paper size. Press the **Save** and **OK** buttons.

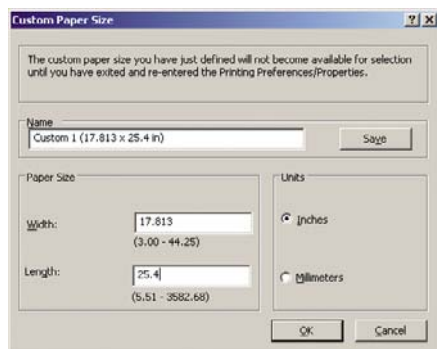
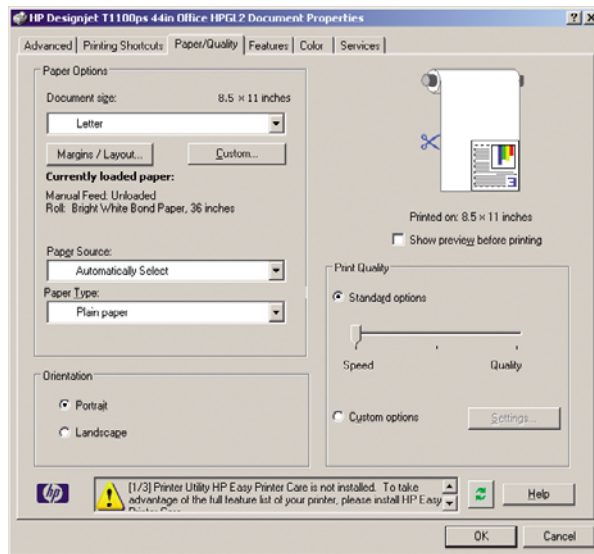

3. Select **File > Print with Preview**.



4. Select **Print > Properties.**

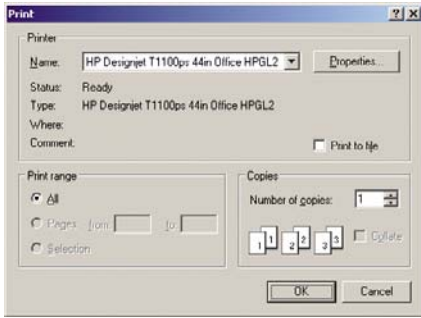

5. Select **Paper Source, Paper Type, and Print Quality.**

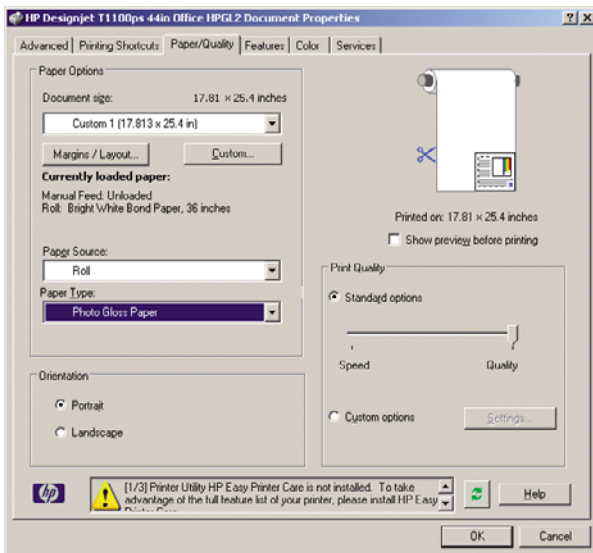
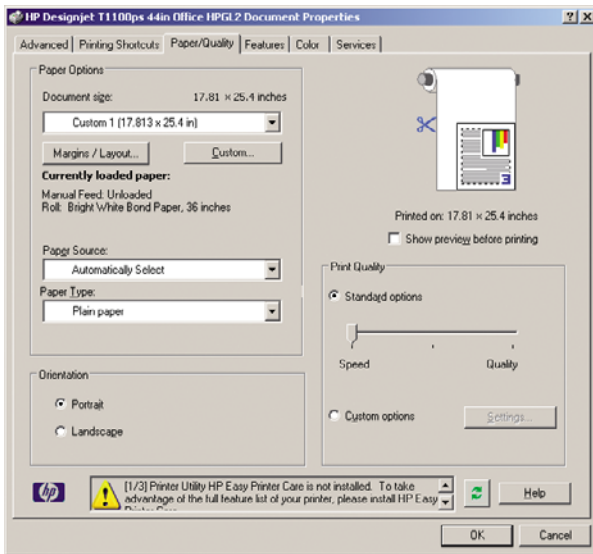

6. Press the **Margins/Layout** button. In this example you can select **Borderless** because you have already selected a photo paper (this option is only enabled with photo and glossy papers). The default image enlargement method is **Automatically by printer**. The option **Manually in application** can be used when you want to control the amount of enlargement precisely.

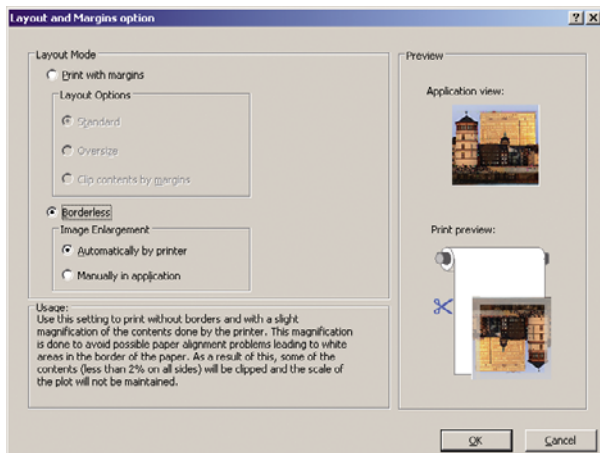

7. In the **Color** tab, the default color management option is **Printer Managed Colors**, and this is the correct option because you have already selected **Let Printer Determine Colors** in Photoshop.

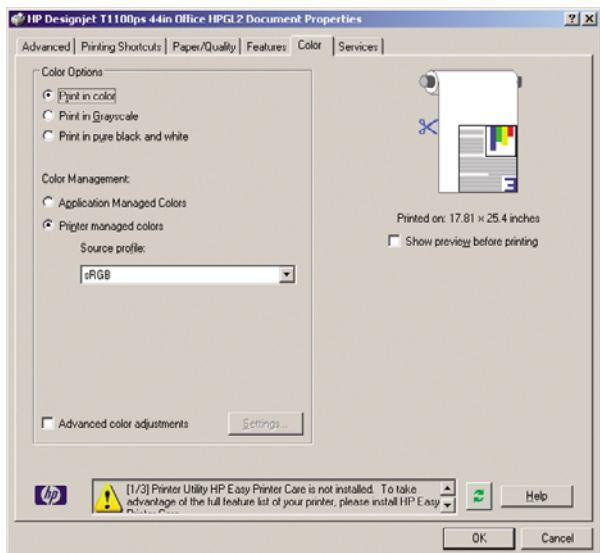

Print and scale from Microsoft Office

This section demonstrates how to print and scale from Microsoft Office.

Using PowerPoint

1. Select **File > Print**, then select the **Name** of your printer.

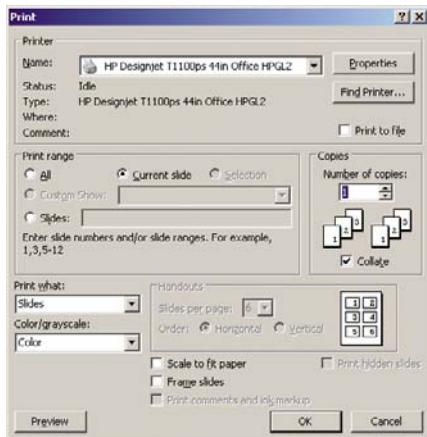

2. Select **Properties > Features > Print document on** to scale the document to a particular size.

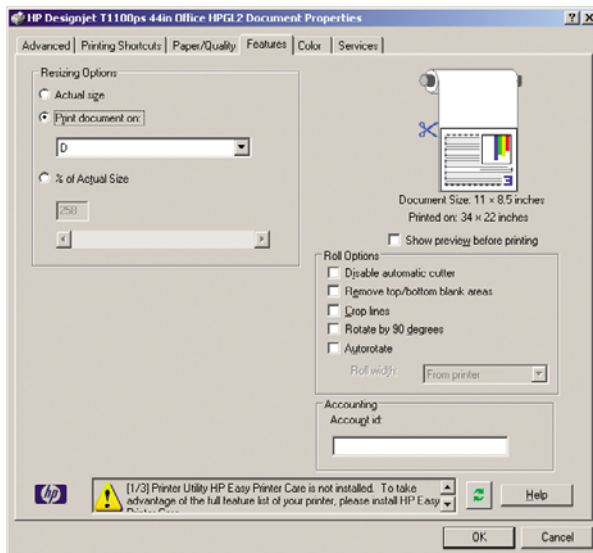

3. Select the **Paper/Quality** tab, then select **Paper Source** and **Paper Type**.

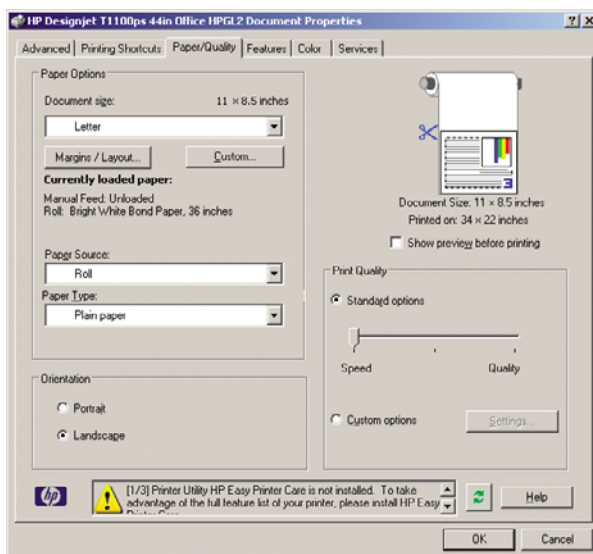

4. Select **Margins/Layout**, then select **Clip contents by margins** to keep the size.

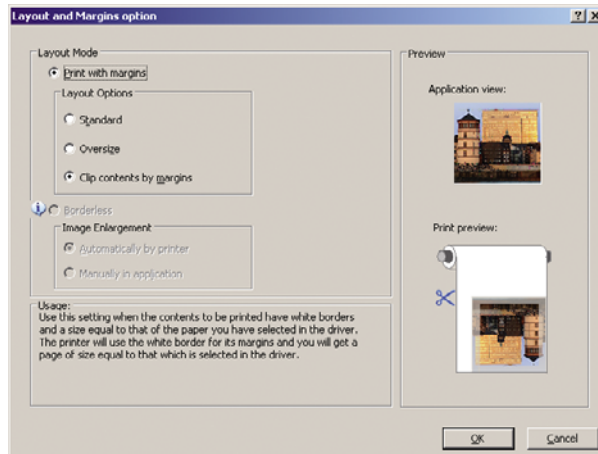

Using Project

1. Select **File > Page Setup > Print**.

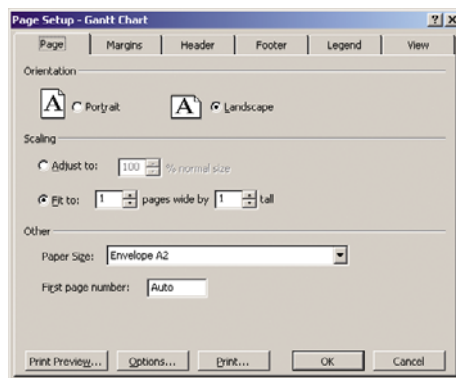

2. Select your printer's name, then **Close**.



3. Select **Page Setup**, and choose the **Paper Size** you want.

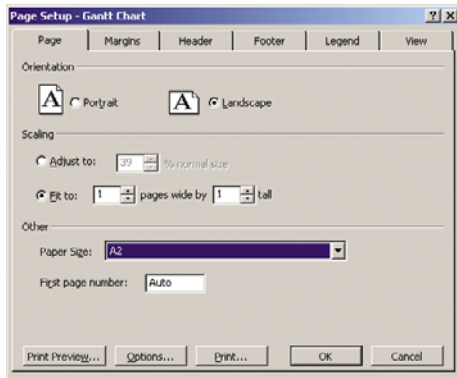

4. Select **Options** to go to the printer driver. The default options in the **Paper/Quality** tab are probably suitable: **Paper Source: Automatically Selected** and **Paper Type: Any**.

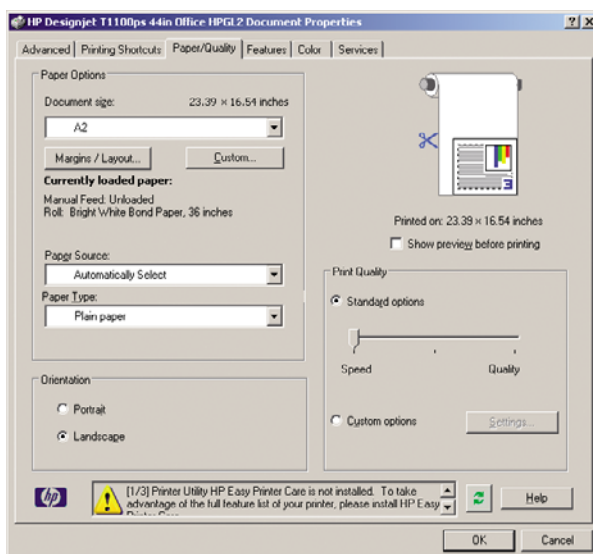

5. Select **Features > Print document on** to scale the document to a particular size. Alternatively, you can scale the document in Project.

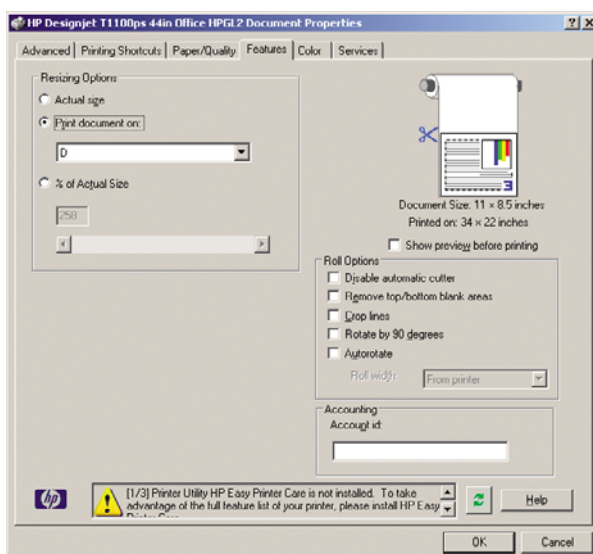

Using Excel

1. Select **File > Page Setup > Print**. Select your printer's name, then click **OK**.



2. Select **File > Page Setup**, and choose the **Paper Size** you want.

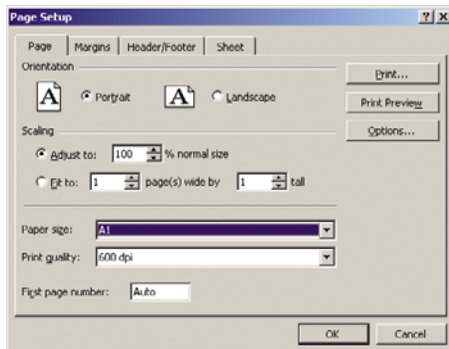

3. Select **Options** to go to the printer driver.

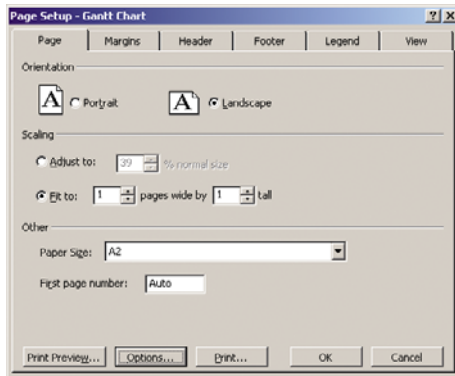

4. Select the **Paper/Quality** tab, where you can select **Paper Type**, **Paper Source**, and **Print Quality**.

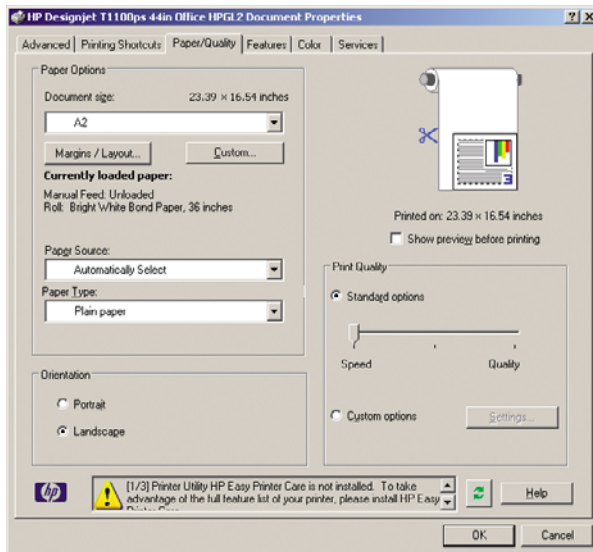

5. Select **Features > Print document on** to scale the document to a particular size. Alternatively, you can scale the document in Excel.

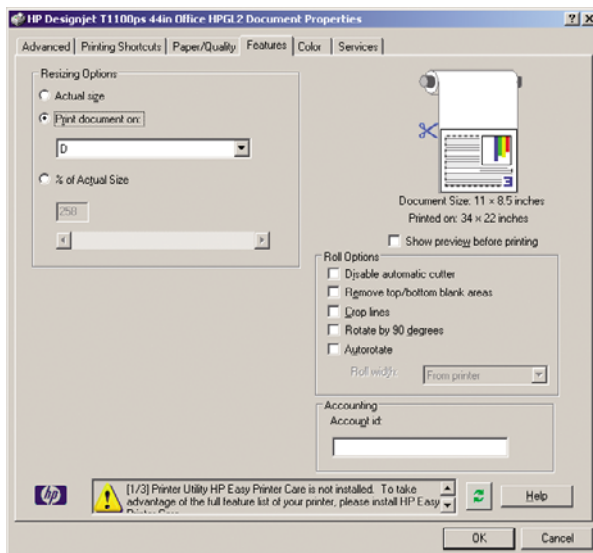

9 Job queue management

- [Job queue page](#)
- [Job preview](#)
- [Turn off the job queue](#)
- [Select when to print a job in the queue](#)
- [Identify a job in the queue](#)
- [Prioritize a job in the queue](#)
- [Delete a job from the queue](#)
- [Reprint or copy a job in the queue](#)
- [Job status messages](#)

Job queue page

You can manage your printer's job queue from HP Easy Printer Care (Windows) or HP Printer Utility (Mac OS), see [Access HP Easy Printer Care \(Windows\) or HP Printer Utility \(Mac OS\) on page 29](#), or the printer's Embedded Web Server, see [Access the Embedded Web Server on page 30](#).

By default, the access to the job queue is open to all users. An administrator can set a password so that users are required to enter a password for:

- Seeing job previews
- Canceling or deleting jobs

The job queue page shows all jobs that are available in the printer job queue. It includes jobs that are being received, parsed, rendered, printed, and already printed.

The following information displayed for each job:

- **Preview:** Click the icon to see the job preview. The job preview is available once the job is processed.
- **File name:** Click the file name to see the properties of the job.
- **Status:** Gives the current job status.
- **Pages:** Number of pages in the job.
- **Copies:** Number of copies printed.
- **Date:** Date and time the printer received the job.
- **User:** The user's name.

Jobs in the queue can be sorted by any of the information items (except Preview) by clicking on the title of the corresponding column. You can perform the following operations on one or all jobs in the queue:

- **Cancel:** Cancels the selected jobs. You are asked to confirm before the job is canceled. The job remains stored in the printer, but will not be printed unless you click **Reprint**.
- **Hold:** Holds the select jobs until you click **Continue** to print.
- **Continue:** All selected jobs, which are on hold, continue printing.
- **Reprint:** Prints more copies of a job. Type the number of copies (default 1, maximum 99) and click **Print**.
- **Move to front:** Sends all selected jobs to the top of the job queue.
- **Delete:** Deletes selected jobs from the job queue. You are asked to confirm before the job is deleted.
- **Refresh:** Refreshes the page, ensuring the information is updated.



NOTE: The job queue page does not automatically update.

Job preview

The printer samples all incoming jobs and generates a JPEG file that can be served as a preview of the job. This preview is available for all languages supported by the printer: PDF, PS, HPGL/2, RTL, TIFF, CALS/G4, and JPEG.



NOTE: Do not send a job for preview with more than 64 pages, this may cause the driver software to crash.

Job preview is available once the job is processed. To access the preview page, click the magnifying glass icon, which appears in the Preview column on the job queue page. The preview page shows the following job details along with a thumbnail preview of the job:

- **File name:** The file name of the job.
- **Loaded paper:** The type of paper loaded in the printer.
- **Job dimensions:** The dimensions of the job.

To see a larger preview of the job, click either the job thumbnail or the magnifying glass icon, which appears on the right hand side of the printer image.



NOTE: Browsers without the Macromedia plug-in show the job image as yellow shaded. Browsers that have the Macromedia flash plug-in version 7 and above shows an enhanced preview of the job image inside the paper loaded in the printer.

Turn off the job queue

You can turn off the queue from the Embedded Web Server (**Setup tab > Printer settings > Job management > Queue** and select **Off**), or from the front panel: select the Setup menu icon , then **Job management options > Enable queue > Off**.

Select when to print a job in the queue



NOTE: The When To Start Printing options cannot be used with PostScript jobs.

You can select at what point you want to print a file you have in the queue. From the Embedded Web Server, select **Setup tab > Printer settings > Start printing**; or, from the front panel, select the Job management menu icon , then **Job queue**.

There are three options you can select:

- When **After Processing** is selected, the printer waits until the whole page has been processed and then it starts to print. This is the slowest setting but ensures the best print quality in large or complex prints.
- When **Immediately** is selected, the printer prints the page as it is processed. This is the quickest setting, but the printer may stop halfway through a print to process data. This setting is not recommended for complex images with dense color.
- When **Optimized** is selected (this is the default setting), the printer calculates the best time to begin printing the page. It is usually the best compromise between the **After Processing** and **Immediately** settings.

Identify a job in the queue

The best way to look at the queue is in the Embedded Web Server (**Main tab > Job queue**), where you can manage the queue and get full information on every job (by clicking the name of the file).

However, you can also manage the queue from the front panel. To do so, select the Job management menu icon , then **Job queue**, where you can see a list of the jobs in the queue.

Each has an identifier, comprising:

<position in queue>: <image name>

The job currently being printed has a check mark, canceled jobs have crosses, processing jobs have a clock, and jobs on hold have a warning.

Prioritize a job in the queue

To make any job in the queue the next one to be printed, select it and choose **Reprint** (in the Embedded Web Server) or **Move to front** (in the front panel).

If nesting is turned on, the prioritized job may still be nested with others. If you really want this job to be printed next, and on its own on the roll, first turn nesting off and then move it to the front of the queue as described above.

Delete a job from the queue

Under normal circumstances, there is no need to delete a job from the queue after printing it, as it will just fall off the end of the queue as more files are sent. However, if you have sent a file in error, and want to avoid printing it, you can simply delete it, by selecting it and choosing **Delete** (in the Embedded Web Server or in the front panel).

In the same way, you can delete a job that has not been printed yet.

If the job is currently being printed (its status is **printing** in the Web server), and you want both to cancel the job and to delete it, first click the **Cancel** icon in the Web server, or press the **Cancel** key on the front panel, and then delete it from the queue.

Reprint or copy a job in the queue

To reprint or make extra copies of any job in the queue, select the job in the Embedded Web Server and click the **Reprint** icon, then specify the number of copies you want. The job will be moved to the top of the queue. To make more than one print of a non-printed job in the queue from the front panel, select the job and choose **Copies**, then specify the number of copies required and press the **Select** key. This overrides any value set by your software.



NOTE: If **Rotate** was **On** when you sent the file, every copy will be rotated.

You can reprint an already-printed job from the front panel. Select the Job management menu icon



, then select the job from the queue, then select **Reprint**.



NOTE: You cannot use this method for PCL3 jobs. To reprint old jobs that are PCL3, you may be able to use your operating system's printer spooler, if you have already set the spooler to save old jobs. This facility depends on your operating system.

Job status messages

These are the possible job status messages, approximately in the order in which they may be seen:

- **Receiving:** the printer is receiving the job from the computer
- **Waiting to process:** the job has been received by the printer and is waiting to be rendered (for jobs submitted through the Embedded Web Server only)
- **Processing:** the printer is parsing and rendering the job
- **Preparing to print:** the printer is performing writing system checks before printing the job
- **Waiting to print:** the job is waiting for the print engine to become free to proceed with printing
- **Waiting for nest:** the printer is set up with Nesting=On and is waiting for other jobs in order to complete the nest and proceed with printing
- **On hold:** the job was sent with the **on hold for preview** option and is on hold



NOTE: Do not send a job for preview with more than 64 pages, this may cause the driver software to crash.

NOTE: If the printer hangs up while printing a job, and the queue facility is turned on, the partially printed job will appear in the queue as **on hold** when the printer is next turned on. When you resume the job, it will start printing at the page at which it was interrupted.

- **On hold for paper:** the job can't be printed because paper is not loaded in the printer. Load the required paper, see [Paper handling on page 35](#), and click **Continue** to resume the job
- **On hold for accounting:** the job can't be printed because the printer requires all jobs to have an account ID: enter the account ID and then click **Continue** to resume the job



TIP: To set an account ID, see [Require account ID on page 25](#).

- **Printing**
- **Drying**
- **Cutting paper**
- **Ejecting page**
- **Canceled:** the job is being canceled, but will remain in the printer job queue
- **Deleting:** the job is being deleted from the printer
- **Printed**
- **Canceled:** the job has been canceled by the printer
- **Canceled by user**
- **Empty job:** the job does not contain anything to print

Remove a hold

When the printer puts a job on hold you receive an alert, see [Printer alerts on page 190](#), which explains why the job is on hold. Follow the instructions on the screen to remove the hold and continue printing.

10 Retrieving printer usage information

- [Get printer accounting information](#)
- [Check printer usage statistics](#)
- [Check ink and paper usage for a job](#)

Get printer accounting information

There are various different ways of getting accounting information from your printer.

- View printer usage statistics for the whole lifetime of the printer, see [Check printer usage statistics on page 116](#).
- View ink and paper usage for each of your recent jobs by using HP Easy Printer Care (Windows) or HP Printer Utility (Mac OS), see [Check ink and paper usage for a job on page 116](#). If HP Easy Printer Care or HP Printer Utility is not available, see [Access HP Easy Printer Care \(Windows\) or HP Printer Utility \(Mac OS\) on page 29](#).
- Use a third-party application to request printer status, printer usage, or job accounting data from the printer through the Internet. The printer provides data in XML to the application whenever requested. HP provides a Software Development Kit to facilitate the development of such applications.

Check printer usage statistics

There are two ways to check your printer's usage statistics.



NOTE: The accuracy of the usage statistics is not guaranteed.

Printer statistics with HP Easy Printer Care (Windows) or HP Printer Utility (Mac OS)

1. Access HP Easy Printer Care (Windows) or HP Printer Utility (Mac OS), see [Access HP Easy Printer Care \(Windows\) or HP Printer Utility \(Mac OS\) on page 29](#).
2. Under Windows, go to the **Overview** tab and click on the **Printer usage** link.

Under Mac OS, select **Information > Printer Usage** and click on the **Lookup** button.

Printer statistics with the Embedded Web Server

1. Access the Embedded Web Server, see [Access the Embedded Web Server on page 30](#).
2. Go to the **Main** tab.
3. Select **History > Usage**.

Check ink and paper usage for a job

There are two ways to check ink and paper usage for a job.



NOTE: The accuracy of the usage statistics is not guaranteed.

Ink and paper statistics with HP Easy Printer Care (Windows) or HP Printer Utility (Mac OS)

1. Access HP Easy Printer Care (Windows) or HP Printer Utility (Mac OS), see [Access HP Easy Printer Care \(Windows\) or HP Printer Utility \(Mac OS\) on page 29](#).
2. Select **Job center** to view information regarding the most recent jobs.
3. Under Windows, click on the **Accounting** link.

Under Mac OS, select **Job Accounting** and click on the **Look Up** button.

Ink and paper statistics with the Embedded Web Server

1. Access the Embedded Web Server, see [Access the Embedded Web Server on page 30](#).
2. Go to the **Main** tab.
3. Select **History > Accounting**.

11 Handling ink cartridges and printheads

- [About the ink cartridges](#)
- [Check the ink cartridges status](#)
- [Remove an ink cartridge](#)
- [Insert an ink cartridge](#)
- [About the printheads](#)
- [Check the printhead status](#)
- [Remove a printhead](#)
- [Insert a printhead](#)

About the ink cartridges

Ink cartridges store the ink and are connected to the printheads, which distribute the ink on the paper. Your 24-inch printer comes with one 130 ml matte black ink cartridge and five 69 ml ink cartridges. Your 44-inch printer comes with six 130 ml ink cartridges. To purchase additional cartridges, see [Accessories on page 141](#).



CAUTION: Observe precautions when handling ink cartridges because they are ESD-sensitive devices (see the [Glossary on page 203](#)). Avoid touching pins, leads, and circuitry.

Check the ink cartridges status

To view the ink levels of your ink cartridges, press the **View ink level** key on the front panel.

To get more information on your ink cartridges, you can use the front panel ink menu, HP Easy Printer Care (Windows), or HP Printer Utility (Mac OS).

For an explanation of the ink cartridge status messages, see [Ink cartridge status messages on page 178](#).

Ink menu procedure

1. Press the **Menu** key to return to the main menu and select the Ink menu icon , then **Ink cartridge information**.
2. Select the cartridge on which you want information.
3. The front panel displays:
 - Color
 - Product name
 - Product number
 - Serial number
 - Status
 - Ink level, if known
 - Total ink capacity in milliliters
 - Expiration date
 - Warranty status
 - Manufacturer

HP Easy Printer Care (Windows) or HP Printer Utility (Mac OS) procedures

- In HP Easy Printer Care (Windows), go to the **Overview** tab, each cartridge's status is under **Supply Status > Cartridges**.
- In HP Printer Utility (Mac OS), select **Information > Printer Status**.

Remove an ink cartridge

There are two occasions when you need to remove an ink cartridge.

- The ink cartridge is very low and you want to replace it with a full cartridge for unattended printing (you can use up the remaining ink in the first cartridge at a more convenient time).
- The ink cartridge is empty or faulty, and you must replace it to continue printing.



CAUTION: Do not try to remove an ink cartridge while printing.

CAUTION: Remove an ink cartridge only if you are ready to insert another one.

CAUTION: Make sure the printer wheels are locked (the brake lever is pressed down) to prevent the printer from moving.

1.

Press the **Menu** key to return to the main menu and select the Ink menu icon , then **Replace ink cartridges**.

Ink

- ▶ View ink levels
- ▶ **Replace ink cartridges**
- ▶ Replace printheads
- ⊕ Ink cartridge information
- ⊕ Printhead information

2. Open the ink cartridge cover on the left-hand side of the printer. All six inks, gray, photo black, matte black, yellow, magenta, and cyan, are on the left-hand side.



3. Grip the cartridge you wish to remove.

4. Pull the cartridge straight up.

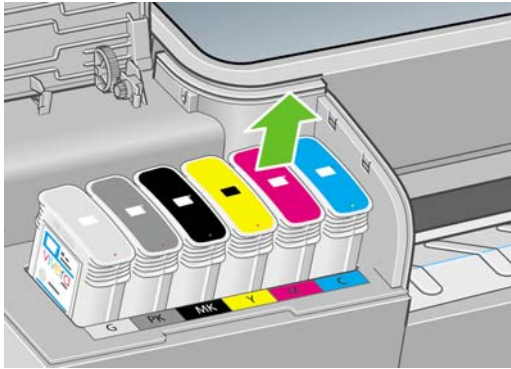

NOTE: Avoid touching the end of the cartridge that is inserted into the printer, as there may be ink on the connection.

NOTE: Avoid storing partially used ink cartridges.

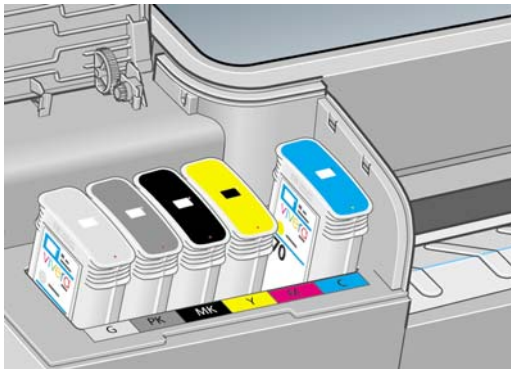

5. The front-panel display identifies the missing ink cartridge.

Insert an ink cartridge

1. Before removing the cartridge from its wrapping, shake it vigorously.
2. Unwrap the new ink cartridge, find the label identifying the ink color. Check that the letter or letters (in these illustrations, M for magenta) marking the empty slot, matches the letter or letters on the cartridge label.
3. Insert the ink cartridge into its slot.

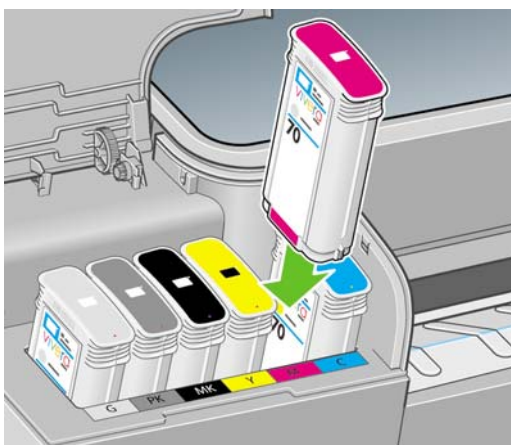

4. Push the cartridge into the slot until it snaps into position. You should hear a beep and see confirmation that the cartridge has been inserted.

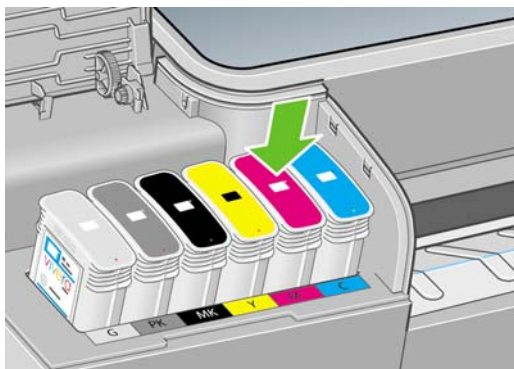

If you have difficulty, see [Cannot insert an ink cartridge on page 178](#).

5. When all cartridges have been inserted, close the cover.

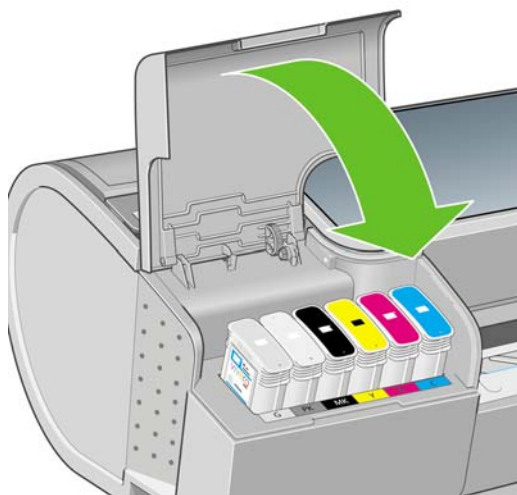

6. The front-panel display confirms that all cartridges have been correctly inserted, press the **OK** key on the front panel.

About the printheads

The printheads are connected to the ink cartridges and jet ink onto the paper.



CAUTION: Observe precautions when handling printheads because they are ESD-sensitive devices (see the [Glossary on page 203](#)). Avoid touching pins, leads, and circuitry.

Check the printhead status

The printer automatically checks and services the printheads after each print. Follow the steps below to get more information on your printheads.

1. Press the **Menu** key to return to the main menu and select the Ink menu icon , then **Printhead information**.
2. Select the printhead on which you want information.
3. The front panel displays:
 - Colors
 - Product name
 - Product number
 - Serial number
 - Status, see [Front-panel error messages on page 191](#)
 - Volume of ink it has used
 - Warranty status

You can also get most of this information without leaving your computer by using HP Easy Printer Care (Windows) or HP Printer Utility (Mac OS).

For an explanation of the printhead status messages, see [Printhead status messages on page 184](#).

If the warranty status is **See warranty note**, this indicates that non-HP ink is being used. See the HP Legal Information document provided with your printer for details of the warranty implications.

Remove a printhead



CAUTION: Make sure the printer wheels are locked (the brake lever is pressed down) to prevent the printer from moving.

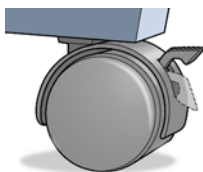

 **CAUTION:** Printhead replacement must be performed with the printer powered on.

1. Press the **Menu** key to return to the main menu and select the Ink menu icon , then **Replace printheads**.

Ink

- ▶ View ink levels
- ▶ Replace ink cartridges
- ▶ **Replace printheads**
- ⊕ Ink cartridge information
- ⊕ Printhead information

2. The printer moves the carriage into the correct position.

 **CAUTION:** If the carriage is left in the removal position for more than three minutes without inserting or removing any printheads, it tries to move back to its normal position in the right-hand end.

3. When the carriage has stopped moving, the front-panel display asks you to open the window.

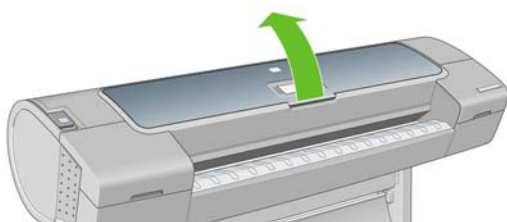

4. Locate the carriage on the right side of the printer.
5. Pull the handle up and toward you to release the wire loop.

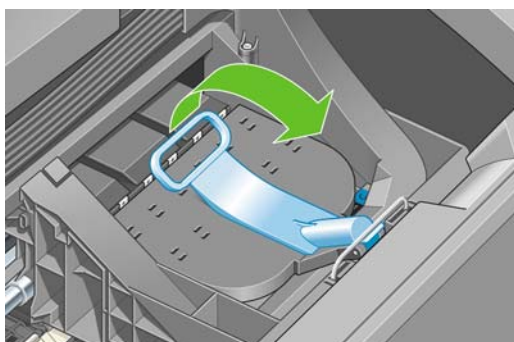

6. Push the handle back to raise the lid.

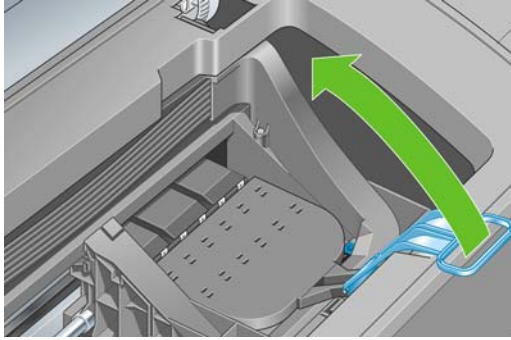

7. This gives you access to the printheads.

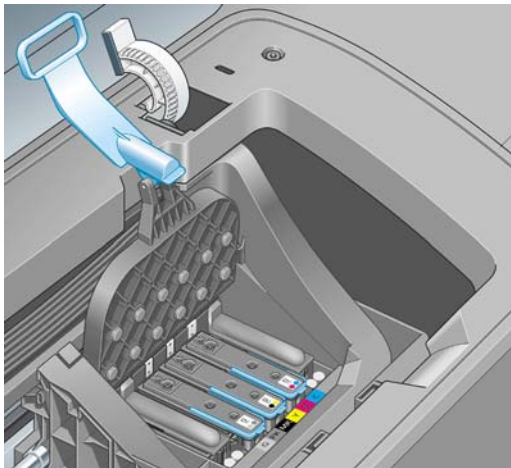

8. To remove a printhead, lift up the blue handle.

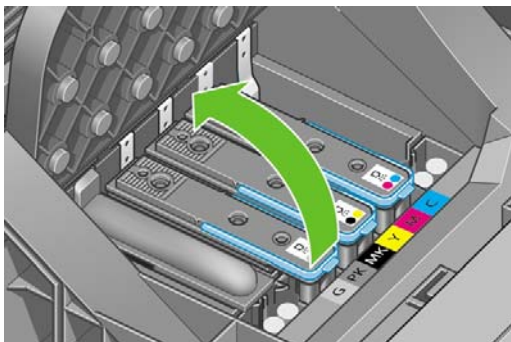

9. Using the blue handle, use steady force to disengage the printhead.

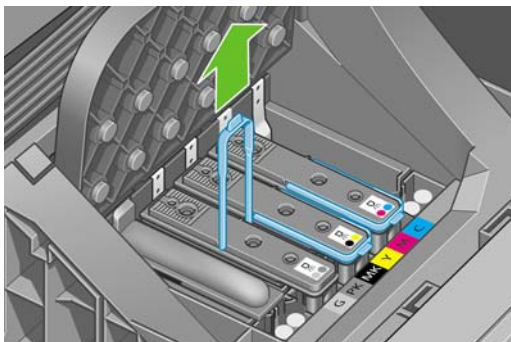

10. Pull the blue handle upward until the printhead is released from the carriage.



CAUTION: Do not pull abruptly because this can damage the printhead.

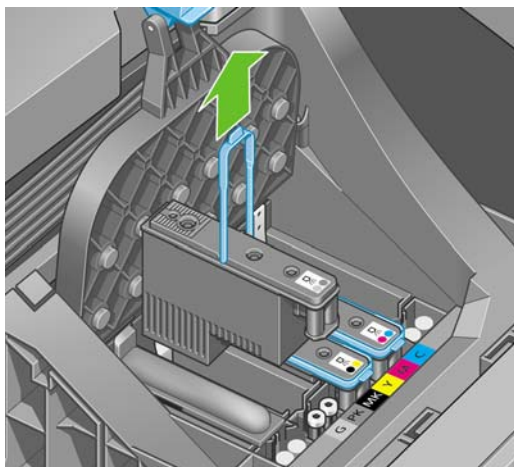

11. The front-panel display identifies the missing printhead.

Insert a printhead

1. Remove the orange protective caps by pulling them down.

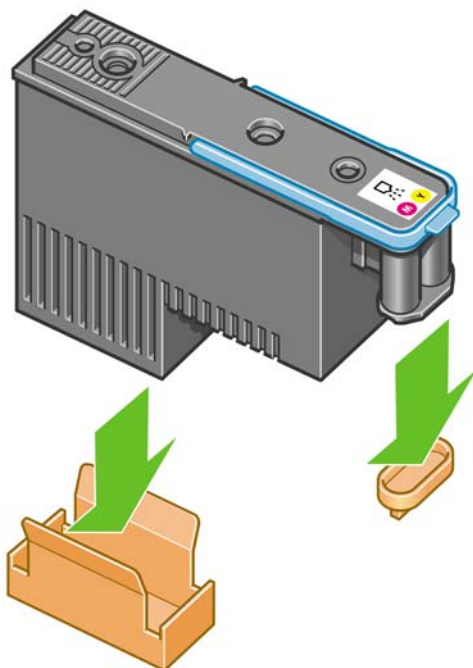

2. The printhead is designed to prevent you from accidentally inserting it into the wrong slot. Check that the colored label on the printhead matches the colored label of the carriage slot into which the printhead is to be inserted.

3. Insert the new printhead into its correct slot in the carriage.



CAUTION: Insert the printhead slowly and vertically, straight down. It may be damaged if you insert it too fast, or at an angle, or if you rotate it as you insert it.

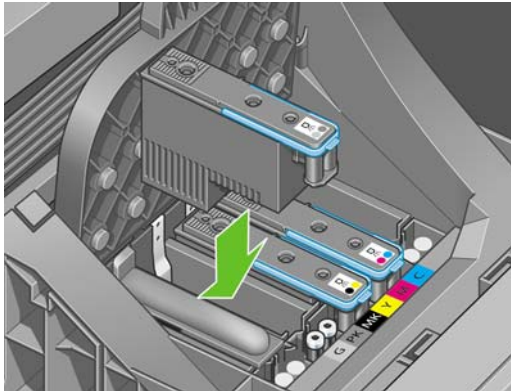

4. Push down as indicated by the arrow shown below.

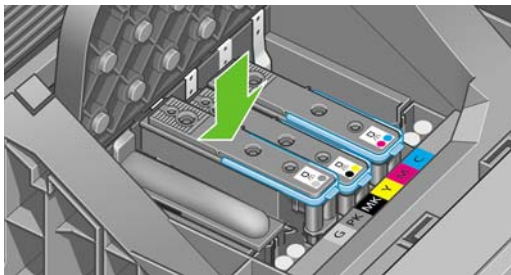

CAUTION: When installing the new printhead there may be some resistance, so you need to press it down firmly but smoothly. You should hear a beep and see confirmation on the front-panel display that the printhead has been inserted. If you have difficulty, see [Cannot insert a printhead on page 178](#).

5. Insert all other printheads that need to be installed, and close the carriage lid.

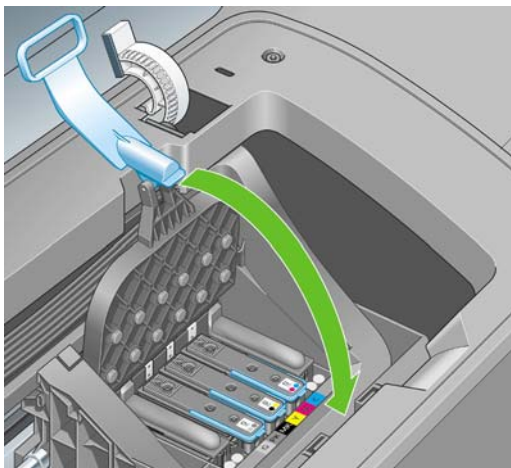

6. Ensure the end of the blue handle catches the wire loop on the near side of the carriage.

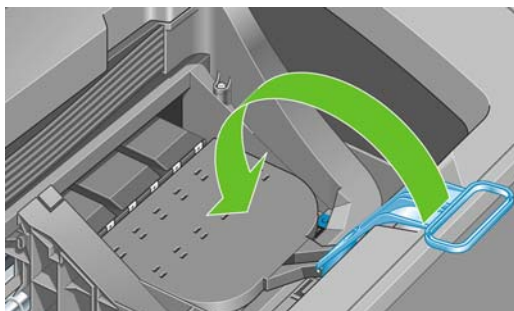

7. Lower the handle to rest on the carriage cover.

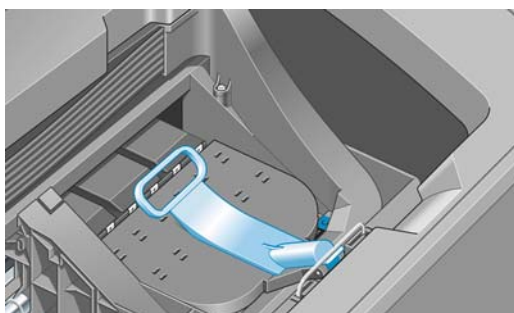

When all the printheads have been inserted correctly and are accepted by the printer, the printer beeps.



NOTE: If the printer does not beep when you insert the printhead and the **Replace** message appears on the front-panel display, the printhead may need to be reinserted.

8. Close the window.

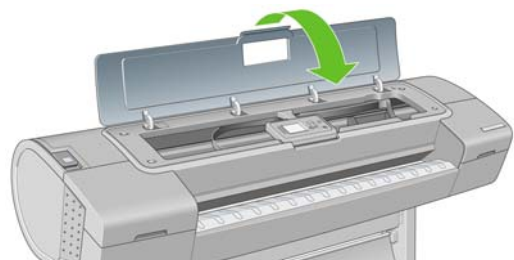





9. The front-panel display confirms that all printheads are correctly inserted. The printer starts checking and preparing the printheads. The default routine process, when all printheads are changed, takes 10 minutes. If the printer finds problems in preparing the printheads, it takes longer, up to 45 minutes. For a single printhead insertion, the times vary between 2 and 40 minutes. After all printheads are checked and prepared, the printhead realignment procedure runs automatically if paper is loaded, see [Align the printheads on page 182](#).

12 Maintaining the printer

- [Check printer status](#)
- [Clean the exterior of the printer](#)
- [Replace the cutter](#)
- [Maintain the ink cartridges](#)
- [Move or store the printer](#)
- [Update the firmware](#)
- [Update the software](#)
- [Printer maintenance kits](#)
- [Secure Disk Erase](#)

Check printer status

You can check the current status of the printer in various ways:

- If you start HP Easy Printer Care under Windows or HP Printer Utility under Mac OS, and select your printer, you see a page of information describing the status of the printer and its paper and ink supplies.
- If you access the Embedded Web Server, you see information about the general status of the printer. The Supplies page in the **Main** tab describes the status of the paper and ink supplies.
- The status screen of the printer's front panel notifies you of any current problems affecting the printer as a whole. You can also request information about:
 - The currently loaded paper, with the **View loaded paper** key 
 - The ink levels, with the **View ink levels** key 
 - The ink cartridges, by selecting the Ink menu icon  and then **Ink cartridge information**
 - The printheads, by selecting the Ink menu icon  and then **Printhead information**

Clean the exterior of the printer

Clean the outside of the printer and all other parts of the printer that you regularly touch as part of normal operation with a damp sponge or a soft cloth and a mild household cleaner such as non-abrasive liquid soap.



WARNING! To avoid an electric shock, make sure that the printer is turned off and unplugged before you clean it. Do not let water get inside the printer.



CAUTION: Do not use abrasive cleaners on the printer.

Replace the cutter

The cutter may need to be replaced once or twice during the life of the printer, depending on the total amount and thickness of paper used. The front panel advises when replacement is due. If you do not replace the cutter immediately, the printer continues working normally, but the front panel continues to remind you about the cutter.

To replace the cutter:

1. If there is paper loaded in the printer, unload it.
2. At the front panel, select the Setup menu icon , then **Resets > Reset cutter life counters**.
3. After a brief pause, the printer turns itself off. The printhead carriage is parked on the right-hand side of the printer, and the cutter on the left-hand side.



WARNING! There is a risk of electric shock if you attempt to replace the cutter with the printer turned on.

4. Lift the ink cartridge cover on the left-hand side of the printer.



5. Press the button behind the ink cartridges to release the cover of the left-hand end of the printer.

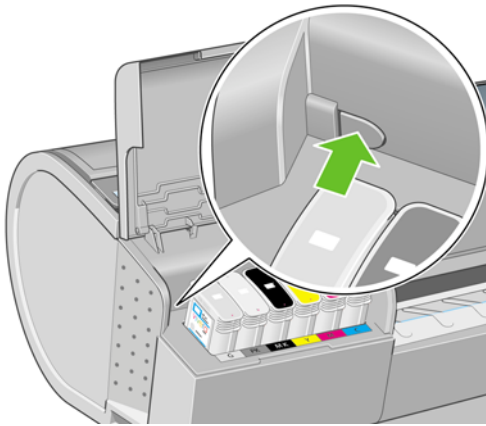

6. Remove the left end cover.

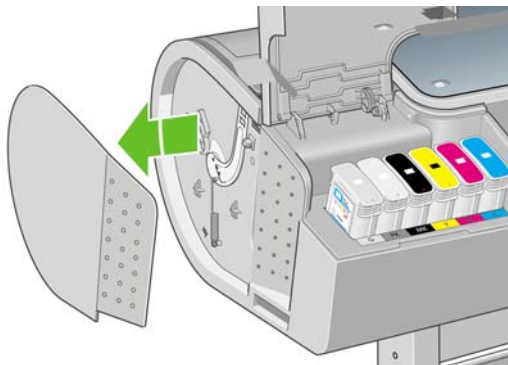

7. Unscrew and remove the cutter stop using the TORX PLUS screwdriver provided with the new cutter. The screw is captive and will not fall out.

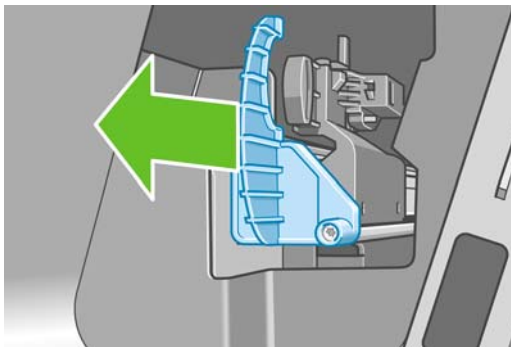
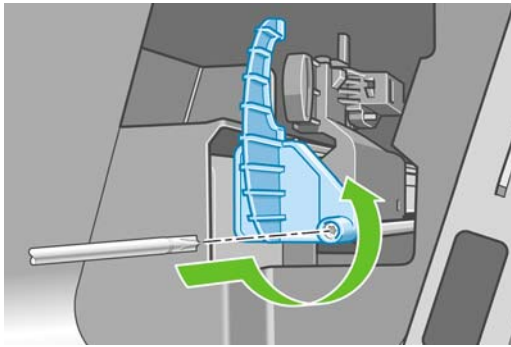

8. Remove the old cutter.

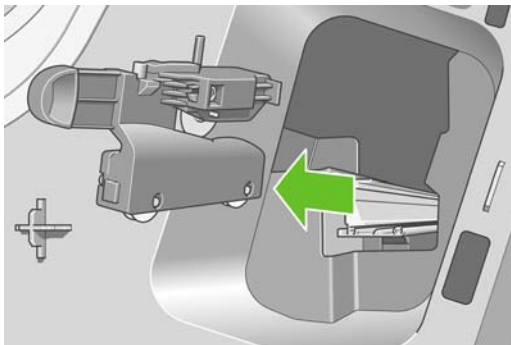

9. Take the new cutter from the maintenance kit and move the plunger at the top slowly back and forth within its housing to check that it moves freely.

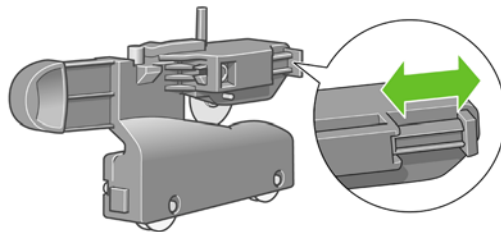

10. Slide the new cutter into position on the cutter rail.

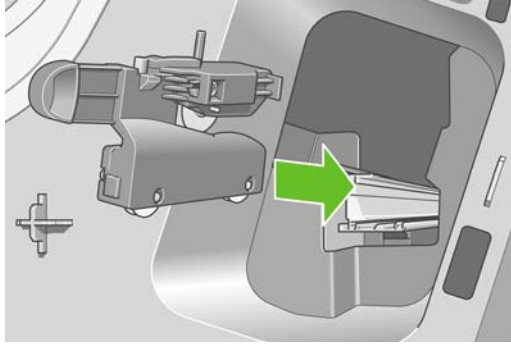

The two wheels on the bottom of the cutter should engage the central ridge on the cutter rail, and the two bushing guides should fit into the groove in the upper part of the cutter rail.

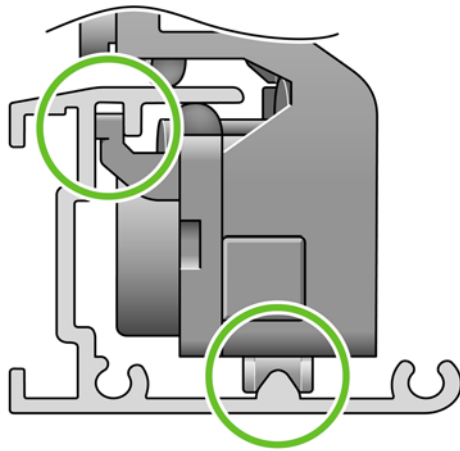

Check that the cutter runs smoothly up and down the rail. You can leave it anywhere on the rail; the printer will park it correctly later.

11. Fit the cutter stop onto the end of the cutter rail, holding it there with one hand while you tighten the screw with the screwdriver in your other hand.

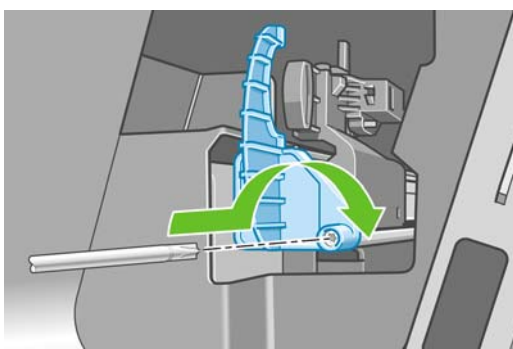
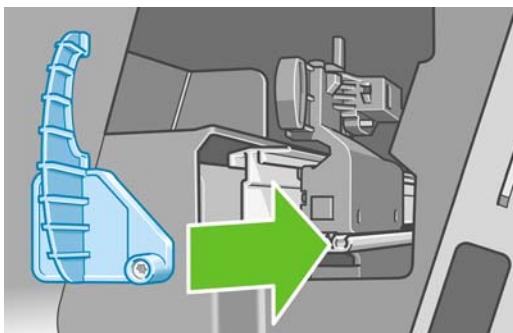

12. Put the left end cover back on the printer, aligning the protrusions with the holes in the printer.

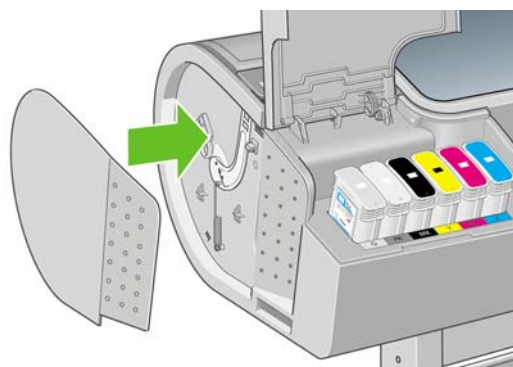

13. Close the ink cartridge cover.

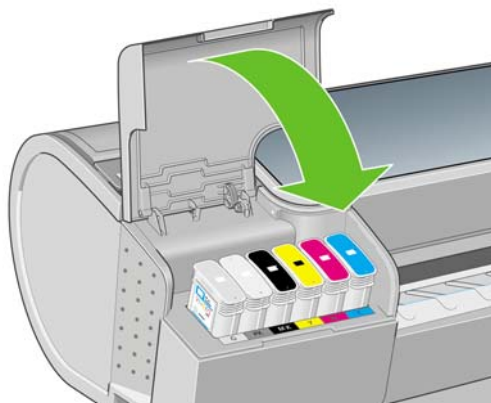

14. At the front panel, turn the printer back on. The printer checks that the cutter has been correctly installed. Look at the front panel and follow its instructions if there is any problem.

Maintain the ink cartridges

During the normal lifetime of a cartridge, no specific maintenance is required. However, in order to maintain the best print quality, replace a cartridge when it reaches its expiration date. The printer's front panel notifies you when any cartridge reaches its expiration date.

You can also check a cartridge's expiration date at any time: see [Check printer status on page 132](#).

See also [Handling ink cartridges and printheads on page 119](#).

Move or store the printer

If you need to move or store the printer, prepare it correctly to avoid possible damage to it. To prepare the printer, follow the instructions below.

1. Do not remove the ink cartridges or printheads.
2. Make sure that no paper is loaded.
3. Make sure that the printer is idle.
4. Disconnect any cables connecting the printer to a network or a computer.

If you need to leave the printer turned off for a long time, follow the additional steps below.

1. Turn off the power using the **Power** key on the front panel.
2. Also turn off the power switch at the rear of the printer.
3. Disconnect the printer's power cable.
4. Before transporting the printer, secure the rear tray in the closed position with tape. Otherwise, the tray could open and perhaps break and fall out of the printer.

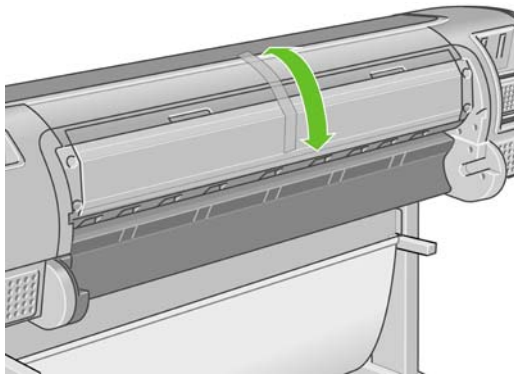

CAUTION: If you turn the printer upside down, ink could escape into the printer and cause serious damage.

When the printer is turned back on, it takes about three minutes to initialize itself and to check and prepare the printheads. Preparing the printheads normally takes just over a minute. However, if the printer has been off for a six weeks or more, preparing the printheads could take up to 45 minutes.



CAUTION: If the printer remains off for a long period of time, the printheads may become unusable. In this case, you need to replace the printheads with new ones.



TIP: Because preparing and purging the printheads uses both time and ink, you are strongly recommended to leave the printer always on or in sleep mode, whenever possible, to maintain the health of the printheads. In both cases, the printer wakes up from time to time to maintain the printheads. Thus you can avoid going through lengthy preparation processes before using your printer.

Update the firmware

The printer's various functions are controlled by software that resides in the printer, otherwise known as firmware.

From time to time firmware updates will be available from Hewlett-Packard. These updates increase the printer's functionality and enhance its features.

Firmware updates can be downloaded from the Internet and installed in your printer in the following ways; you can choose whichever you find most convenient.

- Using HP Easy Printer Care under Windows, select your printer, the **Support** tab, and then **Firmware Update**.
- Using HP Printer Utility under Mac OS, select **Support** and then **Firmware Update**.
- Using your printer's Embedded Web Server, select the **Setup** tab and then **Firmware update**.

In each case, follow the instructions on your screen to download the firmware file and store it on your hard disk. Then select the downloaded file and click **Update**.

If you experience very slow progress while uploading the firmware file to the printer, the reason could be that you are using a proxy server. In that case, try bypassing the proxy server and accessing the Embedded Web Server directly.

- In Internet Explorer 6 for Windows, go to **Tools > Internet Options > Connections > LAN Settings**, and check the **Bypass proxy server for local addresses** box. Alternatively, for more precise control, click the **Advanced** button and add the printer's IP address to the list of exceptions, for which the proxy server is not used.
- In Safari for Mac OS, go to **Safari > Preferences > Advanced** and click the **Proxies: Change Settings** button. Add the printer's IP address or its domain name to the list of exceptions, for which the proxy server is not used.

The firmware includes a set of the most commonly used paper profiles. Extra paper profiles can be downloaded separately; see [Paper profiles on page 55](#).

Update the software

To update the printer driver and other software for any HP Designjet printer, go to <http://www.hp.com/go/designjet/> and select **Downloads**, then **Drivers**. Then select your printer, your preferred language, and your operating system.

If your operating system is Windows, HP Software Update regularly offers to update your software automatically.

Printer maintenance kits

Four maintenance kits are available for your printer, containing components that may need to be replaced after long use. When one of them is needed, a message is displayed on the front panel and by HP Easy Printer Care under Windows or HP Printer Utility under Mac OS.

When you see the message, you should contact HP Support (see [Contact HP Support on page 196](#)) and request the maintenance kit. Three of the kits are installed by service engineers only; the fourth consists of a replacement cutter, which you can install yourself (see [Replace the cutter on page 132](#)).

Secure Disk Erase

The printer's hard disk is used as a temporary storage area for print jobs. The Secure Disk Erase facility can completely erase your information from the hard disk to protect it from unauthorized access. You can choose to erase particular files, or the whole hard disk.

Secure Disk Erase provides three different levels of security:

- **Non-Secure Fast Erase:** all pointers to the information are erased. The information itself remains on the hard disk until the disk space it occupies is needed for other purposes, and it is then overwritten. While it remains on the disk, it is difficult for most people to access, but may be accessed using software designed for the purpose. This is the normal method in which files are erased on most computer systems; it is the fastest method but the least secure.
- **Secure Fast Erase:** all pointers to the information are erased, and the information itself is also overwritten with a fixed character pattern. This method is slower than Non-Secure Fast Erase, but more secure. It may still be possible to access fragments of the erased information by using special tools to detect residual magnetic traces.



- **Secure Sanitizing Erase:** all pointers to the information are erased, and the information itself is repetitively overwritten using an algorithm designed to eliminate any residual traces. This is the slowest method, but the most secure. Secure Sanitizing Erase meets the US Department of Defense 5220-22.m requirements for clearing and sanitization of disk media. This is the default security level when using Secure Disk Erase.



Secure Disk Erase is one of the facilities provided by Web JetAdmin, which is HP's free Web-based print management software: see <http://www.hp.com/go/webjetadmin/>.

If you have difficulty in using Secure Disk Erase from Web JetAdmin, please contact HP Support: see [Contact HP Support on page 196](#).



NOTE: If you choose to erase the whole hard disk, you may be asked to restart the printer several times during the process, which will take about 6 hours with Secure Disk Erase or 24 hours with Secure Sanitizing Erase.

13 Accessories

- [How to order supplies and accessories](#)
- [Introduction to the accessories](#)

How to order supplies and accessories

There are two alternative ways to order supplies or accessories for your printer:

- Visit http://www.hp.com/go/designjett1100_order/ on the Web.
- Contact HP Support (see [Contact HP Support on page 196](#)).

The rest of this chapter lists the available supplies and accessories, and their part numbers.

Order ink supplies

The following ink supplies can be ordered for your printer.

Table 13-1 Ink cartridges

Cartridge	Part number
HP 72 69 ml Photo Black Ink Cartridge	C9397A
HP 72 69 ml Cyan Ink Cartridge	C9398A
HP 72 69 ml Magenta Ink Cartridge	C9399A
HP 72 69 ml Yellow Ink Cartridge	C9400A
HP 72 69 ml Gray Ink Cartridge	C9401A
HP 72 130 ml Matte Black Ink Cartridge	C9403A
HP 72 130 ml Photo Black Ink Cartridge	C9370A
HP 72 130 ml Cyan Ink Cartridge	C9371A
HP 72 130 ml Magenta Ink Cartridge	C9372A
HP 72 130 ml Yellow Ink Cartridge	C9373A
HP 72 130 ml Gray Ink Cartridge	C9374A

Table 13-2 Printheads

Printhead	Part number
HP 72 Gray & Photo Black Printhead	C9380A
HP 72 Magenta & Cyan Printhead	C9383A
HP 72 Matte Black & Yellow Printhead	C9384A

Order paper

The following paper types are currently provided for use with your printer.



NOTE: This list is likely to change over the course of time. For the latest information, see <http://www.hp.com/go/designjet/supplies/>.

NOTE: Paper types that HP does not support may nevertheless be compatible with your printer.

Key to availability:

- (A) indicates papers available in Asia (excluding Japan)
- (C) indicates papers available in China

- (E) indicates papers available in Europe, the Middle East, and Africa
- (J) indicates papers available in Japan
- (L) indicates papers available in Latin America
- (N) indicates papers available in North America

If the part number is not followed by parentheses, the paper is available in all regions.

Table 13-3 Roll paper

Paper type	g/m ²	Length	Width	Part numbers
HP Bond and Coated Paper				
HP Universal Inkjet Bond Paper	80	150 ft = 45.7 m	23.39 in = 594 mm (A1)	Q8003A (AJ)
			24 in = 610 mm	Q1396A
			36 in = 914 mm	Q1397A
			42 in = 1067 mm	Q1398A
		300 ft = 91.4 m	23.39 in = 594 mm (A1)	Q8004A (EAJ)
			33.11 in = 841 mm (A0)	Q8005A (EAJ)
HP Bright White Inkjet Bond Paper	90	150 ft = 45.7 m	16.54 in = 420 mm (A2)	Q1446A (J)
			23.39 in = 594 mm (A1)	Q1445A (EJ)
			24 in = 610 mm	C1860A (LN), C6035A (AEJ)
			33.11 in = 841 mm (A0)	Q1444A (EJ)
			36 in = 914 mm	C1861A (LN), C6036A (AEJ)
			300 ft = 91.4 m	36 in = 914 mm
HP Universal Coated Paper	95	150 ft = 45.7 m	24 in = 610 mm	Q1404A (AEJN)
			36 in = 914 mm	Q1405A (AEJN)
			42 in = 1067 mm	Q1406A
HP Coated Paper	90	150 ft = 45.7 m	16.54 in = 420 mm (A2)	Q1443A (J)
			18 in = 458 mm	Q7897A (EJN)
			23.39 in = 594 mm (A1)	Q1442A (EJ)
			24 in = 610 mm	C6019B
			33.11 in = 841 mm (A0)	Q1441A (EJ)
			36 in = 914 mm	C6020B
			42 in = 1067 mm	C6567B
HP Universal Heavyweight Coated Paper	120	100 ft = 30.5 m	24 in = 610 mm	Q1412A (AEJN)
			36 in = 914 mm	Q1413A
			42 in = 1067 mm	Q1414A (AEJN)

Table 13-3 Roll paper (continued)

Paper type	g/m ²	Length	Width	Part numbers
HP Heavyweight Coated Paper	131	100 ft = 30.5 m	24 in = 610 mm	C6029C (AEJN)
			36 in = 914 mm	C6030C
			42 in = 1067 mm	C6569C
			225 ft = 67.5 m	42 in = 1067 mm
HP Super Heavyweight Plus Matte Paper	210	100 ft = 30.5 m	24 in = 610 mm	Q6626A (AEJN)
			36 in = 914 mm	Q6627A (AEJN)
			42 in = 1067 mm	Q6628A (AEJN)
HP Colored Paper Fluorescent Yellow	100	150 ft = 45.7 m	36 in = 914 mm	Q1757A (E)
HP Colored Paper Yellow	92	150 ft = 45.7 m	36 in = 914 mm	Q1760A (EN)
		295.3 ft = 90 m	23.39 in = 594 mm (A1)	Q6596A (E)
HP Technical Paper				
HP Natural Tracing Paper	90	150 ft = 45.7 m	16.54 in = 420 mm (A2)	Q1440A (J)
			23.39 in = 594 mm (A1)	Q1439A (J)
			24 in = 610 mm	C3869A
			33.11 in = 841 mm (A0)	Q1438A (J)
			36 in = 914 mm	C3868A
HP Translucent Bond	67	150 ft = 45.7 m	24 in = 610 mm	C3860A (AJN)
			36 in = 914 mm	C3859A (LN)
HP Vellum	75	150 ft = 45.7 m	24 in = 610 mm	C3862A (N)
			36 in = 914 mm	C3861A (LN)
HP Film (Technical and Graphic)				
HP Clear Film	174	75 ft = 22.9 m	24 in = 610 mm	C3876A (AEJN)
			36 in = 914 mm	C3875A
HP Matte Film	160	125 ft = 38.1 m	24 in = 610 mm	51642A (AEJN)
			36 in = 914 mm	51642B
HP Polyester Film White Matte	167	50 ft = 15.2 m	36 in = 914 mm	Q1736A (AEN)
HP Photographic Paper				
HP Universal Instant-Dry Photo Gloss	190	100 ft = 30.5 m	24 in = 610 mm	Q6574A
			36 in = 914 mm	Q6575A
			42 in = 1067 mm	Q6576A
HP Universal Instant-Dry Photo Semi-Gloss	190	100 ft = 30.5 m	24 in = 610 mm	Q6579A
			36 in = 914 mm	Q6580A
			42 in = 1067 mm	Q6581A



TIP: The dye inks used by your printer will fade very quickly on instant-dry photo papers. If you plan to display the prints for more than two weeks, you should laminate them to achieve longer life.

Table 13-3 Roll paper (continued)

Paper type	g/m ²	Length	Width	Part numbers
HP Premium Plus Photo Gloss	286	50 ft = 15.2 m	24 in = 610 mm	Q5488A
HP Premium Plus Photo Satin	286	50 ft = 15.2 m	18 in = 458 mm	Q7920A
			24 in = 610 mm	Q5491A
HP Universal High-Gloss Photo Paper	190	100 ft = 30.5 m	24 in = 610 mm	Q1426A (AEJN)
			36 in = 914 mm	Q1427A (AEJN)
			42 in = 1067 mm	Q1428A (AEJN)
HP Universal Semi-Gloss Photo Paper	190	100 ft = 30.5 m	24 in = 610 mm	Q1420A (AEJN)
			36 in = 914 mm	Q1421A (AEJN)
			42 in = 1067 mm	Q1422A (AEJN)
HP Photo Paper RC Matte	200	100 ft = 30.5 m	36 in = 914 mm	C7946A (AEN)
HP Backlit Material				
HP Backlit Film Reverse Print Matte	160	75 ft = 22.9 m	36 in = 914 mm	C7960A (AEJN)
HP Self-Adhesive Material and Laminate				
HP Two-View Cling	240	75 ft = 22.9 m	36 in = 914 mm	Q1914A (AEN)
			42 in = 1067 mm	Q1915A (AEN)
HP Indoor Paper Self-Adhesive	170	75 ft = 22.9 m	36 in = 914 mm	Q1733A (EJN)
HP Polypropylene, Matte — Adhesive Backed	225	70 ft = 21.3 m	36 in = 914 mm	Q1908A (AEN)
HP Self-Adhesive Satin/Gloss Polypropylene		75 ft = 22.9 m	36 in = 914 mm	Q8834A
			42 in = 1067 mm	Q8835A
HP Adhesive-backed Polypropylene	128	164 ft = 50 m	36 in = 914 mm	Q8044A (C)

Table 13-4 Sheet paper

Paper type	g/m ²	Length	Width	Part numbers
HP Bond and Coated Paper				
HP Coated Paper	90	24 in = 610 mm	18 in = 457 mm	Q1961A (AEJN)
			24 in = 610 mm	Q1962A (AEN)
HP Photographic Paper				
HP Premium Plus Photo Gloss	286	19 in = 483 mm	13 in = 330 mm	Q5486A
			18 in = 457 mm	Q5487A
HP Premium Plus Photo Satin	286	19 in = 483 mm	13 in = 330 mm	Q5489A
			18 in = 457 mm	Q5490A

Order accessories

The following accessories can be ordered for your printer.

Name	Product number
HP Designjet T1100 24in Stand	Q6663A
HP Designjet T1100 24in Spindle	Q6700A
HP Designjet T1100 44in Spindle	Q6709A
HP Jetdirect 620n Fast Ethernet Print Server	J7934A
HP Jetdirect 625n Gigabit Ethernet Print Server	J7960G
HP Jetdirect 635n IPv6/IPsec Print Server	J7961A

Introduction to the accessories

Stand

The printer stand is used to support the printer and the basket, which collects prints as they emerge from the printer. The main alternative to the stand is to put the printer on a desk.

The height of the stand is 668 mm.

The weight of the stand is 10.12 kg (24 inch).

Spindle

With extra spindles, you can change rapidly from one paper type to another.

Jetdirect print server

Jetdirect print servers support extra connectivity and security options beyond those provided in the standard Gigabit Ethernet interface built into the printer.

14 Troubleshooting paper issues

- [The paper cannot be loaded successfully](#)
- [The paper type is not in the driver](#)
- [The paper has jammed](#)
- [The printer displays out of paper when paper is available](#)
- [Prints do not fall nicely into the basket](#)
- [The sheet stays in the printer when the print has been completed](#)
- [The paper is cut when the print has been completed](#)
- [The cutter does not cut well](#)
- [The roll is loose on the spindle](#)
- [A strip stays on the output tray and generates jams](#)
- [Recalibrate the paper advance](#)

The paper cannot be loaded successfully

- Ensure no paper is loaded.
- Ensure the paper is far enough inside the printer, you should feel the printer grab the paper.
- Do not attempt to straighten the paper during the aligning process, unless instructed to do so by the front-panel display. The printer automatically attempts to straighten the paper.
- The paper may be crumpled, or warped, or may have irregular edges.

General unsuccessful roll load issues

- If the paper does not load, the leading edge of the paper may not be straight or clean and needs to be trimmed. Remove the initial 2 cm (1 in) from the roll and try again. This may be necessary even with a new roll of paper.
- Ensure the roll ends are tight against the spindle ends.
- Check that the spindle is correctly inserted.
- Check that the paper is correctly loaded on the spindle, and that it loads over the roll towards you.
- Check that all roll end plugs have been removed.
- Check that the paper is wound tightly on the roll.
- Do not touch the roll or paper at during the alignment process.

Unsuccessful roll load with 24-inch printer

On a 24-inch printer, if the paper has not been inserted straight, the front panel displays the following instructions.

1. When prompted by the front-panel display, lift the blue lever on the left. The printer attempts to straighten the roll.
2. When prompted by the front-panel display, lower the blue lever. The printer checks the alignment. If the roll is aligned, the printer measures the width and you are now ready to print.

If the roll is still not aligned, the front panel displays an error and instructions.

3. When prompted by the front-panel display, lift the blue lever on the left.
4. Rewind the roll from the end of the spindle until the edge is on the blue line.
5. Press **OK**, on the front panel.
6. When prompted by the front-panel display, lower the lever. The printer checks the alignment. If the roll is aligned, the printer measures the width and you are now ready to print.

If the roll is still not aligned, the front panel displays an error and instructions to start again at step three.

If you would like to start the load process again, cancel the process on the front panel and rewind the roll from the end of the spindle until the edge is removed from the printer.

Unsuccessful roll load with 44-inch printer

On a 44-inch printer, if the paper has not been inserted straight, the front panel displays the following instructions.

1. When prompted by the front-panel display, lift the blue lever on the left. The printer attempts to straighten the roll.
2. When prompted by the front-panel display, lower the blue lever. The printer checks the alignment. If the roll is aligned, the printer measures the width and you are now ready to print.

If the roll is still not aligned, the front panel displays an error and instructions to start again.

If you would like to start the load process again, cancel the process on the front panel and rewind the roll from the end of the spindle until the edge is removed from the printer.



NOTE: If the roll has become loose around the core, the printer cannot load the paper.

Unsuccessful sheet load

- Guide the sheet, especially thick papers, when the printer initially feeds the sheet.
- Do not attempt to straighten the sheet during the loading process, unless instructed to by the front-panel display. The printer automatically attempts to straighten the sheet.
- Do not use hand-cut sheets, which may be of irregular shapes. Use only purchased sheets.

If the sheet is not caught by the printer, the front-panel display asks you to push paper further into the printer, and tries to feed the paper again.

If the sheet is caught by the printer but is not inserted straight, the front panel displays the following instructions.

1. When prompted by the front-panel display, lift the blue lever on the left.
2. Adjust the sheet to align with the front and right side blue lines.
3. Once the sheet is aligned, press **OK** on the front panel.
4. When prompted by the front-panel display, lower the blue lever. The printer checks the alignment. If the sheet is aligned, the printer measures the sheet and feed it out the back into the roll feed. You are now ready to print.

If the sheet is still not aligned, the front panel displays an error and instructions to start again.

If you would like to start the load process again, cancel the process on the front panel and the printer ejects the sheet out the front.

Paper loading error messages

Here is a list of front-panel display messages related to paper loading, with the suggested corrective action.

front-panel display message	Suggested action
Paper incorrectly loaded	The paper has not been loaded correctly; the edge was not aligned with the load guide. Lift the blue lever, remove paper, and lower lever.
Paper not found	During the paper load process the printer did not detect any paper. Ensure the paper is inserted fully and is not transparent.
Paper loaded with too much skew	During the paper load process the printer detected that the paper had too much skew. Follow the instructions on the front-panel display.

front-panel display message	Suggested action
Paper too small	During the load process the printer detected that the paper is too narrow or too short to be loaded in the printer. Press the Cancel key to stop the load process. See Functional specifications on page 200 .
Paper too big	During the load process the printer has detected that the paper is either too wide or too long (sheet only) to be loaded correctly. Press the Cancel key to stop the load process. See Functional specifications on page 200 .
Paper loose around core	The end of the roll has become loose around the core. Tighten the paper to the core or insert a new roll.
Lever lifted	During the load process the blue lever was lifted. This prevents the printer from loading the paper. Follow the instructions on the front-panel display.

The paper type is not in the driver

To work with a paper not in the driver, you can use your paper as one of the profiles already in the driver, however, you must identify whether your paper is transparent or translucent, glossy, matte, or HP Banners with Tyvek®.



NOTE: For glossy paper, it is important to use a glossy paper type, as matte black ink does not print well on glossy paper.

Transparent or translucent paper

If your paper is a transparent film (for example, a transparency) select paper type **Film > Transparent/Clear film**.

If your paper is a translucent paper (for example, technical paper) select paper type **Technical paper > Natural Tracing Paper, Vellum, or Translucent bond**.

Glossy paper

If your paper is glossy, identify whether it is a photo paper or a proofing paper. If you are not sure consider it photo paper.

If your paper is a photo paper, use the **Photo Paper** category. For glossy or high-gloss paper select paper type **Photo Gloss Paper**. For Semi-gloss, Satin, Pearl, or Luster finishes, select paper type **Semi-gloss/Satin Paper**.

To increase gamut on photo paper select paper type **HP Premium Instant-dry Photo Gloss** or **HP Premium Instant-dry Photo Satin**, depending on the finish.

If your paper is a proofing paper, use the **Proofing Paper** category. For glossy or high-gloss paper select paper type **Proofing Gloss**. Otherwise, for Semi-gloss, Pearl, or Luster finishes, select paper type **Proofing Semi-gloss/Satin**.

To increase gamut on proofing paper select paper type **HP Professional High-gloss Contract Proofing Paper** or **HP Professional Semi-gloss Contract Proofing Paper**, depending on the finish.

If you are printing on a glossy banner (for example, HP Instant-Dry Indoor Banner, Gloss) select paper type **Photo Gloss Paper**.

Matte Paper

Your paper type selection for matte paper depends on the paper's ink absorption capacity. To select a paper category and type, first identify if your paper is general purpose or photographic. Then select the recommended paper types.

General purpose paper

- For thin papers (< 90 g/m²) uncoated papers (for example plain paper or bright white paper) select paper type **Bond and Coated > Plain Paper**.
- For light coated papers (<110 g/m²), select paper type **Bond and Coated > Coated Paper**.
- For heavyweight coated papers (<200 g/m²), select paper type **Bond and Coated > Heavyweight Coated Paper**.
- For cockle-free very thick coated papers (> 200 g/m²), select paper type **Bond and Coated > Super Heavyweight Coated Paper**.



CAUTION: Only use this option if you are sure your paper does not wrinkle when printed.

Photographic paper

For photographic paper, select paper type **Photo Paper > Photo Matte Paper**.

HP Banners with Tyvek®

For HP Banners with Tyvek®, select paper type **Photo Paper > Photo Gloss Paper**.

Black ink is easily removed when touched

This happens when your paper is incompatible with matte black ink. To use non-matte black ink, select paper type **Photo Paper > Photo Gloss Paper**.

After printing, the paper has wrinkles or there is too much ink

This happens when too much ink is used. To use less ink, select a thinner category. Matte paper categories from thinnest to thickest are:

- Plain Paper
- Coated Paper
- Heavyweight Coated Paper
- Super Heavyweight Coated Paper

For other image quality problems, see [Troubleshooting print-quality issues on page 159](#).

The paper has jammed

When a paper jam occurs, you normally see the **Possible paper jam** message in the front-panel display.

1. Power off the printer at the front panel and also switch it off at the rear.

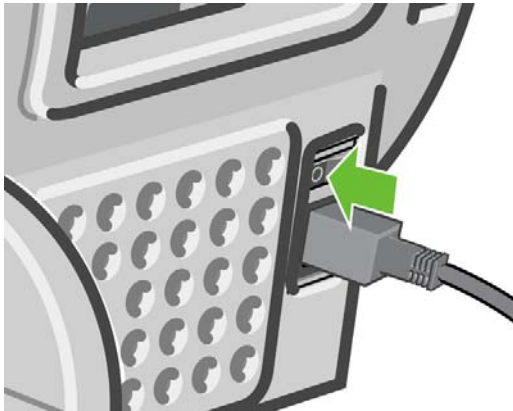

2. Open the window.

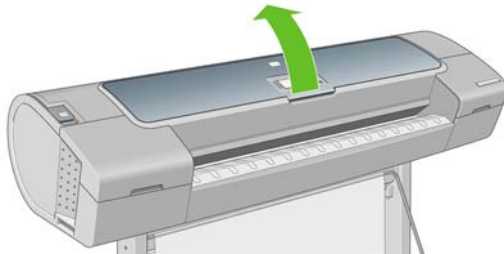

3. Try to move the printhead carriage out of the way.

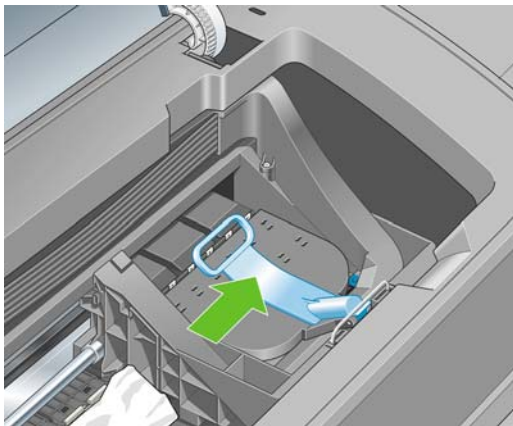

4. Lift the blue lever as far up as it will go.

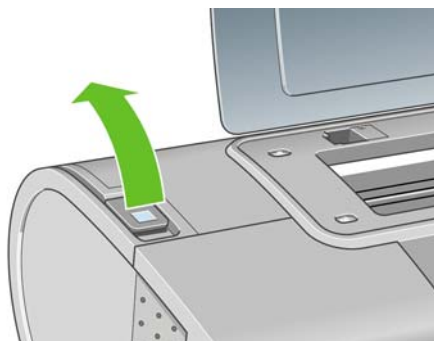

5. Carefully remove any of the jammed paper that you can lift up and out from the top of the printer.

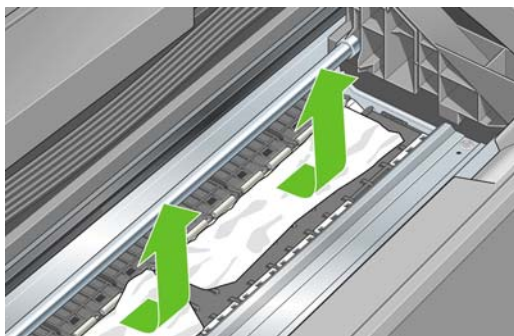

6. Standing behind the printer, rewind the roll or pull the cut sheet from the printer. If you cannot see the paper, return to the front of the printer and remove it from the output tray.



CAUTION: Do not move the paper sideways, as it could damage the printer.



7. Carefully remove all small pieces of paper.

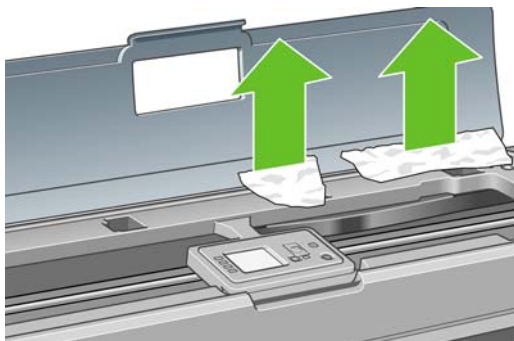

8. Lower the blue lever.

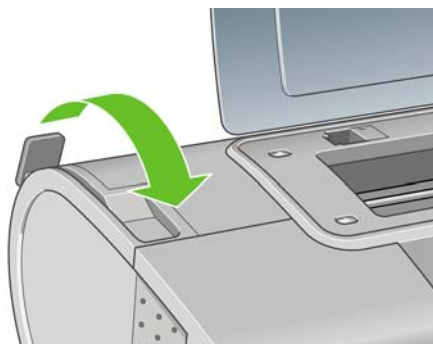

9. Close window.

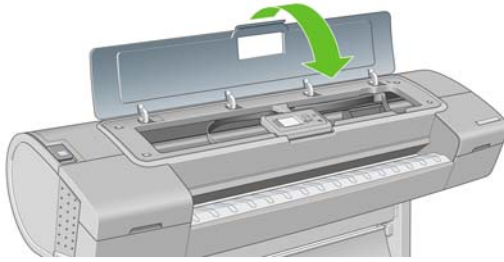

10. Switch on the printer.

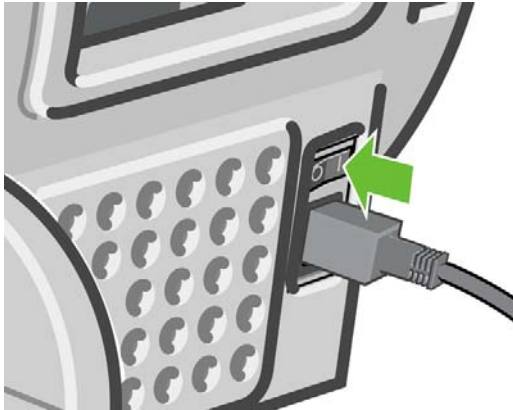

11. Reload the roll, or load a new sheet see [Paper handling on page 35](#).



NOTE: If you find that there is still some paper causing an obstruction within the printer, restart the procedure and carefully remove all pieces of paper.

The printer displays out of paper when paper is available

If the roll has become loose from its core, it will not feed correctly and the printer will not load the paper. If possible, tighten the paper to its core or load a new roll.

Prints do not fall nicely into the basket

- Ensure the basket is correctly installed.
- Ensure the basket is open.
- Ensure the basket not full.
- Paper often tends to curl near the end of a roll, which can cause output problems. Load a new roll, or remove prints manually as they are completed.

The sheet stays in the printer when the print has been completed

The printer holds the paper to allow the print to dry after printing, see [Change the drying time on page 56](#). If the paper is only partially ejected after the drying time, gently pull the sheet out of the printer. If the automatic cutter is disabled, use the **Form feed and cut** key  on the front panel, see [Feed and cut the paper on page 56](#).

The paper is cut when the print has been completed

By default the printer cuts the paper after the drying time has been completed, see [Change the drying time on page 56](#). You can disable the cutter, see [Turn the automatic cutter on and off on page 56](#).

The cutter does not cut well

By default the printer is set to automatically cut the paper after the drying time has been completed.

If the cutter is turned on but not cutting correctly, check that the cutter rail is clean and clear of any obstacles.

If the cutter is turned off, the **Form feed and cut** key  only advances the paper. Use this key to move the print far enough out of the front of the printer, until it is convenient to manually cut with a straight edge or scissors.

The roll is loose on the spindle

The roll may need to be replaced or reloaded. If your roll has a three-inch cardboard core, ensure the core adaptors supplied with the printer have been installed, see [Load a roll onto the 24-inch spindle on page 36](#).

A strip stays on the output tray and generates jams

If a small piece of paper (200 mm or smaller) has been cut, such as before (if new roll) and after a full-bleed print or after the **Form feed and cut** key  has been pressed, the cut strip remains in the output tray. Only when the printer is not working, reach in the tray and remove the strip.

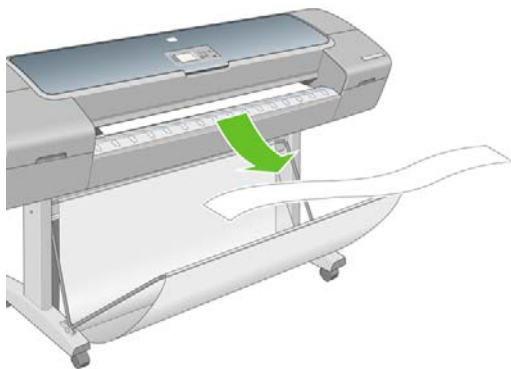

Recalibrate the paper advance

Accurate paper advance is important to image quality because it is part of controlling the proper placement of dots on the paper. If the paper is not advanced the proper distance between printhead passes, light or dark bands appear in the print and image grain may increase.

The printer is calibrated to advance correctly with all the papers appearing in the front panel. When you select the type of loaded paper, the printer adjusts the rate at which to advance the paper while printing. However, if you are not satisfied with the default calibration of your paper, you may need to recalibrate the rate at which the paper advances. See [Troubleshooting print-quality issues on page 159](#) for steps to determine if paper advance calibration will solve your issue.

You can check the paper advance calibration status of the currently loaded paper at any time by pressing the **View loaded paper** key  on the front panel. The status may be one of the following.

- **DEFAULT:** This status appears when loading any paper that has not been calibrated. HP papers in the Front Panel have been optimized by default and unless you experience image quality problems in your printed image such as banding or graininess it is not recommended to recalibrate the paper advance.
- **OK:** This status indicates that the loaded paper has been calibrated before. However you may need to repeat the calibration if you experience image quality problems such as banding or graininess in your printed image.



NOTE: Whenever you update the printer's firmware, the paper advance calibration values are reset to factory default, see [Update the firmware on page 138](#).



CAUTION: Transparent papers and films must be calibrated using Image Quality Maintenance menu icon , then **Paper advance calibration > Adjust paper advance**, from step four in the Recalibrating the paper advance procedure.

Recalibrating the paper advance procedure

1. Press the **Menu** key to return to the main menu and select the Image Quality Maintenance menu icon , then **Calibrate paper advance**. The printer automatically recalibrates the paper advance and prints a paper advance calibration image.
2. Wait until the front panel displays the status screen and re-print your print.



NOTE: The recalibration procedure takes approximately three minutes. Do not worry about the paper advance calibration image. The front-panel display shows any errors in the process.

If you are satisfied with your print continue using this calibration for your paper type. If you see improvement in your print, continue with step three. If you are dissatisfied with the recalibration, return to the default calibration, see [Return to default calibration on page 157](#).

3. If you would like to fine-tune the calibration or are using a transparent paper, press the **Menu** key to return to the main menu and select the Image Quality Maintenance menu icon , then **Paper advance calibration > Adjust paper advance**.
4. Select the percentage of change from -100% to 100%. To correct light banding, decrease the percentage. To correct dark banding, increase the percentage.
5. Press the **OK** key on the front panel, to save the value.
6. Wait until the front panel displays the status screen and re-print your print.

Return to default calibration

Returning to the default calibration sets all the corrections made by the paper advance calibration to zero. To return to the default paper advance calibration value, you must reset the calibration.

1. Press the **Menu** key to return to the main menu and select the Image Quality Maintenance menu icon , then **Paper advance calibration > Reset paper advance**.
2. Wait until the front panel displays the operation has completed successfully before pressing the back key to return to the main menu.

15 Troubleshooting print-quality issues

- [General advice](#)
- [Print quality troubleshooting wizard](#)
- [Horizontal lines across the image \(banding\)](#)
- [Lines are too thick, too thin, or missing](#)
- [Lines appear stepped or jagged](#)
- [Lines print double or in the wrong colors](#)
- [Lines are discontinuous](#)
- [Lines are blurred](#)
- [Line lengths are inaccurate](#)
- [The whole image is blurry or grainy](#)
- [The paper is not flat](#)
- [The print is scuffed or scratched](#)
- [Ink marks on the paper](#)
- [Black ink comes off when you touch the print](#)
- [Edges of objects are stepped or not sharp](#)
- [Edges of objects are darker than expected](#)
- [Horizontal lines at the end of a cut sheet print](#)
- [Vertical lines of different colors](#)
- [White spots on the print](#)
- [Colors are inaccurate](#)
- [Colors are fading](#)
- [The image is incomplete \(clipped at the bottom\)](#)
- [The image is clipped](#)
- [Some objects are missing from the printed image](#)
- [A PDF file is clipped or objects are missing](#)
- [The Image Diagnostics Print](#)
- [If you still have a problem](#)

General advice

When you have any print-quality problem:

- To achieve the best performance from your printer, use only genuine manufacturer's supplies and accessories, whose reliability and performance have been thoroughly tested to give trouble-free performance and best-quality prints. For details of recommended papers, see [Order paper on page 142](#).
- Make sure that the paper type selected in the front panel is the same as the paper type loaded into the printer. To check this, use the **View loaded paper** key  on the front panel. At the same time, check that the paper type has been calibrated. Also make sure that the paper type selected in your software is the same as the paper type loaded into the printer.



CAUTION: If you have the wrong paper type selected, you could experience poor print quality and incorrect colors, and perhaps even damage to the printheads.

- Check that you are using the most appropriate print-quality settings for your purposes (see [Printing on page 59](#)). You are likely to see lower print quality if you have moved the print-quality slider to the 'Speed' end of the scale, or set the custom quality level to **Fast**.
- Check that your environmental conditions (temperature, humidity) are in the recommended range. See [Environmental specifications on page 202](#).
- Check that your ink cartridges and printheads have not passed their expiration dates: see [Maintain the ink cartridges on page 137](#).

Print quality troubleshooting wizard

The Print Quality Troubleshooting Wizard can help with the following problems:

- Horizontal lines across the image (banding)
- The whole image is blurry or grainy
- Lines are too thick, too thin, or missing
- Colors are inaccurate

To start the wizard:

- **From HP Easy Printer Care under Windows:** go to the **Support** tab, and select **Print quality troubleshooting**.
- **From HP Printer Utility under Mac OS:** select **Support**, then **Print quality troubleshooting**.
- **From the Mac OS Print dialog:** go to the **Services** panel, select **Device Maintenance**, then select **Print quality troubleshooting** from the list of maintenance tasks.
- **From the Embedded Web Server:** go to the **Support** tab, select **Troubleshooting**, then select **Print quality troubleshooting**.

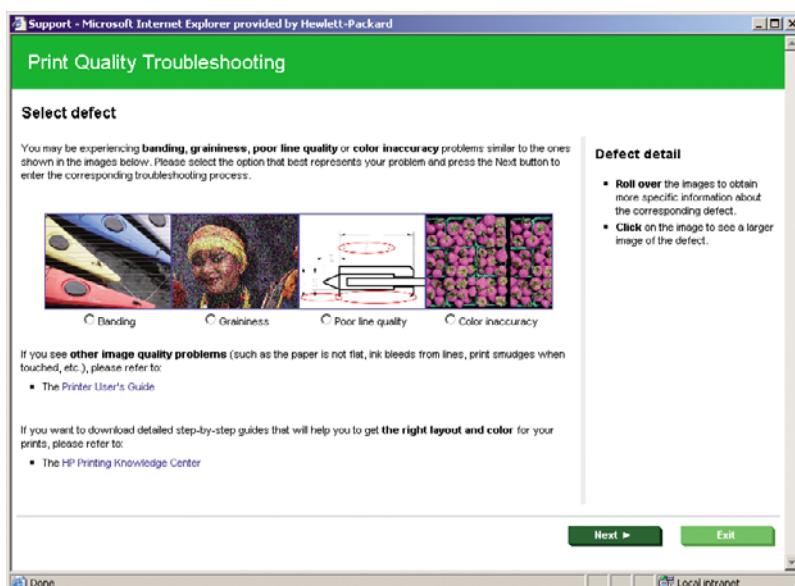



Alternatively, or if you have other print quality problems, you can continue reading this chapter.

Horizontal lines across the image (banding)

If your printed image suffers from added horizontal lines as shown (the color may vary):





1. Check that the paper type you have loaded corresponds to the paper type selected in the front panel and in your software. To check on the front panel, use the **View loaded paper** key .
2. Check that you are using appropriate print-quality settings for your purposes (see [Printing on page 59](#)). In some cases, you can overcome a print-quality problem merely by selecting a higher print-quality level. For instance, if you have set the Print Quality slider to **Speed**, try setting it to **Quality**. If you change the print-quality settings, you may wish to reprint your job at this point in case the problem has been solved.
3. Print the Image Diagnostics Print. See [The Image Diagnostics Print on page 172](#).
4. If the printheads are working correctly, go to the front panel and press the **View loaded paper** key  to see the paper advance calibration status. If the status is DEFAULT, try performing paper advance calibration: see [Recalibrate the paper advance on page 155](#).

If the problem persists despite all the above actions, contact your customer service representative for further support.

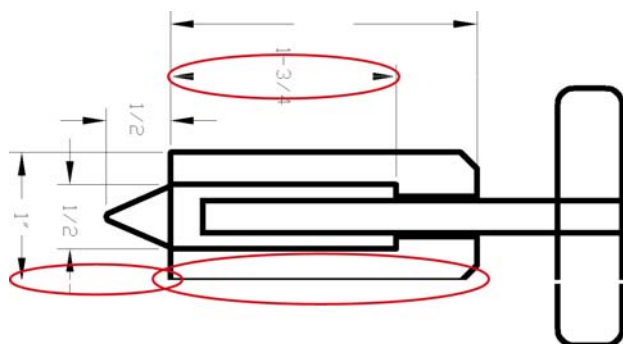
Lines are too thick, too thin, or missing



1. Check that the paper type you have loaded corresponds to the paper type selected in the front panel and in your software. To check on the front panel, use the **View loaded paper** key .
2. Check that you are using appropriate print-quality settings for your purposes (see [Printing on page 59](#)). Select the custom print-quality options in the driver dialog (Mac OS Print dialog), and try turning on the **Maximum detail** option (if available). You may wish to reprint your job at this point in case the problem has been solved.
3. If the resolution of your image is greater than the printing resolution, you may notice a loss of line quality. If you are using the PCL or HP-GL/2 driver for Windows, you can find the **Max. Application Resolution** option in the driver dialog's **Advanced** tab, under **Document Options > Printer Features**. If you change this option, you may wish to reprint your job at this point in case the problem has been solved.
4. If lines are too thin or missing, print the Image Diagnostics Print. See [The Image Diagnostics Print on page 172](#).
5. If the problem remains, go to the front panel and select the Ink menu icon , then **Printhead information** to see the printhead alignment status. If the status is PENDING, you should align the printheads. See [Align the printheads on page 182](#). After alignment, you may wish to reprint your job in case the problem has been solved.
6. Go to the front panel and press the **View loaded paper** key  to see the paper advance calibration status. If the status is DEFAULT, you should perform paper advance calibration: see [Recalibrate the paper advance on page 155](#).

If the problem persists despite all the above actions, contact your customer service representative for further support.

Lines appear stepped or jagged

If lines in your image appear stepped or jagged when printed:

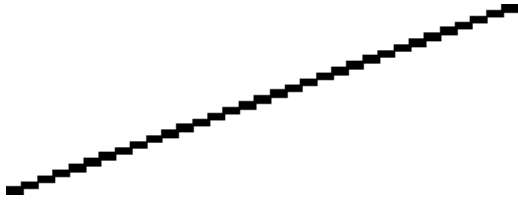

1. The problem may be inherent in the image. Try to improve the image with the application you are using to edit it.
2. Check that you are using appropriate print-quality settings. See [Printing on page 59](#).
3. Select the custom print-quality options in the driver dialog (Mac OS Print dialog), and turn on the **Maximum detail** option (if available).
4. If you are using the PCL or HP-GL/2 driver for Windows, you can change your image rendering resolution to 300 dpi or 600 dpi depending on your printing needs. You can find the **Max. Application Resolution** option in the driver dialog's **Advanced** tab, under **Document Options > Printer Features**.

Lines print double or in the wrong colors

This problem can have various visible symptoms:

- Colored lines are printed double, in different colors.

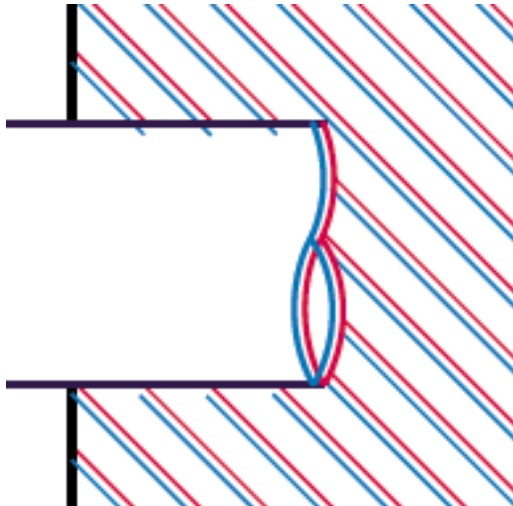

- The borders of colored blocks are wrongly colored.



To correct this kind of problem:

1. Reseat the printheads by removing them and then reinserting them. See [Remove a printhead on page 124](#) and [Insert a printhead on page 127](#).
2. Align the printheads. See [Align the printheads on page 182](#).

Lines are discontinuous

If your lines are broken in the following way:



1. Check that you are using appropriate print-quality settings. See [Printing on page 59](#).
2. Reseat the printheads by removing them and then reinserting them. See [Remove a printhead on page 124](#) and [Insert a printhead on page 127](#).
3. Align the printheads. See [Align the printheads on page 182](#).

Lines are blurred



Humidity can cause ink to soak into the paper, making the lines blurred and fuzzy. Try the following:

1. Check that your environmental conditions (temperature, humidity) are suitable for high-quality printing. See [Environmental specifications on page 202](#).
2. Check that the paper type selected in the front panel is the same as the paper type you are using.
To check on the front panel, use the **View loaded paper** key .
3. Try changing to a heavier paper type, such as HP Heavyweight Coated Paper or HP Super Heavyweight Plus Matte Paper.
4. Select a paper type that is slightly thinner than the paper you have loaded; this will persuade the printer to use less ink. Here are some example paper types in ascending order of thickness: Plain Paper, Coated Paper, Heavyweight Coated Paper, Super Heavyweight Plus Matte Paper.
5. If you are using glossy paper, try changing to a different type of glossy paper.
6. Align the printheads. See [Align the printheads on page 182](#).



Line lengths are inaccurate

If you have measured your printed lines and find that the lengths are not sufficiently accurate for your purposes, you can try to improve line length accuracy in the following ways.

1. Print on HP Matte Film, for which your printer's line length accuracy is specified. See [Functional specifications on page 200](#).
Polyester film is about ten times more dimensionally stable than paper. However, using film that is thinner or thicker than HP Matte Film will reduce line length accuracy.
2. Set the Print Quality slider to **Quality**.
3. Maintain the room at a steady temperature between 10 and 30°C (50 and 86°F).
4. Load the roll of film and let it rest for five minutes before printing.
5. If you are still not satisfied, try recalibrating the paper advance. See [Recalibrate the paper advance on page 155](#).

The whole image is blurry or grainy



1. Check that the paper type you have loaded corresponds to the paper type selected in the front panel and in your software. To check on the front panel, use the **View loaded paper** key .
2. Check that you are printing on the correct side of the paper.
3. Check that you are using appropriate print-quality settings (see [Printing on page 59](#)). In some cases, you can overcome a print-quality problem merely by selecting a higher print-quality level. For instance, if you have set the Print Quality slider to **Speed**, try setting it to **Quality**. If you change the print-quality settings, you may wish to reprint your job at this point in case the problem has been solved.
4. Go to the front panel and select the Ink menu icon , then **Printhead information** to see the printhead alignment status. If the status is PENDING, you should align the printheads. See [Align the printheads on page 182](#). After alignment, you may wish to reprint your job in case the problem has been solved.
5. Go to the front panel and press the **View loaded paper** key  to see the paper advance calibration status. If the status is DEFAULT, you should perform paper advance calibration: see [Recalibrate the paper advance on page 155](#).

If the problem persists despite all the above actions, contact your customer service representative for further support.

The paper is not flat

If the paper does not lie flat when it comes out of the printer, but has shallow waves in it, you are likely to see defects in the printed image, such as vertical stripes. This can happen when you use thin paper that becomes saturated with ink.



1. Check that the paper type you have loaded corresponds to the paper type selected in the front panel and in your software. To check on the front panel, use the **View loaded paper** key .
2. Try changing to a thicker paper type, such as HP Heavyweight Coated Paper or HP Super Heavyweight Plus Matte Paper.
3. Select a paper type that is slightly thinner than the paper you have loaded; this will persuade the printer to use less ink. Here are some example paper types in ascending order of thickness: Plain Paper, Coated Paper, Heavyweight Coated Paper, Super Heavyweight Plus Matte Paper.

The print is scuffed or scratched

The black ink pigment can be scuffed or scratched when touched by a finger, a pen, or some other object. This is particularly noticeable on coated paper and matte proofing paper.

Glossy paper may be extremely sensitive to the basket or to anything else that it contacts soon after printing, depending on the amount of ink used and the environmental conditions at the time of printing.

To reduce the risk of scuffs and scratches:

- Handle prints carefully.
- Avoid stacking prints on top of each other.
- Disable the automatic cutter before printing, so that the print will not fall into the basket. See [Turn the automatic cutter on and off on page 56](#). Alternatively, leave a sheet of paper in the basket so that freshly printed sheets do not make direct contact with the basket.

Ink marks on the paper

This problem can occur for several different reasons.

Horizontal smears on the front of coated paper

If a lot of ink is used on plain or coated paper, the paper absorbs the ink quickly and expands. As the printheads move over the paper, the printheads may come into contact with the paper and smear the printed image. This problem is normally seen only on cut sheets of paper (not on roll paper).

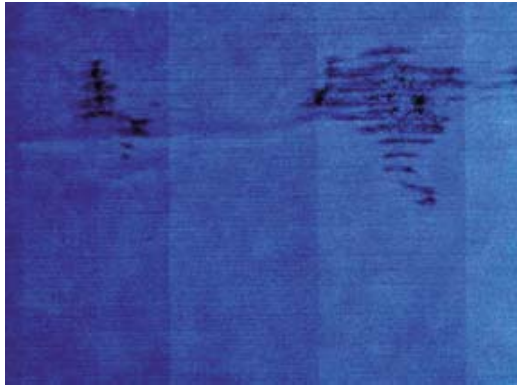

Whenever you notice this problem, cancel the printing job immediately. Press the **Cancel** key and also cancel the job from your computer application. Soaked paper can damage the printheads.

Try the following suggestions to avoid this problem:

1. Check that the paper type you have loaded corresponds to the paper type selected in the front panel and in your software. To check on the front panel, use the **View loaded paper** key .
2. Use a recommended paper type (see [Order paper on page 142](#)) and the correct print settings.
3. If using sheet paper, try rotating the sheet 90 degrees. The orientation of the paper fibers may affect performance.
4. Try changing to a thicker paper type, such as HP Heavyweight Coated Paper and HP Super Heavyweight Plus Matte Paper.
5. Select a paper type that is slightly thinner than the paper you have loaded; this will persuade the printer to use less ink. Here are some example paper types in ascending order of thickness: Plain Paper, Coated Paper, Heavyweight Coated Paper, Super Heavyweight Plus Matte Paper.
6. Try to increase the margins by relocating the image to the center of the page using your software application.

Ink marks on the back of the paper

This can happen after a lot of borderless printing, especially with non-standard paper sizes. Ink residues on the platen are likely to mark the back of the paper.

Clean the platen with a soft cloth. Clean each rib separately without touching the foam between the ribs.

Black ink comes off when you touch the print

This problem may be caused by printing with matte black ink on glossy paper. The printer will not use matte black ink if it knows that the paper will not retain it. To be sure of avoiding matte black ink, you can select Photo Glossy Paper as the paper type (in the Photo Paper category).

Edges of objects are stepped or not sharp

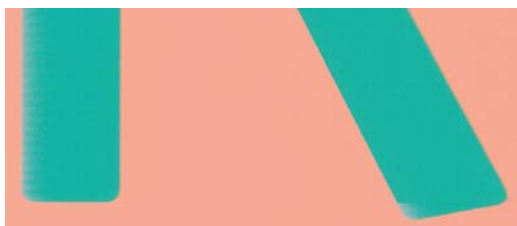

If edges of objects or lines appear to be poorly defined or lighter in density, and you have already set the print-quality slider to **Quality** in the driver dialog (Mac OS Print dialog), select the custom print-quality options, and try setting the quality level to **Normal**. See [Printing on page 59](#).

Edges of objects are darker than expected



If edges of objects seem darker than expected, and you have already set the print-quality slider to **Quality** in the driver dialog (Mac OS Print dialog), select the custom print-quality options, and try setting the quality level to **Normal**. See [Printing on page 59](#).

Horizontal lines at the end of a cut sheet print

This type of defect affects only the end of a print, within approximately 30 mm of the trailing edge of the paper. You may see some very thin horizontal lines across the print.

To avoid this problem:

1. Print the Image Diagnostics Print. See [The Image Diagnostics Print on page 172](#).
2. Consider printing with roll paper.
3. Consider using larger margins around your image.

Vertical lines of different colors

If your print has vertical bands of different colors along it:

1. Try using thicker paper, choosing from the recommended paper types such as HP Heavyweight Coated Paper and HP Super Heavyweight Paper. See [Order paper on page 142](#).
2. Try using higher print-quality settings (see [Printing on page 59](#)). For instance, if you have set the Print Quality slider to **Speed**, try setting it to **Quality**.

White spots on the print

You may notice white spots on the print. This is probably due to paper fibers, dust, or loose coating material. To avoid this problem:

1. Try cleaning the paper manually with a brush before printing, to remove any loose fibers or particles.
2. Always keep the cover of your printer closed.
3. Protect your paper rolls and sheets by storing them in bags or boxes.

Colors are inaccurate



If the colors of your print do not match your expectations, try the following:

1. Check that the paper type you have loaded corresponds to the paper type selected in the front panel and in your software. To check on the front panel, use the [View loaded paper](#) key . At the same time, check the color calibration status. If the status is PENDING or OBSOLETE, you should perform color calibration: see [Color calibration on page 74](#). If you have made any changes, you may wish to reprint your job in case the problem has been solved.
2. Check that you are printing on the correct side of the paper.
3. Check that you are using appropriate print-quality settings (see [Printing on page 59](#)). If you have selected the **Speed** or **Fast** options, you may not get the most accurate colors. If you change the print-quality settings, you may wish to reprint your job at this point in case the problem has been solved.
4. If you are using Application Color Management, check that the color profile you are using corresponds to the selected paper type and print-quality settings. If you have doubts about which color settings to use, see [Color management on page 73](#).
5. If the problem consists of color differences between your print and your monitor, please follow the instructions in the “How to calibrate your monitor” section of the HP Color Center. At this point, you may wish to reprint your job in case the problem has been solved.
6. Print the Image Diagnostics Print. See [The Image Diagnostics Print on page 172](#).
7. Try using the color adjustment options to produce the colors you want. See [Color adjustment options on page 77](#).

If the problem persists despite all the above actions, contact your customer service representative for further support.

Color accuracy using EPS or PDF images in page layout applications

Page layout applications such as Adobe InDesign and QuarkXPress do not support color management of EPS, PDF, or grayscale files.

If you have to use such files, try to ensure that the EPS, PDF, or grayscale images are already in the same color space that you intend to use later on in Adobe InDesign or QuarkXPress. For instance, if your final goal is to print the job in a press that follows the SWOP standard, convert the image into SWOP when you create it.

Colors are fading

If you print on instant-dry photo paper, your prints will fade rapidly. If you plan to display the prints for more than two weeks, you should laminate them to achieve longer life.

Prints on swellable coated papers will fade much less rapidly. However, lamination will increase the life of prints (depending on the type of lamination) with all paper types. For more information, consult your laminate provider.

The image is incomplete (clipped at the bottom)

- Did you press **Cancel** before all the data were received by the printer? If so, you have ended the data transmission and will have to print the page again.
- The **I/O timeout** setting may be too short. This setting determines how long the printer waits for the computer to send more data, before deciding that the job is finished. From the front panel, increase the **I/O timeout** setting to a longer period and then send the print again. From the Connectivity menu , select **Advanced** > **Select I/O timeout**.
- There may be a communications problem between your computer and the printer. Check your USB or network cable.
- Check to make sure that your software settings are correct for your current page size (for example, long-axis prints).
- If you are using network software, make sure it has not timed out.

The image is clipped

Clipping normally indicates a discrepancy between the actual printable area on the loaded paper and the printable area as understood by your software. You can often identify this kind of problem before printing by previewing your print (see [Preview a print on page 65](#)).

- Check the actual printable area for the paper size you have loaded.
printable area = paper size – margins
- Check what your software understands to be the printable area (which it may call "printing area" or "imageable area"). For example, some software applications assume standard printable areas that are larger than those used in this printer.
- If you have defined a custom page size with very narrow margins, the printer may impose its own minimal margins, clipping your image slightly. You may want to consider using a larger paper size, or borderless printing (see [Select margins options on page 62](#)).
- If your image contains its own margins, you may be able to print it successfully by using the **Clip Contents by Margins** option (see [Select margins options on page 62](#)).
- If you are trying to print a very long image on a roll, check that your software is capable of printing an image of that size.
- You may have asked to rotate the page from portrait to landscape on a paper size that is not wide enough.
- If necessary, reduce the size of the image or document in your software application, so it fits between the margins.

There is another possible explanation for a clipped image. Some applications, such as Adobe Photoshop, Adobe Illustrator, and CorelDRAW, use an internal 16-bit coordinate system which means

that they cannot handle an image of more than 32,768 pixels. If you try to print an image larger than this from these applications, the bottom of the image will be clipped. In this case, the only way to print the whole image is to reduce the resolution so that the whole image requires fewer than 32,768 pixels. The PCL and HP-GL/2 drivers for Windows include an option called **16-bit App. Compatibility**, which can be used to reduce the resolution of such images automatically. You can find this option in the **Advanced** tab, under **Document Options > Printer Features**.

Some objects are missing from the printed image

Large quantities of data may be necessary to print a high-quality large-format print job, and in some specific workflows there may be issues that can lead to some objects missing from the output. Here are some recommendations for the use of the PCL or HP-GL/2 drivers for Windows in these cases.

- In the **Advanced** tab, select **Document options, Printer features**, and set **Send job as bitmap** to **Enabled** (HP-GL/2 driver only).
- In the **Advanced** tab, select **Document options, Printer features**, and set **16-bit App. Compatibility** to **Enabled**.
- In the **Advanced** tab, select **Document options, Printer features**, and set **Max. Application resolution** to 300.

The above settings are mentioned for troubleshooting purposes and may adversely affect the final output quality or the time necessary to generate the print job. Therefore, they should be restored to their default values if they do not help to solve the problem.

If you are working under Mac OS or using a PostScript driver, the above settings are not available. Instead, you could try reducing the resolution of bitmap images in your application software.



A PDF file is clipped or objects are missing

In older versions of Adobe Acrobat or Adobe Reader, large PDF files could be clipped or lose some objects when printing with the HP-GL/2 driver at high resolution. In order to avoid such problems, upgrade your Adobe Acrobat or Adobe Reader software to the latest version. From version 7 onwards, these problems should be solved.

The Image Diagnostics Print

The Image Diagnostics Print consists of patterns designed to highlight printhead reliability problems. It helps you to check the performance of the printheads that are currently installed in your printer, and whether any printhead suffers from clogging or other problems.

To print the Image Diagnostics Print:

1. Use the same paper type that you were using when you detected a problem.
2. Use the **View loaded paper** key  on the front panel to check that the selected paper type is the same as the paper type loaded into the printer.
3. At the printer's front panel, select the Image Quality Maintenance menu icon , then **Print diagnostic image**.

It takes about two minutes to print the Image Diagnostics Print.

The print is divided into two parts, both of which test printhead performance.

- Part 1 (top) consists of rectangles of pure colors, one for each printhead. This part represents the print quality that you will get from each color.
- Part 2 (bottom) consists of small dashes, one for each nozzle on each printhead. This part complements the first, and aims more specifically to detect how many faulty nozzles each printhead has.

Please look carefully at the print. The names of the colors are shown above the rectangles and in the center of the patterns of dashes.

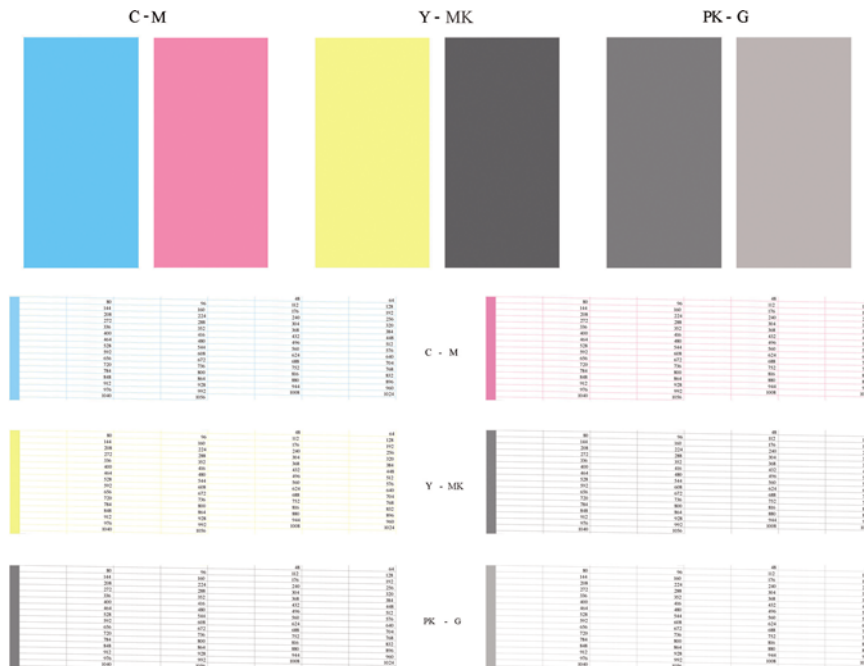

First look at the upper part of the print (part 1). Each colored rectangle should be a uniform color without any horizontal lines across it.

Then look at the bottom part of the print (part 2). For each individual colored pattern, check that most of the dashes are present.

If you see horizontal lines in part 1 and also missing dashes in part 2 for the same color, the printhead responsible needs cleaning. However, if the rectangles look solid, do not worry about just a few missing dashes in part 2; these are acceptable because the printer can compensate for a few clogged nozzles.

Here is an example of a gray printhead in a good state:

G

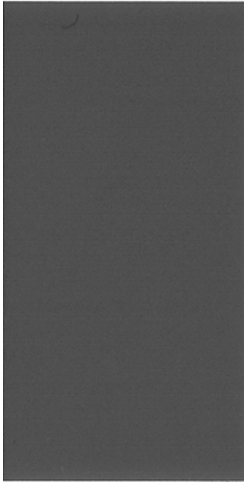

And here is an example of the same printhead in a bad state:

G

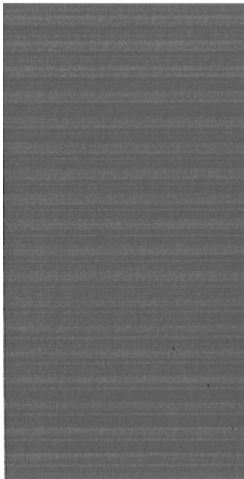

Corrective action

1. Clean any faulty printheads (see [Clean the printheads on page 179](#)). Then reprint the Image Diagnostics Print to see whether the problem has been solved.
2. If the problem remains, clean the printheads again, and reprint the Image Diagnostics Print to see whether the problem has been solved.
3. If the problem remains, consider cleaning your printheads manually (see [Clean the printheads on page 179](#)). You could also try reprinting your current print job, in case it now prints satisfactorily.
4. If the problem remains, try cleaning the printhead drop detector. The printer normally notifies you when this is necessary, but it may be worth trying even if the printer has not suggested it. See [Clean the printhead drop detector on page 180](#).
5. If the problem still remains, replace any persistently faulty printheads (see [Handling ink cartridges and printheads on page 119](#)), or contact HP Support (see [Contact HP Support on page 196](#)).

If you still have a problem

If you still experience print-quality problems after applying the advice in this chapter, here are some further things that you can do:

- Try using a higher print-quality option. See [Printing on page 59](#).
- Check the driver you are using to print with. If it is a non-HP driver, consult the driver vendor about the problem. You could also try using the correct HP driver, if feasible. The latest HP drivers can be downloaded from <http://www.hp.com/go/designjet/>.
- If you are using a non-HP RIP, its settings may be incorrect. See the documentation that came with the RIP.
- Check that your printer's firmware is up to date. See [Update the firmware on page 138](#).
- Check that you have the right settings in your software application.

16 Troubleshooting ink cartridge and printhead issues

- [Cannot insert an ink cartridge](#)
- [Ink cartridge status messages](#)
- [Cannot insert a printhead](#)
- [The front-panel display recommends reseating or replacing a printhead](#)
- [Clean the printheads](#)
- [Clean the printhead drop detector](#)
- [Align the printheads](#)
- [Printhead status messages](#)

Cannot insert an ink cartridge

1. Check that you have the correct type of cartridge (model number).
2. Check that the colored label on the cartridge is the same color as the label on the slot.
3. Check that the cartridge is correctly oriented, with the letter or letters marking the cartridge label right-side up and readable.



CAUTION: Never clean inside the ink cartridge slots.

Ink cartridge status messages

These are the possible ink cartridge status messages:

- **OK:** the cartridge is working normally, with no known problems.
- **Missing:** there is no cartridge present, or it is not correctly connected to the printer.
- **Low:** the ink level is low.
- **Very low:** the ink level is very low.
- **Empty:** the cartridge is empty.
- **Reseat:** you are recommended to remove the cartridge and then reinsert it.
- **Replace:** you are recommended to replace the cartridge with a new cartridge.
- **Altered:** there is something unexpected about the cartridge's status.
- **Expired:** it is past the cartridge's expiration date.

Cannot insert a printhead

1. Check that you have the correct type of printhead (model number).
2. Check that you have removed the two orange protective caps from the printhead.
3. Check that the colored label on the printhead is the same color as the label on the slot.
4. Check that the printhead is correctly oriented (compare with the others).

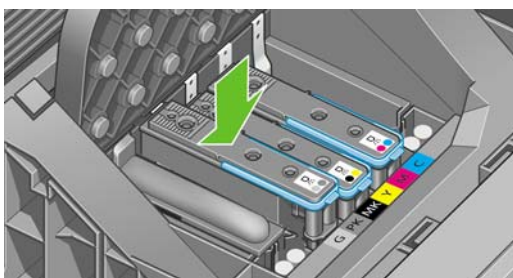

5. Check that you have correctly closed and latched the printhead cover, see [Insert a printhead on page 127](#).

The front-panel display recommends reseating or replacing a printhead

1. From the front panel, turn the power off then on.
2. Check the front-panel display message, if it shows the ready message, the printer is ready to print. If the problem remains continue with the next step.
3. Remove the printhead, see [Remove a printhead on page 124](#).
4. Clean the electrical connections on the backside of the printhead with a lint free cloth. You can carefully use a mild rubbing alcohol if moisture is needed to remove residue. Do not use water.



CAUTION: This is a delicate process and may damage the printhead. Do not touch the nozzles on the bottom side of the printhead, especially not with any alcohol.

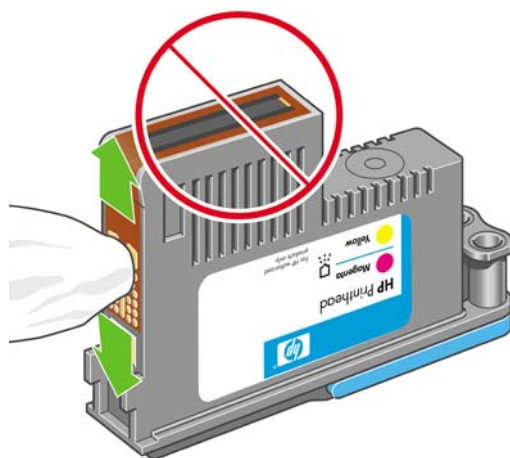

5. Reinsert the printhead, see [Insert a printhead on page 127](#).
6. Check the front-panel display message. If the problem remains, try a new printhead.

Clean the printheads

As long as the printer is kept turned on, an automatic cleaning is performed periodically. This ensures there is fresh ink in the nozzles and prevents nozzle clogs, which ensures color accuracy. If you have not already done so, please see [The Image Diagnostics Print on page 172](#) before proceeding.

To clean the printheads, press the **Menu** key to return to the main menu and select the Image Quality

Maintenance menu icon , then **Clean printheads**. If you have gone through the Image Quality Diagnostic print process, you know which colors are failing. Select the pair of printheads which contain the failing colors. If you are not sure which colors to clean, you can also select to clean all printheads. Cleaning all printheads takes about nine minutes. Cleaning a single pair of printheads takes about six minutes.



NOTE: Cleaning all printheads uses more ink than cleaning a single pair.

If you have cleaned the printheads using the Clean printheads procedure from the front panel and are still experiencing image quality problems, you can try cleaning the printhead nozzles manually using the following procedure.



CAUTION: This is a delicate process and may damage the printhead. Do not touch the electrical connections on the backside of the printhead.

You must remove the printhead, see [Remove a printhead on page 124](#), and using a lint free cloth, clean the bottom of the printhead until the residue is removed.

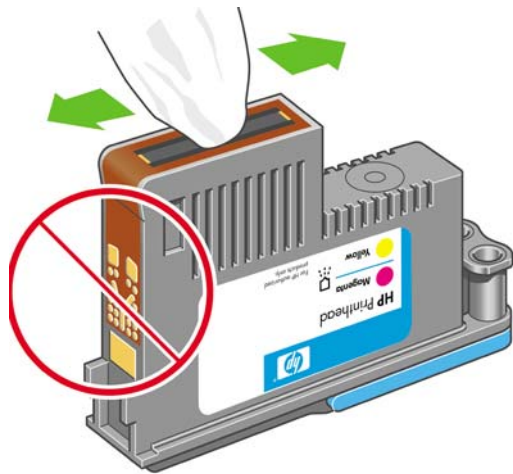

Clean the printhead drop detector

The printhead drop detector is a sensor that detects which nozzles on the printheads are not printing in order to substitute them for good printing nozzles. If particles, such as fibers, hair, or paper pieces, block the sensor print-quality is affected.

When the front panel displays a warning message that the clean process is needed, you are recommended to clean the printhead drop detector. If you do not clean the printhead drop detector immediately, the printer continues working normally, however, the front panel display continues to show the warning.



CAUTION: Wear gloves to avoid getting ink on your hands.

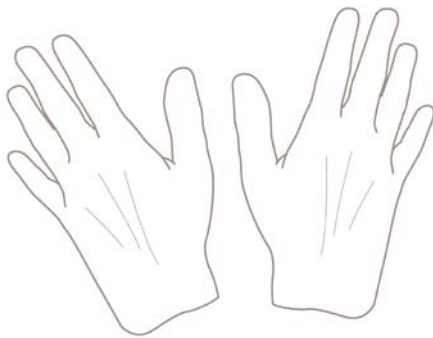

1. Turn off the printer at the front panel.



2. To avoid an electric shock, switch the printer off and unplug it.

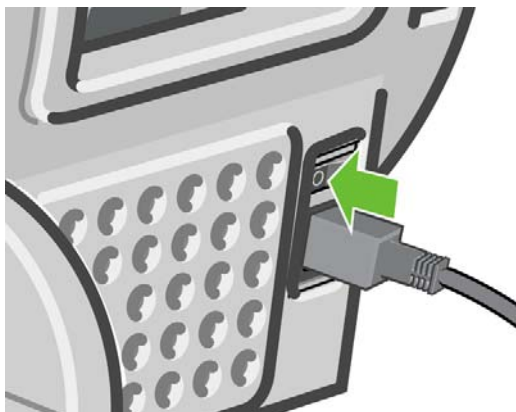

3. Open the window.

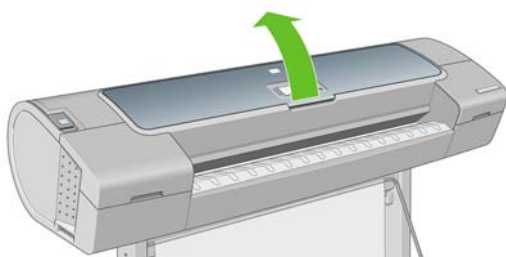

4. Find the printhead drop detector beside the stored printhead carriage.

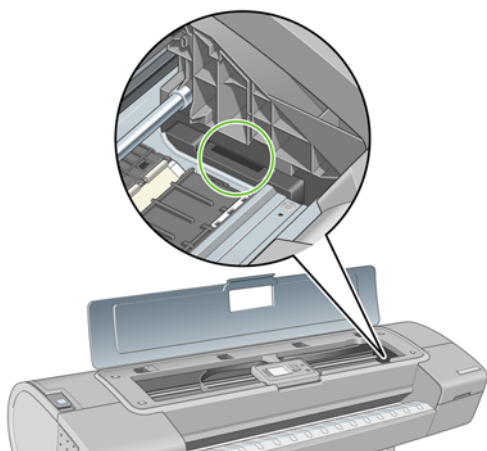

5. Remove any debris blocking the printhead drop detector.

6. With a dry lint free cloth, wipe the surface of the drop detector to remove any non-visible debris.

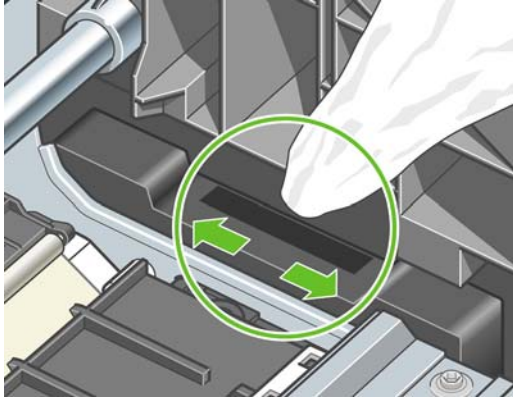

7. Close the window.

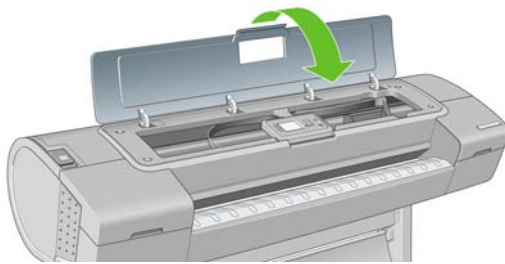

8. Plug in and switch on the printer.

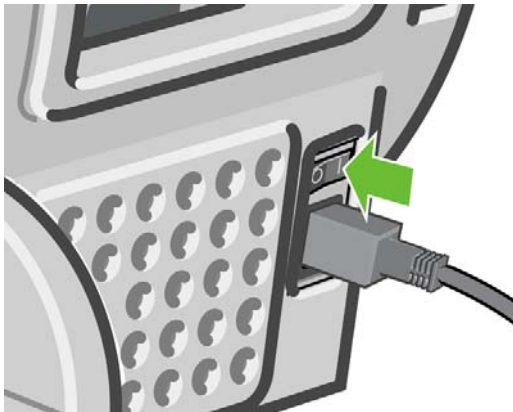

9. Power the printer on at the front panel.



Align the printheads

Precise alignment between printheads is essential for accurate colors, smooth color transitions, and sharp edges in graphical elements. Your printer has an automatic printhead alignment process which runs whenever a printhead has been accessed or replaced.

In cases where the paper has jammed or you are experiencing problems with color accuracy, see [Color management on page 73](#); you may need to align the printheads.



NOTE: If the paper has jammed, it is recommended that you reinsert the printheads and initiate the realignment procedure with the Image Quality Maintenance menu .



CAUTION: Do not use transparent or semi-transparent paper to align the printheads.

Reinsert printheads procedure

1. If the realignment process is running and the wrong paper is loaded, press the **Cancel** key on the front panel.



CAUTION: Do not print if the realignment process has been canceled. You can restart the alignment with the Image Quality Maintenance menu procedure.

2. Load the paper you wish to use, see [Paper handling on page 35](#). You can use a roll or cut sheet, however, it must be A3 landscape or larger.



CAUTION: Do not use transparent or semi-transparent paper to align the printheads.

3. Remove and re-insert all the printheads, see [Remove a printhead on page 124](#) and [Insert a printhead on page 127](#). This starts the printhead alignment procedure.
4. Ensure the window is closed, as a strong light source near the printer during printhead realignment can affect alignment.

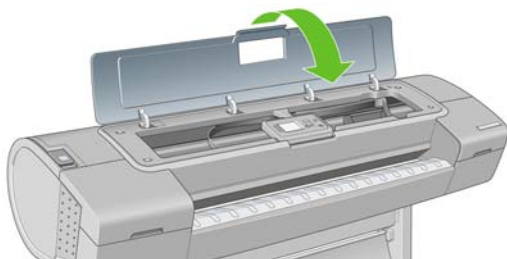

5. The process takes about six minutes. Wait until the front-panel display shows the process complete before using the printer.



NOTE: The printer prints a calibration image. Do not worry about the image. The front-panel display shows any errors in the process.

Image Quality Maintenance menu procedure

1. Load the paper you wish to use, see [Paper handling on page 35](#). You can use a roll or cut sheet, however, it must be A3 landscape or larger (420 by 297 mm).



CAUTION: Do not use transparent or semi-transparent paper to align the printheads.

2. Press the **Menu** key to return to the main menu and select the Image Quality Maintenance menu icon , then **Align printheads**. The printer checks to see if it has enough paper to run the realignment.

3. If the loaded paper is satisfactory, the printer runs the realignment and prints a realignment pattern. Ensure the window is closed, as a strong light source near the printer during printhead realignment can affect alignment.

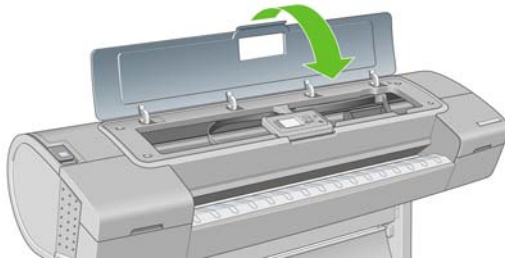

4. The process takes about five minutes. Wait until the front-panel display shows the process complete before using the printer.

Scanning errors during alignment

If the alignment process fails, a Scanning problems message appears on the front panel. This means that the alignment has not completed successfully. Therefore the printer is not aligned and the alignment should be repeated before printing with good image quality. The problem may be due to:

- The paper used was not valid, repeat the alignment with valid paper
- Printhead health problems, clean printheads, see [Clean the printheads on page 179](#)
- The alignment was done with the window open, repeat the alignment with the window closed

If the problem persists after using valid paper, cleaning the printheads, and keeping the window closed, there may be a failure in the scanning system needing reparation or the printheads, although clean, may not work and need to be replaced.

Printhead status messages

These are the possible printhead status messages:

- **OK:** the printhead is working normally, with no known problems
- **Missing:** there is no printhead present, or it is not correctly installed in the printer.
- **Test printhead separately:** you are recommended to test the printheads individually to find the failing printhead. Remove all the printheads and insert them alone one by one, closing the latch and the carriage cover after every insertion. The front-panel display indicates the failing one showing the reset or replace message.
- **Reseat:** you are recommended to remove the printhead and then reinsert it. If that fails, clean the electrical connections, see [The front-panel display recommends reseating or replacing a printhead on page 179](#). If that fails, replace the printhead with a new printhead, see [Remove a printhead on page 124](#) and [Insert a printhead on page 127](#).
- **Replace:** the printhead is failing. Replace the printhead with a working printhead, see [Remove a printhead on page 124](#) and [Insert a printhead on page 127](#).
- **Replacement incomplete:** a printhead replacement process has not completed successfully, re-launch the replacement process and let it finish completely (it is not needed to change the printheads).
- **Remove:** the printhead is not a suitable type for use in printing.

17 Troubleshooting general printer issues

- [The printer does not print](#)
- [The printer seems slow](#)
- [The printer printed on undesirable paper](#)
- [Communication failures between computer and printer](#)
- [Cannot access HP Easy Printer Care \(Windows\) or HP Printer Utility \(Mac OS\)](#)
- [Cannot access the Embedded Web Server](#)
- [Automatic file system check](#)
- [An AutoCAD 2000 memory allocation error](#)
- [No output when printing from Microsoft Visio 2003](#)
- [Unavailable driver features when printing from QuarkXpress](#)
- [Printer alerts](#)

The printer does not print

If all is in order (paper loaded, all ink components installed, and no file errors), there are still reasons why a file you have sent from your computer may not start printing when expected:

- You may have an electrical power problem. If there is no activity at all from the printer, and the front panel does not respond, check that the power cable is connected correctly and that there is power available at the socket.
- You may be experiencing unusual electromagnetic phenomena, such as strong electromagnetic fields or severe electrical disturbances, which can cause the printer to behave strangely or even stop working. In this case, turn off the printer using the **Power** key on the front panel and unplug the power cord, wait until the electromagnetic environment has returned to normal, then turn it on again. If you still experience problems, please contact your customer service representative.
- Nesting may be on and the printer is waiting for the specified nest wait time before calculating the appropriate nests. In this case, the front panel shows the remaining time needed for nesting.
- You may have the wrong graphic language setting, see [Change the graphic language setting on page 32](#).
- You may not have installed in your computer the correct driver for your printer, see the *Assembly instructions*.
- If you are printing on a sheet, you must specify sheet as the paper source in your printer driver.
- The printer may be holding the job for paper or accounting information, see [Job status messages on page 113](#).
- You may have requested a print preview from your printer driver. This is a function you can use to check that the image is the one you want. In this case, the preview is displayed on your screen, and you must click the **Print** button to start printing.
- If you are using Mac OS with a USB connection, you may find that you need to change the data encoding. Select the Setup menu icon , then **Printing preferences > PS > Select encoding > ASCII**. Then configure your application to send ASCII data.

The printer seems slow

Here are some possible explanations.

- Did you set the print-quality to **Best** or **Max Detail**? Best-quality and maximum detail prints take longer.
- Did you specify the correct paper type when loading the paper? Photo and coated papers require more drying time between passes. To find out the printer's current paper type setting, see [View information about the paper on page 54](#). Some paper types require more time for printing.
- Do you have a network connection to your printer? Check that all components used in the network (network interface cards, hubs, routers, switches, cables) are capable of high-speed operation. Is there a lot of traffic from other devices on the network?
- Did you specify **Extended** drying time in the front panel? Try changing the drying time to **Optimal**.

The printer printed on undesirable paper

If the printer prints your job before you were able to load your desired paper, you may have **Any** selected for the Paper Type in the printer driver. When **Any** is selected the printer will print immediately on

whichever paper is loaded. Load your desired paper, see [Paper handling on page 35](#), and select your paper type specifically in the driver.

- **In the Windows driver dialog:** select the Paper/Quality tab, then select your paper type in the Paper Type drop-down list.
- **In the Mac OS Print dialog (T1100):** select the Paper Type/Quality panel, then select your paper type in printer in the Paper Type drop-down list.
- **In the Mac OS PS Print dialog (T1100ps):** select the Image Quality panel, then select your paper type in the Paper Type drop-down list.



NOTE: Any is the driver default.

Communication failures between computer and printer

Some symptoms are:

- The front-panel display does not show the **Receiving** message when you have sent an image to the printer.
- Your computer displays an error message when you are trying to print.
- Your computer or printer hangs (stays idle), while communication is taking place.
- Your printed output shows random or inexplicable errors (misplaced lines, partial graphics etc.)

To solve a communication problem:

- Ensure that you have selected the correct printer in your application, see [Printing on page 59](#).
- Ensure that the printer works correctly when printing from other applications.
- Remember that very large prints may take some time to receive, process, and print.
- If the printer is connected to a network, try using it when connected directly to your computer through a USB cable.
- If your printer is connected to your computer through any other intermediate devices, such as switch boxes, buffer boxes, cable adapters, cable converters, etc., try using it when connected directly to your computer.
- Try another interface cable.
- Ensure that the graphic language setting is correct, see [Change the graphic language setting on page 32](#).
- If the printer is connected with a USB, try to disconnect and reconnect the USB cable with the computer.

Cannot access HP Easy Printer Care (Windows) or HP Printer Utility (Mac OS)

If you have not done so already, please read [Access HP Easy Printer Care \(Windows\) or HP Printer Utility \(Mac OS\) on page 29](#).

1. Press the **Menu** key to return to the main menu and select the Connectivity menu icon .
2. Select **Advanced > Web Services > Printer Utility Software > Enable**.

3. If you have a TCP/IP connection to your printer, press the **Menu** key to return to the main menu and select the Connectivity menu icon  again.
4. Select the type of connection you are using.
5. Select **View Information**.



If you still cannot connect, switch the printer off and back on with the **Power** key on the front panel.

Cannot access the Embedded Web Server

If you have not done so already, please read [Access the Embedded Web Server on page 30](#).



NOTE: If you connect directly to your printer with a USB cable, use HP Easy Printer Care (Windows) or HP Printer Utility (Mac OS).

1. Press the **Menu** key to return to the main menu and select the Connectivity menu icon .
2. Select **Advanced > Allow EWS > On**.
3. If you have a TCP/IP connection to your printer, press the **Menu** key to return to the main menu and select the Connectivity menu icon  again.
4. Select the type of connection you are using.
5. Select **View Information**.
6. Ensure that you see IP enabled. If not, you may need to use a different connection.

If you are using a proxy server, try bypassing the server and accessing the Web server directly.

- In Internet Explorer 6 for Windows, go to **Tools > Internet Options > Connections > LAN Settings**, and check the **Bypass proxy server for local addresses** box. Alternatively, for more precise control, click the **Advanced** button and add the printer's IP address to the list of exceptions, for which the proxy server is not used.
- In Safari for Mac OS, go to **Safari > Preferences > Advanced** and click the **Proxies: Change Settings** button. Add the printer's IP address or its domain name to the list of exceptions, for which the proxy server is not used.

If you still cannot connect, switch the printer off and back on with the **Power** key on the front panel.

Automatic file system check

When you turn on the printer, you will occasionally see a front panel display similar to the one shown below.

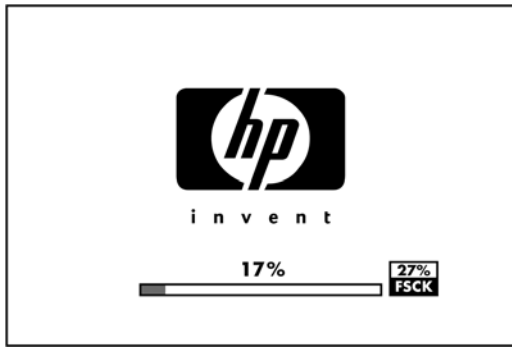

A file system check is taking place; it can take up to 40 minutes. Please wait until it finishes.



CAUTION: If you turn the printer off before the file system check has finished, the file system could be seriously damaged, making the printer's hard disk unusable. In any case, the file system check will restart from the beginning whenever you turn the printer on again.

A file system check is scheduled every 90 days, in order to maintain the hard disk's file system integrity.



NOTE: When the printer is powered back on, it takes about three minutes to initialize and check and prepare the printheads. However, it can take up to 40 under some conditions, for example, when the printer has not been used for a long period of time and requires more time to prepare the printheads.

An AutoCAD 2000 memory allocation error

After installing the printer driver, when you try to print for the first time from AutoCAD 2000, you may see a message saying **Memory allocation error**, after which your image is not printed.

This is due to a problem in AutoCAD 2000, and it can be fixed by downloading the Plotting Update Patch (**plotupdate.exe**) from the Autodesk Web site, <http://www.autodesk.com/>.

This patch is also worth trying if you have any other strange problems when printing from AutoCAD 2000.

No output when printing from Microsoft Visio 2003

For more information about problems when printing large images (more than 129 inches long) from Microsoft Visio 2003, see Microsoft's online knowledge base: <http://support.microsoft.com/search/>.

To avoid these problems, it is possible to scale the image down in Visio to a size shorter than 129 inches and then to scale the drawing up in the driver by using the **Scale to** options in the Effects tab of the Windows driver. If the down-scaling in the application and the up-scaling in the driver match, the result is as originally intended.

Unavailable driver features when printing from QuarkXpress

When you print from QuarkXPress, the following driver features are not available.

- Print Preview
- Rotation
- Scaling

- Microsoft Office features or paper saving options
- Back to front printing

If you are using the HP-GL/2 driver, the following features are not available.

- Print Preview
- Back to front printing

To get the same results, use the equivalent features available in QuarkXPress.

Printer alerts

Your printer can communicate two types of alerts:

- **Errors:** Mainly alerting you to the fact that the printer is unable to print. However, in the driver, errors can also alert you to conditions that could ruin the print, such as clipping, even if the printer is able to print.
- **Warnings:** Alert you when the printer needs attention either for an adjustment, such as a calibration or for a possible unprintable situation, such as a preventive maintenance or low ink.

There are four different alerts communicators within your printer's system.

- **Front-panel display:** The front panel only shows the most relevant alert at a time. It generally requires the user to press the **OK** key for confirmation, but in the case of a warning, it disappears after a timeout. There are permanent alerts, such as "ink cartridge low on ink", that reappear when the printer becomes idle and there is not another more severe alert.



TIP: From the front panel display you can configure paper mismatch alerts, see [Handle paper conflicts on page 22](#).

- **Embedded Web Server:** The upper-right corner of the EWS screen shows the Printer status. If there is an alert in the printer, the status shows the alert text.
- **Driver:** The driver shows alerts. The driver warns about job configuration settings that may produce a problem in the final output. If the printer is not ready to print, it displays a warning.
- **HP Easy Printer Care (Windows) or HP Printer Utility (Mac OS):** To see alerts in these applications, go to the **Overview** tab and review the **Items needing attention** list on the right-hand side.

By default, alerts are only displayed when you are printing and there are printing problems, for example: cartridge low or out of ink or printer out of paper. If alerts are enabled and there is a problem that prevents printing, you see a pop-up window, which explains why the printer is not going to print. Follow the instructions to achieve your required result.



NOTE: There are environments that do not support bidirectional communication, for example: a shared Mac OS computer or a Windows computer connected to the printer with USB. In those cases, alerts do not reach the job owner.

18 Front-panel error messages

Occasionally you may see one of the following messages appear on the front-panel display. If so, please follow the advice in the Recommendation column.

If you see an error message that does not appear here, and you feel in doubt about the correct response, contact HP Support. See [Contact HP Support on page 196](#).

Table 18-1 Text messages

Message	Recommendation
[Color] cartridge has expired	Replace the cartridge. See Handling ink cartridges and printheads on page 119 .
[Color] cartridge is missing	Insert a cartridge of the correct color. See Handling ink cartridges and printheads on page 119 .
[Color] cartridge is out of ink	Replace the cartridge. See Handling ink cartridges and printheads on page 119 .
[Color] printhead #[n] error: not present	Insert the correct printhead. See Handling ink cartridges and printheads on page 119 .
[Color] printhead #[n] error: please remove	Remove the incorrect printhead and insert a new printhead of the correct type (color and number). See Handling ink cartridges and printheads on page 119 .
[Color] printhead #[n] error: replace	Remove the non-functional printhead and insert a new printhead. See Handling ink cartridges and printheads on page 119 .
[Color] printhead #[n] error: reseal	Remove and reinsert the same printhead, or try cleaning the electrical connections. If necessary, insert a new printhead. See The front-panel display recommends reseating or replacing a printhead on page 179 .
[Color] printhead #[n] out of warranty	The printhead's warranty has expired, because of the length of time it has been in operation or because of the volume of ink used.
[Color] printhead #[n] warranty warning	The printhead's warranty may be invalidated by the use of the wrong kind of ink.
IO error	Restart the printer. If the problem persists, contact HP Support. See Contact HP Support on page 196 .
IO warning	Try again; if the problem persists, contact HP Support. See Contact HP Support on page 196 .
Paper advance calibration pending	Perform paper advance calibration. See Recalibrate the paper advance on page 155 .
Paper too small to print paper advance calibration	Unload paper and load larger paper.
Paper too small to scan paper advance calibration	Unload paper and load larger paper.
PDL Error: Ink system not ready	Clean the printheads. See Clean the printheads on page 179 .

Table 18-1 Text messages (continued)

Message	Recommendation
PDL Error: Job clipped	The image is too large for the paper or for the printer. Load larger paper if possible, or reduce the image size.
PDL Error: memory full	Restart the printer and try resending the job; if necessary, reduce the complexity of the job.
PDL Error: out of paper	Load more paper.
PDL Error: parsing error	The print job is unintelligible to the printer. Try to recreate and resend it. Check your cable connections.
PDL Error: print mode error	The paper type or print quality specified for the job are incorrect. Change the loaded paper type or the print settings.
PDL Error: printing error	Try sending the job again.
PDL Error: virtual memory full	Restart the printer and try resending the job; if necessary, reduce the complexity of the job.
Printhead alignment error: paper too small	Unload paper and load larger paper.
Replace [color] cartridge	Replace the cartridge. See Handling ink cartridges and printheads on page 119 .
Reseat [color] cartridge	Remove and reinsert the same cartridge. See Handling ink cartridges and printheads on page 119 .
Update: failed. Invalid file	Make sure that you have selected the correct firmware update file. Then try again to perform the update.

Table 18-2 Numerical error codes

Error code	Recommendation
01.0, 01.1, 01.2	Restart the printer. If the problem persists, contact HP Support. See Contact HP Support on page 196 .
21, 21.1, 22.0, 22.1, 22.2, 22.3, 24	Restart the printer. If the problem persists, contact HP Support. See Contact HP Support on page 196 .
52:01	The printer needs internal cleaning. See Clean the printhead drop detector on page 180 . If the problem persists, contact HP Support. See Contact HP Support on page 196 .
61:01	The file format is wrong and the printer cannot process the job. Check the graphic language setting of your printer (see Change the graphic language setting on page 32). If you are sending PostScript from Mac OS over a USB connection, select ASCII encoding in both the driver and the application. Check for the latest firmware and driver releases.
62, 63, 64, 65, 67	Update your printer's firmware. See Update the firmware on page 138 .
74.1	Try the firmware update again. Do not try to use your computer while the update is in progress. If the problem persists, contact HP Support. See Contact HP Support on page 196 .
79	Restart the printer. If the problem persists, contact HP Support. See Contact HP Support on page 196 .
94, 94.1	Restart color calibration. See Color calibration on page 74 .

19 HP Customer Care

- [Introduction](#)
- [HP Professional Services](#)
- [HP Instant Support](#)
- [HP Proactive Support](#)
- [Contact HP Support](#)

Introduction

HP Customer Care offers award-winning support to ensure you get the most from your HP Designjet, providing comprehensive, proven support expertise and new technologies to give you unique end-to-end support. Services include setup and installation, troubleshooting tools, warranty upgrades, repair and exchange services, phone and Web support, software updates, and self-maintenance services. To find out more about HP Customer Care, please visit us at:

<http://www.hp.com/go/designjet/>

or call us on the telephone (see [Contact HP Support on page 196](#)).

HP Professional Services

Knowledge Center

Enjoy a world of dedicated services and resources to ensure you always get the best performance from your HP Designjet products and solutions.

Join the HP community at the Knowledge Center, your large-format printing community at http://www.hp.com/go/knowledge_center/djt1100/ for 24×7 access to:

- Multimedia tutorials
- Step-by-step how-to guides
- Downloads — the latest printer firmware, drivers, software, paper profiles, etc.
- Technical support — online troubleshooting, customer care contacts, and more
- Workflows and detailed advice for completing various printing tasks from particular software applications
- Forums for direct contact with the experts, both HP and your colleagues
- Warranty tracking online, for your peace of mind
- Latest product information — printers, supplies, accessories, software, etc.
- Supplies Center for all you need to know about ink and paper

By customizing your registration for the products you have purchased and your type of business, and by setting your communication preferences, you decide the information you need.

HP Start-Up Kit

The HP Start-Up Kit is the DVD that comes with your printer; it contains the printer's software and documentation, including introductory multimedia tutorials to help you to get a good first print.

HP Care Packs and Warranty Extensions

HP Care Packs and Warranty Extensions allow you to extend your printer's warranty beyond the standard period.

They include remote support. On-site service is also provided if necessary, with two alternative response-time options.

- Next business day
- Same business day, within four hours (may not be available in all countries)

For more information on HP Care Packs, please visit <http://www.hp.com/go/lookuptool/>.

HP Installation

The HP Installation service unpacks, sets up, and connects the printer for you.

This is one of the HP Care Pack services; for more information, please visit <http://www.hp.com/go/lookuptool/>.

HP Instant Support

HP Instant Support Professional Edition is HP's suite of troubleshooting tools that collect diagnostic information from your printer and match it with intelligent solutions from HP's knowledge bases, allowing you to resolve problems as quickly as possible.

You can start an HP Instant Support session by clicking on the link provided by your printer's Embedded Web Server. See [Access the Embedded Web Server on page 30](#).

To be able to use HP Instant Support:

- You must have a TCP/IP connection to your printer, because HP Instant Support is accessible only through the Embedded Web Server.
- You must have access to the World Wide Web, because HP Instant Support is a Web-based service.

HP Instant Support is currently available in English, Korean, Simplified Chinese, and Traditional Chinese.

You can find more information about HP Instant Support at <http://www.hp.com/go/ispe/>.

HP Proactive Support

HP Proactive Support helps reduce costly printer downtime by preemptively identifying, diagnosing, and resolving printer issues before they become problems for you. HP's Proactive Support tool is designed to help businesses of all sizes reduce support costs and maximize productivity—all with the click of a mouse.

A component of the HP Imaging and Printing suite of services, Proactive Support helps you gain control of your printing environment—with a clear focus on maximizing the value of your investment, increasing printer uptime, and reducing printer management costs.

HP recommends that you enable Proactive Support right away to save you time and prevent problems before they occur, reducing costly downtime. Proactive Support runs diagnostics and checks for software and firmware updates.

You can enable Proactive Support in HP Easy Printer Care for Windows or HP Printer Monitor for Mac OS, where you can specify the frequency of connections between your computer and HP's Web server, and the frequency of diagnostic checks. You can also choose to run the diagnostic checks at any time. To change these settings:

- In HP Easy Printer Care for Windows, select the **Tools** menu, then **HP Proactive Support**.
- In HP Printer Monitor for Mac OS, select **Preferences**, then **HP Proactive Support**.

If Proactive Support finds any potential problem, it notifies you with an alert, which will explain the problem and recommend a solution. In some cases, the solution may be applied automatically; in other cases, you may be asked to perform some procedure to solve the problem.

Contact HP Support

HP Support is available to you by telephone. What to do before you call:

- Review the troubleshooting suggestions in this guide.
- Review the relevant driver documentation.
- If you have installed third-party software drivers and RIPs, see their documentation.
- If you call one of the Hewlett-Packard offices, please have the following information available to help us answer your questions more quickly:
 - The printer you are using (the product number and the serial number, found on the label at the back of the printer)
 - If there is an error code on the front panel, note it down; see [Front-panel error messages on page 191](#)
 - The printer's Service ID: at the front panel, select the Information menu icon , then **View printer information**
 - The computer you are using
 - Any special equipment or software you are using (for example, spoolers, networks, switch-boxes, modems, or special software drivers)
 - The cable you are using (by part number) and where you purchased it
 - The type of interface used on your printer (USB or network)
 - The software name and version you are currently using
 - If possible, print out the following reports; you may be asked to fax them to the support center helping you: Configuration, Usage Report, and "all pages above" from Service Information (see [The printer's internal prints on page 8](#))

Telephone numbers

An up-to-date list of HP Support telephone numbers is available on the Web: please visit http://welcome.hp.com/country/us/en/wwcontact_us.html. If you have no access to the Web, try one of the numbers below.

- Algeria: 213 17 63 80
- Argentina: 0 800 777 HP INVENT, local 5411 4778 8380
- Australia: 13 10 47
- Austria: 0810 00 10 00
- Bahrain: 800 171
- Belgium: (0) 78 600 600
- Bolivia: 0 800 1110, local 54 11 4708 1600
- Brazil: 0800 157 751, local 55 11 3747 7799
- Canada: 1 800 HP INVENT
- Caribbean: 1 800 711 2884

- Central America: 1 800 711 2884
- Chile: 800 HP INVENT, 123 800 360 999
- China: 800 810 59 59, 10 6564 59 59
- Colombia: 01 8000 51 HP INVENT, local 571 606 9191
- Czech Republic: 420 261 307 310
- Denmark: 70 11 77 00
- Ecuador: 999 119, 1 800 225 528
- Egypt: 202 532 5222
- Finland: 0203 53232
- France: 08 26 10 49 49
- Germany: 0180 52 58 143
- Greece: 210 6073603, 801 11 22 55 47
- Guadeloupe: 0800 99 00 11, 877 219 8791
- Guatemala: 1 800 999 5105, 1 800 711 2884
- Hong Kong: 852 3002 8555
- Hungary: 06 1 382 1111
- India: 1 600 112 267
- Indonesia: 350 3408
- Ireland: 1 890 946500
- Israel: 09 830 4848
- Italy: 02 3859 1212
- Jamaica: 0 800 711 2884
- Japan: software 0120 014121, hardware 0120 742594
- Korea: 82 1588 3003
- Luxembourg: 27 303 303
- Malaysia: 1 800 80 5405
- Martinique: 0 800 99 00, 877 219 8671
- Mexico: 01 800 472 6684, local 5258 9922
- Middle East: 4 366 2020
- Morocco: 2240 4747
- Netherlands: 0900 1170 000
- New Zealand: 09 365 9805
- Norway: 800 62 800
- Paraguay: 00 811 800, 800 711 2884

- Panama: 001 800 711 2884
- Peru: 0 800 10111
- Philippines: 632 888 6100
- Poland: 22 566 6000
- Portugal: 213 164 164
- Puerto Rico: 1 800 652 6672
- RSA: 27 11 258 9301, local 086 000 1030
- Romania: 40 21 315 4442
- Russia: 095 797 3520, 812 3467 997
- Saudi Arabia: 6272 5300
- Slovakia: 2 50222444
- South Africa: 0800 001 030
- Spain: 902 010 333
- Sweden: 077 130 30 00
- Switzerland: 0848 80 20 20
- Taiwan: 886 2 872 28000
- Thailand: 0 2353 9000
- Tunisia: 71 89 12 22
- Turkey: 216 444 71 71
- UAE: 800 4520, 04 366 2020
- Ukraine: 44 4903520
- United Kingdom: 0870 842 2339
- United States: 1 800 HP INVENT
- Uruguay: 54 11 4708 1600
- Venezuela: 0 800 HP INVENT, local 58 212 278 8000
- Vietnam: 84 8 823 45 30
- West Africa (French): 351 213 17 63 80

20 Printer specifications

- [Functional specifications](#)
- [Physical specifications](#)
- [Memory specifications](#)
- [Power specifications](#)
- [Ecological specifications](#)
- [Environmental specifications](#)
- [Acoustic specifications](#)

Functional specifications

Table 20-1 HP 72 ink supplies

Printheads	Two inks in each printhead: gray and photo black, matte black and yellow, and magenta and cyan
Ink cartridges	Cartridges containing 69 ml of ink: gray, photo black, yellow, magenta, and cyan Cartridges containing 130 ml of ink: gray, photo black, matte black, yellow, magenta, and cyan

Table 20-2 Paper sizes

	Minimum	Maximum
Roll Width	18 inches (460 mm)	24-inch printer: 24 inches (609 mm) 44-inch printer: 44 inches (1118 mm)
Roll Length		300 feet (91.4 m)
Sheet Width	8.3 inches (210 mm, A4 Portrait)	24-inch printer: 24 inches (609 mm) 44-inch printer: 44 inches (1118 mm)
Sheet Length	11 inches (279 mm, Letter Portrait)	24-inch printer: 36 inches (915 mm) 44-inch printer: 66 inches (1676.4 mm)

Table 20-3 Printing resolutions

Print-quality	Maximum detail	Rendering Resolution (dpi)	Printing Resolution (dpi)
Best	On	1200 × 1200	2400 × 1200 (glossy paper only)*
	On	1200 × 1200	1200 × 1200
	Off	600 × 600	600 × 600
	Off	600 × 600	600 × 600
Normal	On	600 × 600	600 × 600
	Off	600 × 600	600 × 600
	Off	300 × 300	300 × 300
Fast	On	600 × 600	600 × 600
	Off	600 × 600	600 × 600
	Off	300 × 300	300 × 300

*For a list of supported glossy paper, see [Order paper on page 142](#).

Table 20-4 Margins

Top right and left margins	5 mm = 0.2 inches
Bottom margin (trailing edge)	5 mm = 0.2 inches (roll) 17 mm = 0.67 inches (sheet)

Table 20-5 Mechanical accuracy

±0.1% of the specified vector length or ±0.1 mm (whichever is greater) at 23°C (73°F), 50-60% relative humidity, on E/A0 printing material in Best or Normal mode with HP Matte Film roll feed.

Table 20-6 Graphic languages supported

HP PCL3 GUI, HP GL/2 RTL, CALS/G4, PDF (HP Designjet T1100ps only), PostScript (HP Designjet T1100ps only), TIFF (HP Designjet T1100ps only), JPEG (HP Designjet T1100ps only)

Physical specifications

Table 20-7 Printer physical specifications

	24-inch printer	24-inch printer (without stand)	44-inch printer
Weight	143 lb (65 kg)	103.6 lb (47 kg)	189 lb (86 kg)
Width	49.7 inches (1262 mm)	49.7 inches (1262 mm)	69.7 inches (1770 mm)
Depth	Minimum: 26 inches (661 mm) Maximum: 28.8 inches (732 mm)	Minimum: 26 inches (661 mm) Maximum: 28.8 inches (732 mm)	Minimum: 26 inches (661 mm) Maximum: 28.8 inches (732 mm)
Height	41.2 inches (1047 mm)	15.4 inches (391 mm)	41.2 inches (1047 mm)

Memory specifications

Table 20-8 Memory specifications

HP Designjet T1100 Memory (DRAM) supplied	128 MB
HP Designjet T1100ps Memory (DRAM) supplied	256 MB
Hard disk	40 GB

Power specifications

Table 20-9 Printer power specifications

Source	100–240 V ac ±10%, auto-ranging
Frequency	50–60 Hz
Current	< 2 A
Consumption	< 200 W

Ecological specifications

This product complies with European Union WEEE and RoHS Directives, and is compliant with the United States EPA's ENERGY STAR program.

For the up-to-date ecological specifications of your printer, please go to <http://www.hp.com/> and search for “ecological specifications”.

Environmental specifications

Table 20-10 Printer environmental specifications

	Temperature range	Humidity range
Operating for optimal print-quality	22°C to 26°C (72°F to 79°F)	30% to 60%
Operating for standard printing	15°C to 35°C (59°F to 95°F)	20% to 80%
Printer without consumables	5°C to 40°C (41°F to 104°F)	
Non-operating packed consumables and printer:	-40°C to 60°C (-40°F to 140°F)	

Acoustic specifications

Printer acoustic specifications (declared according to ISO 9296).

Table 20-11 Printer acoustic specifications

Idle sound power level	4.4 B (A)
Operating sound power level	6.5 B (A)
Idle sound pressure at bystander	44 dB (A)
Operating sound pressure at bystander	29 dB (A)

Glossary

AppleTalk A suite of protocols that Apple Computer developed in 1984 for computer networking. Apple now recommends TCP/IP networking instead.

Bonjour Apple Computer's trade name for its implementation of the IETF Zeroconf specification framework, a computer network technology used in Apple's Mac OS X from version 10.2 onwards. It is used to discover services available on a local area network. It was originally known as Rendezvous.

Color accuracy The ability to print colors that match the original image as closely as possible, bearing in mind that all devices have a limited color gamut and may not be physically capable of matching certain colors precisely.

Color consistency The ability to print the same colors from a particular print job from print to print and from printer to printer.

Color model A system of representing colors by numbers, such as RGB or CMYK.

Color space A color model in which each color is represented by a specific set of numbers. Many different color spaces can use the same color model: for instance, monitors generally use the RGB color model, but they have different color spaces, because a particular set of RGB numbers results in different colors on different monitors.

Cutter A printer component that slides back and forth across the platen to cut the paper.

ESD ElectroStatic Discharge. Static electricity is common in daily life. It is the spark when touching the car door, or the cling of clothing. Although controlled static electricity has some useful applications, uncontrolled electrostatic discharges are one of the main hazards to the electronics products. Therefore, to prevent damage some precautions are needed when setting up the product, or handling ESD sensitive devices. This type of damage may reduce the life expectancy of the device. One way to minimize uncontrolled ESDs, and therefore reduce this type of damage is by touching any exposed grounded part of the product (mainly metal parts) before handling ESD sensitive devices (such as the printheads or ink cartridges). Additionally, to reduce the generation of electrostatic charge in your body try to avoid working in a carpeted area, and keep your body movements to a minimum when handling ESD sensitive devices. Also, avoid working in low humidity environments.

Ethernet A popular computer networking technology for local area networks.

Firmware Software that controls your printer's functionality and is stored semi-permanently in the printer (it can be updated).

Gamut The range of colors and density values reproducible on an output device, such as a printer or monitor.

HP-GL/2 Hewlett-Packard Graphics Language 2: a language defined by HP to describe vector graphics.

I/O Input/Output: this term describes the passing of data between one device and another.

ICC The International Color Consortium, a group of companies that have agreed on a common standard for color profiles.

Ink cartridge A removable printer component that stores ink of a particular color and provides it to the printhead.

IP address A unique identifier that identifies a particular node on a TCP/IP network. It consists of four integers separated by dots.

Jetdirect HP's brand name for its series of print servers that allow a printer to be connected directly to a local area network.

LED Light-Emitting Diode: a semiconductor device that emits light when electrically stimulated.

MAC address Media Access Control address: a unique identifier used to identify a particular device on a network. It is a lower-level identifier than the IP address. Thus, a device may have both a MAC address and an IP address.

Nozzle One of many tiny holes in a printhead through which ink is deposited onto the paper.

Paper A thin, flat material made to be written or printed on; most commonly made from fibers of some kind which are pulped, dried, and pressed.

Platen The flat surface within the printer over which the paper passes while it is being printed on.

Printer driver Software that converts a print job in a generalized format into data suitable for a particular printer.

Printhead A removable printer component that takes ink of one or more colors from the corresponding ink cartridge(s) and deposits it on the paper, through a cluster of nozzles. In the HP Designjet T1100 series, each printhead prints two different colors.

Rendezvous Apple Computer's original name for its networking software later known as Bonjour.

Spindle A rod that supports a roll of paper while it is being used for printing.

TCP/IP Transmission Control Protocol/Internet Protocol: the communications protocols on which the Internet is based.

USB Universal Serial Bus: a standard serial bus designed to connect devices to computers.

Index

A

- accessories
 - order 145
- account ID
 - requiring 25
- accounting 116
- acoustic specifications 202
- administrator's password 24
- alerts
 - errors 190
 - turn on and off 24
 - warnings 190

B

- banding problems 155
- basket
 - output problems 154
- black and white 67
- black point compensation 81
- blurred lines 165
- buzzer on/off 31

C

- calibration
 - color 74
- cannot load paper 148
- clean the platen 168
- clean the printer 132
- clipped at bottom 171
- clipped image 171
- color
 - adjustment options 77
 - advantages 74
 - calibration 74
 - CMYK 74
 - emulation 79
 - fading 171
 - inaccurate 170
 - printer emulation 76
 - profile 74
 - RGB 74
- color management
 - from drivers 75

- from EWS 80
- from front panel 82
- from PS drivers 78
- options 76
- process 74

- components of printer 4
- computer communication
 - printer/computer
 - communications issues 187
- configure 31
- connect the printer
 - choose a method 12
 - Mac OS direct 18
 - Mac OS network 14
 - Windows direct 13
 - Windows network 12
- contrast in front panel 31
- core adaptors 37, 40
- crop lines 68
- Customer Care 194
- cutter
 - on/off 56
- cutter, replace 132

D

- disk erase, secure 139
- draft for revision, print 86
- draft printing 66
- driver features
 - QuarkXpress 189
- driver preferences 25
- drying time
 - change 56

E

- ecological specifications 201
- economize
 - on ink 70
 - on paper 69
- Embedded Web Server
 - access 30
 - cannot access 188
 - ink and paper usage 116

- job queue 110
- job queue; job preview 110
- language 30
- printer usage statistics 116

- environmental specifications 202
- erase hard disk securely 139
- error messages, front panel 191

F

- fading colors 171
- features of printer 4
- file system check 188
- firmware update 138
- front panel
 - contrast 31
 - language 29
 - units 31
- front panel option
 - adjust paper advance 156
 - align printheads 183
 - allow EWS 188
 - black point compensation 83
 - calibrate color 75
 - calibrate paper advance 156
 - clean printheads 179
 - CMYK source profile 83
 - color/grayscale 82
 - emulate printer 82
 - enable buzzer 31
 - enable crop lines 68
 - enable cutter 56
 - enable economode 66
 - enable maximum detail 67
 - enable merge 65
 - form feed and cut 7, 44, 45, 48, 49, 56, 57, 154, 155
 - ink cartridge information 120
 - internal prints 8
 - load roll 44, 48
 - load sheet 52
 - modify configuration 32
 - PANTONE emulation 83
 - print diagnostic image 172

- print quality 61
- printer utility software 187
- printhead information 124, 162, 166
- rendering intent 83
- replace ink cartridges 121
- replace printheads 125
- reprint 112
- reset cutter life counters 132
- reset paper advance 157
- resize 64
- RGB source profile 82
- select display contrast 31
- select drying time 56
- select graphics language 33
- select I/O timeout 171
- select language 29
- select paper size 62
- select paper type 150, 151
- select units 31
- select wait time 70
- sleep mode wait time 31
- unload paper 7, 49, 53, 54
- view configuration 14
- view connectivity information 188
- view ink levels 7, 132
- view loaded paper 7, 54, 132, 156, 160, 161, 162, 165, 166, 167, 168, 170, 172
- view printer information 196
- functional specifications 200

G

- graininess 166
- graphic languages 201
- gray shades 67

H

- hard disk specification 201
- HP Care Packs 194
- HP Customer Care 194
- HP Installation 195
- HP Instant Support 195
- HP Proactive Support 195
- HP Start-Up Kit 194
- HP Start-Up Kit CD/DVD 2
- HP Support 196
- HP-GL/2 32

I

- image diagnostics print 172

- image problems
 - clipped at bottom 171
 - clipped image 171
 - missing objects 172
 - PDF problems 172
 - Visio 2003 189

ink

- economical use of 70
- usage 116

ink cartridge

- about 120
- cannot insert 178
- insert 122
- maintenance 137
- order 142
- remove 121
- specification 200
- status 120

- Instant Support 195

- internal prints 8

J

- Jetdirect print server 146

job

- create 60
- submit 60

job queue

- Embedded Web Server 110
- job preview; Embedded Web Server 110

- job status 113

K

- Knowledge Center 194

L

- language 29
- line length accuracy 165
- line thickness 162
- load paper
 - cannot load 148
 - general advice 36
 - paper not in driver 150
 - roll cannot load 148
 - roll cannot load 24-inch 148
 - roll cannot load 44-inch 149
 - roll into 24-inch printer 41
 - roll into 24-inch printer easy load 41
 - roll into 24-inch printer with paper menu 44
 - roll into 44-inch printer 45
 - roll into 44-inch printer easy load 45

- roll into 44-inch printer with paper menu 48
- roll onto 24-inch spindle 36
- roll onto 44-inch spindle 38
- sheet 50
- sheet cannot load 149
- sheet easy load 51
- sheet paper menu load 52
- loading paper problems 148

M

- maintenance kits 138

margins

- none 67
- specification 200

- mechanical accuracy 201

- memory error (AutoCAD) 189

- memory specifications 201

Microsoft Office

- print from 103

- misaligned colors 163

- move the printer 137

N

nesting

- turn on and off 22

- Network settings 31

O

order

- accessories 145
- ink cartridges 142
- paper 142
- printheads 142
- overlapping lines 65

P

- page size 61

- PANTONE emulation 78

- PANTONE swatch book 81

paper

- advance 56
- calibrate the paper
 - advance 155
- cannot load 148
- download profiles 55
- economical use of 69
- feed and cut 56
- jammed 152
- loading error messages 149
- maintenance 55
- not flat 166
- output problems in basket 154
- paper not in driver 150

- print on loaded paper 55, 186
 - printed on wrong paper 186
 - profiles 55
 - select type 55
 - size 61
 - sizes (max and min) 200
 - usage 116
 - view information 54
 - paper conflicts, handle 22
 - paper not in driver 150
 - paper types 142
 - password
 - administrator's 24
 - security 24
 - PDF clipped 172
 - PDF missing objects 172
 - physical specifications 201
 - platen cleaning 168
 - power
 - on/off 28
 - power specifications 201
 - preferences, Windows driver 25
 - presentation, print 96
 - preview a print 65
 - print file 60
 - print job
 - create 60
 - ink usage 116
 - nesting 69
 - paper usage 116
 - submit 60
 - print preview 65
 - print quality
 - select 61
 - print with shortcuts 63
 - print-quality problems
 - banding 161
 - black ink comes off 168
 - blurred lines 165
 - bottom of print 169
 - discontinuous lines 164
 - edges darker than
 - expected 169
 - edges stepped or not
 - sharp 168
 - general 160
 - graininess 166
 - horizontal lines 161
 - inaccurate line lengths 165
 - ink marks 167
 - line thickness 162
 - misaligned colors 163
 - paper not flat 166
 - scratching 167
 - scuffing 167
 - stepped lines 162
 - vertical lines of different
 - colors 169
 - white spots 169
 - wizard 160
 - printer does not print 186
 - printer software
 - Mac OS uninstall 19
 - Windows uninstall 14
 - printer stand 146
 - printer status 132
 - Printer Utility
 - access 29
 - cannot access 187
 - language 30
 - printer's main components 4
 - printer's main features 4
 - printhead
 - about 123
 - align 182
 - cannot insert 178
 - clean; purge 179
 - insert 127
 - order 142
 - remove 124
 - replace, reseal 179
 - specification 200
 - status 124
 - printhead cleaner
 - specification 200
 - printhead drop detector
 - clean 180
 - printing resolutions 200
 - Proactive Support 195
 - project, print 88
- Q**
- quality, high 66
 - QuarkXpress, unavailable driver
 - features 189
- R**
- rendering intent 81
 - reprint a job 112
 - rescale a print 64
 - roll paper
 - 24-inch load 41
 - 24-inch spindle load 36
 - 44-inch load 45
 - 44-inch spindle load 38
 - unload 49
- S**
- safety precautions 2
 - scale a print 64
 - scratched prints 167
 - scuffed prints 167
 - secure disk erase 139
 - security password 24
 - sheet paper
 - load 50
 - unload 53
 - shortcuts 63
 - sleep mode wait time 31
 - slow printing 186
 - software 8
 - software update 138
 - specifications
 - acoustic 202
 - ecological 201
 - environmental 202
 - functional 200
 - graphic languages 201
 - hard disk 201
 - ink supplies 200
 - margins 200
 - mechanical accuracy 201
 - memory 201
 - paper size 200
 - physical 201
 - power 201
 - printing resolutions 200
 - spindle
 - 24-inch roll load 36
 - 44-inch roll load 38
 - stand 146
 - statistics
 - ink cartridge 120
 - printer usage 116
 - status 113
 - stepped lines 162
 - store the printer 137
 - submit job 60
 - support services
 - HP Care Packs 194
 - HP Customer Care 194
 - HP Instant Support 195
 - HP Proactive Support 195
 - HP Start-Up Kit 194
 - HP Support 196
 - Knowledge Center 194
 - printer installation 195
 - warranty extensions 194
- T**
- telephone numbers 196

U

- unload paper
 - roll 49
 - roll out of paper 50
 - roll with paper 49
 - sheet 53
 - sheet with paper menu 54
 - sheet with Unload paper key 54
- usage information
 - turn on and off 23
- using this guide 2

V

- Visio 2003, no output 189

W

- warranty extensions 194

Free Manuals Download Website

<http://myh66.com>

<http://usermanuals.us>

<http://www.somanuals.com>

<http://www.4manuals.cc>

<http://www.manual-lib.com>

<http://www.404manual.com>

<http://www.luxmanual.com>

<http://aubethermostatmanual.com>

Golf course search by state

<http://golfingnear.com>

Email search by domain

<http://emailbydomain.com>

Auto manuals search

<http://auto.somanuals.com>

TV manuals search

<http://tv.somanuals.com>