



V8.5 Thermal Plotter

User Guide



COPYRIGHT NOTICE

This document is copyrighted by The Imaging Systems Group Inc., 2000. No part of this publication may be reproduced, transmitted, transcribed, or stored in a retrieval system of any kind without prior written permission of The Imaging Systems Group Inc.

TRADEMARKS

Centronics is a U.S. registered trademark of Centronics Data Computer Corporation.

Versatec is a registered trademark of Versatec Corporation.

DISCLAIMER

The Imaging Systems Group Inc. makes no warranties as to the accuracy, validity or fitness for use of the contents of this manual. The Imaging Systems Group Inc. reserves the right to revise the information in this manual at any time without notice.

HAFTUNGSAUSSCHLUSS

Imaging Systems Group Inc. übernimmt keinerlei Garantie hinsichtlich der Genauigkeit, Gültigkeit und Anwendbarkeit dieses Handbuches. Imaging Systems Group Inc. behält sich das Recht vor, die in diesem Handbuch enthaltenen Informationen jederzeit ohne vorherige Ankündigung zu ändern.

ATTENTION: The V8.5e plotter generates, uses and can radiate radio frequency energy and, if not installed and used in accordance with the instruction manual, may cause interference to radio communications. It has been designed to comply with the requirements for Class A computing devices pursuant to Sub-part J of Part 15 of FCC Rules, which are designed to provide reasonable protection against such interference when operated in a commercial environment. Operation of this equipment in a residential area is likely to cause interference in which case, the user, at his own expense, will be required to take whatever measures may be required to correct the interference.

ACHTUNG: Der V8.5e Plotter erzeugt, verwendet und verbreitet Hochfrequenzenergie und kann daher, im Falle, dass er nicht gemäß dem Benutzerhandbuch installiert und benutzt wird, zu Störungen im Hochfrequenz Kommunikationsverkehr führen. Er wurde gemäß den Anforderungen für Rechnergeräte der Klasse A konstruiert und erfüllt Unterabsatz J des Teils 15 der FCC Vorschriften, die dazu gedacht sind, einen angemessenen Schutz bei Einsatz dieser Geräte in einer gewerblichen Umgebung zu sichern. Ein Einsatz dieser Geräte in Wohngebieten wird wahrscheinlich Störungen verursachen, im welchem Falle der Benutzer auf eigene Kosten die notwendigen Maßnahmen ergreifen muß, die erforderlich sind, um solche Störungen zu vermeiden.

Caution! – must be observed to avoid loss or damage to your equipment.

Important: - must be observed to avoid operational impairment.

Do not proceed past any of the above notices, until you have fully understood the implications.

Electromagnetic Compatibility (EMC) USA – This equipment generates and radiates radio frequency energy and if not installed and used in accordance with the instruction manual, may cause interference to radio communications. It has been tested and found to comply with the limits for a Class A computing device pursuant to Subpart B of Part 15 of FCC rules, which are designed to provide reasonable protection against such interference when operated in a commercial environment. Operation of this equipment in a residential area is likely to cause interference in which case the user at his own expense will be required to take whatever measures may be required to correct the interference. Shielded cables should be used with this unit to ensure compliance with the Class A limits.

Europe – This digital equipment fulfils the requirements for radiation emission according to limit B of EN55022/A1 May 1998, and the requirements for immunity according to EN55024 1998 residential, commercial, and light industry (Compliance is not valid for unshielded network and printer cables).

Vorsicht! – Muss befolgt werden, um Totalverlust oder Beschädigung des Gerätes zu vermeiden.

Wichtig: - Muss befolgt werden, um Beeinträchtigungen beim Betrieb zu vermeiden.

Bitte verfahren Sie erst dann weiter, wenn Sie die Bedeutung der vorstehenden Hinweise vollständig verstanden haben.

Elektromagnetische Kompatibilität (EMC) USA – Dieses Gerät erzeugt und verbreitet Hochfrequenzenergie und kann daher, sofern es nicht gemäß dem Benutzerhandbuch installiert und benutzt wird, zu Störungen im Hochfrequenz-Kommunikationsverkehr führen. Es wurde gemäß den Einschränkungen für Rechnergeräte der Klasse A konstruiert und erfüllt Unterabsatz J des Teils 15 der FCC Vorschriften, die dazu gedacht sind, einen angemessenen Schutz bei Einsatz dieser Geräte in einer gewerblichen Umgebung zu sichern. Ein Einsatz dieser Geräte in Wohngebieten wird wahrscheinlich Störungen verursachen, im welchem Falle der Benutzer auf eigene Kosten die notwendigen Maßnahmen ergreifen muss, die erforderlich sind, um solche Störungen zu beheben. Um die Einhaltung der Klasse-A-Einschränkungen zu gewährleisten, sollte das Gerät mit geschirmten Kabeln verwendet werden.

Europa – Dieses digitale Gerät entspricht den Anforderungen für Strahlungsemissionen gemäß EN55022/A1 Klasse B vom Mai 1998, sowie die Anforderungen für Störsicherheit gemäß EN55024 1998 für den häuslichen, gewerblichen und leichtindustriellen Gebrauch (Konformität gilt nicht für ungeschirmte Netz- und Drucker-kabel).

LIMITATION OF LIABILITY

The Imaging Systems Group's total liability to the purchaser, or to any third party, for damages from any and all causes whatsoever, regardless of the form of action, whether in contract or in tort, including negligence, and any infringement of proprietary rights or any misappropriation or unlawful use of any proprietary rights or property of any third party shall, in the aggregate, be limited to purchase price actually paid by the purchaser for the product relating to the damages. The limitation of liability provisions of this agreement reflect an informed voluntary allocation of the risks (known and unknown) that may exist in connection with the provisions of the goods and services provided hereunder by The Imaging Systems Group Inc., and that such voluntary risk allocation represents a fundamental part of the agreement reached between The Imaging Systems Group Inc. and the purchaser.

The Imaging Systems Group Inc. shall not be liable for any special, direct or indirect, incidental, consequential, exemplary, punitive or any similar or other damages of any nature suffered by the purchaser whatsoever including, without limitation, loss of use or lack of availability of the purchaser facilities, including its computer resources and any stored data, loss of profits or revenue, or other commercial loss, or any claim for contribution or indemnity in respect of any claims against the purchaser, regardless of whether The Imaging Systems Group Inc. has been advised of the possibility of such damages.

The Imaging Systems Group Inc.
911 28th Street N.E.
Calgary, Alberta T2A-7X1
Canada
Phone 1-866-415-4797
Fax: (403) 204-1971
e-mail: josh_wood@isys-group.com
<http://www.isys-group.com>

Contents

1.	INTRODUCTION	1-1
1.1	GENERAL DESCRIPTION	1-1
1.2	MEDIA DESCRIPTION	1-1
1.3	ABOUT THIS MANUAL	1-2
2.	SPECIFICATIONS	2-1
2.1	FUNCTIONAL	2-1
	Operation	2-1
	Media	2-3
	Thermal printhead	2-3
	Transport	2-4
2.2	ELECTRICAL	2-4
	Interface	2-4
	Power consumption	2-4
	Power requirements	2-4
2.3	PHYSICAL	2-5
	Dimensions	2-5
	Weight	2-5
2.4	ENVIRONMENTAL	2-5
	Temperature	2-5
	Other	2-5
3.	INSTALLATION	3-1
3.1	UNPACKING	3-1
3.2	MOUNTING AND POSITIONING	3-2
3.3	INTERFACE SETUP	3-3
3.4	MEDIA INSTALLATION	3-3
	Installing rolled paper	3-4
	Installing fan-fold paper	3-8
	Installing and using film	3-8
	Installing rolled film	3-9

4.	OPERATION	4-1
4.1	POWER SUPPLY PRECAUTIONS	4-1
4.2	USING THE CONTROL PANEL	4-2
4.3	CONTROL PANEL FUNCTIONS AND SETTINGS	4-5
	Changing function settings	4-5
	Default Settings	4-6
	Test plot	4-6
	Contrast	4-6
	Speed	4-7
	Media	4-8
	Scaling	4-9
	Emulation (vertical resolution)	4-10
	Form feed length	4-10
	Bytes per scan	4-12
	Grayscale media table number	4-13
	Setup headers for programming the V8.5e	4-13
4.4	ERROR MESSAGES	4-16
5.	THEORY OF OPERATION	5-1
5.1	INTRODUCTION	5-1
5.2	PLOTTER FUNCTIONS AND FEATURES	5-1
	Power supplies	5-1
	Stepper motor	5-3
5.3	INTERFACE	5-3
	Interface timing and signals	5-3
	Data rates	5-6
	Scan width	5-7
	Vertical resolution	5-7
	Scaling	5-7
	Print mode	5-8
5.4	THERMAL PRINTHEAD	5-9
	Automatic Head Temperature Feedback	5-9
	Film media	5-10

5.5	MEDIA SENSORS	5-10
6.	MAINTENANCE	6-1
6.1	MAINTENANCE GUIDELINES	6-2
6.2	REGULAR MAINTENANCE	6-3
	Cleaning the thermal printhead	6-4
	Cleaning the platen roller	6-5
	Replacing the fuse	6-6
7.	TROUBLESHOOTING	7-1
7.1	INTRODUCTION	7-1
7.2	PROBLEMS	7-2
	Plotter does not plot	7-2
	Plot has vertical white stripes	7-3
	Plot is blotchy or faded	7-4
	Plot contrast is weak	7-5
	Plot has black vertical lines	7-6
	Plot is wrong length	7-7
	Paper is wrinkling or tearing along one edge	7-7
	Plotter has no power	7-8
	Plotter display is functioning but motor	7-8
	Can't make changes to control panel settings	7-8
	Plot output speed is erratic	7-9
	Burning smell during plot, or "blooming"	7-10
	Form feed stops before desired length	7-11
	Form feed does not stop at top-of-form marks	7-11
	Plot is skewed or unreadable	7-12
8.	WARRANTY	8-1
APPENDICES		
A.	ASCII TABLES	A-1

B.	INTERFACE CONNECTOR PIN ASSIGNMENT	B-1
C.	CENTRONICS INTERFACE BOARD	C-1

1.1 GENERAL DESCRIPTION

The Imaging Systems Group's V8.5e Thermal Plotter is a high-speed plotter suitable for office or field use. Its small size and lightweight, yet rugged construction makes it durable in mobile situations. The V8.5e uses direct thermal plotting technology, so it requires no liquid or powdered ink.

Interface parameter settings and other menu functions can be accessed from either the front panel or the host computer. It is capable of printing at four speeds; 1.0, 2.0, 3.0, and 4.0 inches per second.

The V8.5e thermal plotter contains a completely new method of plotting rasterized data. Each scan of data plotted can contain as many as 64 independent intensity levels (gray scales). The thermal print head (TPH) in the V8.5e is made up of 1728 thermal heater nibs, and each one of these nibs can be heated to a different energy level, producing a dot on the thermal media of varying intensity. This type of plotting can produce high-resolution images containing many shades of gray.

The V8.5e prints in both raster and character modes, and contains a 96-character ASCII set. It interfaces with Versatec and optionally Centronics data interfaces.

1.2 MEDIA DESCRIPTION

The V8.5e uses rolled or fan-folded thermal paper or rolled film. Media width is 8.75, and 9.0 inches. The V8.5e accommodates regular thermal paper, papers with a protective top coating, as well as certain types of film media. Call your Imaging Systems Group product representative for media recommendations.

An optional fan-fold paper guide and feeder trays (which attach to the back of the plotter, and below the rackmount plotter) are available from The Imaging Systems Group which stabilizes the paper for smooth intake of fanfold papers. These options are useful in field situations or where vibration is a problem.

1.3 ABOUT THIS MANUAL

Please read this manual before using the plotter, in particular the Installation and Operation Chapters, and the “Regular Maintenance” section in the Maintenance Chapter.

Pay special attention to warnings, cautions and notes. The following conventions are used in this manual:

CAUTION: Indicates possible equipment damage unless procedure is followed correctly.

VORSICHT: Verweist auf die Gefahr der Beschädigung des Gerätes, falls die Vorschriften nicht genau befolgt werden.

NOTE: Indicates a general rule for a procedure, or an exception to a rule.

WICHTIGER HINWEIS: Verweist auf allgemeine Verfahrensvorschriften oder eine Ausnahme zu einer Vorschrift.



This symbol indicates an area of possible concern due to static discharge into the circuitry. When this symbol appears in the manual, please observe proper static precautions to minimize damage to the circuitry.

Dieses Symbol warnt davor, dass es in diesen Bereichen möglicherweise zu statischen Entladungen an den Schaltkreisen kommen kann. Wenn dieses Symbol im Handbuch erscheint, sind die entsprechenden Vorsichtsmaßnahmen zu treffen, um eine Beschädigung der Schaltkreise so weit wie möglich zu vermeiden.

2.1 FUNCTIONAL

Operation

Command panel	Front mounted. LED display. Three push buttons. Online/Offline, Data and error LED's.
Command modes	Bimodal Plotting mode. Grayscale mode. Printing mode.
Features	Bimodal (black and white) plotting. Grayscale plotting. Plot speed up to 4.0 inches per second. Microprocessor controlled. Automatic head temperature feedback
Panel settings	~ On-line, off-line. ~ Test plot, test print. * Contrast C1, C2, C3, C4, C5, C6, C7, C8. * Plot speed select 1", 2", 3", 4" per second. * Media select LP, HP, LF, HF. ~ Scaling (positive and negative) S0, S1, S2, S3, S4, S5, S6, S7, S8, S9, SA, SB, SC, SD, SE. ~ Vertical emulation. P0, n0 for 200 dots per inch vertical emulation. P3, n3 for 203 dots per inch vertical emulation. P selects positive scaling, n selects negative scaling.

- ~ Form feed adjust F2, F4, F8, tF, PF - selects formfeed of 2, 4, 8 inches, Top of Form sensing, and programable past top of form respectively.
- ~ Bytes per scan b1, b2 - selects 216 and 264 bytes per scan respectively.
- ~ Grayscale levels per scan g1, g2, g3, g4 - selects 8, 16, 32, and 64 levels of gray levels per scan respectively.
- # Grayscale media calibration table number t1, t2.

Settings marked with (*) are used exclusively with bi-modal plotting.
Settings marked with (#) are used exclusively with grayscale plotting.
Settings marked with (~) are used with both bi-modal and grayscale plotting.

Plot speeds Paper 1.0, 2.0, 3.0, and 4.0 inches per second in bimodal (black and white) plotting mode.
Film: 1.0 inch per second.
Grayscale: dependent upon the number of levels of grayscale selected.

Condition detection Media out.
Top of form.
Head temperature.
24 volt error detection.

Media

Types	Thermal sensitive paper or film. Rolled paper with 7/16 inch spool core. Rolled film. Fan-folded paper (optional).
Width	8.75 inch rolled paper or film media. 8.75, 9.0 inch fan fold paper media.
Maximum length	Rolled media: 100 feet with thick paper, 150 feet with thin paper. Maximum diameter 2.5 inches. Fan-fold: unlimited maximum.
Fan-fold guides	Optional, for fan-fold paper. Adjustable for 8.75 inch and 9.0 inch media.
Feeder trays	Optional, for fan-fold paper.

Thermal printhead

Type	Linear array.
Resolution	203 dots per inch (8 dots per millimeter).
Dots per scan	1728 (metric) maximum.
Bytes per scan	216 bytes maximum.
Image width	8.5 inches.

Transport

Stepper motor	Micro-step.
Stepping resolution	0.004 millimeter. 6400 micro-steps per inch of media. 32 micro-steps per scan line.

2.2 ELECTRICAL**Interface**

Type	Parallel, 8 kB buffer
Compatibility	Versatec Greensheet Centronics parallel (optional) External SCSI
Data cable	Optional

Power consumption

Idle mode	110 Watt minimum.
Plot or print mode	315 Watt maximum

Power requirements

Voltage	Auto selectable input 100 Volts AC @ 60 Hertz Or 240 Volts AC @ 50 Hertz
Current	3 Amps maximum @ 110 Volts 1.5 Amps nominal @ 220 Volts
Fuse	250 Volts / 5 Amps

2.3 PHYSICAL**Dimensions**

	Rackmount	Desktop
Height	3.5 inches	3.5 inches
Width	19 inches	15 inches
Depth	12.5 inches	12.5 inches

Weight

Net	23 pounds	22 pounds
-----	-----------	-----------

2.4 ENVIRONMENTAL**Temperature**

Operating range 32° to 122° Fahrenheit (0° to 50° Celcius)

Storage range 14° to 158° Fahrenheit (-10° to 70° Celcius)

Other

Operating humidity 5% to 95 non-condensing

Certification FCC Class "A" certified for electromagnetic interference

3.1 UNPACKING

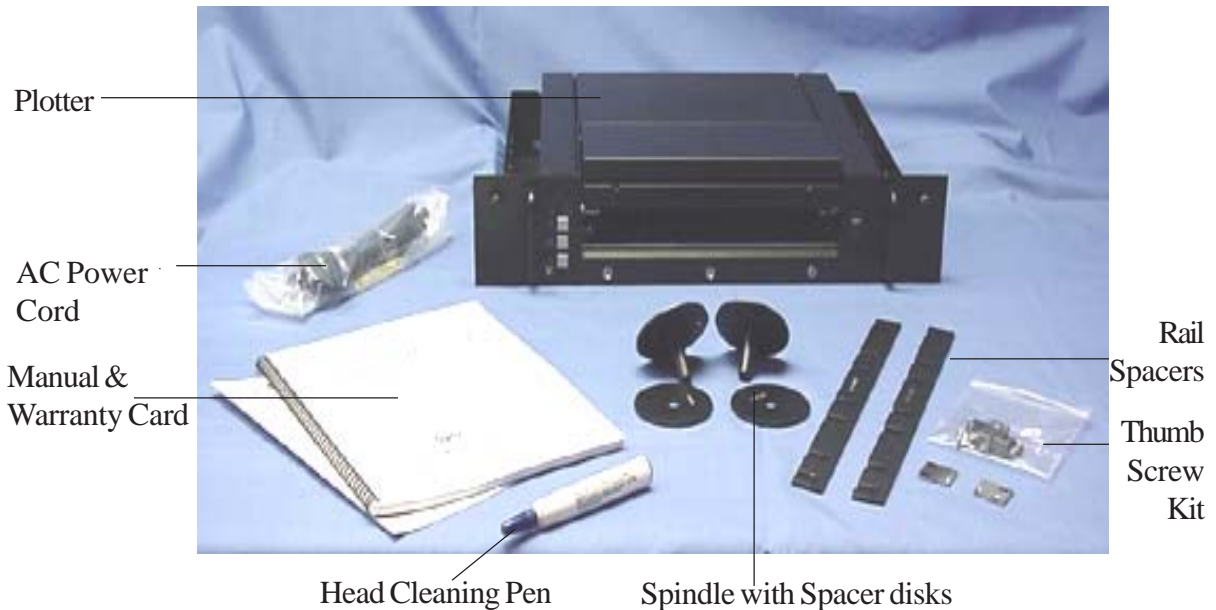

Although shipments are thoroughly checked for completeness by The Imaging Systems Group Inc., confirm that your plotter has the following:

1. Power cord
2. Sample Roll of paper
3. Two spindle hubs
4. Rackmount spacers

Confirm that any specified options are present, such as a data cable or fan-fold guide.

Inspect the plotter and components for any damage that may have occurred during shipment. Report any damage to the carrier of the shipment, and to your Imaging Systems Group Inc. product representative.

Keep the box and packaging for future shipping, in the event of servicing or upgrading issues. This product must be returned to our factory in the original or proper packaging material. Damage caused during return shipping or due to improper packaging will not be covered by The Imaging Systems Group Inc. During shipping or storage, place a length of thermal paper between the printhead and roller. This prevents damage caused by the two components sticking together.

3.2 MOUNTING AND POSITIONING

Keep the V8.5e away from direct heat sources, including sunlight. Do not block the vents on the sides of the plotter.

CAUTION: Make sure the thumbscrews are secured before operation. This is particularly important in mobile situations. Damage to the plotter or rack components could result if the plotter becomes unstable.

VORSICHT: Versichern Sie sich vor dem Betrieb des Gerätes, dass die Flügelschrauben festgestellt sind. Das ist besonders in beweglichen Konstellationen wichtig. Sollte der Plotter instabil werden, kann dies zu Schäden am Plotter oder am Gestell führen.

3.3 INTERFACE SETUP

Plug the power cord into a grounded AC outlet only. Avoid sharing an outlet that is also powering other noise-generating equipment.

The V8.5e comes equipped with a Versatec short line TTL (transistor to transistor logic) interface. This interface can be used for data cable lengths up to 50 feet.

An optional long line interface (differential) can be used for data cable lengths up to 700 feet.

For optional Centronics interface setup, see Appendix C.

An external SCSI (Small Computer System Interface) is also available. Please contact your Imaging Systems Group Inc. product representative for further information.

3.4 MEDIA INSTALLATION

CAUTION: Do not attempt to plot or form feed without the print medium installed. This may damage the print head and will void the warranty.

VORSICHT: Versuchen Sie bitte nicht, einen Druckvorgang oder Papiervorschub zu starten, wenn sich kein Druckmedium im Plotter befindet. Dies kann zu einer Beschädigung des Druckkopfes und zum Verlust der Garantie führen.

Installing rolled paper

The V8.5e plotter comes with a sample roll of thermal sensitive paper.

To install rolled paper:

1. Loosen the rackmount thumbscrews and pull the plotter forward on the rails.
2. Release the lid assembly by grasping underneath the black latch bar and pulling it upwards (Figure 3-5). Open the plotter lid by lifting the guide straight upwards.
3. Remove the fan-fold guide by grasping the two stainless steel rails and lifting it straight upwards.
4. Place the spindle hubs onto each end of the roll of media with the spacer on the left hand side spindle.
5. Orient the roll so that the paper feeds off of the top of the roll.
6. Place the roll in the plotter so that the pins on the spindle hubs snap into the slots on the spindle blocks.
7. Guide the paper over the blue platen roller and under the black cutter bar as shown in Figure 3-3.
8. Figure 3-4 shows roll paper installed. When installing any media, ensure that the coated side of the media is on top.

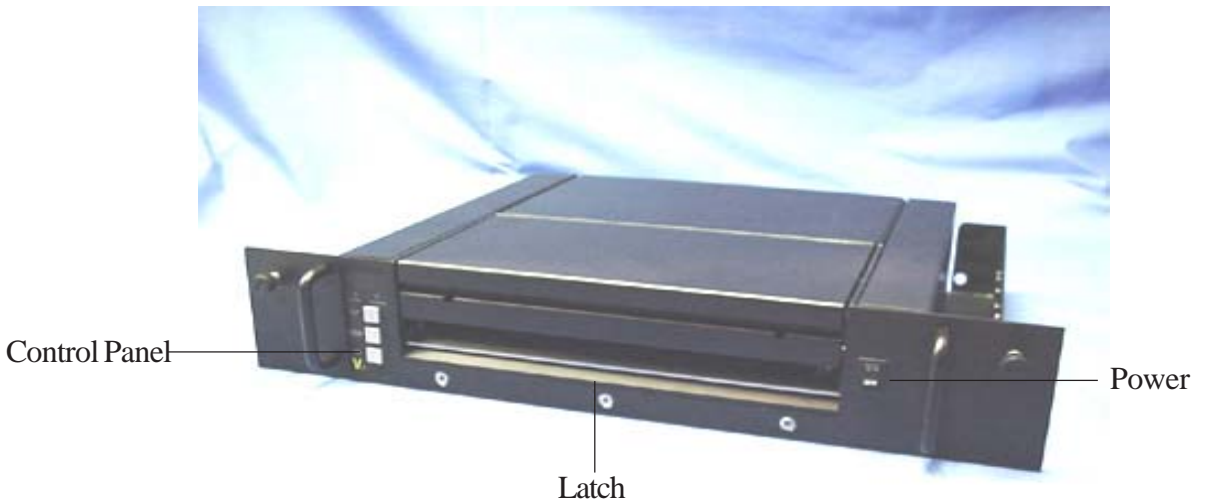

Figure 3-1

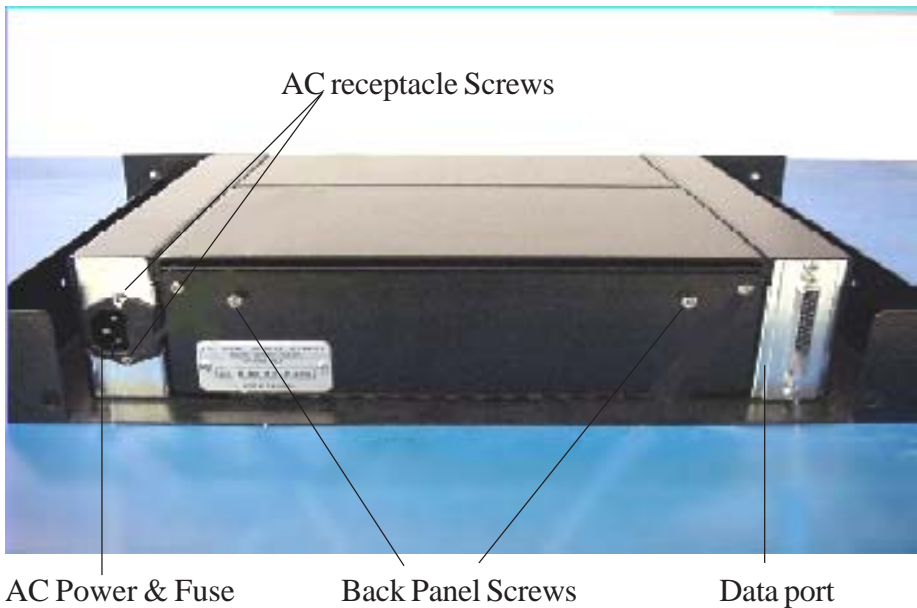

Figure 3-2 Back Panel

3 | I N S T A L L A T I O N

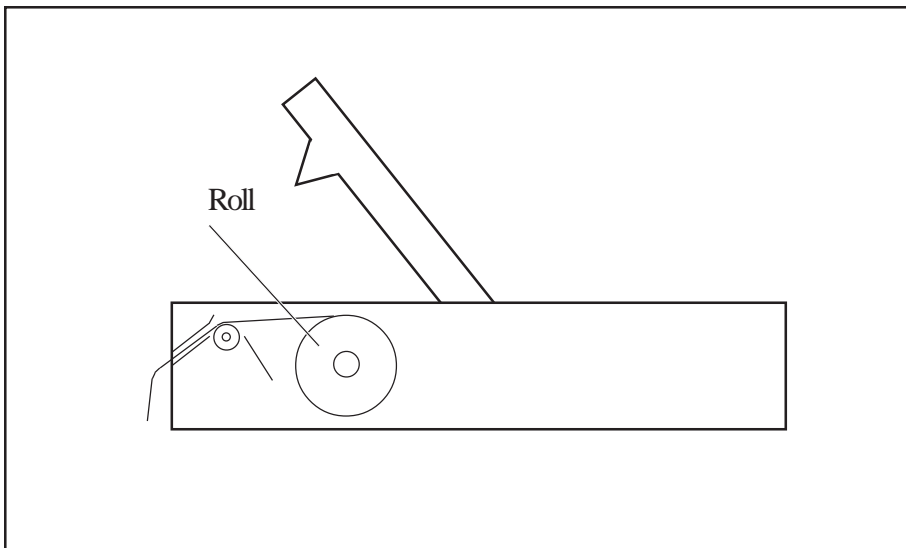

Figure 3-3. Roll paper and film path



Figure 3-4 Roll paper installed



Figure 3-5 Opening the plotter Lid

Latch Bar

Installing fan-fold paper

1. Loosen the rackmount thumbscrews and pull the plotter forward on the rails.
2. Release the lid assembly by grasping underneath the black latch bar and pulling it upwards (Figure 3-5). Open the plotter lid by lifting it straight upwards.
3. Remove paper roll and insert the fanfold guide over the spindle blocks (see Figure 3-6).
4. Feed the paper through the slot in the back or bottom of the plotter depending on which fan-fold paper tray is being used.
5. If using rear load fan-fold paper, feed the media under the rear fan-fold guide bar and over the front fan-fold guide bar. Figure 3-4. If using bottom loaded fan-fold paper, feed the media over the rear fan-fold guide bar and over the front fan-fold guide bar.
6. Guide the paper over the blue platen roller and under the black cutter bar as shown in Figures 3-3 and 3-4.
7. When installing any media, ensure that the coated side of the media is on top and the TOF mark is on the bottom right side.

Installing and using film

Note that the plotter operates at 1.0 inch per second when using film. Install roll film as you would paper, ensuring that the coated side is on top.

Note that the cutter bar is designed for paper media only. Use a sharp knife or scissors to cut film media.

CAUTION: Before plotting or testing on any print media, make sure that the media setting is correct. Incorrect settings may result in damage to the printhead and warranty. The media may also be damaged.

VORSICHT: Bevor Sie mit dem Plotten oder Testdrucken auf einem Druckmedium beginnen, versichern Sie sich, dass die Einstellungen für das Druckmedium korrekt sind. Falsche Einstellungen können zu einer Beschädigung des Druckkopfes und zum Verlust der Garantie führen. Außerdem kann hierdurch auch das Druckmedium beschädigt werden.

Installing rolled film

1. Loosen the rackmount thumbscrews and pull the plotter forward on the rails.
2. Release the lid assembly by grasping underneath the black latch bar and pulling it upwards (Figure 3-5). Open the plotter lid by lifting it straight upwards.
2. Remove the fan-fold guide by grasping the two stainless steel rails and lifting it straight upwards.
3. Place the spindle hubs onto each end of the roll of film with the spacer on the left hand side spindle.
4. Orient the roll so that the film feeds off of the top of the roll.
5. Place the roll in the plotter so that the pins on the spindle hubs snap into the slots on the spindle blocks.
6. Guide the film over the blue platen roller and under the black cutter bar as shown in Figure 3-3.



Figure 3-6 Spindle blocks

Spindle blocks (1 per side)

**Paper path is under rear guide bar,
over front guide bar, then under
cutter plate.**



Figure 3- 7. Fanfold guide path

4.1 POWER SUPPLY PRECAUTIONS

Turn off the power switch on the plotter before doing any of the following:

1. Unplugging the plotter
2. Cleaning the printhead



CAUTION: Take care not to discharge static into the plotter. This may cause damage to the integrated circuits or other electronic components. Use an approved method of static dissipation to prevent component damage.

VORSICHT: Vermeiden Sie statische Entladung am Plotter. Dies könnte zu Schäden an den integrierten Schaltkreisen und anderen elektronischen Bauteilen führen. Verwenden Sie ein anerkanntes Verfahren zu Ableitung der statischen Energie, um Geräteschäden zu vermeiden.

4.2 USING THE CONTROL PANEL

To turn the plotter on, press the main power switch at the front of the plotter. The LED display “moves in circular motion” during bootup, followed by the ONLINE LED illuminating. When the ONLINE LED is on, the plotter is ready to receive data from the host. Changes to the plotter have to be made in offline mode.

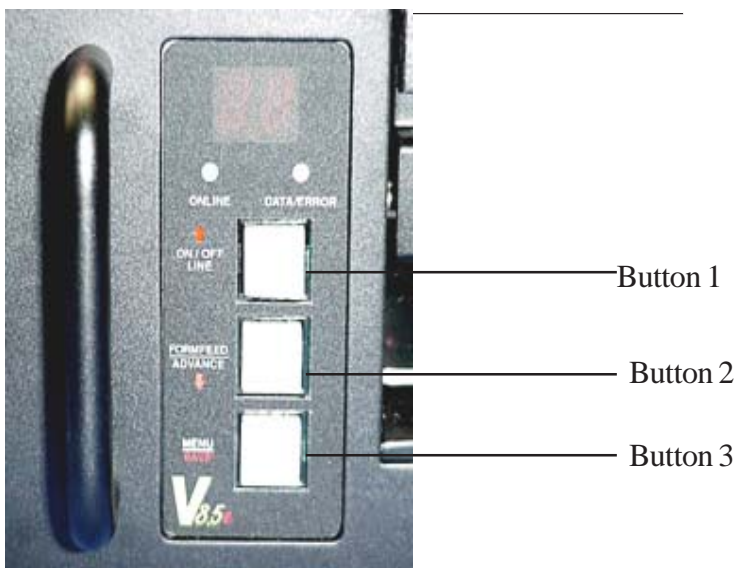

Figure 4-1. Control panel

The control panel is shown in Figure 4-1. It consists of an LED display, two condition lights, and three buttons.

Button	Function
1. UP ARROW. Online/Offline	Toggles between ONLINE and OFFLINE modes. Changes to control panel settings can only be made in OFFLINE mode. Selects function sub menu's after menu access
2. DOWN ARROW. Form Feed/Advance	Works in OFFLINE mode only. Pressing and releasing causes a form feed to the preset length. Pressing and holding manually advances paper. Selects function sub menu's after menu access.
3. Menu/Save	Selects function menu in OFFLINE mode by scrolling through the list. Scrolling is from first to last only. Pressing and holding until display flashes: saves menu settings.

Table 4-1. Control panel button functions

Table 4-1 shows the control panel button functions. The up and down arrows access function sub-menu settings after the menu is accessed using the menu button.

	tP Test Pbt	Contrast	Speed	M edia	Scaling	Vertical Emulation	FF Length	Bytes per scan	Greyscale m edia table
Press UP ARROW / FORM FEED to access	(Activate Pbt test by pressing MENU button)	C8 C7 C6 C5 C4 C3 C2	4 3 2	HF LF HP	SE SD SC Sb SA S9 S8 S7 S6 S5 S4 S3 S2 S1	n0 n3 P0	PF tF fB f4	g4 g3 g2 g1 b2	t2
Default Value	Inactive	C1	1	LP	S0	P3	f2	b1	t1

Table 4-2. Control panel settings and organization

4.3 CONTROL PANEL FUNCTIONS AND SETTINGS

See Table 4-2 for default settings and organization.

Changing function settings

For easy reference in this section, the buttons are referred to as numbers 1, 2, and 3, from top to bottom. (See Table 4-1 for button labels and functions.)

1. Press Button 1 to turn the plotter offline. Settings can only be changed while the plotter is offline. The green ONLINE status light turns off and the display will show: — indicating offline status.
2. Press Button 3 to scroll through the menus.
3. For each menu item, press Button 1 or 2 (up or down arrows) until the desired setting (or sub menu item) is shown in the display for that menu.
4. Save the setting by pressing *and holding* Button 3 (MENU/SAVE) Display shows:

NOTE: Press and hold the MENU/SAVE button immediately after the desired function setting is displayed. Advancing through the menu without doing so will not save your changes.

5. The display will then show the offline display: —. Repeat steps 2 through 4 for each function setting.
6. Press button 1 to return to ONLINE mode. Display will be blank and online LED will be illuminated.

Default Settings

To restore the default settings of the plotter, press and hold the menu button (button 3) while powering the plotter on. The display will briefly show “dF” during the boot up sequence, indicating that the default menu items have been loaded.

Test plot

This function produces approximately six inches of plot in a checkerboard and dither pattern in Bimodal mode. Generating a test plot while the plotter is set to grayscale mode will result in a grayscale plot corresponding to the number of gray levels selected at the time. This enables the user to verify that the plotter is creating a plot image, feeding the paper correctly, and that contrast levels and media settings are acceptable. The test plot will use the current menu settings to generate the image.

1. Press Button 1 to put the plotter into OFFLINE mode.
2. Press Button 3 once. “tP” is displayed.
3. Press and hold Button 3 until the display flashes:
The test plot will be generated.

Contrast

The contrast function adjusts the density of the output. Settings range from **C 1** to **C 8**. Settings are relative values: **C 1** is the lightest, **C 4** is normal, **C 8** the darkest.

After performing a test plot or plot job, determine if the contrast is acceptable. If the output is extremely dark, very faint, or irregular, first check that the media setting is correct (see “Media” section of this chapter).

If the contrast needs further adjusting, change the contrast setting by starting at the lowest value, adjust the contrast upwards one value at a time, testing after each adjustment. This is particularly important when using lightweight papers or papers with unknown specifications.

CAUTION: Thermal plotting technology involves high temperatures. Incorrect media or contrast settings can damage the printhead or other components and void the warranty. Media damage can also occur.

VORSICHT: Bei der thermischen Plottertechnologie entstehen hohe Temperaturen. Ungeeignete Medien oder falsche Kontrasteinstellungen können den Druckkopf oder andere Bauteile beschädigen und zu Verlust der Garantie führen. Auch können Beschädigungen an den Medien entstehen.

Speed

The speed function adjusts the speed of the plot output. There are four output plot speed settings in the V8.5e: 1.0, 2.0, 3.0, and 4.0 inches per second. The default setting is 1.0 inch per second which produces the highest quality output.

If the plot speed is erratic, or if output quality is unacceptable, lowering the plot speed will result in an improved plot quality. Such problems may arise when data enters the plotter at a slower rate than the plot speed setting. Lowering the output plotting speed enables the plotter to match a lower input data rate and produces a smoother output plot.

When the media setting is film (**LF** or **HF**), the plotter speed defaults to 1 inch per second. When Grayscale mode is enabled, plot speed is dependent upon the level of grayscale selected.

Media

The media function adjusts the time that the printhead is turned on (strobe time) to create an image on the media based upon the media type selected. The default setting is light paper. When the plotter is set to film or grayscale mode the printhead's requirement for strobe times is raised. This requires a slower plot speed in order to maintain the high quality level of the V8.5e.

Note: there are two preprogrammed media tables for grayscale plotting. These calibration tables can be changed for different medias by uploading new tables which can be provided by The Imaging Systems Group Inc. for virtually any approved thermal media. These tables are custom tuned to provide maximum grayscale performance on a selected media. These tables can be uploaded to the V8.5e, where they are stored in non-volatile memory until overwritten. Tables are uploaded two at a time overwriting the factory default tables stored in **T1** and **T2**.

CAUTION: Thermal plotting technology involves high temperatures. Incorrect media or contrast settings can damage the printhead or other components and void the warranty. Media damage can also occur.

VORSICHT: Bei der thermischen Plottertechnologie entstehen hohe Temperaturen. Ungeeignete Medien oder falsche Kontrasteinstellungen können den Druckkopf oder andere Bauteile beschädigen und zu Verlust der Garantie führen. Auch können Beschädigungen an den Medien entstehen.

Scaling

The scaling function stretches or shrinks the plot over a 36-inch length of plot with settings being **S0** through **SE**. The default setting is (**S2**). To determine if scaling is needed, plot a job of a known length and measure it. Adjustments can be made to the scaling in increments of + or - 1/16-inch over 36 inches of plot. **S0** = no scale,
SE = + /- 14/16" over 36 inches of plot.

Note: Positive or negative scaling is selected through the Emulation menu setting.

Emulation (vertical resolution)

The emulation function adjusts the vertical resolution of the plot (along the media length). The settings are P0, n0, P3, and n3. **P0** and **n0** are used with 200 scans/inch of plot data. The default setting (**P3**) is 203 scans per inch (equal to 203 dots per inch- dpi). **P3** and **n3** are used for 203 scans/inch of plot data. **P** and **n** stand for Positive and negative scaling for the scaling menu. If **n** is selected, the scaling factors are from no scale to -14/16" over 36" of output plot. If **P** is selected, the scaling factors are from no scale to + 14/16" over 36" of plot.

Note that the horizontal resolution is determined by the printhead dot density, which is 203 dpi. The plotter can emulate 200 dpi vertical resolution (**E0** and **n0** settings), to match the rastered host data (for Imperial units).

Form feed length

The form feed length function adjusts the distance that the media is advanced in off-line mode and when a remote function is sent. To form feed media, put the plotter in offline mode and press the FORMFEED/ADVANCE button *without holding*.

Menu settings are: **F2, F4, F8, tF, PF**.

F2, F4, F8 cause 2", 4", or 8" of media to be advanced upon a formfeed. If a TOF mark is detected before the formfeed is completed the plotter will stop upon detecting the mark, or to what the **PF** setting is.

tF results in the plotter advancing up to 18" while detecting for the Top of Form mark on fan fold media. The top-of-form setting (**tF**) allows the plotter to detect top-of-form marks. These marks signal the plotter to stop the form feed at a consistent distance from the perforated edge of the paper.

PF - Programmable advance past Top of Form- This feature allows the V8.5e to line up with the beginning of pages when a media whose TOF marks do not meet the V8.5e specifications.

NOTE: iSys recommends only the use of approved media in the V8.5e which has been qualified to increase plotter life and produce higher quality plots.

Once the **PF** feature is selected in the menu, the V8.5e will detect the media TOF mark and continue to advance the media by the amount programmed when a formfeed or end of transmission is commanded.

This feature is enabled by setting the formfeed menu to “PF”
The advance range is from 01 hex --- 10 scans (approx 0.05”)
to
ff hex --- 2550 scans (approx 12.5”)
in increments of 10 scans for each hex number.

Once the menu has been set to “**PF**”, the amount of advance past TOF which has been programmed into the V8.5e will be used until it is changed. The default value is 23 Hex.

To program the amount of advance past TOF, send header:

98 XY 0A (where XY is the hex# of groups of 10 scans).

If the V8.5e accepts the setup string, the display will flash

Bytes per scan

The SCANWIDTH function adjusts the scan width of the plot, defined in bytes per line. The default scan width is **b1** (216 bytes per scan).

Menu settings are: **b1, b2, g1, g2, g3, and g4.**

b1 – 216 bytes/scan (bimodal).

b2 – 264 bytes/scan (bimodal).

g1 – 8 gray levels per scan, 1728 bytes/scan maximum.

g2 – 16 gray levels per scan, 1728 bytes/scan maximum.

g3 – 32 gray levels per scan, 1728 bytes/scan maximum.

g4 – 64 gray levels per scan, 1728 bytes/scan maximum.

Unless you are using RLTER (remote line terminate) commands, the plotter scan width must be set to the same byte count as the rastered data from the host. Setting the scan width higher than the byte count of the raster data does not create a wider plot. Setting the scan width incorrectly results in skewed output as the data “wraps” and finishes the scan on the next line. This condition is identifiable on the plot in Figure 7-8.

The V8.5e contains a new method of plotting raster data. Each scan of data plotted can contain as many as 64 independent intensity levels (gray scales). The thermal print head (TPH) in the V8.5e is made up of 1728 thermal heater nibs, and each one of these nibs can be heated to a different energy level, producing a dot on the thermal media of varying intensity. This type of plotting can produce high-resolution images containing many shades of gray.

Change the scan width settings by pressing the up or down arrows in the bytes/scan sub-menu.

Press and hold Button 3 until the display flashes: 

Grayscale media table number

t1 - media calibration table for media 1.

t2 - media calibration table for media 2.

These tables have preset values for imaging on two different medias while in grayscale mode. These medias can be changed for different medias by uploading new tables.

Setup headers for programming the V8.5e

NOTE: The V8.5E must be in PRINT mode for the setup header string to work. Numeric values shown below are hexadecimal, not ASCII.

NOTE: All menu functions can be remotely configured by sending a setup header string from the host to the V8.5E through the interface. The programmable advance past TOF can be programmed in a similar fashion.

NOTE: Sending a 00 hex in any of the setup string positions listed below allows the menu item to remain unchanged.

The format is as follows:

Byte 1:	escape code	= 99	
Byte 2:	contrast	C1= 11	Lightest
		C2= 12	
		C3= 13	
		C4= 14	
		C5= 15	
		C6= 16	
		C7= 17	
		C8= 18	Darkest
		No Change= 00	

Byte 3:	speed	1"= 21 1.0 inches/sec 2"= 22 2.0 inches/sec 3"= 23 3.0 inches/sec 4"= 24 4.0 inches/sec No Change= 00
Byte 4:	media	LP= 31 Light Paper HP= 32 Heavy Paper LF= 33 Light Film HF= 34 Heavy Film No Change= 00
Byte 5:	scaling	S0= 41 No Scale S1= 42 S2= 43 S3= 44 S4= 45 S5= 46 S6= 47 + /- 1/16" S7= 48 increments over 36" of S8= 49 plot up to + /- 14/16" S9= 4A SA= 4B Sb= 4C SC= 4D Sd= 4E SE= 4F No Change= 00

Byte 6:	emulation	P0= 51 200 scans/inch vertical with positive
scaling		n0= 52 200 scans/inch vertical with negative
scaling		P3= 53 203 scans/inch vertical with positive
scaling		n3= 54 203 scans/inch vertical with negative
scaling		No Change= 00
Byte 7:	formfeed	F2= 61 F4= 62 F8= 63 tF= 64 Stops on TOF Mark PF= 65 Programmable advance past TOF mark No Change= 00
Byte 8:	bytes/scan	b1= 71 (216 bytes/scan) b2= 72 (264 bytes/scan) g1= 73 8 level grayscale g2= 74 16 level grayscale g3= 75 32 level grayscale g4= 76 64 level grayscale No Change= 00
Byte 9:	grayscale media table	t1= 81 (media type 1) t2= 82 (media type 2) No Change= 00

Byte 10: line feed 0A

Example: To set the plotter to:

```

contrast= C3
speed= 1.0 ips
media= LP
scaling= S2
emulation= P3
formfeed= F2
bytes/scan= b1
grayscale media table= t1

```

Then send header: 99 13 21 31 43 53 61 71 81 0A

If the V8.5E accepts the setup string, the display will flash

If there are any errors in the string, such as an out of range value on one of the numbers, or any other errors in the string format, the plotter will not accept the string, no reconfiguration will take place, and the error LED will flash twice.

4.4 ERROR MESSAGES

1. Media Out Error: The plotter will display a small square, flashing segments and the error LED will flash. To fix this error, reload media into the potter. Plotter must be put back online to continue plotting.

2. Hot Head Error: The plotter will display Ht and the error LED will flash. The plotter will display this error until the thermal printhead cools to a temperature that is safe to plot again.

3. 24 Volts Error: The plotter will display 24 and the error LED will flash. If this error occurs, the 24 volt power supply may be faulty. Please contact your product representative.

4. Thermistor Error: The plotter will display tH and the error LED will flash. If the error occurs, the thermal printhead may be faulty. Please contact your product representative.

4.4 FEHLERMELDUNGEN

1. Medien leer: Am Plotter erscheint eine kleine quadratische blinkende Anzeige und die Fehleranzeige blinkt. Zur Behebung dieses Fehler muss neues Aufzeichnungsmaterial geladen werden. Der Plotter muss erneut online geschaltet werden, um den Plotting-Vorgang fortzuführen.

2. Druckkopfüberhitzung: Am Plotter erscheint **Ht** und die Fehleranzeige blinkt. Die Anzeige bleibt solange bestehen, bis der Druckkopf auf eine Temperatur abgekühlt ist, bei der wieder gefahrlos geplottet werden kann.

3. 24 Volt Fehler: Am Plotter erscheint **24** und die Fehleranzeige blinkt. Wenn dieser Fehler auftritt ist möglicherweise die 24-V-Spannungsversorgung defekt. In diesem Fall nehmen Sie mit ihrem zuständigen Vertragspartner Kontakt auf.

4. Thermistor Fehler: Am Plotter erscheint **th** und die Fehleranzeige blinkt. In diesem Fall ist möglicherweise der thermische Druckkopf defekt. Nehmen Sie bitte mit ihrem zuständigen Vertragspartner Kontakt auf.

5.1 INTRODUCTION

The V8.5e plotter uses thermal technology to convert data from the host computer into plotted output. Host data enters the plotter main logic circuitry via the data port, and passes through the interface to the data buffer on the main logic board. Control and status signals enter the main logic board at the same time as the parallel data. The microcontroller converts the data from parallel to serial and sends the serial data to the printhead. One horizontal line or scan, consisting of a single row of dots, is plotted. The stepper motor advances the paper for the next scan. This cycle repeats until the plotted or printed image is finished.

5.2 PLOTTER FUNCTIONS AND FEATURES

Power supplies

The logic circuitry and printhead of the plotter are powered by a 5 Volt DC output power supply. The thermal printhead and stepper motor are powered by a 24 Volt, 10 Amp DC power supply. Both power supplies feature an auto-switchable input, which adapts to different voltage or frequency inputs.

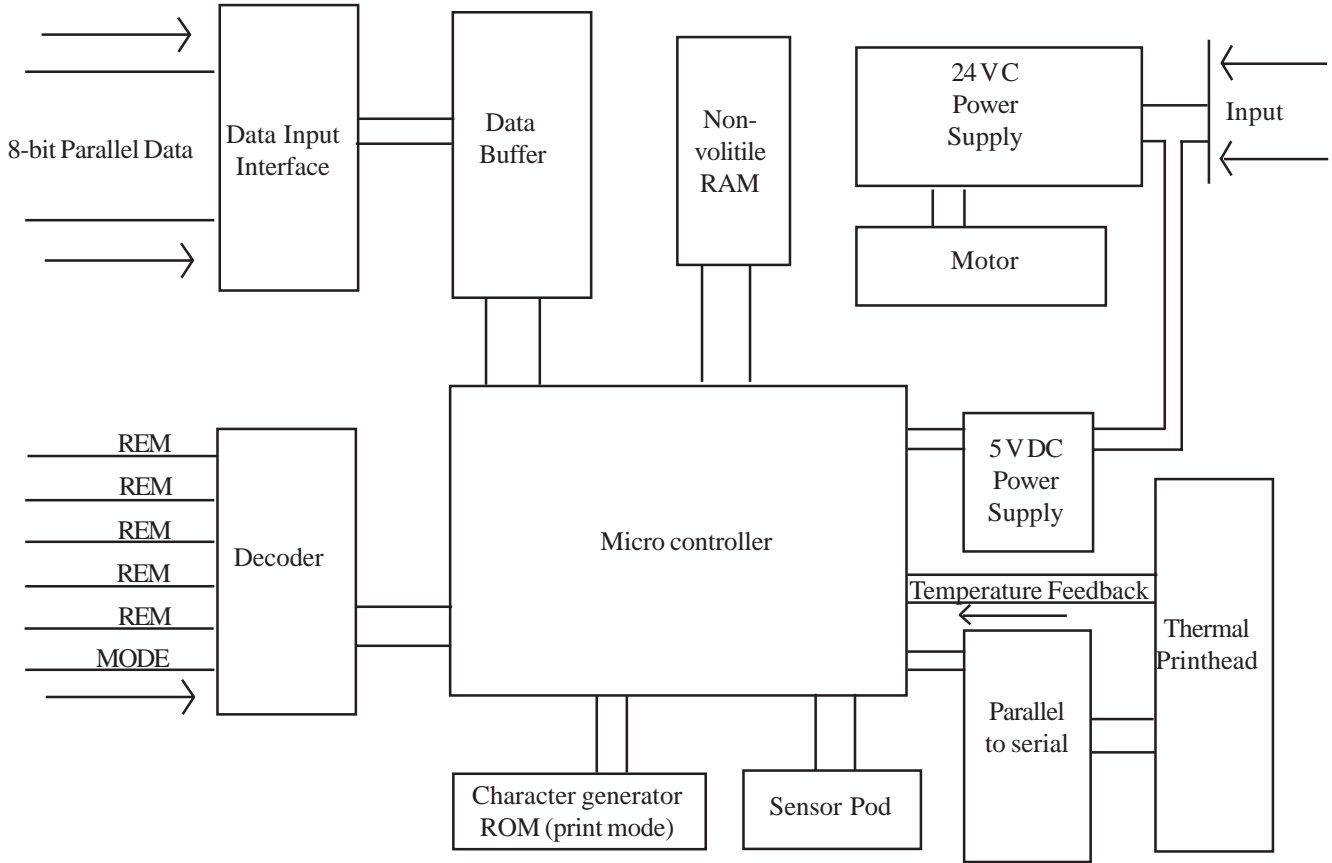

Figure 5-1. Functional block diagram

Stepper motor

The V8.5e uses a bipolar, two-phase stepper motor. The motor is micro-step driven, requiring 200 full steps for one rotation of the motor shaft. There are 32 micro-steps per full step. Thus the motor makes 6400 micro-steps for each rotation.

5.3 INTERFACE

The data interface may be short line or, optionally, long line (see “Interface setup” in Chapter 3, Installation for details.) The plotter is compatible with either the Versatec Greensheet or (optionally) the Centronics interface (see Appendix A). Table 5-1 shows the active level for the plotter status signals.

Signal Mnemonic	Signal Name	Active Level	Operation
ONLIN	Online	Low	Low level indicates the plotter is powered on and online
NOPAP	No paper	High	Indicates there is no paper in the plotter, or the lid is not properly closed and latched.

Table 5-1 Status Signals

Interface timing and signals

The ready signal indicates the plotter’s readiness to accept data. When READY is low, the plotter can accept one byte of data. This byte must be accompanied by a PICLK (data strobe) pulse.

Table 5-2 shows the timing relationship for maximum data transfer.

Signal Nhemmonic	Signal Name	Active Level	Operation
IND1 - IND8	Input data	High	Input lines for byte parallel data Must be accompanied by a PICKL
PICKL	Parallel input clock	High	Stobes a data byte present on IND1-IND8 into the input bufffer. Minimum 300nS pulse
READY	Plotter ready	Low	Low level means plotter is ready to receive next data byte or remote function. High level indicates plotter is busy and will not accept data or remote functions.

Table 5-2 Data Transfer

Note that the plotter goes busy after receiving each byte. The plotter goes busy for longer periods during the execution of remote functions, when the input buffer is full, or when an error occurs.

Table 5-3 shows the timing relationships for the remote functions. When the input buffer receives the number of bytes necessary to plot a full scan, a write cycle is automatically initiated, causing the buffer contents to be imaged on the medium.

Signal Mnemonic	Signal Name	Signal Level	Operation
CLEAR	Remote clear	Low	Clears the input buffer.
RESET	Remote Reset	Low	Resets the plotter and re-initializes all logic while the signal is asserted. Ready remains high while reset is asserted.
RLTER	Remote line terminate	Low	Terminates the buffer data currently being loaded, causes all previously loaded data to be output in sequence, then outputs the buffer data just terminated in sequence. This command is ignored if received immediately after a full scan has been automatically terminated.
RFFED	Remote form feed	Low	Terminates the buffer data currently being loaded, causes all previously loaded buffer data to be output in sequence, then outputs the buffer data just terminated in sequence. Paper is then advanced.
REOTR	Remote end of transmission	Low	

Table 5-3. Remote function signals

Data rates

The plotter accommodates a wide range of data rates. The speed of the plotter can be set to 1.0, 2.0, 3.0, 4.0 inches per second. To achieve a consistent plot rate at a certain speed setting requires minimum data rates. If data rates are inconsistent, and lower than these minimum rates, that plot speed will not be sustained. Table 5-4 shows the minimum data rates at the four speed settings.

Speed of plot	Minimum data rate
1.0 inch per second	44 KB/sec
2.0 inches per second	88 KB/sec
3.0 inches per second	132 KB/sec
4.0 inches per second	176 KB/sec

Table 5-4. Minimum data rates

As with all thermal plotters, slower speeds produce the highest quality output. Plotting at a speed too high for the data may result in the deterioration of fine details. Stops and starts caused by inconsistent data rates may also result in a lower quality output.

Scan width

Scan width settings sent from host software can specify the number of bytes of data that will be plotted on a line. The maximum setting that data can be rastered to is 264 bytes per scan.

NOTE: The thermal head holds a maximum of 216 bytes of data. When the plotter is set to 264 bytes per scan, the first 216 bytes of data from the host are loaded into the thermal head to be plotted and the last 48 are discarded.

For rastered data less than the current byte count setting on the plotter, the scan may be terminated at any byte count by a RLTER command. If a RLTER command is asserted, the scan is terminated and the plot continues on the next line.

Vertical resolution

The vertical resolution of the plot can be changed from the default value of 203 dpi (**n3 or P3**) to 200 dpi (**n0 or P0**, also known as Imperial unit setting). See “Emulation”, in Chapter 4, Operation, for information on control panel settings.

The plotter emulates the 200 dpi resolution by stretching the plot length. This is accomplished by inserting micro-steps at regular intervals, so that 200 scans cover one inch of plot.

Scaling

The scaling function either stretches or shrinks the plot by removing or adding a micro-step at a set interval. Adjustments can be made to the scaling in increments of $\pm 1/16$ ” over 36” of plot length. The interval is determined by the scaling setting on the control panel. See “Scaling” in Operation, Chapter 4, Page 4-9, for information on control panel settings.

Print mode

When the host asserts the PRINT mode signal, the plotter can generate ASCII characters. Table 5-5 shows the timing relationships for print mode signals.

Signal Mnemonic	Signal Name	Active Level	Operation
PRINT	Print Mode	High	Selects either print or plot mode. When signal is high, plotter is in print mode.
SPP	Simultaneous print/plot mode	Low	Not used

Table 5-5. Mode signals

ASCII characters are produced as plot patterns on a 16 x 20 dot matrix through the use of a Character Generator ROM. When one complete print line of ASCII-coded data is received, the data is converted into plot patterns. Each character line is executed over 20 plot scans.

5.4 THERMAL PRINTHEAD

The thermal printhead is comprised of a row of 1728 heater elements (nibs). Each bit within a scan addresses an individual nib. Plot patterns are generated one scan at a time, each scan consisting of a horizontal row of dots. A nib produces a dot if the corresponding scan bit in the buffer is a logic level "1". Nibs in the printhead are heated, causing a thermo-chemical reaction with the coating on the media. The intensity or period for which the nib is heated is called the burn strobe.

Automatic Head Temperature Feedback

The thermal printhead rises in temperature as it plots images on paper, thus, less energy is required to activate each nib as the plot proceeds to create an image of the same intensity. A thermistor embedded in the head measures the head temperature and provides feedback information to the main logic board. The main logic board decreases the burn strobe accordingly to keep the contrast of the plotted image consistent as the plot proceeds.

If the printhead temperature reaches 60° C, the Automatic Head Temperature Feedback circuit stops the plotter in order to let the head cool down. The control panel display reads hot (Ht) and the error light flashes. When the thermistor measures that the printhead temperature has cooled to 45° C, the plot resumes with no loss of data.

Film media

When the plotter is set to film mode, the strobe length is increased to accommodate the thicker media. The plot speed is set to 1.0 inch per second to allow the longer strobe length and to maintain plot quality.

5.5 MEDIA SENSORS

The top-of-form (also known as the “I-mark”) sensor and the media sensor are contained on a media sensor board .

The top-of-form sensor consists of a focused infrared beam and receptor that reacts to black top-of-form marks. The receptor sends a “stop form feed” command to the logic circuitry if a mark stops the beam from reflecting back into the receptor.

The paper sensor consists of an unfocused infrared beam and receptor. If the receptor receives enough reflected light, the receptor sends no command. If the reflected light is below the required level the receptor sends a “media out” command to the logic circuitry and plotting stops. The “no media” indicator is displayed on the control panel.

NOTE: Do not attempt to repair or modify any component of the V8.5e. If a component fails, it may be replaced free of charge in accordance with the warranty procedures in this manual. Attempting unauthorized repairs or modifications will void the warranty and invalidate safety approvals.

WICHTIGER HINWEIS: Versuchen Sie nicht, irgendwelche Bauteile des V8.5e zu reparieren oder zu modifizieren. Falls ein Bauteil versagt, kann es gemäß den in diesem Handbuch enthaltenen Garantiebedingungen kostenfrei ersetzt werden. Bei nicht genehmigten Reparaturen oder Modifizierungen erlischt der Garantieanspruch und Sicherheitszertifikate werden ungültig.

WARNING: There are voltage hazards inherent in the printhead power supply and AC input wiring. Take reasonable precautions to avoid electrical shock. Never service any electrical component of the V8.5e while the power cord is connected. Severe electrical shock may result.

WARNUNG: Am Druckkopf und am Wechselstromanschluss bestehen gefährliche Spannungen. Lassen Sie angemessene Vorsicht walten, um Stromschläge zu vermeiden. Ziehen Sie den Netzstecker, bevor Sie an irgendwelchen elektrischen Bauteilen des V8.5e arbeiten. Andernfalls kann es zu erheblichen Stromschlägen kommen.

CAUTION: Take care not to discharge static into the plotter. This may cause damage to integrated circuits or other electronic components. Dissipate static by wearing a static dissipating wrist strap, before using tools on the plotter or touching internal components.

VORSICHT: Vermeiden Sie statische Entladung am Plotter. Dies kann Schäden an den integrierten Schaltkreisen und anderen elektronischen Bauteilen verursachen. Leiten Sie statische Elektrizität ab, indem Sie ein Antistatik-Armband anlegen, bevor Sie am Plotter mit Werkzeugen hantieren oder interne Bauteile berühren.



This symbol indicates an area of possible concern due to static discharge into the circuitry. When you see this symbol in the manual, please observe proper static precautions to minimize damage to the circuitry.

Dieses Symbol warnt davor, dass es in diesen Bereichen möglicherweise zu statischen Entladungen an den Schaltkreisen kommen kann. Wenn dieses Symbol im Handbuch erscheint, sind die entsprechenden Vorsichtsmaßnahmen zu treffen, um eine Beschädigung der Schaltkreise so weit wie möglich zu vermeiden.

6.1 MAINTENANCE GUIDELINES

In order to minimize the complexity of troubleshooting and repairs, the V8.5e plotter is composed, wherever possible, of field-replaceable units (FRUs). The Imaging Systems Group Inc. does not recommend troubleshooting at a component level, but rather to the level of these FRUs. This chapter and the troubleshooting chapter of this manual follows this approach, resulting in faster and easier repairs. Replacing or repairing FRUs, rather than smaller components, minimizes downtime and simplifies procedures.

Use caution while troubleshooting the V8.5e. Turn the power off and unplug the power cord to prevent electrical shock.

Seien Sie bei der Fehlerbehebung am V8.5e vorsichtig. Schalten Sie den Strom ab und ziehen Sie den Netzstecker, um Stromschläge zu vermeiden.

6.2 REGULAR MAINTENANCE

The V8.5e thermal plotter is engineered to require minimal preventative maintenance. If the thermal printhead and platen roller are cleaned regularly, and the plotter is kept free of debris, extra maintenance should rarely be required.

This minimal preventative maintenance is the customers responsibility. Damage to the plotter that has in The Imaging System Group's opinion resulted from neglect or misuse will not be covered under warranty.

CAUTION: No parts of the V8.5e require lubrication. All bearings are sealed and self-lubricating. These bearings must be replaced in pairs if one fails by authorized repair depot.

VORSICHT: Kein Teil des V8.5e erfordert Schmierung. Alle Kugellager sind geschlossen und selbstschmierend. Diese Lager dürfen nur paarweise durch eine autorisierte Servicewerkstatt ausgetauscht werden, falls eines defekt wird.

Cleaning the thermal printhead

After prolonged use, the thermal printhead picks up fibres from the media passing under it. These fine fibres collect and compact on portions of the printhead, blocking the contact it makes with the paper during a plot and causing faded patches. Poor contact between the printhead and paper may also cause the affected heating elements (nibs) to fail prematurely because of improper heat dissipation to the paper.

Clean the printhead every time you install a new roll of paper or film.

1. Turn the plotter power off.

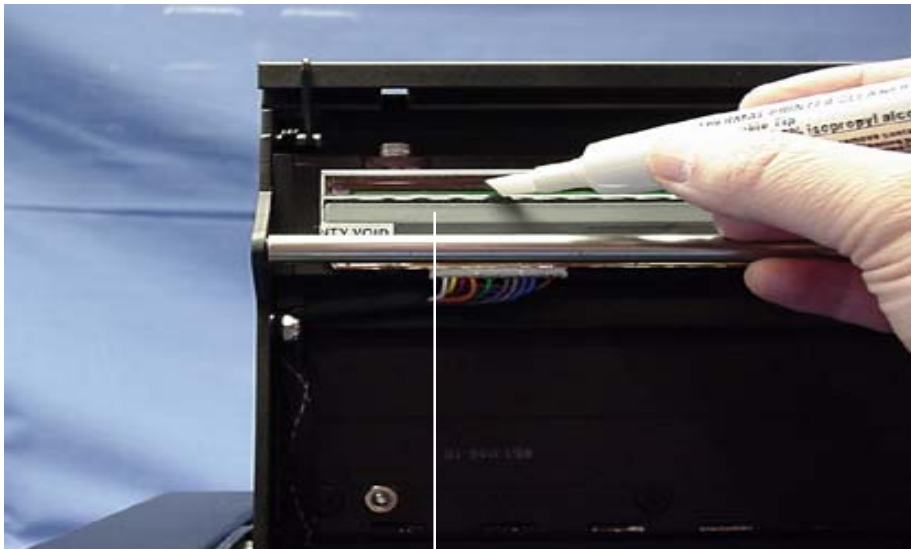

Figure 6-1

Print Head

2. Moisten (do not soak) a soft, lint-free cloth or cotton swab with 99% pure isopropyl alcohol. Rub gently along the length of the printhead, removing any buildup of residue on the printhead.
3. Allow the alcohol to evaporate completely before using the plotter.

CAUTION: Do not touch the printhead with your fingers or other objects. Skin oil will contaminate the printhead, which diminishes plot quality and shortens the life span of the printhead.

VORSICHT: Den Druckkopf nicht mit den Fingern oder irgendwelchen Gegenständen berühren. Fett oder Öl verschmutzt den Druckkopf, wodurch die Druckqualität vermindert und die Lebensdauer des Druckkopfes verkürzt wird.

Cleaning the platen roller

After prolonged use, the platen roller picks up fibres from the paper passing above it. These fine fibres collect and compact on portions of the platen roller, creating bumps. The uneven surface of the roller may cause the printhead to contact the passing paper unevenly, producing a blotchy or faded plot.

Clean the platen roller when it appears dirty, or after approximately three rolls of paper or film have been plotted.

Lightly wipe the roller with a soft, lint-free cloth moistened in 99% pure isopropyl alcohol, turning the roller as necessary to remove paper fragments and dust.

Replacing the fuse

The fuse is located in a clip next to the AC receptacle. Figure 3-2.

1. Unplug the power cable from the AC receptacle.
 2. Insert a small screwdriver into the slot on the fuse clip to release it from the AC receptacle.
 3. Remove the fuse from the clip. Replace the fuse and insert the clip.
-

WARNING: Replace only with a fuse of identical specifications. Other fuses may cause a fire hazard. See Chapter 2, Specifications, for fuse specifications.

WARNUNG: Beim Auswechseln der Sicherungen nur solche mit gleicher Spezifikation verwenden. Andere Sicherungen können Brände verursachen. Siehe Kapitel 2, Spezifikationen, hinsichtlich der Spezifikation der Sicherungen.

WARNING: Consistent damage to the plotter AC fuse indicates a serious problem and should be repaired immediately. Contact your authorized service center.

WARNUNG: Andauernder Ausfall der Wechselstromsicherung des Plotters verweist auf ein ernstes Problem, das sofort behoben werden sollte. Nehmen Sie Kontakt mit ihrer autorisierten Servicewerkstatt auf.

7.1 INTRODUCTION

This chapter provides a list of problems that may be encountered with the V8.5e, and gives possible causes and solutions for these problems.

To use this chapter, locate the problem from the list. Follow the steps in order, referring to Chapter 6, Maintenance, where necessary.

7.2 PROBLEMS

Plotter does not plot

Possible causes: Plotter has no paper or film
Lid is not securely closed
Thermal printhead is overheated
Latch pins need adjustment

Solutions:

1. Check the media supply. Install more media if necessary as described in Chapter 3, Installation.
2. Check that the media is installed correctly and the plotter lid is securely closed. The top of the lid should be flush with the top of the side panels.
3. If plotting has stopped in mid-task, the printhead may be overheated.

Do not intervene. The plotter will resume plotting from where it left off with no loss of data when the printhead has cooled sufficiently.

When the printhead temperature reaches 60°C, the plotter stops and asserts a “busy” signal to the host. Plotting resumes when the head temperature has cooled to 45°C. This prevents printhead damage caused by overheating.

4. If the lid does not close securely, or if the head pressure is too low, contact your authorized service center.

Plot has vertical white stripes

Figure 7-3 . Plot with vertical white stripes

Possible causes: Lid is not securely closed
 The printhead is dirty
 Some printhead nibs are burnt out

Solutions:

1. Check that the media is installed correctly and the plotter lid is securely closed. The top of the lid should be flush with the top of the side panels.
2. Clean the printhead as described in Chapter 6, page 6-3.
3. The thermal printhead has one or more burnt out nibs so it must be replaced. Contact your authorized service center.

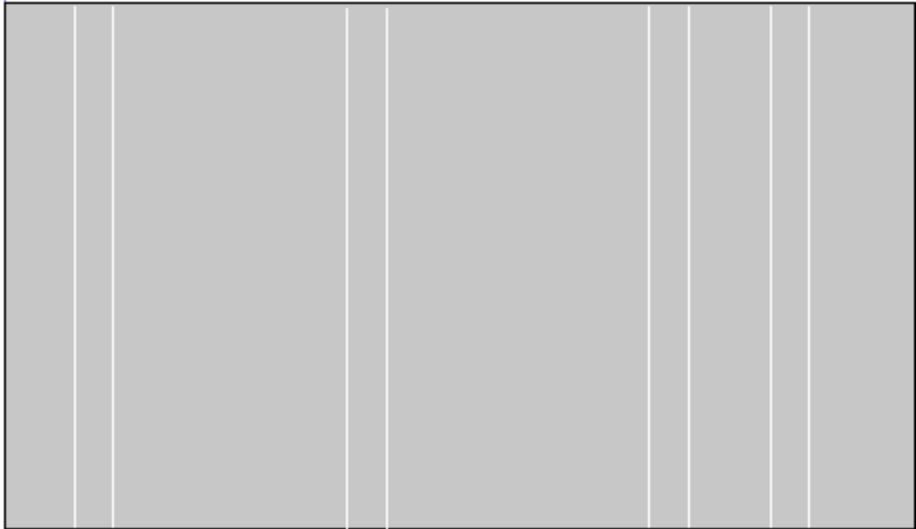
Plot is blotchy or faded

Figure 7-4 . Blotchy or faded plot

This problem originates from inconsistent printhead pressure across the platen roller during plotting.

Possible causes: Lid is not securely closed
 Latch pins need adjustment

Solutions:

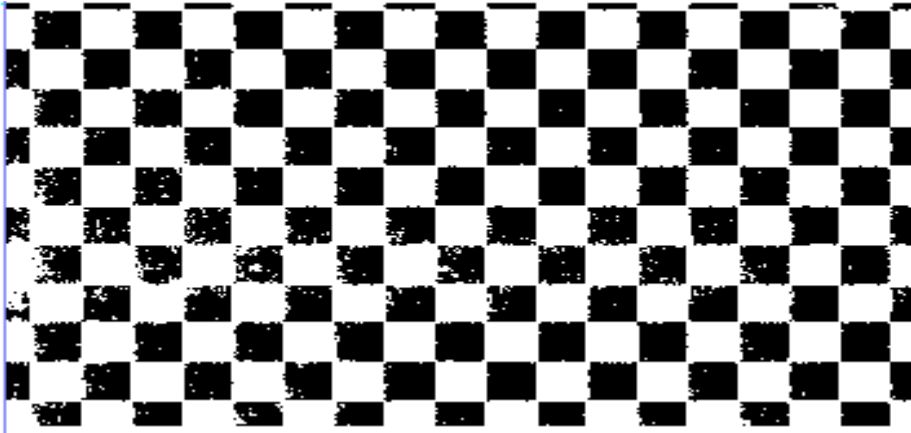
1. Check that the media is installed correctly and the plotter lid is securely closed. The top of the lid should be flush with the top of the side panels.
2. If the plot is fading on one side, test by pressing down on that side of the lid while the plotter is plotting. If this helps, the latch pin needs to be adjusted on that side. Contact your authorized service center.

Plot contrast is weak

Possible causes:

- Lid is not securely closed
- Latch pins need adjustment
- Media setting is incorrect
- Contrast setting is too low
- 24 V power supply is malfunctioning

Solutions:

1. Check that the media is installed correctly and the plotter lid is securely closed. The top of the lid should be flush with the top of the side panels.
2. If the lid does not close securely, or if the head pressure is too low, contact your authorized service center.
3. Check that the media setting is correct. See Chapter 4, page 4-8.
4. Adjust the contrast setting as described in Chapter 4, page 4-6.

Plot has black vertical lines

Figure 7-6 . Plot with black vertical lines

Possible Cause: One or more bits in each byte going to the plotter are “stuck high”.

Solution:

1. If your plotted output from the host shows these lines, run a test plot. If the lines are not present on the test plot, the problem originates with the host data. Check the interface data cable from the host and replace it if necessary.

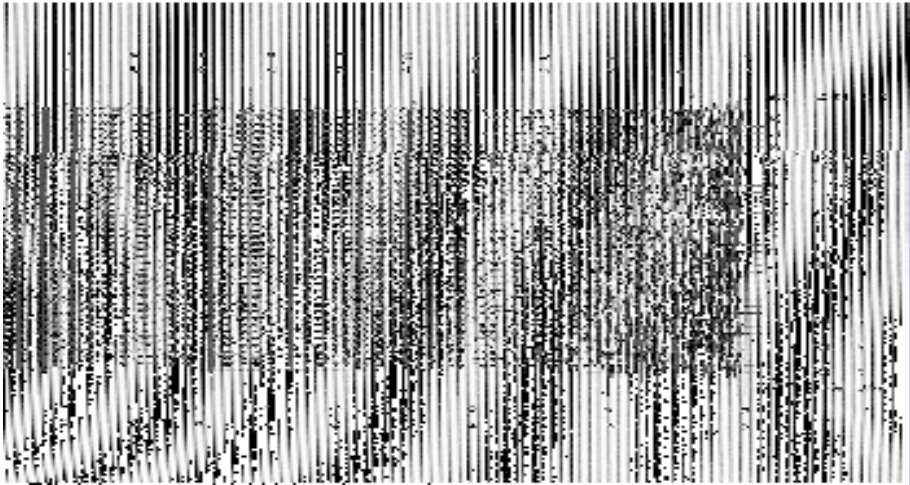
Plot is wrong length

If you suspect that a plot is the wrong length, plot a job of a known length and measure it.

Possible causes: Paper is not moving freely
Scaling is incorrectly applied
Vertical emulation is incorrectly applied

Solutions:

1. Check the media feed path. Ensure that the paper is installed correctly and that the paper feed is not obstructed.
2. Adjust or reset the scaling setting as described in Chapter 4, Operation.
3. Determine if your data requires vertical emulation and adjust the vertical resolution setting appropriately. See “Emulation” in Chapter 4, Page 4-10.

Paper is wrinkling or tearing along one edge

Possible causes: Paper feed is misaligned
Paper is incorrectly installed
Lid is not securely closed
Latch pins need adjustment

Solutions:

1. Ensure that paper is correctly aligned while feeding. If using fan-fold paper, you may wish to leave the paper in the box.
2. Check that the paper is installed correctly (see “Media Installation” in Chapter 3, Installation) and the plotter lid is securely closed. The top of the lid should be flush with the top of the side panels.

3. If the lid does not close securely, or if the head pressure is too low, contact your authorized service center.

Plotter has no power

Possible Cause: If the plotter is plugged in to a functioning outlet, then the AC fuse has blown.

Solution:

1. Replace the fuse as described in Chapter 6.

Plotter display is functioning but motor does not function

Possible Cause: Either the 5 V or 24 V power supply is malfunctioning.

Solution:

1. Contact your authorized service center.

Can't make changes to control panel settings

Possible Cause: Plotter is in ONLINE mode.

Solution:

1. Press the ON/OFFLINE button.

Plot output speed is erratic

Possible Cause: Plotter speed is set too high. This is most likely to occur on the HIGH setting. Lowering the plot speed enables the plotter to match the rate of data and produces a more steady output.

Solution:

1. Lower the plot speed setting on the control panel as described in Chapter 4, Page 4-7.

Burning smell during plot, or "blooming" present on output

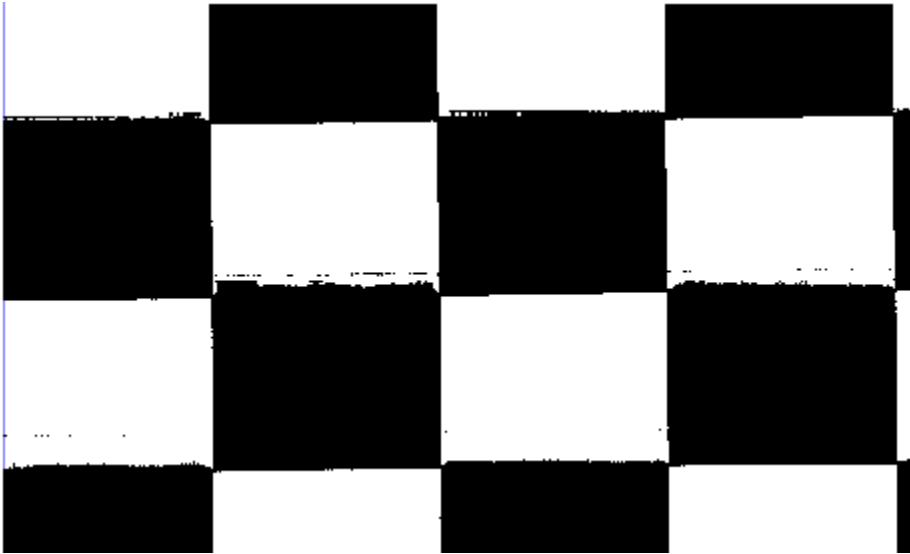

Figure 7-7 . "Blooming" plot

Possible Cause: Media setting is incorrect. The thermal printhead operating temperature is too high and is burning the media.

Solution:

1. Change the media setting on the control panel as described in Chapter 4. If unsure of the media specifications, start at the LT PAPER setting and then increase the setting, testing plot output after each change.

CAUTION: Thermal plotting technology involves high temperatures. Incorrect media or contrast settings can damage the printhead or other components and void the warranty. Media damage can also occur.

VORSICHT: Bei der thermischen Plottertechnologie entstehen hohe Temperaturen. Ungeeignete Medien oder falsche Kontrasteinstellungen können den Druckkopf oder andere Bauteile beschädigen und zu Verlust der Garantie führen. Auch können Beschädigungen an den Medien entstehen.

Form feed stops before desired length

Possible Cause: The form feed length is too short. The form feed stops before the paper sensor can read the “top of form” mark.

Solution:

1. Adjust the FFLENGTH setting on the control panel as described in Chapter 4, Page 4-10.

Form feed does not stop at top-of-form marks

Possible Cause: The top-of-form sensor is not reading the marks.

Solution:

1. Contact your authorized service center.

Plot is skewed or unreadable

Figure 7-8 . Skewed plot

Possible Cause: The scan width is incorrect.

Solution:

1. Adjust the scan width (byte count) in your host software to 216 bytes or less.

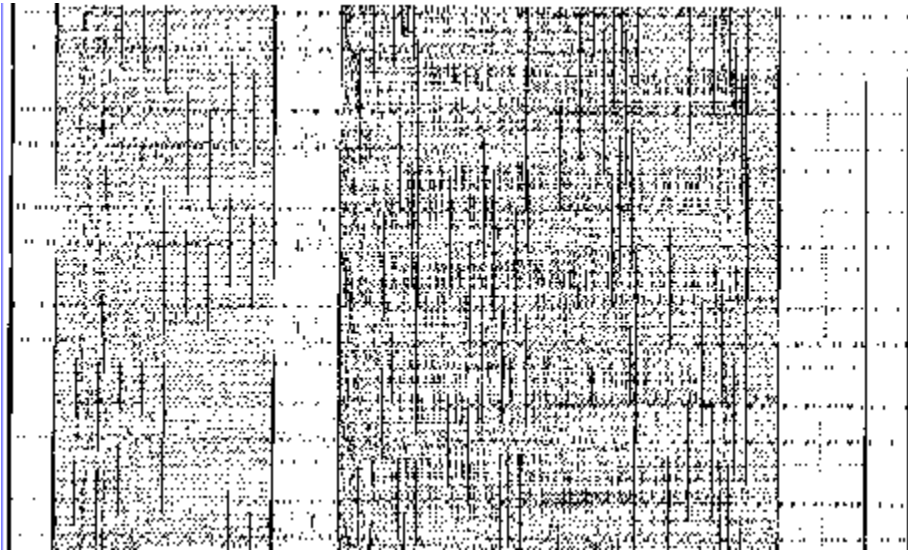
The Imaging Systems Group Inc. (iSys) warrants our V8.5e plotters to be free from defects in materials and workmanship as follows:

- Labour and parts are warranted for a period of one (1) year from the date of purchase.
- This warranty applies only to products purchased from an authorized dealer or agent, and extends only to the original retailer purchaser.
- This warranty only covers defects arising under normal usage within the duty cycles per specifications, and does not cover malfunction or failures resulting from misuse, abuse or neglect.
- Consumable accessories are not included in this warranty.
- iSys will extend to customers during the warranty period a Hot Swap Program to further expedite warranty repair.

Hot Swap warranty is one (1) year for the V8.5e Thermal Plotter. During the warranty period, iSys will exchange the plotter within 24 Hours (North America ONLY) free of charge to the customer. Included with the thermal plotter will be an RMA Kit, which will include all of the paper work needed to ship the defective plotter back to iSys, at our expense. Hot Swap warranty is based on availability. After the warranty has expired on the V8.5e Thermal Plotter, the same service will be available at an established monthly rate. Please call us for details and pricing.

TERMS and CONDITIONS of Hot Swap and Post Hot Swap

a) The product **MUST** be returned in the original or proper packing material including any anti-static packaging. Any products damaged in shipping due to inadequate packing will not be accepted by iSys. The return must arrive at iSys within 14 days from receipt of the RMA Kit. If these policies are violated, the customer will be responsible for payment of the purchase price on the product.

b) Warranty from the manufacturer and warranty from iSys will be null and void if it is discovered that the product is not functional due to neglect or unauthorized personnel tampering with the hardware.

A S C I I T A B L E S

MSN: Most significant nibble

LSN: Least significant nibble

		LSN														
MSN	0	1	2	3	4	5	6	7	8	9	A	B	C	D	E	F
2		!	"	#	\$	%	&	'	()	*	+	,	-	.	/	
3	0	1	2	3	4	5	6	7	8	9	:	;	<	=	>	?
4	@	A	B	C	D	E	F	G	H	I	J	K	L	M	N	O
5	P	Q	R	S	T	U	V	W	X	Y	Z	[\]	^	-
6	`	a	b	c	d	e	f	g	h	i	j	k	l	m	n	o
7	p	q	r	s	t	u	v	w	x	y	z	{		}	~	VS

Table A-1. Normal ASCII character set

		LSN														
MSN	0	1	2	3	4	5	6	7	8	9	A	B	C	D	E	F
0					EOT						LF		FF	CR		

Table A-2. ASCII control code character set

INTERFACE CONNECTOR PIN ASSIGNMENT

Signal Pin	Return Pin	Signal Name	Mnemonic
1	20	Input Bit 1 (LSB)	IND1
2	21	Input Bit 2	IND2
3	22	Input Bit 3	IND3
4	23	Input Bit 4	IND4
5	24	Input Bit 5	IND5
6	25	Input Bit 6	IND6
7	26	Input Bit 7	IND7
8	27	Input Bit 8 (MSB)	IND8
9	28	Clear	<u>CLEAR</u>
10	29	Parallel Input Clock	PICKL
11	30	Ready	<u>READY</u>
12	31	Print	PRINT
13		Not Connected	NC
14	33	Simultaneous Plot/Print	<u>SPP</u>
15	34	Remote Reset	<u>RESET</u>
16	35	Remote Form Feed	<u>RFFED</u>
17	36	Remote End of Transmit	<u>REOTR</u>
18	37	Remote Line Terminate	<u>RLTER</u>
19	37	No Paper	NOPAP
32	37	Online	<u>ONLIN</u>

Table B-1. Versatec cable pin outs (straight through)

Pin	Signal	Pin	Signal
1	STROBE	14	AFXT
2	DATA 0	15	ERROR
3	DATA 1	16	RESET
4	DATA 2	17	SLCTIN
5	DATA 3	18	GND
6	DATA 4	19	GND
7	DATA 5	20	GND
8	DATA 6	21	GND
9	DATA 7	22	GND
10	ACK	23	GND
11	BUSY	24	GND
12	PE	25	GND
13	SLCTOUT		

Table B-2. Centronics cable pin outs (straight through)

CENTRONICS INTERFACE BOARD

The new Centronics adapter (rev1-2) implements some improvements over the previous (rev1-1) adapter card. These include:

- a) Rev 1-2 cards will accept either of the two data transfer methods described below automatically; no switches or jumpers required.
- b) Reliable data transfers using up to 40 ft length of shielded cable.
- c) Rev 1-1 adapter cards exhibit inconsistent data transfer with newer generation PC.'s equipped with high speed integrated Centronics parallel ports.

The following are two transfer formats that can be used with the optional V8.5E Centronics parallel adapter:

1.) Standard transfer format

To place the V8.5E Centronics adapter in raster mode, the following 3 bytes (hex) must be sent to the Centronics adapter card:

1B, 2A, 00

Once these 3 bytes are sent, rastered plot data can be sent to the plotter as follows:

V8.5E bytes/scan menu setting	bytes/scan raster data
b1	216
b2	264
g1-g4	1728

Specifying XX YY at values greater than those indicated will cause the V8.5E to terminate scans incorrectly.

3.) 1B 4X and control characters

Other commands that can be sent to the V8.5E Centronics adapter:

1B 41	remote clear
1B 42	remote line terminate
1B 43	remote end of transmission
1B 44	remote form feed
1B 45	remote reset
1B 50 ZZ	sends blank scans to plotter from ZZ = 01 hex to FF hex

NOTE: These commands must be sent when the plotter is in print mode. The commands will be ignored and interpreted as raster data if they are sent at any other time.

The V8.5E plotter also obeys standard control characters which must be sent when the plotter is in print mode:

04	end of transmission
0A	line feed
0C	form feed

NOTE: print mode on the V8.5E means that all bytes that are received by the plotter are interpreted as ASCII characters and printed at 108 characters/line.

Free Manuals Download Website

<http://myh66.com>

<http://usermanuals.us>

<http://www.somanuals.com>

<http://www.4manuals.cc>

<http://www.manual-lib.com>

<http://www.404manual.com>

<http://www.luxmanual.com>

<http://aubethermostatmanual.com>

Golf course search by state

<http://golfingnear.com>

Email search by domain

<http://emailbydomain.com>

Auto manuals search

<http://auto.somanuals.com>

TV manuals search

<http://tv.somanuals.com>