

Océ | Operation Guide

English Version



Océ WP36/50

Operation Guide



**Please read the Operation Guide before using the printer.
Keep it close to the printer for easy reference.**

The sections of this guide and parts of the printer marked with symbols are safety warnings meant to protect the user, other individuals and surrounding objects, and ensure correct and safe usage of the printer. The symbols and their meanings are indicated below.

⚠ WARNING: Indicates that serious injury or even death may result from insufficient attention to or incorrect compliance with the related points.

⚠ CAUTION: Indicates that personal injury or mechanical damage may result from insufficient attention to or incorrect compliance with the related points.

Symbols

The \triangle symbol indicates that the related section includes safety warnings. Specific points of attention are indicated inside the symbol.



..... [General warning]



..... [Warning of danger of electrical shock]



..... [Warning of high temperature]

The \otimes symbol indicates that the related section includes information on prohibited actions. Specifics of the prohibited action are indicated inside the symbol.



..... [Warning of prohibited action]



..... [Disassembly prohibited]

The \bullet symbol indicates that the related section includes information on actions which must be performed. Specifics of the required action are indicated inside the symbol.



..... [Alert of required action]



..... [Remove the power plug from the outlet]



..... [Always connect the printer to an outlet with a ground connection]

Please contact your service representative to order a replacement if the safety warnings in the guide are illegible or if the guide itself is missing. (fee required)

Caution

No liability is assumed for any damage caused by improper installation.

Notice on Software

Software used with this printer must support the printer's emulation mode. The printer is factory-set to emulate the PCL. The emulation mode can be changed by following the procedures described in *Chapter 3*.

Notice

The information in this guide is subject to change without notification. Additional pages may be inserted in future editions. The user is asked to excuse any technical inaccuracies or typographical errors in the present edition.

No responsibility is assumed if accidents occur while the user is following the instructions in this guide. No responsibility is assumed for defects in the printer's firmware (contents of its read-only memory).

This guide, any copyrightable subject matter sold or provided with or in connection with the sale of the page printer, are protected by copyright. All rights are reserved. Copying or other reproduction of all or part of this guide, any copyrightable subject matter without the prior written consent of Kyocera Corporation is prohibited. Any copies made of all or part of this guide, any copyrightable subject matter must contain the same copyright notice as the material from which the copying is done.

Regarding Trademarks

PRESCRIBE is a registered trademark of Kyocera Corporation. KPDL and KIR (Kyocera Image Refinement) are trademarks of Kyocera Corporation.

Diablo 630 is a product of Xerox Corporation. IBM Proprinter X24E is a product of International Business Machines Corporation. Epson LQ-850 is a product of Seiko Epson Corporation.

Hewlett-Packard, PCL, and PJJ are registered trademarks of Hewlett-Packard Company. Centronics is a trade name of Centronics Data Computer Inc. PostScript is a registered trademark of Adobe Systems Incorporated. Macintosh is a registered trademark of Apple computer, Inc. Microsoft, Windows, and Windows NT are registered trademarks of Microsoft Corporation. PowerPC is trademark of International Business Machines Corporation. CompactFlash is a trademark of SanDisk Corporation. ENERGY STAR is a U.S. registered mark. All other brand and product names are registered trademarks or trademarks of their respective companies.

This Kyocera Mita page printer uses PeerlessPrintXL to provide the HP LaserJet compatible PCL 6 language emulation. PeerlessPrintXL is a trademark of The Peerless Group, Redondo Beach, CA 90278, U.S.A.

This product was developed using the Tornado™ Real Time Operating System and Tools from Wind River Systems.

AGFA  This printer contains UFST™ and MicroType® from Agfa Corporation.

IBM program license agreement

The device you have purchased contains one or more software programs ("programs") which belong to international business machines corporation ("IBM"). This document defines the terms and conditions under which the software is being licensed to you by IBM. If you do not agree with the terms and conditions of this license, then within 14 days after your acquisition of the device you may return the device for a full refund. If you do not so return the device within the 14 days, then you will be assumed to have agreed to these terms and conditions.

The Programs are licensed not sold. IBM, or the applicable IBM country organization, grants you a license for the Programs only in the country where you acquired the Programs. You obtain no rights other than those granted you under this license.

The term "Programs" means the original and all whole or partial copies of it, including modified copies or portions merged into other programs. IBM retains title to the Programs. IBM owns, or has licensed from the owner, copyrights in the Programs.

1. License

Under this license, you may use the Programs only with the device on which they are installed and transfer possession of the Programs and the device to another party.

If you transfer the Programs, you must transfer a copy of this license and any other documentation to the other party. Your license is then terminated. The other party agrees to these terms and conditions by its first use of the Program.

You may not:

- 1) use, copy, modify, merge, or transfer copies of the Program except as provided in this license;
- 2) reverse assemble or reverse compile the Program; or
- 3) sublicense, rent, lease, or assign the Program.

2. Limited Warranty

The Programs are provided "AS IS."

There are no other warranties covering the programs (or conditions), express or implied, including, but not limited to, the implied warranties of merchantability and fitness for a particular purpose.

Some jurisdictions do not allow the exclusion of implied warranties, so the above exclusion may not apply to you.

3. Limitation of Remedies

IBM's entire liability under this license is the following:

- 1) For any claim (including fundamental breach), in any form, related in any way to this license, IBM's liability will be for actual damages only and will be limited to the greater of:
 - a) the equivalent of U.S.\$25,000 in your local currency; or
 - b) IBM's then generally available license fee for the Program

This limitation will not apply to claims for bodily injury or damages to real or tangible personal property for which IBM is legally liable.

IBM will not be liable for any lost profits, lost savings, or any incidental damages or other economic consequential damages, even if IBM, or its authorized supplier, has been advised of the possibility of such damages. IBM will not be liable for any damages claimed by you based on any third party claim. This limitation of remedies also applies to any developer of Programs supplied to IBM. IBM's and the developer's limitations of remedies are not cumulative. Such a developer is an intended beneficiary of this Section. Some jurisdictions do not allow these limitations or exclusions, so they may not apply to you.

4. General

You may terminate your license at any time. IBM may terminate your license if you fail to comply with the terms and conditions of this license. In either event, you must destroy all your copies of the Program. You are responsible for payment of any taxes, including personal property taxes, resulting from this license. Neither party may bring an action, regardless of form, more than two years after the cause of action arose. If you acquired the Program in the United States, this license is governed by the laws of the State of New York. If you acquired the Program in Canada, this license is governed by the laws of the Province of Ontario. Otherwise, this license is governed by the laws of the country in which you acquired the Program.

Typeface Trademark Acknowledgement

All resident fonts in this printer are licensed from Agfa Corporation.

Helvetica, Palatino and Times are registered trademarks of Linotype-Hell AG.

ITC Avant Garde Gothic, ITC Bookman, ITC ZapfChancery and ITC Zapf Dingbats are registered trademarks of International Typeface Corporation.

Agfa Japan License Agreement

1. "Software" shall mean the digitally encoded, machine readable, scalable outline data as encoded in a special format as well as the UFST Software.
2. You agree to accept a non-exclusive license to use the Software to reproduce and display weights, styles and versions of letters, numerals, characters and symbols ("Typefaces") solely for your own customary business or personal purposes at the address stated on the registration card you return to Agfa Japan. Under the terms of this License Agreement, you have the right to use the Fonts on up to three printers. If you need to have access to the fonts on more than three printers, you need to acquire a multi-user license agreement which can be obtained from Agfa Japan. Agfa Japan retains all rights, title and interest to the Software and Typefaces and no rights are granted to you other than a License to use the Software on the terms expressly set forth in this Agreement.
3. To protect proprietary rights of Agfa Japan, you agree to maintain the Software and other proprietary information concerning the Typefaces in strict confidence and to establish reasonable procedures regulating access to and use of the Software and Typefaces.

4. You agree not to duplicate or copy the Software or Typefaces, except that you may make one backup copy. You agree that any such copy shall contain the same proprietary notices as those appearing on the original.
5. This License shall continue until the last use of the Software and Typefaces, unless sooner terminated. This License may be terminated by Agfa Japan if you fail to comply with the terms of this License and such failure is not remedied within thirty (30) days after notice from Agfa Japan. When this License expires or is terminated, you shall either return to Agfa Japan or destroy all copies of the Software and Typefaces and documentation as requested.
6. You agree that you will not modify, alter, disassemble, decrypt, reverse engineer or decompile the Software.
7. Agfa Japan warrants that for ninety (90) days after delivery, the Software will perform in accordance with Agfa Japan-published specifications, and the diskette will be free from defects in material and workmanship. Agfa Japan does not warrant that the Software is free from all bugs, errors or omissions.

The parties agree that all other warranties, expressed or implied, including warranties of fitness for a particular purpose and merchantability, are excluded.
8. Your exclusive remedy and the sole liability of Agfa Japan in connection with the Software and Typefaces is repair or replacement of defective parts, upon their return to Agfa Japan.

In no event will Agfa Japan be liable for lost profits, lost data, or any other incidental or consequential damages, or any damages caused by abuse or misapplication of the software and Typefaces.
9. New York, U.S.A. law governs this Agreement.
10. You shall not sublicense, sell, lease, or otherwise transfer the Software and/or Typefaces without the prior written consent of Agfa Japan.
11. Use, duplication or disclosure by the Government is subject to restrictions as set forth in the Rights in Technical Data and Computer Software clause at FAR 252-227-7013, subdivision (b)(3)(ii) or subparagraph (c)(1)(ii), as appropriate. Further use, duplication or disclosure is subject to restrictions applicable to restricted rights software as set forth in FAR 52.227-19 (c)(2).
12. You acknowledge that you have read this agreement, understand it, and agree to be bound by its terms and conditions. Neither party shall be bound by any statement or representation not contained in this agreement. No change in this agreement is effective unless written and signed by properly authorized representatives of each party. By opening this diskette package, you agree to accept the terms and conditions of this agreement.

Contents

Contents	iv
-----------------------	-----------

Introduction	vi
---------------------------	-----------

1 For More Information.....	vi
2 Guide to the Operation Guide	vi

IMPORTANT! PLEASE READ FIRST	vii
---	------------

Chapter 1 Names of Parts	1-1
---------------------------------------	------------

Chapter 2 Handling Paper.....	2-1
--------------------------------------	------------

1 General Guidelines.....	2-1
1.1 Paper Availability.....	2-1
1.2 Paper Specifications	2-1
1.3 Selecting the Right Paper	2-2
2.1 Transparency (Overhead Projection Film)	2-4
2.2 Adhesive-Backed Labels.....	2-4
2 Special Paper	2-4
3 Paper Type.....	2-5
4 How to Load Paper.....	2-6
4.1 Loading Paper into the Paper Cassette	2-6
4.2 Loading Paper into the MP (Multi-Purpose) Tray	2-7
4.3 Setting Envelopes	2-8

Chapter 3 Using the Operator Panel	3-1
---	------------

1 Understanding the Operator Panel.....	3-1
1.2 Message Display	3-2
1.1 Operation Indicators.....	3-2
1.3 Interface Indicator	3-2
1.5 Paper Type Indicator.....	3-3
1.4 Paper Size Indicator.....	3-3
1.6 Keys	3-4
2 Using the Operator Panel.....	3-5
2.1 Menu Selection System	3-5
2.2.1 Printing the Menu Map	3-11
2.2 Using the Menu Selection System	3-11
2.2.2 Printing Status Page	3-11
2.2.3 e-MPS	3-12
2.2.4 Changing the Interface Parameters	3-19
2.2.5 Changing the Emulation.....	3-22
2.2.6 Setting the Default Font	3-24
2.2.7 Using Page Set Menus	3-27
2.2.8 Setting the Print Quality	3-31
2.2.9 Operating an Option Hard Disk.....	3-32
2.2.10 Operating the RAM Disk	3-35

2.2.11 Operating a Memory Card	3-37
2.2.12 Paper Handling	3-41
2.2.13 Other Modes	3-48

Chapter 4 Troubleshooting.....	4-1
---------------------------------------	------------

1 General Guide.....	4-1
2 Print Quality Problems	4-2
3.1 Indicators	4-4
3.2 Maintenance Messages.....	4-4
3 Indicators and Messages	4-4
3.3 Error Messages.....	4-6
4 Correcting a Paper Jam	4-8
4.2 Jam at the MP Tray.....	4-9
4.1 Jam in Paper Cassette.....	4-9
4.3 Jam inside the MP transport	4-9
4.4 Jam in Left Cover 1.....	4-11
4.6 Paper Jam at the Option Document Finisher.....	4-12
4.5 Jam in Left Cover 2.....	4-12

Chapter 5 Maintenance	5-1
------------------------------------	------------

1 Toner Container Replacement.....	5-1
1.1 Toner Container Replacement Interval.....	5-1
1.2 Replenishing Toner.....	5-1

Chapter 6 Fonts	6-1
------------------------------	------------

Appendix A Option Units	A-1
--------------------------------------	------------

1 Available Options	A-1
2.2 DF-71/73/75 Document Finishers	A-3
2.3 Network Interface.....	A-3
2 Installing Option Units	A-3
2.1 PF-70/75 Paper Feeders	A-3
2.5 Memory Card	A-4
2.4 Hard Disk	A-4
3.1 Notes on Handling the Main Circuit Board and DIMM	A-5
3.2 Removing the Main Circuit Board from the Printer	A-5
3 Removing the Main Circuit Board	A-5
4.1 Removing DIMM	A-6
4 Installing DIMMs.....	A-6
4.2 Testing the Expansion Memory	A-6

Appendix B Host Computer Interface..... B-1

1 Parallel Interface.....	B-1
1.1 Parallel Interface Communication Modes.....	B-1
1.2 Interface Signals.....	B-1
2 USB Interface	B-2
2.1 Specifications	B-2
2.2 Interface Signals.....	B-2
4 RS-232C Protocol.....	B-3
3 Serial Interface (Option)	B-3
3.1 RS-232C Interface.....	B-3
4.1 PRESCRIBE FRPO D0 command	B-4
5 RS-232C Cable Connection	B-4
5.1 Obtain a Suitable RS-232C Cable.....	B-4
5.2 Connecting the Printer to the Computer	B-4
5.3 Setting the RS-232C Parameters.....	B-5

Appendix C Specifications C-1**GlossaryGlossary-1****IndexIndex-1**

Introduction

The Kyocera Mita printer has many advanced features, such as the EcoPrint function that reduces the power consumption and the Auto Media Type Selection function that selects the media automatically before printing. If you install an optional document finisher to the printer, you can also make stitching.

This section explains the following topics:

- For More Information...
- Guide to the Operation Guide

1. For More Information...

Item	Description
Installation Guide (paper manual)	Describes procedures such as printer setup and printing a test page.
Operation Guide (this manual)	Guides you through topics concerning the operations and maintenance of the printer.
Printer Driver Guide	Describes how to install and set up the printer driver. This is contained in the latter half of this guide.
PRESCRIBE Commands Technical Reference	PRESCRIBE is the native language of the Kyocera Mita printers. This Technical Reference contains the information about how the printing is performed using the PRESCRIBE commands as well as the font and emulation description. Also included is a list of permanent parameters and their explanation needed when customizing your printer.
PRESCRIBE Commands Command Reference	Gives a detailed explanation of the PRESCRIBE command syntax and parameters.

2. Guide to the Operation Guide

This Operation Guide has the following chapters:

Chapter 1 Names of Parts

This chapter explains the name and function of each part of the printer.

Chapter 2 Handling Paper

This chapter explains the type of paper that can be used with this printer, and how to load paper into the paper cassette and MP tray.

Chapter 3 Using the Operator Panel

This chapter explains the message display, indicators and keys on the operator panel, and how to make various settings from the operator panel.

Chapter 4 Troubleshooting

This chapter explains how to handle printer problems that may occur, such as paper jams.

Chapter 5 Maintenance

This chapter explains how to replace the toner container, waste toner box, and how to care for your printer.

Chapter 6 Fonts

This appendix explains about fonts and lists the printer's internal fonts.

Appendix A Option Units

This appendix explains how to expand the printer's memory. This appendix introduces the available options for use with the printer.

Appendix B Host Computer Interface

This appendix explains the pin assignment and specifications for the printer's parallel interface and serial interface.

Appendix C Specifications

This appendix lists the printer's specifications.

Glossary

This glossary explains the terminology used in this manual.

Important! Please read first

Caution Labels

Caution labels have been attached to the printer at the following locations for safety purposes. BE SUFFICIENTLY CAREFUL to avoid fire or electric shock when removing a paper jam or when replacing toner.

Label 2

High temperature inside. Do not touch parts in this area, because there is a danger of getting burned.

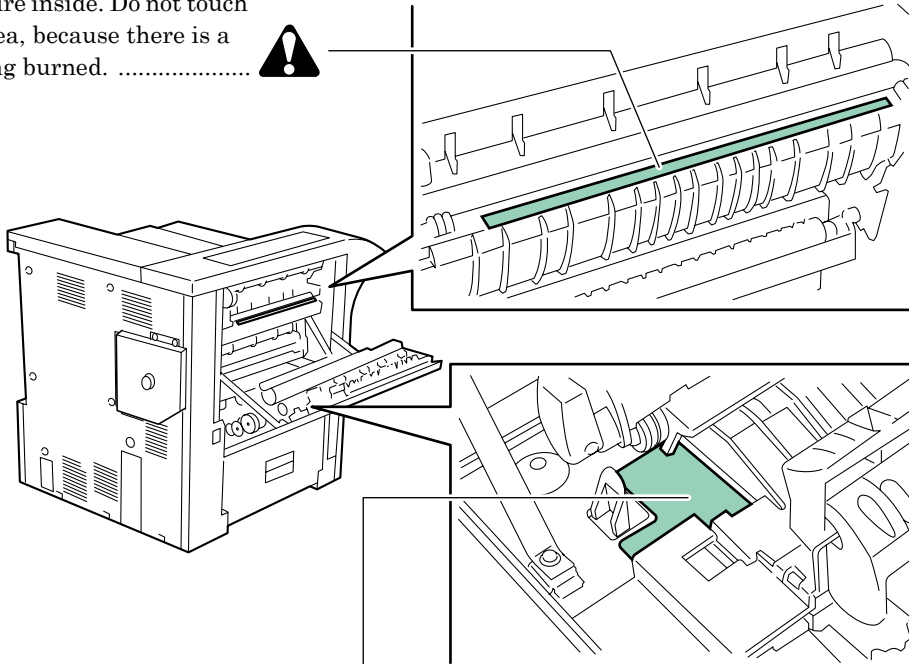

Label 1

High voltage inside. NEVER touch parts in this area, because there is a danger of electric shock.



Label 3

Do not incinerate toner and waste toner box. Dangerous sparks may cause burn.

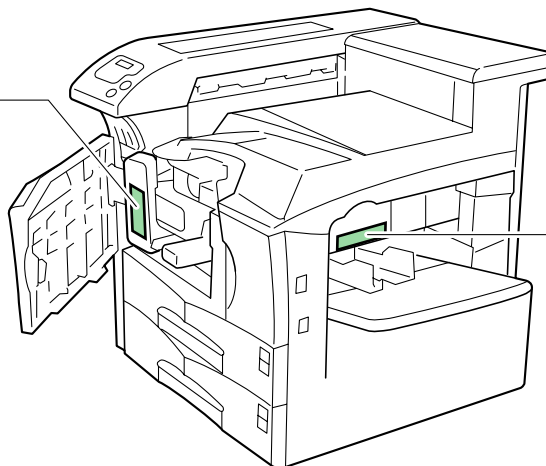

Label 4





Moving parts inside. May cause personal injury. Do not touch moving parts. ...





Installation Precautions

■ Environment

CAUTION

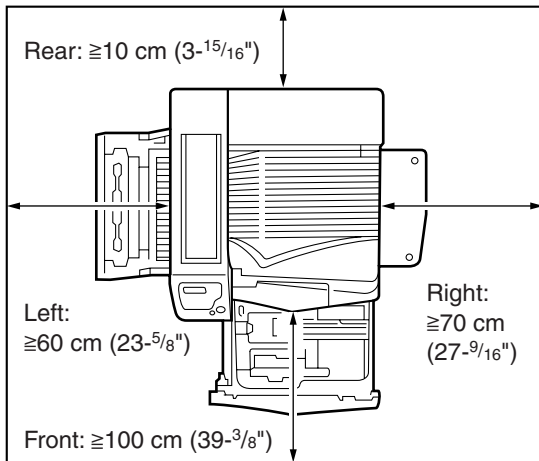
- Avoid placing the printer on or in locations which are unstable or not level. Such locations may cause the printer to fall down or fall over. This type of situation presents a danger of personal injury or damage to the printer. 
- Avoid locations with humidity or dust and dirt. If dust or dirt becomes attached to the power plug, clean the plug to avoid the danger of fire or electrical shock. 
- Avoid locations near radiators, heaters, or other heat sources, or locations near flammable items, to avoid the danger of fire. 
- To keep the printer cool and facilitate changing of parts and maintenance, allow access space as shown below. Leave adequate space, especially around the left cover, to allow air to be properly ventilated out of the printer. 





- Always use the caster stoppers to stabilize the printer once it is in place to keep it from moving and/or falling over and causing injury. 

Other Precautions

- Adverse environmental conditions may affect the safe operation and performance of the printer. Install in an air-conditioned room (recommended room temperature: around 20 °C, humidity: around 65 % RH) and avoid the following locations when selecting a site for the printer.
 - Avoid locations near a window or with exposure to direct sunlight.
 - Avoid locations with vibrations.
 - Avoid locations with drastic temperature fluctuations.
 - Avoid locations with direct exposure to hot or cold air.
 - Avoid poorly ventilated locations.
- When casters are installed on the printer, moving the printer can cause damage to certain floor surfaces.

■ Power Supply/Grounding the Printer

WARNING

- Do not use a power supply with a voltage other than that specified. Avoid multiple connections in the same outlet. These types of situations present a danger of fire or electrical shock. 
- Plug the power cord securely into the outlet. If metallic objects come in contact with the prongs on the plug, it may cause a fire or electric shock. 
- Always connect the printer to an outlet with a ground connection to avoid the danger of fire or electrical shock in case of an electric short. If ground connection is not possible, contact your service representative. 

Other Precautions

- Connect the power plug to the closest outlet possible to the printer.

■ Handling of Plastic Bags









WARNING

- Keep the plastic bags that are used with the printer away from children. The plastic may cling to their nose and mouth causing suffocation. 





Precautions for Use

■ Cautions when Using the Printer



WARNING

- Do not place metallic objects or containers with water (flower vases, flower pots, cups, etc.) on or near the printer. This type of situation presents a danger of fire or electrical shock should they fall inside. 
- Do not remove any of the covers from the printer as there is a danger of electrical shock from high voltage parts inside the printer. 
- Do not damage, break or attempt to repair the power cord. Do not place heavy objects on the cord, pull it, bend it unnecessarily or cause any other type of damage. These types of situations present a danger of fire or electrical shock. 
- Never attempt to repair or disassemble the printer or its parts as there is a danger of fire, electrical shock or damage to the laser. If the laser beam escapes, there is a danger of it causing blindness. 
- If the printer becomes excessively hot, smoke appears from the printer, there is an odd smell, or any other abnormal situation occurs, there is a danger of fire or electrical shock. Turn the power switch OFF (O) immediately, remove the power plug from the outlet and contact your service representative. 
- If anything harmful (paper clips, water, other fluids, etc.) falls into the printer, turn the power switch OFF (O) immediately. Next, remove the power plug from the outlet to avoid the danger of fire or electrical shock. Then contact your service representative. 
- Do not remove or connect the power plug with wet hands, as there is a danger of electrical shock. 
- Always contact your service representative for maintenance or repair of internal parts. 

CAUTION

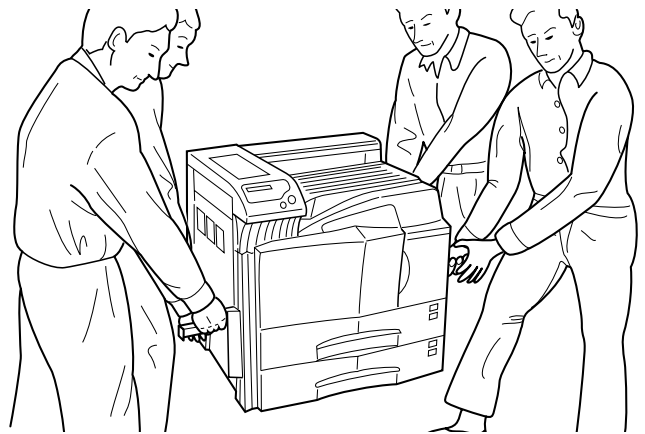
- Do not pull the power cord when removing it from the outlet. If the power cord is pulled, the wires may become broken and there is a danger of fire or electrical shock. (ALWAYS grasp the power plug when removing the power cord from the outlet.) 
- Always remove the power plug from the outlet when moving the printer. If the power cord is damaged, there is a danger of fire or electrical shock. 
- If the printer will not be used for a short period of time (overnight, etc.), turn the power switch OFF (O). If it will not be used for an extended period of time (vacations, etc.), remove the power plug from the outlet for safety purposes during the time the printer is not in use. 
- When lifting or moving the printer, pull up the 4 handles on both sides of the printer, then ALWAYS carry the printer by the designated 4 handles with at least 4 people, one person to a handle. 







- For safety purposes. Always remove the power plug from the outlet when performing cleaning operations. 
- If dust accumulates within the printer, there is a danger of fire or other trouble. It is therefore recommended that you consult with your service representative in regard to the cleaning of internal parts. This is particularly effective if accomplished prior to seasons of high humidity. Consult with your service representative in regard to the cost of cleaning the internal parts of the printer. 

Other Precautions

- Do not place heavy objects on the printer or cause other damage to the printer.
- Do not open the front cover, turn off the main switch, or pull out the power plug during printing.
- During printing, some ozone is released, but the amount does not cause any ill effect to one's health. If, however, the printer is used over a long period of time in a poorly ventilated room or when printing an extremely large number of copies, the smell may become unpleasant. To maintain the appropriate environment for print work, it is suggested that the room be properly ventilated.
- Do not touch electrical parts, such as connectors or printed circuit boards. They could be damaged by static electricity.
- Do not attempt to perform any operations not explained in this handbook.
- Caution: Use of controls or adjustments or performance of procedures other than those specified herein may result in hazardous radiation exposure.
- If the printer will not be used for an extended period of time, remove the paper from the cassette, return it to its original package and reseal it.

■ Cautions for Toner Handling

▲ CAUTION

- Do not incinerate toner and toner containers. Dangerous sparks may cause burn. 
- Never open the toner container or waste toner box.. 
- Make sure not to inhale the toner, and not to rub your eyes or touch your mouth with the hands stained with the toner. And make sure not to stick to your skin. 
- For the disposal of old toner container and waste toner box, consult your dealer. Or dispose of the toner or toner containers in accordance with Federal, state and Local rules and regulations. 
- Keep the toner container and the waste toner box away from children. 

Chapter 1

Names of Parts

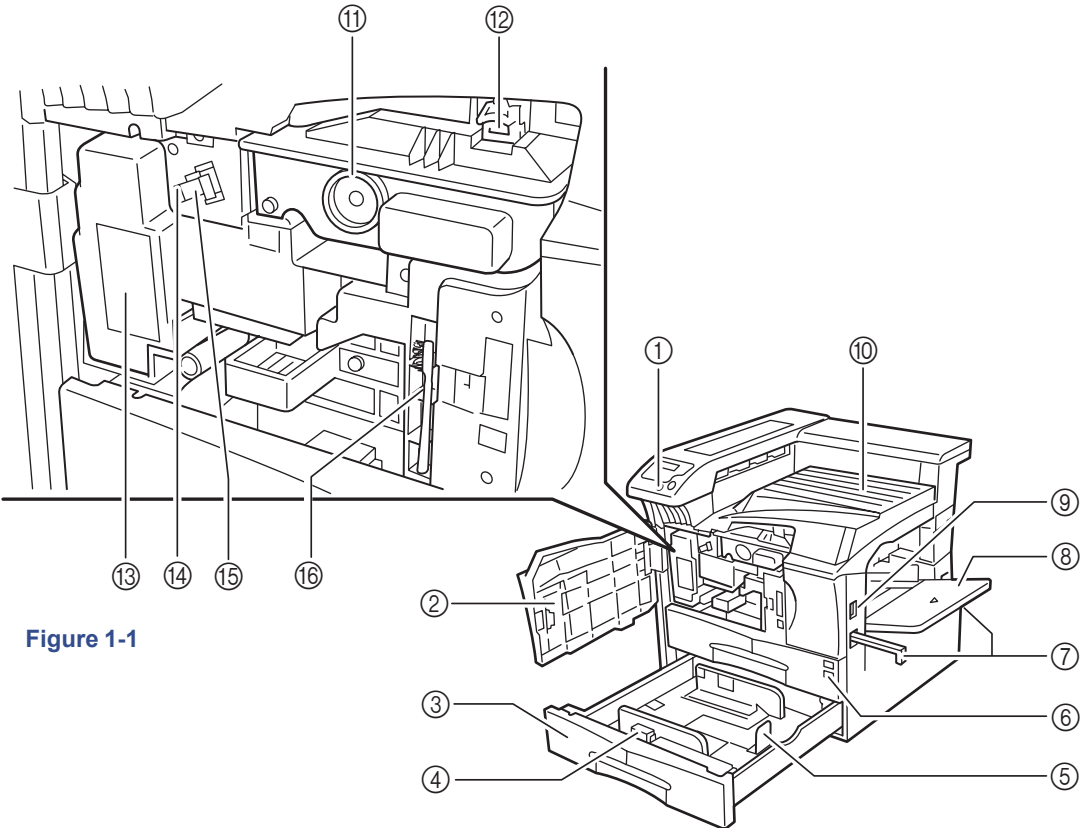

Figure 1-1

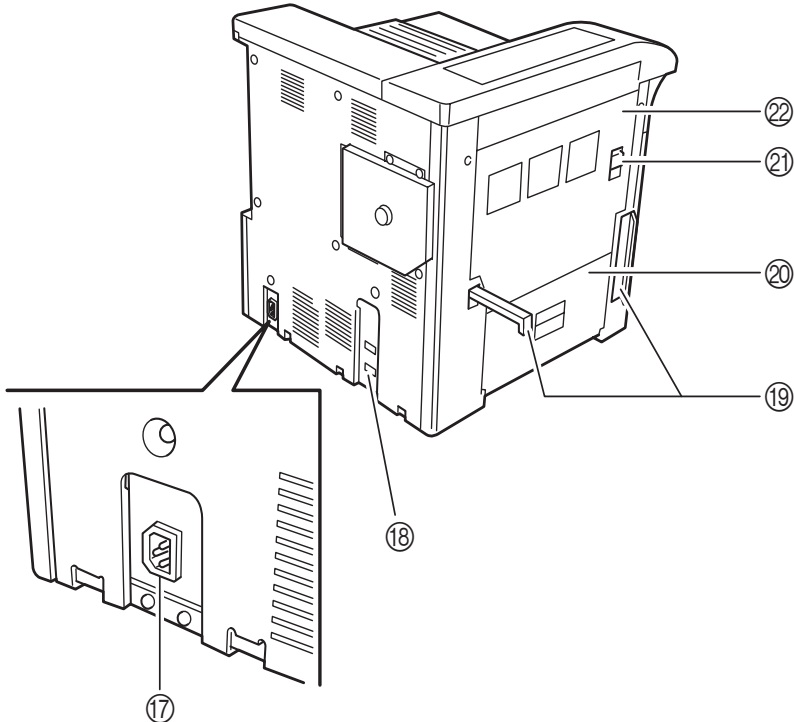

Figure 1-2

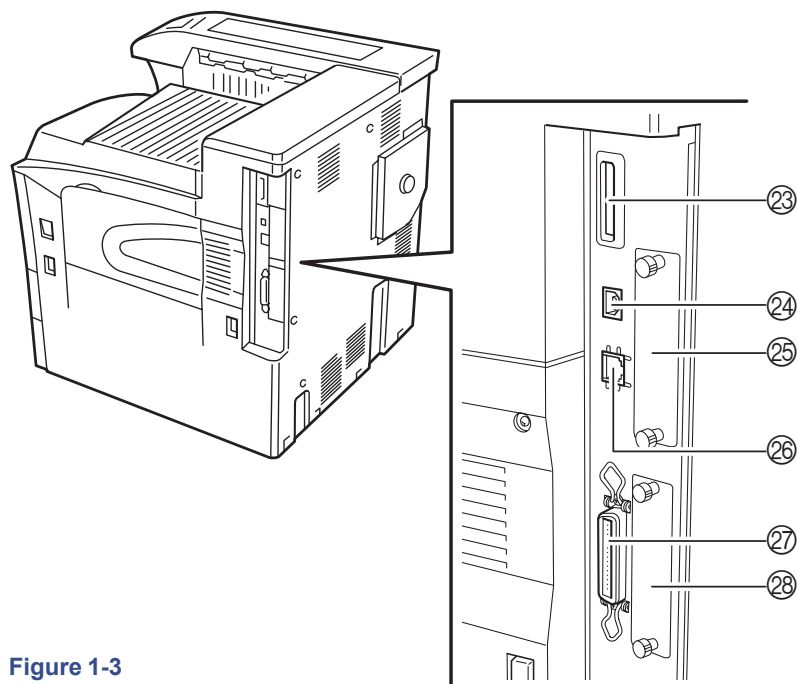

Figure 1-3

- ① **Operator panel**
Contains the keys and indicators for operating the printer.
- ② **Front cover**
Open to replace the toner container or waste toner box.
- ③ **Paper cassette 2**
Second cassette that holds up to about 500 sheets of standard paper.
- ④ **Paper guide**
Adjust to the length of the paper to be set in the paper cassette.
- ⑤ **Paper stopper**
Hold the lever and adjust the paper guide to the width of the paper to be set in the paper cassette.
- ⑥ **Paper cassette 1**
First cassette that holds up to about 500 sheets of standard paper.
- ⑦ **Handles for transport**
These handles must be held by at least 4 persons when lifting or moving the printer.
- ⑧ **MP (Multi-Purpose) tray**
Load paper here when printing onto small-size or special paper.
- ⑨ **Main switch**
Turn ON (I) before starting to print.
- ⑩ **Top tray**
Printed paper is stored here.
- ⑪ **Toner container**
- ⑫ **Toner container release lever**
Operate to replace the toner container.
- ⑬ **Waste toner box**
Waste toner is collected.
- ⑭ **Cleaning knob**
Pull and push back in after toner container replacement or when print images become soiled with toner.
- ⑮ **Main charger unit**
When replacing the toner container, install the grid cleaner to clean the grid.
- ⑯ **Cleaning brush**
Used to clean the internal part of the printer.
- ⑰ **Power cord connector**
- ⑱ **Option unit connector**
When using the option device, connect its cable to this connector.
- ⑲ **Handles for transport**
These handles must be held by at least 4 persons when lifting or moving the printer.
- ⑳ **Left cover 2**
Open when a paper jam occurs inside the left cover 2.
- ㉑ **Lock lever**
Pull up to open the left cover 1.
- ㉒ **Left cover 1**
Open when a paper jam occurs.
- ㉓ **Memory card slot**
- ㉔ **USB cable connector**
Connect the USB cable to this connector for USB printing.
- ㉕ **Optional network interface card slot (OPT)**
For optional network interface card.
- ㉖ **Network cable connector**
Connect the network cable to this connector for network printing.
- ㉗ **Parallel cable connector**
Connect the parallel cable to this connector for parallel printing.
- ㉘ **Optional hard disk unit slot (HDD)**
For optional hard disk unit.

Chapter 2 Handling Paper

This chapter explains the following topics:

- General Guidelines
- Special Paper
- Paper Type
- How to Load Paper

1. General Guidelines

The printer is designed to print on high-quality copier bond paper (the kind used in ordinary dry copier machines), but it can also accept a variety of other types of paper within the limits specified below.

NOTE

The manufacturer assumes no liability for problems that occur when paper not satisfying these requirements is used.

Selection of the right paper is important. Using the wrong paper can result in paper jams, misfeeding, curling, poor print quality, and paper waste, and in extreme cases can damage the printer. The guidelines given below will increase the productivity of your office by ensuring efficient, trouble-free printing and reducing wear and tear on the printer.

1.1 Paper Availability

Most types of paper are compatible with a variety of machines. Paper intended for xerographic copiers can also be used with the printer.

There are three general grades of paper: economy, standard, and premium. The most significant difference between grades is the ease with which they pass through the printer. This is affected by the smoothness, size, and moisture content of the paper, and the way in which the paper is cut. The higher the grade of paper you use, the less risk there will be of paper jams and other problems, and the higher the level of quality your printed output will reflect.

Differences between paper from different suppliers can also affect the printer's performance. A high-quality printer cannot produce high-quality results when the wrong paper is used. Low-priced paper is not economical in the long run if it causes printing problems.

Paper in each grade is available in a range of basis weights (defined later). The traditional standard weights are 16, 20, and 28 pounds (60 to 105 g/m²).

1.2 Paper Specifications

The following table summarizes the basic paper specifications. Details are given on the following pages.

Item	Specification
Weight	Cassette: 60 to 105 g/m ² (16 to 28 lb/ream) MP tray: 60 to 200 g/m ² (16 to 53 lb/ream)
Thickness	0.086 to 0.110 mm (3.4 to 4.3 mils)
Dimensional accuracy	±0.7 mm (±0.0276 inches)
Squareness of corners	90° ±0.2°
Moisture content	4 to 6 %
Direction of grain	Long grain
Pulp content	80 % or more

Table 2-1

Minimum and maximum paper sizes

The minimum and maximum paper sizes are as follows. For non standard paper such as cut-sheet, the MP (multi-purpose) tray must be used.

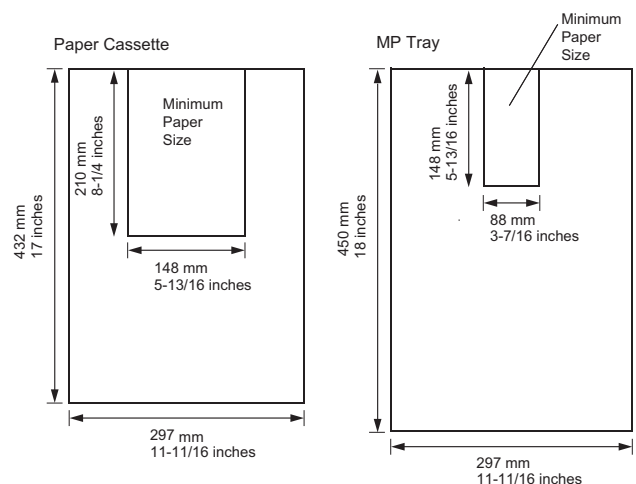

Figure 2-1

1.3 Selecting the Right Paper

Laser printing is a process involving laser light, electrostatic discharge, toner, and heat. In addition, as the paper passes through the printer it undergoes considerable sliding, bending, and twisting motions. A high-quality printing paper matching the printer's requirements withstands all these stresses, enabling the printer to turn out clean, crisp printed copies consistently.

Remember that all paper is not the same. Some of the factors to consider when selecting paper for the printer are as follows:

Condition of the Paper

Avoid using paper that is bent at the edges, curled, dirty, torn, embossed, or contaminated with lint, clay, or paper shreds.

Use of paper in these conditions can lead to illegible printing, misfeeding, and paper jams, and can shorten the life of the printer. In particular, avoid using paper with a surface coating or other surface treatment. The paper should have as smooth and even a surface as possible.

Composition

Do not use paper that has been coated or surface-treated and contains plastic or carbon. The heat of fusing can cause such paper to give off harmful fumes.

Bond paper should contain at least 80 % pulp. Not more than 20 % of the total paper content should consist of cotton or other fibers.

Paper Size

Cassettes and an MP tray are available for the paper sizes listed in the table below. The dimensional tolerances are ± 0.7 mm (± 0.0276 inches) for the length and width. The angle at the corners must be $90^\circ \pm 0.2^\circ$.

MP tray	Size
Monarch	3-7/8 × 7-1/2 inches
Business	4-1/8 × 9-1/2 inches
Commercial 9	3-7/8 × 8-7/8 inches
Commercial 6-3/4	3-5/8 × 6-1/2 inches
International DL	11 × 22 cm
International C5	16.2 × 22.9 cm
ISO A6	105 × 148 mm
JIS B6	128 × 182 mm
International B5	17.6 × 25 cm
Executive	7-1/4 × 10-1/2 inches
International C4	229 × 324 mm
Oficio II	8-1/2 × 13 inches
Hagaki	100 × 148 mm
Oufuku Hagaki	148 × 200 mm
Youkei 2	114 × 162 mm
Youkei 4	105 × 235 mm
8K	273 × 394 mm
16K	197 × 273 mm

Table 2-2

Cassette or MP tray	Size
Ledger	11 × 17 inches
Legal	8-1/2 × 14 inches
Letter	8-1/2 × 11 inches
Statement	5-1/2 × 8-1/2 inches
Folio	210 × 330 mm
ISO A3	297 × 420 mm
ISO A4	210 × 297 mm
ISO A5	148 × 210 mm
JIS B4	257 × 364 mm
JIS B5	182 × 257 mm

Table 2-3

Paper with other sizes (custom sizes) can also be fed from the MP tray. The minimum size paper for manual feed is 88 × 148 mm (3-1/2 × 5-13/16 inches), fed lengthwise. The maximum size is 297 × 450 mm (11-11/16 × 17-3/4 inches).

Smoothness

The paper should have a smooth, uncoated surface. Paper with a rough or sandy surface can cause voids in the printed output. Paper that is too smooth, however, can cause multiple feeding and fogging problems. (Fogging is a gray background effect.)

Basis Weight

Basis weight is the weight of a standard quantity of paper. In the traditional system, the standard quantity is a ream consisting of 500 sheets measuring 17 × 22 inches each. In the metric system the standard quantity is 1 square meter.

Paper that is too light or too heavy can cause misfeeding, jams, and premature wear of the printer. Uneven paper weight can cause multiple feeds, print defects, poor toner fusing, blurring, and other print quality problems. The proper weight is 60 to 105 g/m² for the paper cassette, and 60 to 200 g/m² for the MP tray.

Thickness (Caliper)

Thick paper is referred to as high-caliper paper and thin paper as low-caliper paper. The paper used with the printer should be neither extremely thick nor extremely thin. If you are having problems with paper jams, multiple feeds, and faint printing, the paper you are using may be too thin. If you are having problems with paper jams and blurred printing, the paper may be too thick. The proper thickness is 0.086 to 0.110 mm (3.4 to 4.3 mils).

Moisture Content

Moisture content is defined as the percent ratio of moisture to the dry mass of the paper. Moisture can affect the paper's appearance, feedability, curl, electrostatic properties, and toner fusing characteristics.

The moisture content of the paper varies with the relative humidity in the room. When the relative humidity is high and the paper absorbs moisture, the paper edges expand, becoming wavy in appearance. When the relative humidity is low and the paper loses moisture, the edges shrink and tighten, and print contrast may suffer.

Wavy or tight edges can cause misfeeding and alignment anomalies. The moisture content of the paper should be 4 to 6%. To ensure the proper moisture content, it is important to store the paper in a controlled environment. Some tips on moisture control are:

- Store paper in a cool, dry location.
- Keep the paper in its wrapping as long as possible. Rewrap paper that is not in use.
- Store paper in its original carton. Place a pallet, etc., under the carton to separate it from the floor.
- After removing paper from storage, let it stand in the same room as the printer for 48 hours before use.
- Avoid leaving paper where it is exposed to heat, sunlight, or damp.

Paper Grain

When paper is manufactured, it is cut into sheets with the grain running parallel to the length (long grain) or parallel to the width (short grain). Short grain paper can cause feeding problems in the printer. All paper used in the printer should be long grain.

Other Paper Properties

Porosity: Refers to the density of the paper structure; that is, how openly or compactly the fibers are bonded.

Stiffness: Limp paper can buckle inside the printer, while paper that is too stiff may bind. Either way the result is a paper jam.

Curl: Most paper has a natural tendency to curl in one direction. The paper should be loaded so that the natural curl is downward, to counteract the upward curl imparted by the printer. Printed sheets will then come out flat. Most paper also has a top and bottom surface. Loading instructions are usually given on the paper package.

NOTE

If the paper is considerably curled in one direction, e.g. when the paper was used to print on one side, try to roll the paper in the opposite direction to counteract the curl. Printed sheets will then come out flat.

Electrostatic properties: During the printing process, the paper is electrostatically charged to attract the toner. The paper must be able to release this charge so that printed sheets do not cling together in the output tray.

Whiteness: The contrast of the printed page depends on the whiteness of the paper. Whiter paper provides a sharper, brighter appearance.

Quality control: Uneven sheet size, corners that are not square, ragged edges, welded (uncut) sheets, and crushed edges and corners can cause the printer to malfunction in various ways. A quality paper supplier should take considerable care to ensure that these problems do not occur.

Packaging: Paper should be packed in a sturdy carton to protect it from damage during transport. Quality paper obtained from a reputable supplier is usually properly packaged.

2. Special Paper

This section explains printing on special paper. The page printer can use the following types of special paper. In this case, set the media type according to the table below.

Paper type to be used	Media type to be selected
Colored paper	Color
Preprinted paper	Preprinted
Overhead projector transparencies	Transparency
Postcards	Cardstock
Envelopes	Envelope
Label	Labels

Table 2-4

When using the above types of paper, be sure to use products that are specified for use with photocopiers and/or page printers. Feed paper other than colored paper or preprinted paper from the MP (multi-purpose) tray. Use paper that is sold specifically for use with copiers (heat-fusing type). Label paper and envelopes should not be placed in the cassette.

Since the composition and quality of special paper vary considerably, special paper is more likely than white bond paper to give trouble during printing. No liability will be assumed if moisture, etc., given off in printing on special paper causes harm to the machine or operator.

NOTE

Before purchasing any type of special paper, test a sample on the printer and check that print quality is satisfactory.

Specifications for each type of special paper are given below.

2.1 Transparency (Overhead Projection Film)

Transparency must be able to withstand the heat of fusing during the printing process. It should satisfy the conditions given in the table below.

Item	Specification
Tolerance of heat	Must tolerate at least 190 °C (374 °F)
Thickness	0.100 to 0.110 mm (3.9 to 4.3 mils)
Material	Polyester
Dimensional accuracy	±0.7 mm (±0.0276 inches.)
Squareness of corners	90° ± 0.2°

Table 2-5

If transparency jams frequently, pull the top of the sheet very gently as it leaves the printer.

2.2 Adhesive-Backed Labels

The basic rule for printing on adhesive labels is that the adhesive must never come into contact with any part of the printer. Adhesive paper sticking to the drum or rollers will damage the printer.

Label paper must be manually fed.

Label paper has a structure comprised of three layers, as shown in the figure below. The top sheet is printed on. The adhesive layer consists of pressure-sensitive adhesives. The carrier sheet (also called the linear or backing sheet) holds the labels until use. Due to the complexity of its composition, adhesive-backed label paper is particularly likely to give trouble in printing.

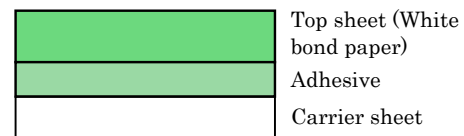

Figure 2-2

Adhesive label paper must be entirely covered by its top sheet, with no spaces between the individual labels. Labels with spaces in between are apt to peel off, causing serious paper jam problems.

Some label paper is manufactured with an extra margin of top sheet around the edge. Do not remove the extra top sheet from the carrier sheet until after printing is finished.

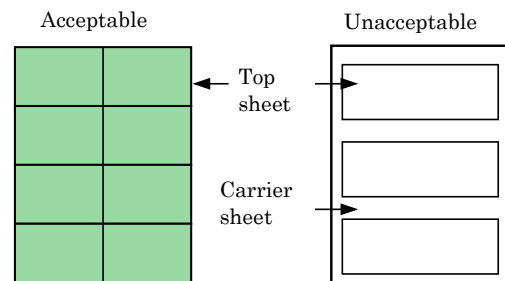

Figure 2-3

The table below lists the specifications for adhesive label paper.

Item	Specification
Weight of top sheet	44 to 74 g/m ² (12 to 20 lb/ream)
Composite weight	104 to 151 g/m ² (28 to 40 lb/ream)
Thickness of top sheet	0.086 to 0.107 mm (3.9 to 4.2 mils)
Composite thickness	0.115 to 0.145 mm (4.5 to 5.7 mils)
Moisture content	4 to 6 % (composite)

Table 2-6

Envelopes

The printer can print on envelopes using paper with a basis weight of 60 to 79 g/m² (16 to 21 lb/ream). Envelopes must be manually fed.

An envelope is a more complex object than a single sheet of paper. For this reason, it may not be possible to obtain consistent print quality over the entire envelope surface.

Many envelopes have a diagonal grain orientation (See *Paper Grain on page 2-3*). This orientation is more likely to wrinkle and crease on its way through the printer. Before purchasing envelopes for use with the printer, test a sample to verify the envelope's suitability.

Do not use envelopes that have an encapsulated liquid adhesive.

Avoid long printing runs consisting of envelopes only. Extensive envelope printing can cause premature printer wear. To avoid jamming due to curled envelopes, do not leave more than approximately 10 printed envelopes stacked in the paper trays during multiple envelope printing.

Colored Paper

Colored paper should satisfy the same conditions as white bond paper, listed in *1.2 Paper Specifications on page 2-1*. In addition, the pigments used in the paper must be able to withstand the heat of fusing during the printing process (up to 200 °C or 392 °F).

Preprinted Paper

Preprinted paper should have a bond paper base. The preprinted ink must be able to withstand the heat of fusing during the printing process, and must not be affected by silicone oil.

Do not use paper with any kind of surface treatment, such as the type of paper commonly used for calendars.

Recycled Paper

Select recycled paper that meets the same specifications as the white bond paper (see *1.2 Paper Specifications on page 2-1*) except whiteness.

NOTE

Before purchasing recycled paper, test a sample on the printer and check that the print quality is satisfactory.

3. Paper Type

The printer is capable of printing under the optimum setting for the type of paper being used.

Setting the paper type for the paper source from the printer's operator panel will cause the printer to automatically select the paper source and print in the mode best suited to that type of paper.

A different paper type setting can be made for each paper source including the MP tray. Not only can preset paper types be selected, but it is also possible for you to define and select customized paper types. See *Customizing Paper Type on page 3-46*.

The following types of paper can be set.

Media Type	Paper source	MP tray	Paper Cassette	Paper Weight	Duplex path (MP tray available only in Cassette mode)
Plain		Yes	Yes	Normal 2	Yes
Transparency		Yes	No	Extra Heavy	No
Preprinted		Yes	Yes	Normal 2	Yes
Labels		Yes	No	Heavy 1	No
Bond		Yes	Yes	Normal 2	Yes
Recycled		Yes	Yes	Normal 2	Yes
Vellum		Yes	No	Light	No
Rough		Yes	Yes	Normal 2	Yes
Letterhead		Yes	Yes	Normal 2	Yes
Color		Yes	Yes	Normal 2	Yes
Prepunched		Yes	Yes	Normal 2	Yes
Envelope		Yes	No	Heavy 1	No
Cardstock		Yes	No	Heavy 2	No
Thick		Yes	No	Heavy 1	No
High quality		Yes	No	Normal 2	Yes
Custom 1 (to 8)*		Yes	Yes	Normal 2	Yes

Table 2-7

Yes: Can be used No: Cannot be used

*This is a paper type defined and registered by the user. Up to eight types of user settings may be defined. For details on *Customizing Paper Type on page 3-46*.

4. How to Load Paper

The following explains the procedure for loading paper can be loaded into the two paper cassettes and the MP tray.

IMPORTANT

Fan the paper, then tap it on a level surface. This avoid media jams or skewed printing.

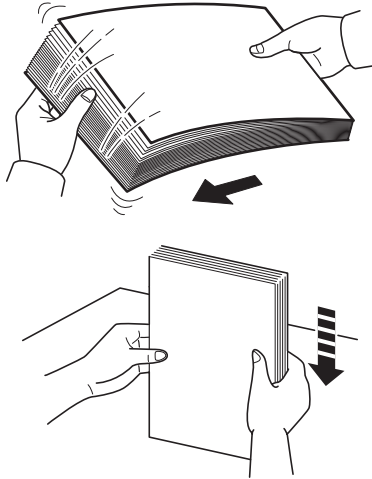

Figure 2-4

4.1 Loading Paper into the Paper Cassette

Up to about 500 sheets of standard paper (80 g/m²) can be loaded into the each paper cassette.

Inch specifications

Each paper cassette can be set to hold paper of any desired size from 11 × 17 to 5-1/2 × 8-1/2".

Metric specifications

Each paper cassette can be set to hold paper of any desired size from A3 to A5R.

- 1 Pull the paper cassette out toward you as far as it will go. Do not pull more than one paper cassette out at a time.

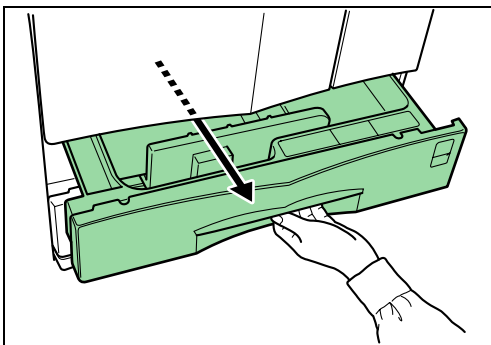

Figure 2-5

- 2 Hold the paper guide and move it to align the paper guide with the required paper width. Paper sizes are marked inside the paper cassette.

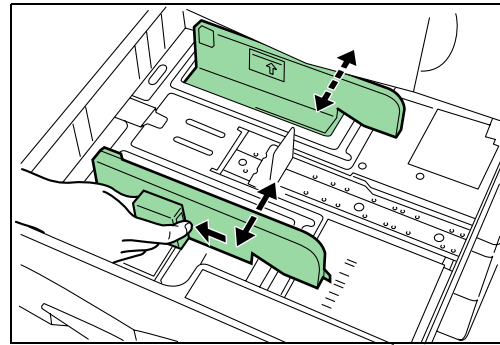

Figure 2-6

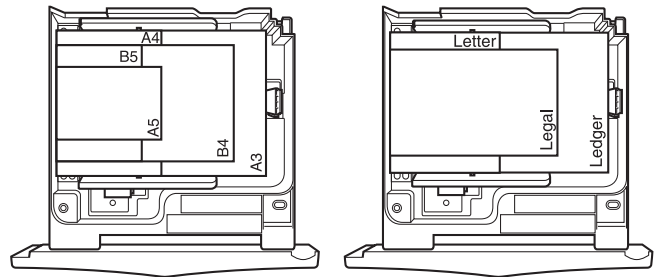

Figure 2-7

- 3 Hold the paper stopper and move it to align with the required paper length.

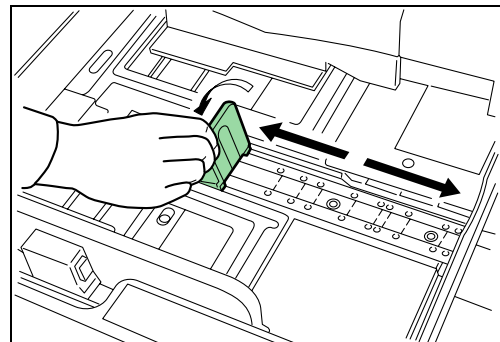

Figure 2-8

- 4 Set the paper flush against the left-hand wall of the paper cassette.

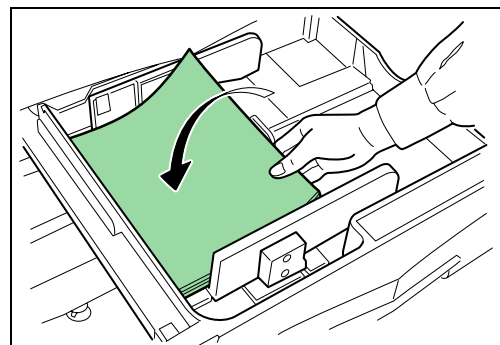

Figure 2-9

IMPORTANT

- There is a sticker (↑ in the illustration) indicating paper capacity attached to the inside of the paper cassette. Do not load paper above this limit.
- When loading paper into the paper cassette, make sure that the loading side is facing upward. (The print side is the side facing upward when the package is opened.)
- Check that the paper guide makes secure contact with the paper. If there is a gap, adjust the position of the paper guide.
- If small-size paper jams occur frequently under high temperature and high humidity conditions, reduce the number of sheets to the level line indicated on the sticker ↑.

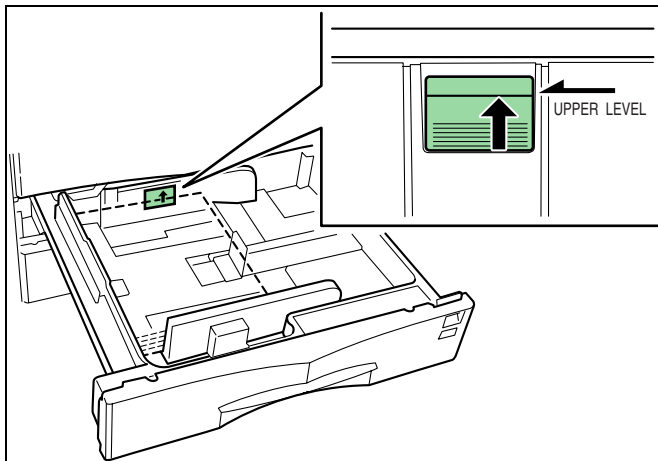

Figure 2-10

- 5 Set the supplied paper size plate so that the size of the paper loaded can be checked by looking at the front of the paper cassette.

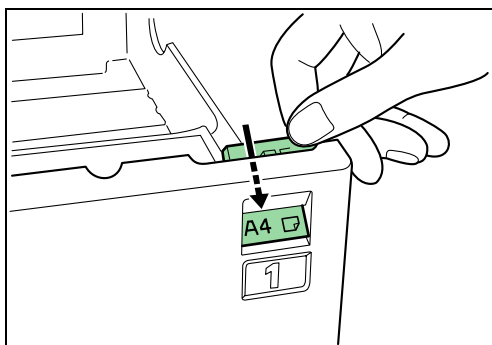

Figure 2-11

- 6 Gently push the paper cassette back in.

NOTE

Before leaving the printer in disuse for a prolonged period of time, remove the paper from the paper cassette(s) and seal it in its original packaging to protect from moisture. Also, when storing paper in a high temperature and high humidity environment, seal it in a moisture-proof bag.

4.2 Loading Paper into the MP (Multi-Purpose) Tray

Special paper as well as standard paper can be loaded into the MP tray. When printing onto transparencies or thick paper, be sure to use the MP tray.

NOTE

- The number of sheets of standard paper that can be loaded in the MP tray at a time is approximately 200.
- When using transparencies, load a single sheet at a time.

IMPORTANT

When setting special paper, such as transparencies and thick paper, into the M tray, select the type of paper by referring to [3.Paper Type on page 2-5](#).

- 1 Open the MP tray.

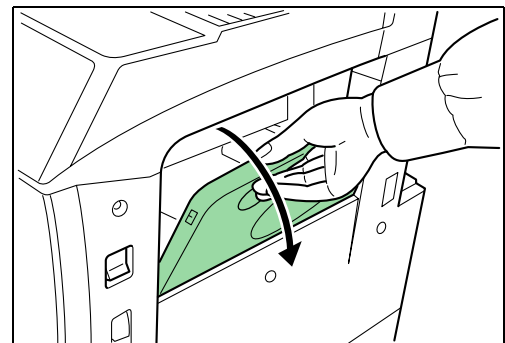

Figure 2-12

- 2 Adjust the insert guides to the size of the paper to be loaded.

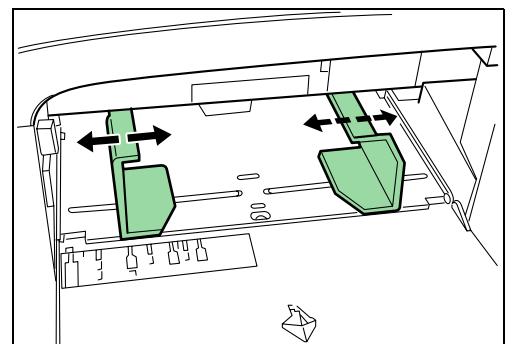

Figure 2-13

- 3 Insert the paper along the guides as far as it will go.

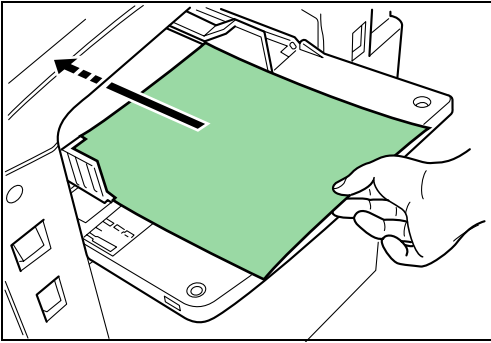

Figure 2-14

IMPORTANT

When loading paper into the MP tray, make sure that the print side is facing upward. (The print side is the side facing upward when the package is opened.) If the leading edge of the paper is curled, straighten it out before loading the paper in the MP tray.

- 3 Position the envelope against the insert guides with the print side facing upward, and insert it as far as it will go.

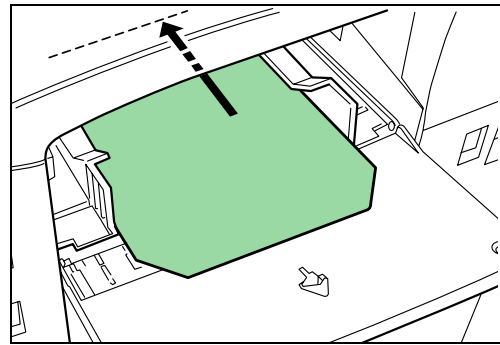

Figure 2-17

NOTE

Incorrectly loading envelopes can result in printing in the wrong orientation or on the wrong side.

4.3 Setting Envelopes

When using the optional printer function, envelopes can be set in the MP tray.

NOTE

Do not print on envelopes with flap adhesive exposed. This can cause printer malfunction.

- 1 Open the MP tray.

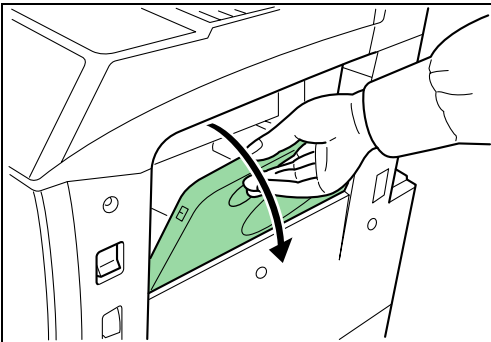

Figure 2-15

- 2 Align the insert guides with the envelope size.

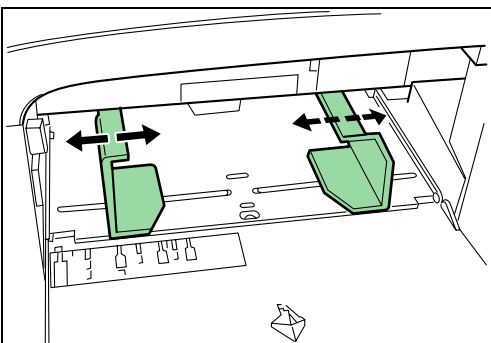

Figure 2-16

Chapter 3

Using the Operator Panel

This chapter explains the following topics:

- Understanding the Operator Panel
- Using the Operator Panel

1. Understanding the Operator Panel

The operator panel has an LCD message display, indicators, and eight keys.

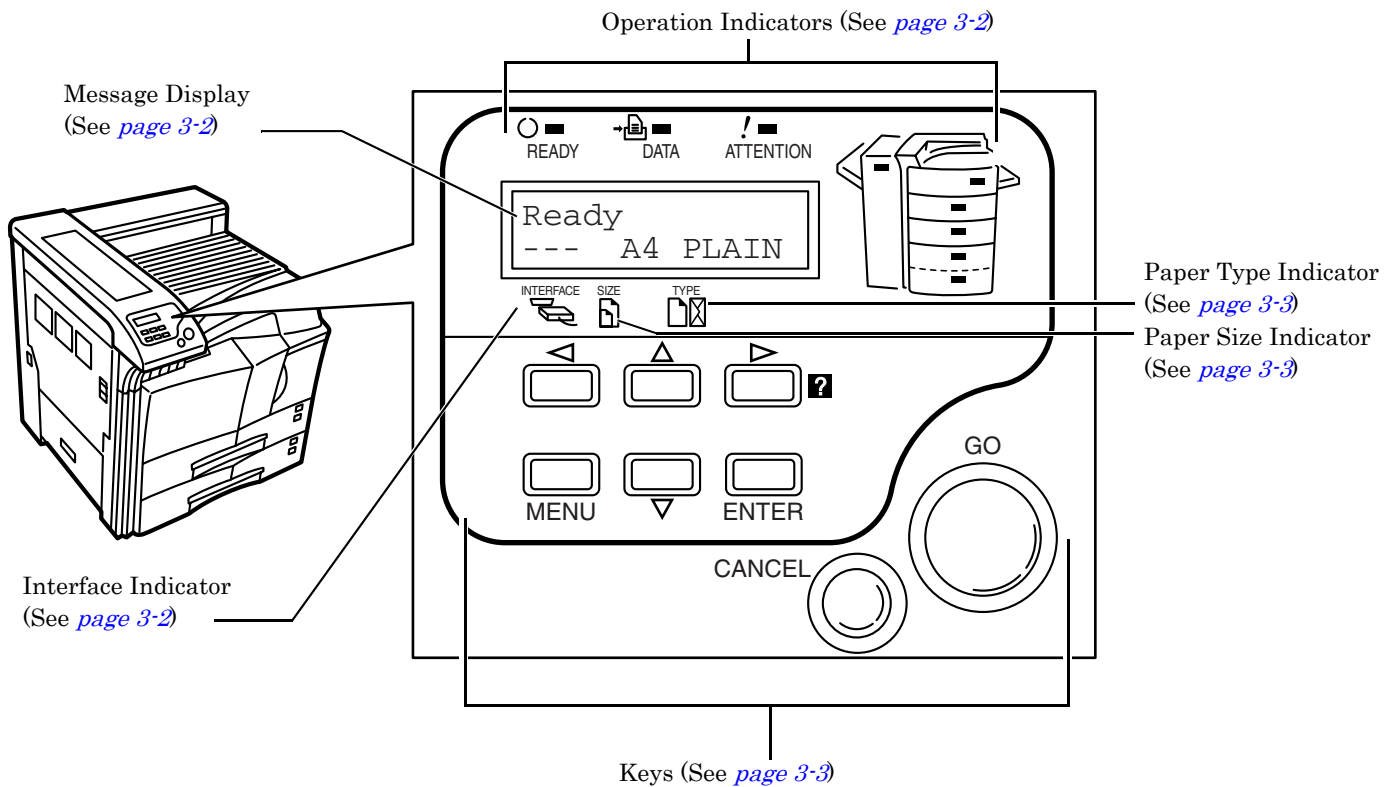

Figure 3-1

1.1 Operation Indicators

The following indicators light up during normal operation and when the printer needs attention.





Indicator	Description
 READY	<p>Flashing: Indicates when an error occurs that you can clear by yourself.</p> <p>Lit: Indicates that the printer is on-line. The printer prints received data.</p> <p>Off: Indicates that the printer is off-line. Data can be received but will not be printed. Also indicates when printing is automatically stopped due to occurrence of an error.</p>
 DATA	<p>Flashing: Indicates data transfer is taking place.</p> <p>Lit: Indicates either that data is being processed, or that data is being written to the memory card.</p>
 ATTENTION	<p>Flashing: Indicates when the printer needs maintenance attention or the printer is warming up (Please wait).</p> <p>Lit: Indicates when a problem or an error occurs that you can clear by yourself. (For example, paper jam occurs.)</p>
	<p>① Flashing: Indicates when no paper is detected.</p> <p>Fast-Flashing: Indicates that a paper jam is occurring.</p> <p>Lit: Indicates that the MP tray is selected.</p>
	<p>② Flashing: Indicates when the cassette or paper is not detected, or when the paper is loading.</p> <p>Fast-Flashing: Indicates that a paper jam is occurring.</p> <p>Lit: Indicates that the cassette is selected.</p>
	<p>③ Flashing: Indicates that there is paper jam in the optional finisher.</p> <p>Lit: Indicates that the document finisher is being selected.</p>

Table 3-1

1.2 Message Display

The message display gives information in the form of short messages. The eight messages listed below are displayed during normal warm-up and printing.

Other messages that may appear when the printer needs the operator's attention are explained [on page 4-4](#).

Message	Meaning
Self test	The printer is self-testing after power-up.
Please wait	The printer is warming up and is not ready. When the printer is switched on for the first time after the toner container is installed, (Adding toner) also appears.
Ready	The printer is ready to print.
Processing	The printer is receiving data, generating graphics, reading a memory card/hard disk, or printing.
Sleeping	The printer is in Sleep mode. The printer wakes from Sleep mode whenever a key on the operator panel is pressed, the cover is opened or closed, or data is received. The printer then warms up and goes online. The time that the printer takes to enter Sleep mode depends on the Sleep Timer setting.
Cancelling data	Jobs inside the printer are being canceled. To cancel a job, see the table on page 3-4 .
Waiting	The printer is waiting for the end-of-job command before printing the last page. Pressing the GO key allows you to obtain the last page immediately.
FormFeed TimeOut	The printer is printing the last page after a waiting period.

Table 3-2

1.3 Interface Indicator

The interface Indicator shows the interface that is currently used. It uses the following abbreviations:

PAR	Parallel interface
USB	USB interface
NET	Network interface
OPT	Network interface card (option)
SER	Serial (RS-232C) interface (option)
---	No interface is active.

Each interface has a timeout time of 30 seconds during which the other interface should wait to receive a print job. Even if a print job has been completed on the interface, you should wait for this period until the other interface begins printing the job.

1.4 Paper Size Indicator

This indicator shows the paper size of the current paper cassette. The following abbreviations are used to indicate the paper sizes.

Message Display	Paper Size
A3	ISO A3
A4	ISO A4
A5	ISO A5
A6	ISO A6*
B5	JIS B5
B6	JIS B6*
LT	Letter
LG	Legal
MO	Monarch*
BU	Business*
B4	B4
LD	Ledger
FO	Folio
Y4	Youkei4*
DL	ISO DL*
C5	ISO C5*
b5	ISO B5*
EX	Executive*
#6	Commercial 6-3/4*
#9	Commercial 9*
HA	Japanese Postcard*
OH	Return Postcard*
CU	Custom Size
C4	ISO C4
O2	Oficio II
ST	Statement
Y2	Youkei2*
8K	8kai*
16K	16kai*

Table 3-3

* With only the MP tray feeding

NOTE

While the printer is processing data, the **SIZE** display indicates the paper size selected by the application software.

1.5 Paper Type Indicator

This shows the paper type defined for the current paper cassette. Automatic cassette switching is available according to the paper type.

The paper type can be specified at the operator panel. See *Customizing Paper Type on page 3-46*.

The following abbreviations are used to indicate the paper type.

Message Display	Paper Type
None	Auto
PLAIN	Plain
TRNSPRNCY	Transparency*
PREPRINT	Preprinted
LABELS	Labels*
BOND	Bond
RECYCLED	Recycled
VELLUM	Vellum*
RECYCLED	Recycled
ROUGH	Rough
LETTERHEA	Letterhead
COLOR	Color
PREPUNCH	Prepunched
ENVELOPE	Envelope*
CARDSTOCK	Cardstock*
THICK	Thick paper*
HIGH QUAL	High quality paper
CUSTOM1 (to 8)	Custom 1 (to 8)

Table 3-4









* With only the MP tray feeding

1.6 Keys

The operator panel keys are used to configure the printer. Note that certain keys have the secondary function.

NOTE

Settings made with these keys effect only the interface currently in use.

Key	Function
	<ul style="list-style-type: none"> Switches the printer on-line and off-line. Prints and feeds out one page.
	<ul style="list-style-type: none"> <ul style="list-style-type: none"> Cancels a printing job. To cancel, proceed as follows: <ol style="list-style-type: none"> Check if <code>Processing</code> is displayed in the message display. Press the CANCEL key. <ul style="list-style-type: none"> <code>Print Cancel?</code> appears in the message display and then interface to be canceled appears. Parallel USB Network Option (appears only when an option network interface card is installed) Serial Select the interface to cancel using the Δ or ∇ key and then press the ENTER key. Printing from the selected interface will stop. <code>Cancelling data</code> appears in the message display and printing stops after the current page is printed. Resets numeric values, or cancels a setting procedure. Used to stop the sounding of the alarm buzzer indicating an error.
	<ul style="list-style-type: none"> Used to select the emulation, font, character code set; to read a memory card, and more. When pressed during mode selection, terminates the setting and the printer returns to the Ready mode.
	Used to access a desired item or enter numeric values. In some of the control procedures, the \triangleright and \triangleleft keys are used to enter or exit a sub item.
	Used to access a desired item or to enter numeric values. In some of the control procedures, the \triangleright and \triangleleft keys are used to enter or exit a sub item.
	Used as the Δ key in the mode selection function.
	<ul style="list-style-type: none"> Used as the \triangleright key in the mode selection function. Displays online help messages on the message display when paper jam errors occur. When pressed in the Ready condition, it displays explanations of online help messages. When pressed while the online help is displayed, it cancels the online help.
	Finalizes numeric values and other selections.

† If you hold down the **ENTER** key and press the **MENU** key when Ready is shown on this printer, the Administration ID menu will be displayed. This menu is the setting menu for administration under the Account Management System and is normally not used. Press the **MENU** key to return to the Ready display.

Table 3-5

2. Using the Operator Panel

This section explains how to use the menu selection system. The **MENU** key on the operator panel allows you to use the menu to set or change the printer environment such as the number of copies to print, emulation, etc., to your specific needs. Settings can be made when Ready is indicated on the printer message display.

The printer obeys the most recently received printer settings sent from the application software, or from the printer driver, which take priority over operator panel settings.

2.1 Menu Selection System

The following is the hierarchy diagram of the menu selection system of the printer. The vertical transition is made with the Δ and ∇ keys and horizontal transition is made with the \triangleright and \triangleleft keys. To change or finalize configuration on an item, use the **ENTER** key.

 These items will not appear unless the printer is installed with the applicable option.

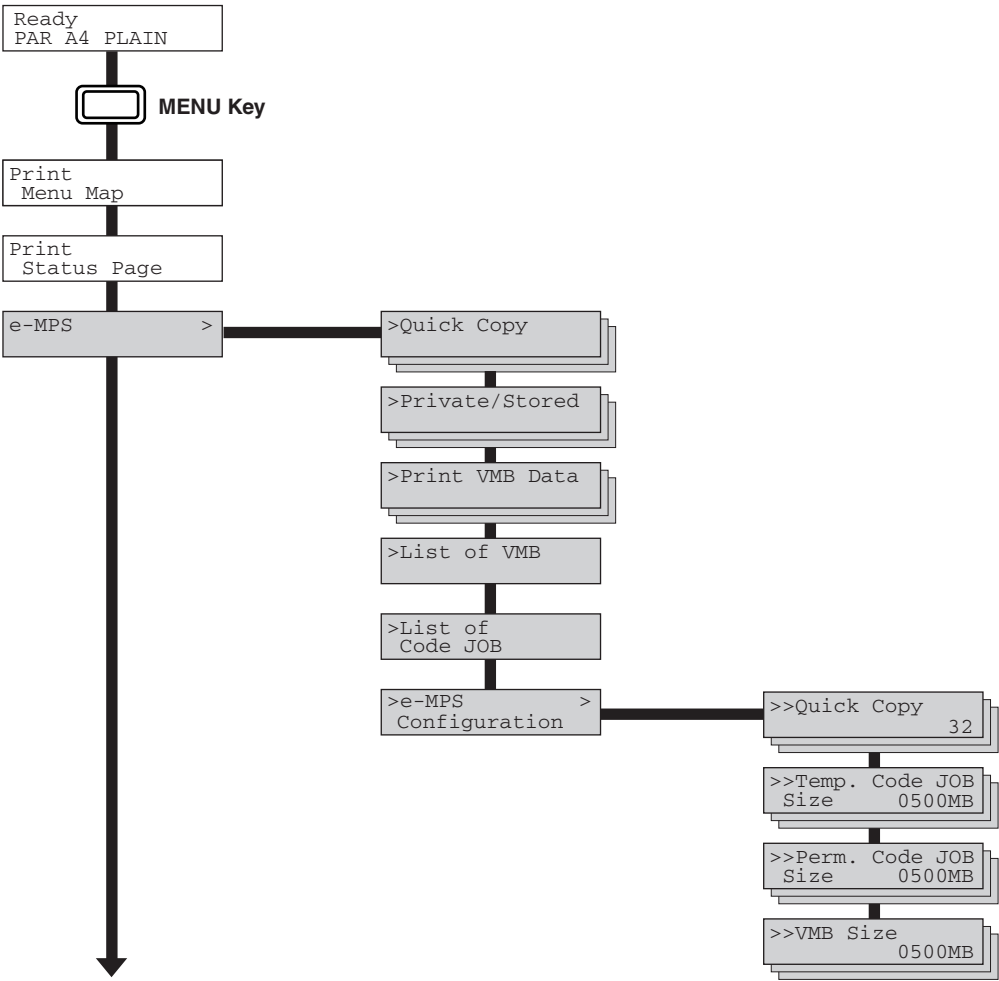

Continued on the next page

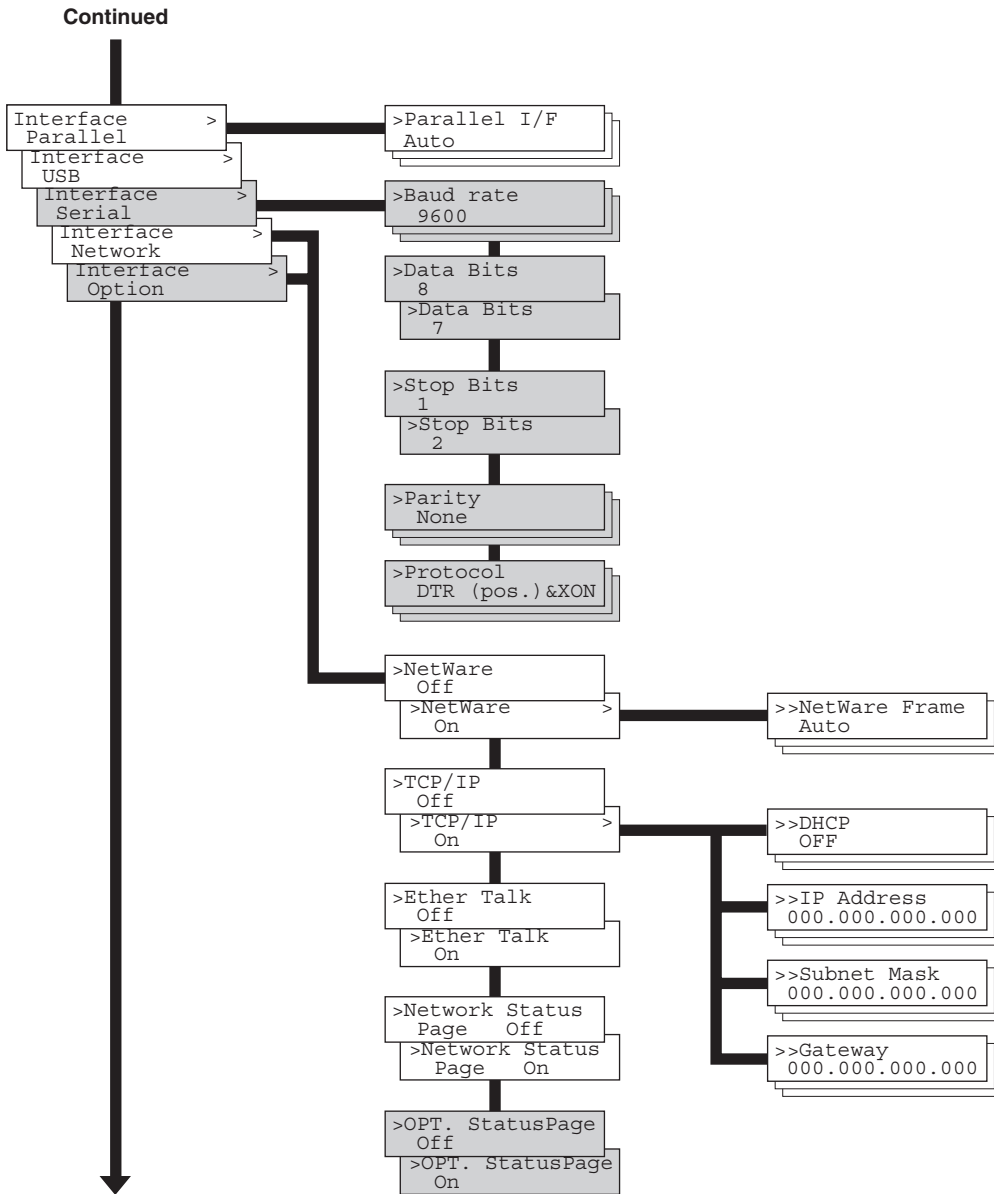

Continued

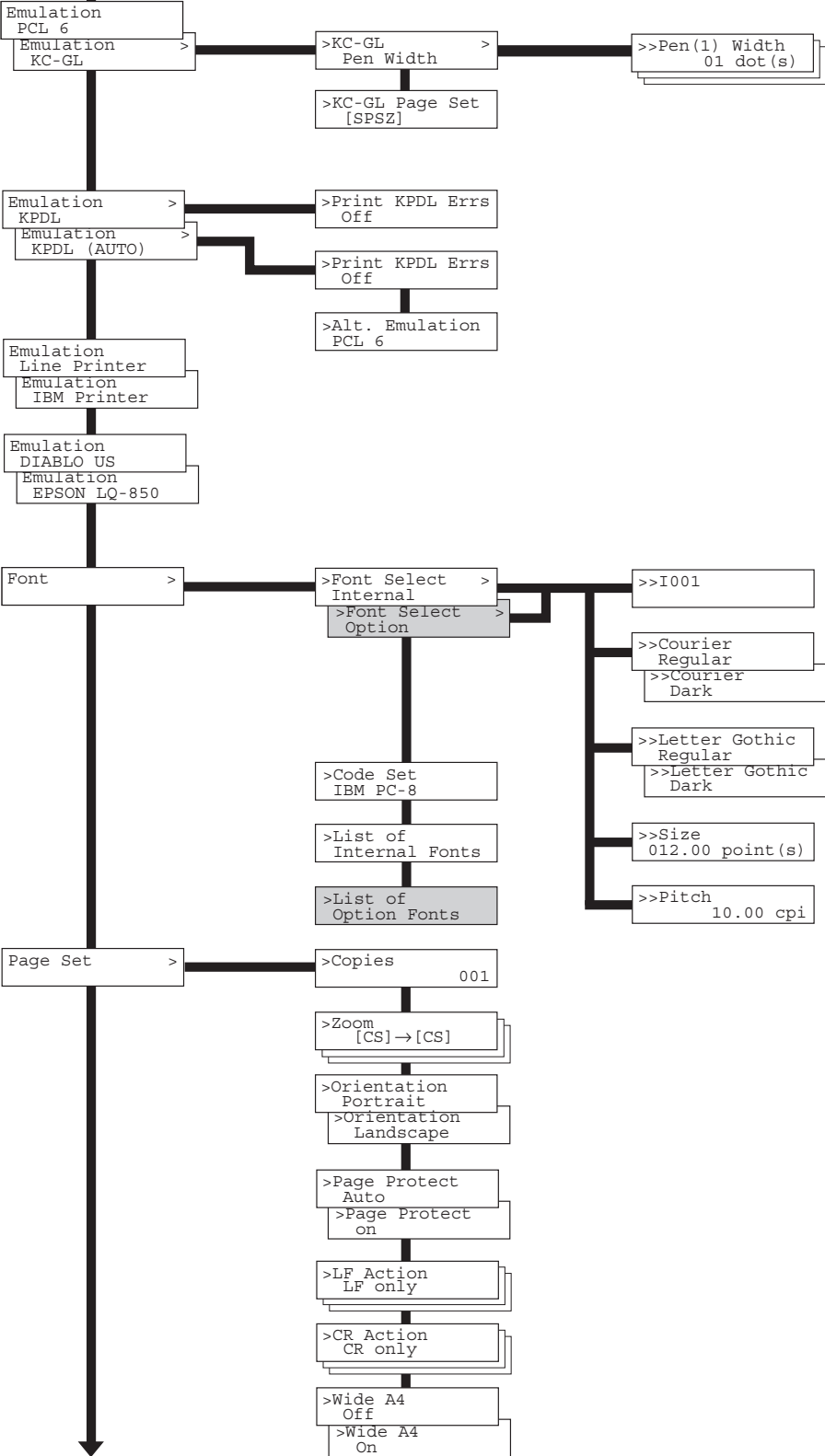

Continued on the next page

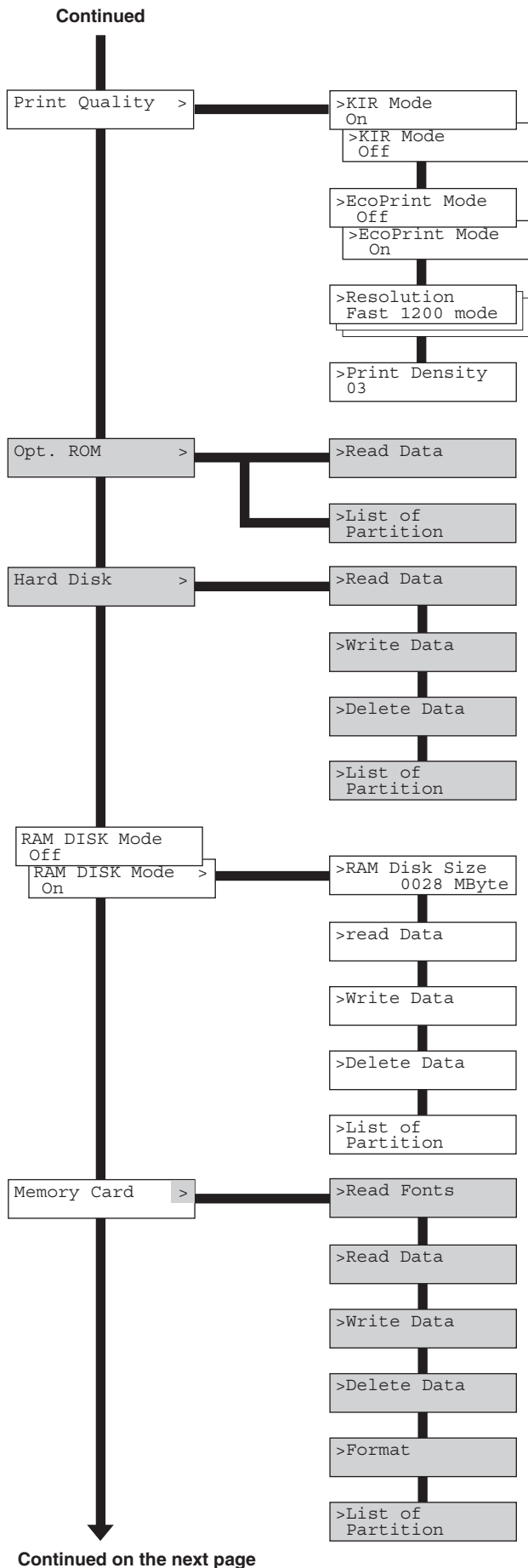

Continued on the next page

Continued

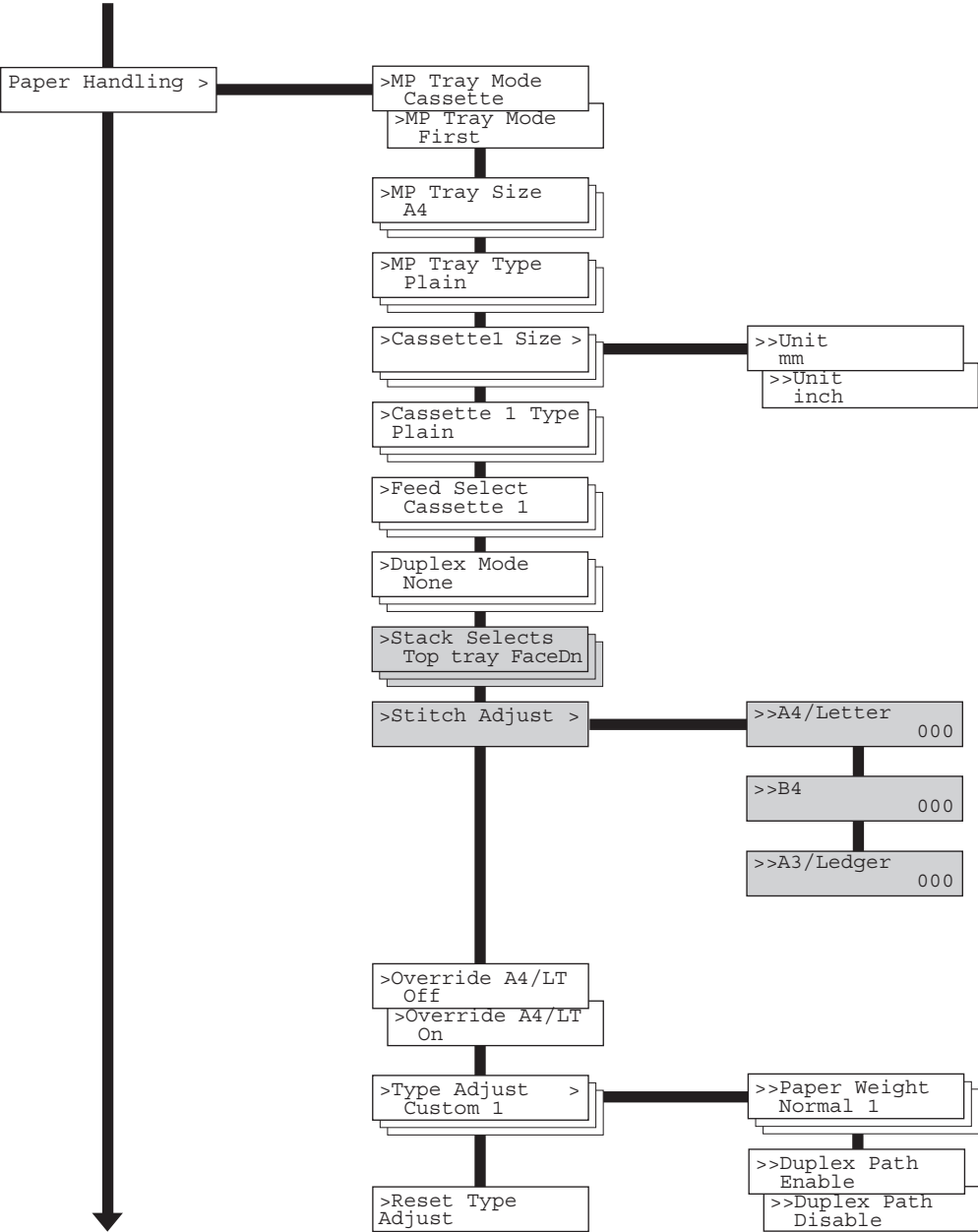

Continued on the next page

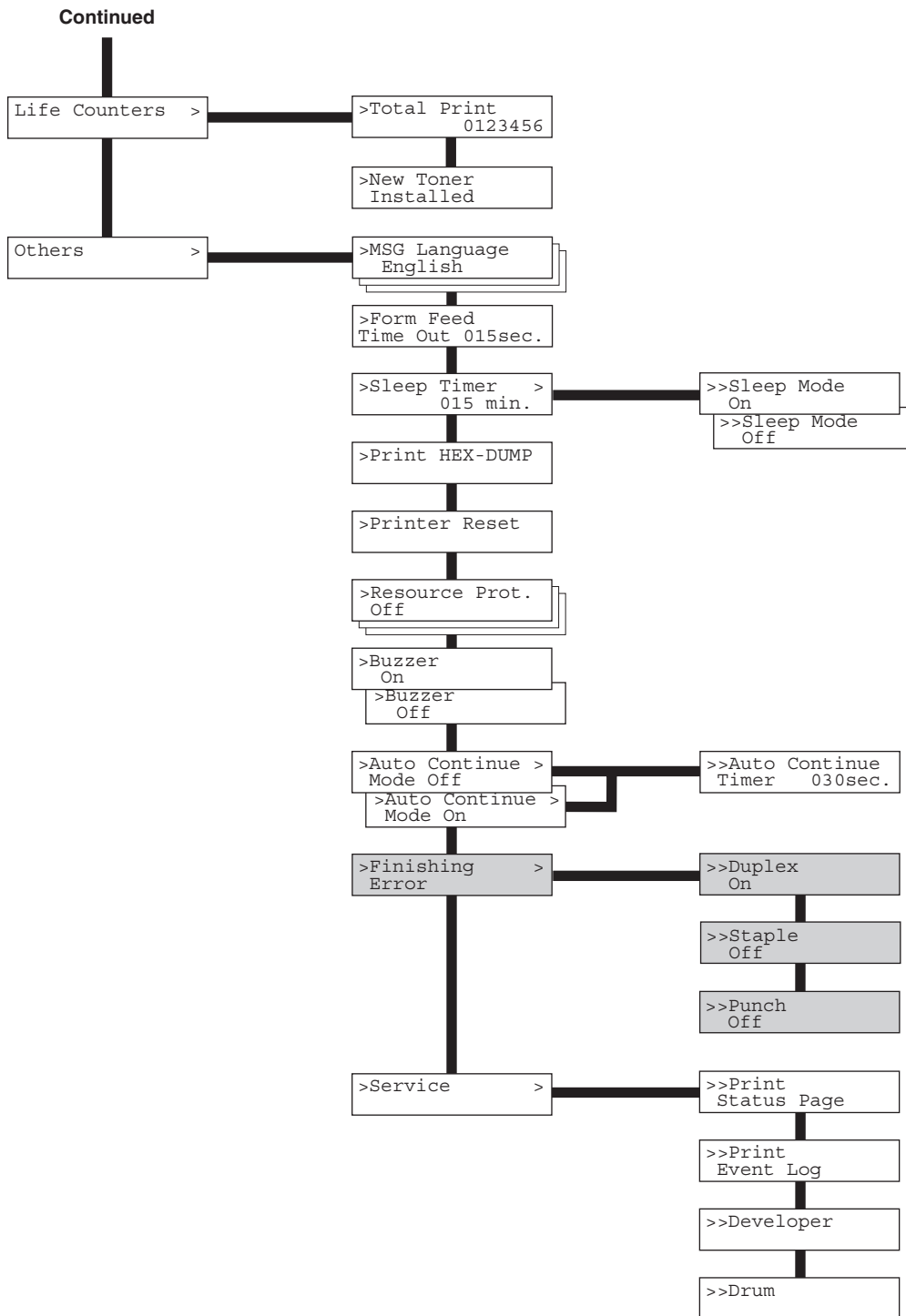

2.2 Using the Menu Selection System

This section explains the procedure for using the menu selection system. The menu selection system is activated by the **MENU** key while the printer is Ready.

2.2.1 Printing the Menu Map

The printer prints a full list of menu selections. Note that menus indicated on the list may vary depending on which option units are installed on the printer.

- 1** Press the **MENU** key.
- 2** Press the Δ or ∇ key repeatedly until **Print Menu Map** appears.
- 3** Press the **ENTER** key. A question mark (?) appears.
- 4** Press the **ENTER** key again. The printer prints a menu map.

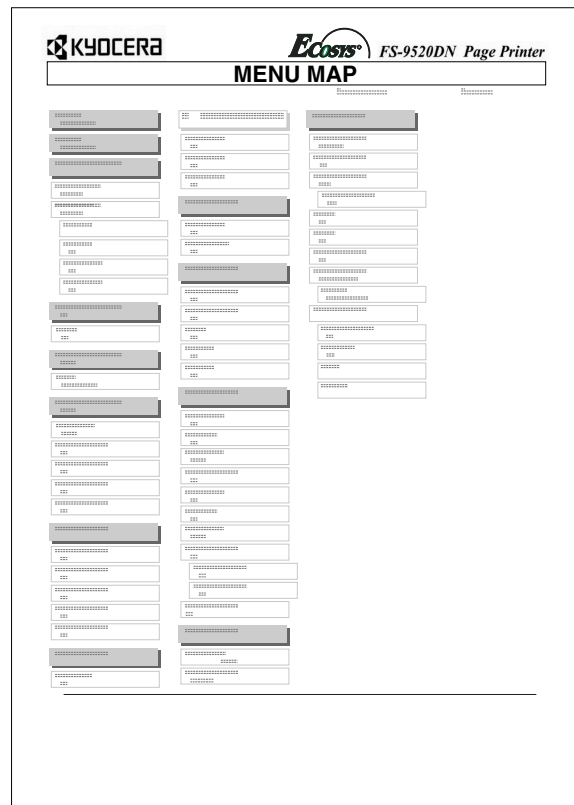
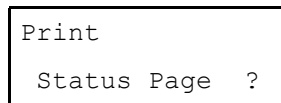
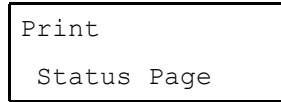

Figure 3-2

2.2.2 Printing Status Page

If you want to check the printer's current status, including memory available and option settings, you can find the information you need on the status page.

- 1** Press the **MENU** key.
- 2** Press the Δ or ∇ key repeatedly until **Print Status Page** appears.
- 3** Press the **ENTER** key. A question mark (?) appears.
- 4** Press the **ENTER** key again. The printer prints a status page.



NOTE

For a full description of the status, see the following sample status page.

The following is a sample status page. The numbers below refer to the contents explained on the next page.

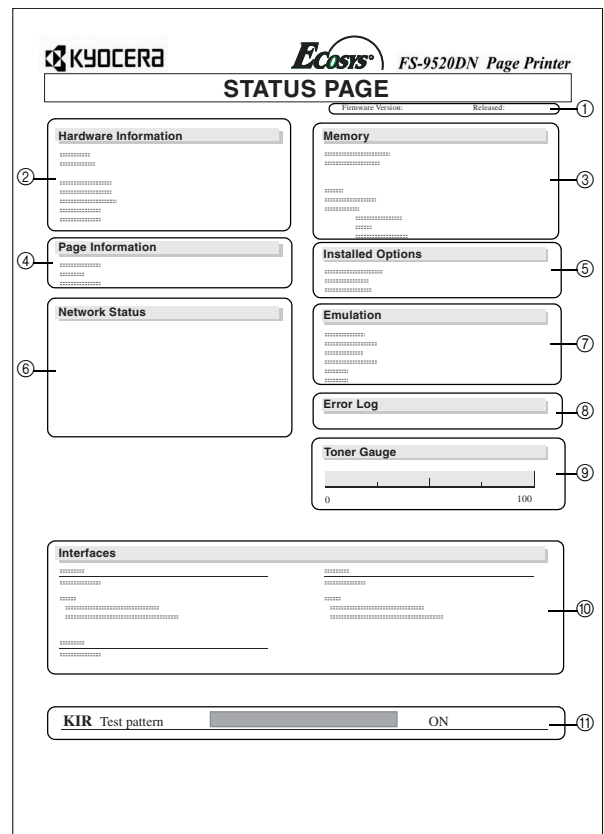

Figure 3-3

When the Network Status is turned on, the Network Interface Status Page will be printed after the Printer Status. (See [page 3-20](#).)

NOTE

Items and values on the status page may vary depending on the printer's firmware version.

① Software Version

This information shows the firmware version and date of issue of the printer.

② Hardware Information

This information shows various printer settings, such as the size and type of the paper in the paper cassettes.

③ Memory

This shows the amount of total memory installed in the printer, the amount of currently available memory, and the current status of the RAM disk. See [Setting RAM Disk Size on page 3-35](#).

④ Page Information

This shows the print resolution, number of copies, and the total page count.

⑤ Installed Options

This shows the option(s) installed in the printer.

⑥ Network Status

This shows the IP address, Subnet Mask address, and Default Gateway address for the network interface.

⑦ Emulation

This shows all available emulations of the printer. The printer is shipped from the factory with PCL 6 emulation selected as the default.

⑧ Error Log

This shows the last three instances of the following types of errors, listing them in the order of their occurrence:

- KPD (PostScript) errors
- Memory card errors
- Memory card, hard disk, RAM disk errors

The most recent error is displayed on the top line of the Error Log. For error remedies, see [Maintenance Messages on page 4-4](#). Error information is cleared when the printer's power is turned off.

⑨ Toner Gauge

This shows the approximate level of remaining toner. When the value is 100, the toner container is full.

⑩ Interface Information

This information shows the default font and the default emulation for all interfaces installed in the printer.

⑪ KIR Test Pattern

KIR is the Kyocera's original smoothing function. This test pattern shows the effect of the KIR (Kyocera Image Refinement) system.

2.2.3 e-MPS

e-MPS is an abbreviation for 'enhanced-Multiple Printing System' which implements the following functions that are available from the printer driver:

- Job Retention
- Job Storage

In either job mode, when printing a document, the print data is transferred from the computer to the printer then stored on the printer's hard disk. Since copies of the document are printed using the stored data, printing is performed faster with less computer spooling time and less network traffic.

NOTE

To use the e-MPS system, an optional hard disk must be installed in the printer. For details, see [Appendix A Option Units](#). As an alternative to a hard disk, the RAM disk may be used in the Proof-and-Hold and Private Print modes. To activate the RAM disk in the printer, see [Operating the RAM Disk on page 3-35](#).

Job Retention

Job Retention has four modes as summarized below. These modes are selected when you choose on the printer driver through the application software:

	Quick Copy	Proof-and-Hold
Primary function	To later print additional copies	To proof the first copy before printing multiple copies
Storing started	Printer driver	Printer driver
Retrieved by	Operator panel	Operator panel
Default number of copies printed at retrieval	Same as storing	One less
Maximum number of jobs stored*	32,expandable to 50	32,expandable to 50
PIN security	No	No
Data after printing	Retained	Retained
Data when power off	Deleted	Deleted

Table 3-6

	Private Print	Stored Job
Primary function	To hold the document in printer to prevent unauthorized access	To electronically store documents such as fax cover pages
Storing started	Printer driver	Printer driver
Retrieved by	Operator panel	Operator panel
Default number of copies printed at retrieval	Same as storing	One
Maximum number of jobs stored*	Private jobs are deleted automatically once it is retrieved.	Depends on the hard disk capacity
PIN security	Yes	Yes (Option)
Data after printing	Deleted	Retained
Data when power off	Deleted	Retained

*Jobs in excess will cause the earlier ones to be deleted.

Table 3-7

Job Storage

Job storage stores print jobs either temporarily or permanently, or in virtual mailboxes, as you click an appropriate radio button on the printer driver when printing from a computer.

Virtual Mailbox

Virtual mailbox is part of Job Storage, which stores print jobs on the hard disk without printing. It enables you to retrieve jobs later from the operator panel.

Each mailbox may be used by an individual who desires to share the printer in this mode. By default, each mailbox is numbered from 'Tray 001,' 'Tray 002,' ... etc. To 'post' a job in one of these mailboxes, you assign a numbered or named mailbox on the printer driver when printing.

To retrieve the stored job for printing, see *Retrieving Jobs from Virtual Mailbox (VMB) on page 3-16*.

NOTE

The virtual mailbox can be used in PCL 6 emulation only.

Using Quick Copy

This mode enables you to print the requested number of copies of a job, simultaneously storing the job on the hard disk. When additional copies are required, you can reprint the required number of copies from the printer operator panel. To print a job as a quick copy job, see *Printer Driver Guide*.

The default number of print jobs that can be stored on the hard disk is 32. This value can be increased to up to 50 from the e-MPS Configuration menu. For details, see *Changing e-MPS Configuration on page 3-16*. When the number of jobs reaches the limit, the oldest job will be overwritten by the new one.

When the printer is turned off, all stored jobs will be deleted.

Printing Additional Copies using Quick Copy

To print additional copies of a job stored in the printer:

- 1** Press the **MENU** key.
- 2** Press the Δ or ∇ key repeatedly until e-MPS > appears.
- 3** Press the \triangleright key.
- 4** Press the Δ or ∇ key repeatedly until >Quick Copy appears followed by the user name (Harold, in this example). The user name is assigned at printing using the printer driver.

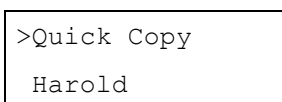
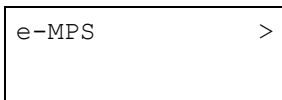

- 5** Press the **ENTER** key. A blinking question mark (?) appears before the user name.

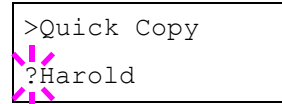

- 6** Press the Δ or ∇ key to display the desired user name, Arlen, in this example.

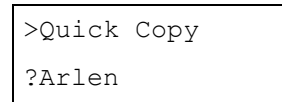

- 7** Press the **ENTER** key. The job name entered in the printer driver (Report, in this example) appear with a blinking question mark (?) before the letters.

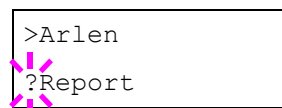

- 8** Press the Δ or ∇ key to scroll to the desired job title.

- 9** Press the **ENTER** key. The number of copies to be printed can be set. To increase the copy count, press the Δ key; to decrease the copy count, press the ∇ key.

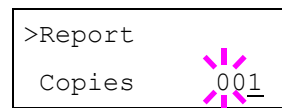

- 10** Press the **ENTER** key to finalize the copy count. The printer prints the specified number of copies for the job.

Deleting a Quick Copy Job

All quick copy jobs are automatically deleted when the printer is turned off. If you desire to explicitly delete a stored quick copy job, proceed as follows:

- 1** Follow steps 1 through 8 in the above section to display the title of the job to be deleted.
- 2** When the title of the job to be deleted is displayed, e.g. Report, below, press the **ENTER** key. The cursor below the copy count starts to blink.
- 3** Press the ∇ key repeatedly until Delete appears below the title.
- 4** Press the **ENTER** key. The stored quick copy job is deleted.

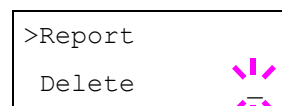
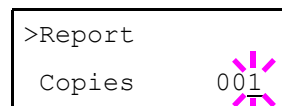

Chapter 3 Using the Operator Panel

Using Proof-and-Hold

When you print multiple copies, this mode first prints one copy so that you can proof it before continuing to print the remaining copies. Since you can proof the printouts before printing the remaining copies, wastage of paper can be reduced.

The printer prints one copy and, at the same time, saves the print job on the hard disk. You can also change the number of copies when resuming printing from the operator panel.

When the printer is turned off, all stored jobs will be deleted.

Printing Remaining Copies of a Proof and Hold Job

Printing a Proof-and-Hold job on the operator panel is similar to printing a quick copy job. To print remaining copies of a job held in the printer:

Printing a Private Print/Job Retention

In private printing, you can specify that a job is not printed until you release the job from the operator panel. When sending the job from the application software, you can specify a 4-digit access code in the printer driver. The job is released for printing by entering the access code on the operator panel. Thus, this function ensures confidentiality of the print job.

In the job retention mode, access codes are not mandatory, but can be set on the printer driver if printing with the PIN security is required. Then, the access code must be entered on the operator panel to print a stored job. Print data will be stored in the hard disk/RAM disk after printing. *See KX Printer Drivers Operation Guide* for the driver settings.

Releasing a Private/Stored Job

1 Press the **MENU** key.

2 Press the Δ or ∇ key repeatedly until e-MPS > appears.

```
e-MPS >
```

3 Press the \triangleright key.

4 Press the Δ or ∇ key repeatedly until >Private/ Stored appears. The name entered in the printer driver (Harold, in this example) also appears.

```
>Private/Stored  
Harold
```

5 Press the **ENTER** key. A blinking question mark (?) appears before the user name.

```
>Private/Stored  
?Harold
```

6 Press the Δ or ∇ key to display the desired user name (Arlen, in this example).

```
>Private/Stored  
?Arlen
```

7 Press the **ENTER** key. The user name and the job name (Agenda, in this example) entered in the printer driver appear with a blinking question mark (?).

```
>Arlen  
?Agenda
```

8 Press the Δ or ∇ key to display the desired job title.

9 Press the **ENTER** key. The ID input line appears. Enter the four-digit access code entered in the printer driver and press the **ENTER** key. To enter the ID, Press the \triangleleft or \triangleright key to move the cursor to the number to be changed and then enter the correct number by pressing the Δ or ∇ key.

```
>Agenda  
ID 0000
```

10 You can set the number of copies to be printed. To increase the copy count, press the Δ key; to decrease the copy count, press the ∇ key.

```
>Agenda  
Copies 001
```

11 Press the **ENTER** key to finalize the copy count. The printer prints the specified number of copies for the job.

Deleting a Private/Stored Job

You can individually delete stored jobs by performing the following procedure. Jobs saved using Private Print will be automatically deleted if you turn the power off after printing, but jobs saved using Stored Job will not be deleted automatically.

1 Follow steps 1 through 8 in the above section.

2 When the title of the job to be printed is displayed (Agenda, in this example), press the **ENTER** key. Enter the four-digit access code entered in the printer driver and press the **ENTER** key.

```
>Agenda  
Copies 001
```

- 3 Press the ∇ key repeatedly until **Delete** appears for the number of copies.

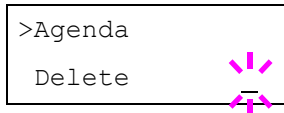

- 4 Press the **ENTER** key. The private job is deleted from the hard disk.

Printing a code job

Install the KM-NET Job Manager software from the CD-ROM supplied with the printer. To do this, from the CD-ROM **Main Menu**, select **Printer Utilities > Install KM-NET Job Manager**.

- 1 Browse through Windows **Start > Programs > KYO-CERA MITA > KM-Net > Job Manager**.
- 2 Enter the password for the software. **Job Manager** will start.
- 3 Click the **Add printer** icon (below). Select the **Local** or **Network** port.

NOTE

If you use the local parallel port to connect to the printer, make sure that the printer driver is set to print to a local port. To check this out, click the Details tab of the printer Properties, and note the Print to the following port setting.

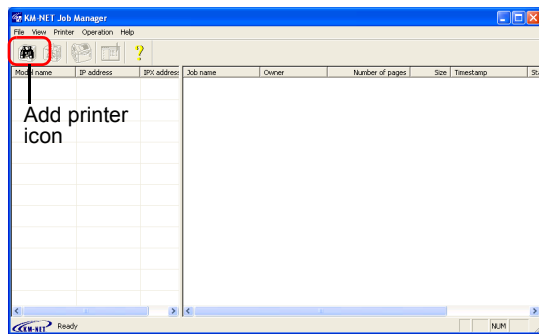

Figure 3-4

- 4 Follow the wizard until the **Select printer** dialog box is reached. When the printer is found in the **Printer List**, click (highlight) it, then **Finish**.

- 5 Double click **Model Name** on the list. The jobs currently stored in the printer are shown. To print the job, right click **Job name** and then click **Print** on the drop down list that appears.

It is possible to select more than one job at a time by left clicking a job one by one while pressing the **Ctrl** key on the computer keyboard.

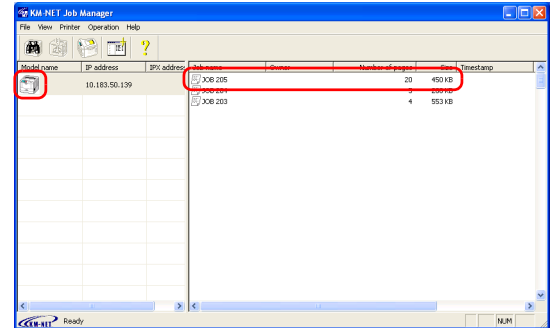

Figure 3-5

The job remains intact even after printing. To permanently delete the job in the hard disk, right click the job name on **Job Manager**, then click **Delete** on the drop down list that appears.

Printing a List of Code Jobs

If you select Permanent Job Storage on the printer driver, you can have a List of Code Job printed using the operator panel.

- 1 Press the **MENU** key.
- 2 Press the Δ or ∇ key repeatedly until **e-MPS >** appears.



- 3 Press the \triangleright key.

- 4 Press the Δ or ∇ key repeatedly until **>List of Code JOB** appears.

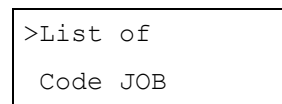

- 5 Press the **ENTER** key. A question mark (?) appears.

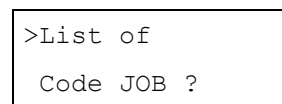

- 6 Press the **ENTER** key again. The printer prints a Code Job list as shown below.

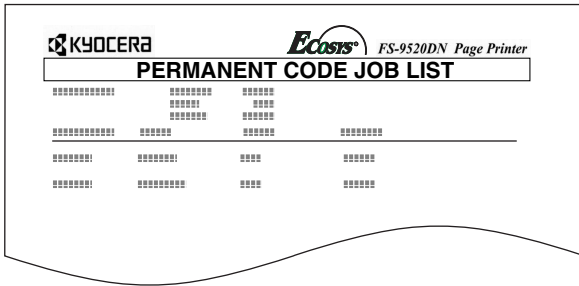
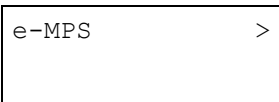

Figure 3-6

Retrieving Jobs from Virtual Mailbox (VMB)

To retrieve the jobs posted in the virtual mailbox, proceed as follows.

- 1 Press the **MENU** key.
- 2 Press the Δ or ∇ key repeatedly until e-MPS > appears.



- 3 Press the \triangleright key.

- 4 Press the Δ or ∇ key repeatedly until >Print VMB Data appears. The virtual mailbox number will also appear.

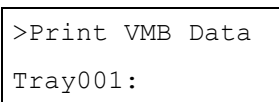

If you have named the virtual mailbox with an alias on the printer driver, the alias (Richard, in this example) will follow the number:

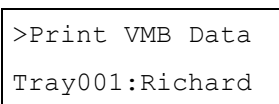

- 5 Press the **ENTER** key. A blinking question mark (?) appears.

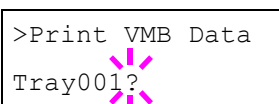

- 6 Press the **ENTER** key. The document in the mailbox is printed and automatically deleted from the mailbox.

Printing a List of VMB

A Virtual Mailbox list includes the jobs currently stored in the mailboxes.

- 1 Press the **MENU** key.
- 2 Press the Δ or ∇ key repeatedly until e-MPS > appears.

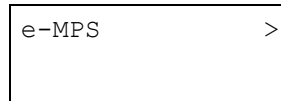

- 3 Press the \triangleright key.

- 4 Press the Δ or ∇ key repeatedly until >List of VMB appears.

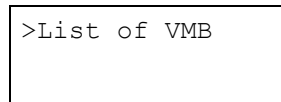

- 5 Press the **ENTER** key. A question mark (?) appears.

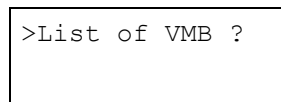

- 6 Press the **ENTER** key again. The printer prints a list of jobs currently posted in the virtual mailboxes as shown below.

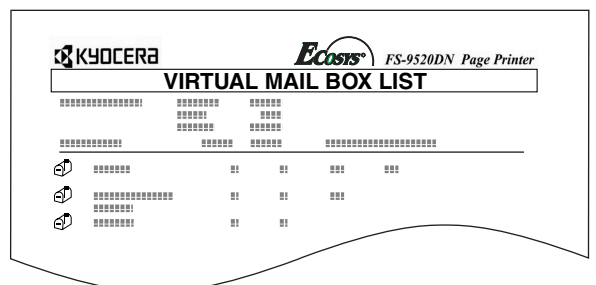

Figure 3-7

Changing e-MPS Configuration

You can change the following parameters for e-MPS operation:

- Maximum number of Quick Copy/Proof-and-Hold jobs
- Maximum space assigned to temporary code jobs
- Maximum space assigned to permanent code jobs
- Maximum space assigned to virtual mailboxes

NOTE

The total amount of storage area specified must not exceed the total size of the hard disk. Otherwise, you may only be able to accommodate a smaller number of print jobs than specified.

Changing the Maximum Number of Quick Copy/Proof-and-Hold Jobs

This changes maximum number of Quick Copy/Proof-and-Hold jobs from 0 to 50. The default is 32.

1 Press the **MENU** key.

2 Press the Δ or ∇ key repeatedly until e-MPS > appears.

```
e-MPS >
```

3 Press the \triangleright key.

4 Press the Δ or ∇ key repeatedly until >e-MPS Configuration > appears.

```
>e-MPS >
Configuration
```

5 Press the \triangleright key.

6 Press the Δ or ∇ key repeatedly until >>Quick Copy appears.

```
>>Quick Copy
32
```

7 Press the **ENTER** key. A blinking cursor () appears.

```
>>Quick Copy
32
```

8 Press the Δ or ∇ key to increase or decrease the value at the blinking cursor. The value can be set between 0 and 50. Use the \triangleright and \triangleleft keys to move the cursor right and left.

9 When the desired maximum number of jobs is set, press the **ENTER** key.

10 Press the **MENU** key. The display returns to Ready.

Maximum Space Assigned to Temporary Code Jobs

This changes the hard disk space that holds temporary code jobs. You can change the maximum space from 0 to 9999 (megabytes). The actual maximum size depends on the size of free hard disk space, however. The default size is 1/6 of the total hard disk space, rounded off in units of 50 MB. For example, if the total hard disk space is 3.2 GB, the default size is 500 MB.

1 Press the **MENU** key.

2 Press the Δ or ∇ key repeatedly until e-MPS > appears.

```
e-MPS >
```

3 Press the \triangleright key.

4 Press the Δ or ∇ key repeatedly until >e-MPS Configuration > appears.

```
>e-MPS >
Configuration
```

5 Press the \triangleright key.

6 Press the Δ or ∇ key repeatedly until >>Temp. Code JOB Size appears.

```
>>Temp. Code JOB
Size 0500MB
```

7 To change the maximum disk space, press the **ENTER** key. A blinking cursor () appears.

```
>>Temp. Code JOB
Size 0500MB
```

8 Press the Δ or ∇ key to increase or decrease, respectively, the value at the blinking cursor. Use the \triangleright and \triangleleft keys to move the cursor right and left.

9 When the desired size is displayed, press the **ENTER** key.

10 Press the **MENU** key. The display returns to Ready.

Maximum Space Assigned to Permanent Code Jobs

This changes the hard disk space that holds permanent code jobs. You can change the maximum space from 0 to 9999 (megabytes). The actual maximum size depends on the size of free hard disk space, however. The default size is 1/6 of the total hard disk space, rounded off in units of 50 MB. For example, if the total hard disk space is 3.2 GB, the default size is 500 MB.

1 Press the **MENU** key.

2 Press the Δ or ∇ key and select e-MPS >.

```
e-MPS >
```

3 Press the \triangleright key.

4 Press the Δ or ∇ key repeatedly until >e-MPS Configuration > appears.

```
>e-MPS >  
Configuration
```

5 Press the \triangleright key.

6 Press the Δ or ∇ key and select >>Perm. Code JOB Size.

```
>>Perm. Code JOB  
Size 0500MB
```

7 Press the **ENTER** key, the message display shows a blinking cursor (_).

```
>>Perm. Code JOB  
Size 0500MB
```

8 Press the Δ or ∇ key to increase or decrease, respectively, the value at the blinking cursor. Use the \triangleright and \triangleleft keys to move the cursor right and left.

9 When the desired size is displayed, press the **ENTER** key.

10 Press the **MENU** key and the message display returns to Ready.

Maximum Space Assigned to Virtual Mailboxes (VMB)

This changes the hard disk space for virtual mailboxes. You can change the maximum space from 0 to 9999 (megabytes). The actual maximum size depends on the size of free hard disk space, however. The default size is 1/6 of the total hard disk space, rounded off in units of 50 MB. For example, if the total hard disk space is 3.2 GB, the default size is 500 MB.

1 Press the **MENU** key.

2 Press the Δ or ∇ key until e-MPS > appears.

```
e-MPS >
```

3 Press the \triangleright key.

4 Press the Δ or ∇ key and select >e-MPS Configuration >.

```
>e-MPS >  
Configuration
```

5 Press the \triangleright key.

6 Press the Δ or ∇ key and select >>VMB Size.

```
>>VMB Size  
0500MB
```

7 To change the maximum size, press the **ENTER** key. The message display shows a blinking cursor (_).

```
>>VMB Size  
0500MB
```

8 Press the Δ or ∇ key to increase or decrease, respectively, the value at the blinking cursor. Use the \triangleright and \triangleleft keys to move the cursor right and left.

9 When the desired size is displayed, press the **ENTER** key.

10 Press the **MENU** key to exit the menu selection.

2.2.4 Changing the Interface Parameters

The printer is equipped with both a parallel and serial interface or a network interface. Various printing environment parameters such as the default emulation can be changed independently on different interfaces by using the printer's menu selection system. Select the interface to apply the changes in the procedure described below.

NOTE

This interface selection described below does not select which interface data will be received from. The printer automatically selects an interface.

Changing Parallel Interface Modes

The parallel interface supports a bi-directional/high-speed mode according to IEEE standards. Normally, this interface is used under the default setting Auto. For details, see [Appendix B Host Computer Interface](#). After setting the interface, be sure to reset the printer or turn the power off at least once. The new setting will be enabled thereafter.

1 Press the **MENU** key.

2 Press the Δ or ∇ key repeatedly until `Interface >` appears. One of the interface names shown below appears, indicating the current interface.

```
Parallel (default)
USB
Network
Option (only when an optional network interface
card is installed)
Serial (only when an optional serial interface board
is installed)
```

3 Press the **ENTER** key. A blinking question mark (?) appears.

```
Interface >
?Parallel
```

If `Parallel` is not displayed, press the Δ or ∇ key repeatedly until `Parallel` appears.

4 Press the **ENTER** key again.

5 Press the \triangleright key. The message display changes to the communication mode menu.

6 Press the **ENTER** key. A blinking question mark (?) appears.

```
>Parallel I/F
?Nibble (high)
```

7 Press the Δ or ∇ key to display the desired mode. The display changes as shown below. Press the **ENTER** key.

```
AUTO (default)
Normal
High speed
Nibble (high)
```

8 Press the **MENU** key. The message display returns to `Ready`.

Changing Serial Interface Modes

You can set the baud rate, data bits, stop bits, parity, and protocol for the serial interface.

NOTE

This section applies to the printer having the optional serial interface board kit (IB-11) installed.

1 Press the **MENU** key.

2 Press the Δ or ∇ key repeatedly until `Interface >` appears. One of the interface names shown below appears, indicating the current interface.

```
Parallel (default)
USB
Network
Option (only when an optional network interface
card is installed)
Serial (only when an optional serial interface board
is installed)
```

3 Press the **ENTER** key. A blinking question mark (?) appears.

```
Interface
?Parallel
```

4 Press the Δ or ∇ key repeatedly until `Serial` appears.

```
Interface
?Serial
```

5 Press the **ENTER** key again.

6 Press the \triangleright key. Each time the \triangle or ∇ key is pressed, the setting item and current setting change as shown below.

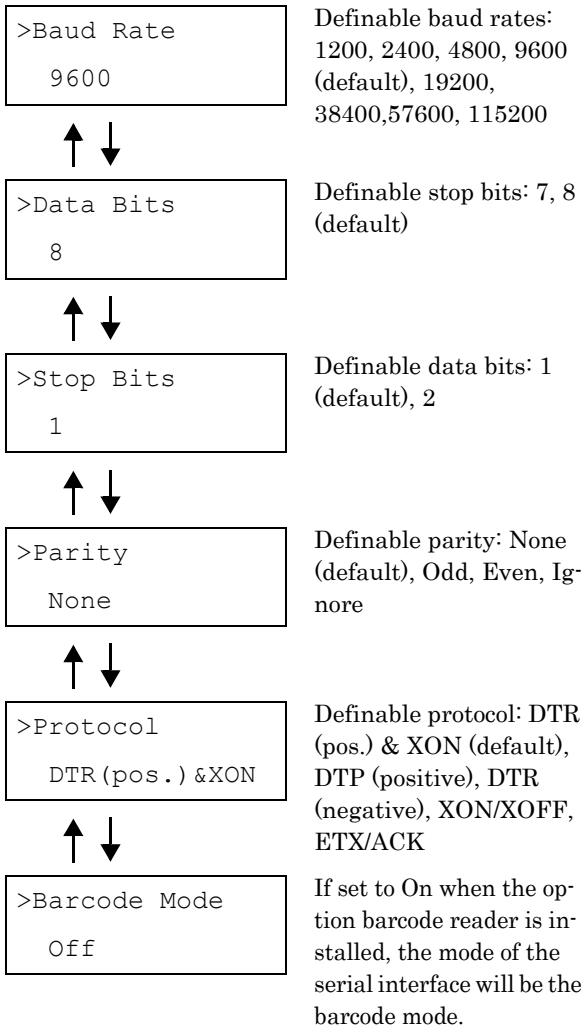

7 Display the setting item to be changed and press the **ENTER** key. A question mark (?) appears.

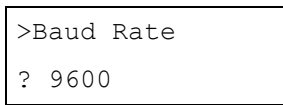

8 Press the \triangle or ∇ key to display the desired setting. The baud rate can be selected from 1200, 2400, 4800, 9600 (default), 19200, 38400, 57600, and 115200.

NOTE

Some computers may not be compatible with a baud rate of 115200 bps. If you set the baud rate to 115200 and communication problems occur, lower the baud rate.

9 Display the desired baud rate and press the **ENTER** key.

10 Press the **MENU** key. The message display returns to Ready.

Changing Network Interface Parameters

This printer supports TCP/IP, NetWare and EtherTalk protocols. In addition, you can install the optional network interface card in the option interface slot.

Using the operator panel, you can:

- Activate or deactivate TCP/IP, NetWare and AppleTalk
- Activate or deactivate DHCP
- Enter IP address, subnet mask address, and default gateway address
- Determine whether to print a network status page when the printer is turned on

To confirm or change network card parameters, proceed as follows:

For details on networking, refer to the Quick Configuration Guide.

1 Press the **MENU** key.

2 Press the \triangle or ∇ key repeatedly until Interface > appears. One of the interface names shown below appears, indicating the current interface.

- Parallel (default)
- USB
- Network
- Option (only when an optional network interface card is installed)
- Serial (only when an optional serial interface board is installed)

3 Press the **ENTER** key. A blinking question mark (?) appears.

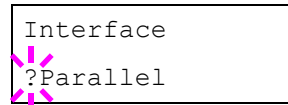

4 Press the \triangle or ∇ key repeatedly until Network appears.

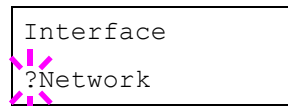

5 Press the **ENTER** key again.

6 Press the \triangleright key. Each time the \triangle or ∇ key is pressed, the display changes as shown below.

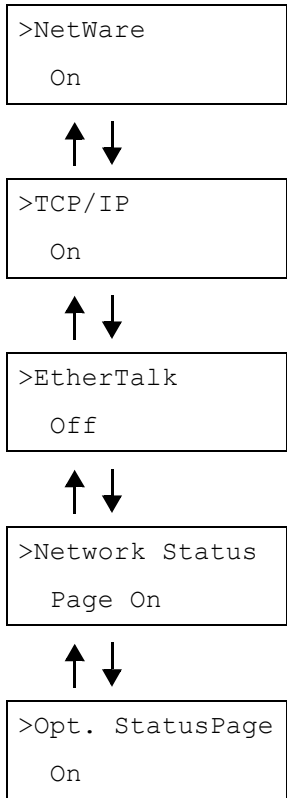

If ON, print the standard Network Interface Status Page after the Printer Status Page. See [page 3-11](#).

If ON, print the optional Network Interface Status Page after the Printer Status Page. See [page 3-11](#).

7 The following example explains how to activate TCP/IP protocol to connect the printer in the network. You can select Netware or EtherTalk in a similar manner.

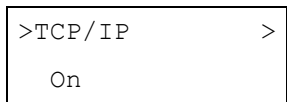

If TCP/IP is currently displays *Off*, select *On* using the \triangle or ∇ key. Press the **ENTER** key again.

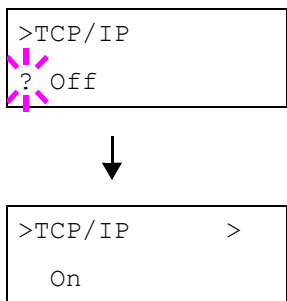

8 Press the \triangleright key. Each time the \triangle or ∇ key is pressed, the item changes as shown below.

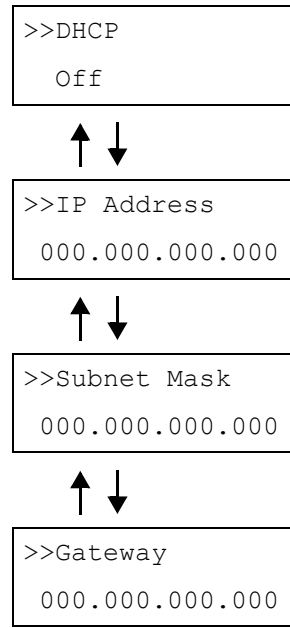

9 Display the item to be set and press the **ENTER** key. For DHCP, a question mark (?) appears. For IP Address, Subnet Mask, and Gateway, the cursor ($_$) blinks.

10 For DHCP, select *On* or *Off* using the \triangle or ∇ key. For IP Address, Subnet Mask, and Gateway addresses, press the \triangle or ∇ key to change the number (000 to 255) where the cursor is blinking. You can use the \triangleright and \triangleleft key to move the cursor right and left.

To obtain these addresses, consult your network administrator.

11 Press the **ENTER** key.

12 Press the **MENU** key. The message display returns to *Ready*.

Printing a Network Interface Status Page

You can print out a status page for the network interface. The network interface status page shows the firmware version, the network addresses, and other information under various network protocols about the network interface. The default setting is *On* (print). The network interface status page will be printed out after the printer status page.

NOTE

Printing out a network interface status page may not be possible with some optional network interface cards. For details, see the manual for the network interface.

1 Press the **MENU** key.

2 Press the Δ or ∇ key repeatedly until `Interface >` appears.

```
Interface >
Parallel
```

3 Press the **ENTER** key. A blinking question mark (?) appears.

```
Interface
?Parallel
```

4 Press the Δ or ∇ key repeatedly until `Network ap` appears.

```
Interface
?Network
```

5 Press the **ENTER** key again. The question mark (?) disappears

```
Interface >
Network
```

6 Press the \triangleright key and then press the Δ or ∇ key repeatedly until the message display indicates `>Network Status Page.`

```
>Network Status
Page On
```

7 The default setting is `On`. If it is set to `Off`, change it as follows. Press the **ENTER** key. A blinking question mark (?) appears.

```
>Network Status
Page ? On
```

8 Select `On` using the Δ or ∇ key.

```
>Network Status
Page ? Off
```

9 Press the **ENTER** key again.

```
>Network Status
Page Off
```

10 Press the **MENU** key. The message display returns to `Ready`.

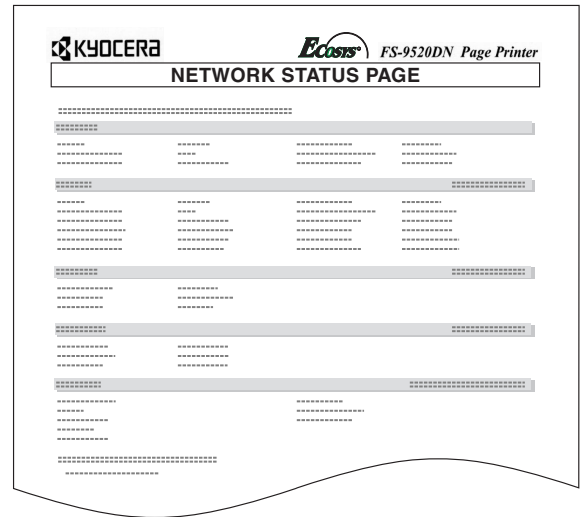

Network Status Page

Figure 3-8

2.2.5 Changing the Emulation

The emulation mode for the current interface can be changed.

1 Press the **MENU** key.

2 Press the Δ or ∇ key repeatedly until `Emulation` appears. One of the emulation names shown below appears, indicating the current emulation.

```
PCL 6 (default)
KC-GL
KPDL
KPDL (AUTO)
Line Printer
IBM Proprinter
DIABLO 630
EPSON LQ-850
```

3 Press the **ENTER** key. A blinking question mark (?) appears.

```
Emulation
?PCL 6
```

4 Press the Δ or ∇ key repeatedly until the desired emulation mode appears.

5 Press the **ENTER** key.

6 Press the **MENU** key. The message display returns to `Ready`.

KPDL (AUTO) Emulation

KPDL is the Kyocera's implementation of the PostScript language. The KPDL (AUTO) emulation enables the printer to automatically change the emulation mode according to the data received when printing.

In addition to KPDL (AUTO) emulation, you can use the operator panel to set another emulation mode that is used very often. The default setting is PCL 6.

1 Press the **MENU** key.

2 Press the Δ or ∇ key repeatedly until Emulation appears.

```
Emulation
PCL 6
```

3 Press the **ENTER** key. A blinking question mark (?) appears.

```
Emulation
?PCL 6
```

4 Press the Δ or ∇ key repeatedly until KPDL (AUTO) appears.

```
Emulation
?KPDL (AUTO)
```

5 Press the **ENTER** key.

6 Press the \triangleright key. When \triangleright Alt. Emulation is displayed, press the Δ or ∇ key. The names of alternative emulations appear.

```
PCL 6 (default)
KC-GL
Line Printer
IBM Proprinter
DIABLO 630
EPSON LQ-850
```

7 Press the **ENTER** key. A blinking question mark (?) appears.

```
Alt. Emulation
?PCL 6
```

8 Press the Δ or ∇ key repeatedly until the desired alternative emulation appears.

9 Press the **ENTER** key.

10 Press the **MENU** key. The message display returns to Ready.

Auto Printing of KPDL Error

The printer can be set to print error data during KPDL emulation. If this is set to On, error data will be printed only when trouble occurs during printing. The factory default setting is Off.

1 Press the **MENU** key.

2 Press the Δ or ∇ key repeatedly until Emulation appears.

```
Emulation
PCL 6
```

3 Press the **ENTER** key. A blinking question mark (?) appears.

```
Emulation
?PCL 6
```

4 Select KPDL or KPDL (AUTO) using the Δ or ∇ key.

```
Emulation
?KPDL
```

5 Press the **ENTER** key.

6 Press the \triangleright key. The message display changes to that shown below. If \triangleright Print KPDL Errs is displayed when the KPDL (AUTO) emulation is selected, press the Δ or ∇ key to change it.

```
>Print KPDL Errs
Off
```

7 Press the **ENTER** key. A blinking question mark (?) appears.

```
>Print KPDL Errs
?Off
```

8 Select On using the Δ or ∇ key.

```
>Print KPDL Errs
?On
```

9 Press the **ENTER** key.

10 Press the **MENU** key. The message display returns to Ready.

Chapter 3 Using the Operator Panel

KC-GL Pen Width

The KC-GL emulation mode enables you to set the pen widths in dots, for pen numbers 1 to 8, and the KC-GL page size.

1 Press the **MENU** key.

2 Press the Δ or ∇ key repeatedly until Emulation appears on the message display.

```
Emulation
PCL 6
```

3 If the current emulation is other than KC-GL, press the **ENTER** key. A blinking question mark (?) appears.

```
Emulation
?PCL 6
```

4 Press the Δ or ∇ key repeatedly until KC-GL appears.

```
Emulation
?KC-GL
```

5 Press the **ENTER** key.

```
Emulation
KC-GL
```

6 Press the \triangleright key to move to the >KC-GL Pen Width submenu.

```
>KC-GL >
Pen Width
```

7 Press the \triangleright key.

```
>>Pen(1) Width
01 dot(s)
```

8 Press the Δ or ∇ key repeatedly until the desired pen number of 1 to 8 appears.

9 When the desired pen number is displayed, press the **ENTER** key.

10 To change the pen width, press the \triangleright key, then press the **ENTER** key. A blinking cursor appears at the width value.

```
>>Pen(1) Width
02 dot(s)
```

Press the Δ or ∇ key repeatedly until the desired pen width in dots (00 to 99) appears. When the desired pen width is displayed, press the **ENTER** key.

11 To set the KC-GL page size, press the \triangleleft key, then press the Δ or ∇ key until >KC-GL Page Set is displayed.

12 To change the page size, press the **ENTER** key. A blinking question mark (?) appears.

```
>KC-GL Page Set
? [SPSZ]
```

Press the 3 or 4 key repeatedly until the desired page size (A2, A1, A0, B3, B2, B1, B0, and SPSZ) appears. When selecting SPSZ, printing will be done with the paper size specified by the PRESCRIBE SPSZ command. For details, see [Programming Manual](#) in the CD-ROM.

13 Press the **ENTER** key to set the page set you just selected.

14 Press the **MENU** key. The display returns to Ready.

2.2.6 Setting the Default Font

You can select the default font for the current interface. In addition to the internal fonts, all fonts that are downloaded to the printer memory, or fonts stored on a memory card, hard disk, or option ROM, can be selected as the default font.

In this menu, you can also set the type and pitch for Courier and Letter Gothic; as well as print a font list.

Selecting the Default Font

1 Press the **MENU** key.

2 Press the Δ or ∇ key repeatedly until Font > appears.

```
Font >
```

- 3** Press the \triangleright key to select an internal font, press the \triangle or ∇ key repeatedly until **Internal** appears.

```
>Font Select >
  Internal
```

To select an option font, press the **ENTER** key while \triangleright Font Select \triangleright is displayed. Press the \triangle or ∇ key repeatedly until the message display indicates **Option**. This operation is possible only when option fonts are installed in the printer.

- 4** Press the \triangleright key.

```
>> I000
```

The letter before the number indicates the type of font as follows:

Letter	Description
I	Internal fonts
S	Soft (down load) fonts
M	Fonts in an option memory card
H	Fonts in a RAM disk or hard disk
O	Fonts in an option ROM

Table 3-8

- 5** Press the **ENTER** key. A blinking question mark (?) appears.

```
>>?I000
```

- 6** Press the \triangle or ∇ key repeatedly until the desired font number appears. For font numbers of the internal fonts, see [List of Fonts on page 6-1](#).

```
>Font Select >
  Internal
```

- 7** When the desired font is displayed, press the **ENTER** key.

- 8** Press the **MENU** key. The message display returns to **Ready**.

Changing Type for Courier/Letter Gothic

Courier or Letter Gothic font type can be selected as Regular or Dark. For example, to change the type of Courier, proceed as follows:

- 1** Press the **MENU** key.

- 2** Press the \triangle or ∇ key repeatedly until **Font** \triangleright appears.

```
Font >
```

- 3** Press the \triangleright key.

- 4** Check that **Internal** is displayed and press the \triangleright key.

```
>Font Select >
  Internal
```

- 5** Press the \triangle or ∇ key repeatedly until \triangleright Courier appears.

```
>>Courier
  Regular
```

- 6** Press the **ENTER** key. A blinking question mark (?) appears.

```
>>Courier
? Regular
```

- 7** Select **Regular** or **Dark** using the \triangle or ∇ key.

- 8** Press the **ENTER** key.

- 9** Press the **MENU** key and the message display returns to **Ready**.

Changing the Font Size

You can change the size of the default font. If the default font is a fixed-pitch font such as Courier or Letter Gothic, the character pitch can be changed instead of the font size.

- 1** Press the **MENU** key.

- 2** Press the \triangle or ∇ key repeatedly until **Font** \triangleright appears.

```
Font >
```

3 Press the \triangleright key.

4 Check that `Internal` is displayed and press the \triangleright key.

```
>Font Select >
Internal
```

5 Press the \triangle or ∇ key repeatedly until `>Size` appears.

```
>Size
012.00 point(s)
```

6 Press the **ENTER** key. A blinking cursor (`_`) appears.

```
>Size
012.00 point(s)
```

7 Press the \triangle or ∇ key to increase or decrease the value of the figure where the cursor is blinking. The font size can be set between 4 and 999.75 points, in 0.25-point increments. You can use the \triangleright and \triangleleft key to move the cursor right and left.

8 When the desired size is displayed, press the **ENTER** key.

9 Press the **MENU** key. The message display returns to `Ready`.

Setting the Character Pitch for Courier/Letter Gothic

You can set the character pitch for fixed-pitch fonts when the default font is Courier or Letter Gothic.

1 Press the **MENU** key.

2 Press the \triangle or ∇ key repeatedly until `Font >` appears.

```
Font >
```

3 Press the \triangleright key.

4 Check that `Internal` is displayed and press the \triangleright key.

```
>Font Select >
Internal
```

5 Press the \triangle or ∇ key repeatedly until `>Pitch` appears.

```
>Pitch
10.00 cpi
```

6 Press the **ENTER** key. A blinking cursor (`_`) appears.

```
>Pitch
10.00 cpi
```

7 Press the \triangle or ∇ key to increase or decrease the value of the figure where the cursor is blinking. The character pitch can be set between 0.44 and 99.99 characters per inch, in 0.01 character-per-inch increments. You can use the \triangleright and \triangleleft keys to move the cursor right and left.

8 When the desired size is displayed, press the **ENTER** key.

9 Press the **MENU** key. The message display returns to `Ready`.

Setting the character code set

You can change the character code set. Available character code sets vary depending on the current font. (The default character code set is IBM PC-8.)

1 Press the **MENU** key.

2 Press the \triangle or ∇ key repeatedly until `Font >` appears.

```
Font >
```

3 Press the \triangleright key.

4 Press the \triangle or ∇ key repeatedly until `> Code Set` appears.

```
>Code Set >
IBM PC-8
```

5 Press the **ENTER** key. A blinking cursor (`?`) appears.

```
>Code Set
??IBM PC-8
```

- 6** Press the Δ or ∇ key until the desired character code set appears.
- 7** Press the **ENTER** key.
- 8** Press the **MENU** key. The display returns to Ready.

Printing a List of Fonts

To help in selecting fonts, you can print a list of the fonts including option fonts.

- 1** Press the **MENU** key.
- 2** Press the Δ or ∇ key repeatedly until Font > appears.



- 3** Press the \triangleright key.

- 4** Press the Δ or ∇ key repeatedly until List of Internal Fonts appears. List of Option Fonts appears.

(Internal Fonts)

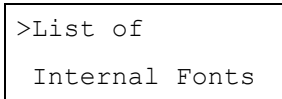

(Optional Fonts)

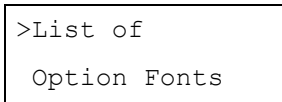

- 5** Press the **ENTER** key. A question mark (?) appears.

(Internal Fonts)

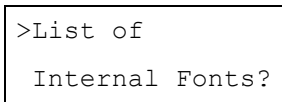

(Optional Fonts)

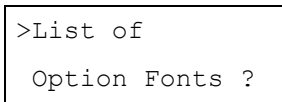

- 6** Press the **ENTER** key again. Processing appears, then Ready. The printer prints a list of fonts with a short sample and font ID (number) for each font.

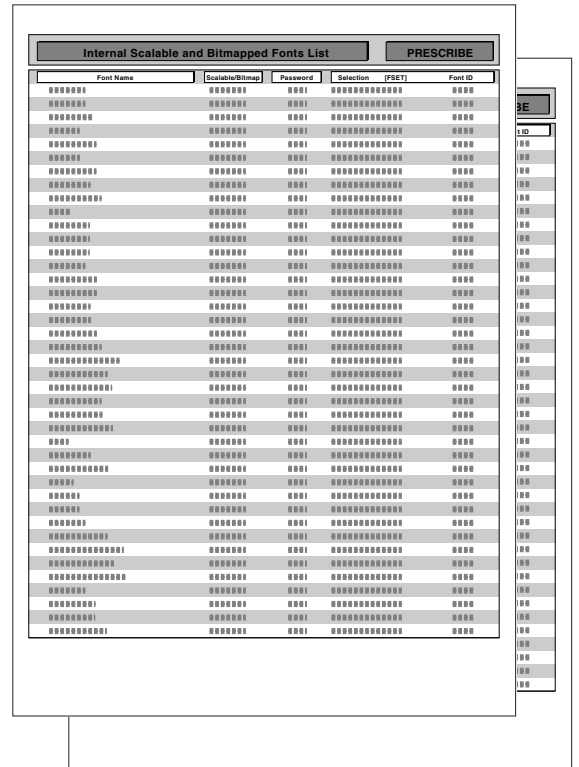

List of Fonts

Figure 3-9

2.2.7 Using Page Set Menus

In Page Set menus, you can set the number of copies, the page orientation, and other settings regarding pagination.

Setting the Number of Copies

You can set the number of copies of each page to be printed for the current interface. The number of copies can be set between 1 and 999. The number of copies can be set whenever the message display indicates Ready.

- 1** Press the **MENU** key.
- 2** Press the Δ or ∇ key repeatedly until Page set > appears.

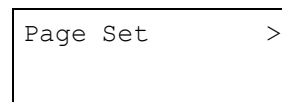

- 3** Press the \triangleright key.

- 4** Press the Δ or ∇ key repeatedly until >Copies appears.

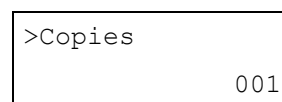

Chapter 3 Using the Operator Panel

- 5** Press the **ENTER** key. A blinking cursor (`_`) appears.



- 6** Press the Δ or ∇ key to increase or decrease the value of the figure where the cursor is blinking. It can be set between 1 and 999. You can use the \triangleright and \triangleleft keys to move the cursor right and left.

- 7** When the desired size is displayed, press the **ENTER** key.

- 8** Press the **MENU** key. The message display returns to Ready.

Selecting the Reduced Print

You can print with the reduced size. This menu is used to set the source paper size and the paper size to use after reduction.

NOTE

Printed results when making reductions differ from equivalent size printing. Sometimes the line width of characters may not be consistent or lines may appear in figures or image patterns.

Bring up the **Zoom** menu. The following display will appear.

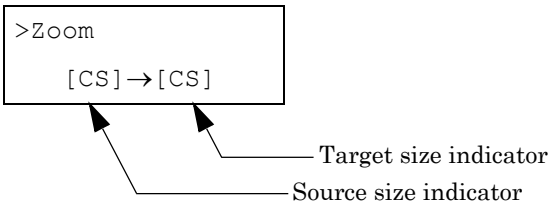

Source size indicator...This is the paper size before reduction. This must be the same as the paper size set for print data from the computer.

Target size indicator...This is the paper size after reduction. This must be the same as the paper size set for the paper cassette.

The message display will show the messages given in the following table.

Source size indicator	Target size indicator
[CS] Current cassette size	[CS] [CS] 98%
[LG] Legal size (8-1/2 × 14 inches)	[LG] [LG] 98%
[LT] Letter size (8-1/2 × 11 inches)	[LT] [A4] [LT] 98%
[LD] Ledger size (12 × 15-1/2 inches)	[LD] [LD] 98%
[ST]	[ST]
[O2]	[O2]
[FO]	[FO]
[A5] (14.8 × 21 cm)	[A5] [A5] 98%
[B5] (18.2 × 25.7 cm)	[B5] [A5] [B5] 98%
[A4] (21 × 29.7 cm)	[A4] [LT] [B5] [A5] [A4] 98%
[B4] (25.7 × 36.4 cm)	[B4] [B5] [A4] [B4] 98%
[A3] (29.7 × 42cm)	[A3] [A4] [B4] [A3] 98%

Table 3-9

- 1** Press the **MENU** key.
- 2** Press the Δ or ∇ key repeatedly until **Page Set >** appears.

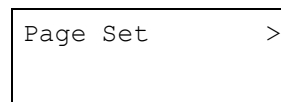

- 3** Press the \triangleright key.

- 4** Press the Δ or ∇ key repeatedly until **>Zoom** appears.

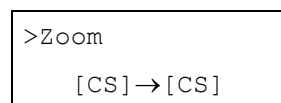

- 5 Press the **ENTER** key. A blinking cursor () appears under the paper size.

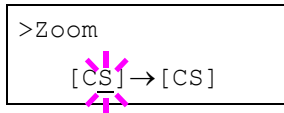

- 6 Press the Δ or ∇ key to select source size. Both sizes change will simultaneously.

- 7 Press the \triangleright key to move the cursor to the target size.

- 8 To make a reduced print, press the Δ or ∇ key to select the target size.

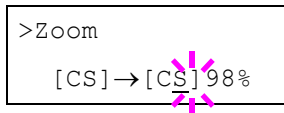

- 9 Press the **ENTER** key.

- 10 Press the **MENU** key. The message display returns to Ready.

Selecting the Printing Orientation

You can select the portrait or landscape page orientation. The page orientation can be set whenever the message display indicates Ready.

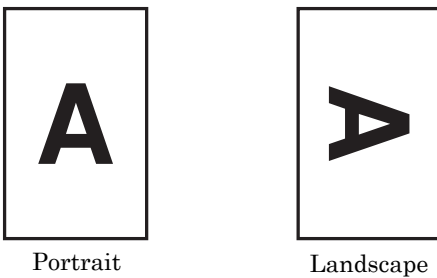
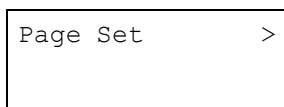

Figure 3-10

- 1 Press the **MENU** key.
- 2 Press the Δ or ∇ key repeatedly until Page Set > appears.



- 3 Press the \triangleright key.

- 4 Press the Δ or ∇ key repeatedly until >Orientation appears.

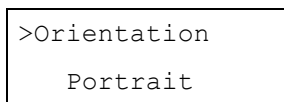

- 5 Press the **ENTER** key. A blinking question mark (?) appears.

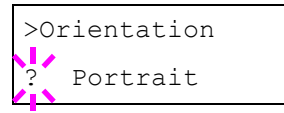

- 6 Select Portrait or Landscape using the Δ or ∇ key.

- 7 Press the **ENTER** key.

- 8 Press the **MENU** key. The message display returns to Ready.

Page Protect Mode

Although Auto is the default setting and this menu does not usually appear, Page Protect will be forcibly set to On if a Print overrun Press GO error occurs due to insufficient printer memory. Be sure to return this setting to Auto in order to maintain high printer memory efficiency. This can be done as follows.

- 1 Press the **MENU** key.

- 2 Press the Δ or ∇ key repeatedly until Page Set > appears.

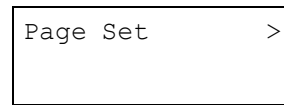

- 3 Press the \triangleright key.

- 4 Press the Δ or ∇ key repeatedly until >Page Protect appears.

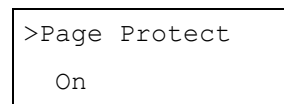

- 5 Press the **ENTER** key. A blinking question mark (?) appears.

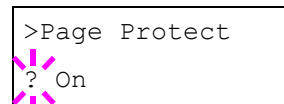

- 6 Press the Δ or ∇ key repeatedly until Auto appears.

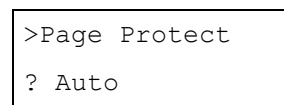

- 7 Press the **ENTER** key.

- 8 Press the **MENU** key. The message display returns to Ready.

Chapter 3 Using the Operator Panel

Linefeed (LF) Action

This procedure instructs the printer what to do when it receives a linefeed code (character code 0AH).

1 Press the **MENU** key.

2 Press the Δ or ∇ key repeatedly until Page Set > appears.

```
Page Set >
```

3 Press the \triangleright key.

4 Press the Δ or ∇ key repeatedly until >LF Action appears.

```
>LF Action  
LF only
```

5 Press the **ENTER** key. A blinking question mark (?) appears.

```
>LF Action  
? LF only
```

6 Press the Δ or ∇ key repeatedly until desired linefeed action appears.

LF only	A linefeed is performed. (default)
CR and LF	A linefeed and carriage return are performed.
Ignore LF	The linefeed is ignored.

7 When the desired action is displayed, press the **ENTER** key.

8 Press the **MENU** key. The message display returns to Ready.

Carriage-Return (CR) Action

This procedure instructs the printer what to do when it receives a carriage-return code (character code 0DH).

1 Press the **MENU** key.

2 Press the Δ or ∇ key repeatedly until Page Set > appears.

```
Page Set >
```

3 Press the \triangleright key.

4 Press the Δ or ∇ key repeatedly until >CR Action appears.

```
>CR Action  
CR only
```

5 Press the **ENTER** key. A blinking question mark (?) appears.

```
>CR Action  
? CR only
```

6 Press the Δ or ∇ key repeatedly until desired carriage-return action appears.

CR only	A carriage-return is performed. (Default)
CR and LF	A carriage-return and linefeed are performed.
Ignore CR	The carriage-return code is ignored.

7 When the desired action is displayed, press the **ENTER** key.

8 Press the **MENU** key. The message display returns to Ready.

Wide A4

Turn this On to increase the maximum number of characters that can be printed in a line for A4 page (78 characters at 10 pitch) and Letter size page (80 characters at 10 pitch). This setting is effective only in PCL 6 emulation.

1 Press the **MENU** key.

2 Press the Δ or ∇ key repeatedly until Page Set > appears.

```
Page Set >
```

3 Press the \triangleright key.

4 Press the Δ or ∇ key repeatedly until >Wide A4 appears.

```
>Wide A4  
Off
```

5 Press the **ENTER** key. A blinking question mark (?) appears.

```
>Wide A4  
? Off
```

- 6** Select On or Off using the Δ or ∇ key.
- 7** Press the **ENTER** key.
- 8** Press the **MENU** key. The message display returns to Ready.

2.2.8 Setting the Print Quality

You can make the following settings to enhance the print quality: Kyocera Image Refinement (KIR), a software algorithm for increasing printout quality; EcoPrint, a printing mode that reduces toner consumption during printing; printing resolution; and Adjustment of Print Density.

KIR (Kyocera Image Refinement)

This printer incorporates the KIR (Kyocera Image Refinement) smoothing function. At a resolution of 600 dpi this function provides high print quality by providing software enhanced print resolution.

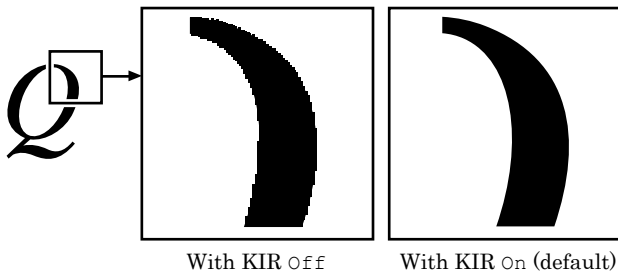

Figure 3-11

NOTE

Set the print density to 3 when setting the KIR mode. For details on print density, see [page 3-32](#). You can monitor the KIR test pattern, the last line on a status page, to make the optimum KIR mode setting.

- 1** Press the **MENU** key.
 - 2** Press the Δ or ∇ key repeatedly until Print Quality > appears.
- ```
Print Quality >
```
- 3** Press the  $\triangleright$  key.
  - 4** Press the  $\Delta$  or  $\nabla$  key repeatedly until >KIR Mode appears.

```
>KIR Mode
 On
```

- 5** Press the **ENTER** key. A blinking question mark (?) appears.

```
>KIR Mode
? On
```

- 6** Select On or Off using the  $\Delta$  or  $\nabla$  key.
- 7** Press the **ENTER** key.
- 8** Press the **MENU** key. The message display returns to Ready.

#### EcoPrint

The EcoPrint enables you to reduce the amount of toner consumed on the page so as to save your printing costs. You can set EcoPrint mode On, as follows. (The factory default setting is Off.) The EcoPrint mode setting is On when the printing image becomes lighter, yet very readable.

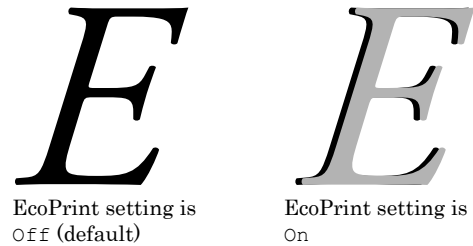

Figure 3-12

#### NOTE

The EcoPrint setting has no effect on the print speed.

- 1** Press the **MENU** key.
  - 2** Press the  $\Delta$  or  $\nabla$  key repeatedly until Print Quality > appears.
- ```
Print Quality >
```
- 3** Press the \triangleright key.
 - 4** Press the Δ or ∇ key repeatedly until >EcoPrint Mode appears.

```
>EcoPrint Mode
  Off
```

- 1 Press the **ENTER** key. A blinking question mark (?) appears.

```
>EcoPrint Mode
? Off
```

- 2 Select On or Off using the Δ or ∇ key.

- 3 Press the **ENTER** key.

- 4 Press the **MENU** key. The message display returns to Ready.

Resolution

You can set the default print resolution in three ways: 300 dpi, 600 dpi and Fast 1200 mode. The clarity of printed characters and graphics becomes sharper in this order. (The factory setting is Fast 1200 mode.)

- 1 Press the **MENU** key.

- 2 Press the Δ or ∇ key repeatedly until Print Quality > appears.

```
Print Quality >
```

- 3 Press the \triangleright key.

- 4 Press the Δ or ∇ key repeatedly until >Resolution appears.

```
>Resolution
Fast 1200 mode
```

- 5 Press the **ENTER** key. A blinking question mark (?) appears.

```
>Resolution
? Fast 1200 mode
```

- 6 Select Fast 1200 mode or 300 dpi, 600 dpi using the Δ or ∇ key.

- 7 Press the **ENTER** key.

- 8 Press the **MENU** key. The message display returns to Ready.

Adjusting the Print Density

The print density can be adjusted in five steps: from 01 (light) to 05 (dark). The factory setting is 03.

- 1 Press the **MENU** key.

- 2 Press the Δ or ∇ key repeatedly until Print Quality > appears.

```
Print Quality >
```

- 3 Press the \triangleright key.

- 4 Press the Δ or ∇ key repeatedly until >Print Density appears.

```
>Print Density
03
```

- 5 Press the **ENTER** key. A blinking question mark (?) appears.

```
>Print Density
? 03
```

- 6 Select the print density from five steps from 01 (light) to 05 (dark) using the Δ or ∇ key.

- 7 Press the **ENTER** key.

- 8 Press the **MENU** key. The message display returns to Ready.

2.2.9 Operating an Option Hard Disk

By installing the option hard disk into the printer, the e-MPS function can be used. The printer's menu selection system allows you to perform the following operations on the hard disk.

If the option hard disk is not formatted, the >Format menu will automatically appear on the message display.

- Reading data
- Writing data
- Deleting data
- Printing of list of partitions

Reading Data

Data stored on a hard disk can be read. To read data on a hard disk, proceed as follows.

- 1 Press the **MENU** key.

- 2 Press the Δ or ∇ key repeatedly until `Hard Disk >` appears.



- 3 Press the \triangleright key.

- 4 Press the Δ or ∇ key repeatedly until `>Read Data` appears. The data name also appears.

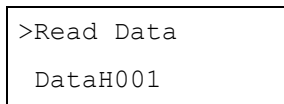

- 5 Press the **ENTER** key. A blinking question mark (?) appears before the data name.

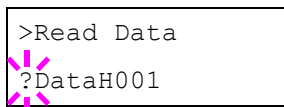

- 6 Press the Δ or ∇ key to display the desired data name.

- 7 Press the **ENTER** key. Processing appears and the reading of data from the hard disk starts.

Writing Data

When writing to a hard disk, a name is assigned to the file automatically. You can use the procedure explained later in this section to print a list of data names for confirmation. To write data onto a hard disk, proceed as follows.

First check that the hard disk is properly formatted. Otherwise, the `>Write Data` message to be explained below will not be shown on the message display.

- 1 Press the **MENU** key.

- 2 Press the Δ or ∇ key repeatedly until `Hard Disk >` appears.

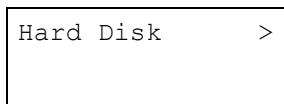

- 3 Press the \triangleright key.

- 4 Press the Δ or ∇ key repeatedly until `>Write Data` appears.

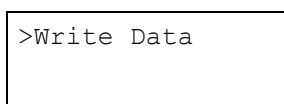

- 5 Press the **ENTER** key. A question mark (?) appears.

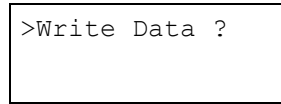

- 6 Press the **ENTER** key. Processing appears, then Waiting.

- 7 In this state, send the file from the computer to the printer.

The file is written onto the hard disk and given a destination name (also referred to as a partition name) which the printer automatically assigns one after another as follows:

- DataH001 (first data),
- DataH002 (second data),
- DataH003 (third data)...

In the example above, if the file TEST.TXT is the first data to be written onto the hard disk, the destination name will be DataH001.

As the printer receives data, the message display changes to `Processing`, then when the end of the data is received, the message display changes to `Waiting`.

- 8 Check that the message display has changed to `Waiting`, then press the **GO** key. This writes file to the hard disk and instructs the printer to automatically print out a hard disk write information page as shown below.

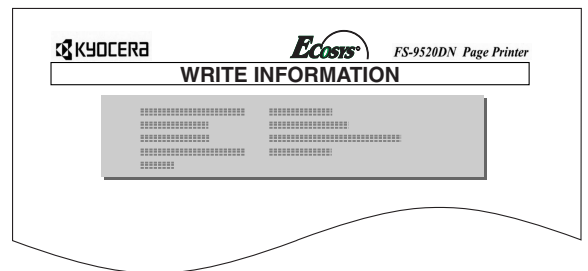

Figure 3-13

Partition Type:	Type of data written (currently only type 2 is supported).
Partition Name:	The destination name of data written to the hard disk.
Write Partition Length:	The size of the written data on the memory hard disk.
Others:	Error information.

When the hard disk write information page is printed, the message display returns to `Ready`.

If the writing was not completed successfully, an error code appears on the message display. For details, see [Error Messages on page 4-6](#). If this happens, press the **GO** key. The message display returns to `Ready`.

- 9 Repeat above steps until you have transferred all data (files) that you want to write to the hard disk. Each time you finish writing data, a hard disk write information page is printed from the printer showing the information explained in step 8 above, but pertaining only to the data just written. To see all data contained in the hard disk at once, print a list of data names as explained. See *Printing a List of Data Names on page 3-34*.

Deleting Data

It is possible to use the printer to delete data from a hard disk one by one. To delete data from a hard disk, proceed as follows.

Check that the hard disk contains data. Otherwise, the >Delete Data menu will not appear on the message display.

- 1 Press the **MENU** key.
- 2 Press the Δ or ∇ key repeatedly until Hard Disk > appears.

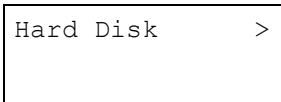

- 3 Press the \triangleright key.

- 4 Press the Δ or ∇ key repeatedly until >Delete Data appears. The data name also appears.

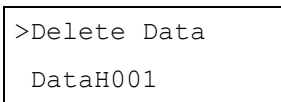

- 5 Press the **ENTER** key. A blinking question mark (?) appears before the data name.

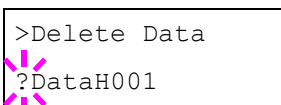

- 6 Press the Δ or ∇ key to display the desired data name.

- 7 Press the **ENTER** key. Processing appears and the data is deleted from the hard disk. The message display returns to Ready.

Printing a List of Data Names

The printer prints a list of all data names (referred to as partitions) stored in a hard disk for reference. To print a list of data names for the hard disk, proceed as follows.

- 1 Press the **MENU** key.
- 2 Press the Δ or ∇ key repeatedly until Hard Disk > appears.

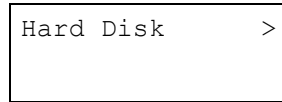

- 3 Press the \triangleright key.

- 4 Press the Δ or ∇ key repeatedly until >List of Partitions appears.

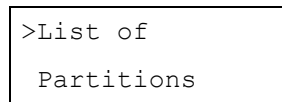

- 5 Press the **ENTER** key. A question mark (?) appears.

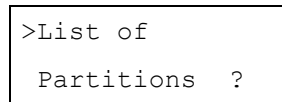

- 6 Press the **ENTER** key. Processing appears and the printing of the list starts.

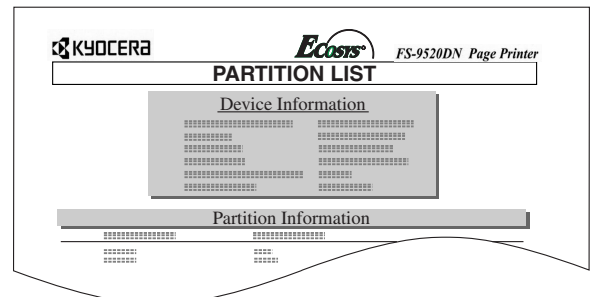

Figure 3-14

The printout (example above) includes the following information;

- Device Name/Number: HARD DISK/0 is indicated for the hard disk.
- Capacity: The total capacity of the hard disk in bytes.
- Used Space: The total size of the data stored in the hard disk in bytes.
- Free Space: The size of the capacity remaining in the hard disk for storing further data, including the amount of memory that the printer uses for its system.
- Partition Name: The name of the written data assigned automatically by the printer.

Partition Size: The size of the written data in bytes.
 Partition Type: The type of the written data i.e., whether it is host data (Data) or font data (Font).

When the list of file names (partition list) for the hard disk is printed, the message display returns to Ready.

It also prints out the Directory Status List to confirm the directory or data that is written in PJJ or KPDL (PostScript).

2.2.10 Operating the RAM Disk

The RAM disk is a memory space shared within the printer memory that can temporarily store print jobs. The RAM disk can be used only for electronic sorting. The stored print job can then be used to print multiple copies of the job reducing the total amount of time required to print the whole job. It acts similarly to the hard disk except that the data is effective only when the printer is powered up.

To set up the RAM disk, the option hard disk must not be installed.

To use the RAM disk, activate and enter the desired size of the RAM disk in the manner described below. The maximum RAM disk size can be calculated as follows:

FS-9120DN:

Maximum RAM size = Total printer memory minus 36 MB

FS-9520DN:

Maximum RAM size = Total printer memory minus 24 MB

For example, if the total memory installed in your printer (FS-9520DN) is 64 MB (Default), you can set 40 MB of RAM disk. If you attempt to set the RAM disk size beyond this restriction, the printer automatically rounds it down so that the size is always 24 MB less than the total printer memory. Once the RAM disk size is set, the printer must be reset.

To activate RAM disk in the printer's memory, first you must use the printer's menu selection system. The printer's menu selection system allows you to perform the following operations on the RAM disk.

- Setting RAM disk size
- Reading data
- Writing data
- Deleting data
- Printing of list of partitions

By default, the RAM disk is not activated (Off). To confirm the RAM disk size or activate the RAM disk, proceed as follows:

Setting RAM Disk Size

1 Press the **MENU** key.

2 Press the Δ or ∇ key repeatedly until RAM Disk Mode > appears.

```
RAM Disk Mode
      Off
```

3 Press the **ENTER** key. A blinking question mark (?) appears.

```
RAM Disk Mode
? Off
```

4 Press the Δ or ∇ key to select On.

```
>RAM Disk Mode
? On
```

5 Press the **ENTER** key. A blinking question mark (?) disappears and > appears on the right side.

```
RAM Disk Mode >
      On
```

6 Press the \triangleright key.

7 Press the Δ or ∇ key repeatedly until >RAM Disk Size appears. The data size also appears.

```
>RAM Disk Size
      0028 MByte
```

8 Press the **ENTER** key. A blinking cursor () appears.

```
>RAM Disk Size
      0028 MByte
```

9 Press the Δ or ∇ key to display the desired size. Definable RAM disk size: 0001 to 1024 (display of size varies depending on the installed RAM size.)

10 Press the **ENTER** key. The selected RAM disk size is activated.

11 Press the **MENU** key. The message display returns to Ready.

Chapter 3 Using the Operator Panel

Reading Data

Data stored on a RAM disk can be read. To read data on a RAM disk, proceed as follows.

1 Press the **MENU** key.

2 Press the Δ or ∇ key repeatedly until RAM Disk Mode > appears.

```
RAM Disk Mode >
On
```

3 Press the \triangleright key.

4 Press the Δ or ∇ key repeatedly until >Read Data appears. The data name also appears.

```
>Read Data
DataH001
```

5 Press the **ENTER** key. A blinking question mark (?) appears before the data name.

```
>Read Data
? DataH001
```

6 Press the Δ or ∇ key to display the desired data name.

7 Press the **ENTER** key. Processing appears and the reading of data from the RAM disk starts.

Writing Data

When writing onto a RAM disk, a name is assigned to the file automatically. You can use the procedure explained later in this section to print a list of data names for confirmation.

1 Press the **MENU** key.

2 Press the Δ or ∇ key repeatedly until RAM Disk Mode > appears.

```
RAM Disk Mode >
On
```

3 Press the \triangleright key.

4 Press the Δ or ∇ key repeatedly until >Write Data appears.

```
>Write Data
```

5 Press the **ENTER** key. A question mark (?) appears.

```
>Write Data ?
```

6 Press the **ENTER** key. Processing appears, then Waiting.

7 In this state, send the file from the computer to the printer.

The file is written onto the RAM disk given a destination name (also referred to as a partition name) which the printer automatically assigns one after another as follows:

DataH001 (first data)
DataH002 (second data)
DataH003 (third data)...

In the example above, if the file TEST.TXT is the first data to be written onto the RAM disk, the destination name will be DataH001.

As the printer receives data, the message display changes to Processing, then when the end of the data is received, the message display changes to Waiting.

8 Check that the message display has changed to Waiting, then press the **GO** key. This writes the file to the RAM disk and instructs the printer to automatically print out a RAM disk write information page as shown below.

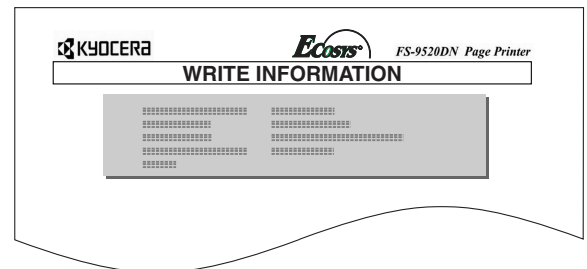

Figure 3-15

Partition Type:	Type of data written (currently only type 2 is supported).
Partition Name:	The destination name of data written to the card.
Write Partition Length:	The size of the written data on the memory card.
Others:	Error information.

When the RAM disk write information page is printed, the message display returns to Ready.

If the writing was not completed successfully, an error code appears on the message display. For details, see [Error Messages on page 4-6](#). If this happens, press the **GO** key. The message display returns to Ready.

- 9** Repeat above steps until you have transferred all data (files) that you want to write to the RAM disk. Each time you finish writing data, a RAM disk write information page is printed from the printer showing the information explained in step 8 above, but pertaining only to the data just written. To see all data contained in the RAM disk at once, print a list of data names as explained. See *Printing a List of Data Names on page 3-34*.

Deleting Data

It is possible to use the printer to delete data from a RAM disk one by one. To delete data from a RAM disk, proceed as follows.

Check that the RAM disk contains data. Otherwise, the >Delete Data will not appear on the message display.

- 1** Press the **MENU** key.
- 2** Press the Δ or ∇ key repeatedly until RAM Disk Mode > appears.

```
RAM Disk Mode >
On
```

- 3** Press the \triangleright key.

- 4** Press the Δ or ∇ key repeatedly until >Delete Data appears. The data name also appears.

```
>Delete Data
DataH001
```

- 5** Press the **ENTER** key. A blinking question mark (?) appears before the data name.

```
>Delete Data
?DataH001
```

- 6** Press the Δ or ∇ key to display the desired data name.

- 7** Press the **ENTER** key. Processing appears and the data is deleted from the RAM disk. The message display returns to Ready.

Printing a List of Data Names

The printer prints a list of all data names (referred to as partitions) stored in a RAM disk for reference. (Printing a list is also available for a font card.) To print a list of data names for the RAM disk, proceed as follows.

- 1** Press the **MENU** key.
- 2** Press the Δ or ∇ key repeatedly until RAM Disk Mode > appears.

```
RAM Disk Mode >
On
```

- 3** Press the \triangleright key.

- 4** Press the Δ or ∇ key repeatedly until >List of Partitions appears.

```
>List of
Partitions
```

- 5** Press the **ENTER** key. A question mark (?) appears.

```
>List of
Partitions ?
```

- 6** Press the **ENTER** key. Processing appears and the printing of the list starts.

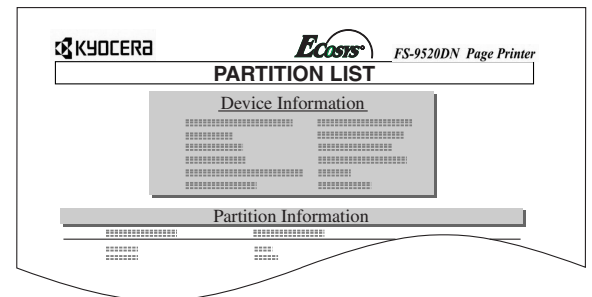

Figure 3-16

See *Printing a List of Data Names on page 3-34* for details on device information.

2.2.11 Operating a Memory Card

The printer is equipped with a slot for a memory card. By inserting a memory card into the printer, the following operations become available. For details about the handling of the memory card, see *Appendix A Option Units*.

- Reading font data
- Reading data
- Writing data
- Deleting data
- Formatting memory card
- Printing of list of partitions

Chapter 3 Using the Operator Panel

Reading Font Data

If a memory card with the font data is already inserted into the slot when the printer is turned on, the fonts are automatically read into the printer. To re-read fonts into the printer from a memory card, proceed as follows.

1 Press the **MENU** key.

2 Press the Δ or ∇ key repeatedly until Memory Card > appears.

```
Memory Card >
```

3 Press the \triangleright key.

4 Press the Δ or ∇ key repeatedly until >Read Fonts appears.

```
>Read Fonts
```

5 Press the **ENTER** key. A question mark (?) appears.

```
>Read Fonts ?
```

6 Press the **ENTER** key. Processing appears and the reading of data from the memory card starts.

```
>Read Fonts  
Processing
```

7 Press the **MENU** key to return to Ready.

Reading Data

Data stored on a memory card can be read. To read data on a memory card, proceed as follows.

1 Press the **MENU** key.

2 Press the Δ or ∇ key repeatedly until Memory Card > appears.

```
Memory Card >
```

3 Press the \triangleright key.

4 Press the Δ or ∇ key repeatedly until >Read Data appears. The data name also appears.

```
>Read Data  
DataS001
```

5 Press the **ENTER** key. A blinking question mark (?) appears before the data name.

```
>Read Data  
?DataS001
```

6 Press the Δ or ∇ key to display the desired data name.

7 Press the **ENTER** key. Processing appears and the reading of data from the memory card starts.

Writing Data

Data can be written to a memory card until no space is left for storing. When writing to a memory card, a name is assigned to the file automatically. You can use the procedure explained later in this section to print a list of data names for confirmation.

To write data to a memory card, proceed as follows.

First check that the memory card is properly formatted. Otherwise, the >Write Data message to be explained below will not be shown on the message display.

If the memory card inserted in the memory card slot is not formatted, the >Format will automatically appear on the display. See [Formatting on page 3-39](#).

1 Press the **MENU** key.

2 Press the Δ or ∇ key repeatedly until Memory Card > appears.

```
Memory Card >
```

3 Press the \triangleright key.

4 Press the Δ or ∇ key repeatedly until >Write Data appears.

```
>Write Data
```

5 Press the **ENTER** key. A question mark (?) appears.

```
>Write Data ?
```

- 6** Press the **ENTER** key. Processing appears, then Waiting.
- 7** In this state, send the file from the computer to the printer.

The file is written onto the memory card given a destination name (also referred to as a partition name) which the printer automatically assigns one after another as follows:

DataS001 (first data),
 DataS002 (second data),
 DataS003 (third data)...

In the example above, if the file TEST.TXT is the first data to be written onto the memory card, the destination name will be DataS001.

As the printer receives data, the message display changes to Processing, then when the end of the data is received, the message display changes to Waiting.

- 8** Check that the message display has changed to Waiting, then press the **GO** key. This writes the file to the memory card and instructs the printer to automatically print out a memory card write information page as shown below.

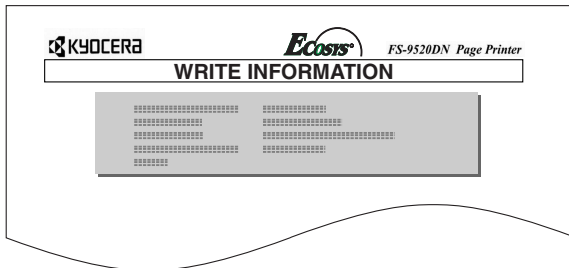

Figure 3-17

Partition Type: Type of data written (currently only type 2 is supported).
 Partition Name: The destination name of data written to the card.
 Write Partition Length: The size of the written data on the memory card.
 Others: Error information.

When the memory card write information page is printed, the message display returns to Ready.

If the writing is not completed successfully, an error code appears on the message display. For details, see [Error Messages on page 4-6](#). If this happens, press the **GO** key. The message display returns to Ready.

- 9** Repeat above steps until you have transferred all data (files) that you want to write to the memory card. Each time you finish writing data, a memory card write information page is printed from the printer showing the information explained in step 8 above, but pertaining only to the data just written. To see all data contained in the memory card at once, print a list of data names as explained. See [Printing a List of Data Names on page 3-40](#).

Deleting Data

It is possible to use the printer to delete data from a memory card one by one.

To delete data from a memory card, proceed as follows. Check that the memory card contains data. Otherwise, the >Delete Data menu will not appear on the message display.

- 1** Press the **MENU** key.
- 2** Press the Δ or ∇ key repeatedly until Memory Card > appears.

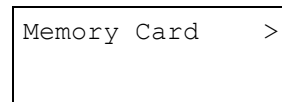

- 3** Press the \triangleright key.

- 4** Press the Δ or ∇ key repeatedly until >Delete Data appears. The data name also appears.

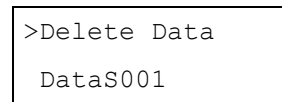

- 5** Press the **ENTER** key. A blinking question mark (?) appears before the data name.

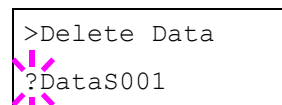

- 6** Press the Δ or ∇ key to display the desired data name.

- 7** Press the **ENTER** key. Processing appears and the data is deleted from the memory card. The display returns to Ready.

Formatting

Formatting allows data to be written to the card. A new memory card must be formatted before it can be used in the printer. Formatting deletes any existing data on the memory card.

To format a memory card, proceed as follows.

- 1** Press the **MENU** key.

- Press the Δ or ∇ key repeatedly until Memory Card > appears.

```
Memory Card >
```

- Press the \triangleright key.

- Press the Δ or ∇ key repeatedly until >Format appears.

```
>Format
```

- Press the **ENTER** key. A question mark (?) appears.

```
>Format ?
```

- Press the **ENTER** key. Processing appears and formatting of the memory card starts.

When the formatting is successfully completed, the printer automatically prints out a format information page.

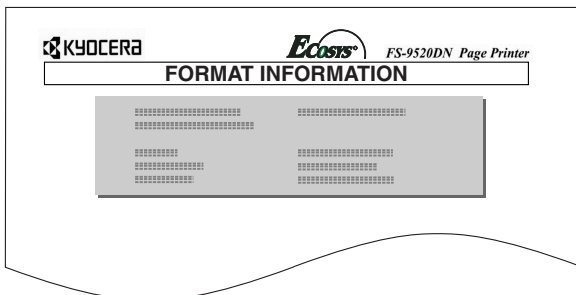

Figure 3-18

The format information page includes the following items;

- Capacity: The total size of the memory card.
- Used Space: The space the printer uses for its system.
- Free Space: The space remaining in the memory card for storing data.

When the memory card format information is printed, the message display returns to Ready.

Printing a List of Data Names

The printer prints a list of all data names (referred to as partitions) stored in a memory card for reference. (Printing a list is also available for a font card.) To print a list of data names for the memory card, proceed as follows.

- Press the **MENU** key.

- Press the Δ or ∇ key repeatedly until Memory Card > appears.

```
Memory Card >
```

- Press the \triangleright key.

- Press the Δ or ∇ key repeatedly until >List of Partitions appears.

```
>List of
Partitions
```

- Press the **ENTER** key. A question mark (?) appears.

```
>List of
Partitions ?
```

- Press the **ENTER** key. Processing appears and the printing of the list starts.

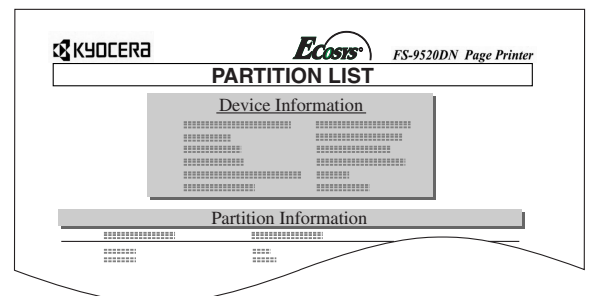

Figure 3-19

The printout (example above) includes the following information.

Device Name/Number: CARD/A is indicated for the memory card.

- Capacity: The total capacity of the memory card in bytes.
- Used Space: The total size of the data stored in the memory card in bytes.
- Free Space: The size of the capacity remaining in the memory card for storing further data, including the amount of memory that the printer uses for its system.

- Partition Name: The name of the written data assigned automatically by the printer.
- Partition Size: The size of the written data in bytes.
- Partition Type: The type of the written data i.e., whether it is host data (Data) or font data (Font).

When the list of file names (partition list) for the memory card is printed, the message display returns to Ready.

2.2.12 Paper Handling

You can change the MP tray mode, the paper size and type for each paper source, the sorter mode, the paper source, and paper destinations.

MP Tray Mode

The MP tray can be used in one of two modes: cassette mode or first mode. The MP tray can hold approximately 200 sheets of paper (A4 size, 0.11 mm thickness).

Cassette Mode

The cassette mode provides faster printing speed than the first mode. Approximately 200 sheets of paper can be continuously fed in this mode. (This is the factory setting.)

First Mode (Automatic Manual Feeding)

The printer automatically feeds any paper placed on the MP tray even if another paper source is selected. After all paper in the MP tray is printed, paper will be fed from the paper source originally selected.

- 1 Press the **MENU** key.

- 2 Press the Δ or ∇ key repeatedly until Paper Handling > appears.

```
Paper Handling >
```

- 3 Press the \triangleright key.

- 4 Press the Δ or ∇ key repeatedly until >MP Tray Mode appears.

```
>MP Tray Mode
Cassette
```

- 5 Press the **ENTER** key. A blinking question mark (?) appears.

```
>MP Tray Mode
? Cassette
```

- 6 Select First or Cassette using the Δ or ∇ key.

- 7 Press the **ENTER** key.

- 8 Press the **MENU** key. The message display returns to Ready.

Setting the MP Tray Size

When using the MP tray in the cassette mode, you should set the MP tray size to the paper size that is used to format the job to print. If they do not match, printing will not be made on the correct size paper when automatic paper size selection is made by the application (printer driver). The factory setting is A4 or Letter size.

For more details about the paper sizes that can be fed from the MP tray, see [Chapter 2 Handling Paper](#).

- 1 Press the **MENU** key.

- 2 Press the Δ or ∇ key repeatedly until Paper Handling > appears.

```
Paper Handling >
```

- 3 Press the \triangleright key.

- 4 Press the Δ or ∇ key repeatedly until >MP Tray Size appears.

```
>MP Tray Size
A4
```

- 5 Press the **ENTER** key. A blinking question mark (?) appears.

```
>MP Tray Size
? A4
```

- 6** Press the Δ or ∇ key to display the desired MP tray size. The display changes as shown below.

A4
Executive
Letter-R
Letter
Legal
Ledger
A3
B4
Custom
C4
Oficio II
Statement
Folio
Youkei 2
Youkei 4
8K
16K
Hagaki
OufukuHagaki
Monarch
Business
Comm.#9
Comm.#6 3/4
DL
C5
A6
B6
A5
B5
B5-R
ISO B5
A4-R

- 7** Press the **ENTER** key.

- 8** Press the **MENU** key. The message display returns to Ready.

Setting the MP Tray Type

You can automatically select the paper cassette according to the selection made by the application (printer driver). The factory default setting is Plain.

For more details about the paper types that can be fed from the MP tray, see [Paper Size Unit Selection on page 3-43](#).

- 1** Press the **MENU** key.
- 2** Press the Δ or ∇ key repeatedly until Paper Handling > appears.

Paper Handling >

- 3** Press the \triangleright key.

- 4** Press the Δ or ∇ key repeatedly until >MP Tray Type appears.

>MP Tray Type
Plain

- 5** Press the **ENTER** key. A blinking question mark (?) appears.

>MP Tray Type
? Plain

- 6** Press the Δ or ∇ key to display the desired MP tray type. The display changes as shown below.

Plain
Transparency
Preprinted
Labels
Bond
Recycled
Vellum
Rough
Letterhead
Color
Prepunched
Envelope
Cardstock
Thick
High quality
Custom (1 to 8)

- 7** When the desired MP tray type is displayed, press the **ENTER** key.

- 8** Press the **MENU** key and the message display returns to Ready.

Cassette Paper Size Display

The paper loaded in the cassette will be automatically detected and its size can be displayed in the LCD. To display the correct size, the paper must be properly loaded in the cassette.

(For details of loading paper, see [Chapter 2 Handling Paper](#).)

- 1** Press the **MENU** key.
- 2** Press the Δ or ∇ key repeatedly until Paper Handling > appears.

Paper Handling >

- 3** Press the \triangleright key.

- 4** Press the Δ or ∇ key repeatedly until `>Cassette Size` appears. The paper size is also displayed.

```
>Cassette1 size
  A4
```

NOTE

- `Cassette3 Size >` or `Cassette4 Size >` appears when an option paper feeder (PF-70) is installed.
- `Cassette3 Size >` appears when an option paper feeder (PF-75) is installed.

If option paper feeders are added, `Cassette1 Size` and `Cassette2 Size` will appear for the standard paper cassette and `Cassette3 Size`, and `Cassette4 Size` will appear for the option paper feeders.

- 5** Press the **MENU** key. The message display returns to Ready.

Paper Size Unit Selection

The paper size unit (metric or inch system) used in the LCD can be selected beforehand. At the time of Ready or when selecting the size display, the unit for some paper may be replaced with the counterpart as shown in the following table.

metric	Inch
A3	Ledger (LD)
B4	Legal (LG)
A4	Letter (LT)
A4-R (A4)	Letter-R (LT)
B5	Letter-R (LT)
B5-R (B5)	Statement (ST)
A5	Statement (ST)
Folio	Legal (LG)

() abbreviated display

Table 3-10

For example, when placing the letter size paper in the cassette while “mm” unit is selected. “A4” will be displayed in the LCD. To correct the display, use the following procedures.

NOTE

You can set the option paper feeder PF-70 using the same procedures, but when using the paper feeder PF-75, you cannot select the paper size and unit.

- 1** Press the **MENU** key.
- 2** Press the Δ or ∇ key repeatedly until `Paper Handling` appears.

```
Paper Handling >
```

- 3** Press the \triangleright key.

- 4** Press the Δ or ∇ key repeatedly until `>Cassette1 size` appears.

```
>Cassette1 size
```

- 5** Press the \triangleright key. `>>Unit` appears.

```
>>Unit
  mm
```

- 6** Press the **ENTER** key. A blinking question mark (?) appears.

```
>>Unit
? mm
```

- 7** Press the Δ or ∇ key to select mm or inch.

- 8** Select mm or inch, and then, press the **ENTER** key.

- 9** Press the **MENU** key. The message display returns to Ready.

Setting the Cassette Paper Type

Make this setting to match the paper type fed from the paper cassette of the printer. If the paper type is set correctly, you can perform printing using the media type selection function from the application (printer driver). The factory default setting is Plain. For more details about the paper types that can be fed from the paper cassette, see [Paper Type on page 2-5](#).

- 1** Press the **MENU** key.

- 2** Press the Δ or ∇ key repeatedly until `Paper Handling >` appears.

```
Paper Handling >
```

- 3** Press the \triangleright key.

- 4** Press the Δ or ∇ key repeatedly until `>Cassette 1 Type` appears. The paper type also displayed.

```
>Cassette 1 Type
  Plain
```

NOTE

- >Cassette 3 Type or >Cassette 4 Type appears when an option paper feeder (PF-70) is installed.
- >Cassette 3 Type appears when an option paper feeder (PF-75) is installed.

5 Press the **ENTER** key. A blinking question mark (?) appears.

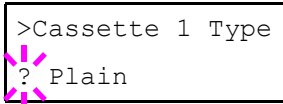

6 Press the Δ or ∇ key to display the desired cassette type. The display changes as shown below.

- Plain
- Preprinted
- Bond
- Recycled
- Rough
- Letterhead
- Color
- Prepunched
- Thick
- High quality
- Custom(1 to 8)

7 When the desired cassette type is displayed, press the **ENTER** key.

8 Press the **MENU** key. The message display returns to Ready.

Selecting the Paper Source

You can select from which paper source printing will be performed. If no option units are installed, the only selections are the paper cassette and MP tray of the printer. If option paper feeders are installed, they can also be selected.

1 Press the **MENU** key.

2 Press the Δ or ∇ key repeatedly until Paper Handling > appears.

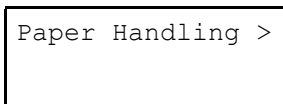

3 Press the \triangleright key.

4 Press the Δ or ∇ key repeatedly until >Feed Select appears.

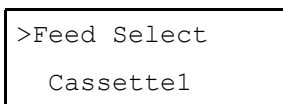

5 Press the **ENTER** key. A blinking question mark (?) appears.

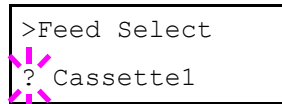

6 Press the Δ or ∇ key to display the desired paper source. The display changes as shown below according to the installed option units.

- Cassette1 (Printer's standard upper cassette when option paper feeders are installed)
- Cassette2 (Printer's standard lower paper cassette)
- MP tray (printer's MP tray)
- Cassette3 (Option upper paper feeder)
- Cassette4 (Option lower paper feeder)

7 When the desired paper source displayed, press the **ENTER** key.

8 Press the **MENU** key. The message display returns to Ready.

Setting Duplex Printing

Using the duplex unit, you can automatically print on both sides of the paper. The duplex unit is installed underneath the printer.

Binding Setups

The term binding refers to the manner in which printed pages of paper are joined together (by gluing, stitching, etc.) in book form. The two possible types of binding are long-edge binding, in which pages are joined together along their long edge; and short-edge binding, in which they are joined together along their short edge. In selecting a binding type, you must also consider the orientation of the printed page. You can use long-edge or short-edge binding with either landscape or portrait printing.

Depending on the binding type and print orientation, the duplex unit provides four types of binding setups. These are: (1) portrait, long-edge, (2) portrait, short edge, (3) landscape, long-edge, and (4) landscape, short-edge. The figure below shows these binding setups.

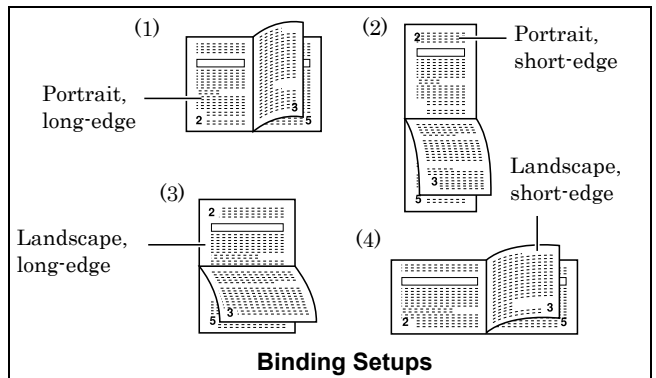

Figure 3-20

To select duplex printing and binding setup from the operator panel, proceed as follows.

1 Press the **MENU** key.

2 Press the Δ or ∇ key repeatedly until Paper Handling > appears.

```
Paper Handling >
```

3 Press the \triangleright key.

4 Press the Δ or ∇ key repeatedly until >Duplex Mode appears.

```
>Duplex Mode
None
```

5 Press the **ENTER** key. A blinking question mark (?) appears.

```
>Duplex Mode
?None
```

6 Press the Δ or ∇ key to display the desired duplex mode. The display changes as shown below.

```
None (default)
Short edge bind
Long edge bind
```

7 When the desired duplex mode is displayed, press the **ENTER** key.

8 Press the **MENU** key. The message display returns to Ready.

Selecting the Output Device

You can select whether printouts will be received by the printer's top tray (face-down) or to the optional document finisher's output tray.

1 Press the **MENU** key.

2 Press the Δ or ∇ key repeatedly until Paper Handling > appears.

```
Paper Handling >
```

3 Press the \triangleright key.

4 Press the Δ or ∇ key repeatedly until >Stack Select appears.

```
>Stack Select
Top tray FaceDn
```

5 Press the **ENTER** key. A blinking question mark (?) appears. The selected output device will be displayed.

```
>Stack Select
?Top tray FaceDn
```

6 Press the Δ or ∇ key to display the desired destination. The output tray changes as shown below.

```
Top tray FaceDn
Finisher FaceUp (when document finisher is
equipped)
Finisher FaceDn (when document finisher is
equipped)
```

7 When the desired paper source displayed, press the **ENTER** key.

8 Press the **MENU** key. The message display returns to Ready.

Adjusting the Stitch Positions

When installing the option document finisher DF-75, adjust the stitch positions using the following procedures. In the default settings, the stitch position is set in the center of the paper. Depending on the paper, a certain amount of deviation will occur. In this case, also use this menu to adjust the stitch position.

The adjustment can be done by moving the stitch position adjustment gear in the document finisher.

For example, select the range from -57 to +57 (1 = approximately 0.14 mm) to move the stitch position approximately 8 mm as shown in the following figure. The default setting is 000 (center of the paper).

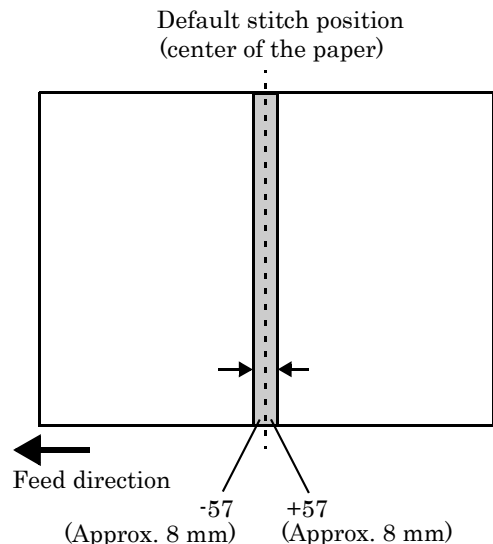

Figure 3-21

1 Press the **MENU** key.

2 Press the Δ or ∇ key repeatedly until Paper Handling > appears.

```
Paper Handling >
```

3 Press the \triangleright key. >Stitch Adjust > appears.

```
>Stitch Adjust >
```

4 Press the \triangleright key. >>A4/Letter appears.

```
>>A4/Letter
000
```

5 Press the Δ or ∇ key to select A4/Letter, B4 or A3/Ledger.

6 When the desired paper size is displayed, press the **ENTER** key. A blinking cursor () appears under the value.

```
>>A4/Letter
000
```

7 Press the Δ or ∇ key to increase or decrease, respectively, the value at the blinking cursor. Use the \triangleright and \triangleleft keys to move the cursor right and left. Definable value: -057 to 057

8 When the desired value is displayed, press the **ENTER** key.

9 Press the **MENU** key. The message display returns to Ready.

Overriding A4 and Letter Size Difference

This selects whether to enable or disable the difference between A4 size and Letter size. Under the default setting of Off, the paper size of the paper source is matched to the paper size formatting the jobs. If these differ, a corresponding error message is displayed. When this is set to On, printing is performed even if the actual paper size differs from the paper size formatting the jobs.

1 Press the **MENU** key.

2 Press the Δ or ∇ key repeatedly until Paper Handling > appears.

```
Paper Handling >
```

3 Press the \triangleright key.

4 Press the Δ or ∇ key repeatedly until >Override A4/LT appears.

```
>Override A4/LT
Off
```

5 Press the **ENTER** key. A blinking question mark (?) appears.

```
>Override A4/LT
? Off
```

6 Select On or Off using the Δ or ∇ key.

7 Press the **ENTER** key.

8 Press the **MENU** key. The message display returns to Ready.

Customizing Paper Type

The following describes the procedure used to set a user-defined paper type for the printer. Eight custom user settings may be registered. After having been set, any of these may be called up when setting the paper type for a paper source.

The paper weight and duplex path can be set (see [Setting the Paper Weight on page 3-47](#), and [Setting the Duplex Path on page 3-47](#)) after selecting the paper type to be customized as follows. For how to reset the customized settings, see [Resetting the Type Adjust on page 3-47](#).

1 Press the **MENU** key.

2 Press the Δ or ∇ key repeatedly until Paper Handling > appears.

```
Paper Handling >
```

3 Press the \triangleright key.

4 Press the Δ or ∇ key repeatedly until >Type Adjust > appears.

```
>Type Adjust >
Custom 1
```

- 5 Press the **ENTER** key. A blinking question mark (?) appears.

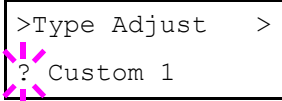

- 6 Press the Δ or ∇ key to display the desired paper type. The display changes as shown below.

```

Custom (1 to 8)
Plain
Transparency
Preprinted
Labels
Bond
Recycled
Vellum
Rough
Letterhead
Color
Prepunched
Envelope
Cardstock
Thick
High quality
    
```

- 7 When the paper type to be customized is displayed, press the **ENTER** key.

- 8 Press the \triangleright key and proceed to [Setting the Paper Weight](#) on the following page.

Setting the Paper Weight

You can set the paper thickness for your custom paper type to be customized.

- 1 Display the custom paper type (see [Customizing Paper Type on page 3-46](#)) and press the \triangleright key.

- 2 Press the Δ or ∇ key repeatedly until \gg Paper Weight appears.

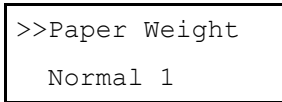

- 3 Press the **ENTER** key. A blinking question mark (?) appears.

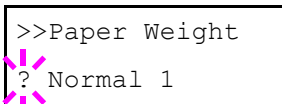

- 4 Press the Δ or ∇ key to display the desired paper thickness. The display changes as shown below. For details of the default setting for each paper type, see [Paper Type on page 2-5](#).

```

Light
Normal 1
Normal 2
Normal 3
Heavy 1
Heavy 2
Heavy 3
Extra Heavy
    
```

- 5 When the desired paper thickness displayed, press the **ENTER** key.

- 6 Press the **MENU** Key. The message display returns to Ready.

Setting the Duplex Path

If the paper type is set to Custom, you can set whether or not to enable duplex printing as follows. The default setting is Enable.

- 1 Display the custom paper type (see [Customizing Paper Type on page 3-46](#)) and press the \triangleright key.

- 2 Press the Δ or ∇ key repeatedly until \gg Duplex Path appears.

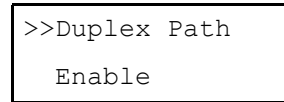

- 3 Press the **ENTER** key. A blinking question mark (?) appears.

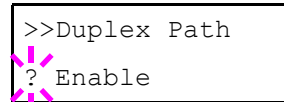

- 4 Select Enable or Disable using the Δ or ∇ key. For details of the default setting for each paper type, see [Paper Type on page 2-5](#).

- 5 Press the **ENTER** key.

- 6 Press the **MENU** key. The message display returns to Ready.

Resetting the Type Adjust

Resets the custom setting that are set in [Customizing Paper Type on page 3-46](#).

- 1 Press the **MENU** key.

- 2 Press the Δ or ∇ key repeatedly until Paper handling > appears.

```
Paper Handling >
```

- 3 Press the \triangleright key.

- 4 Press the Δ or ∇ key repeatedly until >Reset Type Adjust appears.

```
>Reset Type  
Adjust
```

- 5 Press the **ENTER** key. A question mark (?) appears.

```
>Reset Type  
Adjust ?
```

- 6 Press the **ENTER** key. All the customized paper weight and duplex path settings will be reset to the default. The message display returns to Ready.

Verifying the Total Printed Pages and Resetting the Toner Counter

You can display the total number of pages printed by your printer for confirmation whenever necessary. The total number of printed pages can also be checked on the status page. Moreover, for proper maintenance scheduling, it will be necessary to reset the toner counter using this menu each time a new toner container is installed.

Verifying the Total Printed Pages

This procedure only displays the total number of printed pages. The number cannot be changed.

- 1 Press the **MENU** key.

- 2 Press the Δ or ∇ key repeatedly until Life Counters > appears.

```
Life Counters >
```

- 3 Press the \triangleright key.

- 4 Press the Δ or ∇ key until >Total Print appears.

```
>Total Print  
0123456
```

- 5 Press the **MENU** key. The message display returns to Ready.

Resetting the Remaining Toner Counter

If the toner container was replaced when Replace toner Clean Printer was not displayed, reset the toner counter as follows so that an accurate toner gauge measurement is indicated on the status page. Note that if this operation is performed when the toner container is not replaced, the toner gauge measurement will not be indicated correctly. Also refer to the Installation Guide supplied with the toner kit when replacing the toner container.

- 1 Press the **MENU** key.

- 2 Press the Δ or ∇ key repeatedly until Life Counters > appears.

```
Life Counters >
```

- 3 Press the \triangleright key.

- 4 Press the Δ or ∇ key repeatedly until >New Toner Installed appears

```
>New Toner  
Installed
```

- 5 Press the **ENTER** key. A question mark (?) appears.

```
>New Toner  
Installed ?
```

- 6 Press the **ENTER** key. The toner counter is reset.

- 7 Press the **MENU** key. The message display returns to Ready.

2.2.13 Other Modes

The modes described in the following pages can be accessed in the Others submenu. To enter the Others submenu, press the \triangleright key while Others > is displayed.

The following submenus can be displayed by pressing the \triangleright key and then the Δ or ∇ key.

- Message Language Selecting
- Automatic Form Feed Timeout Setting
- Sleep Timer Setting
- Received Data Dumping
- Printer Resetting
- Resource Setting
- Alarm (Buzzer) Setting
- Auto Continue Setting
- Finishing
- Service Menu (for service personnel)

Message Language Selection

You can select the language of the messages on the message display by following the procedure given below.

1 Press the **MENU** key.

2 Press the Δ or ∇ key repeatedly until Others > appears.



3 Press the \triangleright key.

4 Press the Δ or ∇ key repeatedly until >MSG Language appears. The default message language is English.

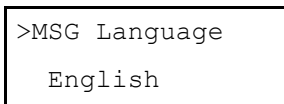

5 To change the language, press the **ENTER** key. A blinking question mark (?) appears.

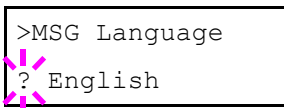

6 Press the Δ key. The display cycles through the available selections in the following order (The ∇ key cycles in the reverse order):

- English
- Francais
- Deutsch
- Italiano
- Nederlands
- Espanol
- Portugues

7 Press the **ENTER** key.

8 Press the **MENU** key. The message display returns to Ready.

Automatic Form Feed Timeout Setting

When the printer receives no data for a certain time, it times out and releases the current interface: it prints whatever data it has in its buffer and feeds out the page. You can adjust the time-out time as follows:

1 Press the **MENU** key.

2 Press the Δ or ∇ key repeatedly until Others > appears.



3 Press the \triangleright key.

4 Press the Δ or ∇ key repeatedly until >Form Feed Time Out appears. The default setting is 30 seconds.

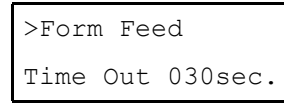

5 Press the **ENTER** key. A blinking cursor () appears.

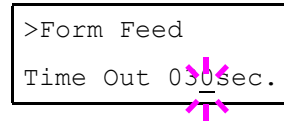

6 Press the Δ or ∇ key to increase or decrease the value of the figure where the cursor is blinking and set the desired time. The time can be set between 0 and 495 seconds, in 5-second increments. (The printer does not timeout with the value set to 0.) You can use the \triangleright and \triangleleft keys to move the cursor right and left.

7 Display the desired time and press the **ENTER** key.

8 Press the **MENU** key. The message display returns to Ready.

Sleep Timer Setting

The printer has a sleep timer to conserve power when the printer is not printing, processing, or receiving data. You can adjust the timer value, the length of time the printer waits before entering sleeping mode in the absence of data.

1 Press the **MENU** key.

2 Press the Δ or ∇ key repeatedly until Others > appears.

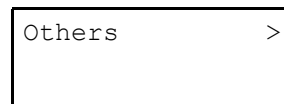

3 Press the \triangleright key.

- 4** Press the Δ or ∇ key repeatedly until `>Sleep Timer >` appears. The default setting is 015 min.

```
>Sleep timer >
      015 min.
```

- 5** Press the **ENTER** key. A blinking cursor (`_`) appears.

```
>Sleep timer >
      015 min.
```

- 6** Press the Δ or ∇ key to increase or decrease the value of the figure where the cursor is blinking and set the desired time. The timer can be set between 5 and 240 min, in 5-minute increments. You can use the \triangleright and \triangleleft keys to move the cursor right and left.

- 7** Press the **ENTER** key.

- 8** Press the **MENU** key. The message display returns to Ready.

Turning Off the Sleep Timer

You can turn off the sleep timer function by following the procedure given below.

- 1** Press the **MENU** key.

- 2** Press the Δ or ∇ key repeatedly until `Others >` appears.

```
Others >
```

- 3** Press the \triangleright key.

- 4** Press the Δ or ∇ key repeatedly until `>Sleep Timer >` appears.

```
>Sleep timer >
      015 min.
```

- 5** Press the \triangleright key and display `>>Sleep Mode.`

```
>>Sleep Mode
      On
```

- 6** Press the **ENTER** key. A blinking question mark (?) appears.

```
>>Sleep Mode
? On
```

- 7** Select `Off` using the Δ or ∇ key.

```
>>Sleep Mode
? Off
```

- 8** Press the **ENTER** key.

- 9** Press the **MENU** key. The message display returns to Ready.

Received Data Dumping

It is possible to print data received by the printer as hexadecimal code for the purposes of debugging programs and files.

- 1** Press the **MENU** key.

- 2** Press the Δ or ∇ key repeatedly until `Others >` appears.

```
Others >
```

- 3** Press the \triangleright key.

- 4** Press the Δ or ∇ key repeatedly until `>Print HEX-DUMP` appears.

```
>Print HEX-DUMP
```

- 5** Press the **ENTER** key. A question mark (?) appears.

```
>Print HEX-DUMP?
```

- 6** Press the **ENTER** key again. Processing appears for a second, and then `Waiting` appears.

```
Processing
```



```
Waiting
```

- 7** Send data to be dumped to the printer. The message `Processing` will be displayed while receiving the data.

Once the dumped data you require has been printed, it is possible to cancel the printing of any further dumped data by taking the printer offline by pressing the **GO** key and then pressing the **CANCEL** key.

- 8** Once all data has been received, the message `Waiting` will appear. Press the **GO** key to finish printing.

Printer Resetting

The procedure described below resets the printer's temporary conditions, such as the current unit of measurement, page orientation, font, character code set, margins, etc., set by commands to their default values.

- 1** Press the **MENU** key.
- 2** Press the Δ or ∇ key repeatedly until `Others >` appears.

```
Others >
```

- 3** Press the \triangleright key.
- 4** Press the Δ or ∇ key repeatedly until `>Printer Reset` appears.

```
>Printer Reset
```

- 5** Press the **ENTER** key. A question mark (?) appears.

```
>Printer Reset ?
```

- 6** Press the **ENTER** key again. `Self test` appears while the printer is resetting itself, then `Please wait` followed by `Ready`.

```
Self test
```



```
Please wait
```



```
Ready
```

Resource Protection

When you switch from the PCL 6 emulation to another, all downloaded fonts and macros are lost. Resource protection preserves these PCL resources in memory so that they are intact when you change the emulation back to PCL 6.

- 1** Press the **MENU** key.
- 2** Press the Δ or ∇ key repeatedly until `Others >` appears.

```
Others >
```

- 3** Press the \triangleright key.
- 4** Press the Δ or ∇ key repeatedly until `>Resource Prot.` appears.

```
>Resource Prot.
Off
```

- 5** Press the **ENTER** key. A blinking question mark (?) appears.

```
>Resource Prot.
? Off
```

- 6** Press the Δ or ∇ key to display the desired mode. The display changes as shown below.

```
Off (default)
Permanent
Perm / Temp
```

- 7** When the desired mode is displayed, press the **ENTER** key.

- 8** Press the **MENU** key. The message display returns to `Ready`.

Alarm (Buzzer) Setting

In addition to the message displayed when the paper supply is exhausted, or when paper jamming occurs, an audio warning is made to sound. This is useful, for example, when the printer is in a location some distance from the user.

The audio alarm is set to `On` as a factory preset. If the alarm is set to `Off`, it will not sound.

- 1** Press the **MENU** key.

- 2 Press the Δ or ∇ key repeatedly until `Others >` appears.

```
Others >
```

- 3 Press the \triangleright key.

- 4 Press the Δ or ∇ key repeatedly until `> Buzzer` appears.

```
>Buzzer
  On
```

- 5 Press the **ENTER** key. A blinking question mark (?) appears.

```
>Buzzer
? On
```

- 6 Select `On` or `Off` using the Δ or ∇ key.

- 7 Press the **ENTER** key.

- 8 Press the **MENU** key. The message display returns to `Ready`.

Auto Continue Setting

When Auto Continue is enabled, the printer will automatically print the next received data following a preset amount of time passes after any one of the following errors occurs:

Memory overflow Press GO
Print overrun Press GO
KPDL error Press GO
File not found Press GO
RAM disk error Press GO
MemoryCard err Press GO
Hard disk err Press GO
Duplex disabled Press GO
Add Staple Press GO
Chad box full Press GO

If one of the above errors is caused by someone on a network where the printer is being shared, for example, data sent from another person will be printed after a preset amount of time.

For setting the auto continue recovery time, see the next section.

- 1 Press the **MENU** key.

- 2 Press the Δ or ∇ key repeatedly until `Others >` appears.

```
Others >
```

- 3 Press the \triangleright key.

- 4 Press the Δ or ∇ key repeatedly until `>Auto Continue >` appears.

```
>Auto Continue >
  Mode Off
```

- 5 Press the **ENTER** key. A blinking question mark (?) appears.

```
>Auto Continue
  Mode ? Off
```

- 6 Select `On` or `Off` using the Δ or ∇ key.

- 7 Press the **ENTER** key.

- 8 Press the **MENU** key. The message display returns to `Ready`.

Setting the Auto Continue Recovery Time

Follow the procedure given below to change the recovery time for Auto Continue.

- 1 Press the **MENU** key.

- 2 Press the Δ or ∇ key repeatedly until `Others >` appears.

```
Others >
```

- 3 Press the \triangleright key.

- 4 Press the Δ or ∇ key repeatedly until `>Auto Continue Mode >` appears.

```
>Auto Continue >
  Mode On
```

- 5 Press the \triangleright key and display `>>Auto Continue Timer`.

6 Press the **ENTER** key. A blinking cursor () appears.

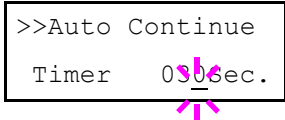

7 Press the Δ or ∇ key to increase or decrease the value of the figure where the cursor is blinking and set the desired time. The time must be set between 000 and 495 seconds, in 5-second increments. If set to 000, printing will be continued immediately without allowing any time interval. You can use the \triangleright and \triangleleft keys to move the cursor right and left.

8 Display the desired time and press the **ENTER** key.

9 Press the **MENU** key. The message display returns to Ready.

Finishing

These settings are possible only when the optional finisher is installed on the printer.

Duplex Printing Error Detection Setting

This setting controls whether or not the message Duplex disabled Press **GO** appears when label or some other type of paper that is not supported for duplex printing is specified as the paper type when duplex printing is being performed.

On	<ul style="list-style-type: none"> • Press the GO key to perform simple printing. • Press the CANCEL key to cancel the print job.
Off	Disable duplex printing. (reverts to simplex printing)

1 Press the **MENU** key.

2 Press the Δ or ∇ key repeatedly until Others > appears.



3 Press the \triangleright key.

4 Press the Δ or ∇ key repeatedly until >Finishing Error > appears.

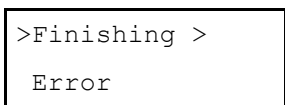

5 Press the \triangleright key.

6 Press the Δ or ∇ key repeatedly until >>Duplex appears.

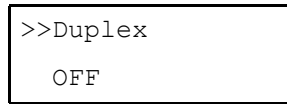

7 Press the **ENTER** key. A blinking question mark (?) appears.

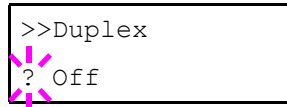

8 Press the Δ or ∇ key to change Off to On.

9 Press the **ENTER** key.

10 To exit the menu selection, press the **MENU** key.

Staple Error Detection Setting

This setting controls whether or not message Add staples appears when the finisher units runs out of staples during output of a stabled job.

On	Message is displayed and printing pauses. Printing resumes automatically when staples are replenished.
Off	Message is displayed, but printing continues without stapling.

1 Press the **MENU** key.

2 Press the Δ or ∇ key repeatedly until Others > appears.

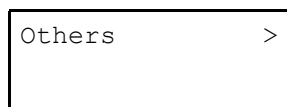

3 Press the \triangleright key.

4 Press the Δ or ∇ key repeatedly until >Finishing Error > appears.

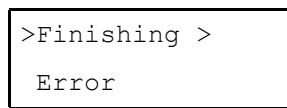

5 Press the \triangleright key.

Chapter 3 Using the Operator Panel

- 6** Press the Δ or ∇ key repeatedly until `>>Staple` appears.

```
>>Staple
  OFF
```

- 7** Press the **ENTER** key. A blinking question mark (?) appears.

```
>>Staple
? Off
```

- 8** Press the Δ or ∇ key to change `Off` to `On`.

- 9** Press the **ENTER** key.

- 10** To exit the menu selection, press the **MENU** key.

Punch Error Detection Setting

This setting is possible only when the Punch Unit is installed on the optional finisher unit. This setting controls whether or not the message `Chad box full` appears when the chad box on the punch unit becomes full.

On	Message is displayed and printing pauses. Printing resumes automatically when the chad box is emptied and replaced back into the punch unit.
Off	Message is displayed, but printing continues without punching.

- 1** Press the **MENU** key.

- 2** Press the Δ or ∇ key repeatedly until `Others >` appears.

```
Others >
```

- 3** Press the \triangleright key.

- 4** Press the Δ or ∇ key repeatedly until `>Finishing >` `Error >` appears.

```
>Finishing >
  Error
```

- 5** Press the \triangleright key.

- 6** Press the Δ or ∇ key repeatedly until `>>Punch` appears.

```
>>Punch
  OFF
```

- 7** Press the **ENTER** key. A blinking question mark (?) appears.

```
>>Punch
? Off
```

- 8** Press the Δ or ∇ key to change `Off` to `On`.

- 9** Press the **ENTER** key.

- 10** To exit the menu selection, press the **MENU** key.

Service Menu

The service menu contains maintenance operations to be performed by service personnel. The `Print Status Page`, `Developer`, and `Drum` menus appear; however, in general, you will only need to use the `Print Status Page` menus.

Printing the Service Status Page

The service status page contains printer settings information that is more detailed than the standard status page and is therefore for mostly service purposes. To print a service status page, proceed as follows:

- 1** Press the **MENU** key.

- 2** Press the Δ or ∇ key repeatedly until `Others >` appears.

```
Others >
```

- 3** Press the \triangleright key.

- 4** Press the Δ or ∇ key repeatedly until `>Service >` appears.

```
>Service >
```

- 5** Press the \triangleright key.

6 Press the Δ or ∇ key repeatedly until >>Print Status Page appears.

```
>>Print
Status Page
```

7 Press the ENTER key. A question mark (?) appears.

```
>>Print
Status Page ?
```

8 Press the ENTER key. The message display indicates Processing and printing starts.

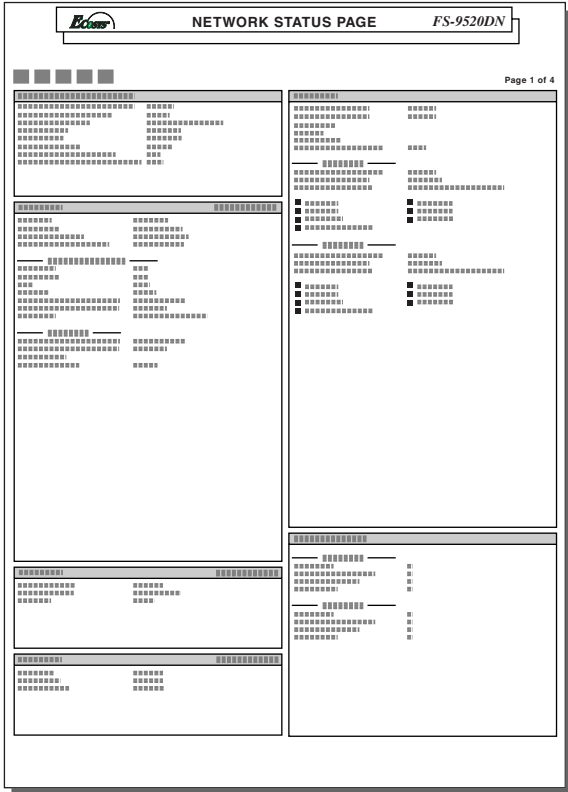

Figure 3-22

NOTE

The network interface status page will be printed after the printer service status page.

Chapter 4 Troubleshooting

This chapter explains how to handle printer problems that may occur. If a problem cannot be corrected, contact your Kyocera Mita dealer.

This chapter explains the following topics:

- General Guide
- Print Quality Problems
- Indicators and Messages
- Correcting a Paper Jam

1. General Guide

If some kind of problem should occur, check the following before concluding the printer is broken:

Symptom	Check Items	Corrective Action	
The printer will not print from the computer.	Check the  READY indicator.	Off	Look through the items below and check anything that seems appropriate.
		Flashing	An error has occurred. Check the message display, and then take measures seeing Indicators and Messages on page 4-4 .
		Lit	See the appropriate item below.
	Check the !ATTENTION indicator.	Flashing	See Indicators on page 4-4 .
		Lit	
	A maintenance message appears in the message display.	See Maintenance Messages on page 4-4 .	
Print quality is not good.		See Print Quality Problems on page 4-2 .	
Paper is jammed.		See Correcting a Paper Jam on page 4-8 .	
Nothing lights on the operator panel even when power is turned on and the fan makes no noise.	Check that the power cord is properly plugged into the power outlet.	Turn off the printer's power, plug in the power cord securely, and try turning on the printer's power again.	
	Check that the main switch is really in the ON (I) position.		
The printer prints a status page, but data from the computer is not being printed normally.	Check the interface cable.	Connect both ends of the interface cable securely. Try replacing the printer cable. For details on the parallel interface for this printer, see Appendix B Host Computer Interface .	
	Check program files and application software.	Try printing another file or using another print command. If the problem occurs only with a specific file or application, check the printer settings for that application.	

Table 4-1

If you still cannot correct a printer problem even after checking the above, please contact your Kyocera Mita dealer.

2. Print Quality Problems

As the following table shows, there are many possible causes of print quality problems, such as blank output. The troubleshooting procedure for each type of problem is explained below. If you still cannot solve the problem, contact your Kyocera Mita dealer.

Printed Results	Corrective Action
<p>Completely blank printout</p> 	<p>Check the toner container. Open the printer front cover and check that the toner container is correctly installed in the printer. See Toner Container Replacement on page 5-1.</p>
<p>All-black printout</p> 	<p>Check the main charger unit. Open the printer front cover and check that the main charger unit is correctly installed.</p>
<p>Dropouts, horizontal streaks, stray dots</p> 	<p>Clean the charger wire. Open the printer front cover. Pull the cleaning knob slowly in and out a few times. See Toner Container Replacement on page 5-1.</p> <hr/> <p>Refresh drum. See the following procedures in the operator panel and try cleaning the drum surface using the printer's built-in cleaning system.</p> <ol style="list-style-type: none"> 1. Press the MENU key, and then press the Δ or ∇ key to display >Others. 2. Press the \triangleright key, and then press the Δ or ∇ key to display >Service >. 3. Press the \triangleright key, and then press the Δ or ∇ key to display >>Drum. And then press the ENTER key twice. 4. The message display shows Please wait, and then the drum starts turning and stops after approx.3 minutes. The printer reverts to Ready.
<p>Black or white vertical streaks</p> 	<p>Clean the separator. Open the printer left cover 1 and clean the separator with a cleaning brush. See Toner Container Replacement on page 5-1.</p> <hr/> <p>Check the operator panel. If the Toner low message is displayed and the ! ATTENTION indicator is flashing, install a new toner kit. See Toner Container Replacement on page 5-1.</p> <hr/> <p>Clean the charger wire. Open the printer front cover. Pull the cleaning knob slowly in and out a few times. See Toner Container Replacement on page 5-1.</p>

Table 4-2

(Continued on next page)

Printed Results

Faint or blurred printing

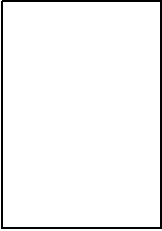
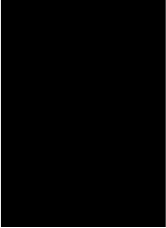
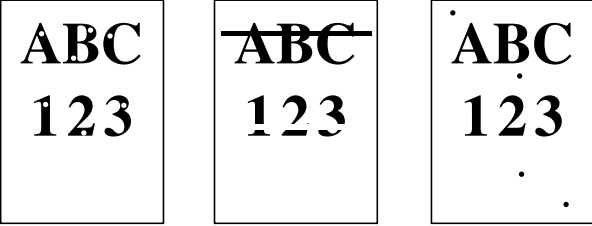
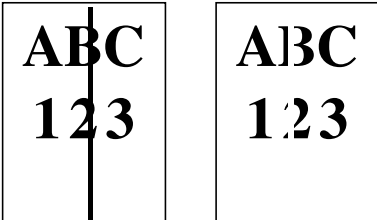
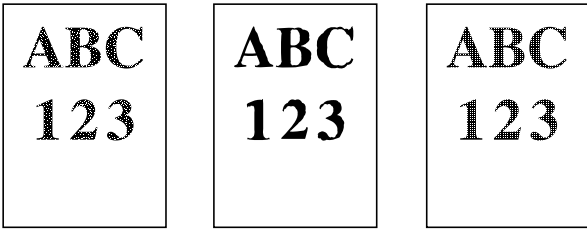

Corrective Action

Check the EcoPrint setting.

When this setting is **On**, switch it to **Off** on the operator panel. (See [Setting the Print Quality on page 3-31](#).)

Check the operator panel.

- If the **Toner low** message is displayed and the **! ATTENTION** indicator is flashing, install a new toner kit. See [Toner Container Replacement on page 5-1](#).
- Set the print density from the operator panel to a higher level than the current setting. See [Adjusting the Print Density on page 3-32](#).
- Make sure the paper type setting is correct. See [Paper Type on page 2-5](#).

Clean the charger wire.

Open the printer front cover. Pull the cleaning knob slowly in and out a few times. See [Toner Container Replacement on page 5-1](#).

Grey background.

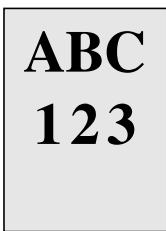

Refresh drum.

See the following procedures in the operator panel and try cleaning the drum surface using the printer's built-in cleaning system.

1. Press the **MENU** key, and then press the Δ or ∇ key to display **>Others**.
2. Press the \triangleright key, and then press the Δ or ∇ key to display **>Service >**.
3. Press the \triangleright key, and then press the Δ or ∇ key to display **>>Drum**. And then press the **ENTER** key twice.
4. The message display shows **Please wait**, and then the drum starts turning and stops after approx.3 minutes. The printer reverts to **Ready**.

Check the operator panel.

If the **Toner low** message is displayed and the **ATTENTION** indicator is flashing, install a new toner kit. See [Toner Container Replacement on page 5-1](#).

Check the print density.

Display the print density menu from the operator panel and select a lighter density setting. See [Adjusting the Print Density on page 3-32](#).

Clean the charger wire.

Open the printer front cover. Pull the cleaning knob slowly in and out a few times. See [Toner Container Replacement on page 5-1](#).

Check the charger unit installation.

Open the printer front cover and check that the main charger unit is correctly installed and seated as far as it will go. See [Toner Container Replacement on page 5-1](#).

Dirt on the top edge or back of the paper

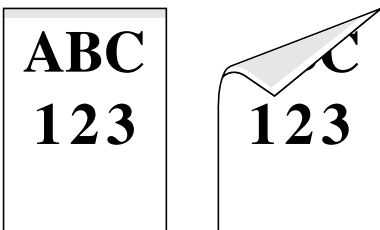

Check the paper ramp.

Open the printer left cover and check for toner on the paper ramp. Clean the paper ramp using a soft, dry, lint-free cloth. See [Toner Container Replacement on page 5-1](#).

Check the transfer roller.

Open the printer left cover 1 and check the transfer roller.

If the transfer roller is dirty with toner, try printing several pages.

Transfer Roller

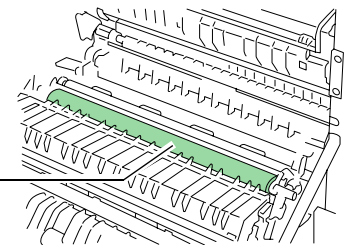

Characters out of position.

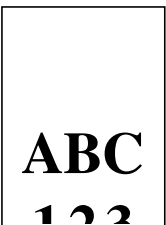

Check the file or program.

Check whether the problem is being caused by a **PRESCRIBE** command error. If the problem occurs only with a specific file or program, the most likely cause is an error in a parameter to a command or command syntax.

3. Indicators and Messages

The tables on the following pages indicate how to respond to problems indicated by the operator panel indicators and messages.

3.1 Indicators



Indicator	Condition	Description
 READY	Flashing	An error occurs that you can clear by yourself.
	Lit	The printer is on-line. The printer is ready to print.
	Off	The printer is off-line. The printer stores but does not print received data. Also indicates when printing is automatically stopped due to occurrence of an error.
 DATA	Flashing	Data transfer is taking place.
	Lit	Either data is being processed, or data is being written onto the option memory card or hard disk.
 ATTENTION	Flashing	The printer needs maintenance attention or the printer is warming up (Please wait).
	Lit	A problem or an error occurs that you can clear by yourself. (For example, a paper jam occurs.)
	Off	Operations are normal.

Table 4-3

3.2 Maintenance Messages

The following table lists maintenance messages that you can deal with by yourself. If Call service person appears, turn off the printer, disconnect the power cord, and contact your Kyocera Mita dealer.

Message	Corrective Action
Add paper (paper source)	The paper has run out. Supply paper according to the paper source displayed (paper cassette, MP tray, or optional paper feeder). Messages indicating the printer status (Ready, Please wait, Processing*, Waiting, and FormFeed Time Out*) are displayed alternately. * These messages will not appear when the number of copies is set to 2 or more.
Add staples	No staples are installed in the stapler. Set it in the stapler. If you wish to continue printing without the staple function, press the GO key.
Call service ####:0123456	#### represents a mechanical error (#=0, 1, 2, ...). Call for service. The printer does not operate when this message is displayed. The total number of pages printed is also indicated, e.g. 0123456.
Call service F###:	F### represents a controller error (#=0, 1, 2, ...). Call for service. The printer does not operate when this message is displayed.
Chad box full	The punch unit chad box of the option document finisher is full. Discard the chads.
Check chad box Press GO	The punch unit waste box of the document finisher is full or is not installed correctly. Check if the box is properly installed, and then discard the chads if the box is full. Press the GO key to resume printing.
Clean printer Press GO	Clean the inside of the printer. See <i>Toner Container Replacement on page 5-1</i> . This message will be displayed when replacing the toner container after the message Replace toner Clean printer is displayed. After cleaning the inside of the printer, press the GO key and the printer will be ready for printing.
Close finisher cover	Close the option document finisher cover.
Close front cover	Close the printer front cover.

Table 4-4

Chapter 4 Troubleshooting

Message	Corrective Action
Close left cover 1 (-3)	Close the printer left cover. If left cover of the option paper feeder is open, 2 or 3 is displayed.
Close reverse adapter	Close the reverse adapter cover of the option document finisher.
Duplex disabled Press GO	Duplex printing cannot be performed due to paper size or type. Press the GO key and the printer will print on one side only.
Finisher tray 1 (2) paper full	The finisher tray is full. When removing the paper, printing will be resumed, "1" indicates the upper tray, while "2" indicates the lower tray.
Finisher path error	The option document finisher is not installed correctly. Install it correctly.
Incorrect slot Please reinstall	The hard disk or the network interface card has been installed in the wrong slot. Turn off the printer and reinstalled in the correct slot.
Install MK	The maintenance kit (MK-702 for FS-9120DN, MK-703 for FS-9520DN) needs to be replaced. Replace the maintenance kit since the total number of printed pages has reached 500,000. Call for service. The maintenance kit includes a drum unit, developer unit and so on.
Load Cassette 1 (to4) (paper size)/(paper type)*	There is data for printing that matches with a paper cassette setting (paper size, paper type), but there is no paper in the paper cassette. Set paper into the paper source as displayed on the operator panel, and press the GO key to restart printing. However, the paper source numbers (3 to 4) are only displayed when there is an option paper feeder installed. Or, if you want to print from a different paper source press the Δ or ∇ key to display <i>Use alternative?</i> and you can change the source for paper feeding.
*(paper size) and (paper type) are displayed flashing alternately.	After selecting a paper source and pressing the MENU key, <i>Paper Handling ></i> appears. By pressing the \triangleright key, the paper type settings menu appears. After setting the correct paper type, press the ENTER key and printing starts.
Load MP tray (paper size)/(paper type)	There is no paper cassette set (paper size, paper type) that matches with the data for printing, so printing is done from the MP tray. Set paper into the MP tray that matches the paper size and type shown on the display and press the GO key to restart printing. Or, if you want to print from a different paper source press the Δ or ∇ key to display <i>Use alternative?</i> and you can change the source for paper feeding.
*(paper size) and (paper type) are displayed flashing alternately.	After selecting a paper source and pressing the MENU key, <i>Paper Handling ></i> appears. By pressing the Δ key, the paper type settings menu appears. After setting the correct paper type, press the ENTER key and printing starts.
Missing chad box	The punch unit chad box of the document finisher is not installed correctly. Install it correctly.
Missing toner container	Install the toner container. See <i>Toner Container Replacement on page 5-1</i> . The printer does not operate when this message is displayed.
Missing stapler unit	The stapler unit is not installed correctly in the document finisher. Install it correctly.
Missing waste toner box	Install the waste toner box. See <i>Toner Container Replacement on page 5-1</i> . The printer does not operate when this message is displayed.
Paper jam #####	Open the front cover or left cover and correct the paper jam (or paper mis-feeding in the paper cassette). The location of the paper jam is also indicated in place of the #'s. Online help messages which are useful for correcting the paper jam will be displayed by pressing the ? key. (See <i>Correcting a Paper Jam on page 4-8</i> .)
Remove paper Press GO	The document finisher tray is full. Remove the paper and press the GO key to resume printing. (Only when the document finisher DF-73 is equipped)

 :Alarm buzzer sounds when an error occurs. Press the **CANCEL** key to stop the alarm buzzer.

(Continued on next page)





Message	Corrective Action
Replace toner Clean printer	Replace the toner container using a new toner kit. The printer does not operate when this message is displayed. See Toner Container Replacement on page 5-1 . 
Replace waste toner box	Replace the old waste toner box with the new one which is included in the TK-70 toner kit. The message will also be shown if the waste toner box has become full. The waste toner box should be replaced when the message display eventually shows <code>Toner low</code> . See Toner Container Replacement on page 5-1 .
Toner low	Replace the toner container using a new toner kit. See Toner Container Replacement on page 5-1 .
Top tray paper full	The top tray has become full (approx. 500 pages). You must remove all printed pages from the top tray. When the printer senses that the top tray is empty again, it will continue printing into the top tray. 
Warning image adapt	Printing job cannot be done in current resolution because there is not enough internal memory. Try adding more memory or changing resolution. See Appendix A Option Units .
Warning Low memory	The printer's internal memory is running low due to the number of fonts and macros downloaded. Print a status page to see how much user memory is left, and try deleting unnecessary fonts and macros.







Table 4-4 (Continued)

3.3 Error Messages

The following table lists error messages that can be dealt with by the user.

Message	Corrective Action
File not found Press GO	VMB: A VMB tray that was specified for output does not contain any jobs, or the VMB tray is not being used. Confirm the VMB tray.  If Auto Continue is set to On, printing will be automatically resumed after a preset period of time. See Auto Continue Setting on page 3-52 .
Format error Memory card	This message appears when the printer is in the ready state and the memory card is not formatted, and therefore cannot be read or written.
Format error Hard disk	Initialization (formatting) of the hard disk is required. Initialize the hard disk.
Hard disk err ## Press GO	Look at the error code given in place of ## and refer to the corresponding description given below. 01: hard disk format error. If this error recurs even if the power has been turned off and then on, reformat the hard disk. 02: The disk system is not installed. Recheck the requirements for using the system and the devices. 04: There is no available hard disk space. Delete unnecessary files, etc., to free up space. 06: There is no memory available to the hard disk system. Increase the available memory. 10: Formatting is not possible because host data is being spooled on the hard disk. Wait until the hard disk is ready, and then format. 20: The hard disk was installed in the incorrect slot (OPT). Reinstall the hard disk in a different slot (HDD). 85: VMB: Alias error (the alias setting was lost, or the VMB tray corresponding to the alias does not exist). Set the alias again. 97: Code job: The number of permanent code jobs reached the limit value, and no more can be saved. Either delete some unnecessary jobs, etc., or increase the limit.  99: A print job for the specified ID does not exist in the hard disk.
I/F occupied	This message is displayed when you attempt to use the printer's operator panel to change the environmental settings on the interface from which data are presently being received.
ID error	The ID entered for a private job, or a stored job is not correct. Check the ID that is set using the printer driver.

Chapter 4 Troubleshooting

Message	Corrective Action
 :Alarm buzzer sounds when an error occurs. Press the CANCEL key to stop the alarm buzzer.	
	(Continued on next page)
Insert the same memory card	You have inserted the wrong memory card when the <code>Insert again</code> message was displayed. Remove the wrong memory card from the printer's memory card slot and insert the correct memory card. The printer again reads it from the beginning of the data.
KPDL error ## Press GO	Current print processing cannot continue. To print out an error report, display <code>> Print KPDL errs</code> from the mode select menu, and select <code>On</code> . Press the GO key to resume printing. You can abandon printing by the CANCEL key.  If Auto Continue is set to <code>On</code> , printing will be automatically resumed after a preset period of time. See Auto Continue Setting on page 3-52 .
Memory card err Insert again	The memory card is accidentally removed from the printer's memory card slot during reading. If you continue reading the memory card, insert the same memory card into the slot again. The printer again reads it from the beginning of the data. Note: We recommend that you follow the reading procedure from the beginning to ensure correct reading of the memory card.
Memory overflow Press GO	The total amount of data received by the printer exceeds the printer's internal memory. Try adding more memory (expansion DIMM). Press the GO key to resume printing. You can abandon printing by the CANCEL key.  If Auto Continue is set to <code>On</code> , printing will be automatically resumed after a preset period of time. See Auto Continue Setting on page 3-52 .
MemoryCard err## Press GO	This message appears when an error occurs during access to the memory card using the <code>PRESCRIBE RWER</code> command or from the printer's operator panel. Look at the error code given in place of ## and refer to the corresponding description given below. 01: The memory card does not meet specifications. This memory card cannot be used by this printer. Insert a memory card which can be used by this printer. (See Memory Card (CF) on page A-2 .) 02: The memory card is not installed. Recheck the requirements for using the memory card. 04: The capacity of the memory card is insufficient. Clean up files.  06: No memory for use by memory card. Expand printer memory.
Print overrun Press GO	The data transferred to the printer was too complex to print on a page. Press the GO key to resume printing. (The page may break in some pages.) You can abandon printing by the CANCEL key. Note: After this message is displayed, page protect mode will be On. To maintain optimum use of memory during printing, display <code>>Page protect</code> from the operator panel, and re-select <code>Auto</code>. See Page Protect Mode on page 3-29.  If Auto Continue is set to <code>On</code> , printing will be automatically resumed after a preset period of time. See Auto Continue Setting on page 3-52 .
RAM disk error ## Press GO	Look at the error code given in place of ## and refer to the corresponding description given below. 01: Format error. Try turning the power off and on again. 02: RAM disk mode is <code>Off</code> . Turn RAM disk mode <code>On</code> . 04: No disk space. Clean up files.  06: No memory for use by disk system. Expand printer memory.
Virtual mailbox full	The storage area for the VMB is full. Print out accumulated VMB data.
 :Alarm buzzer sounds when an error occurs. Press the CANCEL key to stop the alarm buzzer.	

4. Correcting a Paper Jam

The Paper jam message is displayed on the message display when paper becomes stuck in the paper transport system, the paper feed timing is incorrect, or paper fails to feed at all. The jam can be corrected by removing the paper.

The printer goes off-line when the Paper jam message is displayed.

When a paper jam occurs, a paper jam message and the paper jam location are indicated on the message display. Details of the messages and paper jam locations are as follows:

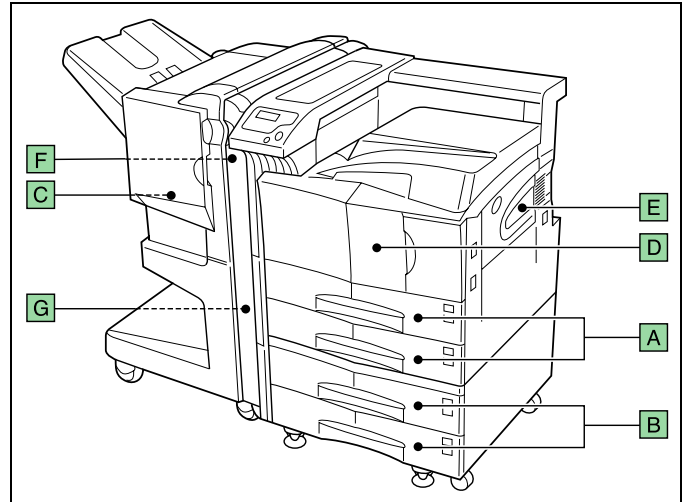

Paper jam message	Paper jam location	Description	Reference Page
Paper jam Cassette 1 (2)	A	Paper is jammed at the paper cassette or inside the printer. "1" appears with upper cassette, while "2" with lower cassette.	4-9
Paper jam Cassette 3 (4)	B	Paper is jammed at the option paper feeder cassette. When installing the paper feeder PF-70, "3" appears with upper cassette, while "4" with lower cassette.	4-9
Paper jam Finisher	C	Remove the paper jammed in the paper stacker. (For details, see the operation guide for document finisher)	See document finisher DF-75 Operation Guide
Paper jam MP Transport	D	Paper is jammed inside the MP transport.	4-9
Paper jam MP Tray	E	Paper is jammed at the MP tray.	4-9
Paper jam Reverse adapter	F	Paper is jammed at the reverse adapter of document finisher DF-75.	See document finisher DF-75 Operation Guide
Paper jam Left cover 1 (to 3)	G	Paper is jammed in the left cover section. "3" appears when jam occurs in the left cover section of the paper feeder.	4-11

When the jammed paper has been removed, open and close the printer's front cover. Then the printer automatically warms up, goes on-line, and continues printing. Depending on the point at which the jam occurred, the printer may or may not print the jammed page.

If paper jams occur frequently, try using a different type of paper, replace with paper from another ream, turn the stack of paper over, or turn the paper the other way around. Also, look for tiny pieces of paper that may have been torn off and overlooked when the jammed paper was removed.

If you cannot solve the problem by changing the paper, there may be a problem with the printer. Contact your service representative.

NOTE

When removing jammed paper, pull it out carefully so as not to tear it. Torn pieces of paper are difficult to remove and may be hard to find. Be sure to remove them all.

Online help messages

With the online help message function, this printer can display the procedure to correct a paper jam on the message display. When a paper jam message is displayed, press the **?** key.

Pressing the **▽** key at the online help message display shows the next step; pressing the **△** key shows the previous step. To exit the online help message display, press the **?** key. The previously shown paper jam message appears.

4.1 Jam in Paper Cassette

The following procedure also applies to the optional paper feeder.

- 1 Pull out the paper cassette.

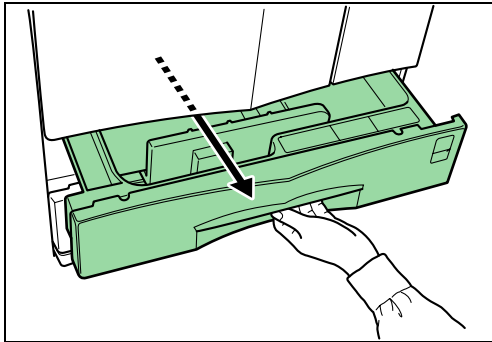

Figure 4-1

- 2 Remove the jammed paper while taking care not to tear it. If the paper has been torn, remove all the scraps from the inside the printer.

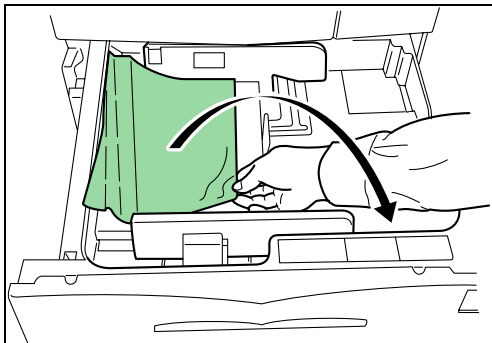

Figure 4-2

- 3 Close the paper cassette.

4.2 Jam at the MP Tray

Paper is jammed at the MP tray. Remove the jammed paper using the procedure given below.

- 1 Remove the paper jammed at the MP tray.

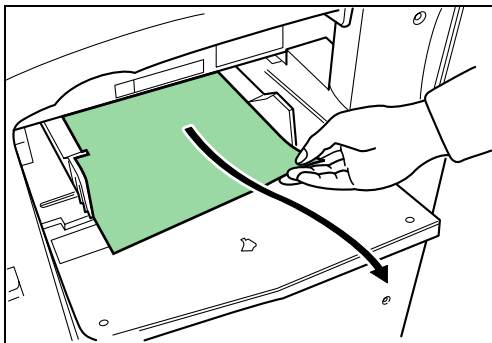

Figure 4-3

- 2 If the jammed paper remains at the MP tray, pull up the lever and remove the jammed paper.
*If the mised paper cannot be removed, go to the next step.

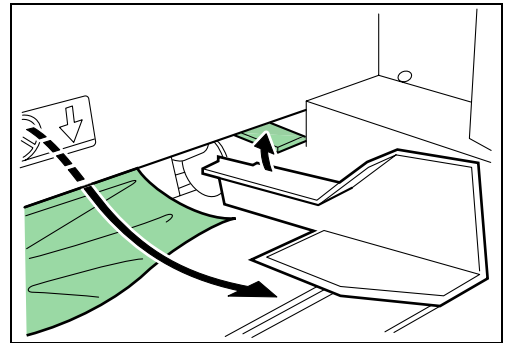

Figure 4-4

4.3 Jam inside the MP transport

- 1 Pull up the lock lever and open left cover 1.

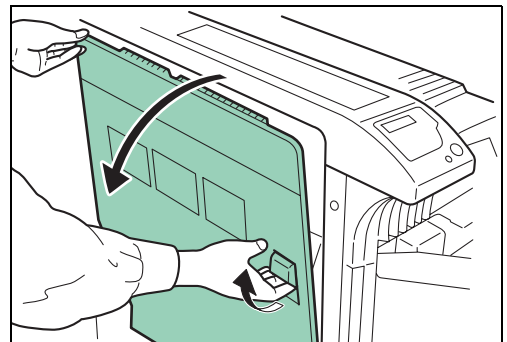

Figure 4-5

- 2 Remove the jammed paper.

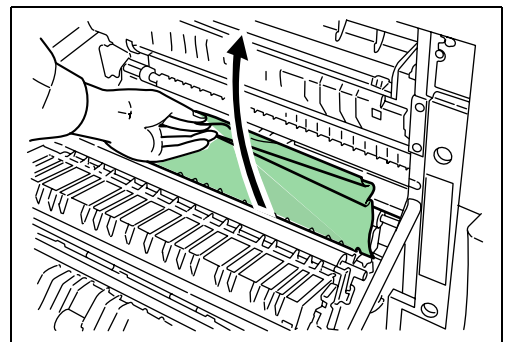

Figure 4-6

- 3 Push the lever (gray colored) to raise the duplex unit and remove the jammed paper.

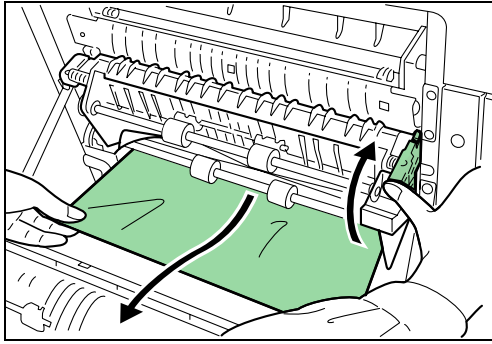

Figure 4-7

- 4 Open the front cover.

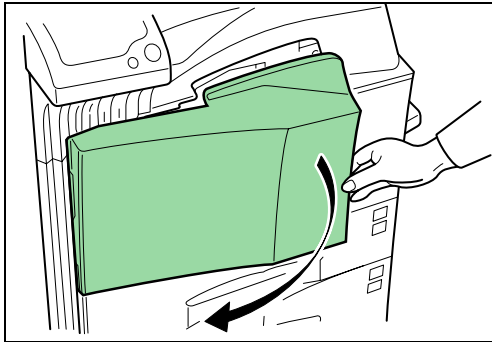

Figure 4-8

- 5 Turn the knob clockwise to release the jammed paper from the MP transport tray section.

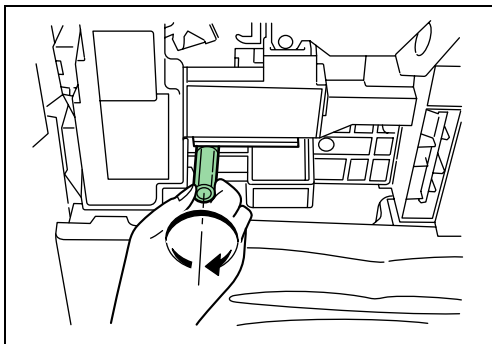

Figure 4-9

- 6 Open left cover 1 to remove paper jammed in the MP transport tray.

NOTE

When removing jammed paper, be careful not to touch the printer drum. This can cause printer malfunction.

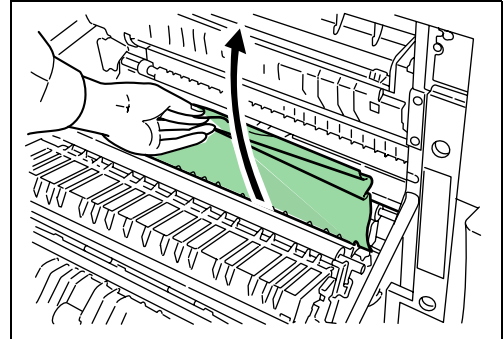

Figure 4-10

- 7 Pull out the MP transport tray as far as it will go.

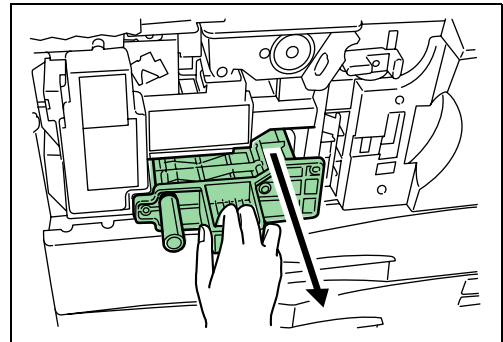

Figure 4-11

- 8 Open the MP transport tray cover and remove any jammed paper.

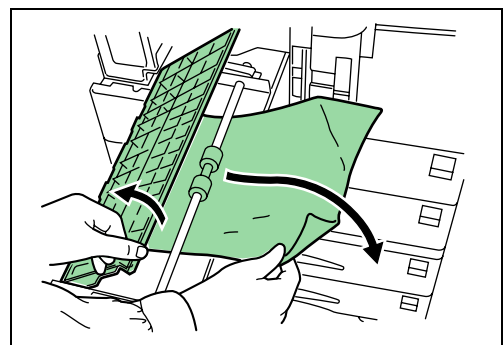

Figure 4-12

- 9** If the paper has been torn, remove the MP transport tray.

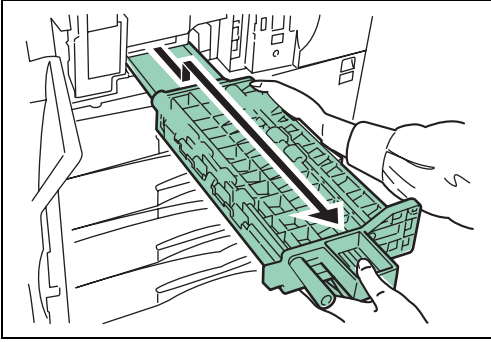

Figure 4-13

- 10** Remove the jammed paper.

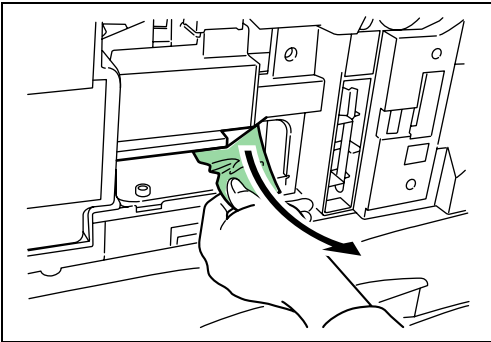

Figure 4-14

- 11** Replace the MP transport tray in its original position, then close the front cover.

4.4 Jam in Left Cover 1

⚠ CAUTION

- Take care not to leave any small pieces of paper in the printer when removing paper jams as this may result in fire.
- The printer's fixing unit is extremely hot. Take sufficient care when working in this area, as there is a danger of getting burned.

- 1** Pull up the lock lever and open left cover 1.

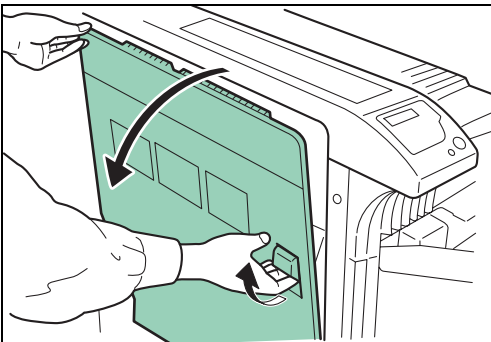

Figure 4-15

- 2** Remove the jammed paper.

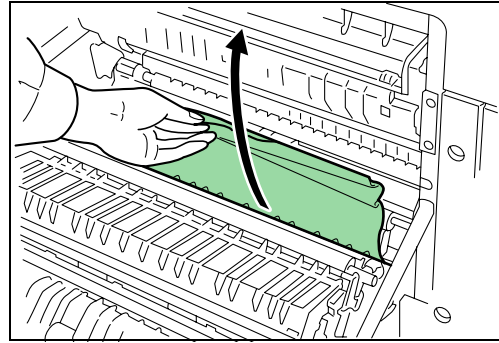

Figure 4-16

- 3** Push the lever (gray colored) to raise the duplex unit and remove the jammed paper.

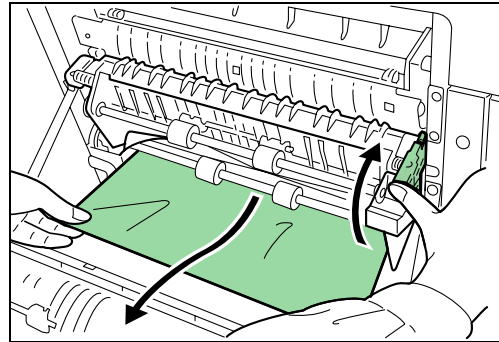

Figure 4-17

- 4** If there is jammed paper in the output section, remove it.

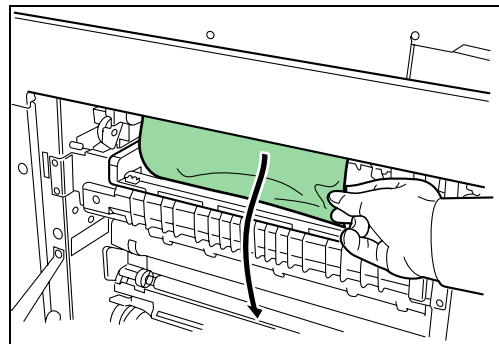

Figure 4-18

- 5** Close left cover 1.

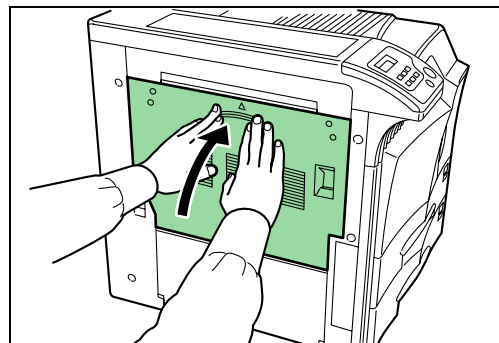

Figure 4-19

4.5 Jam in Left Cover 2

- 1 Open left cover 2.

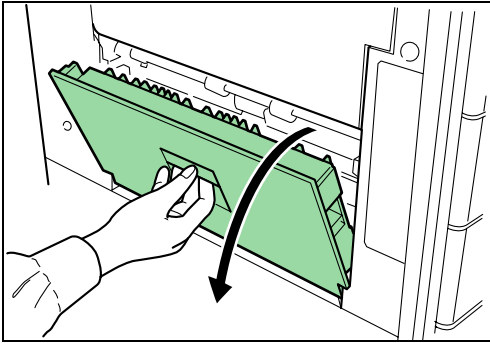

Figure 4-20

- 2 Remove the jammed paper.

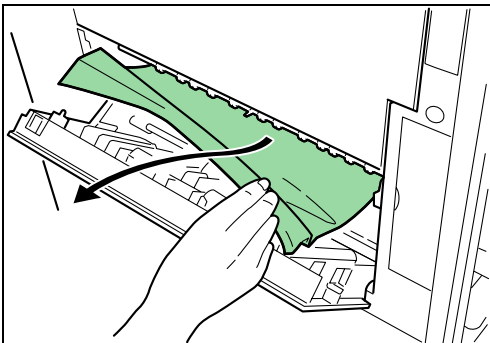

Figure 4-21

- 3 Close left cover 2.

4.6 Paper Jam at the Option Document Finisher

Paper is jammed at the option document finisher. Remove jammed paper referring to the Document Finisher Operation Guide.

Chapter 5 Maintenance

This chapter explains how to replace the toner container and the waste toner box and how to clean the internal parts of the printer. When you replace the toner container, make sure to clean the internal parts of the printer.

1. Toner Container Replacement

The toner container in the printer should be replaced as soon as the message display shows `Toner low` or soon after. If you continue to use the printer, eventually the toner supply will be exhausted at which point the printer will stop printing and the `Replace toner Clean printer` message will be shown instructing you to install a new toner kit.

1.1 Toner Container Replacement Interval

Assuming an average toner coverage of 5% and Ecoprint mode turned off, the toner container will need replacing approximately once every 40,000 pages.*

*For a new printer with a toner kit installed for the first time, the number of copies that can be printed will be approximately 20,000.

Toner Kits to be Used

Name: TK-70 (40,000 pages)

Contents: Toner container

Waste toner box

Wiper cloth

Grid cleaner

2 plastic bags (for disposal of the old toner container and waste toner box)

Installation Guide

NOTE

- Be sure to distance items such as floppy disks during toner container replacement.
- Be sure to clean the inside of the printer when replacing the toner container.
- Use of original Kyocera Mita toner kits is highly recommended to prevent printer trouble and ensure the long life of the printer.

1.2 Replenishing Toner

Replace the toner container using the following procedures.

- 1 Open the printer front cover all the way.

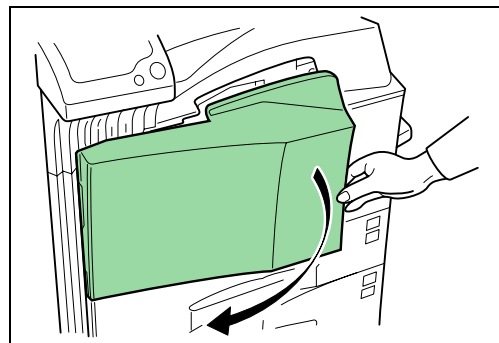

Figure 5-1

- 2 Push the lock lever (blue colored) up and gently remove the toner container until its handle appears.

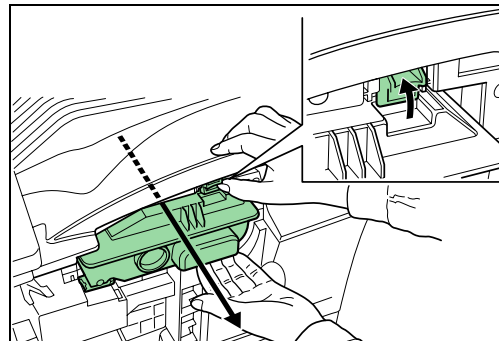

Figure 5-2

NOTE

Do not pull the toner container all the way as it can fall off and the toner spots the floor.

- 3** Grasp the handle on the toner container, push the lock lever up again and gently lift the toner container.

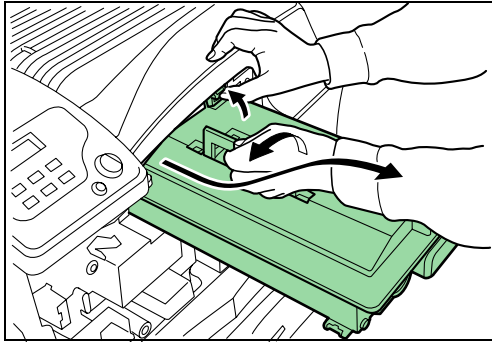

Figure 5-3

- 4** Seal up the old toner container with the supplied plastic bag and dispose of it.

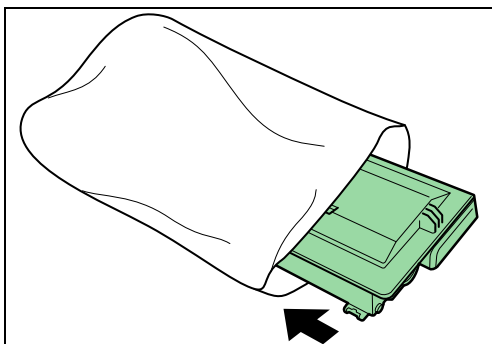

Figure 5-4

- 5** Lightly tap the new toner on the top 5 to 6 times.

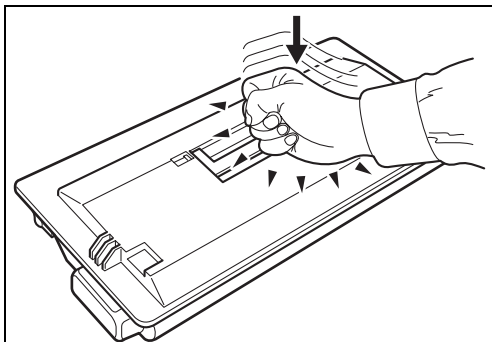

Figure 5-5

- 6** Thoroughly shake the toner container (in the direction of the arrow) ten times or more to loosen and mix the toner inside.

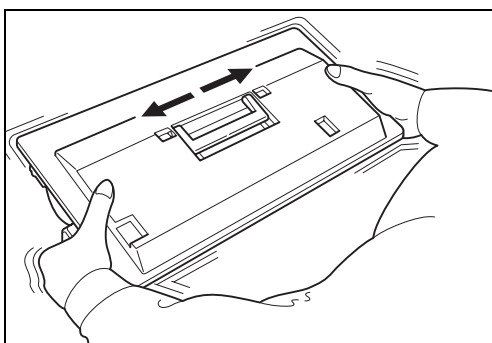

Figure 5-6

- 7** Grasp the handle on the toner container and insert the toner container along the rail of the printer.

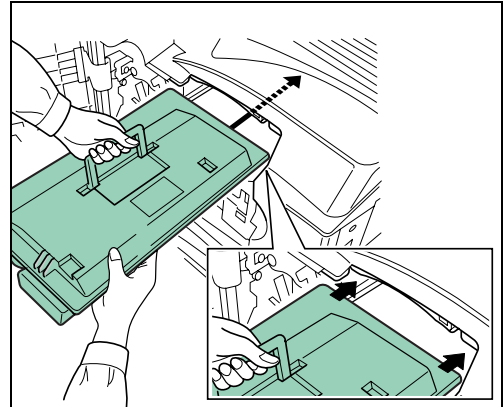

Figure 5-7

When inserting, be sure that the gear side of the toner container faces the printer. Leave the front cover open to allow insertion of the waste toner box.

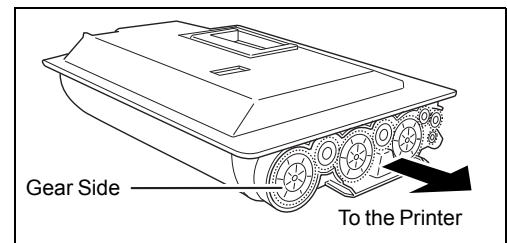

Figure 5-8

- 8** Hold the toner container using both hands and fully insert it into the printer.

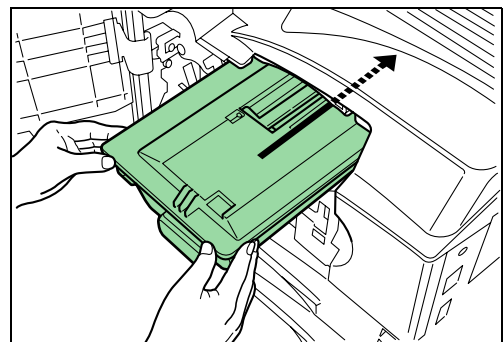

Figure 5-9

- 9** Remove the old waste toner box as shown in the figure.

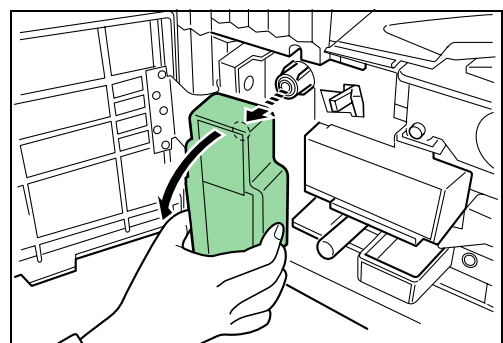

Figure 5-10

- 10** Remove the seal from the rear of the old waste toner box, and then close the opening of the box with the seal. Seal up the old waste toner box with the supplied plastic bag and dispose of it.

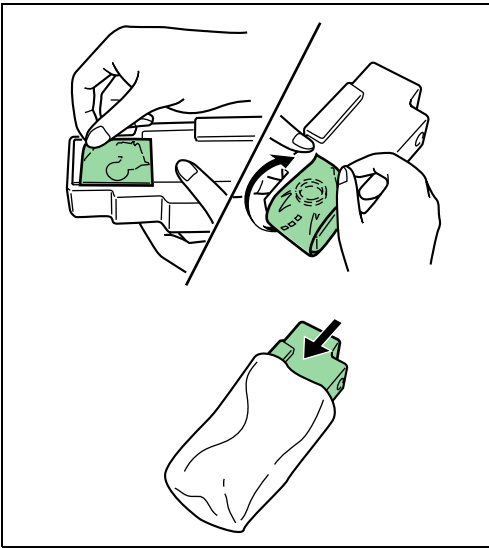

Figure 5-11

- 11** Gently pull the cleaning knob as far as it will go, push and pull it several times, and then push it back in.

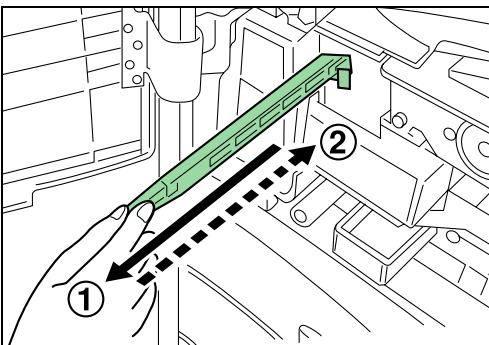

Figure 5-12

- 12** Take out the new grid cleaner from the protective bag, and then remove the cap from the grid cleaner.

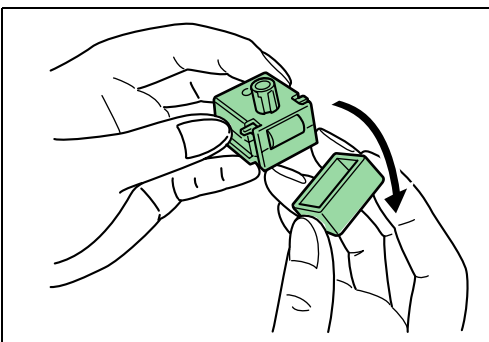

Figure 5-13

- 13** Pull the main charger approximately 5 cm (2 inches) out.

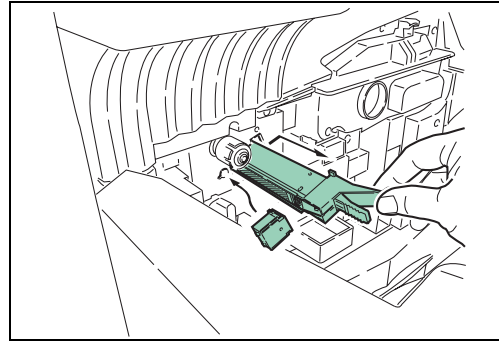

Figure 5-14

- 14** While avoiding the main charger roller (A) to be in contact with the grid cleaner pad, push and pull the main charger several times. (Do not push the main charger all the way in. Otherwise, water from the pad will cause the main charger unit to become wet and this may affect printing.)

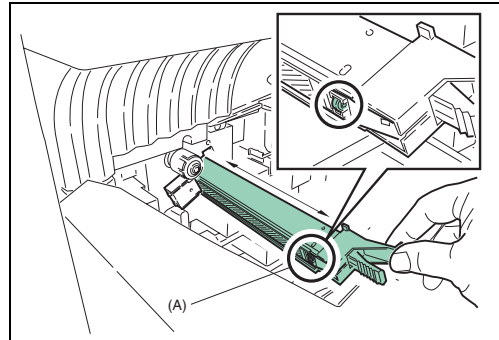

Figure 5-15

When the grid is clean, remove the grid cleaner from the printer and dispose of it. The grid cleaner is not re-usable.

- 15** Fit the new waste toner box to the printer.

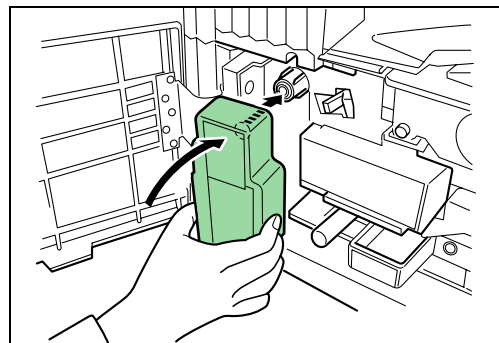

Figure 5-16

- 16** Remove the blue colored cleaning brush.

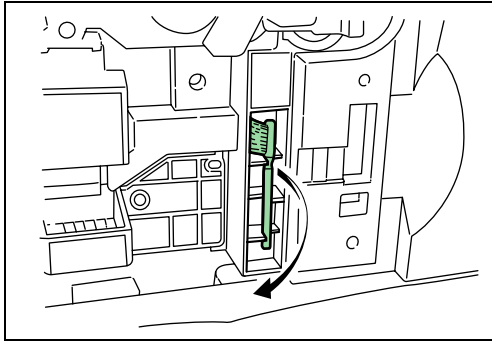

Figure 5-17

- 17** Pull up the lock lever on the left side of the printer, and open the left cover 1.

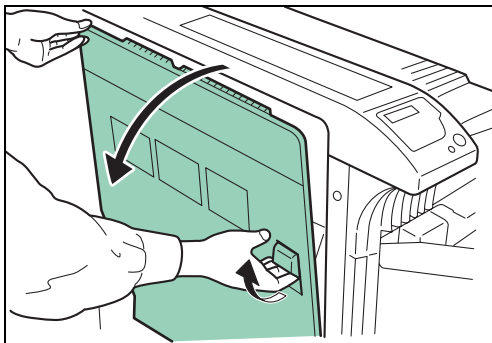

Figure 5-18

- 18** Clean the separator by moving the cleaning brush from left to right along with the separator.

NOTE

When removing jammed paper, be careful not to touch the printer drum. This can cause printer malfunction.

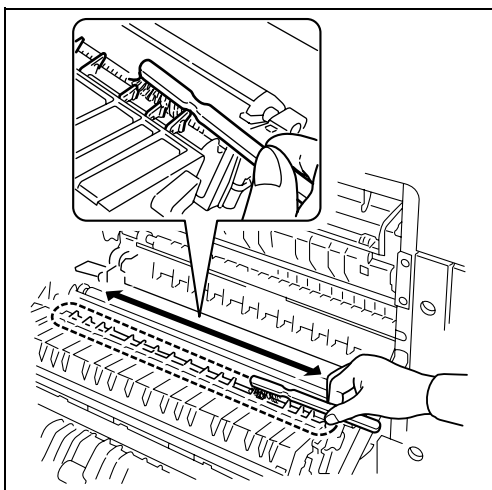

Figure 5-19

- 19** Replacing of toner and cleaning of the internal parts of the printer are completed. Close the front cover and the left cover 1.

Allow approximately five minutes before using the printer until the main charger unit has dried up.

Chapter 6 Fonts

This appendix explains the types of fonts you can use with the printer. A font is a set of characters of a particular design. The design is referred to as a typeface. Several characteristics identify a font. These include the code set (For details on the code sets, read the *PRESCRIBE Commands Technical Reference* on the supplied Kyocera Mita Document Library CD-ROM), spacing, pitch, height, style, stroke weight, and typeface family.

List of Fonts

This section contains a full list of the printer's internal fonts. The printer has 80 PCL fonts and 136 PostScript Level 3 compatible fonts. You can print the font list from the printer by using the printer's operator panel key. To print a list of fonts, refer to *Printing a List of Fonts on page 3-27*. Font may be downloaded to the printer's memory from a option memory card or hard disk.

■ PCL (Scalable and Bitmap) Fonts

AlbertusMd
 ABCDEabcde?*‘012345’
 AlbertusExtBd
ABCDEabcde?*‘012345’
 AntiqueOlive
 ABCDEabcde?*‘012345’
 AntiqueOlive-Bd
ABCDEabcde?*‘012345’
 AntiqueOlive-It
 ABCDEabcde?*‘012345’
 Arial
 ABCDEabcde?*‘012345’
 Arial-Bd
ABCDEabcde?*‘012345’
 Arial-It
 ABCDEabcde?*‘012345’
 Arial-BdIt
ABCDEabcde?*‘012345’
 CGOmega
 ABCDEabcde?*‘012345’
 CGOmega-Bd
ABCDEabcde?*‘012345’
 CGOmega-It
 ABCDEabcde?*‘012345’
 CGOmega-BdIt
ABCDEabcde?*‘012345’
 CGTimes
 ABCDEabcde?*‘012345’
 CGTimes-Bd
ABCDEabcde?*‘012345’
 CGTimes-It
 ABCDEabcde?*‘012345’
 CGTimes-BdIt
ABCDEabcde?*‘012345’
 Clarendon-Cd
ABCDEabcde?*‘012345’
 Courier
 ABCDEabcde?* ‘012345’
 Courier-Bd
ABCDEabcde?* ‘012345’
 Courier-It
 ABCDEabcde?* ‘012345’
 Courier-BdIt
ABCDEabcde?* ‘012345’
 CourierPS
 ABCDEabcde?* ‘012345’
 CourierPS-Bd
ABCDEabcde?* ‘012345’
 CourierPS-Ob
 ABCDEabcde?* ‘012345’
 CourierPS-BdOb
ABCDEabcde?* ‘012345’
 Coronet
ABCDEabcde?‘012345’*
 GaramondAntiqua
 ABCDEabcde?*‘012345’
 Garamond-Hlb
ABCDEabcde?*‘012345’
 Garamond-Krsv
 ABCDEabcde?*‘012345’
 Garamond-HlbKrsv
ABCDEabcde?*‘012345’
 Helvetica
 ABCDEabcde?*‘012345’
 Helvetica-Bd
ABCDEabcde?*‘012345’
 Helvetica-Ob
 ABCDEabcde?*‘012345’
 Helvetica-BdOb
ABCDEabcde?*‘012345’
 Helvetica-Nr
 ABCDEabcde?*‘012345’
 Helvetica-NrBd
ABCDEabcde?*‘012345’
 Helvetica-NrOb
 ABCDEabcde?*‘012345’
 Helvetica-NrBdOb
ABCDEabcde?*‘012345’
 ITCAvantGardeGothic-Bk
 ABCDEabcde?*‘012345’
 ITCAvantGardeGothic-Dm
ABCDEabcde?*‘012345’
 ITCAvantGardeGothic-BkOb
 ABCDEabcde?*‘012345’
 ITCAvantGardeGothic-DmOb
ABCDEabcde?*‘012345’
 ITCBookman-Lt
 ABCDEabcde?*‘012345’
 ITCBookman-Dm
ABCDEabcde?*‘012345’
 ITCBookman-LtIt
 ABCDEabcde?*‘012345’
 ITCBookman-DmIt
ABCDEabcde?*‘012345’
 ITCZapfChancery-MdIt
ABCDEabcde?‘012345’*
 ITCZapfDingbats
 ✪✠✡✢✣✤✥✦✧✨✩✪✫✬✭✮✯✰✱✲✳✴✵✶✷✸✹✺✻✼✽✾✿
 LetterGothic
 ABCDE abcde?* ‘012345’
 LetterGothic-Bd
ABCDE abcde?* ‘012345’
 LetterGothic-It
ABCDEabcde? ‘012345’*
 Marigold
 ABCDEabcde?*‘012345’
 NewCenturySchoolbook-Rom
 ABCDEabcde?*‘012345’
 NewCenturySchoolbook-Bd
ABCDEabcde?*‘012345’
 NewCenturySchoolbook-It
ABCDEabcde?‘012345’*
 NewCenturySchoolbook-BdIt
ABCDEabcde?*‘012345’
 Palatino
 ABCDEabcde?*‘012345’
 Palatino-Bd
ABCDEabcde?*‘012345’
 Palatino-It
 ABCDEabcde?*‘012345’
 Palatino-BdIt
ABCDEabcde?*‘012345’
 Symbol
 ABXΔEαβχδε?*012345
 SymbolPS
 ABXΔEαβχδε?*012345
 TimesNewRoman
 ABCDEabcde?*‘012345’
 TimesNewRoman-Bd
ABCDEabcde?*‘012345’
 TimesNewRoman-It
ABCDEabcde?‘012345’*
 TimesNewRoman-BdIt
ABCDEabcde?*‘012345’
 Times-Rom
 ABCDEabcde?*‘012345’
 Times-Bd
ABCDEabcde?*‘012345’
 Times-It
 ABCDEabcde?*‘012345’
 Times-BdIt
ABCDEabcde?*‘012345’
 Univers-Md
 ABCDE abcde?* ‘012345’
 Univers-Bd
ABCDEabcde?* ‘012345’
 Univers-MdIt
 ABCDEabcde?* ‘012345’
 Univers-BdIt
ABCDEabcde?* ‘012345’
 Univers-MdCd
 ABCDE abcde?* ‘012345’
 Univers-BdCd
ABCDEabcde?* ‘012345’
 Univers-MdCdIt
 ABCDEabcde?*‘012345’
 Univers-BdCdIt
ABCDEabcde?*‘012345’
 Windings
 ①②③④⑤⑥⑦⑧⑨⑩⑪⑫⑬⑭⑮⑯⑰⑱⑲⑳㉑㉒㉓㉔㉕㉖㉗㉘㉙㉚㉛㉜㉝㉞㉟㊀㊁㊂
 LinePrinterBM8.5-Roman (Bitmap font)
ABCDEabcde?*‘012345’

Chapter 6 Fonts

■ KPDL Fonts (1)

AlbertusMT
ABCDEabcde?*012345'
AlbertusMT-Italic
*ABCDEabcde?*012345'*
AlbertusMT-Light
ABCDEabcde?*012345'
AntiqueOlive-Bold
ABCDEabcde?*012345'
AntiqueOlive-Compact
ABCDEabcde?*012345'
AntiqueOlive-Italic
*ABCDEabcde?*012345'*
AntiqueOlive-Roman
ABCDEabcde?*012345'
Apple-Chancery
*ABCDEabcde?*012345'*
Arial-BoldItalicMT
ABCDEabcde?*012345'
Arial-BoldMT
ABCDEabcde?*012345'
Arial-ItalicMT
*ABCDEabcde?*012345'*
ArialMT
ABCDEabcde?*012345'
AvantGarde-Book
ABCDEabcde?*012345'
AvantGarde-BookOblique
*ABCDEabcde?*012345'*
AvantGarde-Demi
ABCDEabcde?*012345'
AvantGarde-DemiOblique
*ABCDEabcde?*012345'*
Bodoni
ABCDEabcde?*012345'
Bodoni-Bold
ABCDEabcde?*012345'
Bodoni-BoldItalic
*ABCDEabcde?*012345'*
Bodoni-Italic
*ABCDEabcde?*012345'*
Bodoni-Poster
ABCDEabcde?*012345'
Bodoni-PosterCompressed
ABCDEabcde?*012345'
Bookman-Demi
ABCDEabcde?*012345'
Bookman-Demilight
*ABCDEabcde?*012345'*
Bookman-Light
ABCDEabcde?*012345'
Bookman-LightItalic
*ABCDEabcde?*012345'*
Candide
*ABCDEabcde?*012345'*
Chicago
ABCDEabcde?*012345'
Clarendon
ABCDEabcde?*012345'
Clarendon-Bold
ABCDEabcde?*012345'
Clarendon-Light
ABCDEabcde?*012345'
CooperBlack
ABCDEabcde?*012345'
CooperBlack-Italic
*ABCDEabcde?*012345'*
Copperplate-ThirtyThreeBC
ABCDEabcde?*012345'
Copperplate-ThirtyTwoBC
ABCDEabcde?*012345'
Coronet-Regular
*ABCDEabcde?*012345'*
Courier
ABCDEabcde?*012345'
Courier-Bold
ABCDEabcde?*012345'

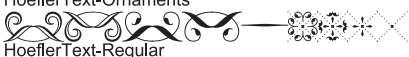
Courier-BoldOblique
ABCDEabcde?*012345'
Courier-Oblique
*ABCDEabcde?*012345'*
Eurostile
ABCDEabcde?*012345'
Eurostile-Bold
ABCDEabcde?*012345'
Eurostile-BoldExtendedTwo
ABCDabcde?*0123'
Eurostile-ExtendedTwo
ABCDabcde?*0123'
Geneva
ABCDEabcde?*012345'
GillSans
ABCDEabcde?*012345'
GillSans-Bold
ABCDEabcde?*012345'
GillSans-BoldCondensed
ABCDEabcde?*012345'
GillSans-BoldItalic
*ABCDEabcde?*012345'*
GillSans-Condensed
ABCDEabcde?*012345'
GillSans-ExtraBold
ABCDEabcde?*012345'
GillSans-Italic
*ABCDEabcde?*012345'*
GillSans-Light
ABCDEabcde?*012345'
GillSans-LightItalic
*ABCDEabcde?*012345'*
Goudy
ABCDEabcde?*012345'
Goudy-Bold
ABCDEabcde?*012345'
Goudy-BoldItalic
*ABCDEabcde?*012345'*
Goudy-ExtraBold
ABCDEabcde?*012345'
Goudy-Italic
*ABCDEabcde?*012345'*
Helvetica
ABCDEabcde?*012345'
Helvetica-Bold
ABCDEabcde?*012345'
Helvetica-BoldOblique
*ABCDEabcde?*012345'*
Helvetica-Condensed
ABCDEabcde?*012345'
Helvetica-Condensed-Bold
ABCDEabcde?*012345'
Helvetica-Condensed-BoldObl
*ABCDEabcde?*012345'*
Helvetica-CondensedOblique
*ABCDEabcde?*012345'*
Helvetica-Narrow
ABCDEabcde?*012345'
Helvetica-Narrow-Bold
ABCDEabcde?*012345'
Helvetica-Narrow-BoldOblique
*ABCDEabcde?*012345'*
Helvetica-Narrow-Oblique
*ABCDEabcde?*012345'*
Helvetica-Oblique
*ABCDEabcde?*012345'*
HoeflerText-Black
ABCDEabcde?*012345'
HoeflerText-BlackItalic
*ABCDEabcde?*012345'*
HoeflerText-Italic
*ABCDEabcde?*012345'*
HoeflerText-Ornaments

HoeflerText-Regular
ABCDEabcde?*012345'

■ KPDL Fonts (2)

JoannaMT
 ABCDEabcde?*‘012345’
 JoannaMT-Bold
ABCDEabcde?*‘012345’
 JoannaMT-BoldItalic
ABCDEabcde?*‘012345’
 JoannaMT-Italic
 ABCDEabcde?*‘012345’
 LetterGothic
 ABCDE abcde?*‘ 012345’
 LetterGothic-Bold
ABCDE abcde?*‘ 012345’
 LetterGothic-BoldSlanted
ABCDEabcde?‘ 012345’*
 LetterGothic-Slanted
ABCDEabcde?‘ 012345’*
 LubalinGraph-Book
 ABCDEabcde?*‘012345’
 LubalinGraph-BookOblique
ABCDEabcde?‘012345’*
 LubalinGraph-Demi
ABCDEabcde?*‘012345’
 LubalinGraph-DemiOblique
ABCDEabcde?*‘ 012345’
 Marigold
 ABCDEabcde?*‘012345’
 MonaLisa-Recut
 ABCDEabcde?*‘012345’
 Monaco
 ABCDE abcde?*‘ 012345’
 NewCenturySchlbk-Bold
ABCDEabcde?*‘012345’
 NewCenturySchlbk-BoldItalic
ABCDEabcde?*‘012345’
 NewCenturySchlbk-Italic
ABCDEabcde?‘012345’*
 NewCenturySchlbk-Roman
 ABCDEabcde?*‘012345’
 New York
 ABCDEabcde?*‘012345’
 Optima
 ABCDE abcde?*‘012345’
 Optima-Bold
ABCDEabcde?*‘012345’
 Optima-BoldItalic
ABCDEabcde?*‘012345’
 Optima-Italic
ABCDEabcde?‘012345’*
 Oxford
 ABCDEabcde?*‘012345’
 Palatino-Bold
ABCDEabcde?*‘012345’
 Palatino-BoldItalic
ABCDEabcde?*‘012345’
 Palatino-Italic
ABCDEabcde?‘012345’*
 Palatino-Roman
 ABCDEabcde?*‘012345’
 StempelGaramond-Bold
ABCDEabcde?*‘012345’
 StempelGaramond-BoldItalic
ABCDEabcde?*‘012345’
 StempelGaramond-Italic
ABCDEabcde?‘012345’*
 StempelGaramond-Roman
 ABCDEabcde?*‘012345’
 Symbol
 ABXΔEαβχδε?*012345
 Taffy
 ABCDE abcde?*‘012345’
 Times-Bold
ABCDEabcde?*‘012345’
 Times-BoldItalic
ABCDEabcde?*‘012345’
 Times-Italic
ABCDEabcde?‘012345’*

Times-Roman
 ABCDEabcde?*‘012345’
 TimesNewRomanPS-BoldItalicMT
ABCDEabcde?*‘012345’
 TimesNewRomanPS-BoldMT
ABCDEabcde?*‘012345’
 TimesNewRomanPS-ItalicMT
ABCDEabcde?‘012345’*
 TimesNewRomanPSMT
 ABCDEabcde?*‘012345’
 Univers
 ABCDE abcde?*‘012345’
 Univers-Bold
ABCDEabcde?*‘012345’
 Univers-BoldExt
ABCDE abcde?*‘012345’
 Univers-BoldExtObl
ABCDEabcde?*‘ 012345’
 Univers-BoldOblique
ABCDEabcde?*‘012345’
 Univers-Condensed
 ABCDE abcde?*‘012345’
 Univers-Condensed-Bold
ABCDE abcde?*‘012345’
 Univers-CondensedBoldOblique
ABCDEabcde?*‘012345’
 Univers-CondensedOblique
ABCDEabcde?‘012345’*
 Univers-Extended
 ABCDE abcde?*‘012345’
 Univers-ExtendedObl
ABCDEabcde?‘ 012345’*
 Univers-Light
 ABCDE abcde?*‘012345’
 Univers-LightOblique
ABCDEabcde?‘ 012345’*
 Univers-Oblique
ABCDEabcde?‘012345’*
 Wingdings-Regular
 ☺☻☼☽☾☿ⓂⓃⓄⓅⓆⓇⓈⓉ
 ZapfChancery-MediumItalic
ABCDEabcde?‘012345’*
 ZapfDingbats
 ☆✦✧✨✩✪✫✬✭✮✯✰✱✲✳✴✵✶✷✸

Appendix A Option Units

This appendix explains how to install each option unit. Also refer to the manuals of the respective option units. Also this appendix explains how to remove the main circuit board and then how to install a DIMM (Dual In-line Memory Module) on the main circuit board. Expanded printer memory enables you to print more complex pages, download more fonts, and define more macros.

1. Available Options

The printer has the following options available. For instructions on installing individual options, refer to the documentation included with the option.

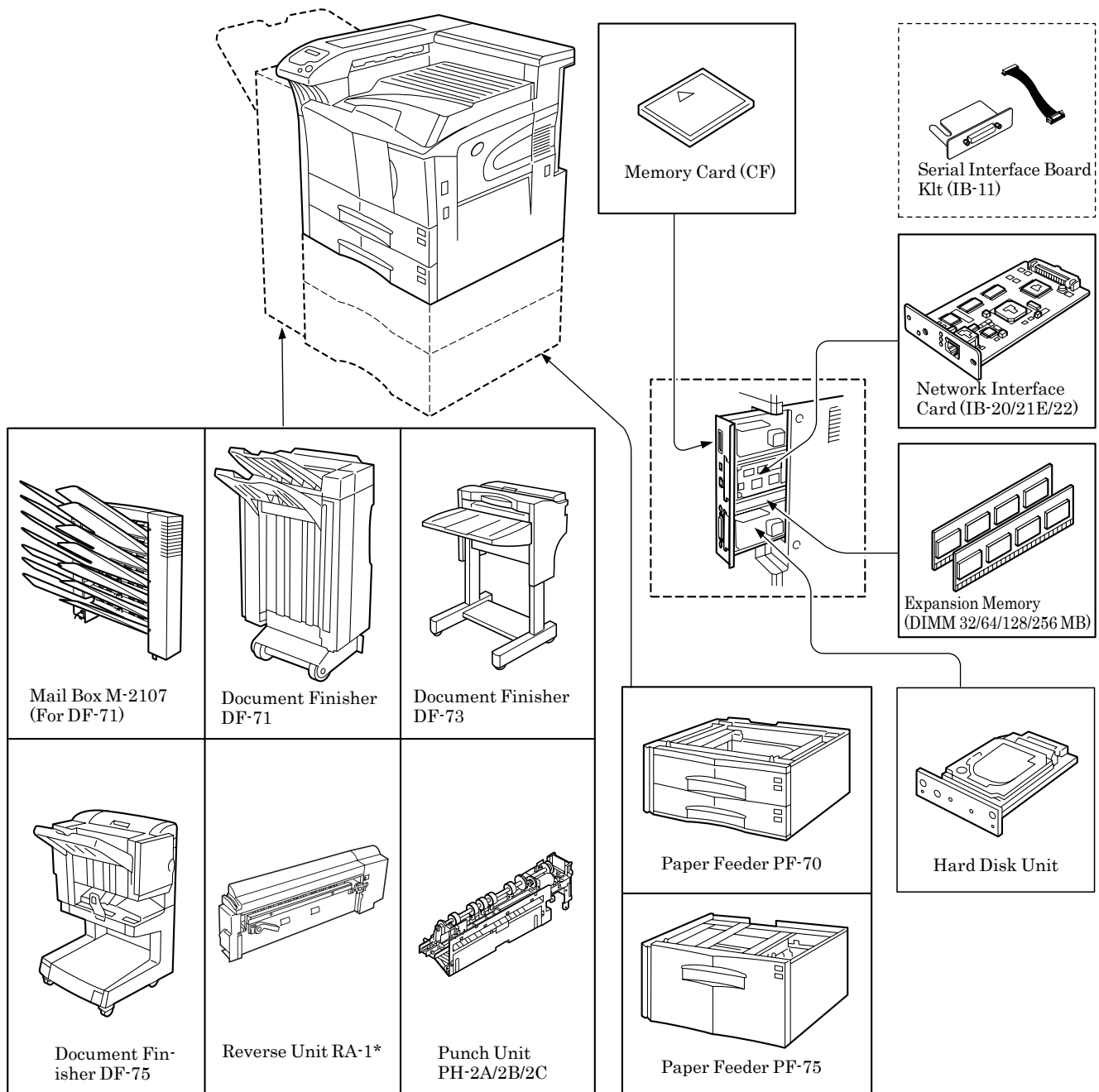

*: For facedown high-speed printing.

Figure A-1

PF-70 Paper Feeder

Holds approximately 500 sheets of A5 to A3 (11 × 17" in Ledger) size paper. Up to two paper feeders can be attached to the bottom of the printer.

PF-75 Paper Feeder

Holds approximately 3000 sheets of A4, B5 or Letter size (8.5 × 11") paper. Only one paper feeder can be attached to the bottom of the printer.

IB-20/21E/22 Network Interface Card

Is used to communicate using the network protocols such as NetWare, TCP/IP or EtherTalk.

IB-20/IB-21E/IB-22 Network Interface Cards

Along with the standard for the network interface on the printer, the network interface card supports TCP/IP, IPX/SPX, NetBEUI and EtherTalk protocols, so that the printer can be used on network environments including Windows, Macintosh, UNIX, NetWare, etc.

Network interface card	Network connections
IB-20	10Base-T/100Base-TX/10Base-2
IB-21E	10Base-T/100Base-TX
IB-22	IEEE802.11b (Wireless)

Table A-1

DF-71 Document Finisher

Provide finishing with about 3,000 sheets at a time with high-speed and large-capacity processes. Also provides a punch function. They are installed to the left side of the printer.

DF-73 Document Finisher

Provides finishing with about 1000 sheets at a time. Also provides staple and off set functions. It is installed to the left side of the printer.

DF-75 Document Finisher

Provides the staple, punch (option), offset and stitch functions. It is installed to the left side of the printer.

Other Options**• Hard Disk Unit**

Enables the electronic sorting and job retention functions. To be inserted into the slot OPT1/HDD designed for it on the main circuit board of the printer.

• Memory Card (CF)

This is a microchip card that may contain option fonts, macros, and forms. Insert the memory card into the memory card slot located on the right of the printer. See your dealer for purchasing information regarding the memory Cards that are best suited for use with this printer.

• Memory DIMM

See your dealer for purchasing information of the DIMM that are best suited for use with this printer. See [Appendix A Option Units](#) for the installation procedure.

2. Installing Option Units

2.1 PF-70/75 Paper Feeders

PF-70 or PF-75 Paper Feeder can be installed below the printer.

PF-70 Paper Feeder holds approximately 500 sheets of A4 to A3 (11 × 17" in Ledger) size paper.



PF-70

Figure A-2

PF-75 Paper Feeder holds approximately 3000 sheets of A4, B5 or Letter size (8.5 × 11") paper.

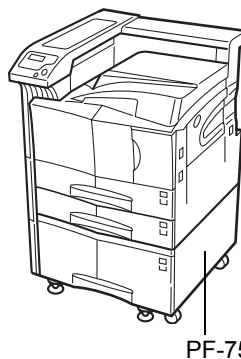

PF-75

Figure A-3

For details of installing the optional paper feeder in the printer, see the [PF-70/75 Installation Guide](#).

2.2 DF-71/73/75 Document Finishers

DF-71/73/75 Document Finisher can be installed to the printer.

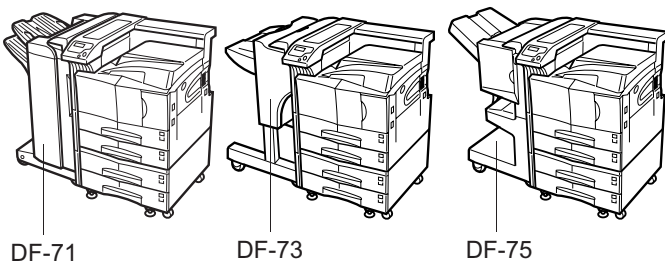

DF-71

DF-73

DF-75

Figure A-4

For details of installing the optional finisher in the printer, see the [DF-71/73/75 Installation Guide](#).

2.3 Network Interface

The FS-9120DN/FS-9520DN have the standard Network interface. This printer supports the TCP/IP, IPX/SPX, NetBEUI, and EtherTalk protocols, so the network printing under various platforms such as Windows, Macintosh, UNIX, and NetWare is available.

An option network interface card can be added by the following procedure.

- 1 Turn off the printer and disconnect the power cord and printer cable.
- 2 Remove the two screws from the option interface slot cover (OPT).

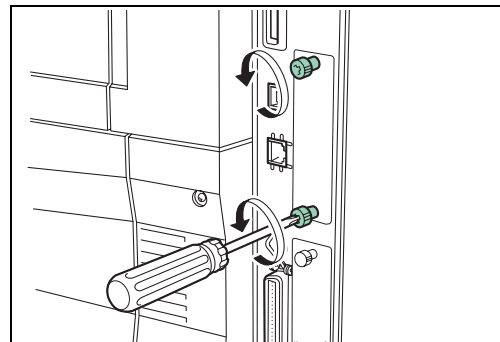

Figure A-5

- 3 Insert the network interface card and secure it with the screws removed in step 2.

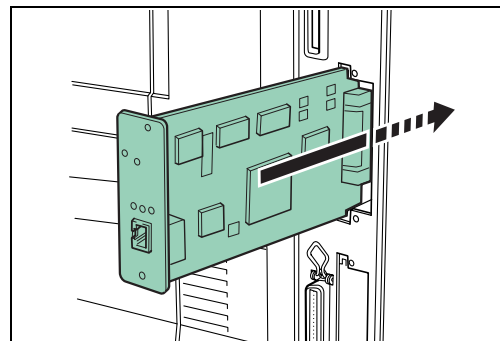

Figure A-6

- 4 Connect the network cable.

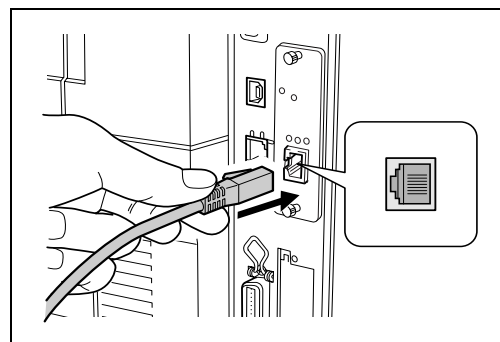

Figure A-7

- 5 Set the network address from the printer operator panel (for details about the modes, see [Changing Network Interface Parameters on page 3-20](#)).

2.4 Hard Disk

Insert the hard disk into its slot on the main circuit board of the printer. If a hard disk unit is installed in the printer, received data can be rasterized and stored on this hard disk. This enables high-speed printing of multiple copies using an electric sort function. Also, you can use the e-MPS functions. For details, see *e-MPS on page 3-12*.

For details on available hard disks, see your dealer.

- 1 Turn off the printer and disconnect the power cord and printer cable.
- 2 Remove the two screws and remove the slot cover (HDD).

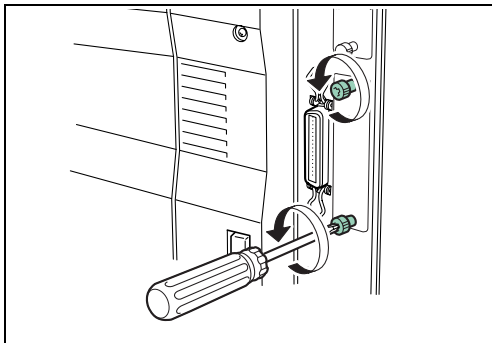

Figure A-8

- 3 Insert the optional hard disk unit into the slot.

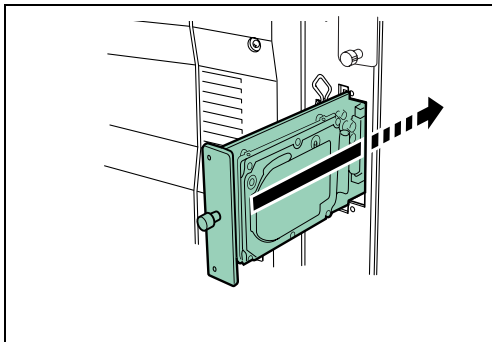

Figure A-9

- 4 Tighten the two screws to secure the hard disk unit to the main circuit board.

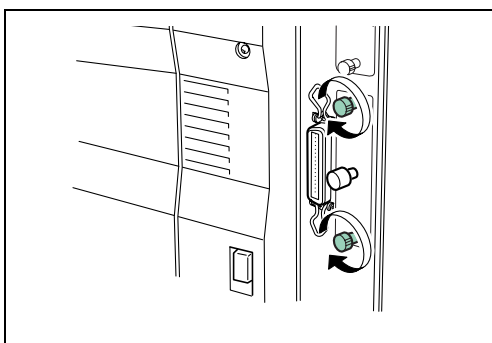

Figure A-10

2.5 Memory Card

Insert the memory card into the memory card slot located on the right side of the printer. A memory card is a microchip card that may contain option fonts, macros, forms, etc. The printer reads the contents of the card into its internal memory when printer is turned on.

For details of available memory cards, see your dealer.

- 1 Turn off the printer.

NOTE

Do not insert or remove a memory card while the power is on. If the memory card is removed while the printer is on, damage could result in the printer's electronics or the memory card.

- 2 Insert the memory card in the slot. Insert it with its label surface facing toward the outside, connector end first. Push it in all the way.

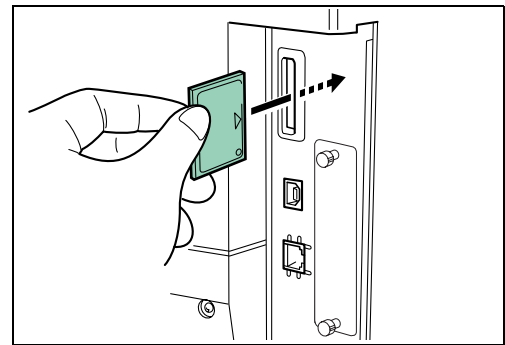

Figure A-11

3. Removing the Main Circuit Board

The main circuit board of the printer is equipped with two sockets for memory expansion. Expansion memory is available in the form of DIMMs.

NOTE

The expansion memory should be installed only by a Kyocera Mita authorized dealer or Kyocera Mita certified technician. Kyocera Mita shall not be liable for damage due to improper installation of the expansion memory.

The following instructions are intended for the technician only.

3.1 Notes on Handling the Main Circuit Board and DIMM

Protect the electronics by taking these precautions:

- Before touching the main circuit board and DIMM, touch a water pipe or other large metal object to discharge yourself of static electricity. While doing the work, it is recommended that you wear an antistatic wrist strap.
- Touch the main circuit board and DIMM only at the edges.



Figure A-12

3.2 Removing the Main Circuit Board from the Printer

Remove the main circuit board completely from the printer as follows:

- 1 Turn off the printer and disconnect the power cord and printer cable.
- 2 Remove the two screws from the printer.

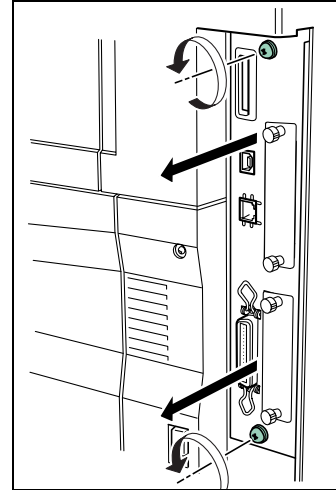

Figure A-13

- 3 Pull the main circuit board all the way out of the printer.

NOTE

Before pulling the main circuit board out, clear away the area, behind the printer. Foreign objects, accidentally sticking to the back of the main circuit board, can cause serious damage to the printer.

4. Installing DIMMs

■ DIMMs to be used

See your Kyocera Mita dealer for purchasing information of the DIMMs that are best suited for use with this printer. 32 MB, 64 MB, 128 MB and 256 MB DIMMs can be used for memory expansion.

Insert the DIMM into the socket as shown below.

- 1 Remove the DIMM from its package.
- 2 Open the clips on both ends of the DIMM socket.
- 3 Insert the DIMM into the socket, so that the notches on the DIMM align with the corresponding protrusions in the socket.

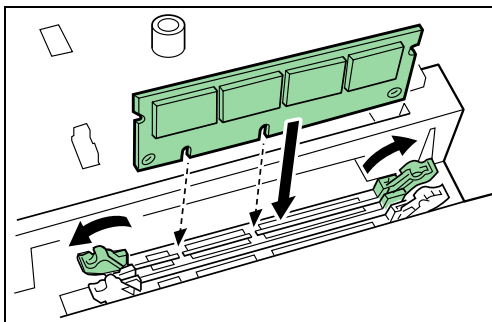

Figure A-14

- 4 Close the clips of the DIMM socket to secure the DIMM.

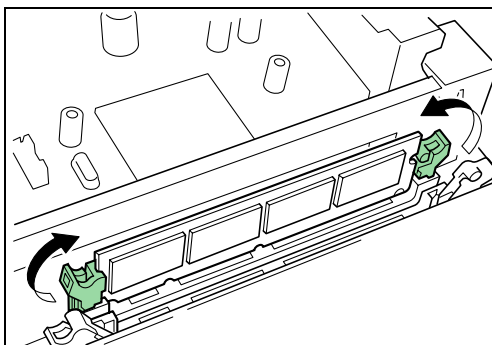

Figure A-15

- 5 When you finish installing the DIMM, reinsert the main circuit board into the printer by reversing the removal procedure.

4.1 Removing DIMM

To remove a DIMM, carefully pull the end clips outwards, then pull the DIMM out of the socket.

Return the main circuit board to the printer by reversing the procedure explained in [Removing the Main Circuit Board from the Printer on page A-5](#).

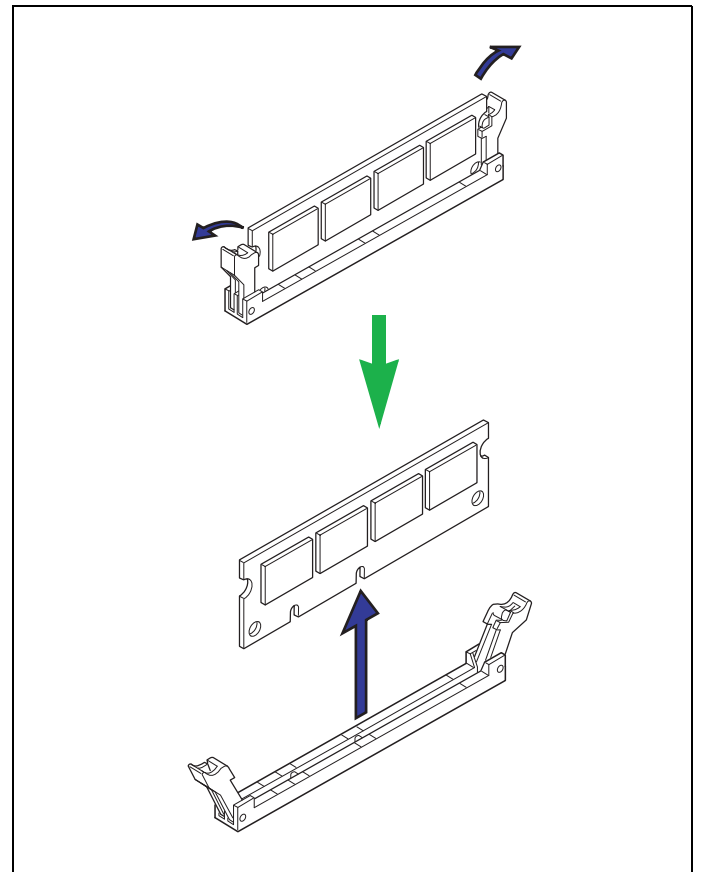

Figure A-16

4.2 Testing the Expansion Memory

After you finish installing DIMMs in the printer, test the printer to see if the installation was successful. To test the expansion memory, proceed as follows:

- 1 Make sure the printer is turned off. Plug the power cord into the printer and turn the printer on.
- 2 Press the **MENU** key on the operator panel.
- 3 Press the Δ or ∇ key repeatedly until **Print Status Page** appears.
- 4 Press the **ENTER** key twice.
- 5 If the installation was successful, the amount of memory shown on the status page will correspond with the amount of expanded memory. (The factory installed memory size is 32 MB for FS-9120DN, 64 MB for FS-9520DN.)

Appendix B Host Computer Interface

This appendix explains the signals used in the printer's parallel, USB, and serial (option) interfaces. It also lists pin assignments, signal functions, timings, connector specifications, and voltage levels. For details on the network interface, refer to the IB-21E/IB-22 User's Manual contained on the CD-ROM that is supplied with the printer.

This appendix explains the following topics:

- Parallel Interface
- USB Interface
- Serial Interface (option)

1. Parallel Interface

1.1 Parallel Interface Communication Modes

The printer features fast data transmission with the parallel interface. The parallel interface mode can be activated from the operator panel.

See [Changing Parallel Interface Modes on page 3-19](#).

NOTE

Use a parallel printer cable that complies with the IEEE1284 standard.

Nibble (high) [default]

High speed data communication is used in compliance with the IEEE1284 standard. Ordinarily, you should leave this setting unchanged.

Auto

The printer automatically changes its communication mode to the one the host computer is currently using.

Normal

The printer uses the standard communication method prescribed for Centronics interfaces.

High-speed

This mode enables faster data transmission between the printer and the host computer. (Select this mode if printing problems occur when the printer is connected to a workstation.)

1.2 Interface Signals

The pins of the parallel interface connector carry the signals listed in the table in [Parallel Connector Pin Assignment](#). As-

terisks in the table indicate signals that are low active. The table also indicates whether each signal is incoming or outgoing with respect to the printer.

Parallel Connector Pin Assignment

Pin	In/out	Description
1	In	Strobe* [nStrobe]
2	In/Out	Data 0 [Data 1]
3	In/Out	Data 1 [Data 2]
4	In/Out	Data 2 [Data 3]
5	In/Out	Data 3 [Data 4]
6	In/Out	Data 4 [Data 5]
7	In/Out	Data 5 [Data 6]
8	In/Out	Data 6 [Data 7]
9	In/Out	Data 7 [Data 8]
10	Out	Acknowledge* [nAck]
11	Out	Busy [Busy]
12	Out	Paper Empty [PError], returns paper empty status if FRPO O2=2
13	Out	Online (Select) [nSelect], returns offline status if FRPO O2=2
14	In	Auto-feed [nAutoFd]
15	-	Not connected
16	-	0 V DC
17	-	Chassis GND
18	-	+5 V DC
19	-	Ground
20	-	Ground
21	-	Ground
22	-	Ground
23	-	Ground
24	-	Ground
25	-	Ground
26	-	Ground
27	-	Ground
28	-	Ground
29	-	Ground
30	-	Ground
31	In	Ignored [nInit]
32	Out	Error*, returns error status if FRPO O2=2 [nFault]
33	-	Not connected
34	-	Not connected
35	Out	Power Ready
36	In	Ignored [nSelectIn]

Table B-1

[]: Signal names in the Auto mode and Nibble (high) mode (IEEE1284).
In the Auto mode and Nibble (high) mode, these signals are bi-directional.

Detailed descriptions of the signals follow.

Strobe* [nStrobe] (Pin 1)

A negative-going Strobe* pulse causes the printer to read and latch the data on the Data 0 [1] to Data 7 [8] signal lines.

Data 0 [1] to Data 7 [8] (Pins 2 to 9)

These eight signals form the data byte sent from the host computer to the printer. Data 7 [8] is the most significant bit.

Acknowledge* [nAck] (Pin 10)

This negative-going pulse acknowledges the previous character received by the printer.

Busy [Busy] (Pin 11)

This signal is high when the printer is busy and low when it is able to accept more data.

Paper Empty [PError] (Pin 12)

This signal goes high when the printer has received a print job and run out of paper.

Online [Select] (Pin 13)

This signal is high when the printer is online and low when the printer is offline. It goes low when the **GO** key is pressed to set the printer offline.

+5 V DC (Pin 18)

This line is connected to the printer's +5 V DC line (+5 V \pm 0.5 V, maximum 400 mA [Serial and Parallel total], fused).

Error* [nFault] (Pin 32)

When the high-speed parallel line control is on (FRPO O2=2), this line returns error status.

Power Ready (Pin 35)

This signal is high when the printer is turned on.

NOTE

The Paper Empty, Online, and Error signals are not used unless enabled by the FRPO command (O2 parameter).

2. USB Interface

This printer supports the Hi-Speed USB 2.0. USB (Universal Serial Bus) interface specifications and interface signals are as follows.

2.1 Specifications

Basic specification

Complies with the Hi-Speed USB 2.0.

Connectors

Printer: B-type receptacle (female) with upstream port

Cable: B-type plug (male)

Cable

Use a shielded cable that complies with USB 2.0 and not longer than 5 meters (16 feet).

Transfer Mode

Full speed (max. 480 Mbps)

Power Control

Self-power device

2.2 Interface Signals

USB Connector Pin Assignment

Pin	Signal	Description
1	Vbus	Power supply (+5 V)
2	D-	Data transmission
3	D+	Data transmission
4	GND	Signal ground
Shell		Shield

Table B-2

3. Serial Interface (Option)

3.1 RS-232C Interface

The pins of the printer's RS-232C interface connector carry the signals listed in the table below. The table also indicates whether each signal is incoming or outgoing with respect to the printer.

Pin	In/out	Signal	Description
1	-	FG	Frame ground
2	Out	TXD	Transmit Data
3	In	RXD	Receive Data
4	Out	RTS	Request To Send
5	In	CTS	Clear To Send
6	In	DSR	Data Set Ready
7	-	SG	Signal Ground
20	Out	DTR	Data Terminal Ready

Table B-3

Brief descriptions of the signals follow.

FG - Frame Ground - (Pin 1)

This pin is connected directly to the printer frame.

TXD - Transmit Data - (Pin 2)

This output carries asynchronous data sent by the printer to the computer. It is used mainly in handshaking protocols.

RXD - Receive Data - (Pin 3)

This input carries serial asynchronous data sent by the computer to the printer.

RTS - Request To Send - (Pin 4)

This output is always held high (above 3 volts).

CTS - Clear To Send - (Pin 5)

DSR - Data Set Ready - (Pin 6)

Unused.

SG - Signal Ground - (Pin 7)

All signals can transmit between the printer and the host computer to send each signal with a signal ground.

DTR - Data Terminal Ready - (Pin 20)

This output is used as a buffer nearly-full handshake line. It is held high (above 3 volts) when the buffer can accept more data.

RS-232C Interface Voltage Levels

The voltage levels of the interface signals conform to EIA RS-232C specifications. SPACE is from 3 volts to 15 volts. MARK is from -3 volts to -15 volts. Voltages between -3 volts and 3 volts are undefined.

4. RS-232C Protocol

A protocol is a set of rules the computer follows in sending data to the printer. They are indicated on the status page. Parameters can be changed from the operator panel. See *Changing Serial Interface Modes on page 3-19*. The parameters and their identification codes are given below.

H1: Baud rate

Parameter value	Baud rate
12	1200
24	2400
48	4800
96	9600
19	19200
38	38400
57	57600
11	115200

Table B-4

The factory default setting is 9600 baud.

H2: Data bits

7 or 8; the factory default setting is 8.

H3: Stop bits

1 or 2; the factory default setting is 1.

H4: Parity

Parameter value	Meaning
0	None
1	Odd
2	Even
3	Ignore

Table B-5

The factory default setting is None (0 on the status printout).

H5: Protocol logic

Parameter value	Meaning
0	Combination of 1 and 3 below
1	DTR/DSR, positive logic
2	DTR, negative logic
3	XON/XOFF
4	ETX/ACK
5	XON/XOFF recognized only as protocol

Table B-6

The factory default setting is 0.

H6: Buffer nearly-full threshold

This is a percentage from 0 to 99. The factory default setting is 90.

H7: Buffer nearly-empty threshold

This is a percentage from 0 to 99. The factory setting is 70. The factory default settings of the buffer nearly-full and nearly-empty thresholds (H6 and H7) are subject to change without notification.

The gap between the nearly-full and nearly-empty thresholds allows the computer to send a fairly large amount of data in a continuous stream.

H8: Received-data buffer size

This is the size of the input buffer, specified in units of 10 Kbytes. The factory-set value is 6, meaning 60 Kbytes.

4.1 PRESCRIBE FRPO D0 command

The PRESCRIBE FRPO D0 command provides control over XON/XOFF operation when an error occurs on the serial interface. The following table summarizes the error status corresponding to different D0 values.

Timing of XON transfer to host while Ready or Waiting	Serial interface error	
	Error not resolved	Error resolved
XON sent every 3 to 5 seconds	D0=0 (default)	D0=1
XON not sent	D0=10	D0=11

Table B-7**5. RS-232C Cable Connection****5.1 Obtain a Suitable RS-232C Cable**

Make sure that the RS-232C cable is wired correctly. The cable must be a null modem cable; that is, one in which pin 2 on either end of the cable is connected to pin 3 on the other end. You cannot use a straight cable such as IBM communication adapter cable type 1502067 unless you purchase a null modem adapter.

- 1 Remove the plastic cover from the printer end of the cable.
- 2 Next to each of the wires inside the cable is a bare shield wire. Solder all these shield wires together into a single bundle.
- 3 Using a section of flat wire about 3 mm wide and 15 mm long, connect the bundle of shield wires to the metal facing of the connector. Check that the solder connections are secure.
- 4 Desolder wires 2 and 3, then resolder them in crossed configuration. Solder wire 2 to pin 3 and wire 3 to pin 2. Cover the solder joints with thermofit tube.
- 5 Cut wires 4, 5, 6, and 20.
- 6 Solder wires 5 and 6 together and connect them to pin 20. Cover the solder joints with a thermofit tube. Leave wire 4 unconnected.
- 7 Tape all remaining loose ends, or seal them with a thermofit tube.
- 8 Attach the plastic cover back on.

5.2 Connecting the Printer to the Computer

Check that the power of both the printer and the computer is switched off.

- 1 Discharge yourself of static electricity by touching a metal object such as a doorknob.
- 2 Remove the plastic cap from the printer's RS-232C interface connector.
- 3 Plug the printer end of the RS-232C interface cable into the printer's RS-232C connector and screw it in place.
- 4 Plug the other end of the cable into the computer's RS-232C interface connector.
- 5 Switch on the printer's power.

Appendix B Host Computer Interface

- 6 The printer's RS-232C parameters are factory-set to the following values:

Baud rate=9600 bps, data bits (character length)=8 bits, stop bits=1, parity=none

The two RS-232C protocols are XON/XOFF and DTR. The printer performs both of them simultaneously, using positive logic for DTR.

If you are uncertain as to the printer's current parameter settings, you can reset them to the values listed above.

- 7 Set the computer to the same parameters as the printer. On many computers this can be done by setting DIP switches before the power is turned on. Another method is as follows:

5.3 Setting the RS-232C Parameters

Windows XP, proceed as follows:

- 1 Click on the **Start** button in the Windows XP task bar and align the cursor with **Settings**, then click on **Control Panel** from among the items displayed.
- 2 The **Control Panel** window opens. Double click on **System**.
- 3 **System Properties** window opens. Click on the **Hardware** tab, then click on the **Device Manager** button, and double click on **Ports (COM & LPT)**.

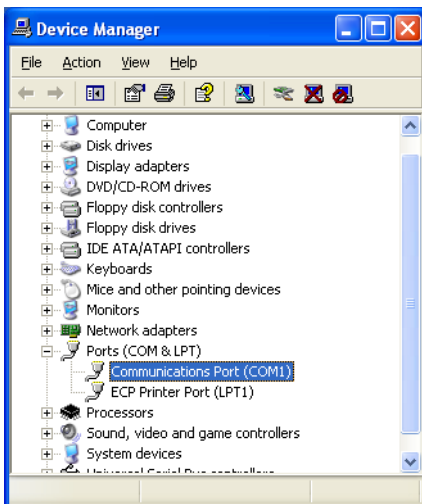

Figure B-1

- 4 Double click on **Communications Port**.

- 5 The **Communications Port Properties** dialog is displayed for the selected COM port. Click on the **Port Settings** tab and set the port properties.

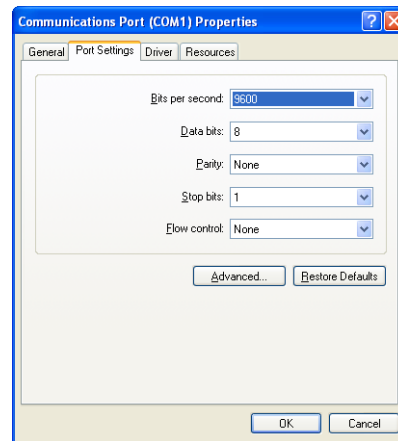

Figure B-2

- 6 After setting the properties, click the **OK** button.

Windows 95/98/ME

- 1 Click on the **Start** button in the Windows 95/98/ME task bar and align the cursor with **Settings**, then click on **Control Panel** from among the items displayed.
- 2 The control panel folder opens. Double click on **System**.
- 3 **System Properties** opens. Click on the **Device Manager** tab, then click on the **COM** port to be used.

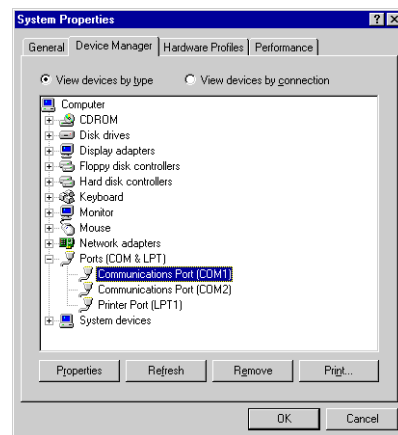

Figure B-3

- 4 Click on the **Properties** button.

- 5 The Properties sheet is displayed for the selected **COM** port. Click on the **Port Settings** tab and set the port properties.

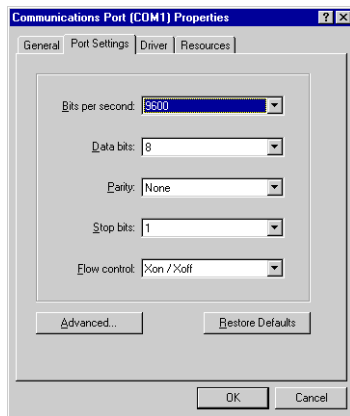

Figure B-4

- 6 After setting the properties, click the **OK** button.

■ DOS

- 1 Enter the following commands:

```
C:\>MODE COM1:96,N,8,1,P  
C:\>MODE LPT1:=COM1
```

- 2 To test the interface, enter the following:

```
CTRL P  
C:\>DIR  
CTRL P
```

The software settings made using the above procedures are temporary. On most computers, permanent settings must be made with DIP switches.

Appendix C Specifications

Specifications

Specifications

Item	Description	
	FS-9120DN	FS-9520DN
Printing method	Electrophotography, laser scan	
Printing speed () : MP tray	A4/Letter: 36 (29) pages/minutes B4 : 20 (18) pages/minutes A3 : 20 (18) pages/minutes	A4/Letter: 51 (31) pages/minutes B4 : 26 (24) pages/minutes A3 : 26 (24) pages/minutes
Resolution	Fast 1200 mode 600 dpi with KIR (Kyocera Image Refinement) 300 dpi with KIR (Kyocera Image Refinement)	
First print (A4 or Letter size, depending on input data)	Approx. 7 seconds or less (During printing) Approx. 32 seconds (During sleep mode)	Approx. 5 seconds or less (During printing) Approx. 30 seconds (During sleep mode)
Warm-up time	Approx. 25 seconds or less (from power on/sleep mode) at 23 °C, 120 or 230 V	Approx. 25 seconds or less (from power on/sleep mode) at 23 °C, 120 or 230 V
Controller	PowerPC 750 CXe (400 MHz)	PowerPC 750 CXe (500 MHz)
Main memory	32 MB, expandable up to 544 MB	64 MB, expandable up to 576 MB
Operating system	Windows 98/ME, Windows NT/2000/XP, Macintosh, Linux	
Interfaces	Parallel 1, IEEE1284 USB 1, USB 2.0 Hi-Speed Network 1, Protocol support:IPX/SPX, TCP/IP, DLC Option 2, Network interface card or serial interface board and hard disk (KUIO-LV)	
Memory card slot	One Memory card (CF)	
Self test	Performed at power-up	
Maximum duty cycle	180,000 pages/month	300,000 pages/month
Drum	Amorphous silicon drum	
Developer	Mono-component dry developer	
Main charger	Positive scorotron charger	
Transferring	Negative charger roller	
Separation	DC brush separation	
Drum cleaning	Blade cleaner	
Drum discharging	Illumination by eraser LED array	
Fuser	Heat roller and pressure roller	
Toner saving	EcoPrint mode	
Paper	Plain paper (See Chapter 2 Handling Paper)	

Table C-1

C-1

Item	Description	
	FS-9120DN	FS-9520DN
Paper feed trays	Cassette : A5 to A3/Ledger size universal cassette. Holds 500 sheets of thickness 0.11 mm MP tray : 88 × 148 mm (3-1/2 × 5-13/16") to 297 × 450 mm (11-11/16 × 17-3/4") (See page 2-2). Holds 200 sheets of thickness 0.11 mm	
Capacity of output tray	Top tray – 500 sheets of thickness 0.11 mm	
Ambient conditions	Temperature : 10 to 32.5 °C (50 to 90.5 °F) Humidity : 20 to 80 % RH Optimum conditions: 23 °C (73.4 °F), 60 % RH Altitude : Max. 2,000 m (6500 feet) Illumination : Max. 1,500 lux	
Power requirements	120 V, 60 Hz, max. 11.3 A (U.S.A./Canada) 220-240 V, 50 Hz/60 Hz, max. 6.0 A (European countries) Max. allowable voltage fluctuation: ±10 % Max. allowable frequency fluctuation: ±2 %	120 V, 60 Hz, max. 11.4 A (U.S.A./Canada) 220-240 V, 50 Hz/60 Hz, max. 6.1 A (European countries) Max. allowable voltage fluctuation: ±10 % Max. allowable frequency fluctuation: ±2 %
Power consumption	Max.: 1,400 W During printing: 850 W (U.S.A./Canada) 920 W (European countries) During standby: 155 W (U.S.A./Canada) 160 W (European countries) During sleep mode: 12 W	Max.: 1,400 W During printing: 870 W (U.S.A./Canada) 940 W (European countries) During standby: 155 W (U.S.A./Canada) 160 W (European countries) During sleep mode: 12 W
Operating noise (in accordance with ISO 7779 [Bystander Position, sound pressure level at the front, and simplex printing])	During printing: LpA=53 dB(A) During standby: LpA=39 dB(A) During sleep mode: Immeasurably low	During printing: LpA=54 dB During standby: LpA=39 dB During sleep mode: Immeasurably low
Dimensions	585 (23) wide × 615 (24-1/2) high × 639 mm (25-1/8") deep	
Weight	67 kg (148 lb), main unit only	

Table C-1 (Continued)

Glossary

Cassette mode

This is an operation mode for the MP tray. When this mode is used, approximately 200 sheets of plain paper can be fed continuously, the same as for the cassette. Cassette mode is specified as the factory setting, but you can change this setting from the printer's operator panel.

dpi (dots per inch)

This indicates the number of dots printed per inch, and is the unit of printer resolution.

EcoPrint

This is a printing mode that controls toner consumption. Pages printed in the EcoPrint mode are lighter than pages printed in the normal mode. The default setting is Off.

Emulation

This refers to emulation of manufacturers' printers. The printer emulates the operation of the following printers: PCL 6, KCGL, Line printer, IBM Proprinter, DIABLO 630, EPSON LQ-850, and KPDL.

Expansion memory

This option is used to increase printer memory. The printer has two expansion sockets, into both of which you can install a 32 MB, 64 MB, 128 MB, and 256 MB DIMM (Dual Inline Memory Module). See your Kyocera Mita dealer to purchase the DIMM that is best suited for use with this printer.

First mode

This is an operation mode for the MP tray. If there is paper inserted in the MP tray, the first paper will always feed from there even if another paper source is selected.

IEEE1284

This is a standard used when connecting a printer to a computer, and was established by the Institute of Electrical and Electronic Engineers in 1994.

KIR (Kyocera Image Refinement)

This is Kyocera Mita's original smoothing function. It uses software to enhance the printer's resolution and produce high-quality printing. The default setting is On.

KM-NET VIEWER

This is a network management tool that can be used with the Kyocera Mita FS series. You can view information for printers connected to the network using SNMP commands. KM-NET VIEWER is contained on the Kyocera Mita Software Library CD-ROM supplied with the printer.

MB (mega byte)

This unit is used to express data quantities and memory capacities. 1 MB is equivalent to 1024 kB, or 1,048,576 bytes.

MP tray

This is an abbreviation for Multi-Purpose tray. The MP tray is used instead of the cassette when printing on envelopes, postcards, transparency sheets, and labels.

Offline

The printer can receive data, but cannot print. Turn the printer online if you want to print.

Online

The printer can output received data.

Operator panel

This is located on the top of the printer. The panel consists of the message display, three indicators and eight keys. The message display shows the printer's status. Press the keys when you want to switch the printer between online and offline status, or to cancel printing.

Outline font

With outline fonts, characters' outlines are represented by numerical expressions, and fonts can be enlarged, reduced, or painted in different ways by changing the numeric values of those expressions. Printing remains clear even if you enlarge fonts, since the letters are defined by an outline. You can specify font size in steps of 0.25 points up to 999.75 points.

Parallel Interface

With this interface, data transfer between the printer and the computer takes place on 8-bit chunks. The printer can perform IEEE1284 compatible bi-directional communications.

Printer driver

The printer driver makes it possible for you to print data created using application software. The printer driver for the printer is on the Kyocera Mita Software Library CD-ROM supplied with the printer. Install the printer driver on the computer connected to the printer.

RAM disk

This is a virtual disk drive that uses part of the printer's memory. With RAM disk you can set any memory size arbitrarily, and use electronic sorting (to reduce print time).

Simple Network Management Protocol (SNMP)

This is a protocol for the management of networks that use TCP/IP (Transmission Control Protocol/Internet Protocol).

Sleep mode

This mode is activated after a specified amount of time elapses. The printer goes into economy mode and a minimum amount of power is consumed. You can change the amount of time before the printer goes into sleep mode from the printer's operator panel. The default setting is 30 minutes.

Status page

This lists printer conditions, such as the printer's memory, the total number of copies printed, and paper source settings.

Index

A

- Access code 3-14
- Adhesive label 2-4
- Alarm (buzzer) setting 3-51
- Amorphous silicon drum C-1
- Auto continue 3-52
- Automatic manual feeding 3-41

B

- Binding 3-44

C

- Cassette paper size 3-42
- Charger unit 1-2, 4-2, 5-3
- Cleaning brush 1-2, 5-4
- Cleaning knob 1-2, 5-3
- Code job 3-15
 - Permanent code jobs 3-18
 - Temporary code jobs 3-17

D

- DIMM A-5
- Document finisher 3-45, A-3
- Drum 4-2, 4-3
 - Refresh drum 4-2, 4-3
- Duplex 2-5, 3-44, 3-47
 - Binding 3-44

E

- EcoPrint 3-31, Glossary-1
- e-MPS 3-12, 3-16
 - Code jobs 3-15
 - Private job 3-14
 - Proof-and-hold 3-14
 - Quick copy 3-13
 - Virtual mailbox 3-16
- Emulation 3-22, Glossary-1
- Envelopes 2-5, 2-8
- Error messages 4-6
- Expansion memory A-1, Glossary-1

F

- Font 3-24, 6-1
- Font list 3-27, 6-1
- Front cover 1-2

G

- Grid cleaner 5-1, 5-3

H

- Handles for transport 1-2
- Hard disk 3-32, A-4

I

- Indicators 3-2, 3-3, 4-4
- Interface 3-2, 3-19, B-1
- Internal fonts 3-25, 6-1

J

- Job retention 3-12
- Job storage 3-13

K

- Keys 3-1, 3-4
- KIR 3-31, Glossary-1
- KM-NET VIEWER Glossary-1
- KPDL 3-23, 6-3, 6-4

L

- Left cover 1 1-2, 4-11
- Lock lever 1-2, 4-11, 5-4

M

- Main charger unit 1-2, 4-2
- Main circuit board A-4, A-5
- Main switch 1-2
- Maintenance 5-1
 - Charger wire 4-2, 4-3
 - Grid cleaner 5-3
 - Separator 5-4
- Maintenance messages 4-4
- Memory card 3-37, A-4
- Memory expansion A-5

Menu map 3-11
 Menu selection system 3-5, 3-11
 Message display 3-1, 3-2
 Message language 3-49
 MP (multi-purpose) tray 1-2, 2-2, 2-5, 2-7, 4-9
 Cassette mode 3-41, Glossary-1
 First mode 3-41, Glossary-1
 Paper guide 2-6
 MP transport 4-8

N

Network 3-12, A-3
 Network interface 1-2, 3-2, 3-21, A-3

O

Online help messages 3-4, 4-5, 4-8
 Operator panel 1-2, 3-1, 3-5, Glossary-1
 Operator panel indicators 4-4
 Option units A-3
 Orientation 3-29, 3-44

P

Paper cassette 1-2, 2-6, 4-9
 Paper feeder 4-8, A-2, A-3
 Paper grain 2-3
 Paper size 2-2, 3-3, 3-42
 Paper size indicator 3-1, 3-3
 Paper size plate 2-7
 Paper specifications 2-1
 Paper stopper 1-2, 2-6
 Paper type 2-5, 3-3, 3-46
 Paper type indicator 3-1, 3-3
 Paper weight 2-2, 3-47
 Parallel interface 3-19, B-1, Glossary-1
 Partition 3-33, 3-34, 3-36, 3-39, 3-41
 PCL fonts 6-1
 Plastic bag 5-1, 5-2
 Preprinted paper 2-4, 2-5
 PRESCRIBE 4-3, B-4
 Print density 3-32, 4-3
 Print quality 3-31, 4-2
 Printer driver 3-12, Glossary-2
 Protocol 3-20, B-3
 Punch unit 4-4

R

RAM disk 3-35, 4-7, Glossary-2
 Recycled paper 2-5
 Reduced print 3-28
 Resolution 3-32, C-1

Resource protection 3-51
 RS-232C 3-2, B-3, B-4
 RS-232C Cable B-4

S

Separator 5-4
 Serial interface 3-2, 3-19, B-2
 Service status page 3-55
 Simple Network Management Protocol (SNMP)
 Glossary-2
 Sleep mode 3-2, 3-50, Glossary-2
 Sleep timer 3-2, 3-49, 3-50
 Special paper 2-4, 2-7
 Specifications 2-1, C-1
 Status page 3-11, 3-21, 3-54, Glossary-2
 Stitch position 3-45

T

TK-70 5-1
 Toner container 1-2, 3-12, 5-1
 Toner kit 5-1
 Top tray 1-2, 3-45
 Transfer roller 4-3
 Troubleshooting 4-1
 Interface 4-1

U

USB Interface B-2

V

Virtual mailbox (VMB) 3-13, 3-16, 3-18

W

Waste toner box 1-2, 5-1
 Wiper cloth 5-1

Free Manuals Download Website

<http://myh66.com>

<http://usermanuals.us>

<http://www.somanuals.com>

<http://www.4manuals.cc>

<http://www.manual-lib.com>

<http://www.404manual.com>

<http://www.luxmanual.com>

<http://aubethermostatmanual.com>

Golf course search by state

<http://golfingnear.com>

Email search by domain

<http://emailbydomain.com>

Auto manuals search

<http://auto.somanuals.com>

TV manuals search

<http://tv.somanuals.com>