

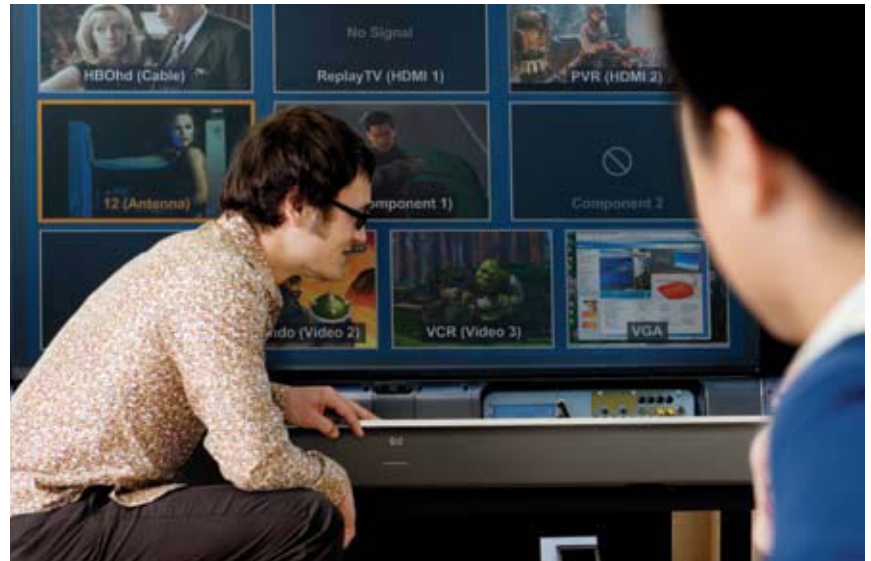

Service Manual

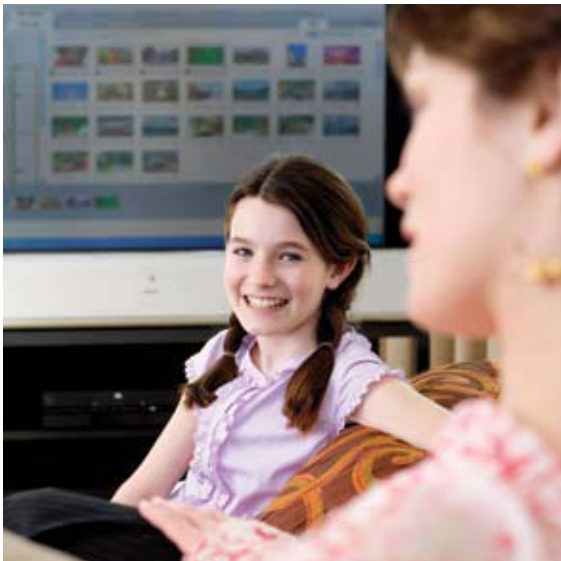

**HP MDTV Rear Projection TVs
Fall 2005**

L1735A, L1736A, L1737A, L1798A



Preface

This manual is prepared for the maintenance service for HP's 50", 58", and 65" Rear Projection Multi-Purpose Display Unit. Maintenance procedures described in this manual are intended to isolate faulty parts and replace them in the field. It also aims to serve as a guide in procuring replacement parts for this product.

This manual is copyrighted and all rights are reserved. This product may not, in whole or in part, be copied, photocopied, translated or reduced to any electronic or machine readable form without prior written consent except for copies retained by the purchaser for backup purpose.

This manual includes basic specifications, major system assembly, components' description, and the "Troubleshooting" making explanations on how to detect errors. It also includes a flow chart for checking or correcting faults.

No warranty or representation, either expressed or implied, is made with respect to this documentation, its quality, performance, merchantability or fitness for particular purpose.

No event that the vendor will be liable for direct, indirect, special, incidental or consequential damages arising out of the user or inability to use this product or documentation.

NOTICE :

The information found in this manual is subject to change without prior notice. Any subsequent changes made in the data herein will be incorporated in further edition.

Table of Contents

On-line links to chapter beginning

Introduction	HP MDTV Product Information	
	Why HP High Definition?	4
	Wobulation	5
	Industrial Design	6
	MDTV Features.....	7
	Model Information	8
	Accessories.....	9
	Model Specifications	10
Chapter 1	Technical Specifications	11
Chapter 2	Disassembly Procedure	
	Tools Needed.....	20
	Disassemble Lamp Module.....	21
	Disassemble Rear cover & Power Supply Module	23
	Disassemble System Fan, Main Board Module & Amplifier Board.....	26
	Disassemble Engine module	30
	Disassemble Speakers & Keypad Board.....	34
Chapter 3	Troubleshooting	
	Main Procedure.....	35
	Power Troubleshooting	36
	Image Performance Troubleshooting.....	38
	Sound Troubleshooting.....	39
	Remote Control Troubleshooting	40
Chapter 4	Alignment & Function Test Procedure	
	Hot Key	41
	Function Test	41
	ADC Calibration	45
	Optical Alignment.....	46
Chapter 5	Upgrade Procedure	
	Equipment Needed	47
	USB Upgrade Function Overview.....	47
	USB Flash Disk Usage	47
	Upgrade LED Indication.....	48
	USB Upgrade Procedure	49
	Error Handling.....	49
Chapter 6	EDID Upgrade Procedure	
	Tools Needed.....	50
	Setup Procedure	50
	Notice	56
Appendix A	Exploded Overviews and Parts Lists	58
Appendix B	System Serial Number Definition	74
Appendix C	Glossary	75



Why HP High Definition?

The digital entertainment revolution is in full swing. Digital cameras, digital camcorders, and CD and DVD players already rule their respective markets, empowering home consumers to easily and affordably create, manage, and enjoy high quality viewing and listening experiences. And the next big wave—already roaring towards shore and about to break—is high definition television. HP is positioned to ride that wave with a complete lineup of high definition TVs that will swamp the competition with everything our customers want: competitive pricing, unequalled ease of use, and mind-boggling image quality.

HP HDTV is the latest and most exciting creation of HP Visual Fidelity technologies. It's grounded in HP's decades-long history of engineering excellence and color science leadership. And it's infused with our unparalleled cutting-edge technological drive and our determination to provide our customers with digital entertainment products that are simple to use yet produce consistently stunning visual experiences.

Pioneering innovation has always been a priority at HP (take for example, the front connect panel on the MDTVs). Nowhere is that innovative edge more apparent, or more crucial to the company's industry-leading position, than in the application of color science to electronic technology. For more than two decades, HP has led the way in color science.

That experience and the depth of knowledge it represents are key to the company's new entry into the home digital entertainment market. HP engineers have taken what they know about ink, and applied it to light—the science underlying ink droplets is surprisingly similar to that of light droplets.

The result immerses the viewer in a dazzling home theater experience: true-to-life color combined with startlingly crisp image quality and ear-tingling sound, all in an attractive, easy-to-use package at a competitive price. That's the HP HDTV experience.



The Wobulator

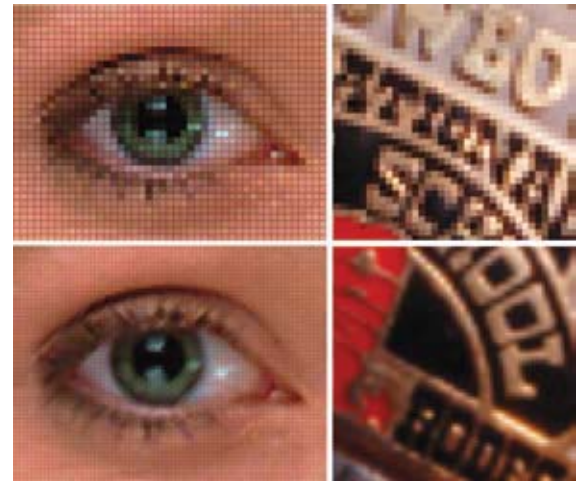

Images without Wobulation (top) are dramatically improved by two-position Wobulation, which doubles the resolution.

The technology story: HP Visual Fidelity and Wobulation

HDTV and HP Visual Fidelity

Thanks to HP's Visual Fidelity technologies—the power behind the picture—our HDTVs deliver unrivaled image quality and color brilliance.

In LCD and plasma models, HP Visual Fidelity technologies provide an advanced video pipeline that combines photorealistic sharpness enhancement, scene-by-scene contrast adaptation keyed to the room's ambient lighting, and a 3D color-enrichment system.

HP Visual Fidelity includes technologies such as Wobulation, which doubles the pixel resolution to provide brilliant, crisp, true-to-life images. (See illustration, above.) The lamp is brighter, offering more accurate, vivid colors and an ultra-wide viewing angle. And DLP™ technology fine-tunes each individual pixel for a cleaner, sharper image.

All HP HDTV models feature high contrast ratios for brighter lights and deeper darks. That means truer blacks—enhancing image sharpness and power, whether the scene is action-packed or brightly lit or darkly shadowed. It means subtler color detail. And it means increased tolerance of ambient light.

The bottom line? A viewing experience like no other, rich with stunning detail and true-to-life colors.

Microdisplay TV and Wobulation

Wobulation is a funny name for a great technology. And it's another great example of HP ingenuity at work—leveraging our industry-leading inkjet technology into new and dazzling consumer products.

Here's how: both printers and digital projectors create a color picture from a matrix of primary color points. Historically, print resolution was increased by placing more and overlapping ink droplets within the same size grid; initially, 300 x 300 dot-per-inch (dpi) resolution became 600 x 300 dpi. That yielded significantly better image quality from the same size dots of ink.

HP engineers simulated applying the same principle to "droplets" of light, with exciting results. Same size spots, yet dramatically improved image quality.

In fact, the resulting light-imaging technology—Wobulation—doubles the addressed resolution of non-Wobulated, digitally projected images, without diminishing their renowned crispness. This technology virtually eliminates the screen-door effect commonly seen in other displays. And it's accomplished without expensive modifications, like changing the light modulator or increasing pixels.

Better resolution, eye-popping picture quality, virtually no increase in cost. So, HP customers who choose our MDTVs get the best possible HDTV viewing experience at a price they can afford.

Industrial design

Form, function, and style

The HP HDTVs are as beautiful as the images they produce. Stylishly thin, the HP Plasma and LCD TVs complement any décor and take up less space than a traditional TV. And they're remarkably easy to use; our intuitive onscreen menus and ergonomic remote controls turn typical setup and operation nightmares into sweet dreams.



The satin-finished metal framing and cabinetry of the HP MDTVs is mirrored in the optional matching stands, as is their unique integrated cable management system. HP MDTVs feature a revolutionary lighted, front-mounted quick-connect panel that allows A/V cables to be easily connected from the front, then hidden from view. Thumbnail source selection (up to ten sources) and preset customizable video and audio modes are key to their unparalleled ease of use. And their built-in 85-watt audio system with integrated subwoofer and SRS TruSurround XT™ delivers thrilling sound.



HP MDTV: a new approach

While all DLP™ TVs share common characteristics, you can really see the differences in HP MDTVs in the areas of picture, sound, connectivity, styling, and ease of use.

The 720p TVs—50-inch and 58-inch models—are entry-level, offering great picture quality and ease of setup. The higher end 1080p TVs, the 58-inch and 65-inch models, feature advanced picture technology, and are two of the few 1080p TVs on the market capable of receiving and displaying native 1080p compressed and uncompressed HD content through HDMI at three frame rates. This gives the consumer the opportunity to select from price and feature options to fit individual budgets and taste. HP is future-proofing the consumer's expensive investment.

HP MDTV features

HP Visual Fidelity

- HP Wobulation uses resolution doubling to produce clean, crisp images and virtually eliminates screen-door effect.
- The DynamicBlack™ aperture enhances resolution for a smoother picture, vivid colors, fine detail, and darker blacks.
- The white point in these TVs is truly white, making it possible to see natural subjects in natural colors.
- The 1080p models (md5880n and md6580n) are capable of receiving and displaying native 1080p compressed and uncompressed HD content (through HDMI at three frame rates).
- HP-enhanced DLP technology and a brighter bulb sharpen contrast ratios while delivering more vivid color and less fall-off.

Image quality

- Picture uniformity across the screen makes for an ultra-wide viewing angle, both horizontal and vertically.
- The screen's flatness and focal length improve image sharpness and virtually eliminate glare and reflection.
- The brighter 150-watt DC UHP lamp produces more vivid color, more contrast, and less fall-off, with no flicker. The picture is rich with detail, even in daylight.
- The color wheel and lamp work together to deliver more natural colors, especially noticeable in realistic skin tones and truer greens.
- Color temperature is lower and warmer overall, for a more true-to-life picture.

Connectivity

- Lighted, front connection panel provides inputs for common sources such as a TV antenna and cable service, a DVD player, an audio/video receiver, a VCR, a personal digital video recorder, an HD camcorder, a video gaming device, a personal computer, and a satellite receiver.
- The 1080p TVs are Digital Cable Ready with an integrated CableCARD slot. The 720p TVs allow for an optional CableCARD tuner module, eliminating the need for a separate cable box.

HP Visual Fidelity: the science of great image quality

HP's rich assets and printing technology intelligence have been employed to transform the art and science of display. When we say "HP Visual Fidelity," we're talking about HP technologies that work together to provide outstanding image quality and color:

- HP Wobulation/resolution enhancement
- Color science
- Image processing and rendering
- Illumination
- Viewing experience



HP MDTV models



Lighted, front connection panel



HP md5880n



HP md6580n

HP Pavilion Microdisplay 1080p TV key features:

- High-definition 1080p resolution with contrast ratios up to 12,000:1 and built-in HD tuner
- HP Visual Fidelity™ technology for fine detail with warm, rich colors and natural skin tones
- Crisp, detailed blacks via the DynamicBlack™ aperture and 7-segment color wheel; ultra-wide viewing angle, brighter 150w lamp
- Front-mounted Quick Connect panel for easy setup and use
- Industry first—thumbnail previews for easy source selection
- 2.1 audio, 85w (peak), integrated subwoofer, and SRS TruSurroundXT™
- CableCARD™ ready; optional matching stand with enhanced cable management



HP md5020n



HP md5820n

HP Pavilion Microdisplay 720p TV key features:

- High-definition 720p resolution; excellent contrast ratios and built-in HD tuner
- HP Visual Fidelity™ technology for fine detail with warm, rich colors and natural skin tones
- Front-mounted Quick Connect panel for easy setup and use
- Industry first—thumbnail previews for easy source selection
- Ultra-wide viewing angle, brighter 150w lamp
- 2.1 audio, 85w (peak), integrated subwoofer, and SRS TruSurroundXT™
- Optional CableCARD™ tuner and matching stand with enhanced cable management



Accessories: remote control and stand



HP MDTV Remote Control

All HP MDTV models include a unique, ergonomically designed remote control that's been HP-engineered for years of smooth and reliable performance. It nestles comfortably into your hand, responds decisively to your touch, and intuitively translates your every command, instantly and flawlessly. The remote allows you to access the TV like a pro videophile or like a regular consumer. You'll probably find yourself wishing you could use it to control the rest of your life, too.

David Katzmaier, in his glowing test report in *Sound & Vision Magazine* (October 2005), said "The TV's Settings menu has more options than a pan-Asian takeout joint."

HP MDTV Stand

The HP TV Stand is the perfect accessory for your new HP MDTV. It's a continuation of the sleek, clean design of your TV, and holds it at the ideal viewing height. It's designed to discreetly yet effectively manage your cables—no more unsightly, tangled snake pit! And, the stand comfortably houses at least four standard home entertainment peripherals (DVD player, receiver, etc.).

HP MDTV specifications*

HP Pavilion md5020n HP Pavilion md5820n HP Pavilion md5880n HP Pavilion md6580n

Physical characteristics

Size	53.0x34.0x17.2in (134.6x86.4x43.8cm)	60.0x38.0x19.2in (152.4x96.5x48.9cm)	60.0x38.0x19.2in (152.4x96.5x48.9cm)	66.5x41.0x20.2in (168.9x104.1x51.4cm)
Weight	102lb (46kg)	117lb (53kg)	117lb (53kg)	133lb (60kg)
Unique dual-component screen, measured diagonally; 16:9 widescreen for all models	50-inch screen (127cm)	58-inch screen (147cm)	58-inch screen (147cm)	65-inch screen (165cm)
Picture				
720p resolution with Wobulation (1280 x 720)	•	•		Ability to receive and reproduce highest quality signals from any source
1080p high-definition resolution with Wobulation (1920 x 1080)			•	Ability to receive and reproduce highest quality native and compressed signals from any source; clean, crisp images and virtually no screen-door effect
DLP™ featuring HP Visual Fidelity technology with steep contrast ratio (up to 2,200:1)	•	•		Increased sharpness, brightness, and contrast, with improved picture reliability and greater detail in darker scenes
DLP™ featuring HP Visual Fidelity technology with steeper contrast ratio (up to 12,000:1)		•	•	Incredible sharpness, brightness, and contrast, with improved picture reliability, stunning rich blacks, and greater detail in darker scenes
Six-segment color wheel	•	•		Superior, lifelike, saturated colors
Seven-segment color wheel with DVE (Digital Video Enhancement)		•	•	Superior, lifelike, saturated colors and dramatic reduction of “dither noise” in darker tones
SmoothPicture™, DynamicBlack™ aperture		•	•	Blacker blacks, richer color tone, increased contrast, and greater detail in darker scenes
Brighter 150w DC UHP lamp	•	•	•	Ultra-wide viewing angles; more contrast, less fall-off; better daytime viewing
Sound				
Built-in 2.1 audio system (85-watt peak) with integrated subwoofer	•	•	•	Stereo sound independent of audio components
SRS TruSurround XT™ including Dialog Clarity Enhancement and TruBass	•	•	•	Thumping home theater sound
Connectivity				
Illuminated front-mounted connectivity panel with integrated cable management slot	•	•	•	Easier set-up and device management; cables tucked away, out of sight
Connection for up to 10 sources, including HDMI, component video, S-video/composite-video, VGA, coaxial cable, and more	•	•	•	Get the most from your viewing experience from a variety of sources
CableCARD™ tuner module slot	optional	optional	integrated	Eliminates the need for a cable box
Video handling				
Video input** 480i/p, 720i/p, 1080i	•	•	•	All the 1080i content you would need
Video input** 1080p at 24, 30, and 60 fps (through HDMI)		•	•	Make the most of 1080i and 1080p content
User Interface				
On-screen thumbnail display for source selection	•	•	•	Easy push-button snapshot view and selection of up to ten sources
Tuners for both digital and analog sources; built-in ATSC tuner	•	•	•	Switch between digital and analog signals with the push of a button
Four customizable video and audio preset modes	•	•	•	Quickly choose from modes tailored to the specific combination of room and source
Intuitive, ergonomic, universal remote control	•	•	•	Comfortable, responsive movement through onscreen menus and controls
Optional extras				
Matching stand with enhanced cable management	•	•	•	

*For more detailed information on the features and benefits described here, please refer to the DVD included with this kit.

**Native or compressed format

Specifications

Technical Specification

The Zappa Family of Digital TVs consists of a portfolio of four TVs. The following table highlights the individual products.

Product Name	Summary of Differentiating Features
MD5020	Screen Size: 50" DMD Resolution: HD4 1280 x 720 Tuner: NTSC, ATSC, Clear QAM
MD5820	Screen Size: 58" DMD Resolution: HD4 1280 x 720 Tuner: NTSC, ATSC, Clear QAM
MD5880	Screen Size: 58" DMD Resolution: xHD4 1920 x 1080 Tuner: NTSC, ATSC, QAM w/ Cable Card
MD6580	Screen Size: 65" DMD Resolution: xHD4 1920 x 1080 Tuner: NTSC, ATSC, QAM w/ Cable Card

1. Lamp

MD5020/ MD5820/ MD5880/ MD6580	
Manufacture	Phoenix
Electrode Gap	1.1mm (Open type) with ellipse reflector E23
Wattage	150Wdc SHP Lamp
Rated Life	6000 hrs. (Typ.)/150W (based on lamp spec.)
Lamp Replacement Barrier	With warning label "DANGER: RISK OF EXPLOSION. REPLACE LAMP IN ACCORDANCE WITH ALL MANUFACTURER'S INSTRUCTIONS"

2. Panel

MD5020/ MD5820	
Manufacture	Texas Instruments
Type	HD4 DMD Chip
Size	0.55 inch
Total Pixels	640(H) x 720(V) Diamond pixels
Active Pixels	1280(H) x 720(V) Pixels
MD5880/ MD6580	
Manufacture	Texas Instruments
Type	xHD4 DMD Chip
Size	0.843 inch
Total Pixels	960(H) x 1080(V) Diamond Pixels
Active Pixels	1920(H) x 1080(V) Pixels

3. Color Wheel

MD5020/ MD5820	
Manufacture	KYO
Type	6 segments including with SLR on (spoke light recapture)
Motor	55mm diameter
Spin Speed	10,800 rpm/NTSC
MD5880/ MD6580	
Manufacture	KYO
Type	7 segments including with SLR on (spoke light recapture)
Motor	65mm diameter
Spin Speed	10,800 rpm/NTSC

4. Screen Image

MD5020	
Image Size	50 inches (1270.0mm)
Aspect Ratio	16:9
Image Horizontal Size	1106.9mm
Image Vertical Size	622.63mm
Projection Distance	608.746mm +/- 4.56mm (based on YOI Engine Spec.)
Distortion (Horizontal), (Vertical)	2.0% (+/- 1.0%)
Over Scan	Diagonal 4% +/- 1%
MD5820	
Image Size	58 inches (1473.2mm)
Aspect Ratio	16:9
Image Horizontal Size	1284.01mm
Image Vertical Size	722.25mm
Projection Distance	714.276mm +/- 5.35mm (based on YOI Engine Spec.)
Distortion (Horizontal), (Vertical)	2.0% (+/- 1.0%)
Over Scan	Diagonal 4% +/- 1%
Distortion (Horizontal), (Vertical)	2.0% (+/- 1.0%)
Over Scan	Diagonal 4% +/- 1%
MD5880	
Image Size	58 inches (1473.2mm)
Aspect Ratio	16:9
Image Horizontal Size	1284.01mm
Image Vertical Size	722.25mm
Projection Distance	698.1mm +/- 5.35mm (based on YOI Engine Spec.)
Distortion (Horizontal), (Vertical)	2.0% (+/- 1.0%)
Over Scan	Diagonal 4% +/- 1%
MD6580	
Image Size	65 inches (1651.0mm)
Aspect Ratio	16:9
Image Horizontal Size	1438.97mm
Image Vertical Size	809.42mm
Projection Distance	788.6mm +/- 5.9mm (based on YOI Engine Spec.)
Distortion (Horizontal), (Vertical)	2.0% (+/- 1.0%)
Over Scan	Diagonal 4% +/- 1%

5. Input Signal Characteristics

Analog RGB Input

Connector(s) Type	D-sub 15 pin
Resolution Compatibility	See Table 1.1

Digital RGB Input

Connector(s) Type	DVI Single Link
Resolution Compatibility	"Same as Analog"

Video Input

Compatibility	NTSC, PAL, S-Video (Y/C), Composite Video
---------------	---

TV Input

Table 1.1

Connector	Signal	HxV/FrameRate	Standards	Details
RF	Analog Terrestrial	720 x 480i/29.97 (4:3) 720 x 480i/29.97 (16:9)	SMPTE 170M, EIA-608, EIA-J CPR-1204, IEC61880, BT. 1119, EIA/IS-702 EIA-744	54MHz-806MHz carrier range, (M)NTSC modulation: 525-lines, 2:1 interlace, 59.94Hz fields/sec, Fsc=3.58MHz, BTSC audio, CC, XDS, CGMS-A, WSS
RF	Analog Cable	720 x 480i/29.97 (4:3) 720 x 480i/ 29.97 (16:9)	ANSI/SCTE 40 2004, SMPTE 170M EIA-608, EIA-J CPR-1204, IEC61880, BT.1119, EIA/IS-702, EIA-744	54MHz-1002MHz carrier range (STD, IRC, HRC) modulation: 525-lines, 2:1 interlace, 59.94Hz field/sec, Fsc=3.58MHz, BTSC audio, CC, XDS, CGMS-A, WSS
RF	Digital Terrestrial	640 x 480i/ 29.97 640 x 480i/30 640 x 480p/23.976 640 x 480p/24 640 x 480p/29.97 640 x 480p/30 640 x 480p/59.94 640 x 480p/60 704 x 480i/29.97 (4:3) 704 x 480i/30 (4:3) 704 x 480p/23.976 (4:3) 704 x 480/24 (4:3) 704 x 480p/29.97 (4:3) 704 x 480p/30 (4:3) 704 x 480p/59.94 (4:3) 704 x 480p/60 (4:3) 704 x 480i/29.97 (16:9) 704 x 480i/30 (16:9) 704 x 480p/23.976 (16:9) 704 x 480p/24 (16:9) 704 x 480p/29.97 (16:9) 704 x 480p/30 (16:9) 704 x 480p/59.94 (16:9) 704 x 480p/60 (16:9) 1280 x 720p/23.976 1280 x 720p/24 1280 x 720p/29.97 1280 x 720p/30 1280 x 720p/59.94 1280 x 720p/60 1920 x 1080i/29.97 1920 x 1080i/30 1920 x 1080p/23.976 1920 x 1080p/24 1920 x 1080p/29.97 1920 x 1080p/30	ATSC A/52, ATSC A/53, ATSC A/54, ATSC A/57, ATSC A/64, ATSC A/65, EIA-708, EIA-766	54MHz-806MHz carrier range 8-VSB modulation, Dolby Digital audio, Table A3 video formats

Connector	Signal	HxV/FrameRate	Standards	Details
RF	Digital Cable	640 x 480i/29.97 640 x 480i/30 640 x 480p/23.976 640 x 480p/24 640 x 480p/29.97 640 x 480p/30 640 x 480p/59.94 640 x 480p/60 704 x 480i/29.97 (4:3) 704 x 480i/30(4:3) 704 x 480p/23.976 (4:3) 704 x 480p/24 (4:3) 704 x 480p/29.97 (4:3) 704 x 480p/30 (4:3) 704 x 480p/59.94 (4:3) 704 x 480p/60 (4:3) 704 x 480i/29.97 (16:9) 704 x 480i/30 (16:9) 704 x 480p/23.976 (16:9) 704 x 480p/24 (16:9) 704 x 480p/29.97 (16:9) 704 x 480p/30 (16:9) 704 x 480p/59.94 (16:9) 704 x 480p/60 (16:9) 1280 x 720p/23.976 1280 x 720p/24 1280 x 720p/29.97 1280 x 720p/30 1280 x 720p/59.94 1280 x 720p/60 1920 x 1080i/29.97 1920 x 1080i/30 1920 x 1080p/23.976 1920 x 1080p/24 1920 x 1080p/29.97 1920 x 1080p/30	ANSI/SCTE 40 2004	54MHz-1002MHz carrier range, 64QAM or 256QAM in-band modulation, QPSK out-of-band modulation, Dolby Digital audio, Table A3 video formats, CableCard: Digital Cable Ready
CBVS	(M)NTSC	640 x 480i/29.97 (4:3) 640 x 480i/30 (4:3) 720 x 480i/29.97 (4:3) 720 x 480i/30 (4:3) 864 x 480i/29.97 (16:9) 864 x 480i/30 (16:9) 940 x 480i/29.97 (16:9) 960 x 480i/30 (16:9)	BT.601, SMPTE 170M, EIA-608, EIA-J CPR-1204, IEC61880, BT.1119, EIA/IS-702, EIA-744, BT.656	

Connector	Signal	HxV/FrameRate	Standards	Details
S-Video	(M)NTSC	40 x 480i/29.97 (4:3) 640 x 480i/30 (4:3) 720 x 480i/29.97 (4:3) 720 x 480i/30 (4:3) 864 x 480i/29.97 (16:9) 864 x 480i/30 (16:9) 940 x 480i/29.97 (16:9) 960 x 480i/30 (16:9)	BT.601, SMPTE 170M, EIA-608, EIA-J CPR-1204, IEC61880, BT.1119, EIA/IS-702, EIA-744	
Component	480i YPbPr	640 x 480i/29.97 (4:3) 640 x 480i/30 (4:3) 720 x 480i/29.97 (4:3) 720 x 480i/30 (4:3) 864 x 480i/29.97 (16:9) 864 x 480i/30 (16:9) 940 x 480i/29.97 (16:9) 960 x 480i/30 (16:9)	BT.601 SMPTE 170M EIA-770.1, EIA-770.2, EIA-608 EIA-J CPR-1204 IEC61880, EIA/IS-702 EIA-744 SMPTE 125M	
Component	480p YPbPr	640 x 480i/59.94 (4:3) 640 x 480i/60 (4:3) 720 x 480i/59.94 (4:3) 720 x 480i/60 (4:3) 864 x 480i/59.94 (16:9) 864 x 480i/60 (16:9) 940 x 480i/59.94 (16:9) 960 x 480i/60 (16:9)	BT.601 SMPTE 170M EIA-770.1, EIA-770.2, SMPTE 293M	
Component	720 YPbPr	1280 x 720p/23.976 1280 x 720p/24 1280 x 720p/59.94 1280 x 720p/60	BT.709, SMPTE 296M, EIA-770.3	
Component	1080i YPbPr	1920 x 1080i/29.97 1920 x 1080i/30	BT.709, SMPTE 274M EIA-770.3	
Component	1080p YPbPr	1920 x 1080p/23.976 1920 x 1080p/24 1920 x 1080p/29.97 1920 x 1080p/30	BT.709, SMPTE 274M EIA-770.3	

Connector	Signal	HxV/FrameRate	Standards	Details
HDMI/DVI		Note: (16:9)formats should have priority over (4:3) formats. This means the (16:9) formats should appear first in the E-EDID structure.	High-Definition Multimedia Interface Specification, CEA-861B, (and compatible with Digital Visual Interface)	CEA EDID Timing Extension Version 3 should be used. This provides support for more than "Basic audio" and support for both (16:9) and (4:3) aspect ratios.
		720 (1440) x 480i/29.97 (4:3) 720 (1440) x 480i/ 30 (4:3) 2880 x 480i/29.97 (4:3) 2880 x 480i/30 (4:3) 640 x 480p/59.94 (4:3) 640 x 480p/60 (4:3) 720 x 480p/59.94 (4:3) 720 x 480p/60 (4:3) 1440 x 480p/59.94 (4:3) 1440 x 480p/60 (4:3) 720 (1440) x 480i/29.97 (16:9) 720 (1440) x 480i/30 (16:9) 2880 x 480i/29.97 (16:9) 2880 x 480i/30 (16:9) 640 x 480p/59.94 (16:9) 640 x 480p/60 (16:9) 720 x 480p/59.94 (16:9) 720 x 480p/60 (16:9) 1440 x 480p/59.94 (16:9) 1440 x 480p/60 (16:9) 1280 x 720p/59.94 1280 x 720p/60 1920 x 1080i/29.97 1920 x 1080i/30 1920 x 1080p/23.976 1920 x 1080p/24 1920 x 1080p/29.97 1920 x 1080p/30	Primary Primary Primary Primary Primary Primary Primary Primary Primary Primary	
VGA			VESA Display Monitor Timing Standard (Unless otherwise specified)	
	VGA	640 x 480p/60 640 x 480p/72 640 x 480p/75 640 x 480p/85		
	480p	720 x 480p/60 (26.719MHz, Horiz Freq 29.820kHz, Neg Hsync, Pos Vsync)	VESA Generalized Timing Formula Standard	
	480p	720 x 480p/60	CEA-861B	
	480p	720 x 480p/60		
	SVGA	800 x 600p/56 800 x 600p/60 800 x 600p/72 800 x 600p/75 800 x 600p/85		
	XGA	1024 x 768p/60 1024 x 768p/70 1024 x 768p/75 1024 x 768p/85		

Connector	Signal	HxV/FrameRate	Standards	Details
	720p	1280 x 720p/60 (74.841MHz, Horiz Feq 44.769kHz, Neg Hsync, Pos Vsync)	VESA Generalized Timing Formula Standard	
	720p	1280 x 720p/60	CEA-861B	
	720p	1280 x 720p/60	TBD	
	1080i	1920 x 1080i/29.97		
	1080i	1920 x 1080i/30		
	1080p	1920 x 1080p/29.97		
	1080p	1920 x 1080p/30		
	1080p	1920 x 1080p/23.976		
	1080p	1920 x 1080p/24		
	WXGA	1280 x 768p/60 (68.250MHz) 1280 x 768p/60 (79.500MHz) 1280 x 768p/75 1280 x 768p/85 1360 x 768p/60		
	SXGA	1280 x 1024p/60 1280 x 1024p/75		

6. Audio System















Power Amplifier (Satellite)	
Power	15W RMS/THD= 10%, R=8 ohm at 1 kHz
Frequency Response	70hz-15khz
Speakers (Satellite)	
Power	15W RMS
Frequency Response	85-15khz
Power Amplifier (Subwoofer)	
Power	25W RMS/THD= 10%, R=4 ohm at 100Hz
Frequency Response	30hz-3khz
Speakers (Satellite)	
Power	25W RMS
Frequency Response	25-3khz

7. Physical

	5020	5820	5880	6580
Physical Dimensions (H*W*D)mm	868 x 1350 x 432	967 x 1530 x 482	967 x 1530 x 482	1055 x 1682 x 530
Weight Kgs	47	52	54	62.5

Disassembly Procedure

Tools Needed

Screwdriver : 107		
Screwdriver : T20		
Screwdriver : 106		
Screwdriver: 5 mm		
Preset type <u>Ratch</u> Torque wrench		
Needle Nose <u>Piler</u>		
Lamp cover		Provided by Coretronic
Adjustable Wrench		
Sponge		

Disassemble Lamp Module

1. Remove Easy Door Module.

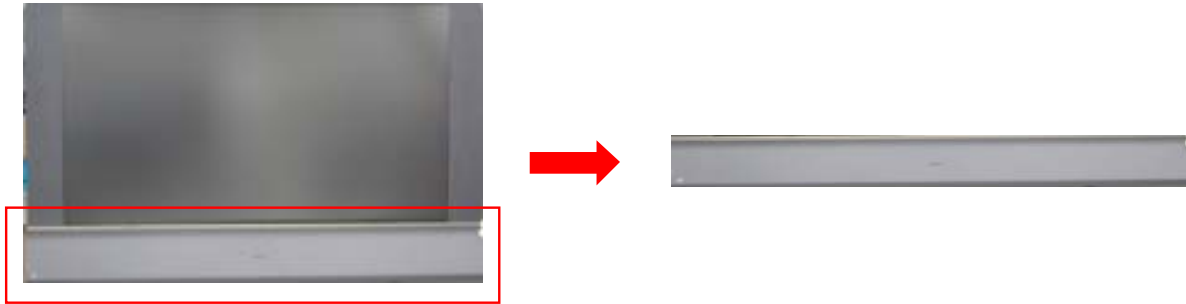

2. Unscrew 2 screws and then remove Lamp Cover (as 2 red circles show).

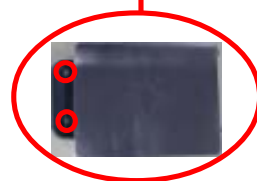

Lamp Cover

- Loosen 3 screws and then remove the Lamp Module.



Lamp Module



Disassemble Rear Cover and Power Supply Module

1. Unscrew 10 screws and then remove the Rear Cover.

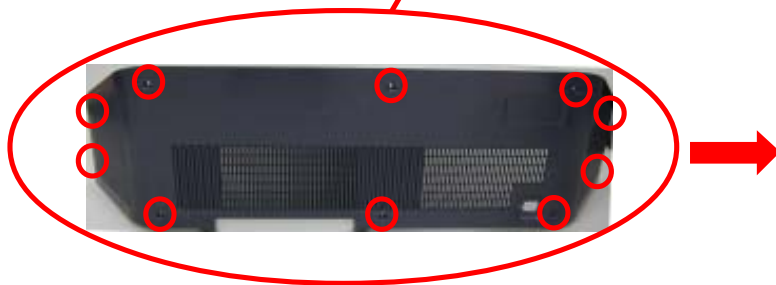

Rear Cover



2. Unscrew 4 screws (step 1), unscrew 1 screw (step 2), unscrew 8 screws (step 3), unplug 9 connectors (step 4) to remove Power Supply Module.

Step 1

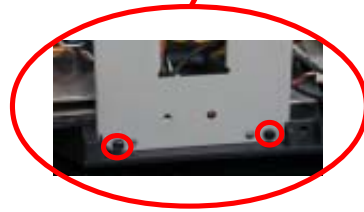
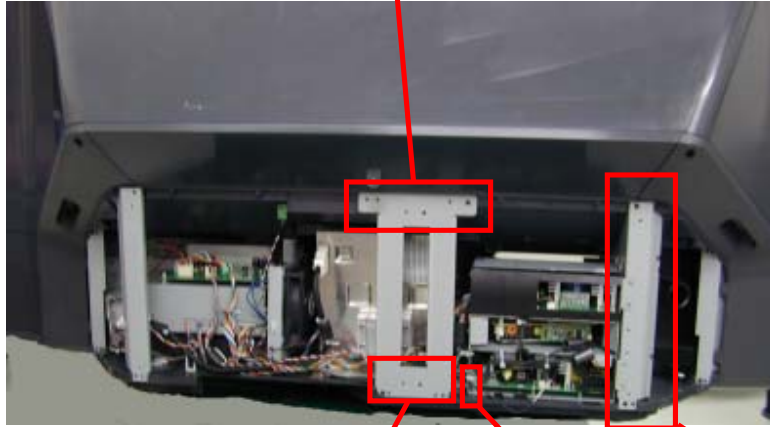

Step 1



Step 2



Step 3



Step 4

3. Unscrew 4 tenons shown in the red circle to remove Ballast from LVPS.

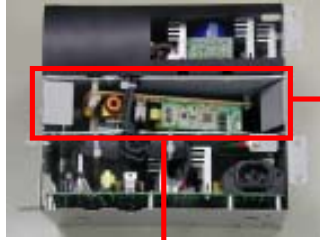

Ballast



LVPS

Disassemble System Fan, Main Board Module and Amplifier Board

1. Unscrew 2 screws to remove System Fan.

XHD4 Model:

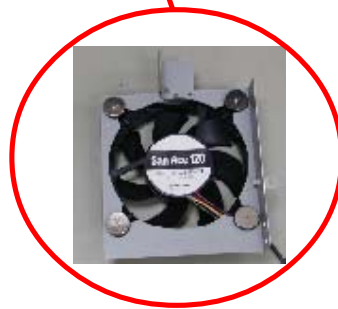
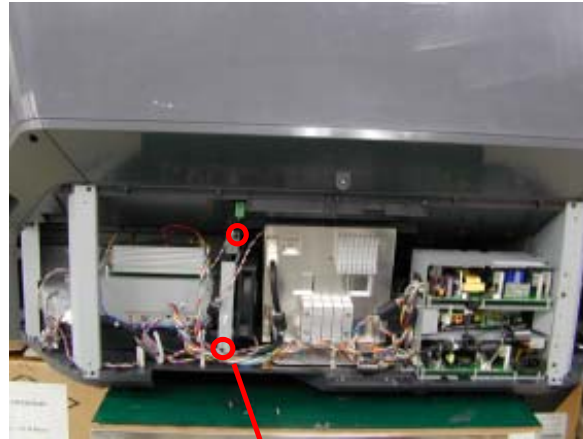

HD4 Model:



2. Unscrew 3 screws (step 1), unscrew 5 screws (step2 & step 3) (shown in the yellow square), unplug 17 connectors (XHD4)/ 16 connectors (HD4) (shown in red circle) to remove Main Board Module.

XHD4 Model:

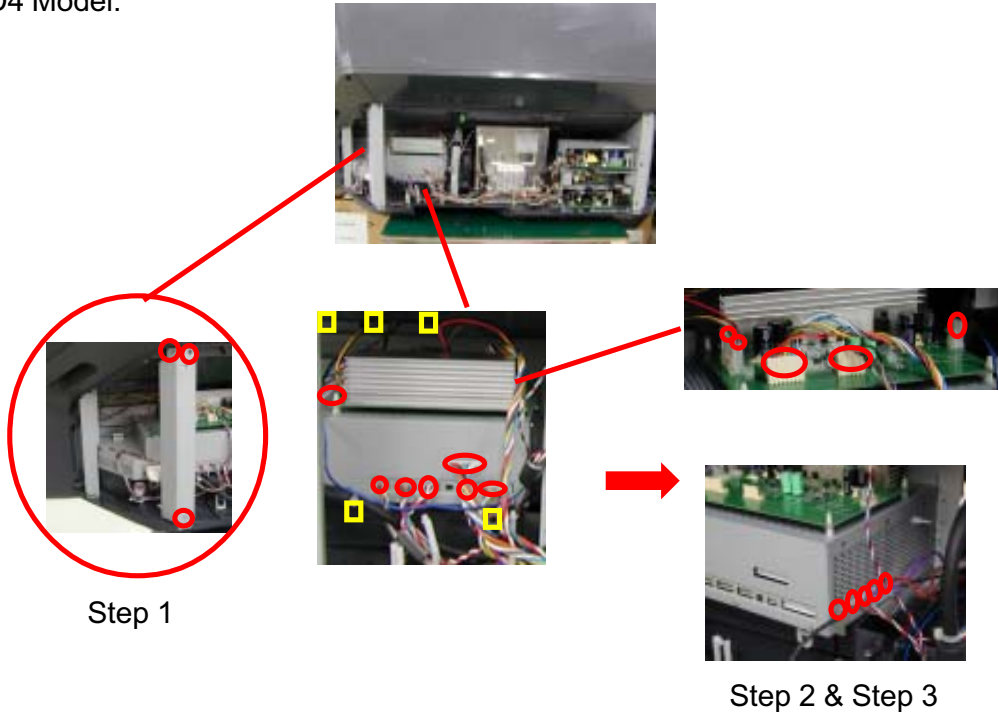

HD4 Model:

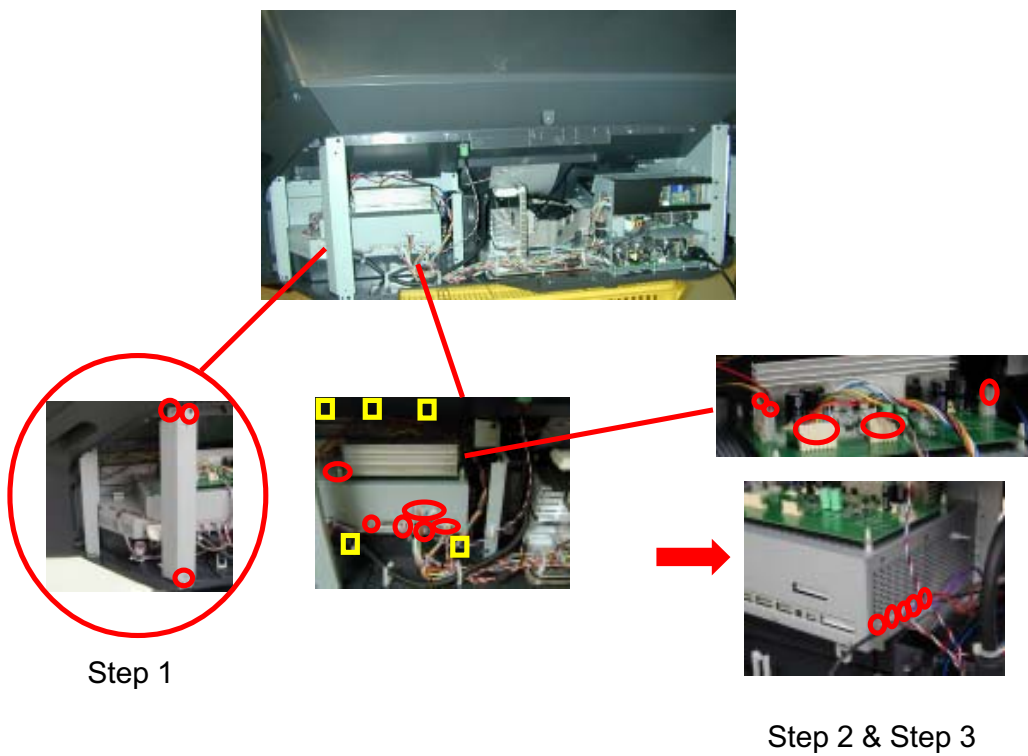

3. Lossen 4 tenons to remove Amplifier Board from Main Board Module.

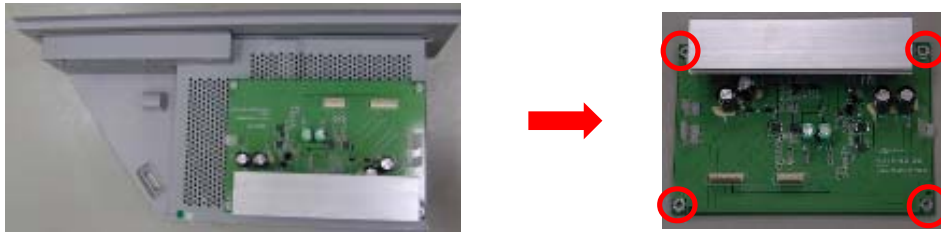

4. Unscrew 14 screws (shown in red circle), 2 hex screws (shown in yellow square) to remove Main Board Cover from Main Board Module.

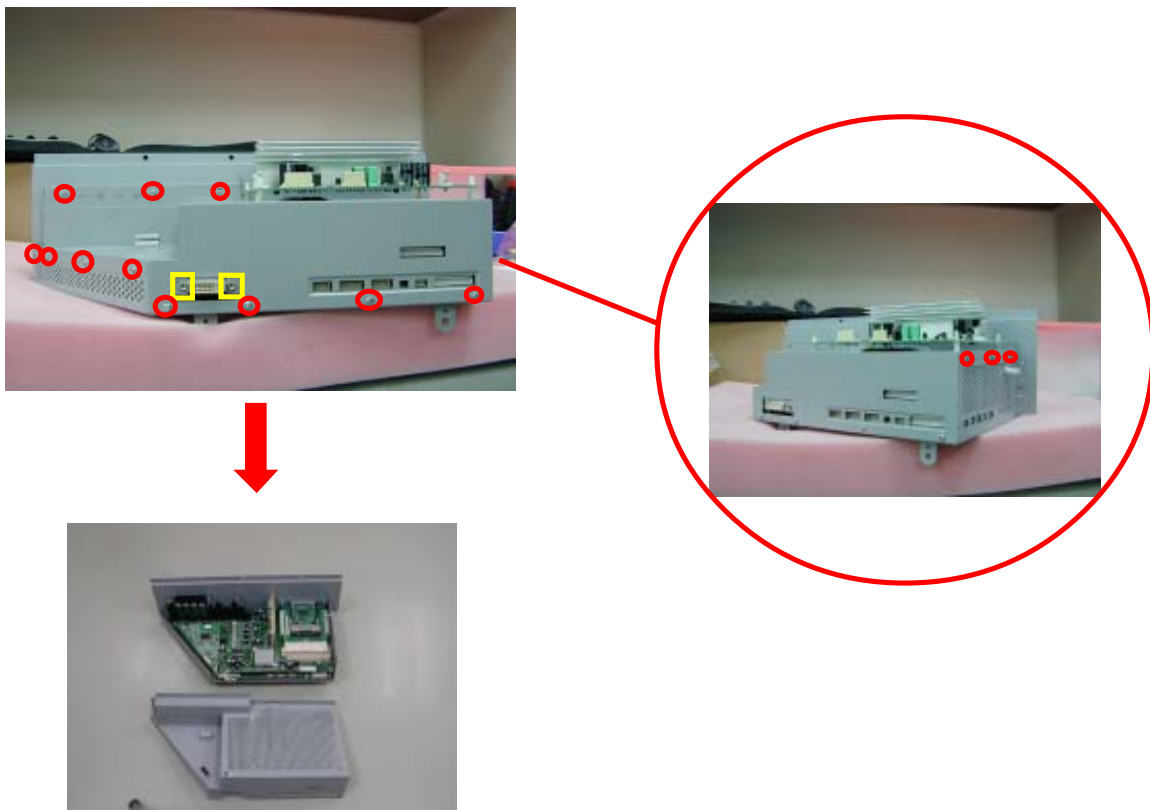

5. Unscrew 2 screws to remove Cable Card Accessory. (for XHD4 model only)

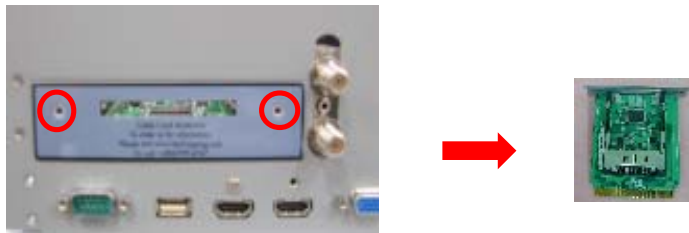

6. Unscrew 2 Nuts (shown in yellow square) and 5 screws (shown in red circle) to remove Tuner Board.

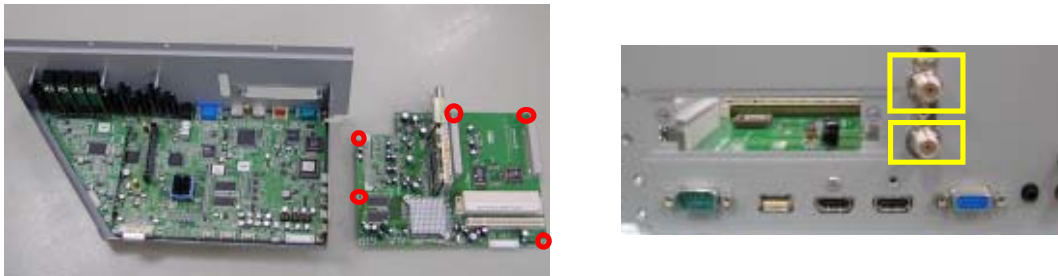

7. Loosen 2 tenons to remove Audio Board.

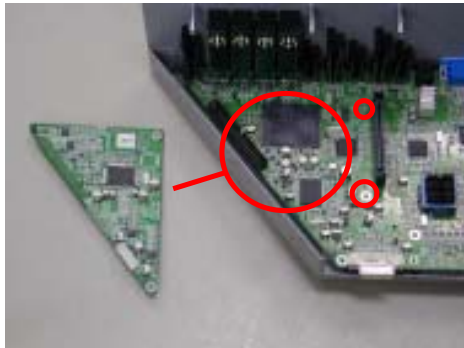

8. Unscrew 4 hex and 2 screws (step 1), 5 screws (as yellow circle) and 5 screws (as red circle) (step 2) to remove Main Board.

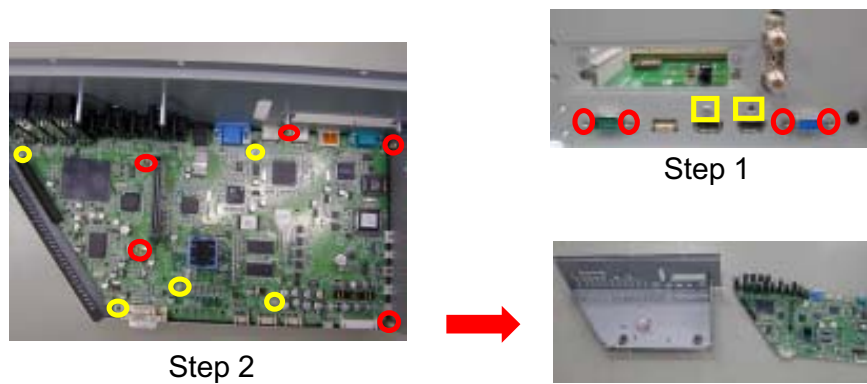

Disassemble Engine Module

1. Disconnect 3 connectors and unscrew 2 screws from the rear side of TV.

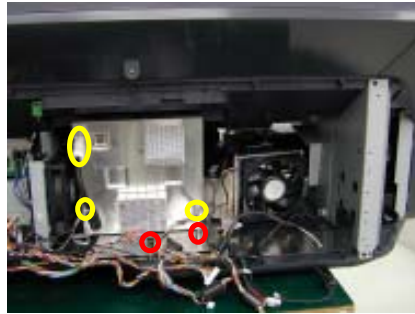

2. Unscrew 4 screws to remove Front Cover. Note: Please use star type screwdriver.

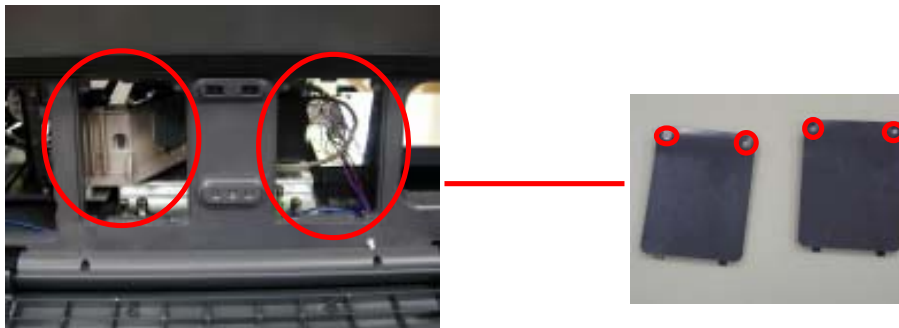

3. Unscrew 4 screws from Engine Module.



4. Unscrew 2 screws to remove the cover the Speaker.

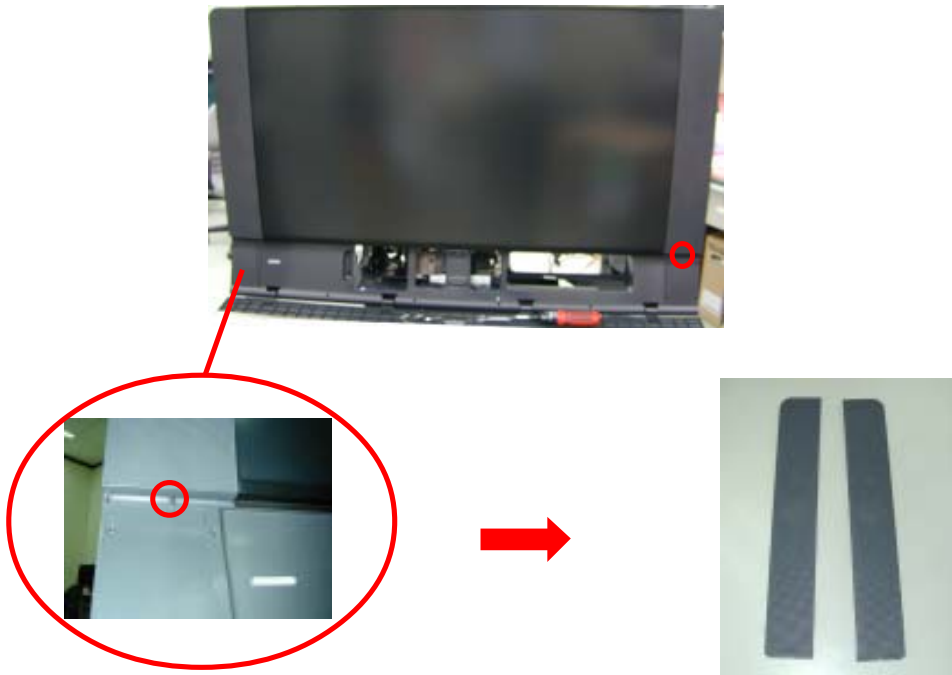

5. Unscrew 2 screws to remove the holding parts.

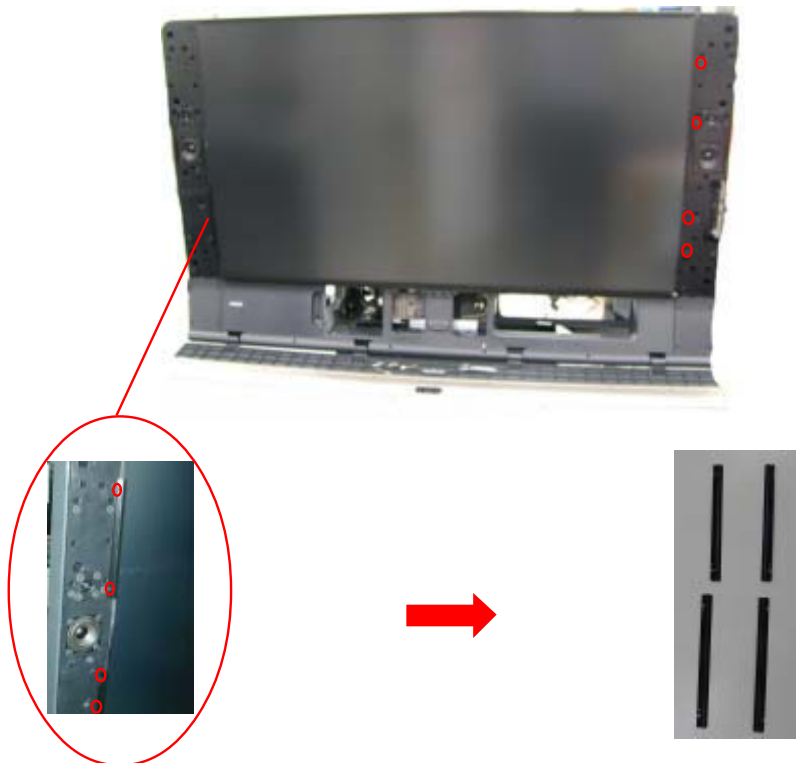

- Remove 4 covers from the top of the TV first and remove 4 screws after, then the screen can be removed.



Inside



Outside

- Note: 1. To prevent the damage, use a sponge to support the screen.
2. Inside of the screen is brighter than outside.

- To gently remove the Engine Module, cover the lens with a Lens cover to preventing damage.



Lens Cover



8. Unscrew 1 screw to remove Thermal Sensor.

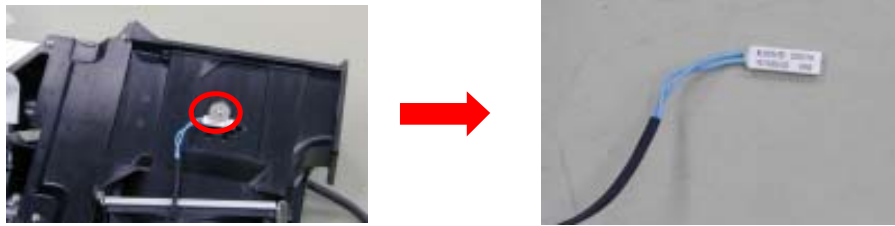

9. Unscrew 3 screws to remove Engine Fan.

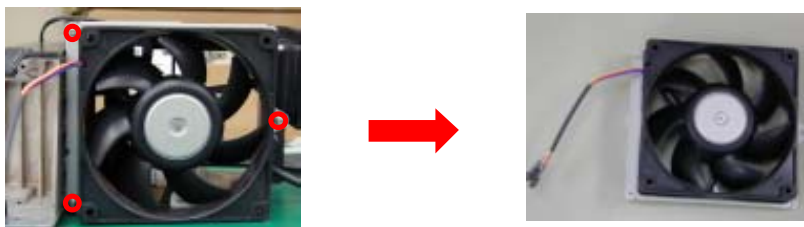

Disassemble Speaker Module and Keypad Board.

1. Unscrew 8 screws and loosen 4 connectors to remove Speaker Module.

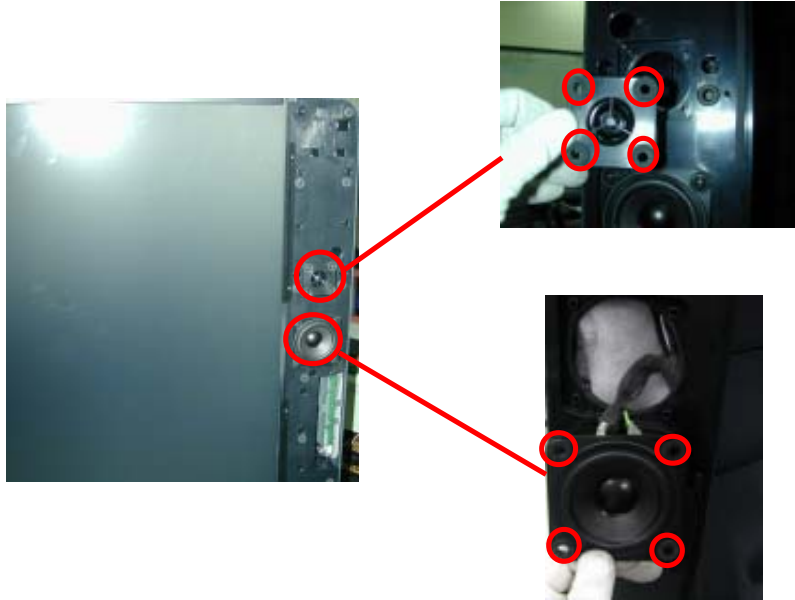

2. To remove Keypad Board, unscrew 4 screws and 1 connector.

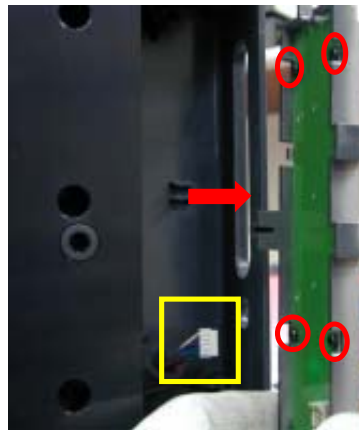

Troubleshooting

Main Procedure

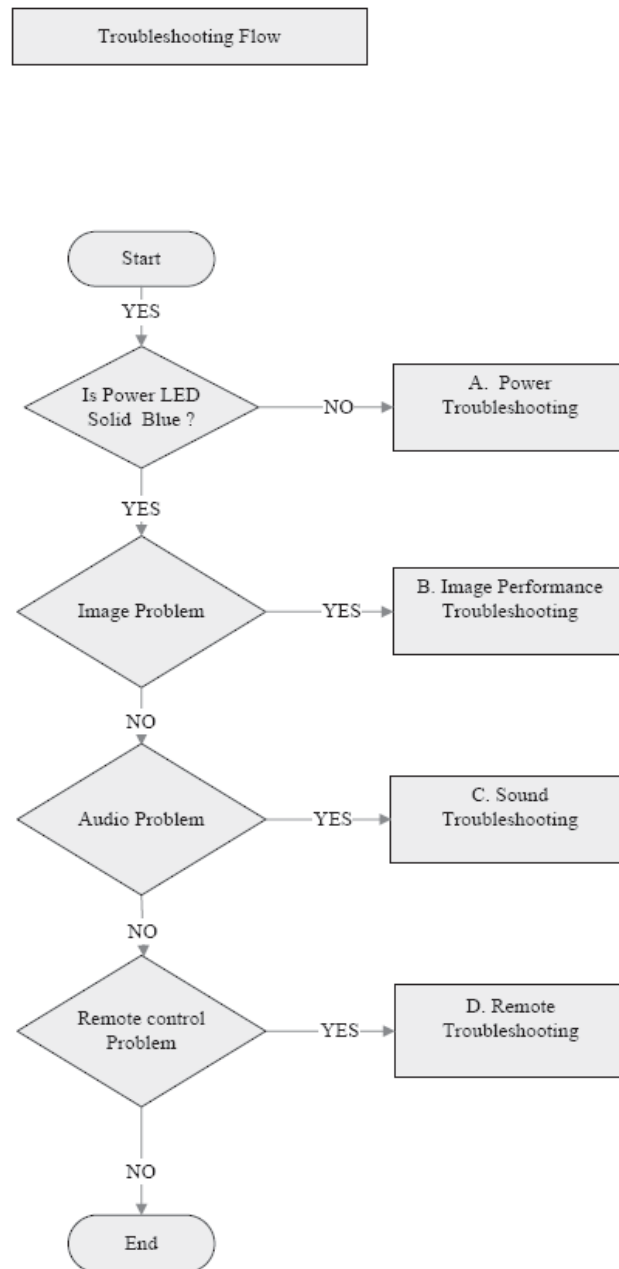

Power Troubleshooting

A. Power Troubleshooting-1

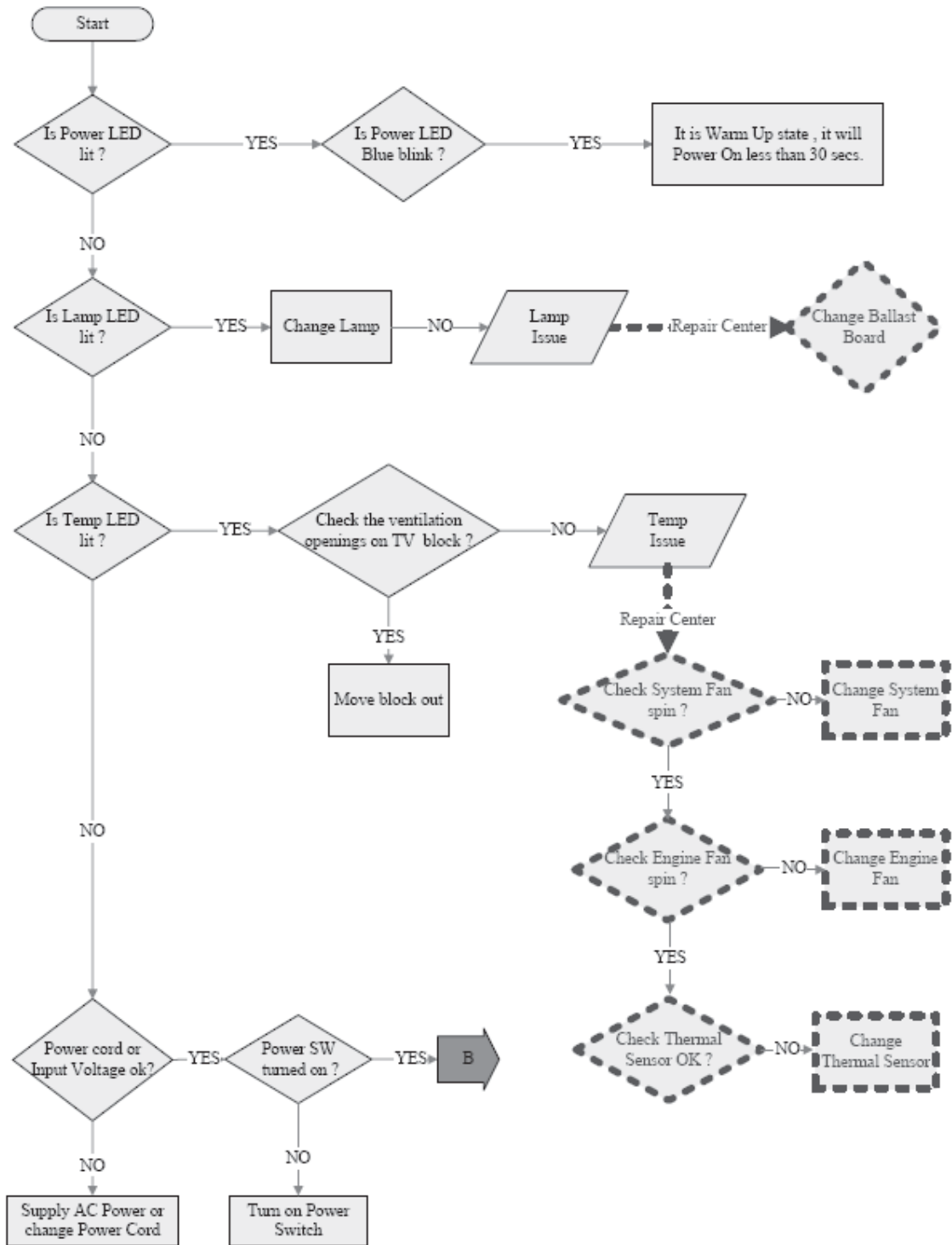

A. Power Troubleshooting-2

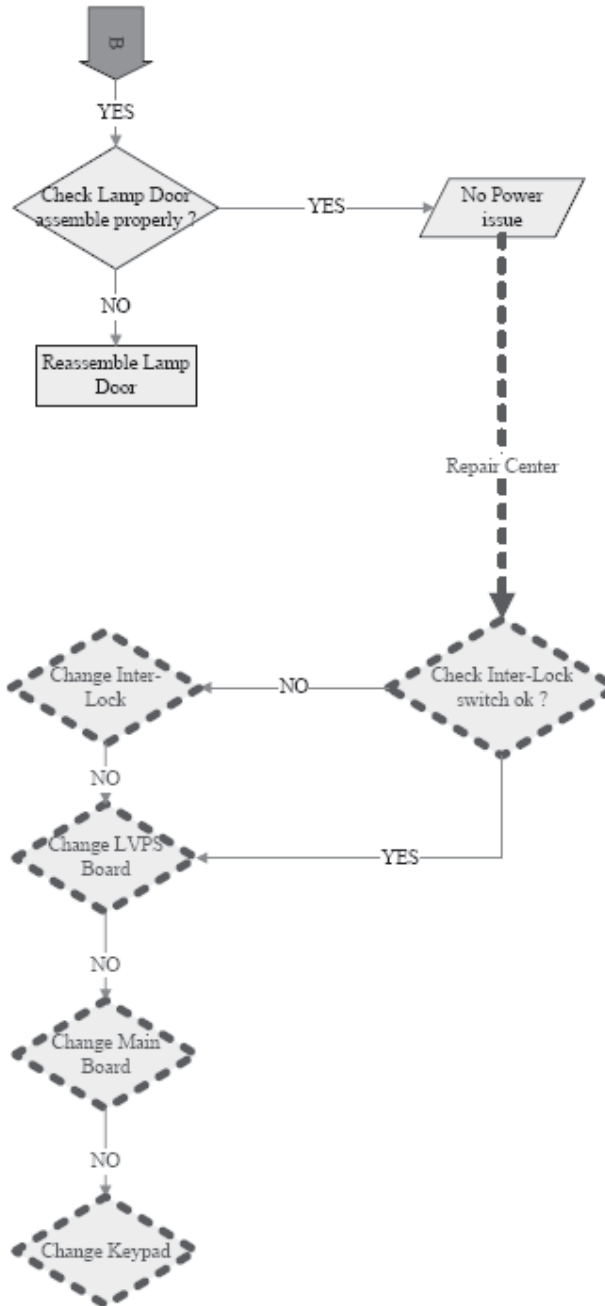
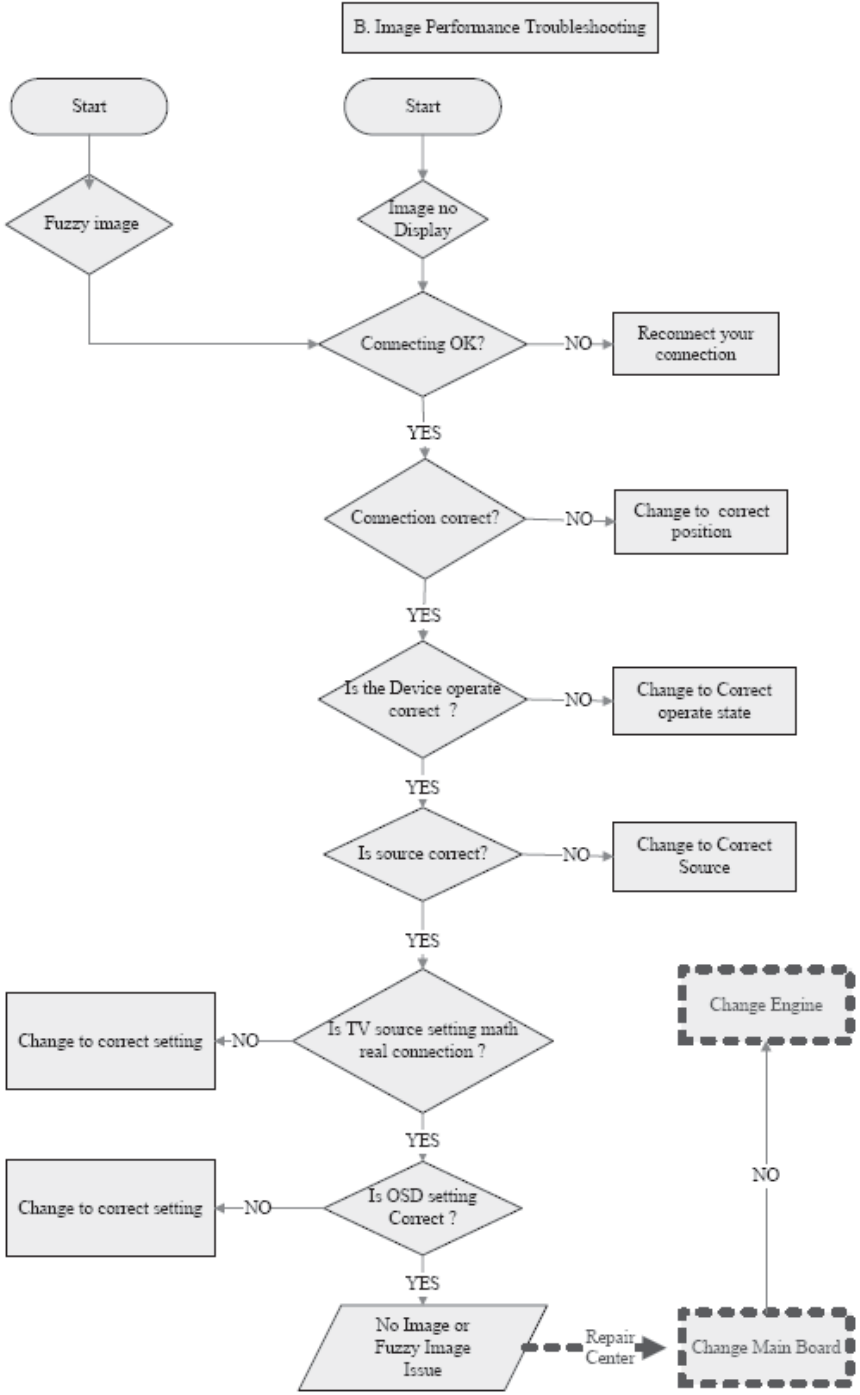
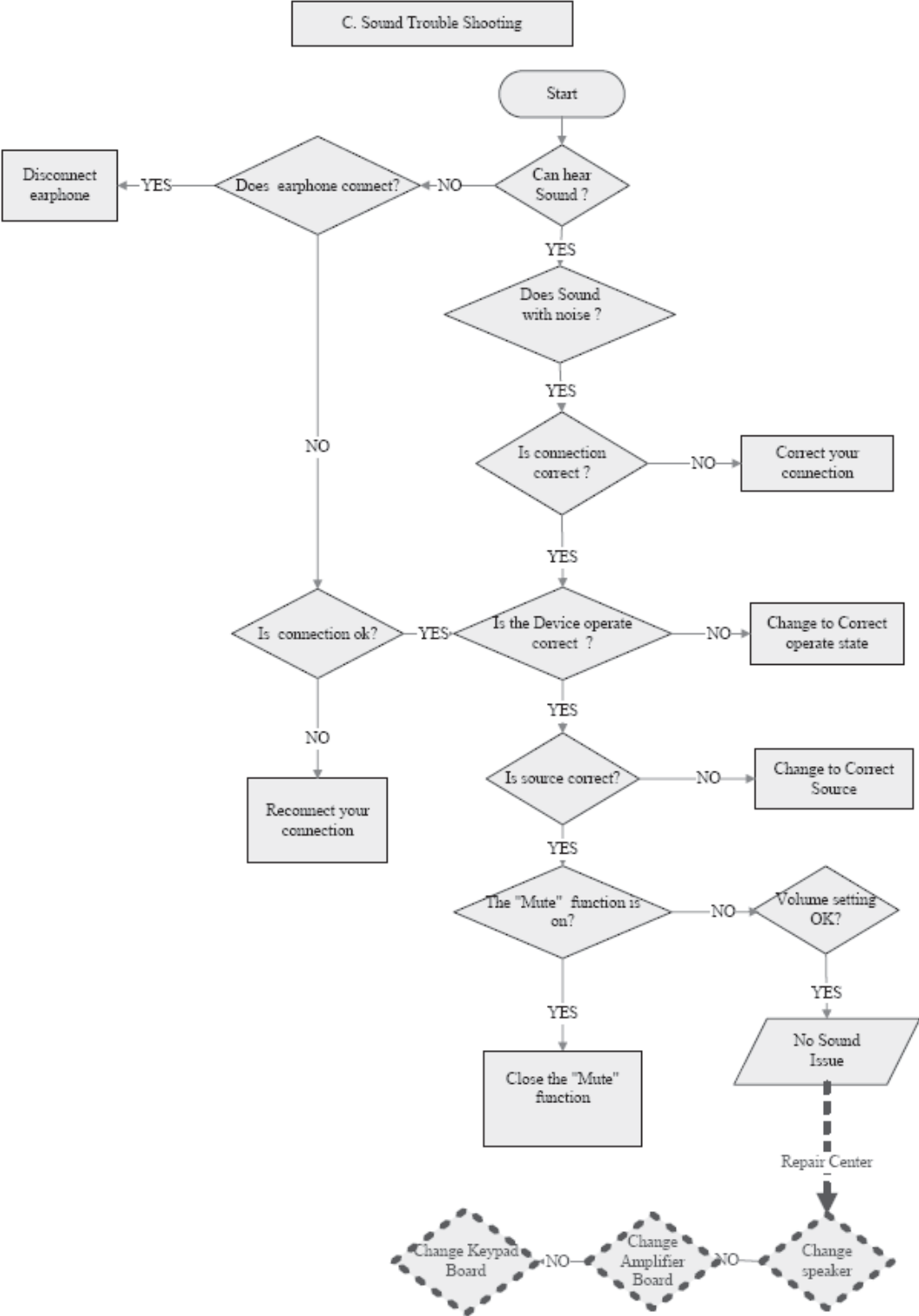

Image Performance Troubleshooting



Sound Troubleshooting



Remote Control Troubleshooting

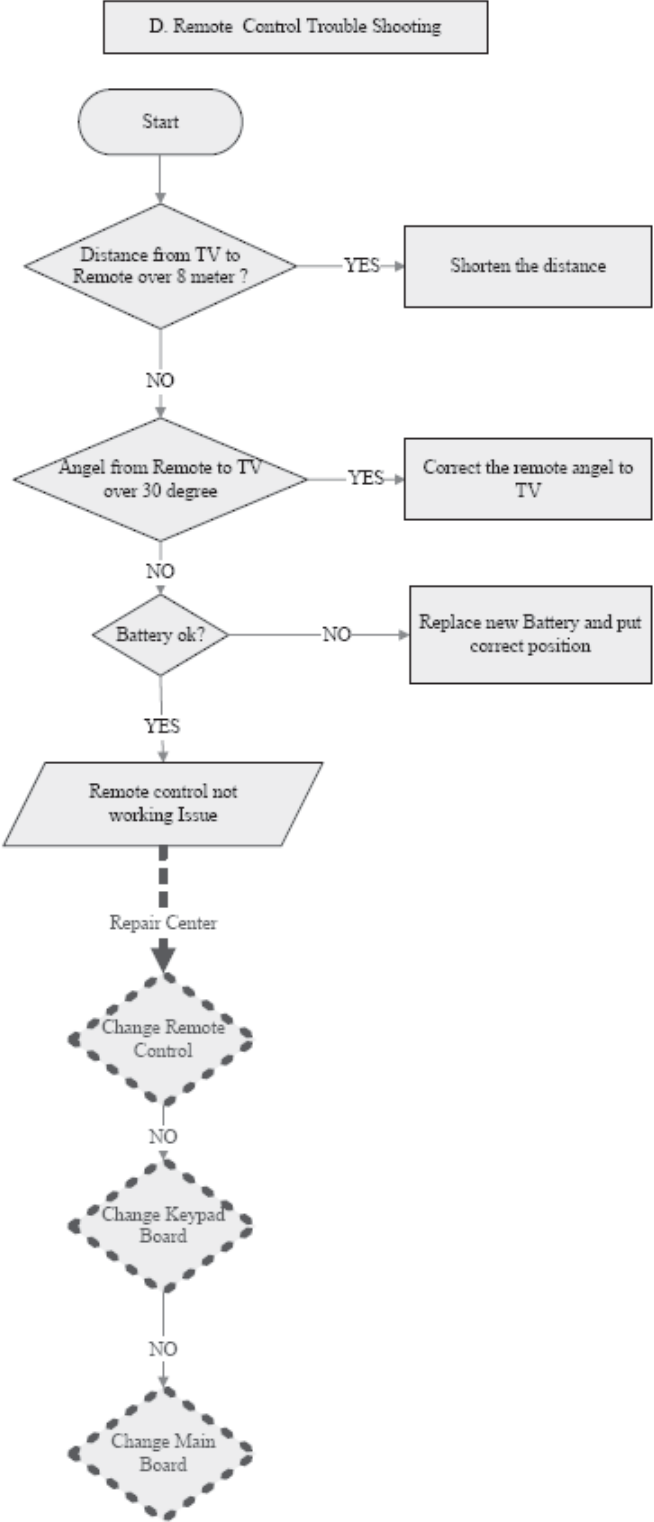

Chapter 4

Alignment & Function Test Procedure

Action Reference

Change parts/update	Optical Alignment	ADC Calibration	Function Test	Channel Scan
Main Board		V(*)	V(**)	V
Firmware		V(*)	V(**)	
EDID		V(*)	V(**)	
Engine	V(*)	V(**)	V(***)	
LVPS or Ballast Board			V	
Amp. Board			V	
Tuner Board			V	
Keypad Board			V	

* : 1st step

** : 2nd step

*** : 3rd step

Hot Key

- Factory Menu: Press “Source”, “-”, “CC”, “SAP” to enter Factory Menu.











Function Test



A. Video/Audio

Test Instrument Facility:

1. Remote controller * 1
2. DVD player * 1 (must have the HDMI and DVI port)
3. Cable * 1 (component, composite, s-video, HDMI, DVI to HDMI, SPDIF)
4. VGA cable * 1 (D-sub 15 pin, audio)
5. Pattern generator * 1 (it can generate the 16 gray scale picture)
6. TV signal generator * 1 (optional, if antenna signal is ready)

Test item	Working items	Picture	Check item/spec
Original customer's source test	Press SOURCE button on the remote controller and choose the customer's original settings.		Test the defect of customers complaint and confirm that the main defect has been solved.
Video test - Composite	(1) Press SOURCE button on the remote control and choose source to Video 1. (2) Connect to DVD composite signal		Check any abnormal color, line distortion or any noise in the screen. And check the Sound from speaker
Video test - Component	(1) Press SOURCE button on the remote control and choose source to Component 1. (2) Connect to DVD component signal		Check any abnormal color, line distortion or any noise in the screen. And check the Sound from speaker
Video test - HDMI	(1) Press SOURCE button on the remote control and choose source to HDMI 1. (2) Connect to DVD HDMI signal		Check any abnormal color, line distortion or any noise in the screen. And check the Sound from speaker

Video test - DVI	(1) Press SOURCE button on the remote control and choose source to HDMI 2 (2) Connect to DVD DVI signal (including audio signal)		Check any abnormal color, line distortion or any noise in the screen. And check the Sound from speaker
Tuner test - Antenna	(1) Press SOURCE button on the remote controller and choose source to Antenna. (2) Connect to Antenna or TV signal generator RF output .	 	After auto-scanning, press "ch+" "ch-" buttons to test channels. Check if lines, abnormal color and zigzag on image.
Tuner test - Cable	(1) Press SOURCE button on the remote Controller and choose source to Cable. (2) Connect to Cable signal.		After auto-scanning, press "ch+" "ch-" buttons to test channels. Check if lines, abnormal color and zigzag on image.
Keypad test	(1) Press SOURCE button on the remote control and choose source to component 2 (2) Connect to DVD component signal		Check if the keypad function work well.
Remote Control test	(1) Press SOURCE button on the remote controller and choose source to video 2. (2) Connect to DVD composite signal		Check if the Remote Control function work well.

Keypad test	<p>(1) Press SOURCE button on the remote control and choose source to Component 2 .</p> <p>(2) Connect to DVD component signal</p>		Check if the keypad function work well.
Remote Control test	<p>(1) Press SOURCE button on the remote control and choose source to video 2.</p> <p>(2) Connect to DVD composite signal</p>		Check if the Remote Control function work well.

4-4 Optical Alignment

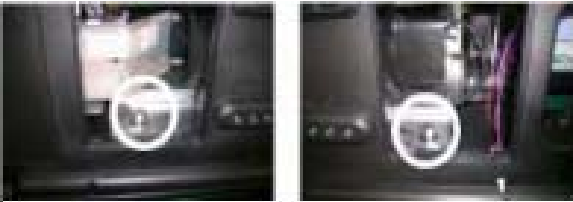
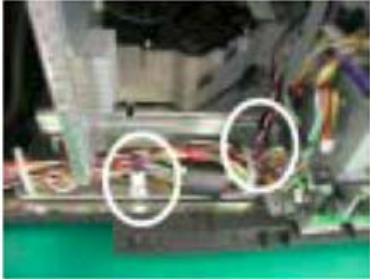
Test Item	Working Items	Check item/Spec/Figure
1	Plug the power cord into socket behind TV	Voltage 110V power cord should be connected firmly
2	Switch on power and press keypad power button to ignite Lamp	Check if Lamp is on
3	Enter the factory mode	
4	<p>Press ok to enter Optical Alignment color bar for image slope/shape/trapezoid to go to the permit area</p> <p>Default value: md5020/5820: left, right: 25 up, bottom: 16</p> <p>md5880/ 6580: left, right: 37 up, bottom: 20</p>	
5	Move and rotate engine module, adjust center line to frame	
6	<p>If the image is too high, adjust front I type screw clockwise rotation, then the screen will be moved to the lower side.</p> <p>If the picture is too low, adjust I type screw to counter clockwise the unit in order to move the picture higher.</p>	
7	Use ratch wrench locking front two fixed studs.	
8	Revolve TV, use ratch wrench locking back twofixed studs. Attention: When locking, can't damage the wire.	
9	Revolve TV again, use gule machine to drop glue range area to two I type screw	drop glue range area: screw circle 1/3 linear.

Firmware Upgrade Procedure

Equipment Needed

Software :

- Zappa Projection Firmware

Hardware :

- Zappa Projection TV
- USB Flash Disk

USB Upgrade Function Overview

Zappa builds in USB OTG chip for F/W upgrade purpose; user just put F/W hex code into USB Flash Disk, and then plug it to USB receptacle of TV, system will upgrade the F/W to appropriate unit. There are 7 units can be upgrade, MTV512, VGA EDID, HDMI 1 EDID, HDMI 2 EDID, Pixel works Flash, DTV module Flash and CSC1220.

USB Flash Disk Usage

Zappa USB OTG only recongnizes USB flash disk device, other devices will be ignored.

- File system: USB driver support FAT 12, FAT 16 and FAT 32 file systems. Also support OTG HOST mode only.
- File location: User can put F/W hex code in any directory or root directory.
- Sub File Name: Current driver only can recognize *.hex sub file name. So you may need to rename the sub file name to be "HEX", such as DTV module, that F/W file name is "vxWorks_user.bin", you need to rename it to be "vxWorks_user.hex".
- File Name: Driver recognizes prefix file name then decide which unit should be upgraded, you can put any characters after prefix, such as date or version. For example, Mtv512_v02.hex, "Mtv512" is prefix and driver will recognize it and upgrade it to MTV512. The prefix file name of each unit list as below.

Upgrade Unit	Prefix File Name	Upgrade Sequence
MTV512	MTV512	1
CSC1220	CSC1220	2
VGA EDID	VGAEDID5020/ VGAEDID5820/ VGAEDID5880/ VGAEDID6580/	3
HDMI EDID	HDMIEDID5020/ HDMIEDID5820/ HDMIEDID5880/ HDMIEDID6580/	4
Pixel Works	APPCODE720P/ APPCODE1080P FLASHER.HEX	5
DTV Boot Code	BOOTROM	6
DTV Module	VXWORKS_USER	7

You can put all of above files into disk or individual file that depend on what unit you want to upgrade. And driver will follow the upgrade sequence to upgrade each unit.

About VGA EDID and HDMI EDID, you can put all of model's EDID code in one USB Flash Drive, USB will according to product ID in EDID EEP ROM to choice correct EDID code.

Note: if the EDID EEP ROM is empty or the product ID is wrong, USB will pick one of EDID code on the flash drive to upgrade. So, if you already know the EDID is empty, just put one EDID code that you want to upgrade in USB Flash Drive.

Upgrade LED Indication

Due to LED are controlled by MTV512, so when MTV512 is upgrading, the LED will be lost control, but when MTV512 upgrade complete, it will be reset and back to Standby mode, all LED are OFF, except this unit, the LED indications as below description.

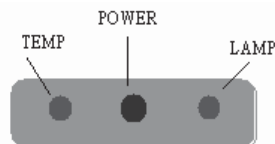

Status	LED Behavior
Upgrade Proceeding	LED rotates from left to right
Unit Upgrade Complete	POWER LED still on
Entire Upgrade Process Complete	POWER LED flash
Upgrade Error	TEMP and LAMP are flashed both

USB Upgrade Procedure

1. Put F/W hex code to USB Flash Disk.
2. TV power state at Standby mode.
3. Plug USB Flash Disk to USB receptacle of TV.
4. LED rotates. (Except MTV512 Unit)
5. Waiting for POWER LED flash or all LED off (MTV512)
6. Power on TV.
7. TV shows Upgrade Complete List report.

Note 1: Pixel works upgrade function will decide what version will be upgraded (720p or 1080p). It depends on VGA EDID product ID, so before upgrade pixel works hex code, please make sure your EDID code is right.

Note 2: If you attempted to upgrade MTV512 and CSC1220, the LED behavior may become strange.

Note 3: If you want to upgrade VGA EDID or HDMI EDID, please remove VGA cable or HDMI cable, because the EDID 12C is wired with USB chip and VGA/HDMI 12C bus.

Error Handling

What situation Error message occurs.

1. Upgrade Pixel Works without flasher.hex.
2. Unplug USB Disk during upgrading.
3. HEX file format not correct.
4. Upgraded unit no response.

EDID Upgrade Procedure

1. Tool Needed:

Hardware :

- IBM compatible PC that minimum CPU requirement is Pentium III 800
- D8330 Card (PCI Interface, see notice 3-1)
- D8330 Interface Cable (see notice 3-1)
- DVI to HDMI cable, like this



Software Tool:

- OS need Microsoft Windows 98/NT/2000/XP
- D8330 Display Data Channel Testing System (see notice 3-1)

2. Setup Procedure:

2-1. You should install the D8330 Display Data Channel Testing System first. (about install “DDC” software please reference D8330 Display Data Channel Testing System user’s manual)

2-2. Add DDC Data in your PC

Coretronic will provide the Archer DDC data for update purpose.

M5020 Model:

ZP5020_VGA.DDC for EDID-analog

ZP5020_HDMI.DDC for EDID-digital

M5820 Model:

ZP5820_VGA.DDC for EDID-analog

ZP5820_HDMI.DDC for EDID-digital

M5880 Model:

ZP5880_VGA.DDC for EDID-analog

ZP5880_HDMI.DDC for EDID-digital

M6580 Model:

ZP6580_VGA.DDC for EDID-analog

ZP6580_HDMI.DDC for EDID-digital

2 files, These files you should put them in C:\Program Files\DynaColor\DDC\data directory

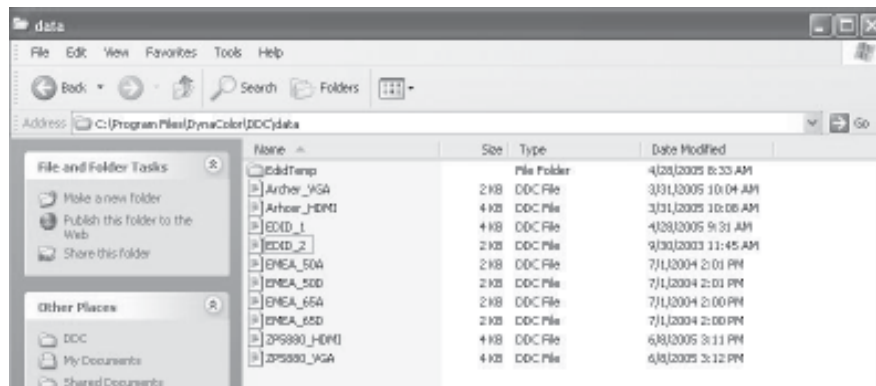

2-3. Turn off protection for DDC upgrade. Press “Ch +” first, then press “Power” after. Hold the both buttons simultaneously, let go, then press “Power”.

2-4. DDC- Analog data update. Here is analog cable installation method:

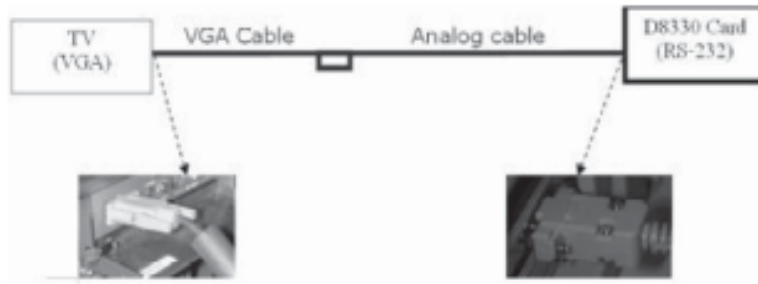

You can see this picture:

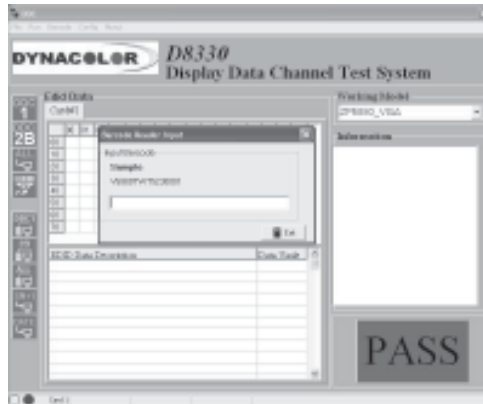

Then key in Serial Number. (see notice 3-3)

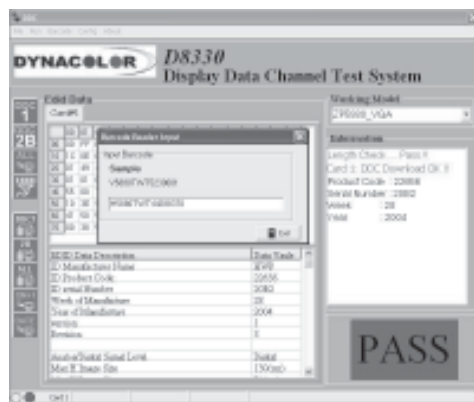

After press "Enter" key in your keyboard to execute. It will show "PASS" Information like this picture.

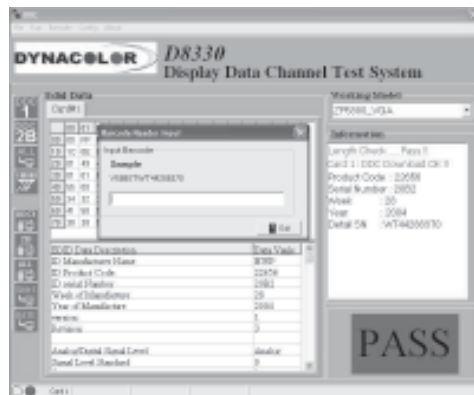

From now, you have finished the DDC-analog data update. If you want to continue update DDC digital data, please don't power off your TV. Then go to 2-5 procedure.

2-5. DDC-digital data update

Here is communication cable installation method: (There are two DDC ports, finish one at the time)

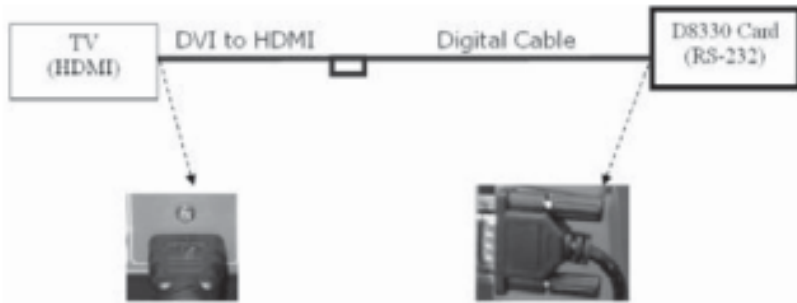

Please check your TV in the power on mode (it means the power light indicator in the front keypad is green)

Double-click "DDC" icon to execute D8330 Display Data Channel Testing System. (about install "DDC" software please reference D8330 Display Data Channel Testing System user's manual)



Then, you can see this picture:

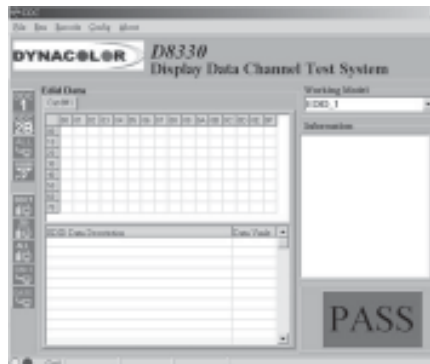

Select "Working Model" to ZP5880_HDMI. If can't find the ZP5880_HDMI, (please see notice 3-2)

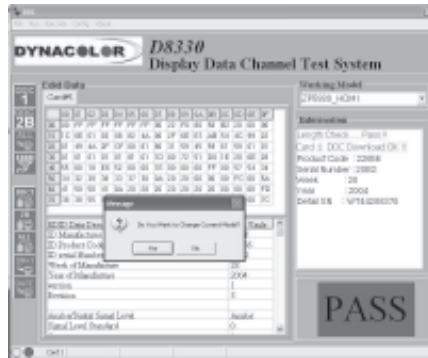

Execute "  " function button in the left area.

You can see this picture:

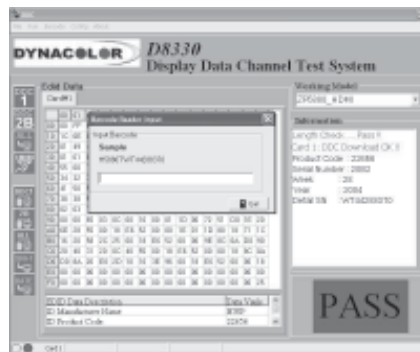

Then key in Serial Number. (see notice 3-3)

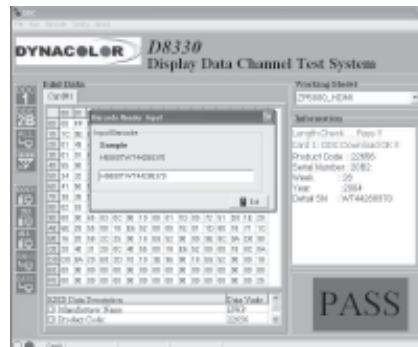

After press “Enter” key to execute. It will show “Pass” Information like this picture:

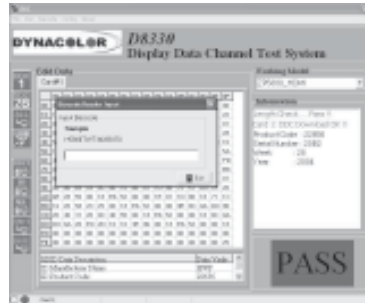

From now, you have finished the DDC-digital data update.

Note: There are 2 DDC ports need upgrade.

2-6. Turn on the “Protection” for DDC upgrade, then press “Vol -” + “Menu” simultaneously.

3. Notice:

3-1. D8330 is a VESA Display Data Channel (DDC) test system. The versatile functions of D8330 include download of DDC data from PC to display unit for configuration, or upload of DDC data from display unit to PC for verification, parsing, and editing. D8330 also offers multi-channel test capability once display unit equips with multiple signal inputs (VGA, DVI). It developed and manufactured from DynaColor, Inc. More information please reference.

<http://www.dynacolor.com.tw>

The full D8330 Display Data Channel Testing System including

1. D8330 card
2. Interface cable (including digital and analog cable)
3. CD-ROM (D8330 software & user’s manual)

Please reference D8330 User’s Manual. If you can’t normal install, please call Coretronic Service Center for help.

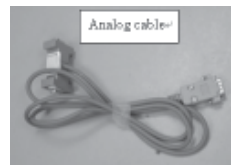
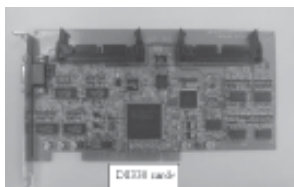

3-2. ZP5880_VGA.DDC, ZP5880_HDMI.DDC

they including DDC data, it's text file. It's provided by Coretronic. It should put in C:\Program Files\DynaColor\DDC\data dictionary. If you got error in here, please call Coretronic Customer Service Center.

3-3. If you key in incorrect serial number or TV doesn't power on. You will show this picture.

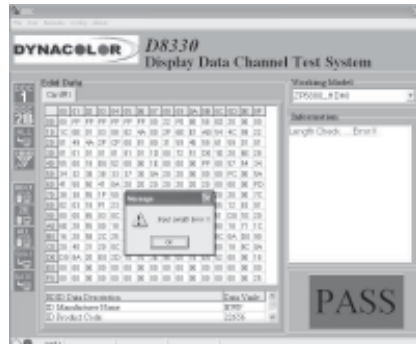

Appendix A

Exploded Overview- 1

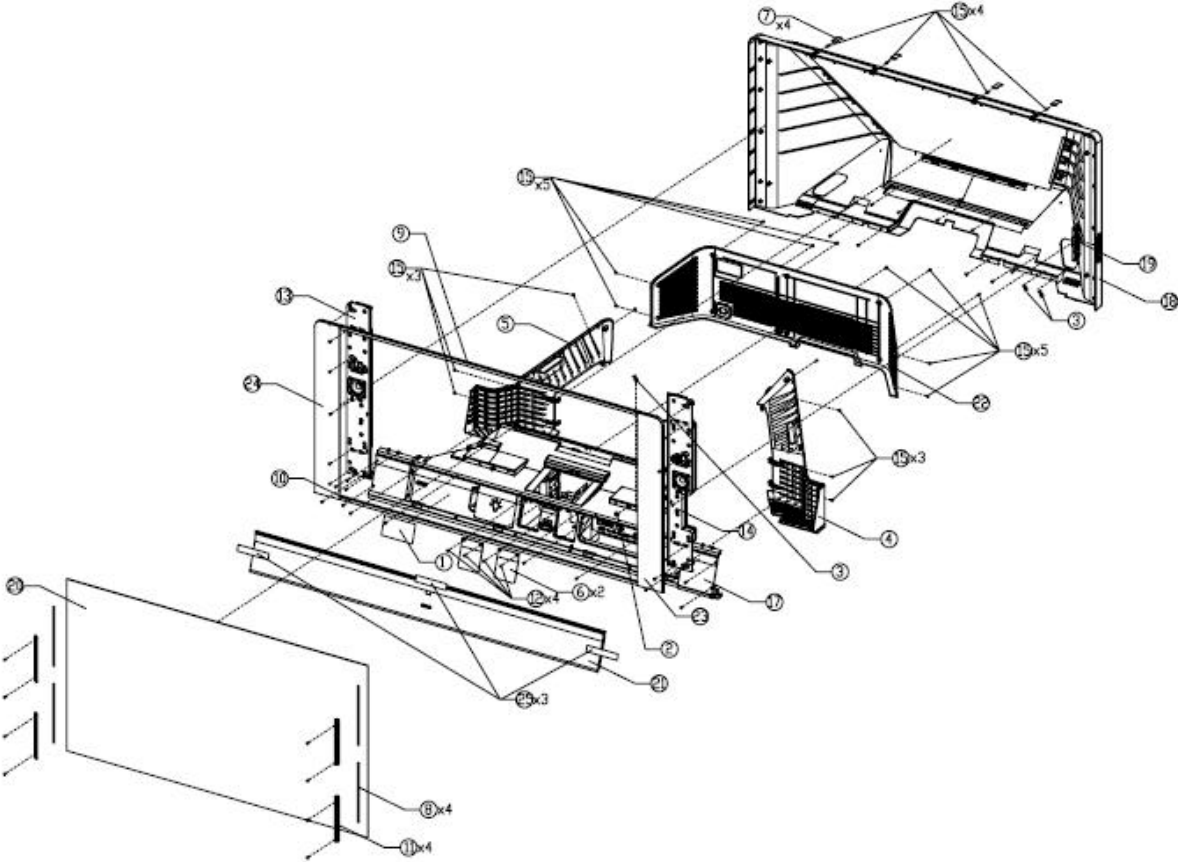

Exploded Parts List – 1

The following parts list is **FOR REFERENCE ONLY**, as not all parts/assemblies are available for ordering on HP's parts ordering web sites (CSN/Consumer Support Ordering and HP PartSurfer).

Item	Description
1	Lamp/interlock warning label
2	Open/close bushing
3	Wire Clip TDY 8-1
4	RP58 real-R-end cap
5	RP58 real-L-end cap
6	RP alignment door
7	RP screw cover
8	RP screen rubber
9	RP58 top extrusion
10	RP58 bottom extrusion
11	RP screen BKT
12	Screw star pan tap M4x12, black
13	Assembly, speaker/left 15W/8 3"
14	Assembly, speaker/right 15W/8 3"
15	Screw machine pan M4x8 NYLOK black
16	Crew pan tap M4x10 black green
17	Assembly, common chassis
18	Assembly, rear housing module
19	Assembly, keypad module
20	Assembly, screen module
21	Assembly, easy door module
22	Assembly, rear-shroud module
23	Assembly, RP58 right speaker grill
24	Assembly, RP58 left speaker grill
25	Fiber tape

Exploded Overview- 2

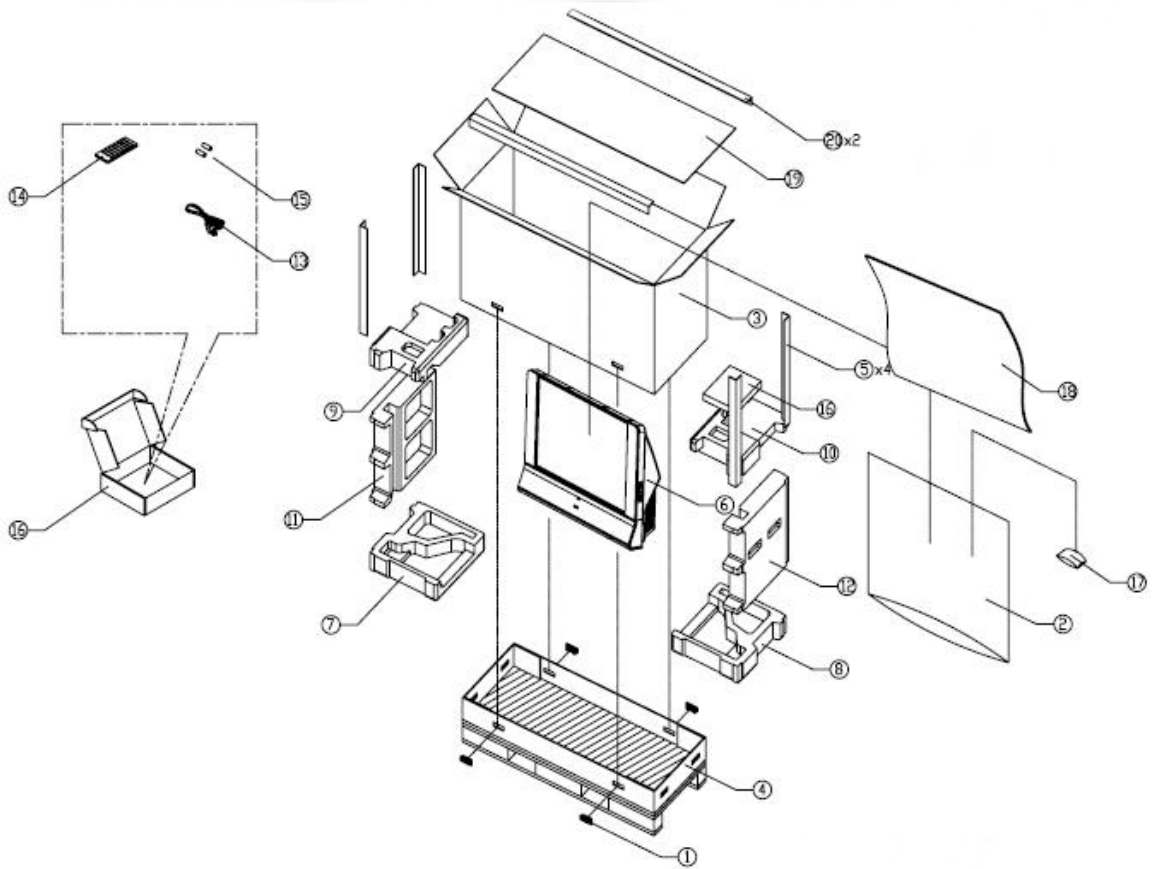

Exploded Parts List – 2

The following parts list is **FOR REFERENCE ONLY**, as not all parts/assemblies are available for ordering on HP's parts ordering web sites (CSN/Consumer Support Ordering and HP PartSurfer).

Item	Description
1	Handle, V0-11
2	RP58 EPE Bag
3	RP58 carton enclosure
4	RP58 C-cap + paper pallet
5	RP58 carton corner
6	MDTV unit (reference only)
7	RP58 cushion bottom left
8	RP58 cushion bottom right
9	RP58 cushion top left
10	RP58 cushion top right
11	RP58 cushion mid left
12	RP58 cushion mid right
13	Cable power cord AS 3P
14	Remote controller, USA
15	Super heavy battery #3
16	Carton pizza-box 278x233x45mm
17	Desiccative 250g
18	EPE foam cover 2060x1750mm
19	RP58 partition paper 1670x630mm
20	RP58 carton corner 1670x50x50mm

Exploded Overview- 3

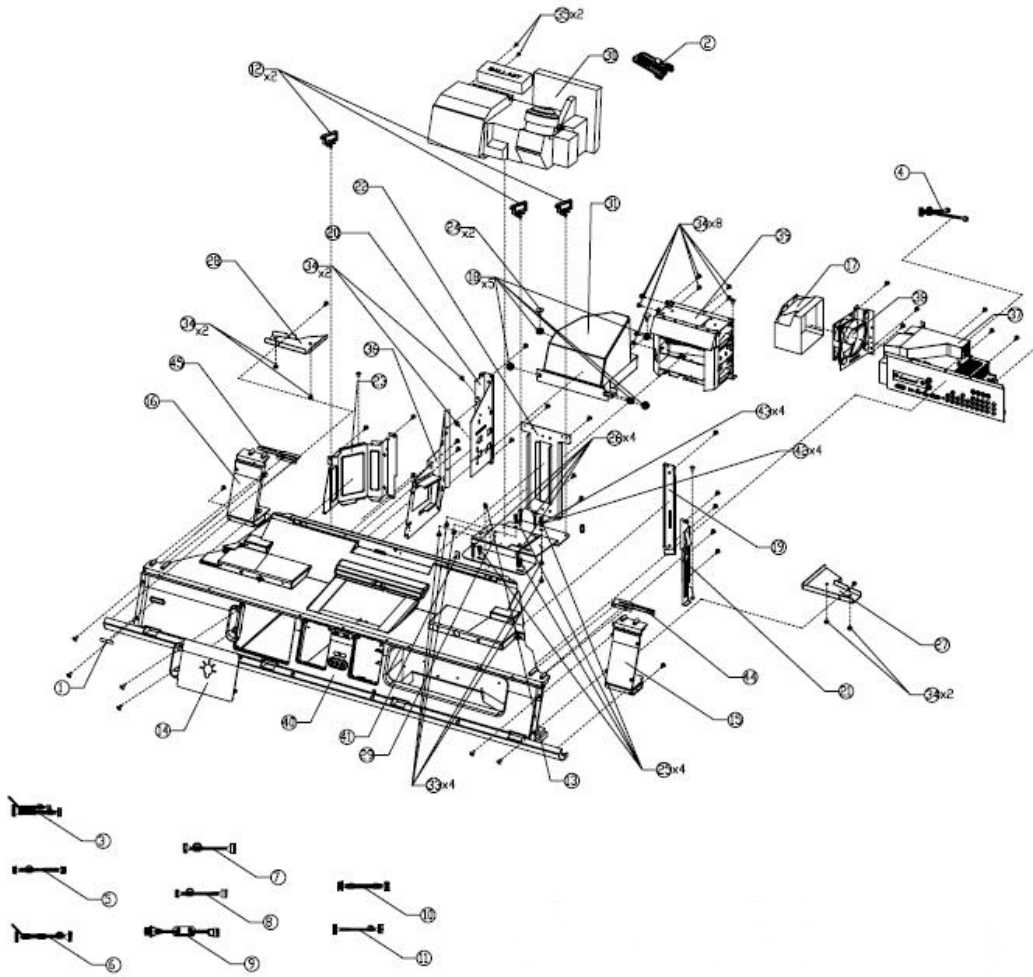

Exploded Parts List – 3

The following parts list is **FOR REFERENCE ONLY**, as not all parts/assemblies are available for ordering on HP's parts ordering web sites (CSN/Consumer Support Ordering and HP PartSurfer).

Item	Description
1	RP58 product label
2	Wiring assembly DVI formatter board to main
3	Wiring assembly LVPS to main board
4	Wiring assembly main board to fan
5	Wiring assembly main board to ballast
6	Wiring assembly LVPS to DVT
7	Wiring assembly LVPS to amplifier
8	Wiring assembly main board to amplifier
9	Wiring assembly lamp to ballast
10	Wiring assembly formatter board to LVPS
11	Wiring assembly main board to control button
12	Wire saddle CH-20A
13	Wire saddle CH-01L
14	RP lamp door
15	RP58 front right end cap
16	RP58 front left end cap
17	Air guide for HD4
18	RP sub woofer rubber
19	RP bottom rear right bracket
20	RP bottom rear left bracket
21	RP bottom front right bracket
22	RP bottom mid left bracket
23	RP bottom front left bracket
24	Screw shoulder tap-2 M5x8
25	Screw hex machine M5x15 NI
26	Screw thumb slot machine M4x35
27	RP58 bottom extended right bracket
28	RP58 bottom extended left bracket
29	ENG mount plate 58HD4
30	Assembly 58" HD4 engine
31	Assembly RP sub-woofer
32	Screw pan tap M4x10 black
33	Screw pan mech W/SF M4x10 NYLOK
34	Screw machine pan M4x8 NYLOK black
35	Screw cap mech M3x6 black
36	Assembly air guide bracket
37	Assembly main board module
38	Assembly fan module
39	Assembly LVPS module
40	Assembly base module
41	PCBA thermal board
42	Washer flat 18x5.3x1.6T NI
43	Washer spring M5 NI
44	RP58 extended top right bracket
45	RP58 extended top left bracket

Exploded Parts List – 4

The following parts list is **FOR REFERENCE ONLY**, as not all parts/assemblies are available for ordering on HP's parts ordering web sites (CSN/Consumer Support Ordering and HP PartSurfer).

Item	Description
1	RP I/O connector label
2	RP wire mount WAS-1
3	Spacer support SCE-11 "pin good"
4	Space support SCB-8A "pin good"
5	Air guide for main board
6	RP main board chassis
7	RP main board cover
8	Screw thumb M3x10 NI
9	Screw copper stick hex M3 H20xL6 green
10	Screw hex copper stick M3 H11xL6 green
11	ATSC/CNTC/QAM/DCR DTV RECEIVIN
12	PCBA main board
13	Audio amplifier board
14	PCBA audio processor board
15	Screw pan mech M3x6 NI NYLOK
16	Nut 3/8x32x11 NI
17	Washer blat 3/8x0.5x15 NI
18	RP cable card cover
19	RP cable card label
20	Hex I/O 4-4DUNCXH5XL9.0 NI

Exploded Overview- 5

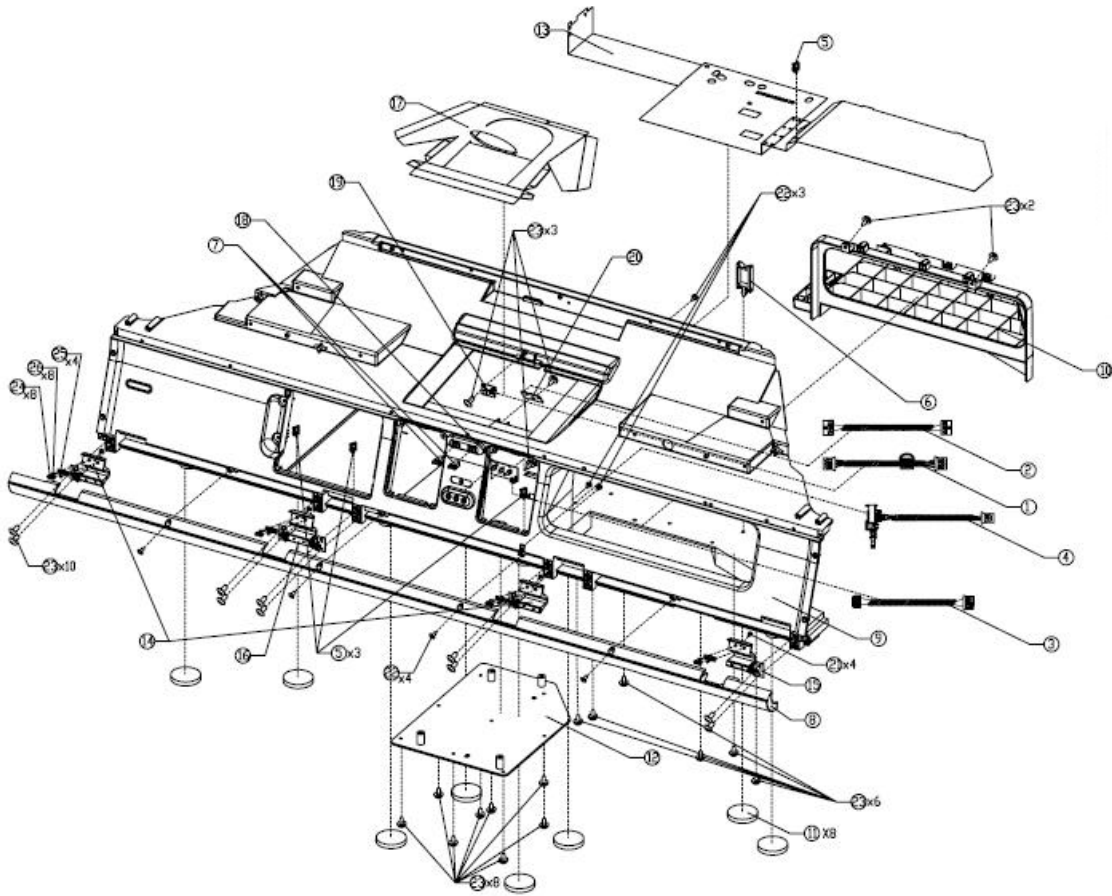

Exploded Parts List – 5

The following parts list is **FOR REFERENCE ONLY**, as not all parts/assemblies are available for ordering on HP's parts ordering web sites (CSN/Consumer Support Ordering and HP PartSurfer).

Item	Description
1	Wiring assembly main board to IR receiver
2	Wiring assembly main board to LED
3	Wiring assembly main board to lighting LED
4	Wiring assembly lighting switch
5	RP wire mount WAS-1
6	RP wire mount CHA-3
7	Door lock DL-400D black
8	RP58 trim-front
9	RP common bottom base
10	RP main board base
11	RP foot pad
12	RP58 engine mount base
13	RP ground foil
14	Assembly RP58
15	Assembly RP58
16	Assembly RP58
17	Assembly RP HD4 engine lens sponge
18	PCBA LED board
19	PCBA IR board
20	PCBA door LED board
21	Screw binding mech M2.6x12 black
22	Screw pan tap M3x6 black
23	Screw pan tap M4x10 black green
24	Door lock female DL-10H
25	Door lock male DL-10K
26	Screw flat tap M3x5 black

Exploded Overview- 6

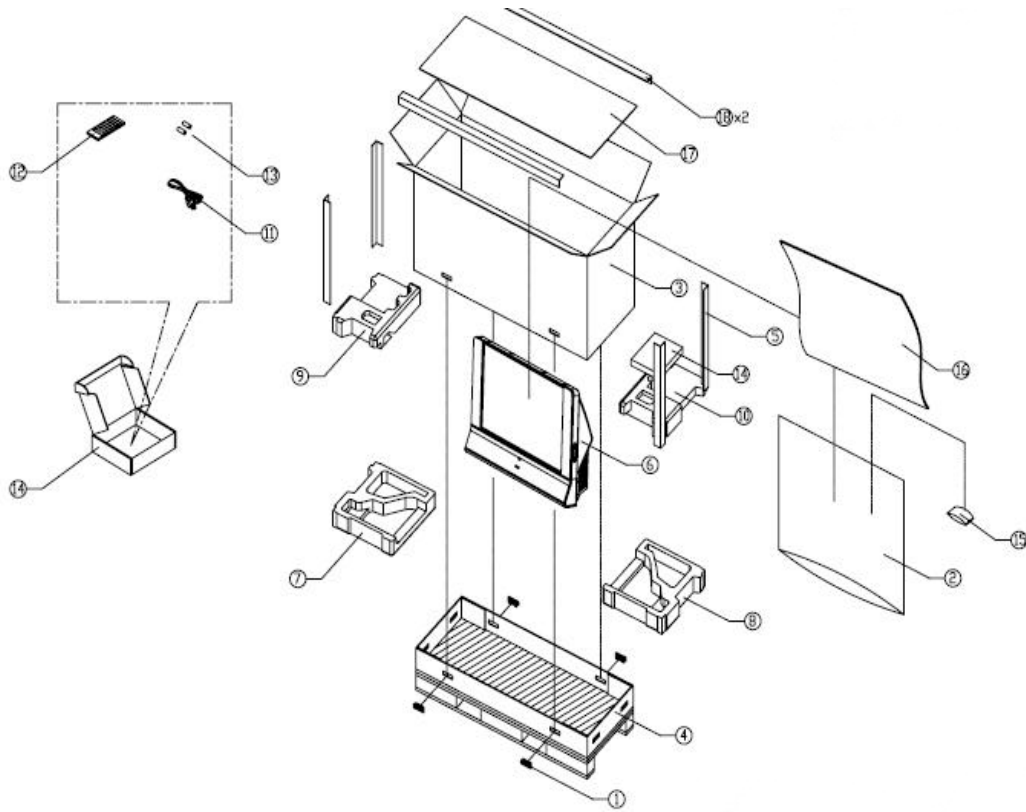

Exploded Parts List – 6

The following parts list is **FOR REFERENCE ONLY**, as not all parts/assemblies are available for ordering on HP's parts ordering web sites (CSN/Consumer Support Ordering and HP PartSurfer).

Item	Description
1	Handle V0-11
2	PE bag 1830x1600x0.08mm
3	RP50 carton enclosure
4	RP50 C-cap + paper pallet
5	RP50 carton corner
6	MDTV unit (reference only)
7	RP50 cushion bottom left
8	RP50 cushion bottom right
9	RP50 cushion top left
10	RP50 cushion top right
11	Cable power cord AC 3P
12	Remote controller
13	Super heavy battery #3
14	Carton pizza-box 278x233x45mm
15	Desiccative 250g
16	EPE foam cover 1830x1600mm
17	RP50 partition paper 1512x615mm
18	EPD foam cover 1830x1600mm

Exploded Overview- 7

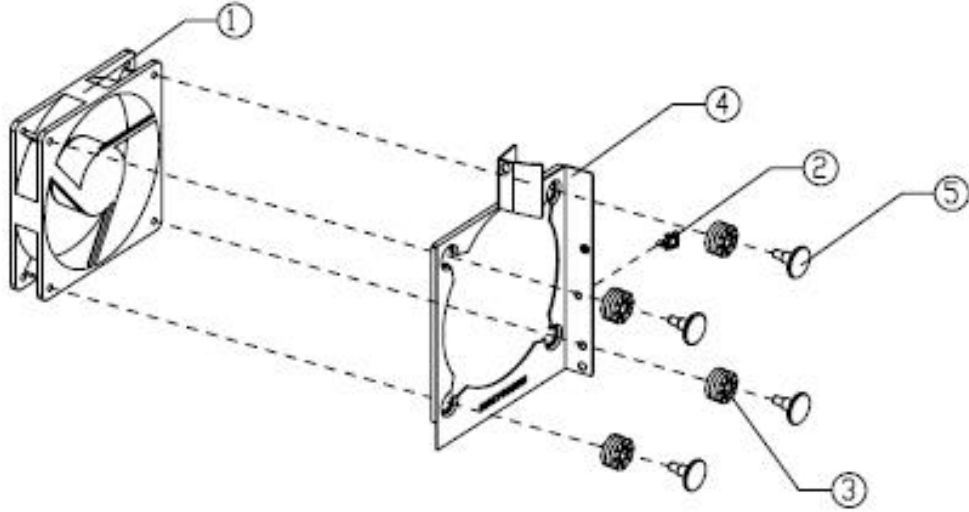

Exploded Parts List – 7

The following parts list is **FOR REFERENCE ONLY**, as not all parts/assemblies are available for ordering on HP's parts ordering web sites (CSN/Consumer Support Ordering and HP PartSurfer).

Item	Description
1	Sanyodenki axial fan
2	RP wire mount WAS-1
3	RP sub woofer rubber
4	RP system fan bracket
5	Screw shoulder TAP2 M5x18 green

Exploded Overview- 8

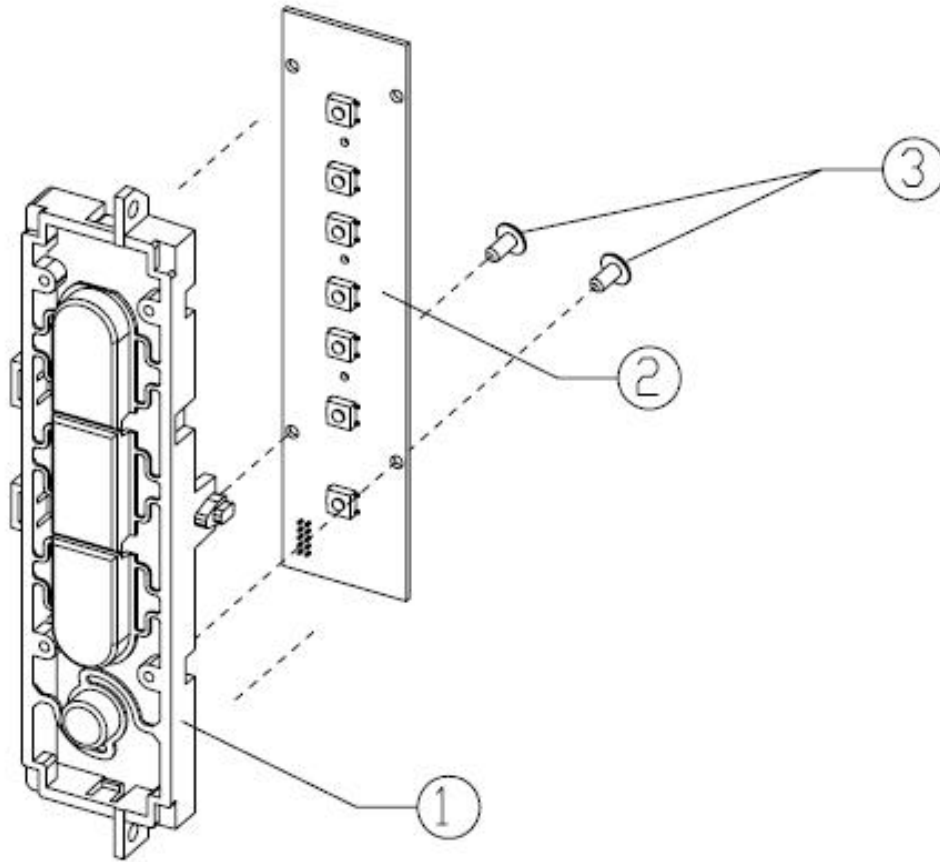

Exploded Parts List – 8

The following parts list is **FOR REFERENCE ONLY**, as not all parts/assemblies are available for ordering on HP's parts ordering web sites (CSN/Consumer Support Ordering and HP PartSurfer).

Item	Description
1	RP Control buttons
2	PCBA keypad board
3	Screen pan tap M3x6 black

Appendix B

System Serial Number Definition

TW T 5 WW ZZZZ
① ② ③ ④ ⑤

- ① is the ISO-3166, alpha 2 code for the country of manufacture (ie. TW).
- ② is a letter or digit that signifies the site/vendor within that country (A-Z, except O,U,I or the numbers 1-9).
- ③ is the year of manufacture counting from within a decade (0-9, ie. 2003 = 3).
- ④ is the week number of manufacture within that year (01-52).
- ⑤ is a unique sequential identifier that identifies the exact unit that was manufactured (ie. 0001).

Appendix C



Glossary

0–9

5.1-channel surround system A speaker setup that places one speaker above or below a television, on each side of the display, and two beside or just behind the listener (standard surround). A subwoofer is usually placed to the front of the listener. A surround system creates a more immersive, realistic sound experience—the more speakers, the richer the sound.

7.1-channel surround system A speaker setup that places one speaker above or below a television, one on each side of the display, two beside or slightly behind the listener (standard surround), two behind the listener (surround back channels), and a subwoofer to the front of the listener. A surround system creates a more immersive, realistic sound experience—the more speakers, the richer the sound.

480i (480-line interlaced scan) The vertical resolution of standard-definition broadcasts, and the original resolution technology. Picture is 704 x 480 pixels, sent at 60 interlaced frames per second (30 complete frames per second).

480p (480-line progressive scan) The vertical resolution of standard-definition and some enhanced-definition broadcasts. Picture is 704 x 480 pixels, sent at 60 complete frames per second.

720i (720-line interlaced scan) The vertical resolution of some high-definition broadcasts. Picture is 1280 x 720 pixels, sent at 60 interlaced frames per second (30 complete frames per second).

720p (720-line progressive scan) The vertical resolution of some high-definition broadcasts. Picture is 1280 x 720 pixels, sent at 60 complete frames per second.

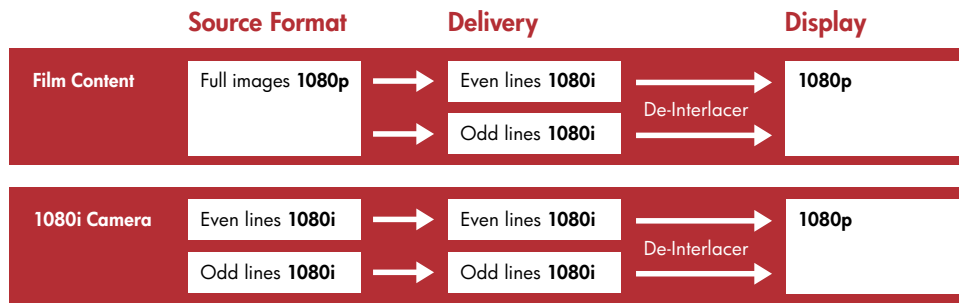

HD televisions and de-interlacing

Glossary continued

D

Digital light processing (DLP™) A Texas Instruments display technology that uses a Digital Micromirror Device (DMD) to create and project vibrant, high-definition images via either television or a projector.

De-interlacing A feature that improves picture quality, producing a film-like richness. Sixty frames per second are shown as opposed to the standard 30 frames per second. Also called "line doubling."

Digital coaxial cable Carries a multi-channel audio signal between digital or electronic devices, separating sound into speaker-specific signals.

Dark video enhancement Enhances details in dark scenes.

Digital tuner A set-top or built-in television tuner that receives digital television signals. Also called "digital receiver."

Dolby Digital A form of digital audio coding that efficiently encodes sound to a digital format, especially when multiple audio channels are required.

DTS (Digital Theater System) Digital Surround A surround sound format (5.1, 6.1, or 7.1), similar to Dolby Digital standard, that features five to seven discrete (independent) channels, plus a channel for low frequency effects. See "Dolby Digital" and also "Surround Sound."

E

Electronic program guide A program menu on HP entertainment products, such as the Digital Entertainment Center and Media Center PC, that displays chronological, and automatically updated, program listings.

F-G-H

HD televisions (see illustration above) Any TV set with native support for at least 720p is considered an HDTV. But will HD programs viewed on a 1080p set look better than they do on 720p models? The answer depends on the type of HD program. No HD shows are currently broadcast in 1080p; some are recorded in 720p, others in 1080i. 1080i content can be broadcast in 1080p using a de-interlacer. A 720p set de-interlaces the 1080i image and then scales down the 1080 horizontal lines to 720 lines; a 1080p set only has to do the first step, so it should produce a better-looking image. But 720p content is likely to look better on a natively 720p set than on a 1080p model that has to scale the image up.

HD-Built-in vs. HD-Ready Some HDTVs (HD-Built-in) have a built-in tuner to receive local high-definition broadcasts, and are considered true HDTVs. Sets without an integrated tuner are "HD-Ready" and need a set-top box to decode the high-definition signal.

Glossary continued

HD DVD (high-definition DVD) A next-generation optical disc format developed for high-definition video recording and rewriting. Types (red or blue laser) and storage capacity of HD DVDs vary. They include blue-laser DVD and Blu-ray disc.

HDMI (high-definition multimedia interface)

An uncompressed, all-digital audio/video interface between any compatible digital audio/video source, such as a set-top box, DVD player, and A/V receiver, and a compatible digital audio and/or video monitor, such as a digital television (DTV). HDMI supports standard, enhanced, or high-definition video, plus multi-channel digital audio on a single cable, and is backward-compatible with DVI.

HDCP (high-definition content protection) An encryption in high-definition signals that prevents unlawful duplication. HP's HD demo tapes have HDCP encoded.

HDTV ATSC tuner An internal or external over-the-air tuner that receives high-definition television signals. Also called "ATSC HD tuner."

I

Integrated HD An HDTV that has a built-in high-definition receiver/tuner.

Interlaced (i) scanning A method of displaying images from a video signal on a TV screen by filling in every other line (the odd lines), and then filling in the other lines (the even lines), so only half of the set's lines are "firing" at a given time. Interlacing allows for greater resolution at lower bandwidth, but it can produce flicker if you're watching sports or other content showing rapid movement.

J-K-L

Low-angle interpolation A corrective feature in HP TVs that smoothes out the "staircase effect" caused by viewing at certain angles.

Lumen The unit used for measuring light output, expressed in "candelas per square meter," or cd/m².

M

Microdisplay TV A large-screen television using rear projection technology. The newest generation of microdisplay TVs are more lightweight and compact than are their earlier counterparts.

Motion adaptive de-interlacing Detects and compensates for motion in pictures, reducing contours and greatly diminishing visual noise without reducing picture detail.

N-O

Optical cable A digital connector that carries information optically rather than electronically, which renders it unsusceptible to electrical interference.

Over-the-air HD programming Requires TV owners to have an HD antenna and HD-capable TV, and live in an area where digital television is broadcast.

P

Personal video recorder A device that can record and play back television in digital format, as opposed to the analog format recorded by a VCR. Also called "digital video recorder."

PIP (picture in picture) A television feature that allows you to view multiple TV channels simultaneously by creating one or more smaller displays within the larger television display.

POP (picture outside picture) A television feature that allows you to view two or more (depending on the type of POP capability the set has) TV channels simultaneously by dividing the television display into halves.

Progressive (p) scanning A method of displaying images from a video signal on a TV screen by filling in all of the vertical lines sequentially, rather than in two passes, as with interlaced scanning.

Glossary continued

Q

Quick connect On HP microdisplay TVs, an illuminated front connector panel that allows for easy setup and component changes.

R

Resolution-doubling technology A unique HP technology that projects digital images at double their resolution for improved clarity without increased cost. Also called "Wobulation."

S

SPDIF (Sony/Philips Digital Interface) A digital audio interface, most often used with an RCA connector.

SRS TruBass An audio technology that enhances low-frequency sound. Also a feature of SRS TruSurround XT.

SRS Dialog Clarity Enhancement An audio technology that makes movie and television dialogue crisper and more clearly articulated. Also a feature of SRS TruSurround XT.

SRS TruSurround XT A three-dimensional, high-definition audio technology that produces the effect of surround-sound with as few as two speakers. Voices are more accurate, bass is richer, and sound is overall fuller and more dramatic.

SRS WOW An audio technology that strengthens voices and creates rich bass without the need for a subwoofer.

Surround-sound Three-dimensional sound, usually created or amplified by the placement of multiple speakers throughout a room or home theater.

T

Terrestrial HD See "Over-the-air HD."

Thumbnail view A feature on HP microdisplay TVs that gives you a snapshot view via nine window panes showing what is connected to the TV. Permits quick, simple change between each source through remote control.

U

UHDV (ultra high-definition video) A next-generation HD format developed by the Japanese Broadcasting Corporation. Its resolution is 16 times greater than standard HD video, but it requires several terabytes of storage and a 450-inch diagonal screen to enjoy.

V

Visual Choice A feature on HP microdisplay TVs that gives you a snapshot view via nine window panes showing what is connected to the TV. Permits quick, simple change between each source through remote control.

Visual Fidelity An HP picture-processing technology that analyzes every pixel of every image from every video source for noise reduction, color enhancement, motion compensation, and detail enhancement to deliver a spectacular picture.

W

Wobulation A unique HP technology that projects digital images at double their resolution for improved clarity without increased cost. Also called "resolution-doubling technology." Virtually eliminates screen-door effect.

Free Manuals Download Website

<http://myh66.com>

<http://usermanuals.us>

<http://www.somanuals.com>

<http://www.4manuals.cc>

<http://www.manual-lib.com>

<http://www.404manual.com>

<http://www.luxmanual.com>

<http://aubethermostatmanual.com>

Golf course search by state

<http://golfingnear.com>

Email search by domain

<http://emailbydomain.com>

Auto manuals search

<http://auto.somanuals.com>

TV manuals search

<http://tv.somanuals.com>