

HP 3PAR StoreServ 7000/7450 Storage Cabling Configuration Guide B: 2 Node Systems with Large 3.5-inch Drive Enclosures

Abstract

This guide provides cabling information for authorized technicians performing installation and maintenance services on the HP 3PAR StoreServ 7000/7450 Storage systems.

HP Part Number: QR482-96397
Published: June 2013



© Copyright 2013 Hewlett-Packard Development Company, L.P.

The information contained herein is subject to change without notice. The only warranties for HP products and services are set forth in the express warranty statements accompanying such products and services. Nothing herein should be construed as constituting an additional warranty. HP shall not be liable for technical or editorial errors or omissions contained herein.

Acknowledgments

Microsoft®, Windows®, are U.S. registered trademarks of Microsoft Corporation.

Warranty

WARRANTY STATEMENT: To obtain a copy of the warranty for this product, see the warranty information website:

<http://www.hp.com/go/storagewarranty>

Printed in the US.

Contents

1	Cabling Preparation for HP 3PAR StoreServ 7000/7450.....	4
	Following Precautions.....	4
	Identifying and Labeling the Components.....	4
2	Cabling HP 3PAR StoreServ 7000/7450.....	7
2	Node 1 Drive Enclosures (1L).....	7
	Attach DP-1 Chains to Enclosures.....	8
	Attach DP-2 Chains to Enclosures.....	9
	Review Completed Cabling.....	10
2	Node 2 Drive Enclosures (2L).....	11
	Attach DP-1 Chains to Enclosures.....	12
	Attach DP-2 Chains to Enclosures.....	13
	Review Completed Cabling.....	14
2	Node 3 Drive Enclosures (3L).....	15
	Attach DP-1 Chains to Enclosures.....	16
	Attach DP-2 Chains to Enclosures.....	17
	Review Completed Cabling.....	18
2	Node 4 Drive Enclosures (4L).....	19
	Attach DP-1 Chains to Enclosures.....	20
	Attach DP-2 Chains to Enclosures.....	21
	Review Completed Cabling.....	22
2	Node 5 Drive Enclosures (5L).....	23
	Attach DP-1 Chains to Enclosures.....	24
	Attach DP-2 Chains to Enclosures.....	25
	Review Completed Cabling.....	26
2	Node 6 Drive Enclosures (6L).....	27
	Attach DP-1 Chains to Enclosures.....	28
	Attach DP-2 Chains to Enclosures.....	29
	Review Completed Cabling.....	30
2	Node 7 Drive Enclosures (7L).....	31
	Attach DP-1 Chains to Enclosures.....	32
	Attach DP-2 Chains to Enclosures.....	33
	Review Completed Cabling.....	34
2	Node 8 Drive Enclosures (8L).....	35
	Attach DP-1 Chains to Enclosures.....	36
	Attach DP-2 Chains to Enclosures.....	37
	Review Completed Cabling.....	38
2	Node 9 Drive Enclosures (9L).....	39
	Attach DP-1 Chains to Enclosures.....	40
	Attach DP-2 Chains to Enclosures.....	41
	Review Completed Cabling.....	42
3	Additional Resources and Related Documentation.....	43
	Contacting HP.....	43
	HP 3PAR Documentation.....	43

1 Cabling Preparation for HP 3PAR StoreServ 7000/7450

The following instructions list important precautions and information about cabling installation options for the HP 3PAR StoreServ Storage system.

Following Precautions

Follow these general precautions to avoid injury, data loss, and damage before and during installation or while servicing the HP 3PAR StoreServ Storage system:

- Avoid using improper tools
- Prepare an Electrostatic Discharge-safe (ESD) work surface by placing an antistatic mat on the floor, or table, near the storage system. Attach the ground lead of the mat to an unpainted surface of the rack
- Always use a wrist-grounding strap, provided with the storage system. Attach the grounding strap clip directly to an unpainted surface of the rack
- Avoid contact between electronic components and clothing which can carry an electrostatic charge
- Ensure all cables are properly labeled and easily identifiable prior to removing a component
- Observe local occupational safety requirements and guidelines for handling heavy equipment
- Always load the heaviest item first, and start from the bottom when loading the rack. Loading from the bottom makes the rack bottom-heavy and helps prevent the rack from becoming unstable
- Do not attempt to move a fully-loaded equipment rack. Remove all equipment from the rack before moving the rack
- Use at least two people to safely move the rack from the pallet

Identifying and Labeling the Components

This section of the chapter applies to all configurations in this guide. The guide provides instructional guidance for cabling the HP 3PAR StoreServ 7000/7450 according to a specific configuration. All HP 3PAR StoreServ Storage systems contain either the HP 3PAR 7200 (2 nodes) or 7400/7450 (with 2 or 4 nodes), M6720 large drive enclosure(s), and M6710 small drive enclosure(s).

The M6720 large drive enclosures supports 3.5-inch disk drives and the smaller M6710 drive enclosure supports 2.5-inch disk drives.

The cabling configurations are identifiable by the specific number of nodes connecting to a combination of small or large disk drive enclosures. The cabling configuration examples below uses the following identification:

- **2 Node 10 Drive Enclosure (1S)** refers to a configuration using two nodes connecting to one small (2.5-inch) disk drive enclosure
- **2 Node 10 Drive Enclosures (6S+4L)** refers to a configuration using two nodes connecting to a combination of six small (2.5-inch) and four large (3.5-inch) drive enclosures

Types of Components

Use the red and green color coding to assist with the cabling. Only connect to components sharing the same color.

Figure 1 Identifying Components and SAS Ports

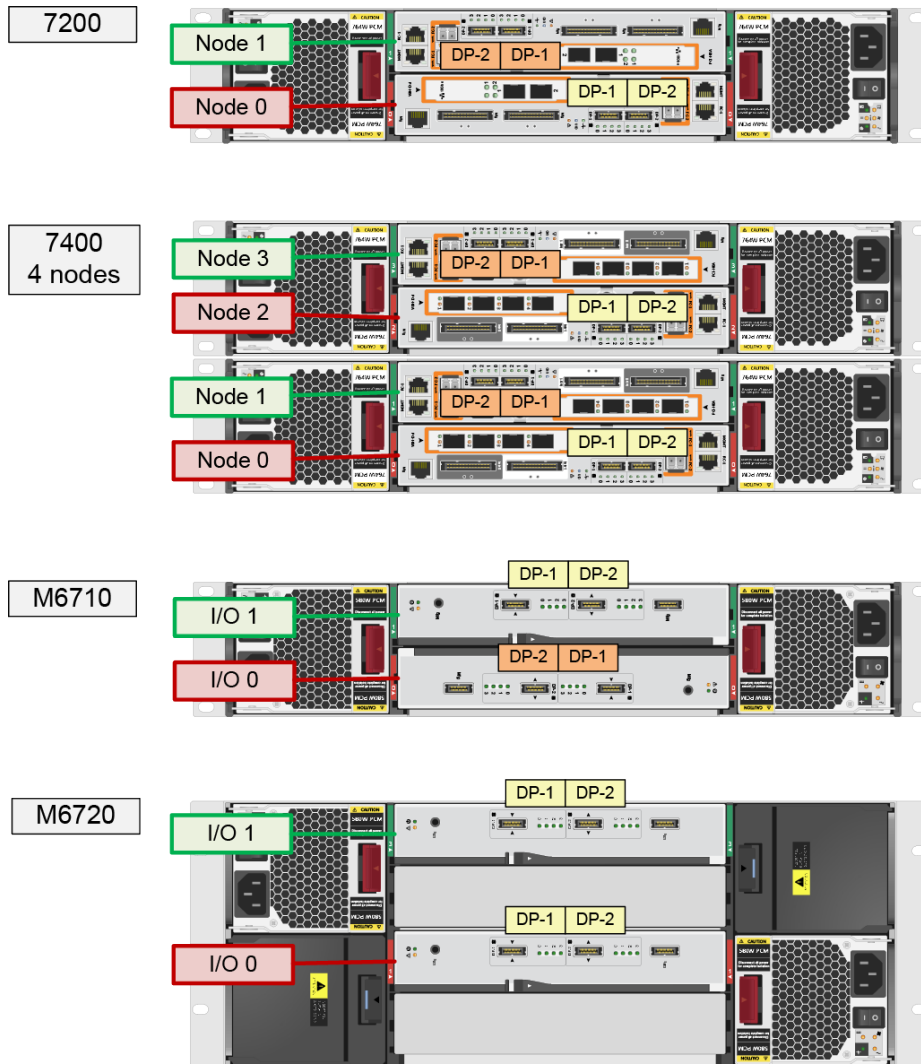

Labeling the Enclosures

Before connecting the cables:

- Labels **(A, B, C, and D)** are provided to help identify the enclosures in the storage system. Apply the labels to each enclosure in a visible location and avoid covering other labels
- Apply label **A** to the controller enclosure with nodes 0 and 1. Alternate the labeling **(A/B)** on each enclosure below the controller enclosure

If applicable, a system using four nodes, apply label **C** to the controller enclosure with nodes 2 and 3. Alternate the labeling **(C/D)** on each enclosure above the controller enclosure.

The illustration below describes a typical configuration using two nodes and a combination of large and small drive enclosures.

NOTE: The illustrative depiction may not reflect the configuration setup of your system but the labeling pattern is similar.

Figure 2 Labeling the Enclosures

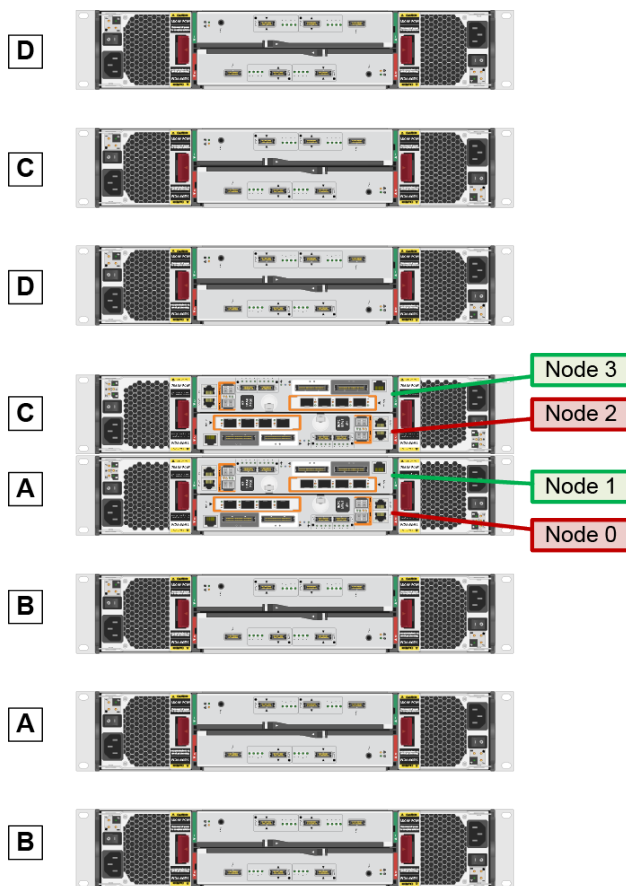

For more information relating to cabling hosts, refer to *HP 3PAR StoreServ 7000/7450 Installation Guide*.

2 Cabling HP 3PAR StoreServ 7000/7450

The following illustrative sections provide a rear view of the rack with recommended racking configuration of the system.

2 Node 1 Drive Enclosures (1L)

Before you begin cabling the storage system, carefully read or print the following section, including figures 1 and 2, "Identifying and Labeling the Components" (page 4).

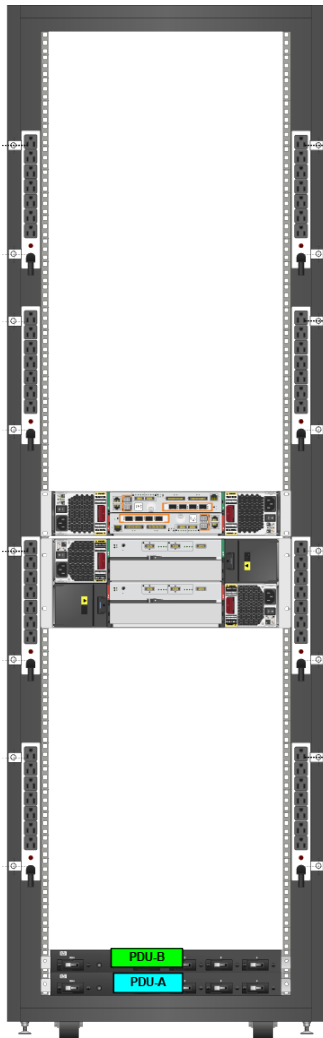

Attach DP-1 Chains to Enclosures

This system does not require any connections to node port DP-1.

A

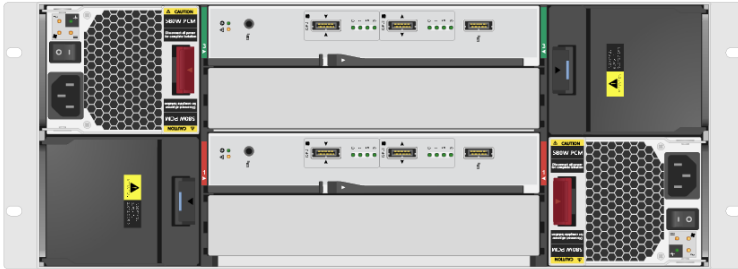
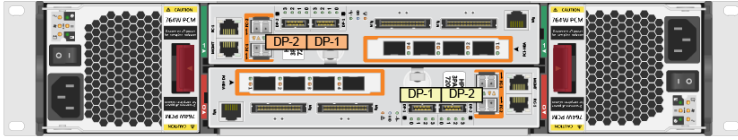

Attach DP-2 Chains to Enclosures

Red routing

1. Connect **Node 0 (DP-2)** to the **I/O 0 (DP-1)** on the **B** drive enclosure closest to the controller.
2. Connect all **A** drive enclosures from **(DP-2) to (DP-1) working away from the controller.**

Green routing

1. Connect **Node 1 (DP-2)** to **I/O 1** on the **B** drive enclosure farthest from the controller.
2. Connect all **B** drive enclosures from **(DP-2) to (DP-1) working toward the controller.**

NOTE: The two adjacent enclosures are not directly connected.

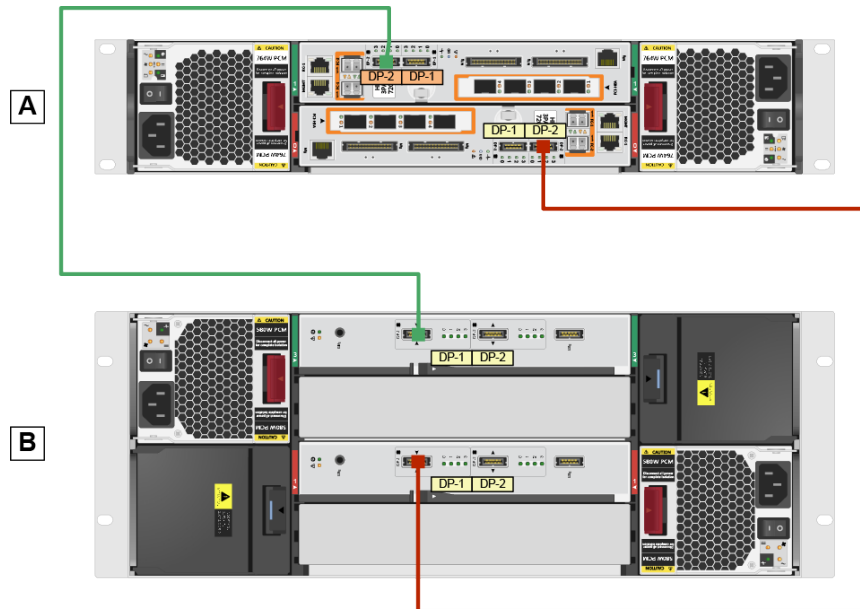

Review Completed Cabling

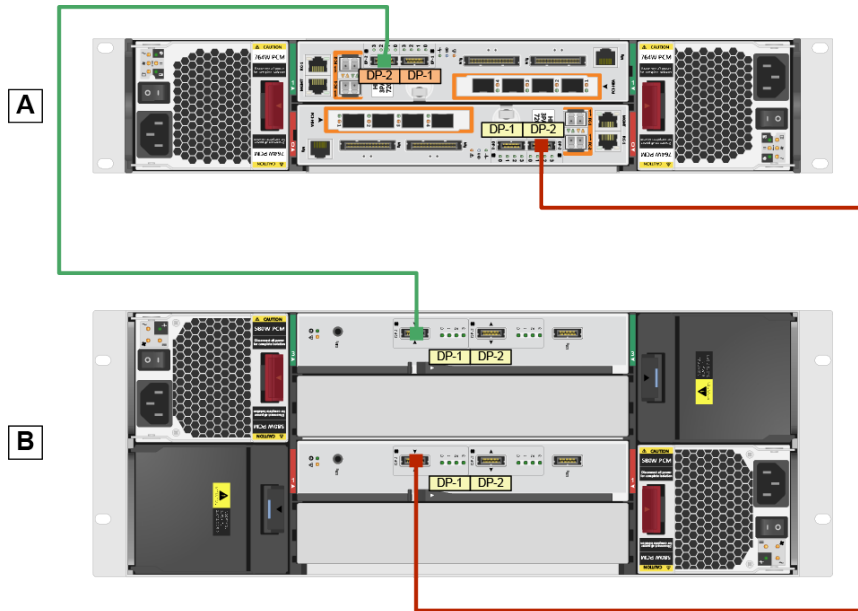
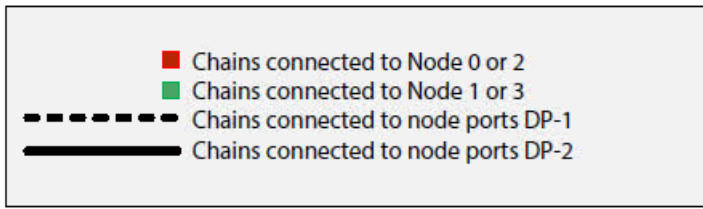

2 Node 2 Drive Enclosures (2L)

Before you begin cabling the storage system, carefully read or print the following section, including figures 1 and 2, "Identifying and Labeling the Components" (page 4).

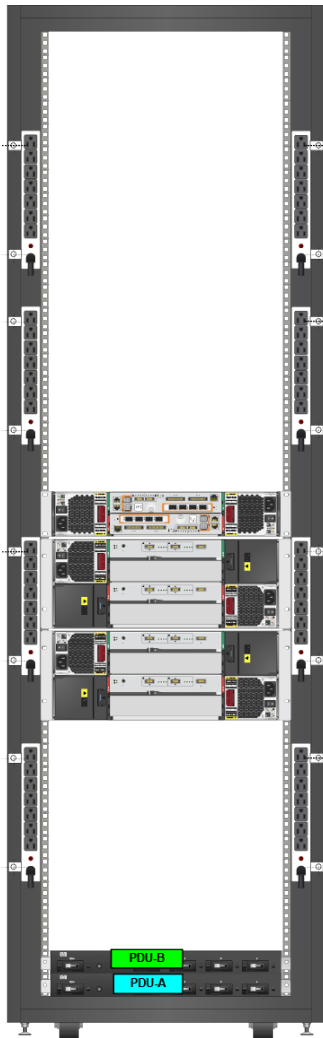

Attach DP-1 Chains to Enclosures

Red routing

1. Connect **Node 0 (DP-1)** to the **I/O 0 (DP-1)** on the **A** drive enclosure closest to the controller.
2. Connect all **A** drive enclosures from **(DP-2) to (DP-1) working away from the controller.**

Green routing

1. Connect **Node 1 (DP-1)** to **I/O 1 (DP-1)** on the **A** drive enclosure farthest from the controller.
2. Connect all **A** drive enclosures from **(DP-2) to (DP-1) working toward the controller.**

NOTE: The two adjacent enclosures are not directly connected.

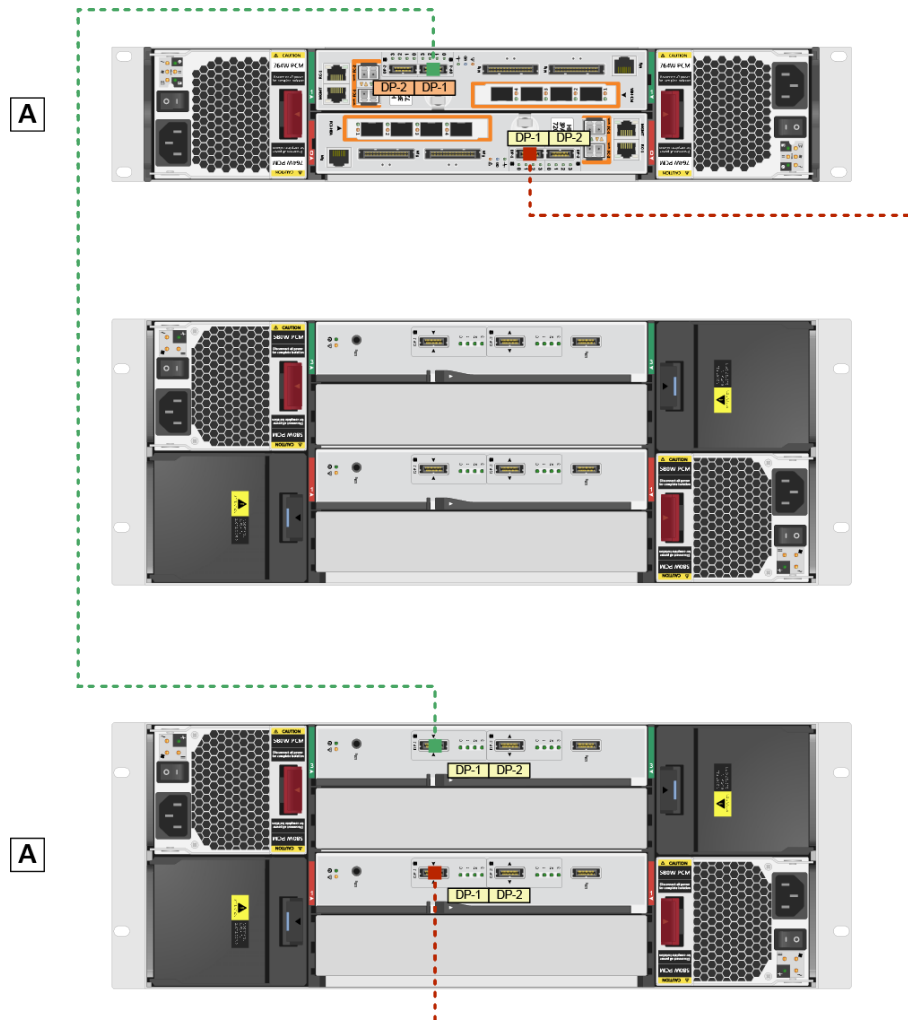

Attach DP-2 Chains to Enclosures

Red routing

1. Connect **Node 0 (DP-2)** to the **I/O 0 (DP-1)** on the **B** drive enclosure closest to the controller.
2. Connect all **B** drive enclosures from **(DP-2) to (DP-1) working away from the controller.**

Green routing

1. Connect **Node 1 (DP-2)** to **I/O 1** on the **B** drive enclosure farthest from the controller.
2. Connect all **B** drive enclosures from **(DP-2) to (DP-1) working toward the controller.**

NOTE: The two adjacent enclosures are not directly connected.

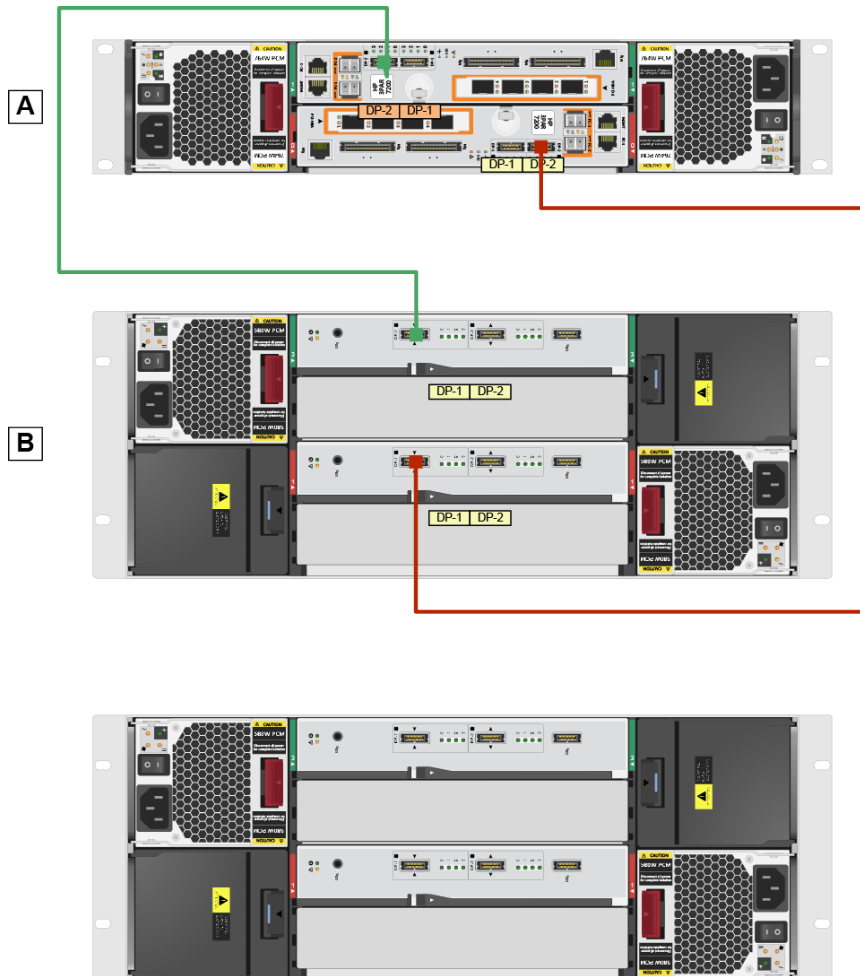

Review Completed Cabling

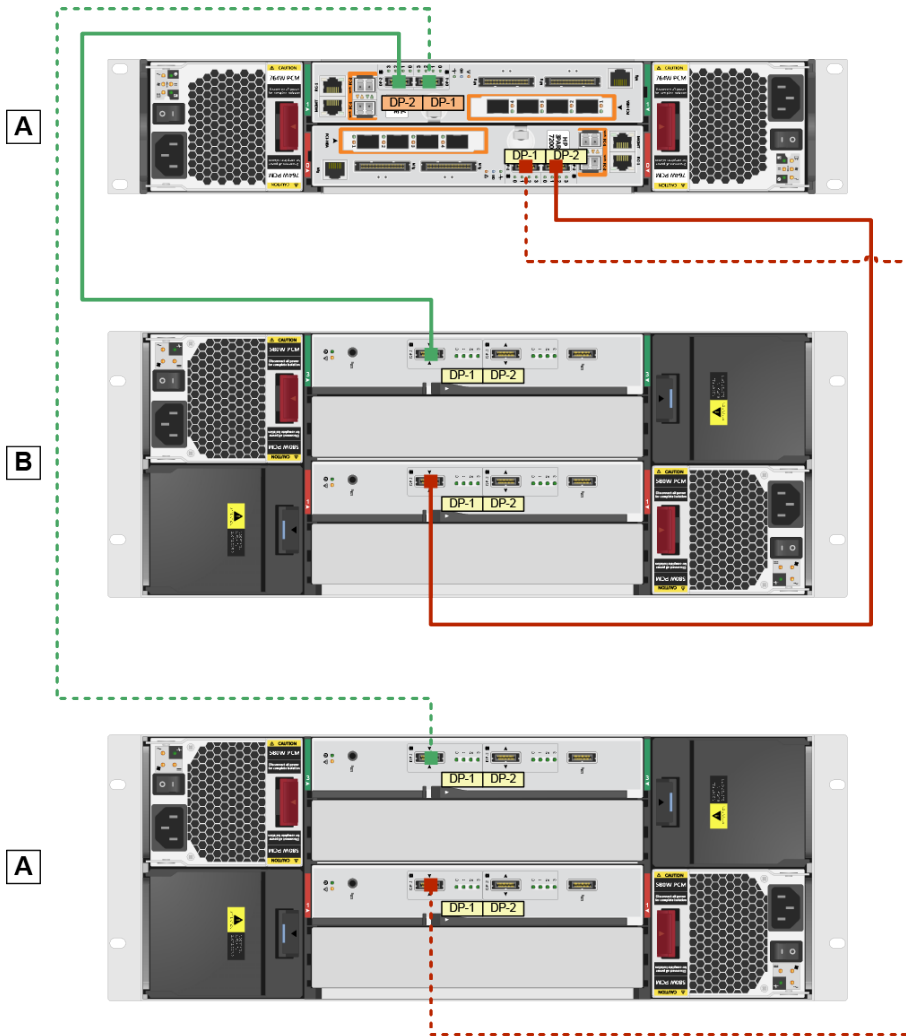
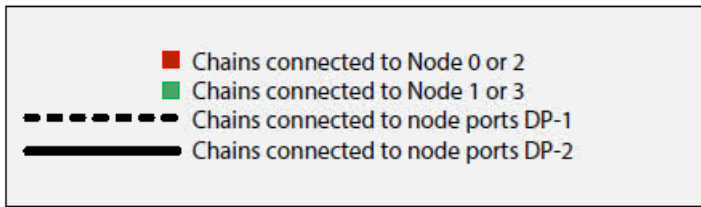

2 Node 3 Drive Enclosures (3L)

Before you begin cabling the storage system, carefully read or print the following section, including figures 1 and 2, "Identifying and Labeling the Components" (page 4).

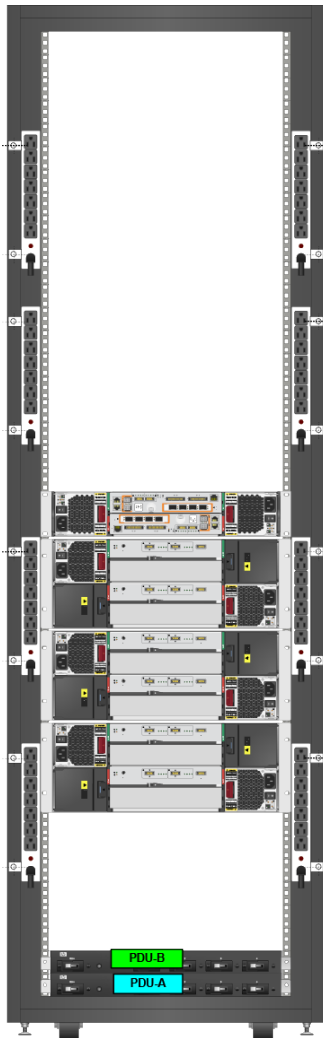

Attach DP-1 Chains to Enclosures

Red routing

1. Connect **Node 0 (DP-1)** to the **I/O 0 (DP-1)** on the **A** drive enclosure closest to the controller.
2. Connect all **A** drive enclosures from **(DP-2) to (DP-1) working away from the controller.**

Green routing

1. Connect **Node 1 (DP-1)** to **I/O 1 (DP-1)** on the **A** drive enclosure farthest from the controller.
2. Connect all **A** drive enclosures from **(DP-2) to (DP-1) working toward the controller.**

NOTE: The two adjacent enclosures are not directly connected.

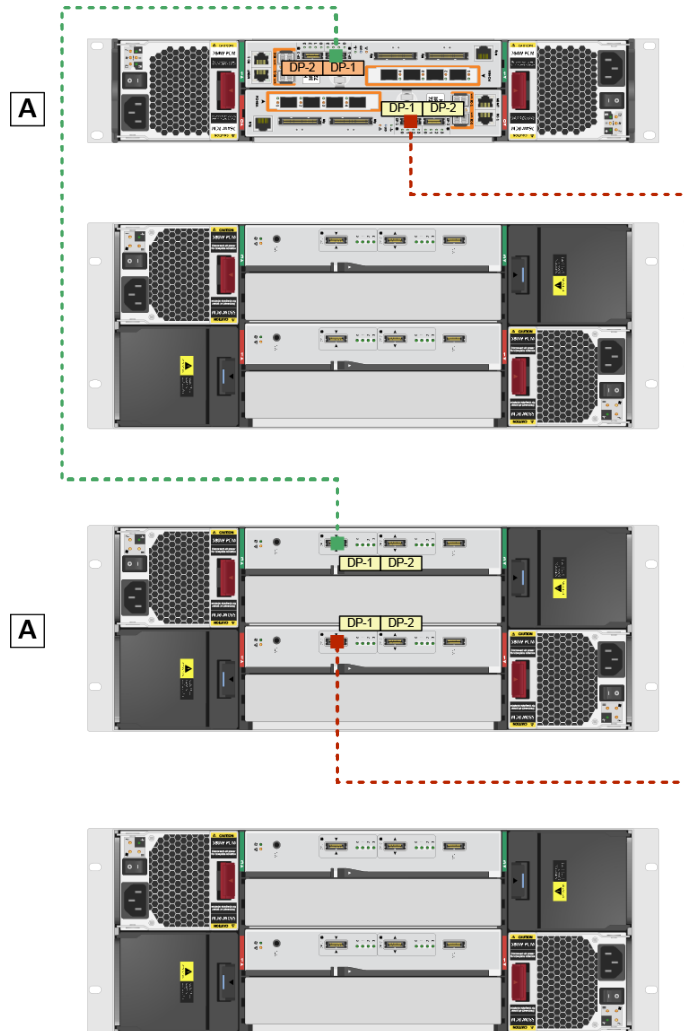

Attach DP-2 Chains to Enclosures

Red routing

1. Connect **Node 0 (DP-2)** to the **I/O 0 (DP-1)** on the **B** drive enclosure closest to the controller.
2. Connect all **B** drive enclosures from **(DP-2) to (DP-1) working away from the controller.**

Green routing

1. Connect **Node 1 (DP-2)** to **I/O 1** on the **B** drive enclosure farthest from the controller.
2. Connect all **B** drive enclosures from **(DP-2) to (DP-1) working toward the controller.**

NOTE: The two adjacent enclosures are not directly connected.

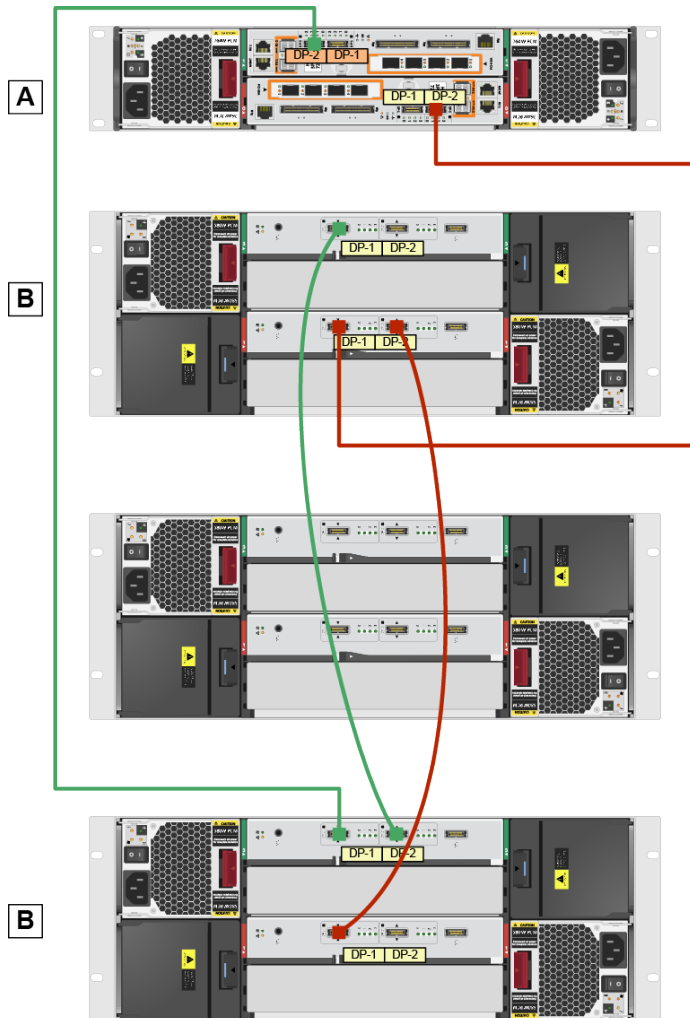

Review Completed Cabling

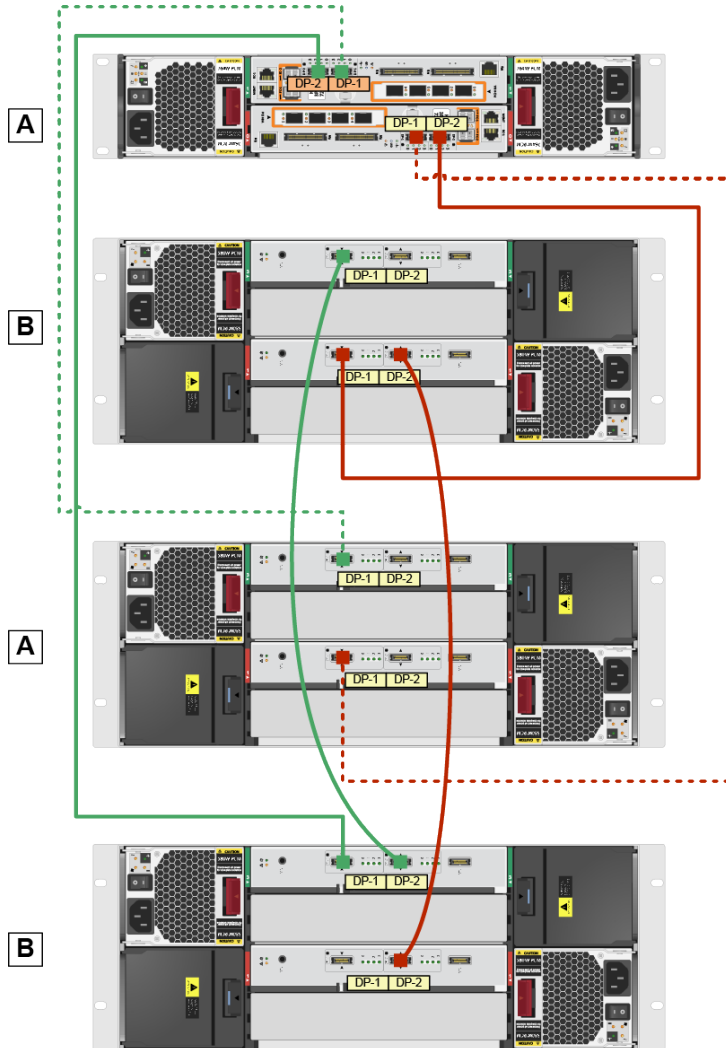
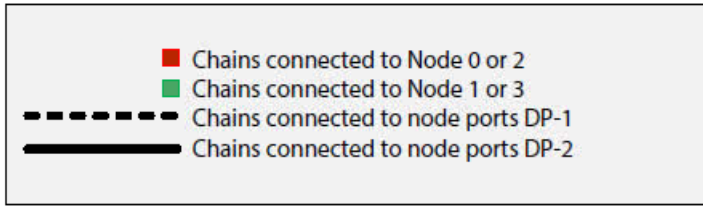

2 Node 4 Drive Enclosures (4L)

Before you begin cabling the storage system, carefully read or print the following section, including figures 1 and 2, "Identifying and Labeling the Components" (page 4).

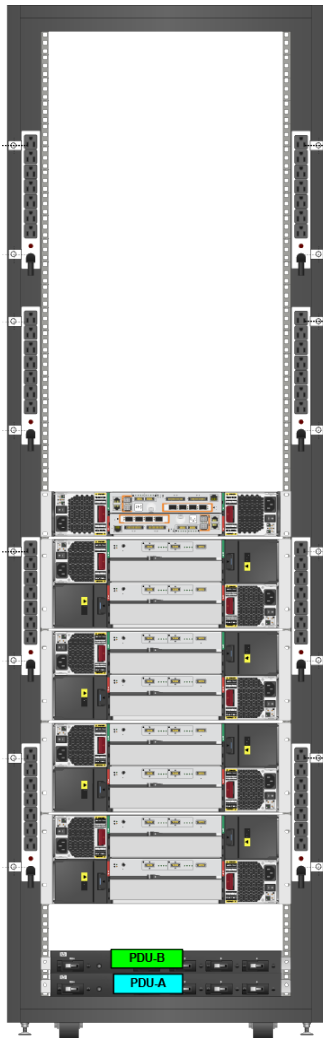

Attach DP-1 Chains to Enclosures

Red routing

1. Connect **Node 0 (DP-1)** to the **I/O 0 (DP-1)** on the **A** drive enclosure closest to the controller.
2. Connect all **A** drive enclosures from **(DP-2) to (DP-1) working away from the controller.**

Green routing

1. Connect **Node 1 (DP-1)** to **I/O 1 (DP-1)** on the **A** drive enclosure farthest from the controller.
2. Connect all **A** drive enclosures from **(DP-2) to (DP-1) working toward the controller.**

NOTE: The two adjacent enclosures are not directly connected.

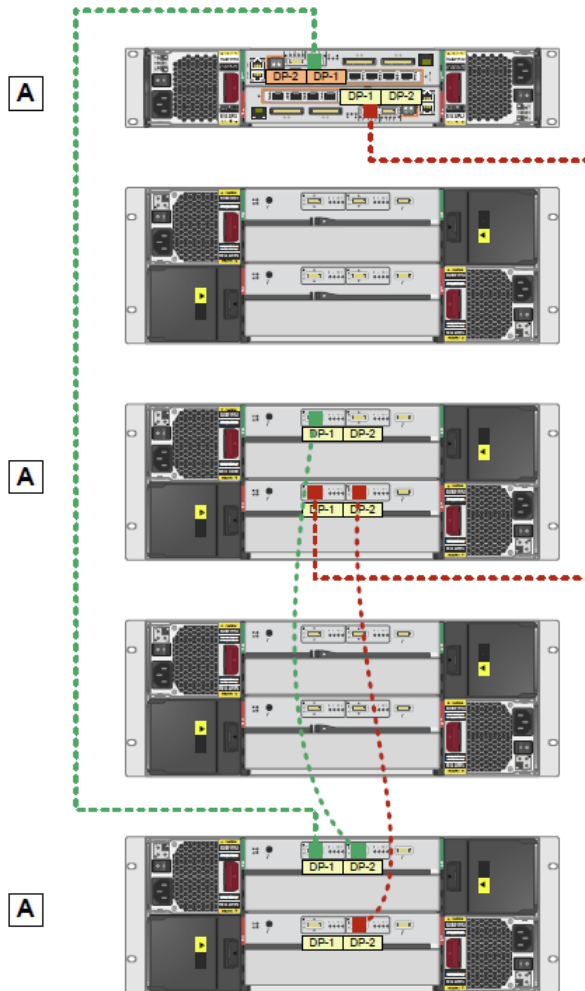

Attach DP-2 Chains to Enclosures

Red routing

1. Connect **Node 0 (DP-2)** to the **I/O 0 (DP-1)** on the **B** drive enclosure closest to the controller.
2. Connect all **B** drive enclosures from **(DP-2) to (DP-1) working away from the controller.**

Green routing

1. Connect **Node 1 (DP-2)** to **I/O 1** on the **B** drive enclosure farthest from the controller.
2. Connect all **B** drive enclosures from **(DP-2) to (DP-1) working toward the controller.**

NOTE: The two adjacent enclosures are not directly connected.

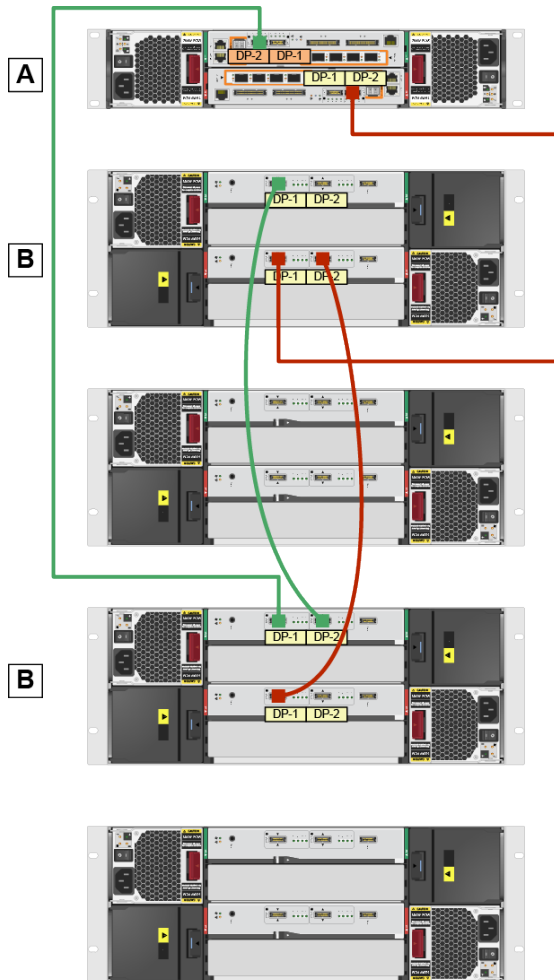

Review Completed Cabling

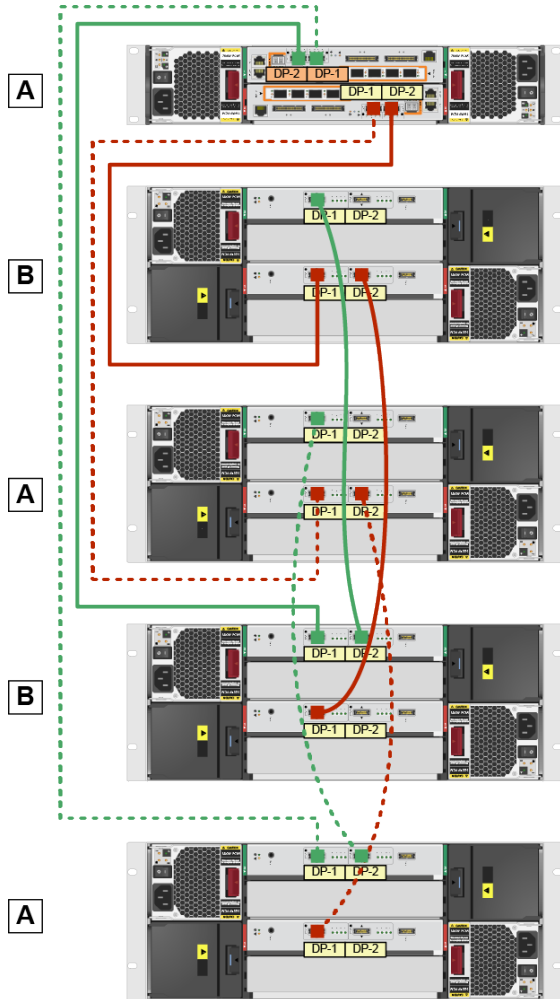
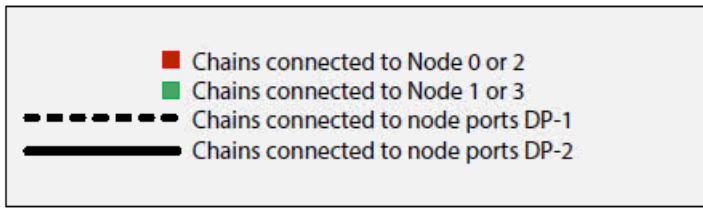

2 Node 5 Drive Enclosures (5L)

Before you begin cabling the storage system, carefully read or print the following section, including figures 1 and 2, "Identifying and Labeling the Components" (page 4).

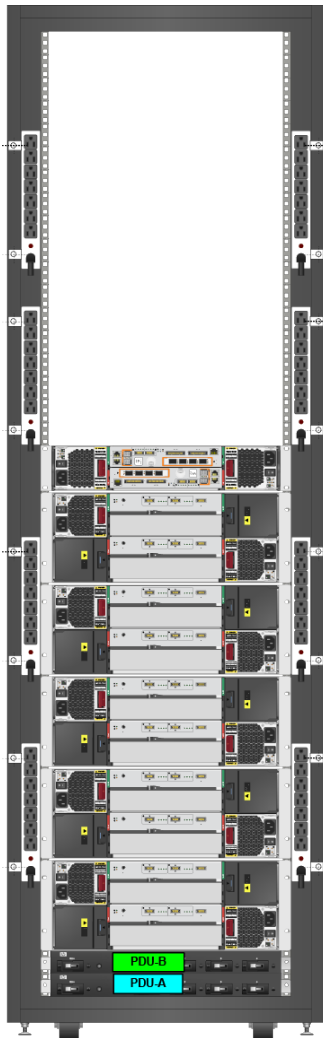

Attach DP-1 Chains to Enclosures

Red routing

1. Connect **Node 0 (DP-1)** to the **I/O 0 (DP-1)** on the **A** drive enclosure closest to the controller.
2. Connect all **A** drive enclosures from **(DP-2) to (DP-1)** working away from the controller.

Green routing

1. Connect **Node 1 (DP-1)** to **I/O 1 (DP-1)** on the **A** drive enclosure farthest from the controller.
2. Connect all **A** drive enclosures from **(DP-2) to (DP-1)** working toward the controller.

NOTE: The two adjacent enclosures are not directly connected.

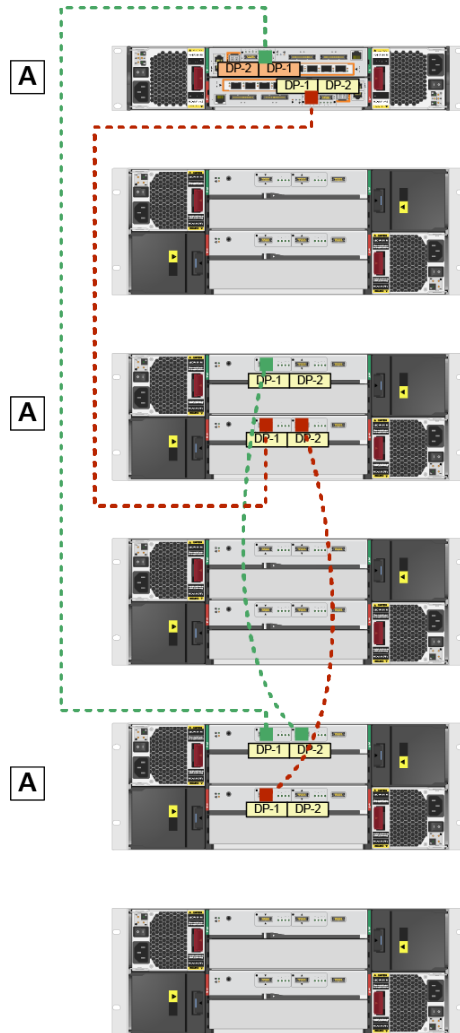

Attach DP-2 Chains to Enclosures

Red routing

1. Connect **Node 0 (DP-2)** to the **I/O 0 (DP-1)** on the **B** drive enclosure closest to the controller.
2. Connect all **B** drive enclosures from **(DP-2) to (DP-1) working away from the controller.**

Green routing

1. Connect **Node 1 (DP-2)** to **I/O 1** on the **B** drive enclosure farthest from the controller.
2. Connect all **B** drive enclosures from **(DP-2) to (DP-1) working toward the controller.**

NOTE: The two adjacent enclosures are not directly connected.

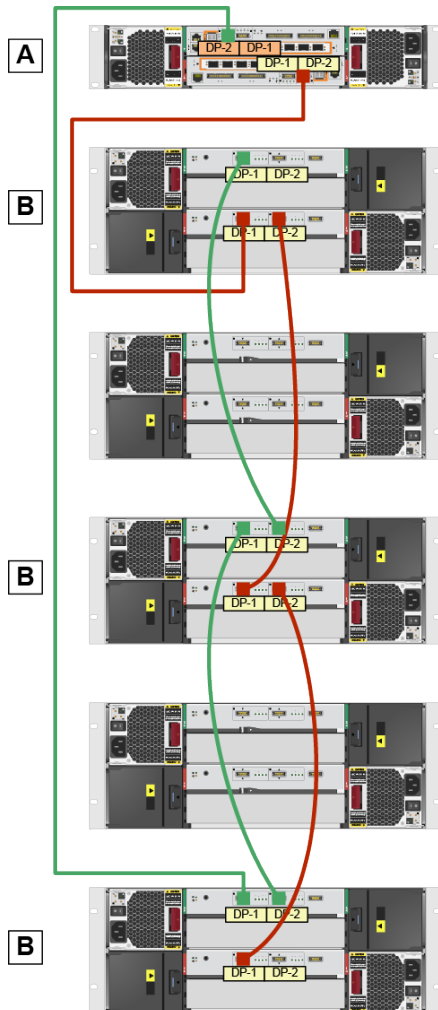

Review Completed Cabling

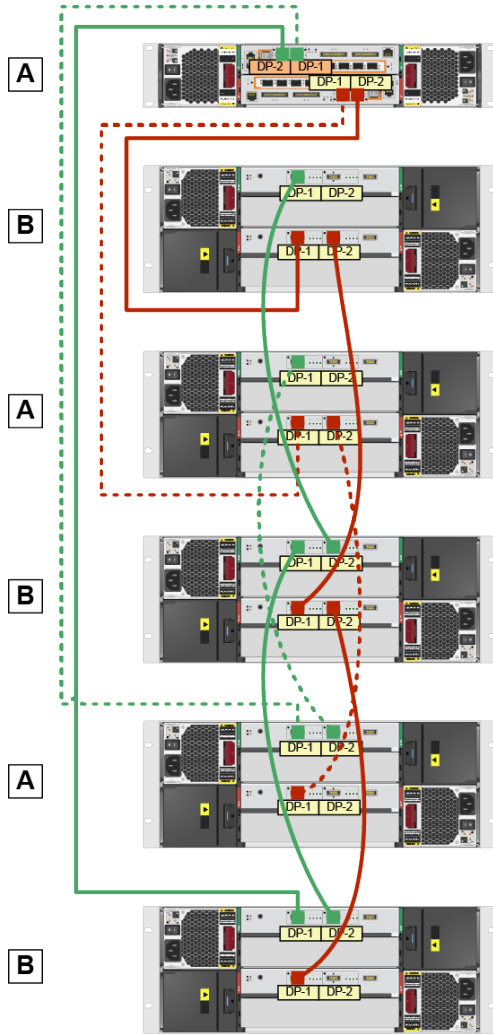
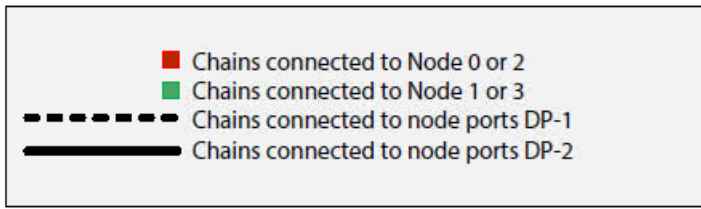

2 Node 6 Drive Enclosures (6L)

Before you begin cabling the storage system, carefully read or print the following section, including figures 1 and 2, "Identifying and Labeling the Components" (page 4).

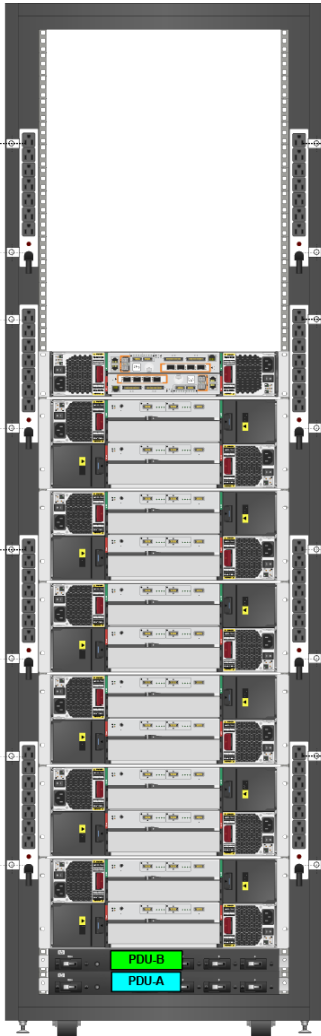

Attach DP-1 Chains to Enclosures

Red routing

1. Connect **Node 0 (DP-1)** to the **I/O 0 (DP-1)** on the **A** drive enclosure closest to the controller.
2. Connect all **A** drive enclosures from **(DP-2) to (DP-1) working away from the controller.**

Green routing

1. Connect **Node 1 (DP-1)** to **I/O 1 (DP-1)** on the **A** drive enclosure farthest from the controller.
2. Connect all **A** drive enclosures from **(DP-2) to (DP-1) working toward the controller.**

NOTE: The two adjacent enclosures are not directly connected.

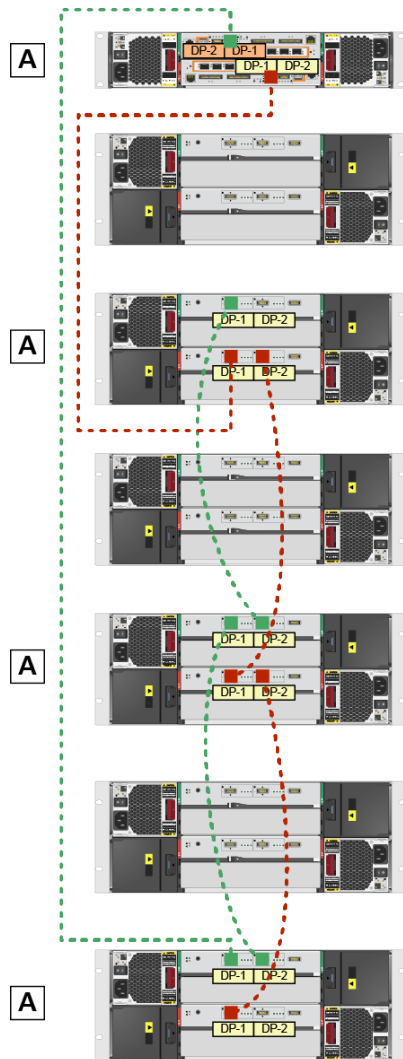

Attach DP-2 Chains to Enclosures

Red routing

1. Connect **Node 0 (DP-2)** to the **I/O 0 (DP-1)** on the **B** drive enclosure closest to the controller.
2. Connect all **B** drive enclosures from **(DP-2) to (DP-1) working away from the controller.**

Green routing

1. Connect **Node 1 (DP-2)** to **I/O 1** on the **B** drive enclosure farthest from the controller.
2. Connect all **B** drive enclosures from **(DP-2) to (DP-1) working toward the controller.**

NOTE: The two adjacent enclosures are not directly connected.

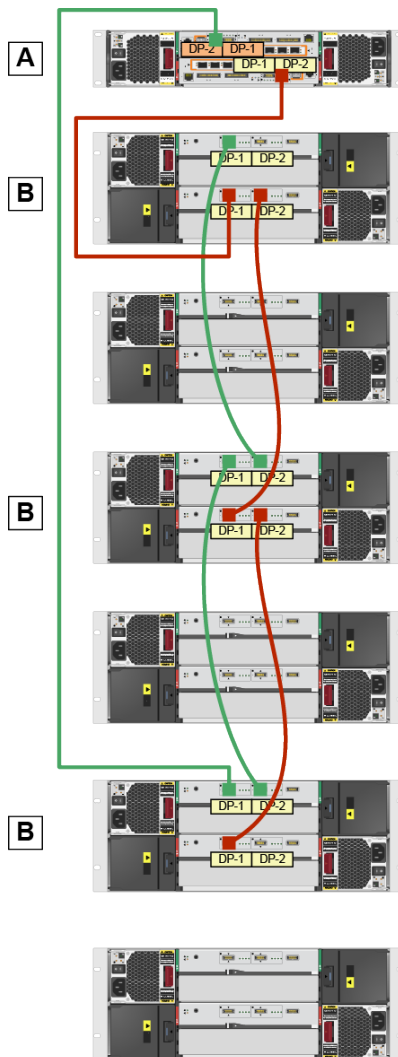

Review Completed Cabling

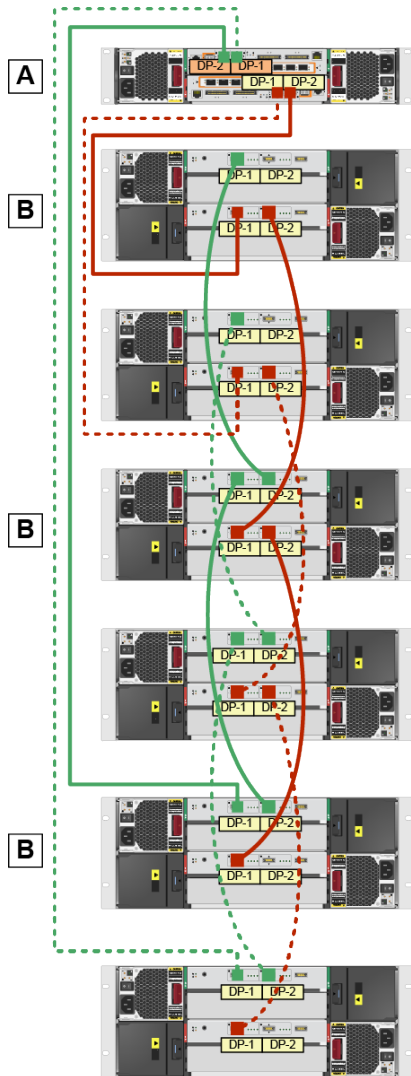
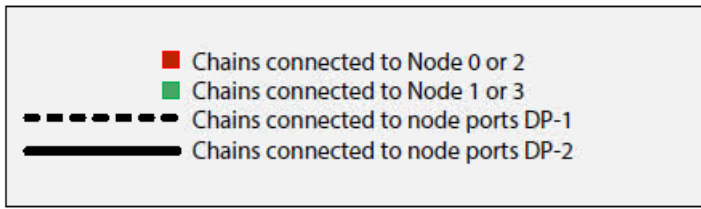

2 Node 7 Drive Enclosures (7L)

Before you begin cabling the storage system, carefully read or print the following section, including figures 1 and 2, "Identifying and Labeling the Components" (page 4).

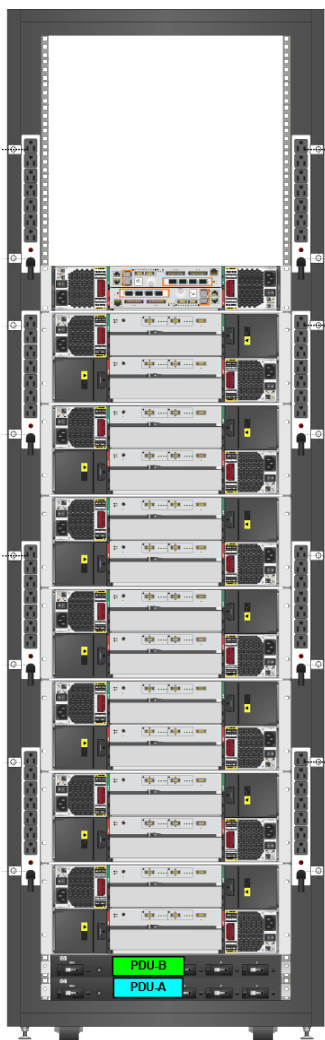

Attach DP-1 Chains to Enclosures

Red routing

1. Connect **Node 0 (DP-1)** to the **I/O 0 (DP-1)** on the **A** drive enclosure closest to the controller.
2. Connect all **A** drive enclosures from **(DP-2) to (DP-1) working away from the controller.**

Green routing

1. Connect **Node 1 (DP-1)** to **I/O 1 (DP-1)** on the **A** drive enclosure farthest from the controller.
2. Connect all **A** drive enclosures from **(DP-2) to (DP-1) working toward the controller.**

NOTE: The two adjacent enclosures are not directly connected.

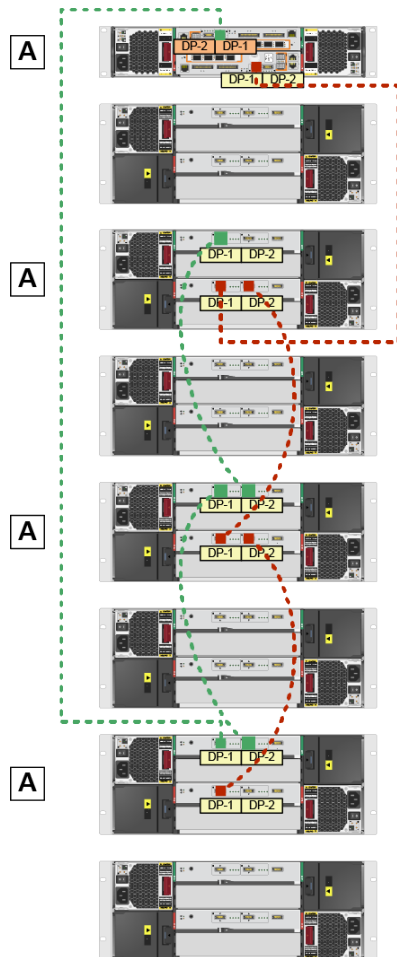

Attach DP-2 Chains to Enclosures

Red routing

1. Connect **Node 0 (DP-2)** to the **I/O 0 (DP-1)** on the **B** drive enclosure closest to the controller.
2. Connect all **B** drive enclosures from **(DP-2) to (DP-1) working away from the controller.**

Green routing

1. Connect **Node 1 (DP-2)** to **I/O 1** on the **B** drive enclosure farthest from the controller.
2. Connect all **B** drive enclosures from **(DP-2) to (DP-1) working toward the controller.**

NOTE: The two adjacent enclosures are not directly connected.

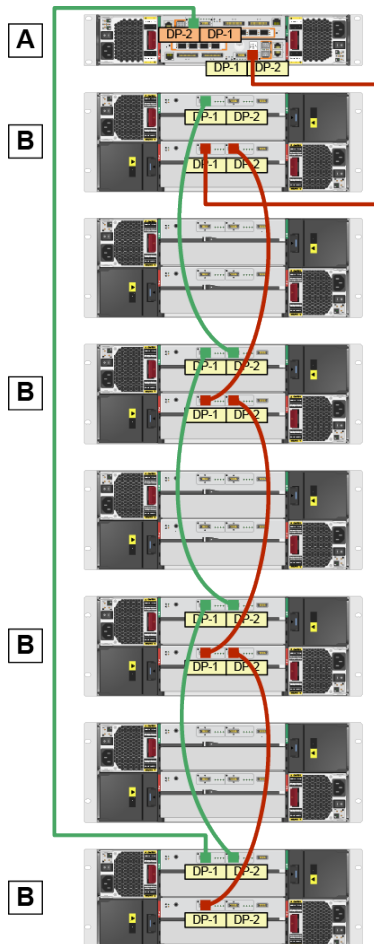

Review Completed Cabling

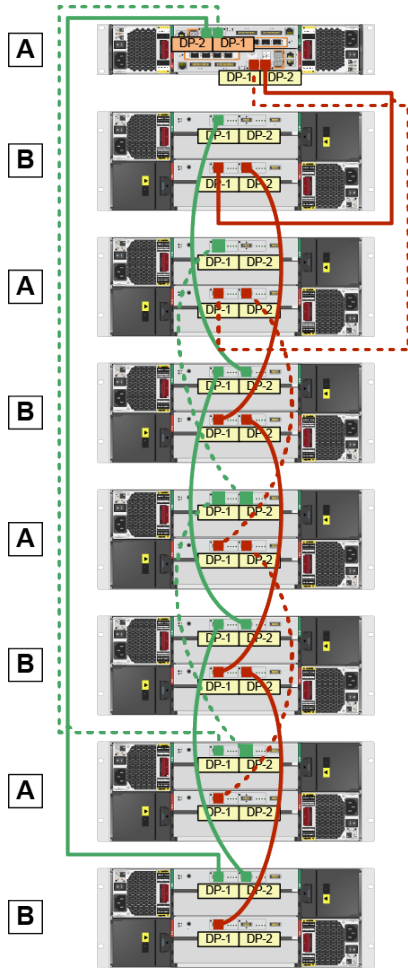
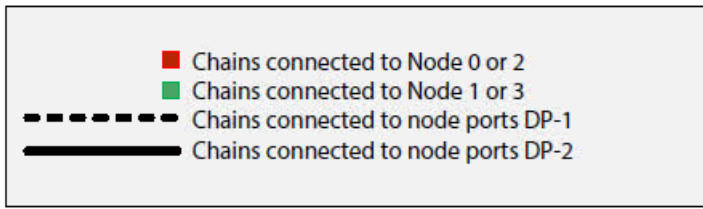

2 Node 8 Drive Enclosures (8L)

Before you begin cabling the storage system, carefully read or print the following section, including figures 1 and 2, "Identifying and Labeling the Components" (page 4).

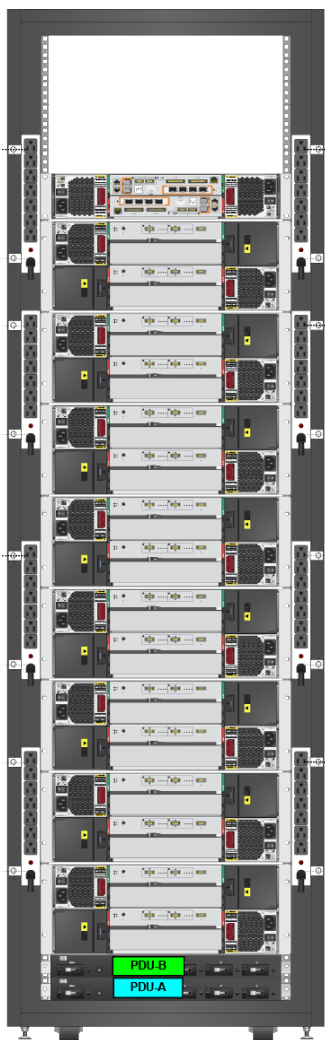

Attach DP-1 Chains to Enclosures

Red routing

1. Connect **Node 0 (DP-1)** to the **I/O 0 (DP-1)** on the **A** drive enclosure closest to the controller.
2. Connect all **A** drive enclosures from **(DP-2) to (DP-1) working away from the controller.**

Green routing

1. Connect **Node 1 (DP-1)** to **I/O 1 (DP-1)** on the **A** drive enclosure farthest from the controller.
2. Connect all **A** drive enclosures from **(DP-2) to (DP-1) working toward the controller.**

NOTE: The two adjacent enclosures are not directly connected.

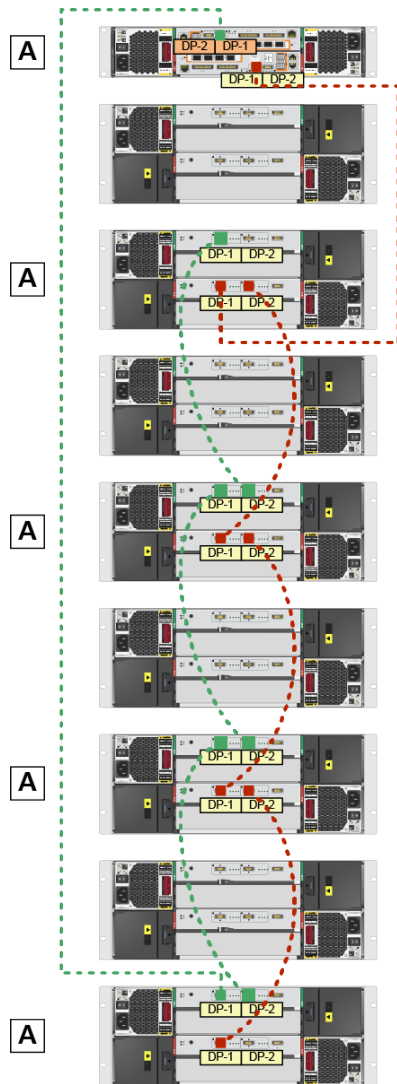

Attach DP-2 Chains to Enclosures

Red routing

1. Connect **Node 0 (DP-2)** to the **I/O 0 (DP-1)** on the **B** drive enclosure closest to the controller.
2. Connect all **B** drive enclosures from **(DP-2) to (DP-1) working away from the controller.**

Green routing

1. Connect **Node 1 (DP-2)** to **I/O 1** on the **B** drive enclosure farthest from the controller.
2. Connect all **B** drive enclosures from **(DP-2) to (DP-1) working toward the controller.**

NOTE: The two adjacent enclosures are not directly connected.

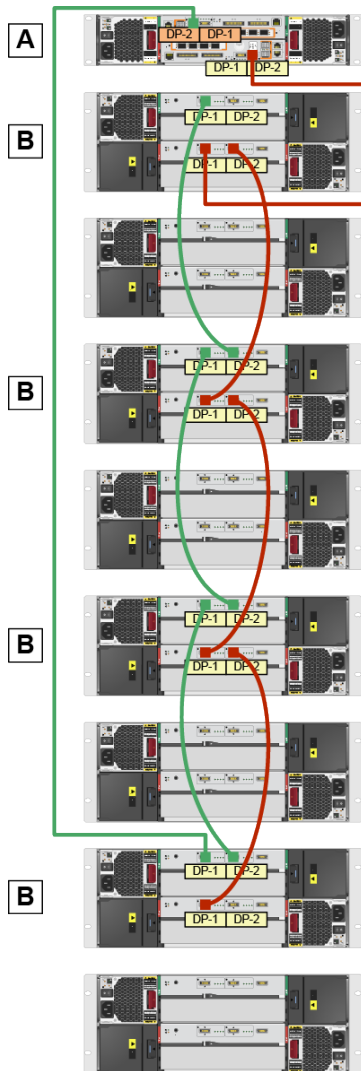

Review Completed Cabling

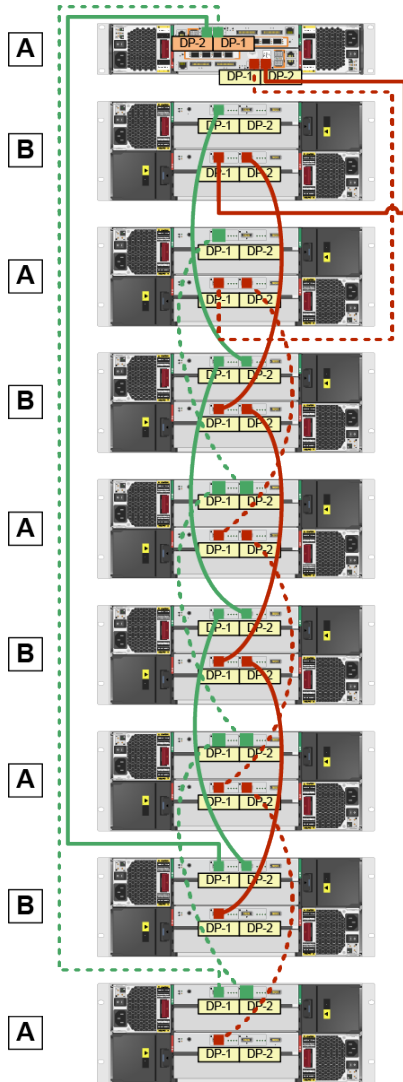
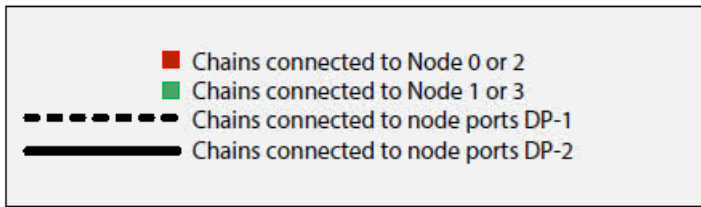

2 Node 9 Drive Enclosures (9L)

Before you begin cabling the storage system, carefully read or print the following section, including figures 1 and 2, "Identifying and Labeling the Components" (page 4).

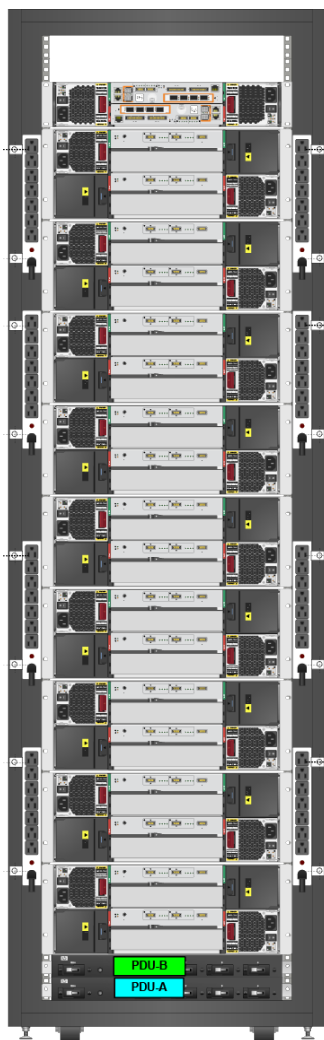

Attach DP-1 Chains to Enclosures

Red routing

1. Connect **Node 0 (DP-1)** to the **I/O 0 (DP-1)** on the **A** drive enclosure closest to the controller.
2. Connect all **A** drive enclosures from **(DP-2) to (DP-1) working away from the controller.**

Green routing

1. Connect **Node 1 (DP-1)** to **I/O 1 (DP-1)** on the **A** drive enclosure farthest from the controller.
2. Connect all **A** drive enclosures from **(DP-2) to (DP-1) working toward the controller.**

NOTE: The two adjacent enclosures are not directly connected.

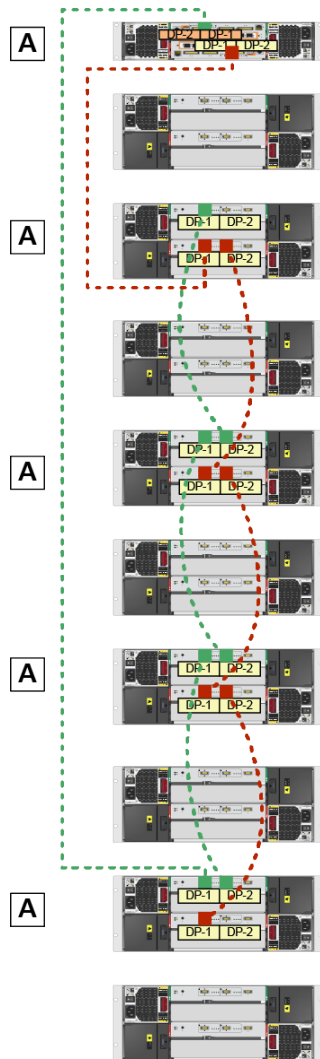

Attach DP-2 Chains to Enclosures

Red routing

1. Connect **Node 0 (DP-2)** to the **I/O 0 (DP-1)** on the **B** drive enclosure closest to the controller.
2. Connect all **B** drive enclosures from **(DP-2) to (DP-1) working away from the controller.**

Green routing

1. Connect **Node 1 (DP-2)** to **I/O 1** on the **B** drive enclosure farthest from the controller.
2. Connect all **B** drive enclosures from **(DP-2) to (DP-1) working toward the controller.**

NOTE: The two adjacent enclosures are not directly connected.

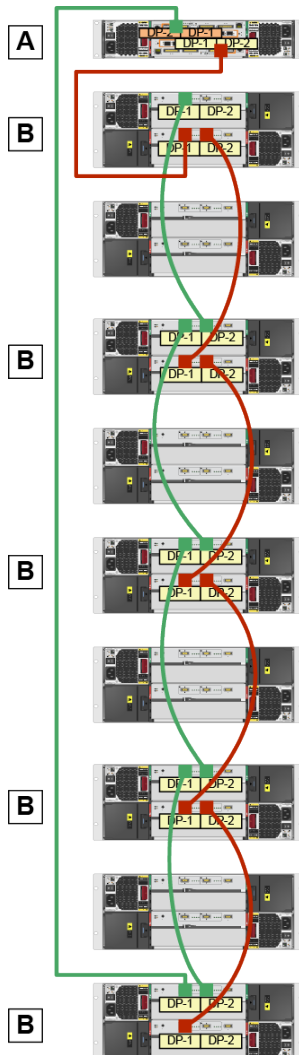

Review Completed Cabling

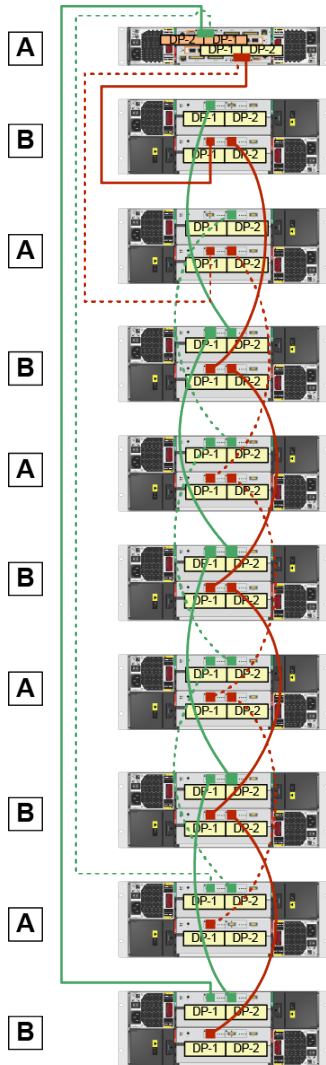
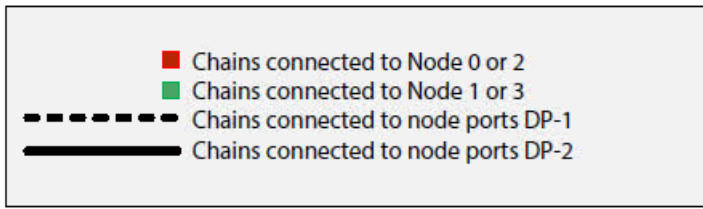

3 Additional Resources and Related Documentation

Contacting HP

For worldwide technical support information, see the HP support website:

<http://www.hp.com/support>

Before contacting HP, collect the following information:

- Product model names and numbers
- Technical support registration number (if applicable)
- Product serial numbers
- Error messages
- Operating system type and revision level
- Detailed questions

Specify the type of support you are requesting:

HP 3PAR Storage System	Support Request
HP 3PAR StoreServ 7200, 7400, and 7450 Storage systems	StoreServ 7000/7450 Storage
HP 3PAR StoreServ 10000 Storage systems HP 3PAR T-Class storage systems HP 3PAR F-Class storage systems	3PAR or 3PAR Storage

HP 3PAR Documentation

For additional information about other related cabling configurations, refer to the following documents:

- *HP 3PAR StoreServ 7000/7450 Storage Cabling Configuration Guide A: 2 Node Systems with Small 2.5-inch Drive Enclosures*
- *HP 3PAR StoreServ 7000/7450 Storage Cabling Configuration Guide B: 2 Node Systems with Large 3.5-inch Drive Enclosures*
- *HP 3PAR StoreServ 7000/7450 Storage Cabling Configuration Guide C: 2 Node Systems with Mixed-Size Drive Enclosures*
- *HP 3PAR StoreServ 7000/7450 Storage Cabling Configuration Guide D: 4 Node Systems with Small 2.5-inch Drive Enclosures*
- *HP 3PAR StoreServ 7000/7450 Storage Cabling Configuration Guide E: 4 Node Systems with Large 3.5-inch Drive Enclosures*
- *HP 3PAR StoreServ 7000/7450 Storage Cabling Configuration Guide F: 4 Node Systems with Mixed-Size Drive Enclosures*

Free Manuals Download Website

<http://myh66.com>

<http://usermanuals.us>

<http://www.somanuals.com>

<http://www.4manuals.cc>

<http://www.manual-lib.com>

<http://www.404manual.com>

<http://www.luxmanual.com>

<http://aubethermostatmanual.com>

Golf course search by state

<http://golfingnear.com>

Email search by domain

<http://emailbydomain.com>

Auto manuals search

<http://auto.somanuals.com>

TV manuals search

<http://tv.somanuals.com>