

HP 974A Multimeter User's Guide

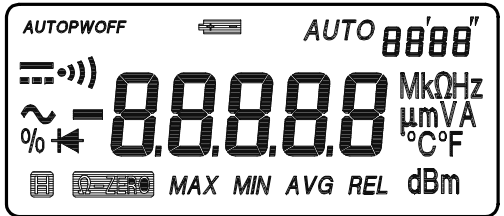

Part Number 00974-90002
March 1995

© Copyright Hewlett-Packard Company 1994, 1995
All Rights Reserved

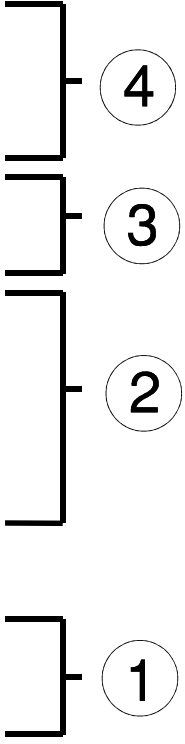
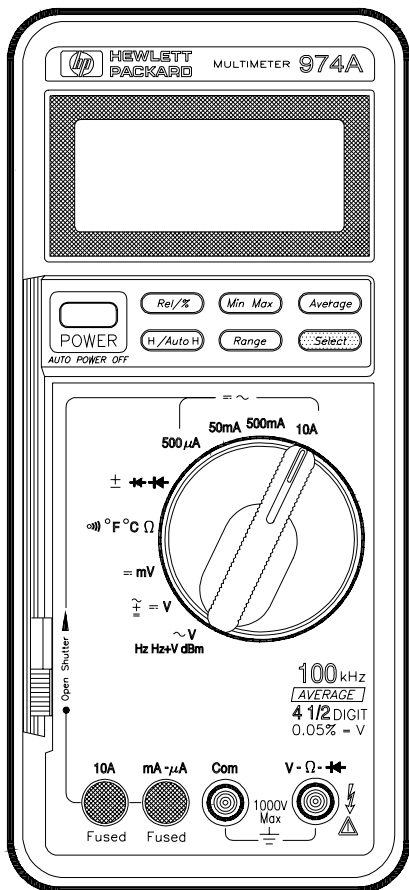

HP 974A Multimeter

Table of Contents

Safety Summary	1-4	Specifications	1-17
Safety Symbols	1-4	General	1-17
Maximum Overvoltage Limitations	1-5	DC Voltage	1-17
Probes and Test Leads	1-6	AC Voltage	1-17
Operation	1-7	AC + DC Voltage	1-18
Terminals, Shutter, & Test Leads	1-7	DC Current, AC Current	1-18
Function Switch	1-8	Resistance	1-19
Function Keys	1-9	Continuity	1-19
Function Keys/Function Switch Matrix	1-12	Diode	1-19
Display	1-13	Frequency (AC Coupled)	1-19
Audio	1-13	Temperature	1-20
Calibration and Adjustment	1-14	dBm	1-20
Required Test Equipment	1-14	Adjustments	6-1
Calibration Procedure	1-14	Calibration Table	6-2
Maintenance	1-15	Replaceable Parts/Accessories	6-4
Battery Replacement	1-15	Disassembly	6-5
Fuse Replacement	1-15	Declaration of Conformity	
Troubleshooting	1-16		
Cleaning	1-16		
Replaceable Parts/Accessories	1-16		

Safety Summary

The CAUTIONS and WARNINGS which appear on the following pages must be followed to ensure operator safety and to retain the operating condition of the Multimeter.

1. Do not use this product beyond its specifications or for uses not intended for this product as identified by the product functions, ranges, and hazards as indicted below.
2. To minimize possible electric shock hazard condition, connect only two leads at any one time to any of the multimeter terminals.
3. To prevent possible electric shock hazard condition when using the current function, do not leave one probe connected to the circuit under test and the other probe disconnected, exposed, and readily accessible (touchable).

Safety Symbols



Indicates the operator must refer to an explanation in this manual.



Indicates terminals at which dangerous voltages may exist.

WARNING



TO AVOID ELECTRICAL SHOCK or damage to the multimeter, do not apply more than ± 1000 Vdc or 1000 Vrms between any terminal and earth ground. Use caution when working with voltages above 60 Vdc or 42 Vpeak. Ensure test leads are in good condition.

WARNING



POSSIBLE ELECTRICAL SHOCK. Do not make measurements if the case is damaged or the rear cover is removed. Remove all electrical inputs before removing the rear cover.

WARNING



POSSIBLE ELECTRICAL SHOCK or FIRE HAZARD. Do not expose this multimeter to rain or moisture. Do not operate the multimeter in the presence of flammable gases or fumes.

**WARNING**

POSSIBLE ELECTRICAL SHOCK. Calibration and performance tests are to be performed by qualified personnel only. Do not attempt calibration or test procedures unless qualified to do so.

**CAUTION**

To avoid damage to the multimeter for inputs above 250 Vdc or Vac, disconnect the test leads before changing functions. Do not exceed the maximum input limits.



Maximum Overvoltage Limitations (AC and DC Voltage Functions)

1000V

MAX indicates the maximum voltage between input terminals and earth is ± 1000 V (dc or ac rms).



Do not use the multimeter on any ACV circuit where the maximum impulse overvoltage may be more than 4000Vpk or any DCV circuit where the maximum impulse overvoltage may be more than 2500Vpk between the COM and VOLT terminals. Excessive impulse overvoltage can damage the multimeter voltage functions. Do not measure branch circuits (CAT II) over 600V to earth or service panel circuits (CAT III) over 300V to earth.

Function	Maximum Operating Input
 10 A	± 10 A (dc or ac rms) / 600 V
 mA or μ A	± 500 mA (dc or ac rms) / 250 V
Resistance, Diode Test, Temperature, Continuity	500 V (dc or ac rms)
Frequency (10 Hz to 9.999 kHz) (9 kHz to 200 kHz)	500 Vrms 100 Vrms
 V	± 1000 Vdc or 750 Vrms

Probes and Test Leads

1. Always inspect probes before use. Do not use test leads whose insulation has cuts, cracks, or other damage that may result in reduced electric shock protection.
2. Keep insulation surface clean between the probe tip connector and the finger guards.
3. If probes other than the ones specified are to be used with the multimeter, be sure the probes and their leads are rated for the voltage and current to which they will be subjected. Do not exceed the voltage ratings for the multimeter.
4. Probes supplied with this multimeter are rated for use up to 1000Vrms or Vdc.

Operation

Terminals, Shutter, & Test Leads

SAFETY SHUTTER

Slide up to **open** shutters for current measurement inputs. Must have the function switch in one of the Current Measurement positions to open shutter. **Close** shutter to change function switch to any other measurement function.

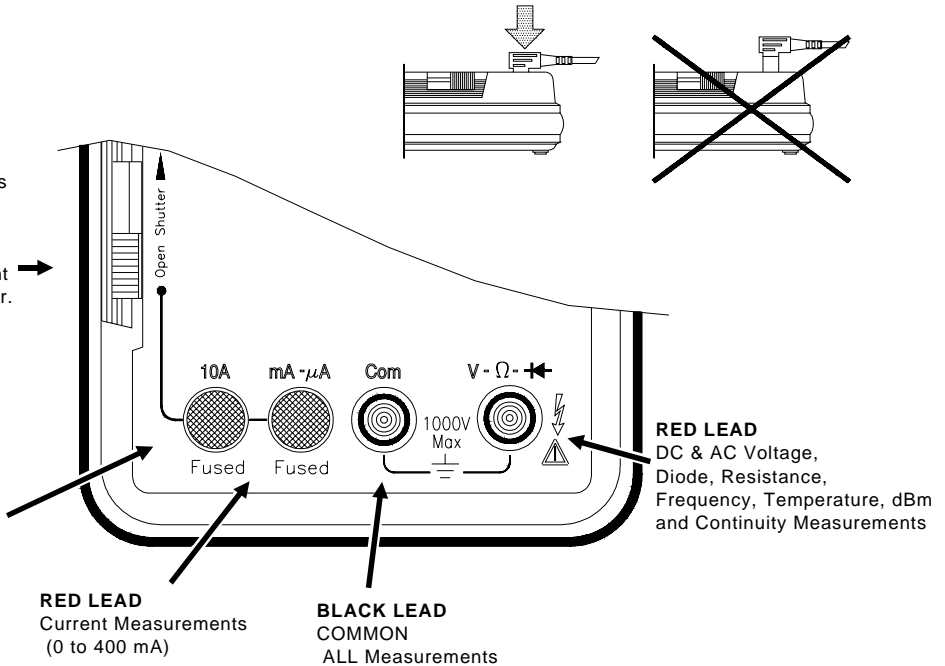

Function Switch

2

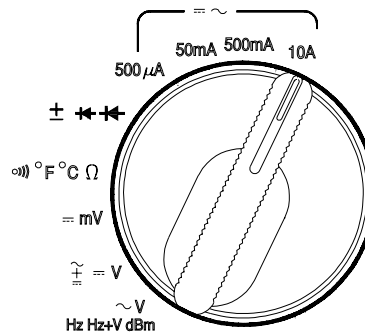

Switch Position	Display	Select	Select	Select
10A	DC Current (1 mA to 10 A)	AC Current (1 mA to 10 A)		
500 mA	DC Current (10 µA to 0.5 A)	AC Current (10 µA to 0.5 A)		
50 mA	DC Current (1 µA to 0.05 A)	AC Current (1 µA to 0.05 A)		
500 µA	DC Current (0.01 µA to 0.5 mA)	AC Current (0.01 µA to 0.5 mA)		
⚡	Diode Test	Auto Diode Test		
Ω	Resistance (0.01 Ω to 50 MΩ)	Continuity (alarm at < 100 Ω)	Temperature in °F (-112° F to 302° F)	Temperature in °C (-80° C to 150° C)
≡mV	DC Millivolts (10 µV to 500 mV)			
≡V	DC Volts (100 µV to 1000 V)	AC + DC Volts (1 mV to 750 V)		
~V	AC Volts (1 mV to 750 V)	Frequency (10 Hz to 200 kHz)	Frequency and Volts ¹ (10 Hz to 200 kHz)	dBm (-59.94 dBm to 62.22 dBm)

¹ Voltage and frequency readings alternate on display

Function Keys



Power

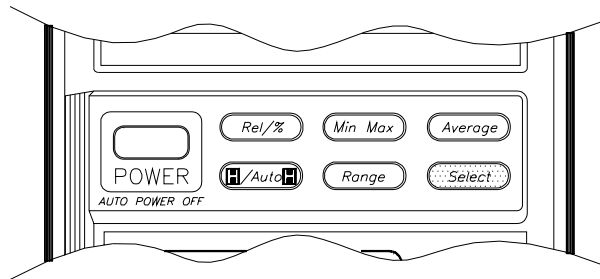

Automatic power off after 30 minutes. Alarm sounds 30 seconds before automatic power off. Press any key or change any function to cancel automatic power off. Defeat automatic power off by holding  key for 2 seconds while applying power.











Relative/Percent

Press	Action	Main Display	Secondary Display
	Makes the displayed measurement the reference	Each measured value relative to the reference value (difference)	Range
	Calculates the percentage change from the reference	Each measured value as a percent change of the reference value	Range
	Cancels the Relative/% function	Measurement value	Range

Perform a **zero adjust** when using the 500 Ω range and displayed value is less than 99 by shorting the test leads and pressing this key. Cycle power to erase the stored zero adjustment.

Operation

Minimum/Maximum ¹



Press	Action	Main Display	Secondary Display ²
	Begin recording of min, max, and avg ³ values	Each measured value	Elapsed time
	Display recorded maximum	Maximum measurement	Time of Maximum
	Display recorded minimum	Minimum measurement	Time of Minimum
	Display recorded average	Calculated average	Elapsed time
	Display last recorded measurement	Latest measurement	Elapsed time
	Pause recording of minimum and maximum values	Last measured value	Total elapsed time
	Resume recording of minimum and maximum values	Each measured value	Elapsed time
 	Press and hold 1 second to cancel	-	-

¹ Automatic power off is disabled when Min/Max is selected.



² Time is recorded and displayed in minutes and seconds up to 99' 59". After 99' 59" time is recorded and displayed in minutes up to the maximum recording time of 1999 minutes. Recording will stop at the maximum time.

³ Average is computed from all readings during elapsed time.

Average





Press	Action	Main Display	Secondary Display
	Makes the displayed measurement the average of the last eight measurements	Average value of last eight measurements	Range
	Disables the averaging of measurements	Each measurement	Range

Hold/Auto-Hold

Press	Action	Main Display	Secondary Display
	Holds the measurement value in the display	Measurement value when hold pressed	Range
	Enters Auto-Hold function ¹	Input value	Range
	Cancels Hold function	Measurement value	Range

¹ Auto-Hold Operation. When measurement becomes stable, multimeter will beep and save the stable reading. Removing probe from measurement circuit will display and hold the last stable reading.

Range

Press	Action	Main Display	Secondary Display
	Changes from auto-ranging to manual ranging	Measurement value	Range
	Change manual range UP once with each keypress ¹	Measurement value	Range
 	Returns to auto-ranging when key is held for 1 second	Measurement value	Range

¹ When upper range is reached, the sequence begins again at the lowest range.

Select



Press this key to use the functions indicated in yellow on the multimeter. See table on page 1- 8. Hold this key to test display when turning meter on.

Function Keys and Function Switch Matrix

Function	Relative	% (Percent)	Min/Max ³	Average	Data Hold	Auto-Hold	Range
μA, mA, 10A	●	●	●	●	●	●	
μA, mA, 10A	●	●	●	●	●	●	
	●	●	●		●	●	
					●		
Ω	● ¹	●	●	●	●	●	●
					●		
°F, °C	●		●		●		
mV	●	●	●	●	●		
V	●	●	●	●	●	●	●
					●		●
V	●	●	●	●	●	●	●
Hz Hz+V					●		● ²
dBm	●				●		

¹ Invokes zero adjust when display is less than 99.

² Changes input attenuator, frequency is always auto range.

³ Secondary display shows elapsed time (in seconds and minutes).

Display

Low Battery indicator

Replace batteries when on.

Main Display

(Not all annunciators shown)

Number of digits is set by range and function
Displays O.L to indicate an overload condition
Entire display flashes if input overvoltage

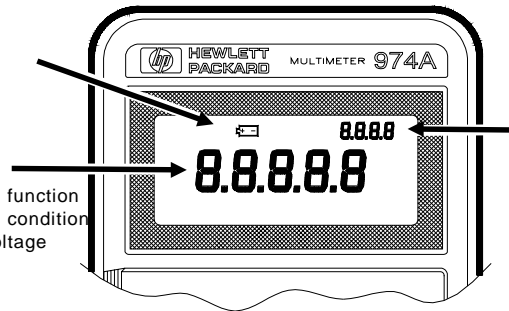

Secondary Display

Shows:

Range (most functions)
except for
Elapsed time (Min/Max)

Audio

	<p>Power on First beep at power on. Second beep when beginning to make measurements.</p>
	<p>Single beep Indicates any valid function key press. Indicates a new High or Low value recorded when in Min/Max function.</p>
	<p>Steady repeating beep Indicates when measurement is steady when using Auto-Hold function.</p>
	<p>Rapid repeating beeps Indicates wrong input terminals used for function selected. Indicates an overload condition at the measurement terminals.</p>
	<p>Continuous tone Indicates a resistance of < 100 Ω when using the Continuity function.</p>
	<p>Auto Power Off Pairs of beeps for 30 seconds. Long beep just before power off. Cancel by changing function switch position or pressing any key.</p>

Calibration and Adjustment

Required Test Equipment

The source used for the calibration should have an output accuracy as good or better than that listed in the specifications.

Calibration Procedure

Environmental range for calibration: $23^{\circ}\text{C} \pm 5^{\circ}\text{C}$, < 80% RH

Calibration interval: 6 Months

- 1 Disconnect all inputs from the multimeter and open the case as described on page 6-5.
- 2 Install new batteries (described below) and close the cover. Turn the multimeter on and allow a 30 minute warm-up. Open the case.
- 3 Set the multimeter function and range and the source output to the values specified at each step in the calibration table on page 6-2.
- 4 When appropriate, make the adjustments indicated in the calibration table to bring the multimeter display within the limits.

CAUTION



Dangerous voltages are present during the calibration procedure. Calibration should only be performed by qualified service technicians Use a non-conductive adjustment tool.

Maintenance

Operator protection from electric shock hazard is provided by a double insulated enclosure. Refer to pages 1-4 and 1-5 for maximum voltage specifications. When servicing, use only specified replacement parts.

Battery Replacement

Replace the battery when the symbol appears in the display or before calibration. Replace both batteries at the same time. Use high-quality type AA alkaline (IEC LR6) batteries. Remove the batteries if the multimeter is to be stored for extended periods of time. Refer to the disassembly drawing on page 6-5.

Fuse Replacement

Fuse locations are shown in the diagram on page 6-5. Fuses are listed in the replaceable part list on page 6-4.



CAUTION

For continued protection use only the specified manufacturers part number or HP part number fuse for replacement purposes.

Troubleshooting

Problem	Possible Cause	Suggested Action
Unit won't turn on	Dead Batteries	Replace batteries
Unit won't turn off	Input limit exceeded	Remove test leads and press any key to reset.
Display flashes and Rapid beeps	Input limit exceeded	Remove test leads and press any key to reset.
Battery Annunciator on	Low battery voltage	Replace batteries
Unable to measure current 10 A or mA - μ A	Blown input protection fuse	Replace fuse(s)

Cleaning

Wipe instrument with a soft rag dampened with soap and water. Do not immerse in water. Do not use chemical cleansers or solvents.

Replaceable Parts/Accessories

Refer to the disassembly diagram on page 6-5.

Specifications

Calibration period: six months minimum. Specifications apply at 23°C ± 5°C, < 80% RH
 Accuracy = ± (% of reading + number of digits)
 Temperature Coefficient = Accuracy 0.1/° C (0° C to 18° C; 28° C to 55° C)

General

Do not expose product to moisture or rain. Do not use product in flammable atmosphere.

Operating Temperature: 0° to 40°C / 80% RH max (no condensation).
 Storage Temperature: -25°C to 60°C / 20% to 70°C RH (no condensation).

Display reading rate: Approximately 2 — 4 times/second
 Display rate for frequency measurements: Approximately 1 times/second
 Battery life: Approximately 120 hours on DCV

DC Voltage

Range	Resolution	Accuracy	Input Resistance
500 mV	10 µV	± (0.05% + 2)	> 1000 MΩ
5 V	100 µV		11 MΩ (nominal)
50 V	1 mV		10 MΩ (nominal)
500 V	10 mV		
1000 V	100 mV		

Normal Mode Rejection Ratio: (NMR) > 60 dB @ 50 or 60 Hz
 Effective Common Mode Rejection Ratio (CMR) 1 kΩ imbalance: > 120 dB @ 50 or 60 Hz

AC Voltage (RMS responding, calibrated to display rms)

Range	Resolution	Accuracy					Input Impedance (nominal)
		20 Hz to 50 Hz	50 Hz to 10 kHz	10 kHz to 30 kHz	30 kHz to 50 kHz	50 kHz to 100 kHz	
500 mV	10 µV	± (1% + 30)	± (0.7% + 30)	± (2% + 50)	Not Specified		11 M Ω < 50 pF
5 V	100 µV		± (0.5% + 30)	± (1% + 40)	± (2% + 70)	± (3% + 300)	
50 V	1 mV						
500 V	10 mV	± (1% + 30)	20 Hz to 1 kHz	Not Specified		10 M Ω < 50 pF	
750 V	100 V						

Specifications

AC + DC Voltage (rms responding, computed from acV, dcV)

Range	Resolution	Accuracy			
		DC, 20 Hz to 10 kHz	DC, 10 kHz to 30 kHz	DC, 30 kHz to 50 kHz	DC, 50 kHz to 100 kHz
5 V	1 mV	± (1% + 30)	± (1.2% + 40)	± (2.5% + 70)	± (3.5% + 300)
50 V	10 mV				
500 V	100 mV				
750 V	1 V	± (1% + 30) DC, 20 Hz to 1 kHz	Not Specified		

Measurement range:

500 mV to 500 V ranges	20 Hz to 30 kHz	5% to 100% of range
	30 kHz to 100 kHz	10% to 100% of range
750 V range		75 V to 750 V

Response time: < 2 seconds for AC, 5 seconds for AC+DC on fixed range

Crest factor: <3

Common Mode Rejection Ratio (CMR) 1 k Ω imbalance: > 60 dB @ DC to 60 Hz

DC Current, AC Current (40 Hz to 1 kHz), 5% to 100% of range

Range	Resolution	DC Current Accuracy	AC Current Accuracy	Input Resistance	Maximum Input
500 μA	10 nA	± (0.3% + 2)	± (1% + 20)	< 1050 Ω	0.5 A (fused)
50 mA	1 μA			< 12 Ω	
500 mA	10 μA			< 2.5 Ω	
10 A	1 mA	± (0.7% + 2)		< 0.05 Ω	15 A (fused)

Resistance

Range	Resolution	Accuracy	Test Current	Max Open Circuit Voltage
500 Ω	10 m Ω	$\pm (0.06\% + 2)$ ¹	< 800 μ A	< 5.5 V
5.0 k Ω	100 m Ω	$\pm (0.06\% + 2)$		
50 k Ω	1 Ω		< 80 μ A	< 2.2 V
500 k Ω	10 Ω		< 15 μ A	
5.0 M Ω	100 Ω		$\pm (0.5\% + 1)$	
50 M Ω	1 k Ω	$\pm (1.0\% + 2)$	< 150 nA	

¹ After zero adjust of input leads. Zero adjust range up to 0.99 Ω .
Response time: 500 Ω to 500 k Ω — < 2 seconds, 5 M Ω to 50 M Ω — < 10 seconds.

Continuity

Measurement Current: 0.8 mA maximum
Displayed resistance: 0 Ω to 499.99 Ω
Alarm: Tone when input < 100 Ω \pm 50 Ω

Open circuit voltage: < 5.5 Vpeak
Input protection: 500 Vrms (sinewave)
Resolution: 10 m Ω (<100 mSec response time)

Diode

Measurement current: +1.0 mA nominal @ 0.6 V
Displayed Voltage: 0 V to 4.999 V
Accuracy: $\pm (1\% + 2)$

Open circuit voltage: < 5.5 Vpeak
Input protection: 500 Vrms (sinewave)
Resolution: 100 μ V

Frequency (AC Coupled)

Frequency Range	Resolution	Accuracy	Input Voltage (rms)
10 Hz to 99.99 Hz	0.01 Hz	$\pm (0.05\% + 1)$	0.45 mV to 500 V
90 Hz to 999.0 Hz	0.1 Hz		
900 Hz to 9.999 Hz	1 Hz		.7 V to 100 V
9.00 kHz to 99.99 kHz	10 Hz		
90 kHz to 200 kHz	100 Hz		

Specifications

Temperature (5 k Ω @ 25°C Thermistor probe)

	°C	°F
Measurement Range	-80° to 150°	-112° to 302°
Resolution	0.1°	0.1°
Accuracy ¹	$\pm 0.2^\circ$	$\pm 0.4^\circ$

¹ Accuracy does not include 5 k Ω Thermistor error

dBm 600 Ω 1 mW reference (rms responding, computed from AC Voltage)

Input dBm	Input Voltage	Accuracy			
		20 Hz to 10 kHz	10 kHz to 30 kHz	30 kHz to 50 kHz	50 kHz to 100 kHz
-29.82 dBm to -23.80 dBm	25 mV to 50 mV	± 0.2 dBm	± 0.50 dBm	Not specified	
-23.80 dBm to -3.80 dBm	50 mV to 499.99 mV	± 0.15 dBm	± 0.30 dBm		
-3.80 dBm to 55.28 dBm	0.5 V to 450.00 V	± 0.10 dBm	± 0.20 dBm	± 0.5 dBm	± 1.00 dBm
55.28 dBm to 59.72 dBm	450 V to 750 V	± 0.15 dBm to 1kHz	Not specified		

Dynamic range: -59.94 dBm to 59.72 dBm (0.8 mV to 750 V),

Accuracy not specified below -29.82 dBm (25 mV)

Display reads OL (overload) outside dynamic range

Adjustments

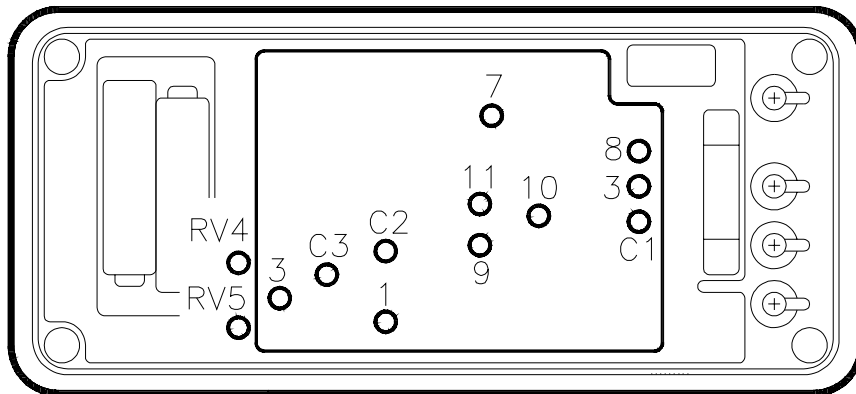

Calibration Table



CAUTION

Dangerous voltages are present during the calibration procedure. Calibration should only be performed by qualified service technicians using a non-conductive tool.

Step	Function	Range	Input Signal	Adjustment (limit)	Tolerance (counts)	
1	⎓ 500 mV	500 mV	Short	—	±2	
2			480.0 mV	1 (±2)	±26	
3			-480.0 mV	—	±26	
4	⎓ V	50 V	48.000 V	2 (±2)	±26	
5			-48.000 V	—	±26	
6		5 V	4.800 V	3 (±2)	±26	
7		500 V	480.00 V	RV4 (±2)	±26	
8		1000 V	1000 V	RV5 (±1)	±7	
9*	~ V	5 V	4.8000 V @ 200 Hz	6 (±10)	±270	
10*			0.2500 V @ 200 Hz	7 (±5)	±42	
11	~	500 mV	480.0 mV @ 200 Hz	8 (±10)	±366	
12			500 V	480.00 V @ 10 kHz	C1 (±20)	±270
13				480.00 V @ 100 kHz	—	±1740
14		480.00 V @ 200 Hz		—	±270	
15		5 V	4.8000 V @ 10 kHz	C2 (±20)	±270	
16			4.8000 V @ 100 kHz	—	±1740	

*Repeat steps 9 and 10.

Step	Function	Range	Input Signal	Adjustment (limit)	Tolerance (counts)
17	V	50 V	48.000 V @ 10 kHz	C3 (± 20)	± 270
18			48.000 V @ 100 kHz	—	± 1740
19			48.000 V @ 200 Hz	—	± 270
20		500 mV	480.00 mV @ 10 kHz	—	± 366
21		750 V	750.0 V @ 200 Hz	—	± 105
22	Ω	500 Ω	Short	zero adjust ¹	± 1
23			480.00 Ω	9 (± 5)	± 30
24		5 k Ω	4.8000 k Ω	—	± 30
25		50 k Ω	48.000 k Ω	—	± 30
26		500 k Ω	480.00 k Ω	—	± 30
27		5 M Ω	4.8000 M Ω	—	± 242
28		50 M Ω	48.000 M Ω	—	± 482
29	500 μ A	500 μ A	Short	—	± 2
30			480.00 μ A	—	± 146
31	50 mA	50 mA	48.000 mA	—	± 146
32	500 mA	40 mA	480.00 mA	—	± 146
33	10 A	10 A	10.000 A	10 (± 10)	± 72
34	500 μ A	500 μ A	480.00 μ A @ 200 Hz	—	± 500
35	50 mA	50 mA	48.000 mA @ 200 Hz	—	± 500
36	500 mA	500 mA	480.00 mA @ 200 Hz	—	± 500
37	10 A	10 A	10.00 A @ 200 Hz	—	± 120
38	o)))	500 Ω	0 Ω to 150 Ω	—	Tone < 100 Ω
39	*	5 V	1.000 V	—	± 102
40	Hz	5 V	9.000 kHz @ 1 Vrms	—	± 5

¹ Perform zero adjustment using  key.

Replaceable Parts/Accessories

Refer to the disassembly diagram on page 6-5.

Call out	Description	HP Part Number
F1	Fuse, 500 mA, 250 V fast blow Littlefuse 216-500 DO NOT SUBSTITUTE	2110-0940
F2	Fuse, 15 A, 600 V fast blow Littlefuse KLK15 DO NOT SUBSTITUTE	2110-0941
MP1	Top case assembly	00974-64401
MP2	Dust/moisture seal	00971-64403
MP3	Bottom case assembly (includes stand)	00974-64402
	Rubber Boot	00971-86001
	Replacement Test Leads, 2 pair	E2305A
	Temperature probe, 5 K Ω Thermistor	E2308A
	Surface temperature sensor, Thermistor $\pm 0.1^{\circ}\text{C}$ 12" lead, requires dual banana plug	40653B
	Soft Case (fits meter with rubber boot)	E2304A

Operator protection from electric shock hazard is provided by a double insulated enclosure. Refer to the Safety Summary for maximum voltage specifications. When servicing, use only specified replacement parts.

Disassembly



WARNING

Always disconnect the test leads before opening the case.

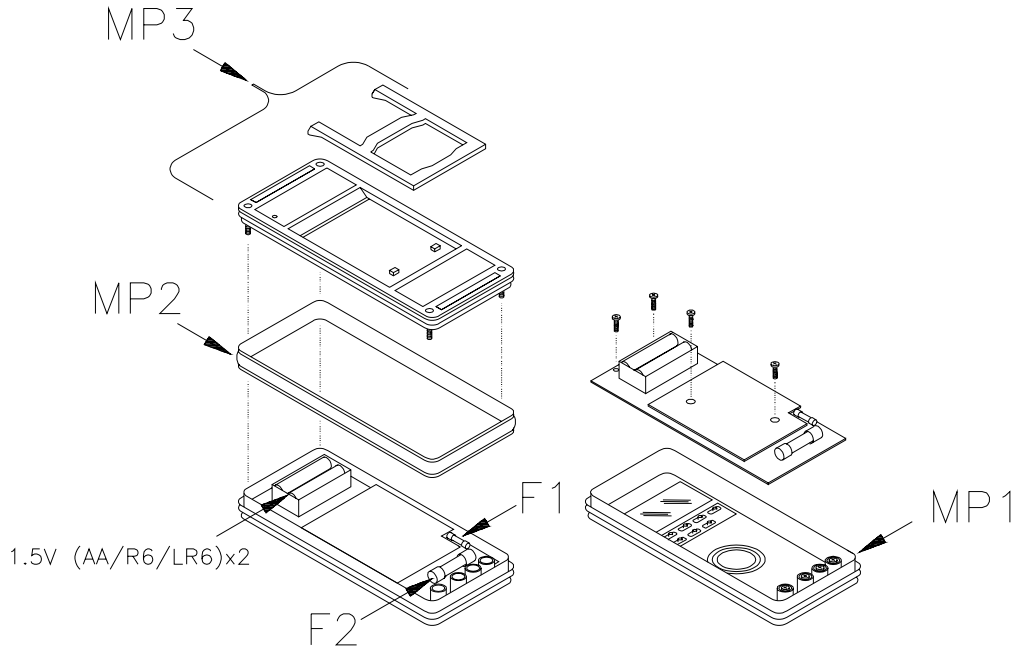

DECLARATION OF CONFORMITY

according to ISO / IEC Guide 22 and EN 45014

Manufacturer's Name: Hewlett-Packard Company, Personal Measurements Operation
Manufacturer's Address: 815 14th Street S.W., Loveland, Colorado 80537 U.S.A.

declares, that the products

Product Name: Handheld Multimeter
Model Number: HP 971A, HP 972A, HP 973A, HP 974A
Product Options: None

conforms to the following Product Specifications:

Safety: IEC 1010-01 (1990) Incl. Amend 1 (1992) / EN61010 (1993)
CSA C22.2 #1010.1 (1992)
UL 1244

EMC: CISPR 11:1990 / EN55011 (1991): Group 1, Class A
IEC801-2:1991 / EN50082-1 (1992): 4 kV CD, 8 kV AD
IEC 801-3:1984 / EN50082-1 (1992): 3 V/m
IEC 801-4:1988 / EN50082-1 (1992): 0.5 kV Signal Lines

Supplemental Information: The product herewith complies with the requirements of the Low Voltage Directive 73 / 23 / EEC and the EMC Directive 89 / 336 / EEC amended by 93 / 68 / EEC (inclusive 93 / 68 / EEC) and carries the CE mark accordingly.

Loveland, Colorado April 1, 1994



Jim White, QA Manager

European Contact: Your local Hewlett-Packard Sales and Service Office or Hewlett-Packard GmbH, Department ZQ / Standards Europe, Herrenberger Straße 130, D-71034 Böblingen (FAX: +49-7031-143143).

Warranty/Service

Limited 3 Year Warranty

What is Covered

The HP 974A Multimeter is warranted by Hewlett-Packard against defects in materials and workmanship for three years from the date of original purchase. If you sell your unit or give it as a gift, the warranty is automatically transferred to the new owner and remains in effect for the original three year period. During the warranty period, we will repair, or at our option, replace at no charge, a product that proves to be defective, provided you return the product, shipping prepaid, to a Hewlett-Packard service center.

What is Not Covered

This warranty does not apply if the product has been damaged by accident of misuse or as the result of service or modification by other than an authorized Hewlett-Packard service center.

No other express warranty is given. The repair or replacement of a product is your exclusive remedy. ANY OTHER IMPLIED WARRANTY OF MERCHANTABILITY OR FITNESS IS LIMITED TO THE THREE YEAR DURATION OF THIS WRITTEN WARRANTY. Some states, provinces, or countries do not allow the exclusion or limitation or incidental or consequential damages, so the above limitation or exclusion may not apply to you.

The warranty gives you specific legal rights, and you may also have other rights which vary from state to state, province to province, or country to country.

Service

Hewlett-Packard maintains service centers in many countries throughout the world. You may have your unit repaired at a Hewlett-Packard service center any time it needs service, whether the unit is under warranty or not. There is a charge for repairs after the warranty period. Repair or replacement during the first 30 days after purchase will be provided by the sales channel. After 30 days, contact the nearest service office.

Hewlett-Packard products normally are repaired and reshipped within five (5) working days of receipt at any service center. This is an average time and could possibly vary depending upon the time of year and work load at the service center. The total time you are without your unit will depend largely on the shipping time.

Free Manuals Download Website

<http://myh66.com>

<http://usermanuals.us>

<http://www.somanuals.com>

<http://www.4manuals.cc>

<http://www.manual-lib.com>

<http://www.404manual.com>

<http://www.luxmanual.com>

<http://aubethermostatmanual.com>

Golf course search by state

<http://golfingnear.com>

Email search by domain

<http://emailbydomain.com>

Auto manuals search

<http://auto.somanuals.com>

TV manuals search

<http://tv.somanuals.com>