

Contents

Programming HP VXI Instruments Common Commands and the Status System

Edition 1

Chapter 1	
Introduction	5
 Chapter 2	
Programming the Status System	7
About this Chapter	7
General Status Register Model	7
Condition Register	8
Transition Filter	8
Event Register	8
Enable Register	8
An Example Sequence	8
Required Status Groups	10
Status Byte	11
Standard Event Group	12
Standard Operation Status Group	13
Questionable Data Group	14
Status System Programming Examples	15
Handling SRQs	15
Using MAV to Determine When Data is Available	15
Example Program	16
Using a Service Request to Detect Errors	18
Example Program	19
 Chapter 3	
Command Reference	23
About this Chapter	23
STATus	24
Subsystem Syntax	24
:OPERation :CONDition?	24
Comments	24
Example	24
:OPERation:ENABle	24
Parameters	24
Comments	24
Example	24
:OPERation:ENABle?	25
Comments	25
Example	25
:OPERation[:EVENT]?	25
Comments	25
Example	25
:PRESet	25
Example	25
:QUEStionable :CONDition?	25
Comments	26

Example	26
:QUEStionable:ENABle	26
Parameters	26
Comments	26
Example	26
:QUEStionable:ENABle?	26
Comments	26
Example	26
:QUEStionable[:EVENT]?	26
Comments	26
Example	27
Common Command Reference.....	28
*CLS	28
*DMC <name_string>, <command_block>	29
*EMC <enable>	29
*EMC?	29
*ESE <mask>	29
Example	29
*ESE?	29
Example	29
*ESR?	29
Example	30
*GMC? <name_string>	30
Example	30
*IDN?	30
Example	30
*LMC?	30
*LRN?	30
*OPC	31
*OPC?	31
*PMC	31
*RMC <name_string>	31
Example	31
*RST	31
*SRE <mask>	32
Example	32
*SRE?	32
Example	32
*STB?	32
Comments	32
Example	32
*TST?	32
Example	32
*WAI	33

This document contains proprietary information which is protected by copyright. All rights are reserved. No part of this document may be photocopied, reproduced, or translated to another language without the prior written consent of Hewlett-Packard Company.

E2090-90021

Notice

The information contained in this document is subject to change without notice.

Hewlett-Packard Company (HP) shall not be liable for any errors contained in this document. HP makes no warranties of any kind with regard to this document, whether express or implied. HP specifically disclaims the implied warranties of merchantability and fitness for a particular purpose. HP shall not be liable for any direct, indirect, special, incidental, or consequential damages, whether based on contract, tort, or any other legal theory, in connection with the furnishing of this document or the use of the information in this document.

Warranty Information

A copy of the specific warranty terms applicable to your Hewlett-Packard product and replacement parts can be obtained from your local Sales and Service Office.

Restricted Rights Legend

Use, duplication or disclosure by the U.S. Government is subject to restrictions as set forth in subparagraph (c)(1)(ii) of the Rights in Technical Data and Computer Software clause of DFARS 252.227-7013.

Use of this manual and magnetic media supplied for this product are restricted. Additional copies of the software can be made for security and backup purposes only. Resale of the software in its present form or with alterations is expressly prohibited.

Copyright © Hewlett-Packard Company 1994

Printing History

This is the first edition of "Programming HP VXI Instruments"

September 1994; First Edition

This Page Intentionally Left Blank

Chapter 1

Introduction

This document describes the common commands and the status system used by VXI instruments. The status system is a group of registers that can be used to monitor events, such as when an error occurs or when a reading is available from a specified instrument in your VXI mainframe. Use the SCPI status system commands and IEEE 488.2 common commands described in Chapter 3 of this document to program the status system.

The common commands are used to read and configure the status byte and standard event group registers, while the status commands are used to configure the standard operation status group and questionable data status group registers. See the individual VXI instrument manuals to determine how a specific instrument uses the operation status group and the questionable data status group. If status system commands are not documented, that instrument does not use the registers.

Other common commands are used for general functionality, macros, and synchronization.

Note This document should be placed with your other VXI instrumentation documentation.

Notes:

Chapter 2

Programming the Status System

About this Chapter

This chapter discusses the structure of the status system used in SCPI instruments and explains how to program status registers. An important feature of SCPI instruments is that they all implement status registers in the same way. The status system is explained in the following sections:

- General Status Register Model

This section explains the way that status registers are structured in SCPI instruments. It also contains an example of how bits in the various registers change with different input conditions.

- Required Status Groups

This section describes the minimum required status registers present in SCPI instruments. These status registers cover the most frequently used functions.

General Status Register Model

The generalized status register model shown in [Figure 2-1](#) is the building block of the SCPI status system. This model consists of a condition register, transition filter, an event register, and an enable register. A set of these registers is called a **status group**.

When a status group is implemented in an instrument, it always contains all of the component registers. However, there is *not* always a corresponding command to read or write to every register.

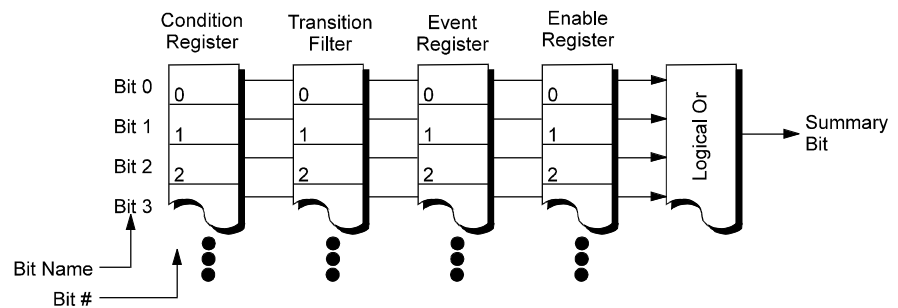

Figure 2-1. Generalized Status Register Model

Condition Register

The **condition register** continuously monitors the hardware and firmware status of the instrument. There is no latching or buffering for this register; it is updated in real time. Condition registers are read-only.

If there is no command to read a particular condition register, it is simply invisible to you.

Transition Filter

The **transition filter** specifies which types of bit state changes in the condition register will set corresponding bits in the event register. Transition filter bits may be set for positive transitions (PTR), negative transitions (NTR), or both. Positive means a condition bit changes from 0 to 1. Negative means a condition bit changes from 1 to 0. Transition filters are read-write. Transition filters are unaffected by *CLS (clear status) or queries. They are set to instrument-dependent values at power on and after *RST (reset).

If there are no commands to access a particular transition filter, it has a fixed setting. This setting is specified in the instrument's programming guide or command dictionary. Most of our VXI instruments assign the transition filter to detect positive transitions only.

Event Register

The **event register** latches transition events from the condition register as specified by the transition filter. Bits in the event register are latched, and, once set, they remain set until cleared by a query or *CLS (clear status). There is no buffering; so while an event bit is set, subsequent events corresponding to that bit are ignored. Event registers are read-only.

Enable Register

The **enable register** specifies which bits in the event register can generate a summary bit. The instrument logically ANDs corresponding bits in the event and enable registers, and ORs all the resulting bits to obtain a summary bit. Summary bits are, in turn, recorded in another register, often the Status Byte. Enable registers are read-write. Enable registers are *not* affected by *CLS (clear status). Querying enable registers does not affect them. There is always a command to read and write to the enable register of a particular status group.

An Example Sequence

[Figure 2-2](#) illustrates the response of a single bit position in a typical status group for various settings. The changing state of the condition in question is shown at the bottom of the figure. A small binary table shows the state of the chosen bit in each status register at the selected times T1-T5.

	PTR	NTR	Enable	Condition	Event	Summary Bit	Condition	Event	Summary Bit	Condition	Event	Summary Bit	Condition	Event	Summary Bit	Condition	Event	Summary Bit
Case A	0	0	0	0	0	0	1	0	0	1	0	0	0	0	0	0	0	0
Case B	0	1	1	0	0	0	1	0	0	1	0	0	0	1	1	0	0	0
Case C	1	0	1	0	0	0	1	1	1	1	0	0	0	0	0	0	0	0
Case D	1	1	0	0	0	0	1	1	0	1	0	0	0	1	0	0	0	0

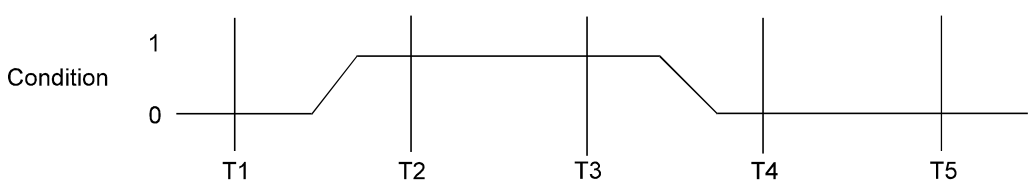

Figure 2-2. Typical Status Bit Changes in a Status Register

Required Status Groups

All SCPI instruments must implement a minimum set of status groups. Some instruments contain additional status groups, consistent with the general status register model. The minimum required status system is shown in Figure 2-3.

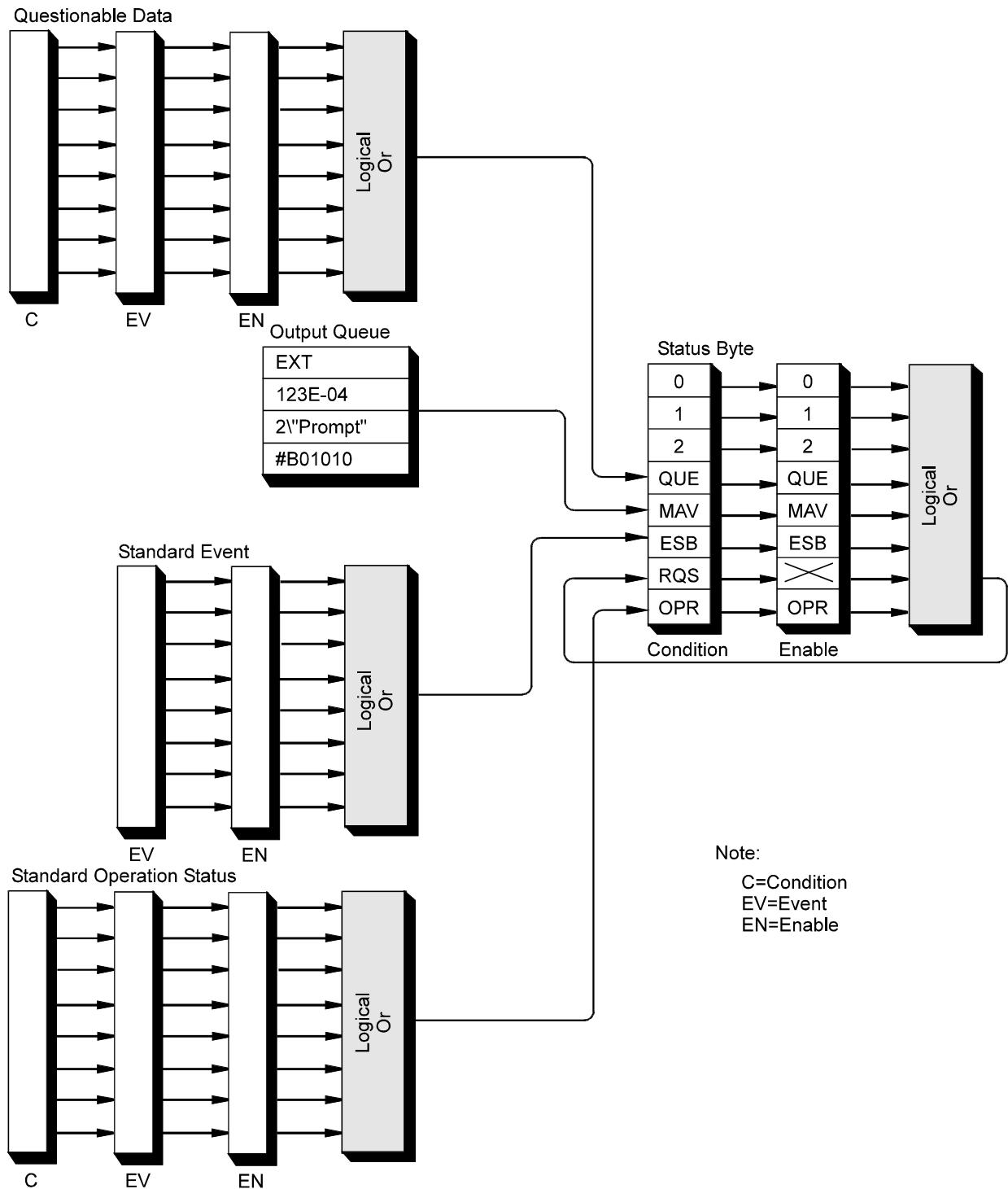

Figure 2-3. Minimum Required Status Register System

The Standard Operation Status and Questionable Data groups are 16 bits wide, while Status Byte and Standard Event groups are only 8 bits wide. In all 16 bit groups, the most significant bit (bit 15) is not used. Bit 15 always returns a zero. The commands that set and query bits in the status registers all use decimal integers. For example, you send *ESE 4 to set bit 2 of the Standard Event enable register. Similarly, a response of "8" to the query *ESE? indicates that bit 3 is set. The remainder of this chapter explains each status group in detail.

Status Byte

As Figure 2-4 indicates, the Status Byte is used to summarize information from all the other status groups. The Status Byte differs from the other groups in the way you read it and how its summary bit is processed.

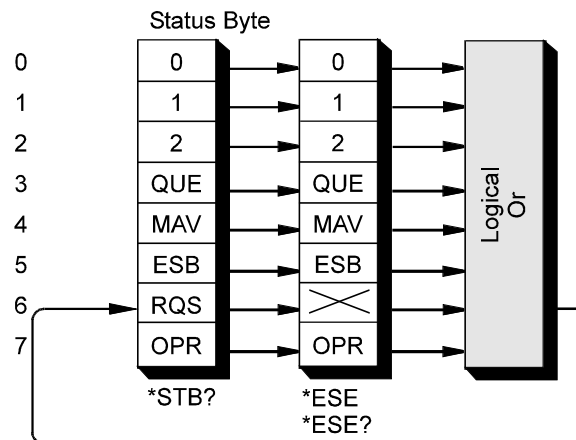

Figure 2-4. Status Byte Register

The Status Byte can be read using either the *STB? common command or by doing a SICL ireadstb function call. The ireadstb function reads the status byte from the device specified.

The Status Byte summary bit actually appears in bit 6 (RQS) of the Status Byte. When bit 6 is set, it generates an SRQ interrupt. This interrupt is a low-level HP-IB message that signals the controller that at least one instrument on the bus requires attention.

There are some subtle differences between *STB? and ireadstb. You can use either method to read the state of bits 0-5 and bit 7. Bit 6 is treated differently depending on whether you use *STB? or ireadstb. With ireadstb, bit 6 returns RQS (request for service) which is cleared after the first ireadstb. *STB? returns the MSS (master state summary). This is the summary bit of the status byte register. It's like a condition bit and will return to zero only when all enabled bits in the status byte are zero. In general, use ireadstb inside interrupt service routines, not *STB?.

Note

In an SRQ interrupt service routine, you must clear the event register which caused the SRQ (for example, STATus:QUES:EVEN?, STATus:OPER:EVEN?, or *ESR?). Failure to do so will prevent future SRQs from arriving.

The meaning of each bit in the Status Byte is explained in the following table.

Table 2-1. Status Byte Bit Definitions

Bit	Name	Description
0		Instrument dependent
1		Instrument dependent
2		Instrument dependent
3	QUE	Summary bit from Questionable Data
4	MAV	Messages available in Output Queue
5	ESB	Summary bit from Standard Event
6	RQS	Service request
7	OPR	Summary bit from Standard Operation Status

Example commands using the Status Byte and Status Byte enable registers:

*SRE 16 *Generate an SRQ interrupt when messages are available.*

*SRE? *Find out what events are enabled to generate SRQ interrupts.*

*STB? *Read and clear the Status Byte event register.*

Standard Event Group

The **Standard Event status group** is frequently used and is one of the simplest. The unique aspect of Standard Event is that you program it using common commands, while you program all other status groups through the STATus subsystem. Standard Event consists of only two registers: the Standard Event event register and the Standard Event enable register. [Figure 2-5](#) illustrates the structure of Standard Event.

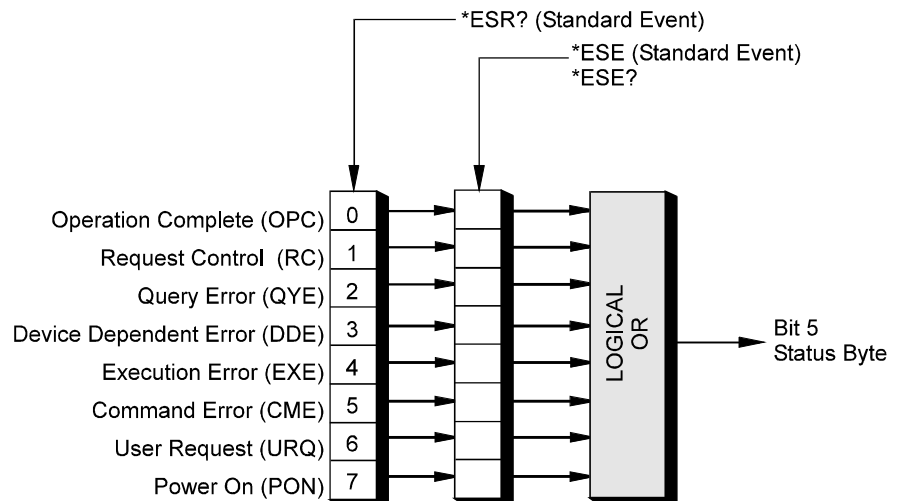

Figure 2-5. Standard Event Status Group

Example commands using Standard Event registers:

*ESE 48 *Generate a summary bit on execution or command errors.*

*ESE? *Query the state of the Standard Event enable register.*

*ESR? *Query the state of the Standard Event event register.*

Standard Operation Status Group

The **Standard Operation Status group** provides information about the state of the measurement systems in an instrument. This status group is accessed through the STATus subsystem. Standard Operation Status includes a condition register, event register, and an enable register. As a beginner, you will rarely need to use this group. [Figure 2-6](#) illustrates the structure of Standard Operation Status.

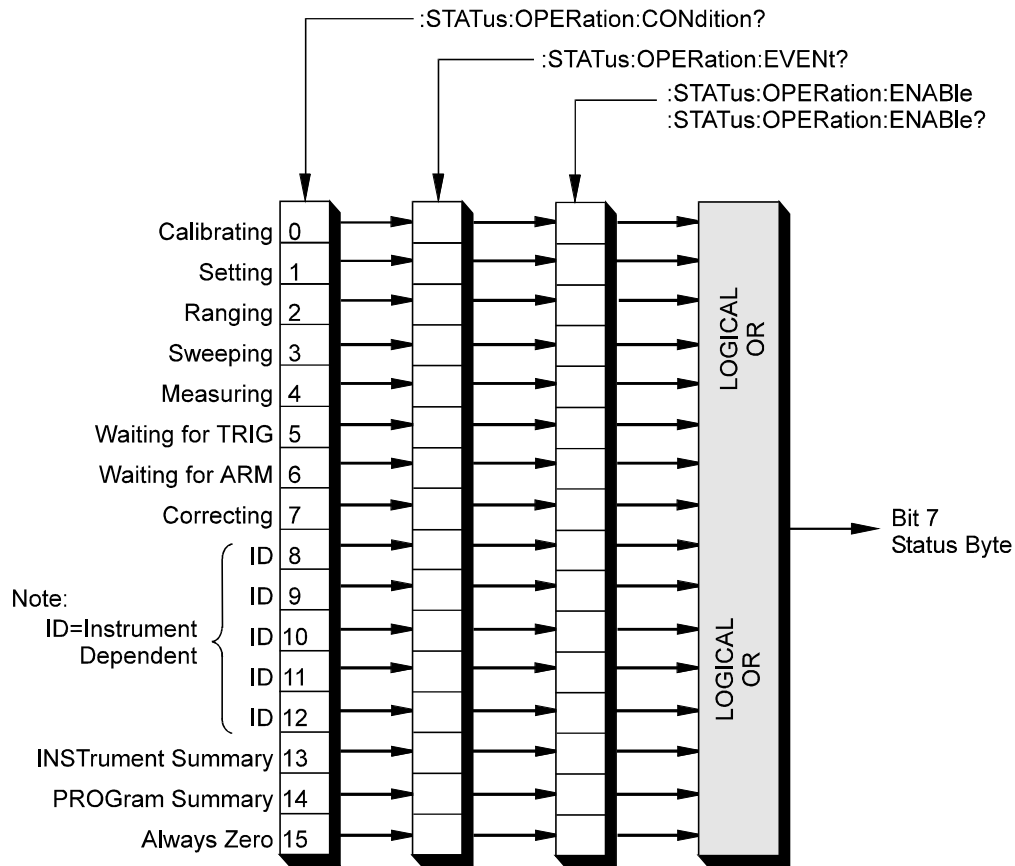

Figure 2-6. Questionable Data Status Group

Questionable Data Group

The **Questionable Data status group** provides information about the quality of instrument output and measurement data. Questionable Data is accessed through the STATus subsystem. As a beginner, you will rarely need to use this status group. [Figure 2-7](#) illustrates the structure of Questionable Data.

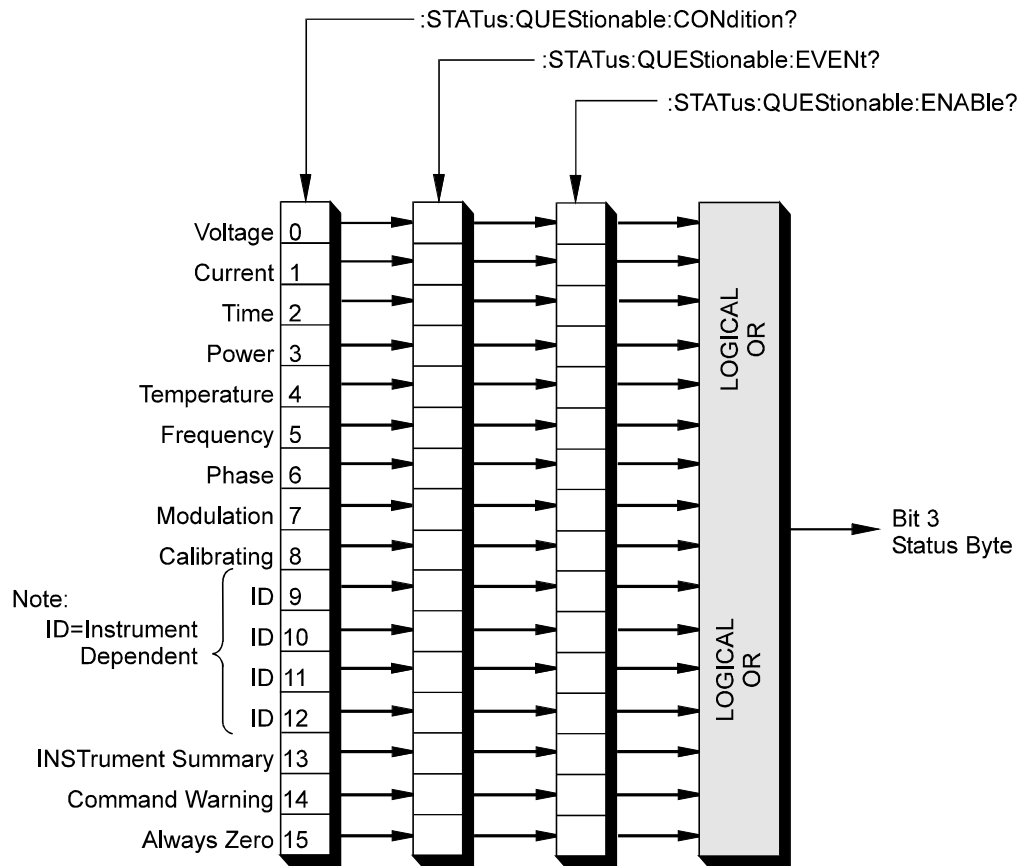

Figure 2-7. Standard Operation Status Group

Status System Programming Examples

This section contains two example programs that use the status system and common commands to monitor when data is available from an instrument and when an error has occurred. Both programming examples are written in C and use the Standard Instrument Control Library (SICL) for I/O operations. The example programs use SCPI (Standard Commands for Programmable Instruments) commands to communicate with the status system. Thus, the instruments must either be message-based or have a SCPI interpreter, such as an HP E1405/06 Command Module or the SICL `iscpi` interface.

Handling SRQs

The following is a general procedure for handling SRQs:

- Define the SRQ handler to do the following:
 - Read the Status Byte using `ireadstb`. `ireadstb` returns the RQS (request for service) bit in bit 6 of the status byte. After issuing a `ireadstb`, RQS is cleared indicating that the Service Request is being acknowledged. A new SRQ will not be issued unless RQS is cleared. Using `*STB?` will return the Master State Summary in bit 6 and does not affect RQS, therefore this should not be used in a SRQ handler.
 - Check the status byte to determine which status group(s) requires service.
 - For each status group that requires service, read the event register of that status group to determine what caused the SRQ to be generated. It is necessary to clear the event register so that if a new event occurs a new SRQ will be generated.
 - Take some action after determining which event caused the SRQ. The action taken is determined by evaluating the contents of the event register.
- Enable SRQ Handler in SICL with `ionsrq`.
- Make sure that all the Enable Masks in all the status enable registers are set to the proper values to propagate the summary bit(s) to the status byte. An SRQ is only generated if the MSS (Master State Summary) bit in the status byte is set.

Using MAV to Determine When Data is Available

The following example program sets up an SRQ handler to be called when there is data in the output queue. The program then prompts for SCPI commands. If the SCPI command results in data in the output queue (such as a query command), then the SRQ handler is called and the data is printed.

The following summarizes the procedure used:

- Define an SRQ handler to do the following:
 - Read the Status Byte using **ireadstb**. **ireadstb** returns the RQS (request for service) bit in bit 6 of the status byte. After issuing a **ireadstb**, RQS is cleared indicating that the Service Request is being acknowledged. A new SRQ will not be issued unless RQS is cleared. Using ***STB?** will return the Master State Summary in bit 6 and does not affect RQS.
 - Check if the MAV bit (bit 4) is set to indicate that a message is available. If the MAV bit is set, then a message is available and the SRQ handler can process the message. In this example, the output queue is read using **iscanf**.
- Enable SRQ Handler in SICL with **ionsrq**.
- Enable MAV bit (Message Available Bit) in the Status Byte Enable Register (e.g. ***SRE 16**). This will cause an SRQ to arrive when there is a message in the output queue (i.e. data is available to be read)

Example Program

```

/* status1.c */
* The following program provides an interactive command line interface
* to send SCPI commands to SCPI compatible instruments.
* This utilizes the MAV bit of the Status Byte in order to determine if
* the instrument is returning any output. */
#include <sicl.h>
#include <stdio.h>

/* These are Masks for the Status Byte */
/* all bits start at bit 0 */
#define MAV_MASK 0x10      /* MAV - bit 4 */

/* This is the SRQ handler to check for Message Available (MAV) */
void srq_hdlr( INST id) {
    unsigned char stb;
    char buf[255];
    int esr;
    int errnum;
    char errmsg[100];
    /* read the status byte to determine what caused the SRQ.
    * Note: use ireadstb instead of *STB? because you want to
    * clear RQS instead of reading the MSS bit in the status byte.*/
    ireadstb(id, &stb);

    /* check if MAV caused the SRQ */
    if( MAV_MASK == (stb & MAV_MASK))
    {
        /* message is available so read in the result. */
        iscanf( id, "%t", buf);
        printf("%s", buf);
    }
}

```



```

void main(){
    INST id;
    char addr[80];
    char cmd[255];
    int opc;
    int idx;

    printf("This program provides an interactive environment for SCPI \n");
    printf("compatible instruments.  \n\n");
    printf("Enter the SIDL address of the instrument to open.\n");
    printf("for example:  iscp1,24)\n");

    gets(addr);

    /* install error handler */
    ionerror( I_ERROR_EXIT);

    /* open the instrument specified by the user */
    id = iopen(addr);
    itimeout( id, 20000);          /* 20 second timeout */

    /* set up SRQ handler */
    ionsrq( id, srq_hdlr);

    /* enable MAV (bit 4) in status byte to cause an SRQ */
    iprintf( id, "*SRE %d\n", MAV_MASK );

    /* make sure *SRE finished */
    ipromptf( id, "*OPC?\n", "%d", &opc);  /* opc value not used */

    printf("\nEnter SCPI Commands/Queries to Instrument at %s\n", addr);
    printf(" (press return to exit)\n\n");

    while(1)
    {
        while(0 == gets(cmd));
        if( 0 == strlen(cmd))
            break;          /* quit sending SCPI Commands */

        /* send command */
        iprintf(id, "%s\n", cmd);

        /* check cmd for a '?', if found assume it is a query */
        for(idx=0; idx<strlen(cmd); idx++)
            if( '?' == cmd[idx])
            {
                /* wait up to 1 minute for srq handler */
                if( 0 != iwaithdlr(60000))
                {
                    printf("ERROR: Failed to process Query\n");
                }
                break;
            }
    }
    /* while - there are commands to send */
    /* remove the handler */
    ionsrq( id, 0);

    /* close the session */
    printf("\nClosing Instrument at %s\n", addr);
}

```

```
    iclose(id);  
}
```

Using a Service Request to Detect Errors

The following example program sets up an SRQ handler to be called when SCPI errors are detected using the Standard Event Status Register. The program then prompts for SCPI commands. If the SCPI command results in data in the output queue (such as a query command) or an error, then the SRQ handler is called and the data is printed.

The following summarizes the procedure used:

- Define a SRQ Handler which does the following:
 - Read the Status Byte using **ireadstb**. **ireadstb** returns the RQS (request for service) bit in bit 6 of the status byte. After issuing a **ireadstb**, RQS is cleared indicating that the Service Request is being acknowledged. A new SRQ will not be issued unless RQS is cleared. Using ***STB?** will return the Master State Summary in bit 6 and does not affect RQS.
 - Check if the MAV bit (bit 4) is set to indicate that a message is available. If the MAV bit is set, then a message is available and the SRQ handler can process the message. In this example, the output queue is read using **iscanf**.
 - Check if the Standard Event Status summary bit (bit 5) is set. If the bit is set then read the Standard Event Status Group's Event Register to determine which event(s) caused the SRQ. Check for Command Error (bit 5), Execution Error (bit 4), Device Dependent Error (bit 3), or Query Error (bit 2). If found, read the error queue with **SYST:ERR?** to print out error messages.
- Enable SRQ Handler in SICL with **ionsrq**.
- Enable MAV bit (Message Available Bit) and Standard Event Status Register Summary Bit in the Status Byte Enable Register (e.g. ***SRE 48**). This will cause an SRQ to arrive when there is a message in the output queue or when the summary bit is set in the standard event status register.
- Enable the Command Error, Execution Error, Device Dependent Error, and Query Error enable bits in the Standard Event status enable register (e.g. ***ESE 60**). This will cause the summary bit of the standard event status register to be set when an error occurs.

Example Program

```
/* status2.c *
* The following program provides an interactive command line interface
* to send SCPI commands to SCPI compatible instruments.
* This utilizes the MAV bit of the Status Byte in order to determine if
* the instrument is returning any output. It also automatically
* displays any error conditions that may result by querying the Standard
* event status register. */
#include <sc1.h>
#include <stdio.h>

/* These are Masks for the Status Byte */
/* all bits start at bit 0 */
#define MAV_MASK 0x10      /* MAV - bit 4 */
#define ESR_MASK 0x20     /* ESR summary - bit 5 */

/* These are Masks for the Standard Event Status Register */
/* all bits start at bit 0 */
#define QRY_ERR_MASK 0x04 /* query error - bit 2 */
#define DEV_ERR_MASK 0x08 /* device dependent error - bit 3 */
#define EXE_ERR_MASK 0x10 /* execution error - bit 4 */
#define CMD_ERR_MASK 0x20 /* command error - bit 5 */

/* This is the SRQ handler to check for Message Available (MAV)
* or any error conditions */
void srq_hdlr( INST id)
{
    unsigned char stb;
    char buf[255];
    int esr;
    int errnum;
    char errmsg[100];

    /* read the status byte to determine what caused the SRQ.
    * Note: use ireadstb instead of *STB? because we want to
    * clear RQS instead of reading the MSS bit in the status byte. */
    ireadstb(id, &stb);

    /* check if MAV caused the SRQ */
    if( MAV_MASK == (stb & MAV_MASK))
    {
        /* message is available so read in the result */
        iscanf( id, "%t", buf);
        printf("%s", buf);
    }
    else /* check if Standard Event Status */
    if( ESR_MASK == (stb & ESR_MASK))
    {
        /* read the standard event register to determine
        * what caused the ESR summary bit to be set. This
        * is necessary in order to get future SRQ's from
        * the Standard Event status group. */
        ipromptf(id, "*ESR?\n", "%d\n", &esr);

        /* check if an error caused the summary bit to get set */
        if( (CMD_ERR_MASK == (esr & CMD_ERR_MASK )) ||
            (EXE_ERR_MASK == (esr & EXE_ERR_MASK )) ||
            (DEV_ERR_MASK == (esr & DEV_ERR_MASK )) ||
```

```

        (QRY_ERR_MASK == (esr & QRY_ERR_MASK ))
    {
        /* an error occurred, read the error queue to get the error */
        errnum = -1;
        while( errnum != 0)
        {
            ipromptf( id, "SYST:ERR?\n", "%d,%t", &errnum, errmsg);
            if( errnum != 0)
                printf("%d,%s", errnum, errmsg);
        }
    }
}

void main()
{
    INST id;
    char addr[80];
    char cmd[255];
    int opc;
    int idx;

    printf("This program provides an interactive environment for SCPI \n");
    printf("compatible instruments.  \n\n");
    printf("Enter the SICL address of the instrument to open.\n");
    printf("for example:  iscp1,24)\n");

    gets(addr);

    /* install error handler */
    ionerror( I_ERROR_EXIT);

    /* open the instrument specified by the user */
    id = iopen(addr);
    itimeout( id, 20000);          /* 20 second timeout */

    /* set up SRQ handler */
    ionsrq( id, srq_hdlr);

    /* enable MAV (bit 4) and Standard Event Status Summary (bit 5)
    * in status byte to cause an SRQ */
    iprintf( id, "*SRE %d\n", MAV_MASK | ESR_MASK);

    /* enable ERROR Bits to generate a ESR summary message */
    iprintf( id, "*ESE %d\n", CMD_ERR_MASK | EXE_ERR_MASK |
            DEV_ERR_MASK | QRY_ERR_MASK);

    /* make sure *SRE and *ESE finished */
    ipromptf( id, "*OPC?\n", "%d", &opc);          /* opc value not used */
    printf("\nEnter SCPI Commands/Queries to Instrument at %s\n", addr);
    printf(" (press return to exit)\n\n");

    while(1)
    {
        while(0 == gets(cmd));
        if( 0 == strlen(cmd))
            break;          /* quit sending SCPI Commands */
    }
}

```

```

/* send command */
iprintf(id, "%s\n", cmd);

/* check cmd for a '?', if found assume it is a query */
for(idx=0; idx<strlen(cmd); idx++)
    if( '?' == cmd[idx])
    {
        /* wait up to 1 minute for srq handler */
        if( 0 != iwaitdlnr(60000))
        {
            printf("ERROR: Failed to process Query\n");
        }
        break;
    }
} /* while - there are commands to send */
/* remove the handler */
ionsrq( id, 0);
/* close the session */
printf("\nClosing Instrument at %s\n", addr);
iclose(id);
}

```

Notes:

Chapter 3

Command Reference

About this Chapter

This section describes the SCPI status system and common (*) commands that can be used to program instruments in your mainframe.

The STATus subsystem commands access the condition, event, and enable registers in the Operation Status Group and the Questionable Data Group.

Subsystem Syntax

```

STATus
  :OPERation
    :CONDition?
    :ENABle <event>
    :ENABle?
    [:EVENT]?
  :PRESet
  :QUEStionable
    :CONDition?
    :ENABle <event>
    :ENABle?
    [:EVENT]?
  
```

:OPERation :CONDition?

STATus:OPERation:CONDition? returns the state of the condition register in the Operation Status Group. The state represents conditions which are part of an instrument's operation.

Comments • **Related Commands:** STAT:OPER:ENABle, STAT:OPER:EVENT?

Example Reading the contents of the condition register

```
STAT:OPER:COND? Query register.
```

:OPERation:ENABle

STATus:OPERation:ENABle <event> sets an enable mask to allow events monitored by the condition register and recorded in the event register, to send a summary bit to the Status Byte register (bit 7).

Parameters

Parameter Name	Parameter Type	Range of Values	Default Units
event	numeric	0-65535	none

Comments • When the summary bit is sent, it sets bit 7 in the Status Byte register.
 • **Related Commands:** STAT:OPER:ENABle?

Example Unmasking bit 8 in the Event Register

```
STAT:OPER:ENAB 256 Unmask bit 8.
```

:OPERation:ENABLE?

STATus:OPERation:ENABLE? returns which bits in the event register (Operation Status Group) are unmasked.

- Comments**
- Reading the event register mask does not change the mask setting (STAT:OPER:ENAB <event>).
 - **Related Commands:** STAT:OPER:ENABLE

Example Reading the Event Register Mask

STAT:OPER:ENAB? *Query register mask.*

:OPERation[:EVENT]?

STATus:OPERation[:EVENT]? returns which bits in the event register (Operation Status Group) are set. The event register indicates when there has been a transition in the condition register.

- Comments**
- Reading the event register clears the contents of the register. If the event register is to be used to generate a service request (SRQ), you should clear the register before enabling the SRQ (*SRE). This prevents an SRQ from occurring due to a previous event.
 - **Related Commands:** STAT:OPER:ENABLE, STAT:OPER:ENABLE?

Example Reading the Event Register

STAT:OPER:EVEN? *Query returns bit(s) set.*

:PRESet

STATus:PRESet Sets the Operation Status Enable and Questionable Data Enable registers to 0. After executing this command, none of the events in the Operation Event or Questionable Event registers will be reported as a summary bit in either the Status Byte Group or Standard Event Group. STATus:PRESet does not clear either of the Event registers.

Example Presetting the Enable Register

STAT:PRES *Preset enable register.*

:QUESTionable :CONDition?

STATus:QUESTionable:CONDition? returns the state of the condition register in the Questionable Status Group. The state represents conditions which are part of an instrument's operation.

Comments • **Related Commands:** STAT:QUES:ENABle, STAT:QUES:EVENT?

Example Reading the contents of the condition register

STAT:QUES:COND? *Query register.*

:QUESTionable:ENABLE

STATus:QUESTionable:ENABLE <event> sets an enable mask to allow events monitored by the condition register and recorded in the event register, to send a summary bit to the Status Byte register (bit 3).

Parameters

Parameter Name	Parameter Type	Range of Values	Default Units
event	numeric	0-65535	none

Comments • When the summary bit is sent, it sets bit 3 in the Status Byte register.

• **Related Commands:** STAT:QUES:ENABle?

Example Unmasking bit 8 in the Event Register

STAT:QUES:ENAB 256 *Unmask bit 8.*

:QUESTionable:ENABLE?

STATus:QUESTionable:ENABLE? returns which bits in the event register (Questionable Status Group) are unmasked.

Comments • Reading the event register mask does not change the mask setting (STAT:QUES:ENAB <event>).

• **Related Commands:** STAT:QUES:ENABle

Example Reading the Event Register Mask

STAT:QUES:ENAB? *Query register mask.*

:QUESTionable[:EVENT]?

STATus:QUESTionable[:EVENT]? returns which bits in the event register (Questionable Status Group) are set. The event register indicates when there has been a transition in the condition register.

Comments • Reading the event register clears the contents of the register. If the event register is to be used to generate a service request (SRQ), you should clear the register before enabling the SRQ (*SRE). This prevents an SRQ from occurring due to a previous event.

- **Related Commands:** STAT:QUES:ENABle, STAT:QUES:ENABle?

Example Reading the Event Register

STAT:QUES:EVEN?

Query returns bit(s) set.

Common Command Reference

This section describes the IEEE-488.2 Common Commands that can be used to program instruments in the mainframe. Commands are listed alphabetically (the following table shows the Common Commands listed by functional group). For additional information on any Common Commands, refer to the *IEEE Standard 488.2-1987*.

IEEE 488.2 Common Commands Functional Groupings		
Category	Command	Title
General	*IDN?	Identification Query
	*RST	Reset Command
	*TST?	Self-Test Query
Instrument Status	*CLS	Clear Status Command
	*ESE <mask>	Standard Event Status Enable Command
	*ESE?	Standard Event Status Enable Query
	*ESR?	Standard Event Status Register Query
	*SRE <mask>	Service Request Enable Command
	*SRE?	Service Request Enable Query
	*STB?	Status Byte Query
Macros	*DMC <name>,<cmds>	Define Macro Command
	*EMC <state>	Enable Macros Command
	*EMC?	Enable Macro Query
	*GMC? <name>	Get Macro Query
	*LMC?	Learn Macro Query
	*PMC	Purge all Macros Command
	*RMC <name>	Remove individual Macro Command
Synchronization	*OPC	Operation Complete Command
	*OPC?	Operation Complete Query
	*WAI	Wait-to-Continue Command

*CLS

Clear Status Command. The *CLS command clears all status registers (Standard Event Status Register, Standard Operation Event Status Register, Questionable Data Event Register) and the error queue for an instrument. This clears the corresponding summary bits (bits 3, 5, & 7) and the instrument-specific bits (bits 0, 1, & 2) in the Status Byte Register. *CLS does not affect the enabling of bits in any of the status registers (Status Byte Register, Standard Event Status Register, Standard Operation Enable Status Register, or Questionable Data Enable Status Register). (The SCPI command STATUS:PRESet *does* clear the Standard Operation Status Enable and Questionable Status Enable registers.) *CLS disables the Operation Complete function (*OPC command) and the Operation Complete Query function (*OPC? command).

***DMC <name_string>, <command_block>**

Define Macro Command. Assigns one, or a sequence of commands to a macro name.

The command sequence may be composed of SCPI and/or Common commands.

The name given to the macro may be the same as a SCPI command, but may not be the same as a Common command. When a SCPI named macro is executed, the macro rather than the SCPI command is executed. To regain the function of the SCPI command, execute the *EMC 0 command.

***EMC <enable>**

Enable Macros Command. When *enable* is non-zero, macros are enabled. When *enable* is zero, macros are disabled.

***EMC?**

Enable Macros Query. Returns either 1 (macros are enabled), or 0 (macros are disabled) for the selected instrument.

***ESE <mask>**

Standard Event Status Enable Register Command. Enables one or more events in the Standard Event Status Register to be reported in bit 5 (the Standard Event Status Summary Bit) of the Status Byte Register. You enable an event by specifying its decimal weight for <mask>. To enable more than one event, specify the sum of the decimal weights.

Example *ESE 60

Enables bits 2, 3, 4, & 5. Respective weights are 4 + 8 + 16 + 32 = 60.

***ESE?**

Standard Event Status Enable Query. Returns the weighted sum of all enabled (unmasked) bits in the Standard Event Status Register.

Example ESE?

Sends status enable query.

***ESR?**

Standard Event Status Register Query. Returns the weighted sum of all set bits in the Standard Event Status Register. After reading the register, *ESR? clears the register. The events recorded in the Standard Event Status Register are independent of whether or not those events are enabled with the *ESE command.

Example *ESR?

Sends Standard Event Status Register query.

*GMC? <name_string>

Get Macro Query. Returns *arbitrary block response data* which contains the command or command sequence defined by *name_string*. The command sequence will be prefixed with characters which indicate the number of characters that follow the prefix.

Example *GMC? 'LIST'

*Ask for definition of macro from *DMC example.*

If the prefix returned consisted of "#214", the 2 says to expect two character-counting digits. The 14 says that 14 characters of data follow. Had the returned macro been shorter, such as #15*EMC?, we would read this as 1 counting digit indicating 5 data characters.

*IDN?

Identity. Returns the device identity. The response consists of the following four fields (fields are separated by commas):

- Manufacturer
- Model Number
- Serial Number (returns 0 if not available)
- Firmware Revision (returns 0 if not available)

The *IDN? command returns something similar to the following for the HP E1411B:

HEWLETT-PACKARD,E1411B,0,B,05.00

Example *IDN?

Queries identity.

*LMC?

Learn Macros Query. Returns a quoted string *name* for each currently defined macro. If more than one macro is defined, the quoted strings are separated by commas (.). If no macro is defined, then a quoted null string ("") is returned.

*LRN?

Learn query command. *LRN? causes the instrument to respond with a string of SCPI commands which define the instrument's current state. Your application program can enter the *LRN? response data into a string variable, later to be sent back to the instrument to restore that configuration.

Example response from an HP E1326B voltmeter in the power-on state:

```
*RST;;CAL:ZERO:AUTO 1; :CAL:LFR +60; VAL +0.00000000E+000;
:DISP:MON:STAT 0; CHAN (@0); :FORM ASC,+7; :FUNC "VOLT";
:MEM:VME:ADDR +2097152; SIZE +0; STAT 0; :RES:APER +1.666667E-002;
OCOM 0; RANG +1.638400E+004; RANG:AUTO 1;;VOLT:APER
+1.666667E-002; RANG +8.000000E+000; RANG:AUTO 1; :TRIG:COUN +1;
DEL +0.00000000E+000; DEL:AUTO 1; :TRIG:SOUR IMM; :SAMP:COUN +1;
SOUR IMM;TIM +5.000000E-002 S
```

*OPC

Operation Complete. Causes an instrument to set bit 0 (Operation Complete Message) in the Standard Event Status Register when all pending operations have been completed. By enabling this bit to be reflected in the Status Byte Register (*ESE 1 command), you can ensure synchronization between the instrument and an external computer or between multiple instruments.

*OPC?

Operation Complete Query. Causes an instrument to place an ASCII 1 into the instrument's output queue when all pending instrument operations are finished. By requiring the computer to read this response before continuing program execution, you can ensure synchronization between one or more instruments and the computer.

*PMC

Purge Macros Command. Purges all currently defined macros in the selected instrument.

*RMC <name_string>

Remove Individual Macro Command. Purges an individual macro identified by the *name_string* parameter.

Example *RMC 'LIST'

*Remove macro command from *DMC example.*

*RST

Reset. Resets an instrument as follows:

- Sets the instrument to a known state (usually the power-on state).
- Aborts all pending operations.
- Disables the *OPC and *OPC? modes.

*RST does not affect:

- The state of the VXI interface
- The VXI address

- The output queue
- The Service Request Enable Register
- The Standard Event Status Enable Register
- The power-on flag
- Calibration data
- Protected user data

*SRE <mask>

Service Request Enable. When a service request event occurs, it sets a corresponding bit in the Status Byte Register (this happens whether or not the event has been enabled (unmasked) by *SRE). The *SRE command allows you to identify which of these events will assert a service request (SRQ). When an event is enabled by *SRE and that event occurs, it sets a bit in the Status Byte Register and issues an SRQ to the computer. You enable an event by specifying its decimal weight for <mask>. To enable more than one event, specify the sum of the decimal weights.

Example *SRE 160 *Enables bits 5 & 7. Respective weights are 32 + 128 = 160.*

*SRE?

Status Register Enable Query. Returns the weighted sum of all enabled (unmasked) events (those enabled to assert SRQ) in the Status Byte Register.

Example *SRE? *Sends Status Register Enable query.*

*STB?

Status Byte Register Query. Returns the weighted sum of all set bits in the Status Byte Register.

Comments You can read the Status Byte Register using either the *STB? command or by doing a SICL ireadstb function call. There are some subtle differences between *STB? and ireadstb. You can use either method to read the state of bits 0-5 and bit 7. Bit 6 is treated differently depending on whether you use *STB? or ireadstb. In general, use ireadstb inside interrupt service routines, not *STB?.

Example *STB? *Sends Status Byte Register query.*

*TST?

Self-Test. Causes an instrument to execute an internal self-test and returns a response showing the results of the self-test. A zero response indicates that self-test passed. A value other than zero indicates a self-test failure or error.

Example *TST? *Execute self-test, return response.*

*WAI

Wait-to-continue. Prevents an instrument from executing another command until the operation caused by the previous command is finished (sequential operation). Since all instruments normally perform sequential operations, executing the *WAI command causes no change to the instrument's operation.

Notes:

Free Manuals Download Website

<http://myh66.com>

<http://usermanuals.us>

<http://www.somanuals.com>

<http://www.4manuals.cc>

<http://www.manual-lib.com>

<http://www.404manual.com>

<http://www.luxmanual.com>

<http://aubethermostatmanual.com>

Golf course search by state

<http://golfingnear.com>

Email search by domain

<http://emailbydomain.com>

Auto manuals search

<http://auto.somanuals.com>

TV manuals search

<http://tv.somanuals.com>