

HP
StorageWorks

MSL6000
Series
Drive Module
Installation

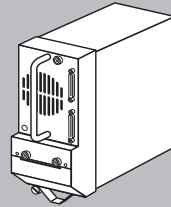

Caution: Parts can be damaged by electrostatic discharge. Keep parts in their containers until needed. Ensure you are properly grounded when touching static-sensitive components.



Note: This part is not hot-pluggable. Before installing the drive, you must take it off line using the library GUI touch screen.



Note: If you are adding an additional tape drive to your library, skip to "Installation" in step 7.



Note: Depending on the model, your library may look different from the ones illustrated in this procedure.

1

Removal

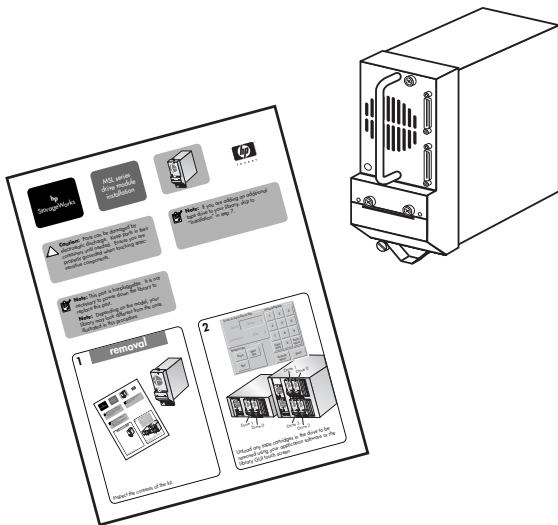

Inspect the contents of the kit.

2

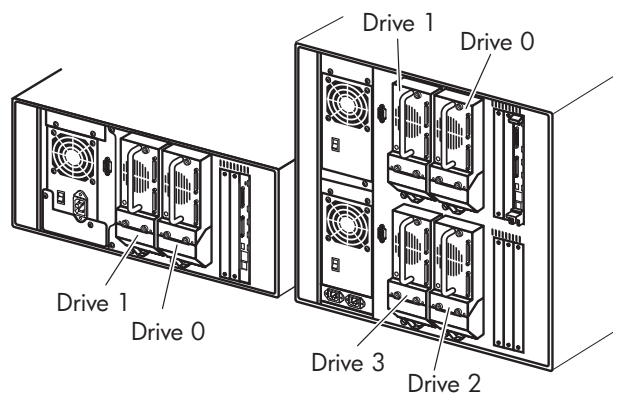
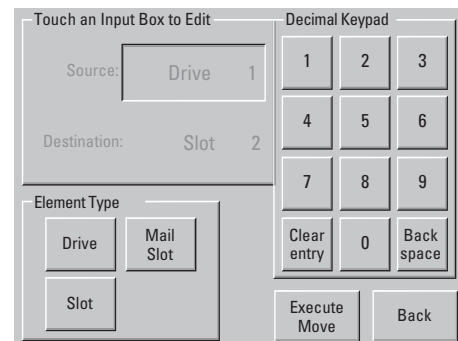

Unload any tape cartridges in the drive to be removed using your application software or the library GUI touch screen.

3

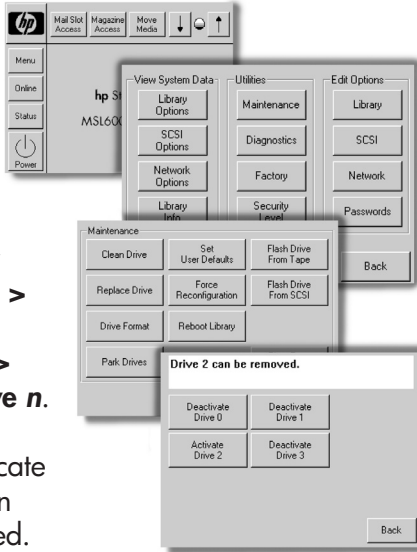

Deactivate the tape drive to be removed by selecting **Menu > Maintenance > Replace Drive > Deactivate Drive n**. The screen will change to indicate that Drive *n* can now be removed.

4

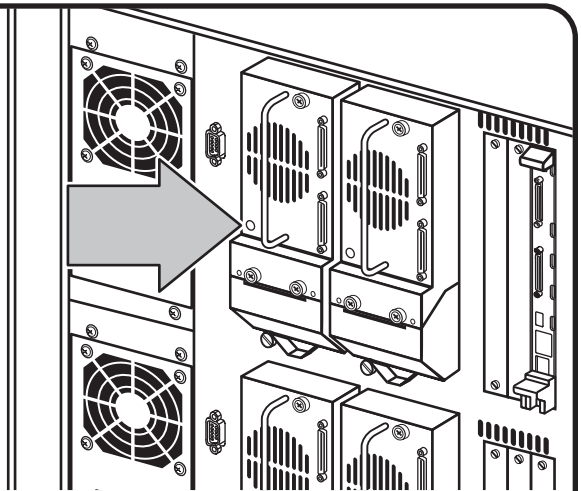

Make sure that the LED on the tape drive to be removed is off.

5

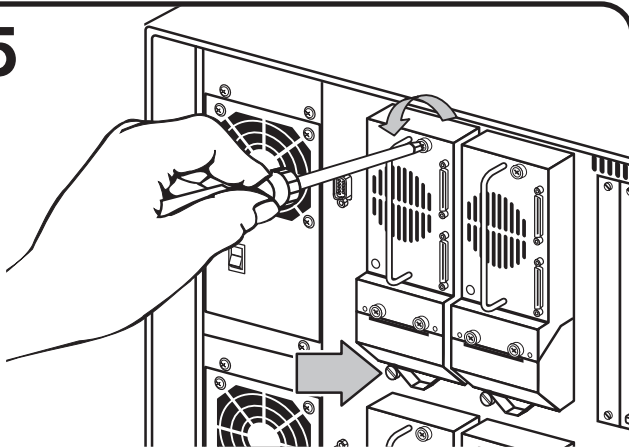

Using a flat-blade screwdriver, loosen the two captive thumbscrews at the top center and lower left of the tape drive.

6

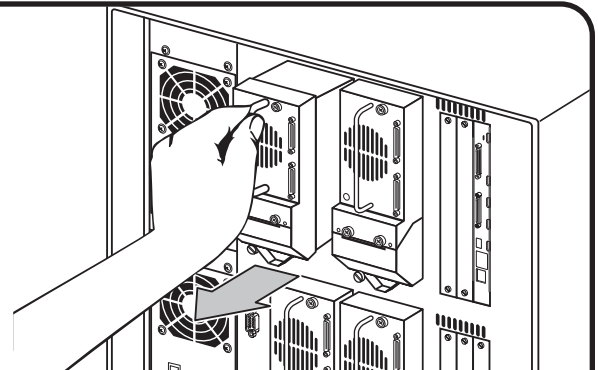

Pull straight back on the tape drive handle to remove it from the library.



Note: Some effort is required to overcome the initial resistance of unplugging the tape drive from the drive bay.

7

Installation

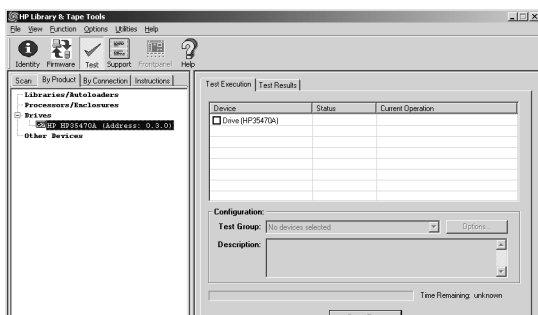

If you are upgrading to a new drive technology, use HP StorageWorks Library and Tape Tools to upgrade the library firmware before installing the new tape drive.

8

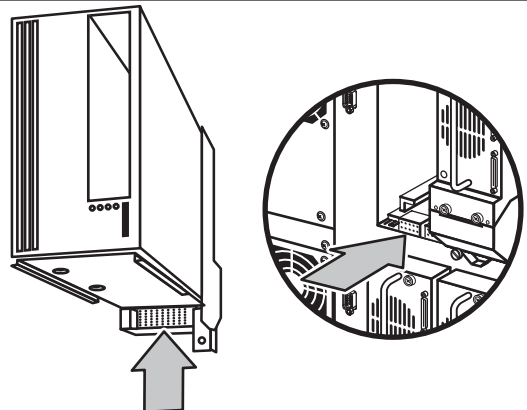

Before installing the new drive, inspect the connectors on the tape drive and in the drive bay. Ensure that the connectors are intact, free of any foreign objects, and have no cracks or deformed contacts.

9

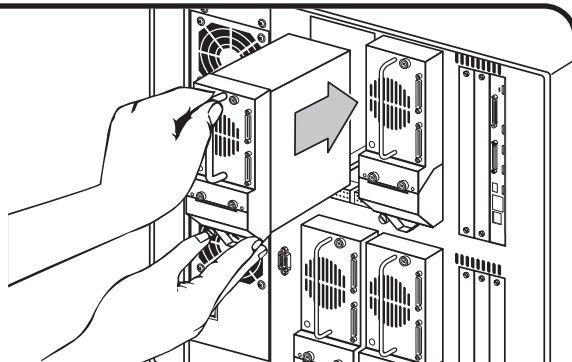

Slowly insert the new tape drive into the drive bay, aligning the connectors on the tape drive with the connectors in the drive bay.



Caution: Push on the tape drive handle and the bottom portion of the tape drive until it is seated.

10

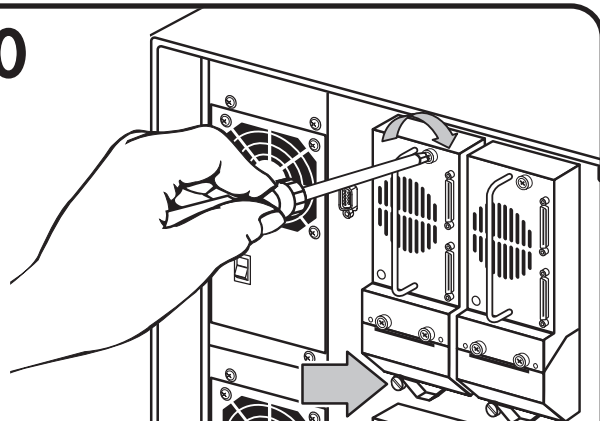

Using a flat-blade screwdriver, tighten the two captive thumbscrews. If adding an additional drive, configure the library for the new tape drive. Refer to the tape library user guide for more information.

11

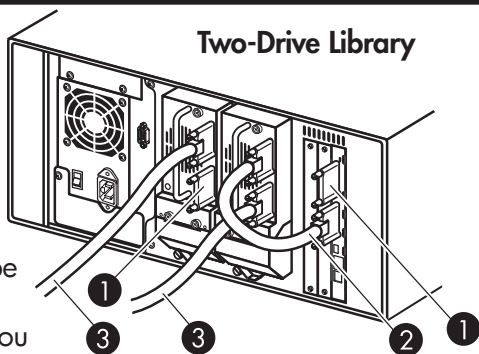

If you are adding an additional tape drive to your library, or if you are upgrading an existing drive, ensure you use supported cabling configurations. See the *HP StorageWorks MSL6000 Series Tape Library User Guide* for more information. The user guide can be downloaded from <http://www.hp.com/support>.

Two-Drive Library

- 1 - Terminator
- 2 - 0.5 m cable
- 3 - 0.5 m cable to host
- 4 - RS-232 diagnostic cable (for service only)



Note: For optimum performance, Ultrium 460 and 960 drives should be configured with one drive per bus.

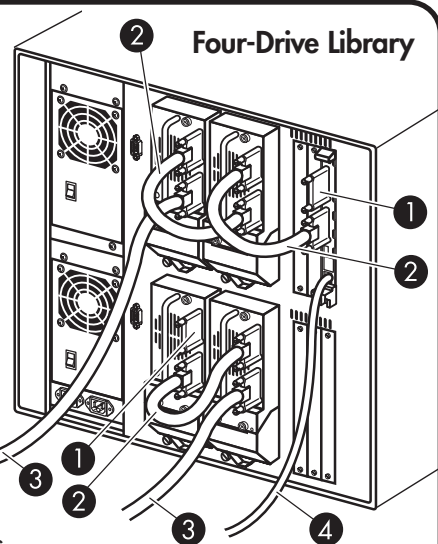

Four-Drive Library

12

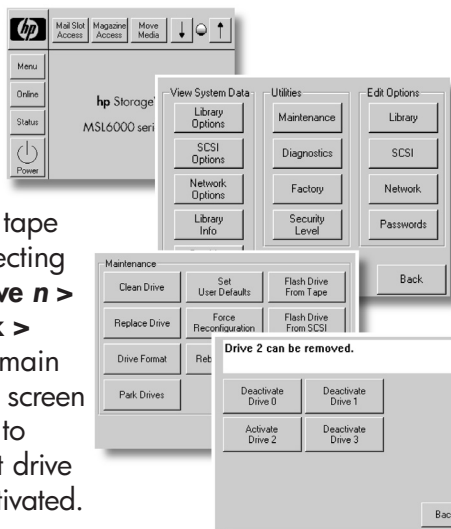

Activate the tape drive by selecting **Activate Drive n > Back > Back > Back** to the main screen. The screen will change to indicate that drive n is now activated.

13

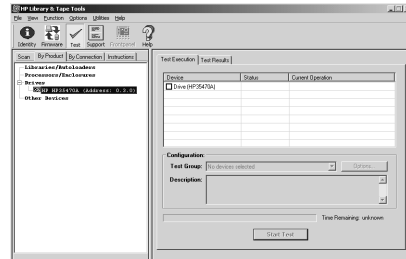

Use HP StorageWorks Library and Tape Tools, Remote Management Interface (RMI), or MSLUtil diagnostic software to upgrade the drive to the latest firmware.



Note: You may need to reconfigure your software application. Drive serial numbers might be used for configuration and to assign drives to the library.

Getting Help

- HP Product Information Site:
<http://www.hp.com/go/storage>
- HP Technical Support and Phone Numbers:
<http://www.hp.com/support>
- HP StorageWorks Library and Tape Tools (L&TT) diagnostic software:
<http://www.hp.com/support/tapetools>



Note: Use L&TT, RMI, or MSLUtil diagnostic software to verify installations and to ensure your library has the latest firmware.

© 2005 Hewlett-Packard Development Company, L.P.

Second Edition (March 2005)
Part Number: 331764-002



331764-002

Free Manuals Download Website

<http://myh66.com>

<http://usermanuals.us>

<http://www.somanuals.com>

<http://www.4manuals.cc>

<http://www.manual-lib.com>

<http://www.404manual.com>

<http://www.luxmanual.com>

<http://aubethermostatmanual.com>

Golf course search by state

<http://golfingnear.com>

Email search by domain

<http://emailbydomain.com>

Auto manuals search

<http://auto.somanuals.com>

TV manuals search

<http://tv.somanuals.com>