

DECADE CAPACITOR

4440B

GENERAL ELECTRIC
INSTRUMENTATION SERVICE
(602) 278-8515

CAL
DUE

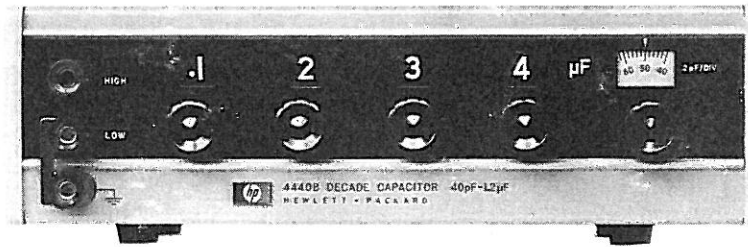

Electronic Services, Los Angeles
M15752X

CERTIFICATION

The Hewlett-Packard Company certifies that this instrument was thoroughly tested and inspected and found to meet its published specifications when it was shipped from the factory. The Hewlett-Packard Company further certifies that its calibration measurements are traceable to the U.S. National Bureau of Standards to the extent allowed by the Bureau's calibration facility.

WARRANTY AND ASSISTANCE

All Hewlett-Packard products are warranted against defects in materials and workmanship. This warranty applies for one year from the date of delivery, or, in the case of certain major components listed in the operating manual, for the specified period. We will repair or replace products which prove to be defective during the warranty period provided they are returned to Hewlett-Packard. No other warranty is expressed or implied. We are not liable for consequential damages.

Service contracts or customer assistance agreements are available for Hewlett-Packard products that require maintenance and repair on-site.

For any assistance, contact your nearest Hewlett-Packard Sales and Service Office. Addresses are provided at the back of this manual.

O P E R A T I N G A N D S E R V I C E M A N U A L

MODEL 4440B
DECADE CAPACITOR

SERIALS PREFIXED: 1224 J and above
See Section VI for Other Serial Prefixes.

COPYRIGHT: YOKOGAWA-HEWLETT-PACKARD, LTD., 1969
9-1, TAKAKURA-CHO, HACHIOJI-SHI, TOKYO, JAPAN

Part No. 04440-90003

Printed: MAR. 1980



TABLE OF CONTENTS

Section	Title	Page
I	GENERAL INFORMATION.....	1-1
1-1.	Introduction.....	1-1
1-4.	Specifications.....	1-1
1-6.	Instrument Identification.....	1-1
1-8.	Manual Changes.....	1-1
II	INSTALLATION	
2-1.	Introduction.....	2-1
2-3.	Unpacking and Inspection.....	2-1
2-5.	Storage and Shipment.....	2-1
2-8.	Installation.....	2-1
III	OPERATION	
3-1.	Introduction.....	3-1
3-3.	Controls and Connectors.....	3-1
IV	MAINTENANCE.....	4-1
4-1.	Introduction.....	4-1
4-3.	Test Equipment.....	4-1
4-5.	In-Cabinet Performance Check.....	4-2
4-10.	Adjustment.....	4-2
4-13.	Vernier Adjustment.....	4-2
4-14.	Fourth Decade Adjustment.....	4-2
4-15.	Third Decade Adjustment.....	4-4
4-17.	Troubleshooting.....	4-4
V	REPLACEABLE PARTS.....	5-1
5-1.	Introduction.....	5-1
5-4.	Ordering Information.....	5-1
VI	MANUAL CHANGES AND OPTIONS.....	6-1
6-1.	Options.....	6-1
6-3.	Special Instruments.....	6-1
6-5.	Manual Changes.....	6-1
VII	CIRCUIT DIAGRAMS.....	7-1
7-1.	Introduction.....	7-1
7-3.	General Notes.....	7-1

LIST OF TABLES

Number	Title	Page
1-1.	Specifications.....	1-0
4-1.	Test Equipment Required.....	4-0
4-2.	Capacitance Check.....	4-3
4-3.	Composition of the 1st Decade.....	4-5
4-4.	Composition of the 2nd Decade.....	4-5
4-5.	Composition of the 3rd Decade.....	4-6
4-6.	Composition of the 4th Decade.....	4-6
5-1.	List of Reference Designators and Abbreviations.....	5-1
5-2.	Reference Designation Index.....	5-2
6-1.	Backdating Changes.....	6-1

LIST OF ILLUSTRATIONS

Number	Title	Page
1-1.	Model 4440B Decade Capacitor	1-0
3-1.	Front Panel Controls and Connectors	3-1
3-2.	Operating Procedure	3-2
4-1.	Measuring Cable	4-0
4-2.	Testing Plate	4-0
4-3.	Performance Test Setup	4-1
4-4.	1615-A Capacitance Bridge Setting	4-2
4-5.	Parts Location	4-5
7-1.	Schematic Diagram Notes	7-2
7-2.	Model 4440B Schematic Diagram	7-3

Table 1-1 and Figure 1-1

Table 1-1. Specifications

<p>Capacitance: 40pF to 1.2μF in steps of 100pF with a 40pF to 140pF variable air capacitor providing continuous adjustment to better than 2pF between steps.</p> <p>Dielectric: Silvered mica for decade steps.</p> <p>Direct Reading Accuracy: ±(0.25% + 3pF) at 1kHz for three-terminal connection; capacitance increase for two-terminal connection is less than 1pF (nominal 0.5pF).</p> <p>Temperature Coefficient: -0 to +70 ppm/°C</p> <p>Dissipation Factor: 0.001 max at 1kHz above 1040pF. *0.005 max at 1kHz below 1040pF. * For lowest decade only.</p> <p>Resonant Frequency: Typical values of the resonant frequency are: 450kHz at 1μF, 4MHz at 0.01μF, and 40 MHz at 100pF.</p>	<p>Insulation Resistance: 5 x 10⁹ ohms minimum, after 5 minutes at 500Vdc.</p> <p>Maximum Voltage: 500V peak</p> <p>Operating Temperature: 0° C - 65° C</p> <p>Weight: Approximately 5.5 lb. (2.5kg)</p> <p>Dimensions:</p>

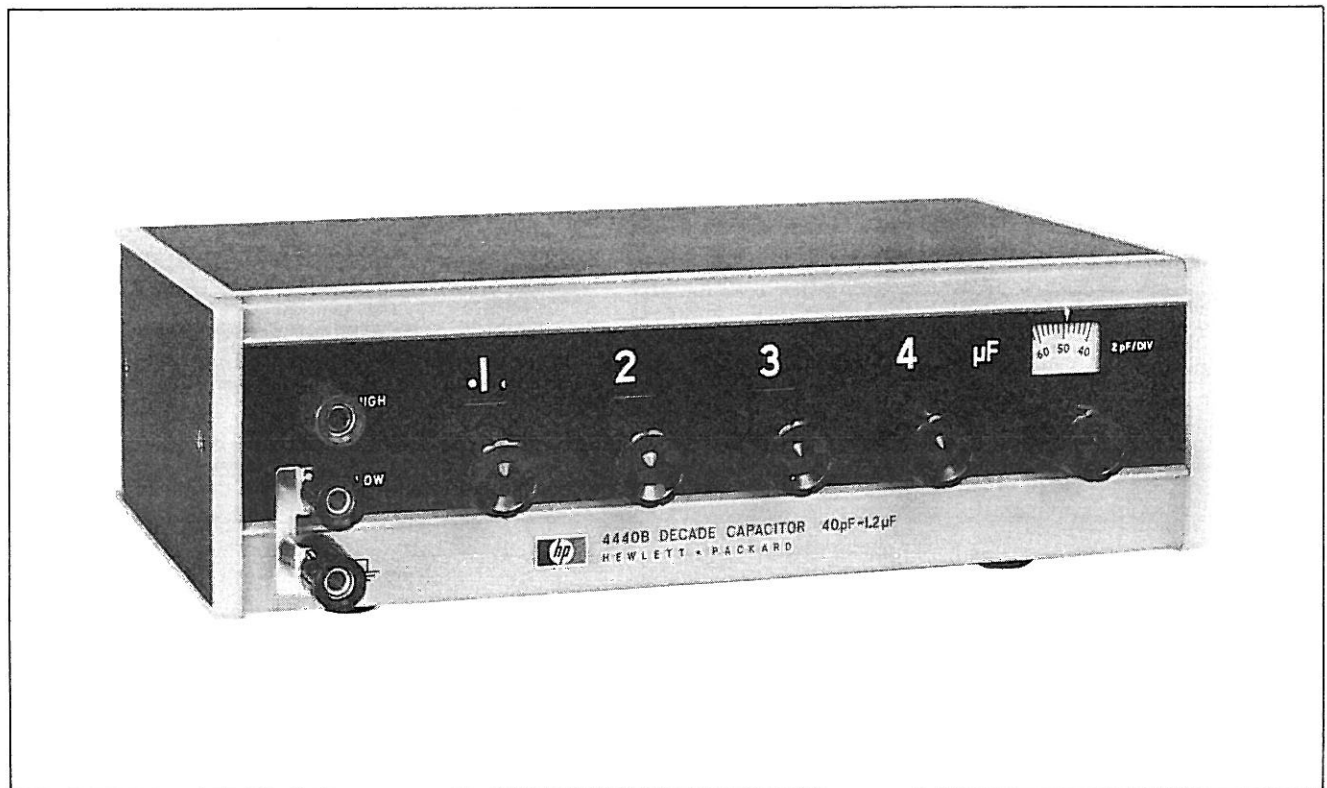

Figure 1-1. Model 4440B Decade Capacitor

SECTION I

GENERAL INFORMATION

1-1. INTRODUCTION

1-2. The HP 4440B Decade Capacitor is a high-accuracy instrument providing usable capacitances from 40pF to 1.2 μ F. Its 0.25% accuracy makes it an ideal aid in circuit design, ac bridge measurements, and any application where accuracy is critical, such as a working standard. The 4440B is also ideally suited for production line testing.

1-3. The 4440B offers simplicity of operation combining four easy-to-read decade ranges in a lightweight, compact package designed for operator convenience and speed. The use of silvered-mica capacitors in all decade steps provides for high accuracy, low dissipation factor, and good temperature coefficient. An air capacitor vernier provides 100pF of additional capacitance with 2pF resolution between the 100pF steps of the smallest decade. The capacitors are housed in a double shield, such that the increased capacitance from three-terminal connection to two-terminal connection is held to 1pF.

1-4. SPECIFICATIONS

1-5. A complete list of specifications is found in Table 1-1.

1-6. INSTRUMENT IDENTIFICATION

1-7. Hewlett-Packard uses a two-section eight-digit serial number to identify instrument. The first three digits (preceding the dash) are the serial prefix which identifies a series of instruments; the last five digits identify a particular instrument in the series. The serial number appears on a plate located on the rear panel. All correspondence with Hewlett-Packard Sales/Service Offices with regard to an instrument should reference the complete serial number.

1-8. MANUAL CHANGES

1-9. This manual provides operating and service information for the HP Model 4440B Decade Capacitor. Information in this manual applies directly to instruments (as manufactured) with serial numbers prefixed by the three digits indicated on the title page. If the serial prefix of the instrument is different from that on the title page, a "Manual Changes" sheet supplied will describe changes which will adapt this manual to provide correct coverage. Technical correction (if any) to this manual, due to known errors in print, are called Errata and are shown on the change sheet. For information on manual coverage of any HP instrument, contact the nearest HP Sales/Service Office (addresses are listed at the back of this manual).

SECTION II INSTALLATION

2-1. INTRODUCTION

2-2. This section contains information for unpacking, inspection, repacking, storage, and installation of the Model 4440B.

2-3. UNPACKING AND INSPECTION

2-4. If the shipping carton is damaged, ask that the carrier's agent be present when the instrument is unpacked. Inspect the instrument for damage (scratches, dents, broken knobs, etc.). If the instrument is damaged or fails to meet specifications, notify the carrier and the nearest Hewlett-Packard Field Office (see list at back of this manual). Retain the shipping carton and the padding material for the carrier's inspection. The field office will arrange for the repair or replacement of your instrument without waiting for the claim against the carrier to be settled.

2-5. STORAGE AND SHIPMENT

2-6. PACKAGING. To protect valuable electronic equipment during storage or shipment always use the best packaging methods available. Your Hewlett-Packard field office can provide packing material such as that used for original factory packaging. Contract packaging companies in many cities can provide dependable custom packaging on short notice. Here are a few recommended packaging methods:

- a. RUBBERIZED HAIR. Cover painted surfaces of instrument with protective wrapping paper. Pack instrument securely in strong corrugated container (350 lb/sq in. bursting test) with 2-

inch rubberized hair pads placed along all surfaces of the instrument. Insert fillers between pads and container to ensure a snug fit.

- b. EXCELSIOR. Cover painted surfaces of instrument with protective wrapping paper. Pack instrument in strong corrugated container (350 lb/sq in. bursting test) with a layer of excelsior about 6 inches thick packed firmly against all surfaces of the instrument.

2-7. ENVIRONMENT. Conditions during storage and shipment should normally be limited as follows:

- a. Maximum altitude, 20,000 feet.
- b. Minimum temperature, -40° F (-40° C).
- c. Maximum temperature, 167° F (75° C).

2-8. INSTALLATION

2-9. The Model 4440B is a submodular unit, equipped with rubber feet for bench operation as shipped from the factory. However, when used in combination with other submodular units it can be rack mounted. The HP adapter frame is designed for this purpose and is available through your Hewlett-Packard Sales/Service Office.

2-10. ADAPTER FRAME (HP Part No. 5060-0808)

2-11. The adapter frame is a rack frame that accepts any combination of submodular units. It can be rack mounted only.

SECTION III

OPERATION

3-1. INTRODUCTION

3-2. The Model 4440B Decade Capacitor provides capacitance from 40pF to 1.2 μ F in steps of 100pF. Between steps a variable air capacitor provides continuous adjustment to better than 2pF. Capacitance

setting can be directly read out from in-line display.

3-3. CONTROLS AND CONNECTORS

3-4. The front panel controls and connectors are explained in Figure 3-1.

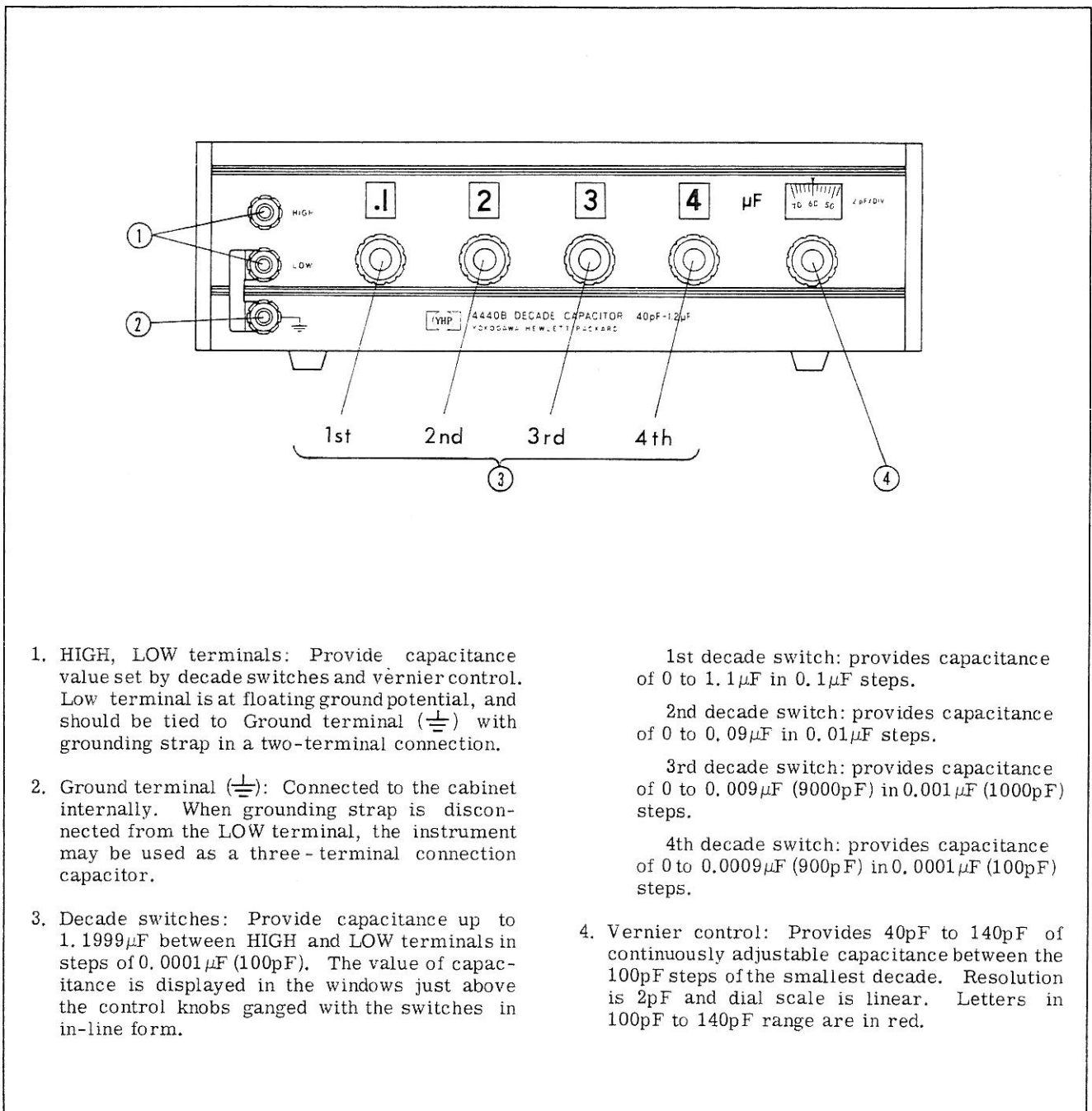

1. HIGH, LOW terminals: Provide capacitance value set by decade switches and vernier control. Low terminal is at floating ground potential, and should be tied to Ground terminal (---) with grounding strap in a two-terminal connection.

2. Ground terminal (---): Connected to the cabinet internally. When grounding strap is disconnected from the LOW terminal, the instrument may be used as a three-terminal connection capacitor.

3. Decade switches: Provide capacitance up to 1.999 μ F between HIGH and LOW terminals in steps of 0.0001 μ F (100pF). The value of capacitance is displayed in the windows just above the control knobs ganged with the switches in in-line form.

1st decade switch: provides capacitance of 0 to 1.1 μ F in 0.1 μ F steps.

2nd decade switch: provides capacitance of 0 to 0.09 μ F in 0.01 μ F steps.

3rd decade switch: provides capacitance of 0 to 0.009 μ F (9000pF) in 0.001 μ F (1000pF) steps.

4th decade switch: provides capacitance of 0 to 0.0009 μ F (900pF) in 0.0001 μ F (100pF) steps.

4. Vernier control: Provides 40pF to 140pF of continuously adjustable capacitance between the 100pF steps of the smallest decade. Resolution is 2pF and dial scale is linear. Letters in 100pF to 140pF range are in red.

Figure 3-1. Front Panel Controls and Connectors

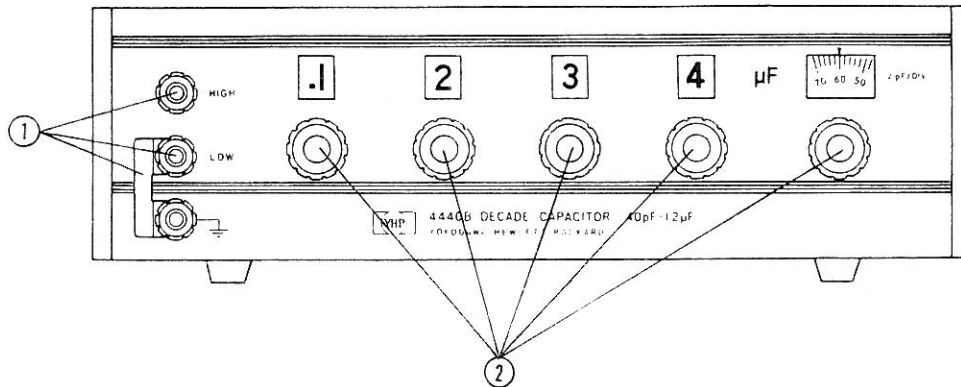

1. Connect the terminals to desired external circuit. Being used as a two-terminal connection, LOW terminal should be tied to Ground terminal with grounding strap. For three-terminal connection use, grounding strap must be removed from the LOW terminal.
2. Set decade switches and vernier control to desired capacitance value. Capacitance value is displayed by the sum of the decade switches and vernier control settings. Refer to the following Table.

CAUTION

Do not apply more than 500V (peak maximum) to the terminals. Damage to the capacitor will occur if higher voltages are applied.

Capacitance Value	Control Settings	Examples
40pF - 140pF 0.000DEG μF	. 0 0 0 0 μF DEG 2pF/DIV	52pF . 0 0 0 0 μF 52 2pF/DIV 134pF . 0 0 0 0 μF 134 2pF/DIV
more than 140pF, 10pF decade is 0-3 0. ABCD E=0-3 G μF	0. A B C D-1 μF 100+EG 2pF/DIV range in red letters	234pF . 0 0 0 1 μF 134 2pF/DIV 1220pF . 0 0 1 1 μF 120 2pF/DIV
more than 140pF, 10pF decade is 4-9 0. ABCD E=4-9 G μF	0. A B C D μF EG 2pF/DIV	152pF . 0 0 0 1 μF 52 2pF/DIV 1340pF . 0 0 1 3 μF 40 2pF/DIV

Figure 3-2. Operating Procedure

Note

After using and/or for storage, set decade switches to 1.1999 μ F position. This setting keeps all (four) contacts that contact stress and corrosion is minimized.

Table 4-1. Test Equipment Required

Instrument Type	Required Characteristics	Use	Recommended Model
Capacitance* Bridge	Measuring Frequency: 1kHz Range: 10pF to 1.1μF Resolution: 0.01pF Capacitance Accuracy: 0.01% Dissipation Factor Resolution: better than 10 ⁻⁴ Dissipation Factor Accuracy: 10 ⁻⁴	Performance Test and Calibration	GR Type 1615-A Capacitance Bridge
Oscillator**	Frequency Range Covering: 1kHz Maximum Output: 30V rms into 600Ω load	Performance Test and Calibration	GR Type 1311-A Audio Oscillator
Detector***	Frequency Range Covering: 1kHz Sensitivity: 0.1μV Gain: 120dB	Performance Test and Calibration	GR Type 1232-A Tuned Amplifier and Null Detector
Measuring Cable		Performance Test and Calibration	Shown in Figure 4-1
Testing Plate		Calibration	Shown in Figure 4-2

*, **, ***: These three instruments work together as a capacitance bridge and are substituted by HP Model 4270A Automatic Capacitance Bridge. See paragraph 4-16.

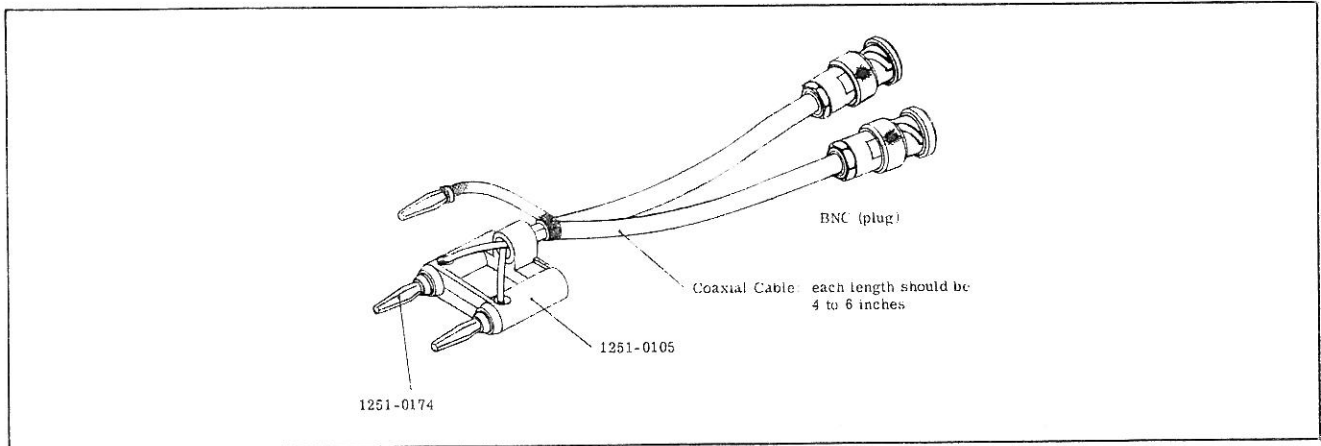

Figure 4-1 Measuring Cable

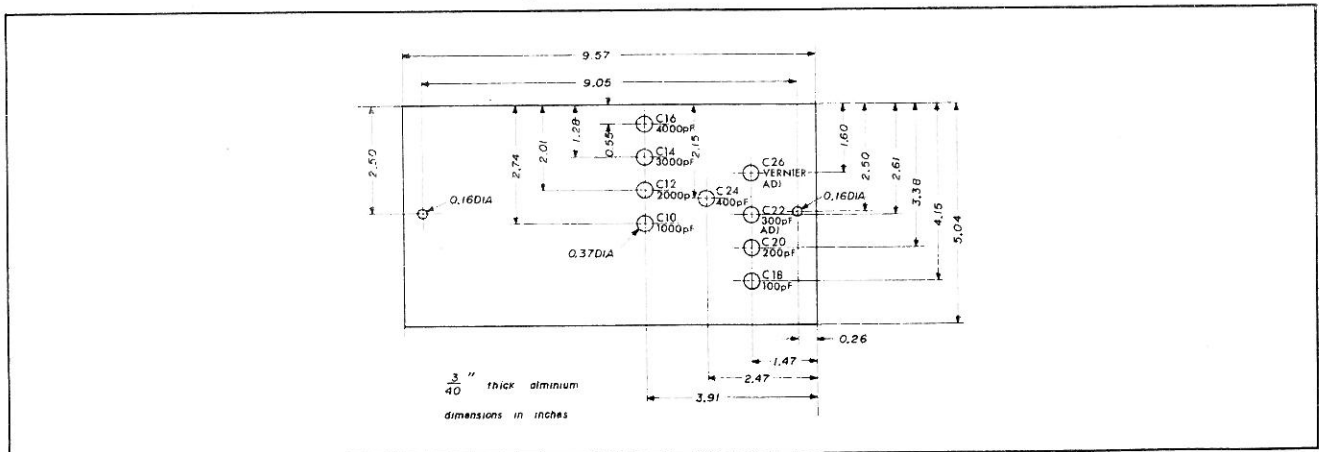

Figure 4-2 Testing Plate

SECTION IV MAINTENANCE

4-1. INTRODUCTION

4-2. Maintenance of the Model 4440B should be minimal unless an overload voltage or physical damages require replacement of a part. This section gives maintenance and service information. Included is a table of recommended test equipment, repair procedures, an in-cabinet performance check.

4-3. TEST EQUIPMENT

4-4. Table 4-1 lists recommended test equipment for maintaining and checking performance of the instrument. Test equipment having equivalent characteristics may be substituted for equipment listed.

4-5. IN-CABINET PERFORMANCE CHECK

4-6. The performance check can be used to verify proper operation of the instrument and also may be used:

- a. As part of an incoming inspection check of instrument specifications.
- b. Periodically, for instruments used in systems where maximum reliability is important.
- c. As part of a procedure to locate defective components.
- d. After any repair or adjustment, before returning instrument to regular service.

- e. As a permanent record of the instrument maintenance performed.

4-7. The performance test setup is illustrated in Figure 4-3. An Oscillator (GR Type 1311-A), a Capacitance Bridge (GR Type 1615-A), and a Detector (GR Type 1232-A) are required for this test. In addition, a special measuring cable assembly as shown in Figure 4-1 is required.

4-8. To perform the performance test, proceed as follows:

- a. Make test setup as illustrated in Figure 4-3.
- b. Set the 1311-A Audio Oscillator controls as follows:
 FREQUENCY dial 1 kHz
 MAXIMUM OUTPUT
 switch . . . 30V, 130mA
 OUTPUT LEVEL 12 o'clock position
 Δ F Dial 0
- c. Set the 1232-A Tuned Amplifier and Null Detector controls as follows:
 GAIN dial 12 o'clock position
 METER switch LOG
 FILTER FREQUENCY
 switch . . . 200Hz - 2kHz
 FILTER TUNING dial . . Set around the scale
 10 to maximize the
 meter deflection.

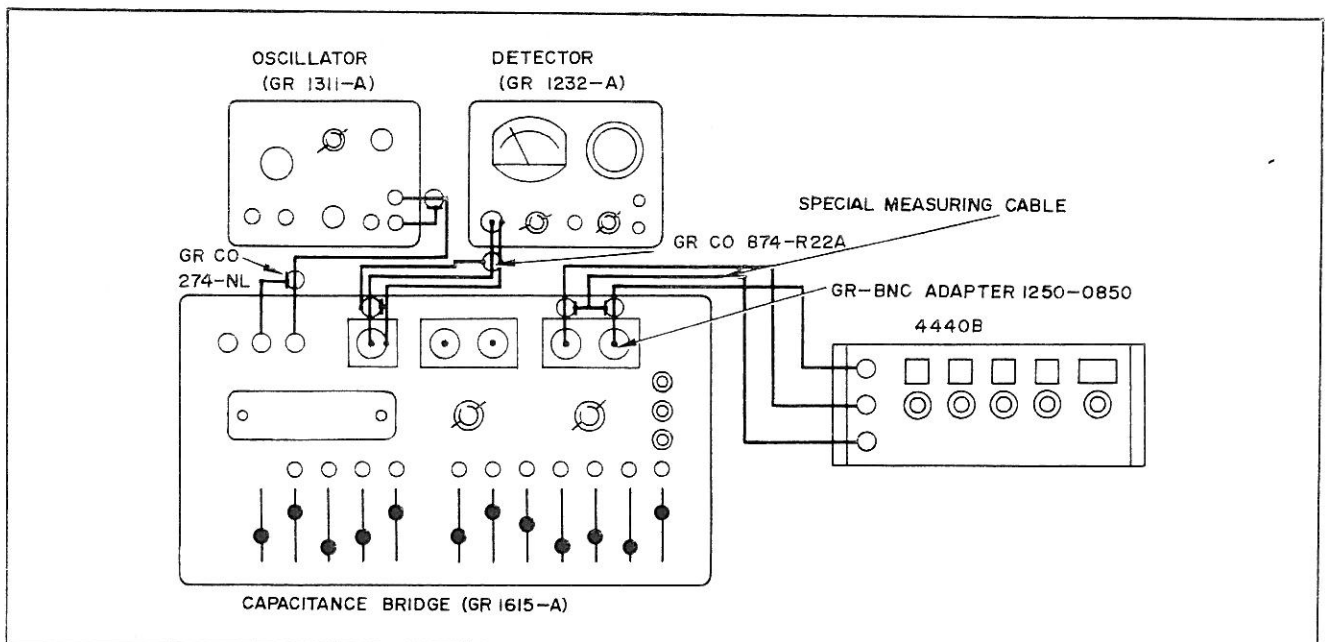

Figure 4-3. Performance Test Setup

- d. Set the 1615-A Capacitance Bridge controls as illustrated in Figure 4-4.
- e. Connect the 1311-A Audio Oscillator OUTPUT and the 1615-A Capacitance Bridge GENERATOR terminals with input cable GR CO 274 - NL. Connect the 1615-A's DETECTOR connector and the 1232-A Tuned Amplifier and Null Detector with cable GR CO 874-R22A.
- f. Turn on the power switches of the 1311-A Audio Oscillator and 1232-A Tuned Amplifier and Null Detector.
- g. Connect the measuring cable to the 1615-A UNKNOWN terminal with GR - BNC (receptacle) adapter, HP Part No. 1250-0850 and measure the residual capacitance of the measuring cable by manipulating 1615-A capacitance controls.

Let the obtained value x .
 x is usually 0.7pF to 1.2pF.

4-9. Set the 4440B as shown in Table 4-2, measure the capacitance between the 4440B terminals. Check that the 1615-A capacitance reading is within the upper and lower limits shown in Table 4-2 and that the dissipation factor reading is less than .001.

NOTE

When measuring higher values of the 4440B (greater than $0.1\mu\text{F}$), the resistance of the measuring cable increases the series loss resulting in an incorrect Dissipation Factor reading of the 1615-A. In this case, use 3 TERMINAL (binding post) position of the 1615-A Terminal Selector and connect the 4440B to these terminals with three pieces of wire with resistance as small as possible (thicker than AWG #20, shorter than 4 inches).

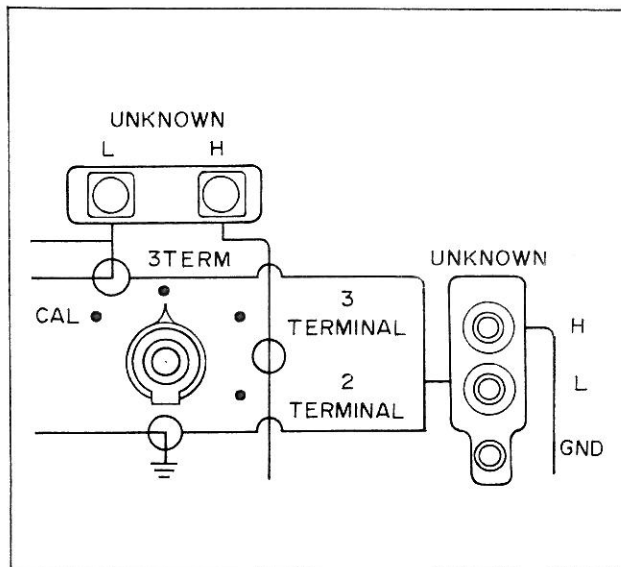

Figure 4-4. 1615-A Capacitance Bridge Setting

4-10. ADJUSTMENT

4-11. When the adjustment of the variable capacitor is necessary, the testing plate (Figure 4-2) should be installed according to the following steps, and an adjusting screw driver with long insulator rod should be used. The Capacitance Bridge reading while adjustment is being made should be equal to the reading after the adjustment is completed.

- a. Remove the top cover by taking out two screws on the rear.
- b. Remove the inside cover plate by taking out two screws at the center of the right and left sides of the plate.
- c. Install the testing plate (Figure 4-2) in place of the inside cover. Fasten it with the two screws taken out in step b.

4-12. Set the Capacitance Bridge same as indicated in paragraph 4-8.

4-13. VERNIER ADJUSTMENT

- a. Set all the dials of four decades to zero, and the vernier scale to 40pF.
- b. Set 1615-A capacitance controls $(40 + x)\text{pF}$, and adjust C26 to minimize the meter deflection of the 1232-A "Tuned Amplifier and Null Detector" using the adjusting driver. Rotate the vernier dial, and set vernier scale to 140pF. Make the 1615-A Capacitance Bridge balance by manipulating capacitance and dissipation factor-conductance controls, with D MAX knob set at 0.01, and read the capacitance and dissipation factor. The reading should be between $(135.65 + x)\text{pF}$ and $(143.35 + x)\text{pF}$. Dissipation factor should be less than .001.
- c. Set vernier scale to 120pF, 100pF, 80pF and 60pF, make the 1615-A Capacitance Bridge balance at each setting and make sure that the reading is within the limits listed in Table 4-2.
- d. Set vernier scale to 40pF again.

4-14. FOURTH DECADE ADJUSTMENT

- a. Without moving vernier scale, set the fourth decade dial of 4440B to 1 (equivalent to 100pF).
- b. Set capacitance control of 1615-A to $(140 + x)\text{pF}$. Adjust C18 and manipulate the dissipation factor control for the minimum deflection on the 1232A meter. Dissipation factor readout should be less than .001.
- c. Set the fourth decade dial to 2 (equivalent to 200pF), set capacitance control of 1615-A to $(240 + x)\text{pF}$ and balance the 1615-A by following the same steps as indicated in step b. with the adjustment of C20.

Table 4-2. Capacitance Check

4440B Setting		1615-A Reading		4270A Reading	
Decade Switch	Vernier Control	Lower Limit	Upper Limit	Lower Limit	Upper Limit
0000	40 pF	36.90 + x	43.10 + x	36.95 + x	43.05 + x
0000	60 pF	56.85 + x	63.15 + x	56.92 + x	63.08 + x
0000	80 pF	76.80 + x	83.20 + x	76.89 + x	83.11 + x
0000	100 pF	96.75 + x	103.25 + x	96.86 + x	103.14 + x
0000	120 pF	116.70 + x	123.30 + x	116.83 + x	123.17 + x
0000	140 pF	136.65 + x	143.35 + x	136.80 + x	143.20 + x
0001		136.65 + x	143.35 + x	136.80 + x	143.20 + x
0002		236.40 + x	243.60 + x	236.65 + x	243.35 + x
0003		336.15 + x	343.85 + x	336.50 + x	343.50 + x
0004		435.90 + x	444.10 + x	436.35 + x	443.65 + x
0005	40 pF	535.65 + x	544.35 + x	536.20 + x	543.80 + x
0006		635.40 + x	644.60 + x	636.05 + x	643.95 + x
0007		735.15 + x	744.85 + x	735.90 + x	744.10 + x
0008		834.90 + x	845.10 + x	835.75 + x	844.25 + x
0009		934.65 + x	945.35 + x	935.60 + x	944.65 + x
0010		1034.5 + x	1045.5 + x	1035.6 + x	1044.4 + x
0020		2032.0 + x	2048.0 + x	2034.1 + x	2045.9 + x
0030		3029.5 + x	3050.5 + x	3032.6 + x	3047.4 + x
0040		4027.0 + x	4053.0 + x	4031.1 + x	4048.9 + x
0050	40 pF	5024.5 + x	5055.5 + x	5029.6 + x	5050.4 + x
0060		6022.0 + x	6058.0 + x	6028.1 + x	6051.9 + x
0070		7019.5 + x	7060.5 + x	7026.6 + x	7053.4 + x
0080		8017.0 + x	8063.0 + x	8025.1 + x	8054.9 + x
0090		9014.5 + x	9065.5 + x	9023.6 + x	9056.4 + x
0100		10014 + x	10068 + x	10024 + x	10058 + x
0200		19987 + x	20093 + x	20007 + x	20073 + x
0300		29962 + x	30118 + x	29992 + x	30088 + x
0400		39937 + x	40143 + x	39977 + x	40103 + x
0500	40 pF	49912 + x	50168 + x	49962 + x	50118 + x
0600		59887 + x	60193 + x	59947 + x	60133 + x
0700		69862 + x	70218 + x	69932 + x	70148 + x
0800		79837 + x	80243 + x	79917 + x	80163 + x
0900		89812 + x	90268 + x	89902 + x	90178 + x
.1000		99787	100293	99.89 nF	100.19 nF
.2000		199537	200543	199.8 nF	200.3 nF
.3000		299287	300793	299.6 nF	300.5 nF
.4000		399037	401043	399.5 nF	400.6 nF
.5000		498787	501293	499.3 nF	500.8 nF
.6000	40 pF	598537	601543	599.2 nF	600.9 nF
.7000		698287	701793	699.0 nF	701.1 nF
.8000		798037	802043	798.9 nF	801.2 nF
.9000		897787	902293	898.7 nF	901.4 nF
1.0000		997537	1002543	998.6 nF	1.0015 μ F
1.1000		1097287	1102793	1.0984 μ F	1.1017 μ F

- d. Set the fourth decade dial to 3 (equivalent to 300 pF), set capacitance control of 1615-A to $(340 + x)$ pF and balance the 1615-A by following the same steps as indicated in step b. with the adjustment of C22.
- e. Set the fourth decade dial to 4 (equivalent to 400 pF), set capacitance control of 1615-A to $(440 + x)$ pF and balance the 1615-A by following the same steps as indicated in step b. with the adjustment of C24.
- f. Set the fourth decade dial to 5, 6, 7, 8, 9, and balance the 1615-A by manipulating the Capacitance and Dissipation Factor - Conductance controls. Capacitance readout should be within the limits indicated in Table 4-2. Dissipation Factor readout should be less than .001.

4-15. THIRD DECADE ADJUSTMENT

- a. Without moving vernier scale, set the third decade dial of 4440B to 1 (equivalent to 1000pF) and set the fourth decade to 0.
- b. Set capacitance control of 1615-A to $(1040 + x)$ pF, adjust C10 and manipulate the dissipation factor control for the minimum deflection on the 1232 - A meter. Dissipation factor readout should be less than .001.
- c. Set the third decade dial of 4440B to 2 (equivalent to 2000pF), set capacitance control of 1615-A to $(2040 + x)$ pF, and balance the 1615-A as indicated in step b. with the adjustment of C12.
- d. Set the third decade dial of 4440B to 3 (equivalent to 3000pF), set capacitance control of 1615-A to $(3040 + x)$ pF, and balance the 1615-A as indicated in step b. with the adjustment of C14.
- e. Set the third decade dial to 4 (equivalent to 4000pF), set capacitance control of 1615-A to $(4040 + x)$ pF and balance the 1615-A as indicated in step b. with the adjustment of C16.
- f. Set the third decade dial to 5, 6, 7, 8, 9, and balance the 1615-A. Capacitance readout should be within the limits indicated in Table 4-2. Dissipation Factor readout should be less than .001.

4-16. This paragraph describes how to calibrate the capacitance of the 4440B when it is not necessary to confirm the dissipation factor less than .001. This easier and simpler way of capacitance calibration is performed by HP Model 4270A. Automatic Capacitance Bridge. (No oscillator and null detector are necessary). Dissipation factor accuracy of 4270A is:

$$1\% \text{ of reading} + (10 + C_s/C_x) \text{ counts}$$

so the dissipation factor of 4440B can not be confirmed. Performance Check and Adjustment can be done according to paragraphs 4-7 through 4-15 with Table 4-2 and the following change.

Adjustment with C18(4-14, b), C20(4-14, c), C22(4-14, d), C24(4-14, e), C10(4-15, b), C12 (4-15, c), C14(4-15, d), C16(4-15, e), should be changed as: (for example)

4-14, a. b. should be as follows:

Without moving vernier scale, set the fourth decade dial of 4440B to 1 (equivalent to 100pF). Adjust C18 for the 4270A reading of $(140 + x)$ pF.

4-17. TROUBLESHOOTING

4-18. LOCAL TROUBLE: When wrong capacitance or dissipation factor values are found at a certain setting or at a certain series of settings, check the associated components shown in Table 4-3 through 4-6, or the associated decade switch and connections between the components. Parts location is illustrated in Figure 4-5.

4-19. TROUBLE IN VARIABLE CAPACITOR: If dissipation factor is greater than .001, at a certain setting, see if there is not any specks of dirt between the plates of the associated variable capacitor. Sometimes these tend to increase the dissipation factor readings. Blowing or wiping off these specks will improve the reading.

4-20. OVERALL TROUBLE: When a wrong value of capacitance or dissipation factor is presented at all the settings, the trouble should be allocated to one of six portions of the 4440B, terminal portion, 1st decade, 2nd decade, 3rd decade 4th decade and vernier portion. These six portions are connected by a wire which runs below the four decade switches and is terminated at the solder lug of the HIGH terminal. The possible causes of troubles are:

- a. Terminal portion: wrong insulator between HIGH terminal and LOW terminal (Common Floating Ground), wrong binding post.
- b. Decade switch portion: wrong insulator between the common of the switch connected to HIGH terminal and Common Floating Ground, dirty rotor of the switch, wrong wiring configuration.
- c. Vernier portion: trouble in vernier capacitor C25 or variable capacitor C26, specks of dirt on these components.

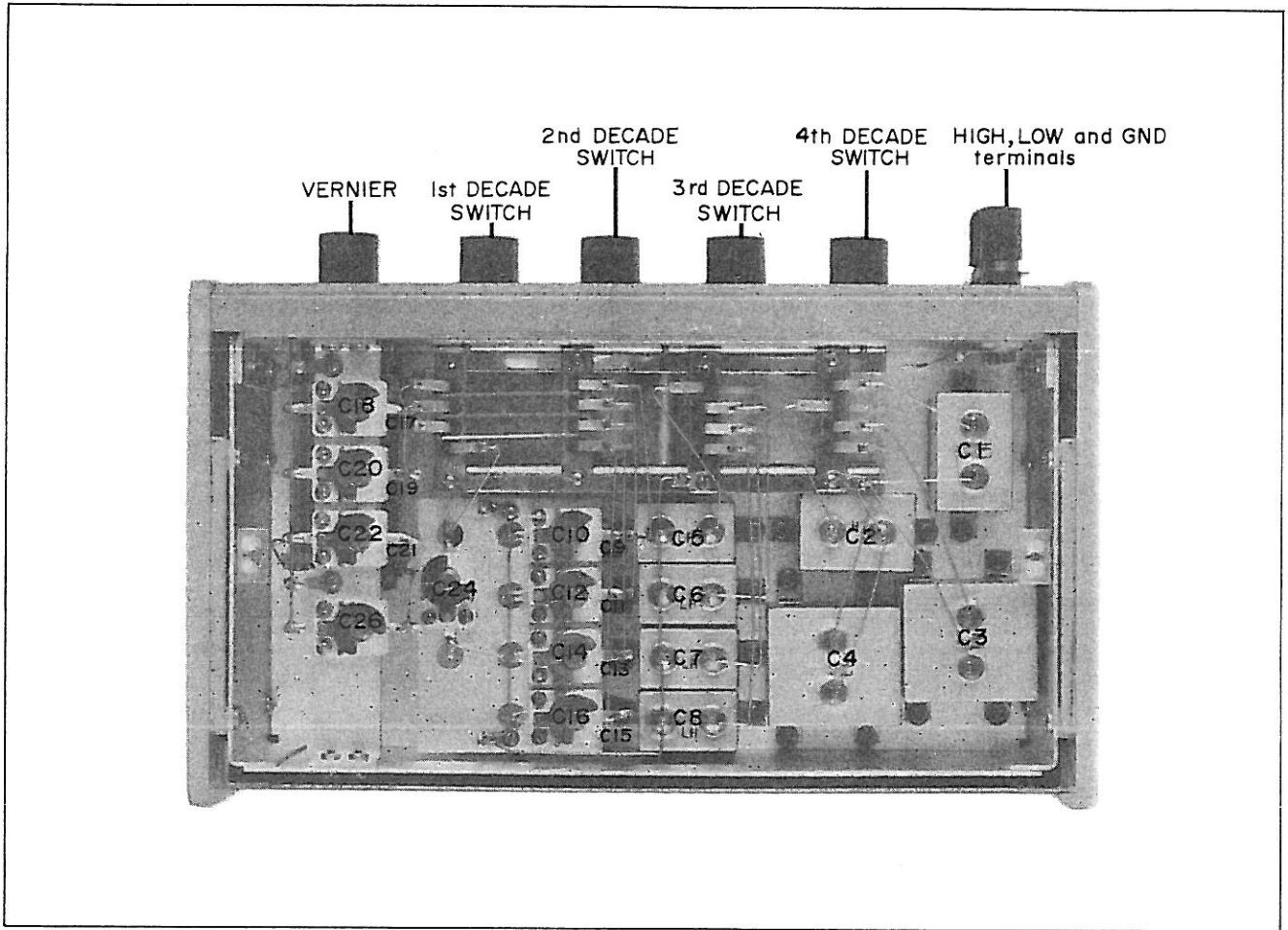

Figure 4-5. Parts Location

Table 4-3. Composition of the 1st Decade

Component Dial Setting	0.1 μ F C1	0.2 μ F C2	0.4 μ F C3	0.4 μ F C4
.0	-	-	-	-
.1	○	-	-	-
.2	-	○	-	-
.3	○	○	-	-
.4	-	-	○	-
.5	○	-	-	○
.6	-	○	-	○
.7	○	○	-	○
.8	-	-	○	○
.9	○	-	○	○
1.0	-	○	○	○
1.1	○	○	○	○

Table 4-4. Composition of the 2nd Decade

Component Dial Setting	0.01 μ F C5	0.02 μ F C6	0.03 μ F C7	0.03 μ F C8
0	-	-	-	-
1	○	-	-	-
2	-	○	-	-
3	-	-	○	-
4	○	-	-	○
5	-	○	-	○
6	-	-	○	○
7	○	-	○	○
8	-	○	○	○
9	○	○	○	○

Table 4-5. Composition of the 3rd Decade

Component Dial Setting	1000pF C9+C10	2000pF C11+C12	3000pF C13+C14	3000pF C15+C16
0	-	-	-	-
1	○	-	-	-
2	-	○	-	-
3	-	-	○	-
4	○	-	-	○
5	-	○	-	○
6	-	-	○	○
7	○	-	○	○
8	-	○	○	○
9	○	○	○	○

Table 4-6. Composition of the 4th Decade

Component Dial Setting	100pF C17+C18	200pF C19+C20	300pF C21+C22	300pF C23+C24
0	-	-	-	-
1	○	-	-	-
2	-	○	-	-
3	-	-	○	-
4	○	-	-	○
5	-	○	-	○
6	-	-	○	○
7	○	-	○	○
8	-	○	○	○
9	○	○	○	○

Note

After using and/or for storage, set decade switches to 1.1999 μ F position. This setting keeps all (four) contacts of the four decade switches closed so that contact stress and corrosion is minimized.

SECTION V REPLACEABLE PARTS

5-1. INTRODUCTION

5-2. This section contains information for ordering replacement parts. Table 5-2 lists parts in alphabetical order of their reference designators and indicates the description (see Table 5-1 for abbreviations used) and HP Part number of each part, together with any applicable notes.

5-3. Miscellaneous parts associated with each assembly are listed at the end of each assembly listing. Others are listed at the end of Table 5-2.

5-4. ORDERING INFORMATION

5-5. To obtain replacement parts, address order or inquiry to your local Hewlett-Packard Field Office (see lists at rear of this manual for addresses). Identify parts by their Hewlett-Packard part numbers.

5-6. To obtain a part that is not listed, include:

- a. Instrument model number.
- b. Instrument serial number.
- c. Description of the part.
- d. Function and location of the part.

Table 5-1. List of Reference Designators and Abbreviations

REFERENCE DESIGNATORS					
A = assembly B = motor BT = battery C = capacitor CP = coupler CR = diode DL = delay line DS = device signaling (lamp)	E = misc electronic part F = fuse FL = filter IC = integrated circuit J = jack K = relay L = inductor M = meter	MP = mechanical part P = plug Q = transistor R = resistor RT = thermistor S = switch T = transformer TB = terminal board	TP = test point V = vacuum tube, neon bulb, photocell, etc. VR = voltage regulator W = cable X = socket Y = crystal		
ABBREVIATIONS					
A = amperes A. F. C. = automatic frequency control AMPL = amplifier B. F. O. = beat frequency oscillator BE CU = beryllium copper BH = binder head BP = bandpass BRS = brass BWO = backward wave oscillator CCW = counter-clockwise CER = ceramic CMO = cabinet mount only COEF = coefficient COM = common COMP = composition COMPL = complete CONN = connector CP = cadmium plate CRT = cathode-ray tube CW = clockwise DEPC = deposited carbon DR = drive ELECT = electrolytic ENCAP = encapsulated EXT = external F = farads f = femto = 10 ⁻¹⁵ FH = flat head FIL H = filister head FXD = fixed G = giga = 10 ⁹ GE = germanium GL = glass GRD = grounded	H = henries HEX = hexagonal HG = mercury HR = hour(s) Hz = hertz IF = intermediate freq. IMPG = impregnated INCD = incandescent INCL = include(s) INS = insulation(ed) INT = internal k = kilo = 1000 LH = left hand LIN = linear taper LK WASH = lock washer LOG = logarithmic taper LPF = low pass filter m = milli = 10 ⁻³ M = meg = 10 ⁶ MET FLM = metal film MET OX = metallic oxide MFR = manufacturer MINAT = miniature MOM = momentary MTG = mounting MY = "mylar" n = nano = 10 ⁻⁹ N C = normally closed NE = neon NI PL = nickel plate N O = normally open NPO = negative positive zero (zero temperature coefficient)	NPN = negative-positive-negative NRFR = not recommended for field replacement NSR = not separately replaceable OBD = order by description OH = oval head OX = oxide P = peak PC = printed circuit p = pico = 10 ⁻¹² PH BRZ = phosphor bronze PHL = Phillips PIV = peak inverse voltage PNP = positive-negative-positive P/O = part of POLY = polystyrene PORC = porcelain POS = position(s) POT = potentiometer PP = peak-to-peak PT = point PWV = peak working voltage RECT = rectifier RF = radio frequency RH = round head or right hand RMO = rack mount only RMS = root-mean square	RWV = reverse working voltage S-B = slow-blow SCR = screw SE = selenium SECT = section(s) SEMICON = semiconductor SI = silicon SIL = silver SL = slide SPG = spring SPL = special SST = stainless steel SR = split ring STL = steel TA = tantalum TD = time delay TGL = toggle THD = thread TI = titanium TOL = tolerance TRIM = trimmer TWT = traveling wave tube μ = micro = 10 ⁻⁶ VAR = variable VDCW = dc working volts W = with W = watts WIV = working inverse voltage WW = wirewound W/O = without		

0001-9700

Table 5-2. Reference Designation Index

Reference Designation	HP Part No.	Description	Note
C1	0160-1571	C:FXD S. MICA 0.1 μ F 0.2% 500VDCW	
C2	0160-1570	C:FXD S. MICA 0.2 μ F 0.2% 500VDCW	
C3	0160-1569	C:FXD S. MICA 0.4 μ F 0.2% 500VDCW	
C4	0160-1569	C:FXD S. MICA 0.4 μ F 0.2% 500VDCW	
C5	0160-1574	C:FXD S. MICA 0.01 μ F 0.2% 500VDCW	
C6	0160-1573	C:FXD S. MICA 0.02 μ F 0.2% 500VDCW	
C7	0160-1572	C:FXD S. MICA 0.03 μ F 0.2% 500VDCW	
C8	0160-1572	C:FXD S. MICA 0.03 μ F 0.2% 500VDCW	
C9	0160-1577	C:FXD S. MICA 980pF 1% 500VDCW	
C10	0121-0229	C:VAR AIR 2.5-35pF 500VDCW	
C11	0160-1576	C:FXD S. MICA 1970pF 0.5% 500VDCW	
C12	0121-0229	C:VAR AIR 2.5-35pF 500VDCW	
C13	0160-1575	C:FXD S. MICA 2980pF 0.5% 500VDCW	
C14	0121-0229	C:VAR AIR 2.5-35pF 500VDCW	
C15	0160-1575	C:FXD S. MICA 2980pF 0.5% 500VDCW	
C16	0121-0229	C:VAR AIR 2.5-35pF 500VDCW	
C17	0160-1580	C:FXD S. MICA 90pF 1% 500VDCW	
C18	0121-0227	C:VAR AIR 1.5-10pF 500VDCW	
C19	0160-1579	C:FXD S. MICA 190pF 1% 500VDCW	
C20	0121-0227	C:VAR AIR 1.5-10pF 500VDCW	
C21	0160-1578	C:FXD S. MICA 290pF 1% 500VDCW	
C22	0121-0227	C:VAR AIR 1.5-10pF 500VDCW	
C23	0160-1578	C:FXD S. MICA 290pF 1% 500VDCW	
C24	0121-0227	C:VAR AIR 1.5-10pF 500VDCW	
C25	0121-0226	C:VAR AIR 8-115pF 500VDCW	
C26	0121-0227	C:VAR AIR 1.5-10pF 500VDCW	
J1	04440-7048 04440-5021 04440-3021	TERMINAL:HIGH BINDING POST ASS'Y:RED INSULATOR:FRONT INSULATOR:REAR	
J2	1510-0006 04440-5021	TERMINAL:LOW BINDING POST:BLACK INSULATOR:FRONT	
J3	04440-3028 0340-0223	TERMINA:GROUND (\perp) BINDING POST ASS'Y:BLACK INSULATOR:FRONT	

See list of abbreviations in introduction to this section

Table 5-2. Reference Designation Index (Cont'd)

Reference Designation	HP Part No.	Description	Note	
S1-S4	3100-0909	SWITCH ASS'Y:DECADE		
	04440-7047	CONTACT:BAR 4 REQ'D		
	04440-5022	CONTACT:ASS'Y 4 REQ'D		
	04440-5023	CAM:10 POSITION FOR S2-S4 3 REQ'D		
		04440-5023	CAM:12 POSITION FOR S1	
		1460-0307	SPRING:COIL 2 REQ'D	
		04260-1067	ARM:CLICK 4 REQ'D	
		04260-3056	ROLLER:CLICK 4 REQ'D	
		04260-3057	SHAFT:CLICK 2 REQ'D	
		04440-1028	ANGLE:L REAR	
		04440-1029	ANGLE:L FRONT	
		04440-1040	PLATE:SHIELD 3 REQ'D	
		04440-1044	CHASSIS:SWITCH ASS'Y	
		04440-3022	INSULATOR:BAR CONTACT 8 REQ'D	
		04440-3023	STUD 4 REQ'D	
		04440-3025	SPACER	
			MISCELLANEOUS	
		5040-3316	FRAME:SIDE 2 REQ'D	
		04440-1139	PANEL:FRONT	
		04440-1125	PANEL:FRONT	
		04440-1134	COVER:TOP	
		04440-1135	COVER:BOTTOM	
		5000-4197	COVER:SIDE 2 REQ'D	
		0370-0025	KNOB:ROUND 3/4" DIA BLACK 5 REQ'D	
		1520-0115	CUSHION:FOOT 4 REQ'D	
		04440-5124	DIAL:DECADE SWITCH FOR S2 - S4 3 REQ'D	
		04440-5125	DIAL:DECADE SWITCH FOR S1	
		04440-5127	DIAL:VERNIER	
		04440-5126	TRIM:FRONT PANEL 2 REQ'D	
		04440-1026	CASE:SHIELD	
		04440-1036	PLATE:SHIELD CASE	
		04440-1032	PLATE:CAPACITOR ASS'Y	
		04440-1033	ANGLE:L 2 REQ'D	
	04440-1038	SPRING:L ANGLE 2 REQ'D		
	04440-1043	ANGLE:CAPACITOR ASS'Y		
	04440-3023	STUD 2 REQ'D		

See list of abbreviations in introduction to this section

SECTION VI MANUAL CHANGES AND OPTIONS

6-1. OPTIONS

6-2. Options are standard modifications performed on HP instruments at the factory. No options for the Model 4440B are offered at the present time.

6-3. SPECIAL INSTRUMENTS

6-4. "Specials" are standard HP instrument that are modified according to customer specifications. A separate insert sheet is included with the manual for special instruments having electrical changes. Make the changes specified in addition to any other changes that are necessary.

6-5. MANUAL CHANGES

6-6. This manual applies directly to the Model 4440B with serials 935/936-00631 and above. The following paragraphs explain how to adapt this manual to apply to later instruments with higher serial prefix, or earlier instruments with lower serial prefix. Technical corrections to this manual (if any) are called errata and are listed on a separate "Manual Changes" sheet supplied with this manual.

6-7. LATER INSTRUMENTS: If the serial prefix of your Model 4440B is above 935/936, refer to a separate "Manual Changes" sheet supplied with this manual. Locate the serial prefix of your instrument and make the indicated changes.

6-8. EARLIER INSTRUMENTS(Backdating Changes): If the serial prefix of your Model 4440B is 935/936-00630 and below, refer to Table 6-1 for the changes necessary to adapt this manual to your particular

instrument. Locate the serial prefix of your instrument in the table and make the indicated changes. Note that instrument-component values that differ from those in this manual, yet are not listed in this backdating changes, should be replaced using the part number given in this manual.

Table 6-1. Backdating Changes

Instrument Serial Prefix or Number	Make Changes
813/814	1, 2, 3, 4, 5, 6, 7
815/816-00250 and below	2, 3, 4, 5, 6, 7
815/816-00370 and below	3, 4, 5, 6, 7
919/920-00400 and below	4, 5, 6, 7
935/936-00520 and below	5, 6, 7
935/936-00630 and below	6, 7
935/936 and below	7

CHANGE 1

Page 5-2, Table 5-2, Reference Designation Index
Delete C18*, C20*, C22* and C24*

Page 7-3, Figure 7-2, Schematic Diagram
Delete C18*, C20*, C22* and C24* from circuit.

CHANGE 2

Page 5-2, Table 5-2, Reference Designation Index
Delete P/O J1 HP Part No. 04440-7048, BINDING POST ASS'Y:RED
Add P/O J1 HP Part No. 1510-0007, BINDING POST:RED

CHANGE 3

Page 5-3, Table 5-2, Reference Designation Index, Miscellaneous
Change HP Part No. of ANGLE:CAPACITOR ASS'Y to 04440-1041.

CHANGE 4

- Page 5-2, Table 5-2, Reference Designation Index
Change HP Part No. of 0340-0223 (P/O J3) INSULATOR:FRONT to 04260-5021
- Page 5-3, Table 5-2, Reference Designation Index
Change HP Part No. of 04440-1044(P/O S1-S4), CHASSIS:SWITCH ASS'Y to 04440-1027

CHANGE 5

- Page 5-2, Table 5-2, Reference Designation Index
Change C26* to HP Part No. 0121-0228, C:VAR AIR 2-15pF 500VDCW.
- Page 7-3, Figure 7-2, Schematic Diagram
Change value of C26* to 2-15pF.

CHANGE 6

- Page 5-3, Table 5-2, Reference Designation Index, Miscellaneous
Change HP Part No. of DIAL:VERNIER to 04440-1037.

CHANGE 7

- Page 5-2, Table 5-2, Reference Designation Index
Change HP Part No. of MISCELLANEOUS parts as follows:

5040-3316 (FRAME:SIDE) to 5040-3310.
04440-1139 (PANEL:FLONT) to 04440-1039.
04440-1125 (PANEL:FLONT) to 04440-1025.
04440-1134 (COVER:TOP) to 04440-1034.
04440-1135 (COVER:BOTTOM) to 04440-1035.
5000-4197 (COVER:SIDE) to 04440-1031.
04440-5124 (DIAL:DECADE) to 04440-5024.
04440-5125 (DIAL:DECADE) to 04440-5025.
04440-5127 (DIAL:VERNIER) to 04440-5027.
04440-5126 (TRIM:FRONT) to 04440-5026.

SECTION VII
CIRCUIT DIAGRAM

- 7-1. INTRODUCTION
- 7-2. This section includes the following:
- a. General Notes for schematic diagram.
 - b. Schematic Diagram and Parts Location Illustration.
- 7-3. GENERAL NOTES
- a. Unless other wise indicated, resistance is in ohms, capacitance is in microfarads, and inductance is in microhenries.
 - b. Components assigned an asterisk(*) are factory selected, average values shown.
- c. The components mounted on chassis or main-frame parts are not assigned an assembly designation (i. e. R1, Q1, etc.).
 - d. Reference designations (R1, Q1, etc.) within assembly (A1, A2, etc.) use assembly designation as prefix to form complete designation (i. e. R1 in A1 assembly is A1R1).
 - e. (9. 4. 7) indicates wire color code. Wire color code (MIL-STD-681) same as resistor color code. First number identifies ground color, second number identifies wide stripe, and third number identifies narrow stripe, i. e. (9. 4. 7) denotes white ground, yellow wide stripe, violet narrow stripe.
- 7-4. Additional notes are shown in Figure 7-1.

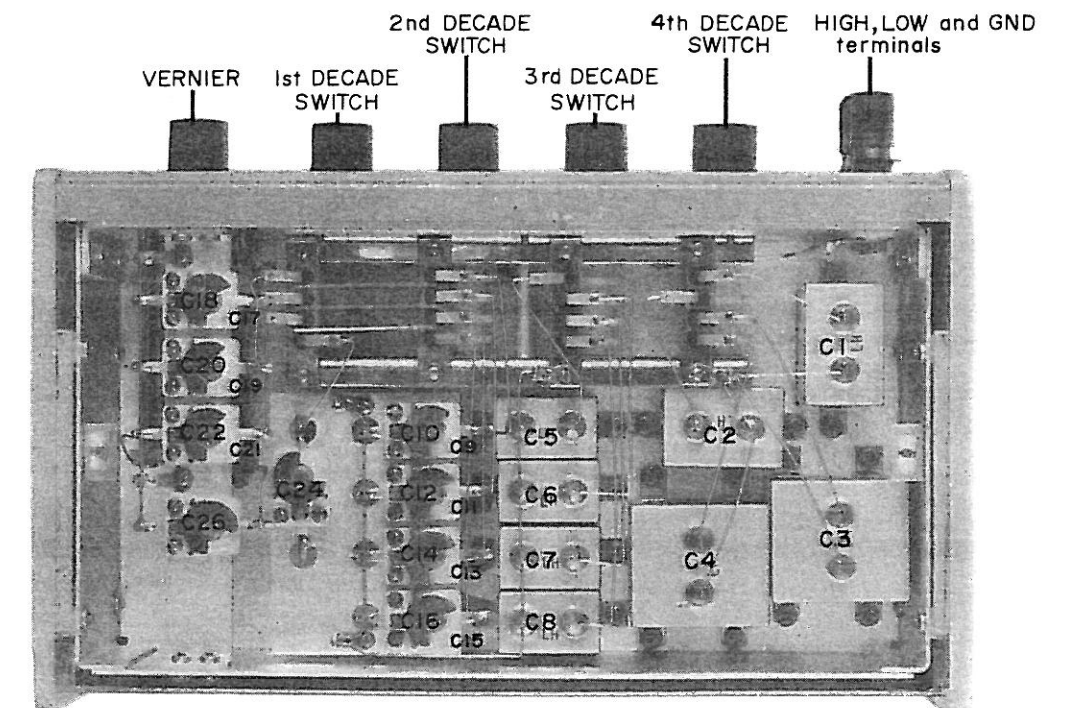
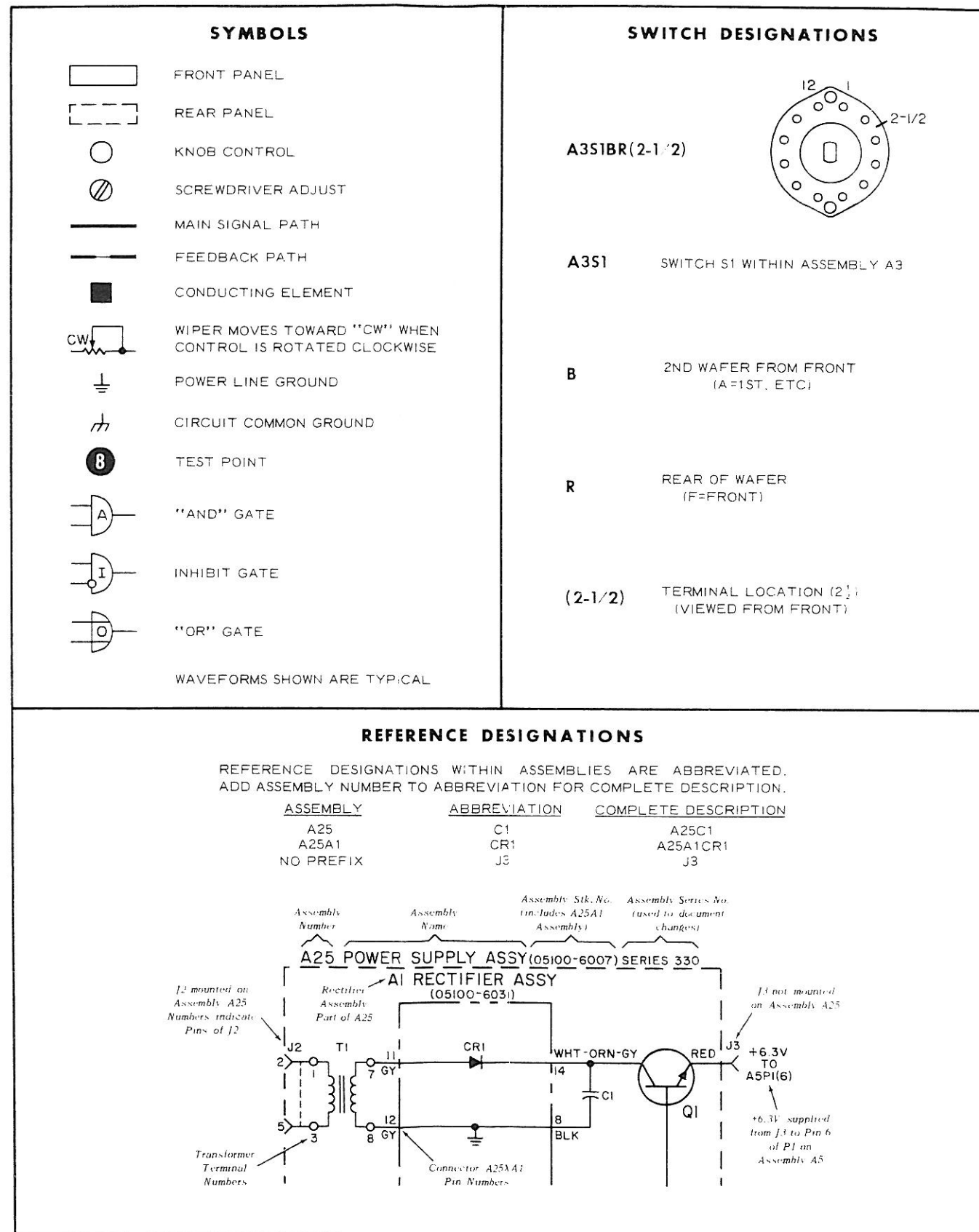

4440B DECADE CAPACITOR

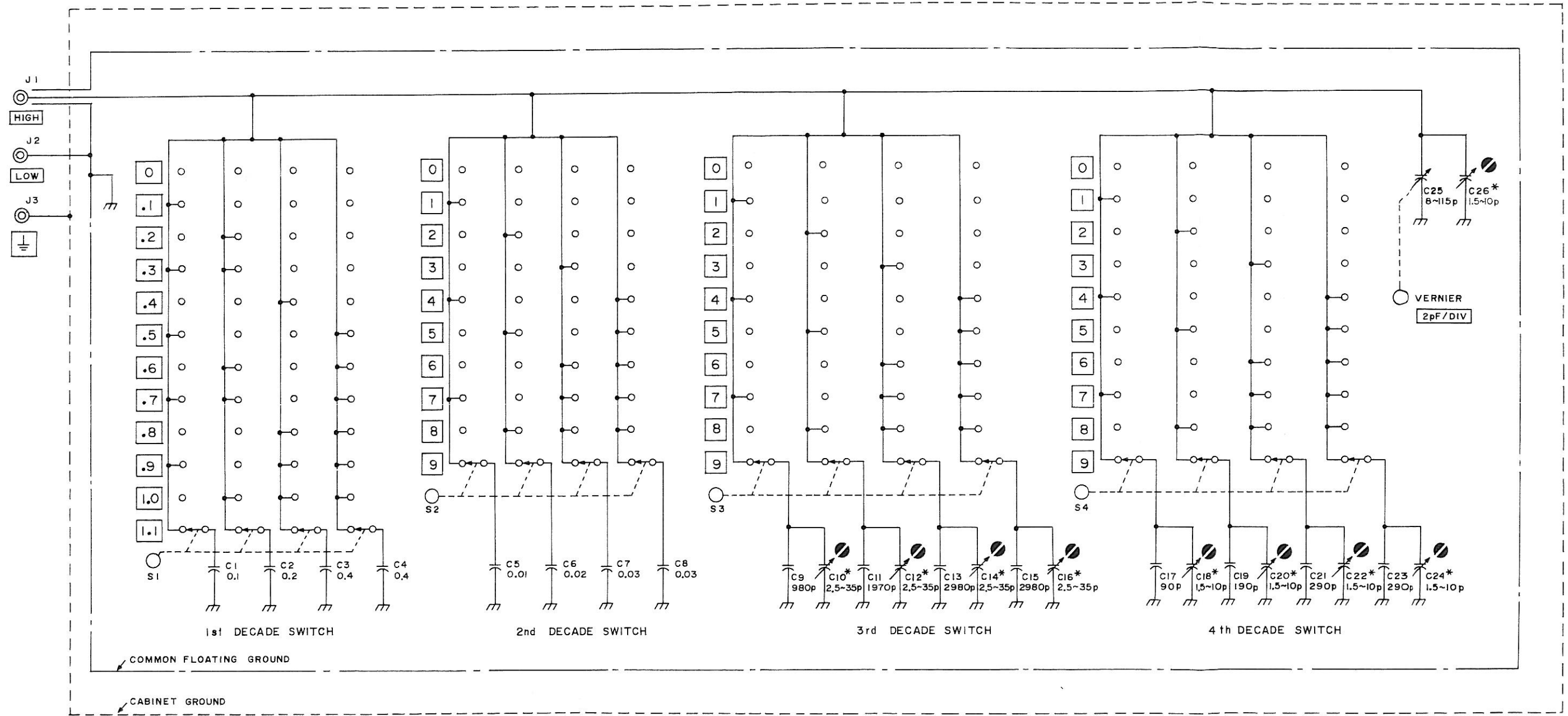

COPYRIGHT 1968 BY YOKOGAWA-HEWLETT-PACKARD, LTD.

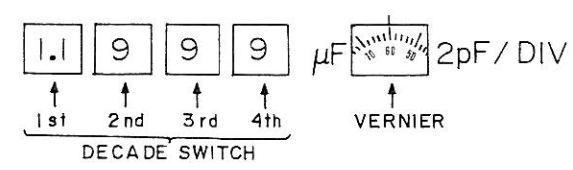
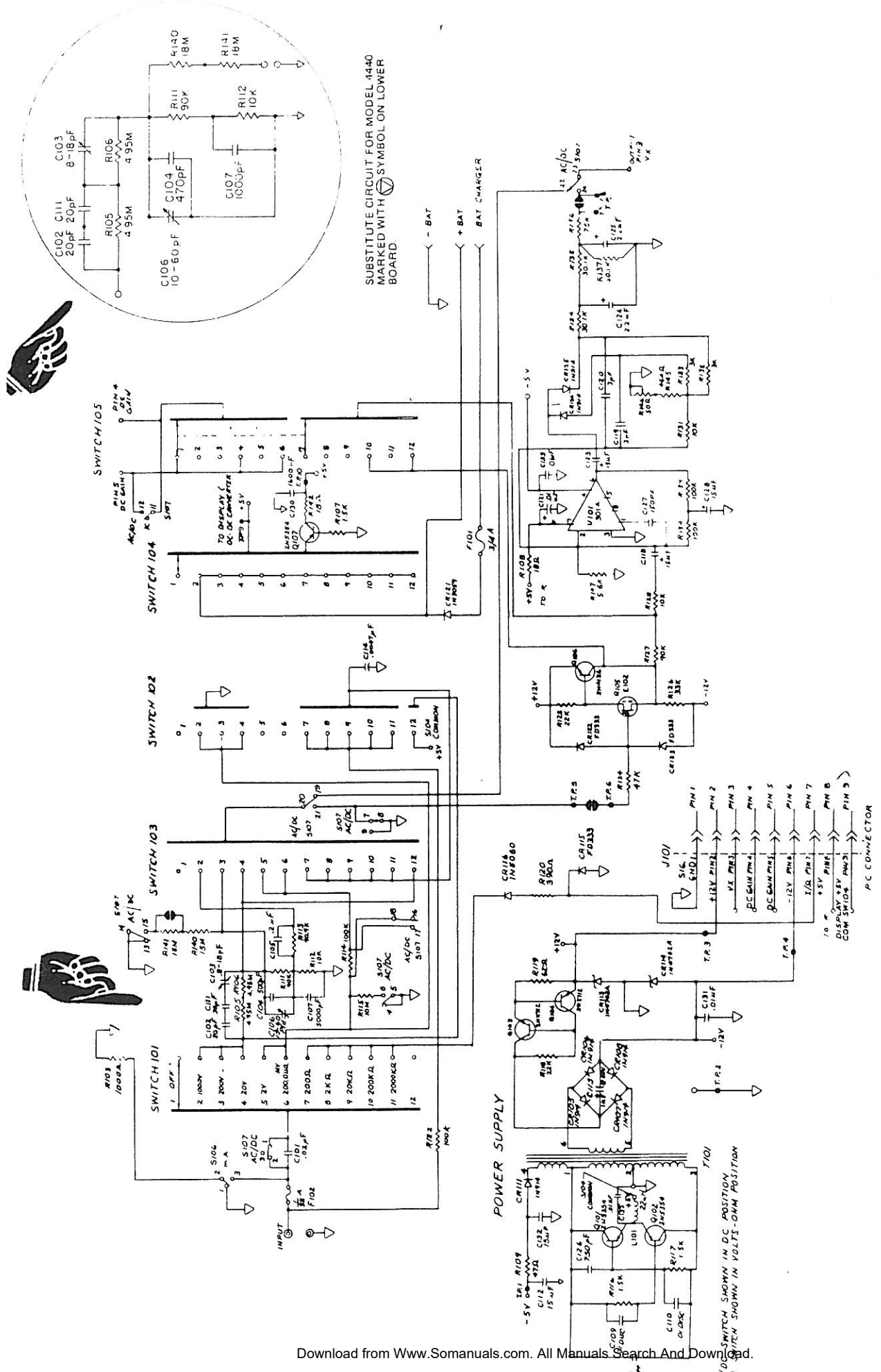

Figure 7-2. Model 4440B Schematic Diagram



SUBSTITUTE CIRCUIT FOR MODEL 4440
 MARKED WITH SYMBOL ON LOWER
 BOARD.

Figure 7-3. Schematic Diagram, Lower Board

Free Manuals Download Website

<http://myh66.com>

<http://usermanuals.us>

<http://www.somanuals.com>

<http://www.4manuals.cc>

<http://www.manual-lib.com>

<http://www.404manual.com>

<http://www.luxmanual.com>

<http://aubethermostatmanual.com>

Golf course search by state

<http://golfingnear.com>

Email search by domain

<http://emailbydomain.com>

Auto manuals search

<http://auto.somanuals.com>

TV manuals search

<http://tv.somanuals.com>