

smart
SMA

User Manual

SO
SA
SA

Please Read Before Proceeding

THIS DEVICE IS NOT FULLY CHARGED WHEN YOU TAKE IT OUT OF THE BOX.

DO NOT REMOVE THE BATTERY PACK WHEN THE DEVICE IS CHARGING.



YOUR WARRANTY IS INVALIDATED IF YOU OPEN OR TAMPER WITH THE DEVICE'S OUTER CASING.

PRIVACY RESTRICTIONS

Some countries require full disclosure of recorded telephone conversations, and stipulate that you must inform the person with whom you are speaking that the conversation is being recorded. Always obey the relevant laws and regulations of your country when using the recording feature of your Pocket PC Phone.

INTELLECTUAL PROPERTY RIGHT INFORMATION

Copyright © 2006 High Tech Computer Corp. All rights reserved.

    ExtUSB are trademarks and/or service marks of High Tech Computer Corp.

Microsoft, MS-DOS, Windows, Windows NT, Windows Server, Windows Mobile, ActiveSync, Excel, Internet Explorer, MSN, Hotmail, Outlook, PowerPoint, Word, and Windows Media are either registered trademarks or trademarks of Microsoft Corporation in the United States and/or other countries.

Bluetooth and the Bluetooth logo are trademarks owned by Bluetooth SIG, Inc.

microSD is a trademark of SD Card Association.

Java, J2ME and all other Java-based marks are trademarks or registered trademarks of Sun Microsystems, Inc. in the United States and other countries.

Copyright © 2006, Adobe Systems Incorporated.

Copyright © 2006, Macromedia Netherlands, B.V.

Macromedia, Flash, Macromedia Flash, Macromedia Flash Lite and Reader are trademarks and/or registered trademarks of Macromedia Netherlands, B.V. or Adobe Systems Incorporated.

Copyright © 2006, JATAAYU SOFTWARE (P) LTD. All Rights Reserved.

Copyright © 2006, Tao Group Limited. All Rights Reserved.

Copyright © 2006, Tegic Communications. T9 and XT9 are trademarks or registered trademarks of Tegic Communications. XT9 Mobile Interface is licensed under one or more of the following: U.S. Pat. Nos. 5,187,480, 5,818,437, 5,945,928, 5,953,541, 6,011,554, 6,286,064, 6,307,548, 6,307,549, and 6,636,162, 6,646,573, 6,970,599, 6,801,190, 7,030,863, 7,088,345; Australia Pat. Nos.

727539, 746674, 747901; Austria Pat. Nos. AT225534, AT221222; Brazil P.I. No. 9609807-4; Canada Pat. Nos. 1,331,057, 2,227,904, 2,278,549, 2,302,595; Japan Pat. Nos. 3532780, 3492981; United Kingdom Pat. No. 2238414B; Hong Kong Standard Pat. No. HK1010924; Republic of Singapore Pat. Nos. 51383, 66959, 71976, 89076; European Pat. Nos. 0 842 463 (96927260.8), 1 010 057 (98903671.0), 1 018 069 (98950708.2); Republic of Korea Pat. Nos. KR201211B1, KR226206B1, 402252, 552085; People's Republic of China Pat. No. ZL96196739.0; Mexico Pat. Nos. 208141, 216023, 218409; Russian Federation Pat. Nos. 2206118, 2214620, 2221268; New Zealand Pat. No. 519928; and additional patents are pending worldwide.

Licensed by QUALCOMM Incorporated under one or more of the following patents:

4,901

5,109

5,267

5,416,797

All other company, product and service names mentioned herein are trademarks, registered trademarks or service marks of their respective owners.

HTC shall not be liable for technical or editorial errors or omissions contained herein, nor for incidental or consequential damages resulting from furnishing this material. The information is provided "as is" without warranty of any kind and is subject to change without notice. HTC also reserves the right to revise the content of this document at any time without prior notice.

No part of this document may be reproduced or transmitted in any form or by any means, electronic or mechanical, including photocopying, recording or storing in a retrieval system, or translated into any language in any form without prior written permission of HTC.

Important Health Information and Safety Precautions

When using this product, the safety precautions below must be taken to avoid possible legal liabilities and damages. Additional safety information can be found in the Appendix at the end of the user manual.

Retain and follow all product safety and operating instructions. Observe all warnings in the operating instructions on the product.

To reduce the risk of bodily injury, electric shock, fire and damage to the equipment, observe the following precautions.

ELECTRICAL SAFETY

This product is intended for use when supplied with power from the designated battery or power supply unit. Other usage may be dangerous and will invalidate any approval given to this product.

SAFETY PRECAUTIONS FOR PROPER GROUNDING INSTALLATION

CAUTION – Connecting to an improperly grounded equipment can result in an electric shock to your device.

This product equipped with a USB Cable for connecting with desk-top or notebook computer. Be sure your computer is properly grounded (earthed) before connecting this product to the computer. The power supply cord of a desktop or notebook computer has an equipment-grounding conductor and a grounding plug. The plug must be plugged into an appropriate outlet which is properly installed and grounded in accordance with all local codes and ordinances.

SAFETY PRECAUTIONS FOR POWER SUPPLY UNIT

• Use the correct external power source

A product should be operated only from the type of power source indicated on the electrical ratings label. If you are not sure of the type of power source required, consult your authorized service provider or local power company. For a product that operates from battery power or other sources, refer to the operating instructions that are included with the product.

• Handle battery packs carefully

This product contains a Li-Ion or Li-Ion Polymer battery. There is a risk of fire and burns if the battery pack is handled improperly. Do not attempt to open or service the battery pack. Do not disassemble, crush, puncture, short external contacts or circuits, dispose of in fire or water, or expose a battery pack to temperatures higher than 60°C (140°F).

WARNING! Danger of explosion if battery is incorrectly replaced. To reduce risk of fire or burns, do not disassemble, crush, puncture, short external contacts, expose to temperature above 60°C (140°F), or dispose of in fire or water. Replace only with specified batteries. Recycle or dispose of used batteries according to the local regulations or reference guide supplied with your product.



SAFETY PRECAUTIONS FOR DIRECT SUNLIGHT

Keep this product away from excessive moisture and extreme temperatures. Do not leave the product or its battery inside a vehicle or in places where the temperature may exceed 60°C (140°F), such as on a car dashboard, window sill, or behind a glass that is exposed to direct sunlight or strong ultraviolet light for extended periods of time. This may damage the product, overheat the battery, or pose a risk to the vehicle.

PREVENTION OF HEARING LOSS

CAUTION – Permanent hearing loss may occur if earphones or headphones are used at high volume for prolonged periods of time.

Turn down the volume before using headphones or other audio devices. An excessive sound volume level could cause damage to your hearing.

SAFETY IN AIR CRAFT

Due to the possible interference caused by this product to an aircraft's navigation system and its communications network, using this device's phone function on board an airplane is against the law in most countries. If you want to use this device when on board an aircraft, remember to turn off your phone by switching to Flight Mode.

ENVIRONMENT RESTRICTIONS

Do not use this product in gas stations, fuel depots, chemical plants or where blasting operations are in progress, or in potentially explosive atmospheres such as fuelling areas, fuel storehouses, below deck on boats, chemical plants, fuel or chemical transfer or storage facilities, and areas where the air contains chemicals or particles, such as grain, dust, or metal powders. Please be aware that sparks in such areas could cause an explosion or fire resulting in bodily injury or even death.

EXPLOSIVE ATMOSPHERES

When in any area with a potentially explosive atmosphere or where flammable materials exist, the product should be turned off and the user should obey all signs and instructions. Sparks in such areas could cause an explosion or fire resulting in bodily injury or even death. Users are advised not to use the equipment at refueling points such as service or gas stations, and are reminded of the need to observe restrictions on the use of radio equipment in fuel depots, chemical plants, or where blasting operations are in progress. Areas with a potentially explosive atmosphere are often, but not always, clearly marked. These include fueling areas, below deck on boats, fuel or chemical transfer or storage facilities, and areas where the air contains chemicals or particles, such as grain, dust, or metal powders.

ROAD SAFETY

Vehicle drivers in motion are not permitted to use telephony services with handheld devices, except in the case of emergency. In some countries, using hands-free devices as an alternative is allowed.

SAFETY PRECAUTIONS FOR RF EXPOSURE

- Avoid using your device near metal structures (for example, the steel frame of a building).
- Avoid using your device near strong electromagnetic sources, such as microwave ovens, sound speakers, TV and radio.
- Use only original manufacturer-approved accessories, or accessories that do not contain any metal.
- Use of non-original manufacturer-approved accessories may violate your local RF exposure guidelines and should be avoided.

INTERFERENCE WITH MEDICAL EQUIPMENT FUNCTIONS

This product may cause medical equipment to malfunction. The use of this device is forbidden in most hospitals and medical clinics.

If you use any other personal medical device, consult the manufacturer of your device to determine if it is adequately shielded from external RF energy. Your physician may be able to assist you in obtaining this information.

Turn the phone OFF in health care facilities when any regulations posted in these areas instruct you to do so. Hospitals or health care facilities may be using equipment that could be sensitive to external RF energy.

HEARING AIDS

Some digital wireless phones may interfere with some hearing aids. In the event of such interference, you may want to consult your service provider, or call the customer service line to discuss alternatives.

NONIONIZING RADIATION

Your device has an internal antenna. This product should be operated in its normal-use position to ensure the radiative performance and safety of the interference. As with other mobile radio transmitting equipment, users are advised that for satisfactory operation of the equipment and for the safety of personnel, it is recommended that no part of the human body be allowed to come too close to the antenna during operation of the equipment.

Use only the supplied integral antenna. Use of unauthorized or modified antennas may impair call quality and damage the phone, causing loss of performance and SAR levels exceeding the recommended limits as well as result in non-compliance with local regulatory requirements in your country.

To assure optimal phone performance and ensure human exposure to RF energy is within the guidelines set forth in the relevant standards, always use your device only in its normal-use position. Do not touch or hold the antenna area unnecessarily when placing or receiving a phone call. Contact with the antenna area may impair call quality and cause your device to operate at a higher power level than needed. Avoiding contact with the antenna area when the phone is IN USE optimizes the antenna performance and the battery life.

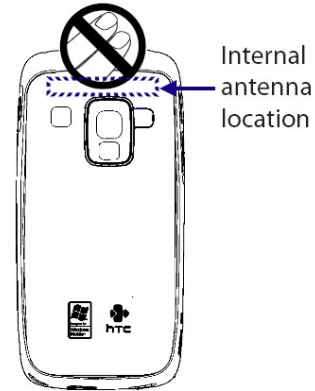

General Precautions

• Heed service markings

Except as explained elsewhere in the Operating or Service documentation, do not service any product yourself. Service needed on components inside the device should be done by an authorized service technician or provider.

• Damage requiring service

Unplug the product from the electrical outlet and refer servicing to an authorized service technician or provider under the following conditions:

- Liquid has been spilled or an object has fallen into the product.
- The product has been exposed to rain or water.
- The product has been dropped or damaged.
- There are noticeable signs of overheating.
- The product does not operate normally when you follow the operating instructions.

• Avoid hot areas

The product should be placed away from heat sources such as radiators, heat registers, stoves, or other products (including amplifiers) that produce heat.

• Avoid wet areas

Never use the product in a wet location.

- **Avoid using your device after a dramatic change in temperature**

When you move your device between environments with very different temperature and/or humidity ranges, condensation may form on or within the device. To avoid damaging the device, allow sufficient time for the moisture to evaporate before using the device.

NOTE When taking the device from low-temperature conditions into a warmer environment or from high-temperature conditions into a cooler environment, allow the device to acclimate to room temperature before turning on the power.

- **Avoid pushing objects into product**

Never push objects of any kind into cabinet slots or other openings in the product. Slots and openings are provided for ventilation. These openings must not be blocked or covered.

- **Mounting Accessories**

Do not use the product on an unstable table, cart, stand, tripod, or bracket. Any mounting of the product should follow the manufacturer's instructions, and should use a mounting accessory recommended by the manufacturer.

- **Avoid unstable mounting**

Do not place the product with an unstable base.

- **Use product with approved equipment**

This product should be used only with personal computers and options identified as suitable for use with your equipment.

- **Cleaning**

Unplug the product from the wall outlet before cleaning. Do not use liquid cleaners or aerosol cleaners. Use a damp cloth for cleaning, but NEVER use water to clean the LCD screen.

Contents

Chapter 1	Getting Started	11
1.1	Getting to Know Your Phone and Its Accessories.....	12
1.2	Installing the Battery.....	15
1.3	Installing a microSD Card.....	15
1.4	Turning On and Off the Phone.....	15
1.5	The Home Screen	15
1.6	Programs On Your Phone	16
1.7	Start Menu.....	17
1.8	Quick List	18
1.9	Entering Information.....	18
1.10	Battery Information.....	21
1.11	Status Indicators	22
Chapter 2	Using Phone Features	23
2.1	Using the Phone.....	24
2.2	Making a Call.....	24
2.3	Receiving a Call	26
2.4	In-Call Options	26
2.5	Additional Dialing Information	27
Chapter 3	Synchronizing Information with Your Computer	29
3.1	About Synchronization	30
3.2	Using Microsoft Windows Mobile® Device Center.....	30
3.3	Installing and Using Microsoft ActiveSync®	31
3.4	Synchronizing with Your Computer	31
3.5	Synchronizing via Bluetooth	32
3.6	Synchronizing Music and Video	33
Chapter 4	Managing your Phone	35
4.1	Personalizing your Phone	36
4.2	Adding and Removing Programs	40
4.3	Using Task Manager and Managing Memory	40
4.4	Managing and Backing Up Files	41
4.5	Protecting your Phone	42
4.6	Restarting your Phone	43
4.7	Resetting your Phone	43

Chapter 5	Organizing Phone Information	45
5.1	Contacts	46
5.2	Calendar	47
5.3	Tasks	48
5.4	Voice Notes.....	49
Chapter 6	Exchanging Messages	51
6.1	Messaging	52
6.2	Text Messages	52
6.3	Setting Up E-mail Accounts.....	53
6.4	E-mail Messages.....	54
Chapter 7	Working with Company E-mails and Meeting Appointments	59
7.1	Synchronizing Your Phone with Your Company E-mail Server.....	60
7.2	Working with Company E-mails	60
7.3	Managing Meeting Requests	63
7.4	Finding Contacts in the Company Directory	64
7.5	E-mail Security	65
Chapter 8	Getting Connected	69
8.1	Comm Manager.....	70
8.2	Connecting to the Internet	70
8.3	Internet Explorer Mobile	72
8.4	Wireless Modem.....	73
8.5	Bluetooth.....	75
8.6	Windows Live Mobile.....	78
Chapter 9	Experiencing Multimedia	81
9.1	Camera and Video Recorder	82
9.2	Pictures & Videos	85
9.3	Windows Media Player Mobile	86
9.4	Java	89
Chapter 10	Using Other Applications	93
10.1	Microsoft® Office Mobile	94
10.2	Microsoft® Office Word Mobile	94
10.3	Microsoft® Office Excel® Mobile.....	95
10.4	Microsoft® Office PowerPoint® Mobile.....	98

10.5 Adobe Reader LE.....	99
10.6 Speed Dial	99
10.7 Voice Speed Dial	100
Appendix	103
A.1 Specifications.....	104
A.2 Regulatory Notices	105
A.3 Additional Safety Information.....	110
Index	115

Chapter 1

Getting Started

1.1 Getting to Know Your Phone and Its Accessories

1.2 Installing the Battery

1.3 Installing a microSD Card

1.4 Turning On and Off the Phone

1.5 The Home Screen

1.6 Programs On Your Phone

1.7 Start Menu

1.8 Quick List

1.9 Entering Information

1.10 Battery Information

1.11 Status Indicators

1.1 Getting to Know Your Phone and Its Accessories

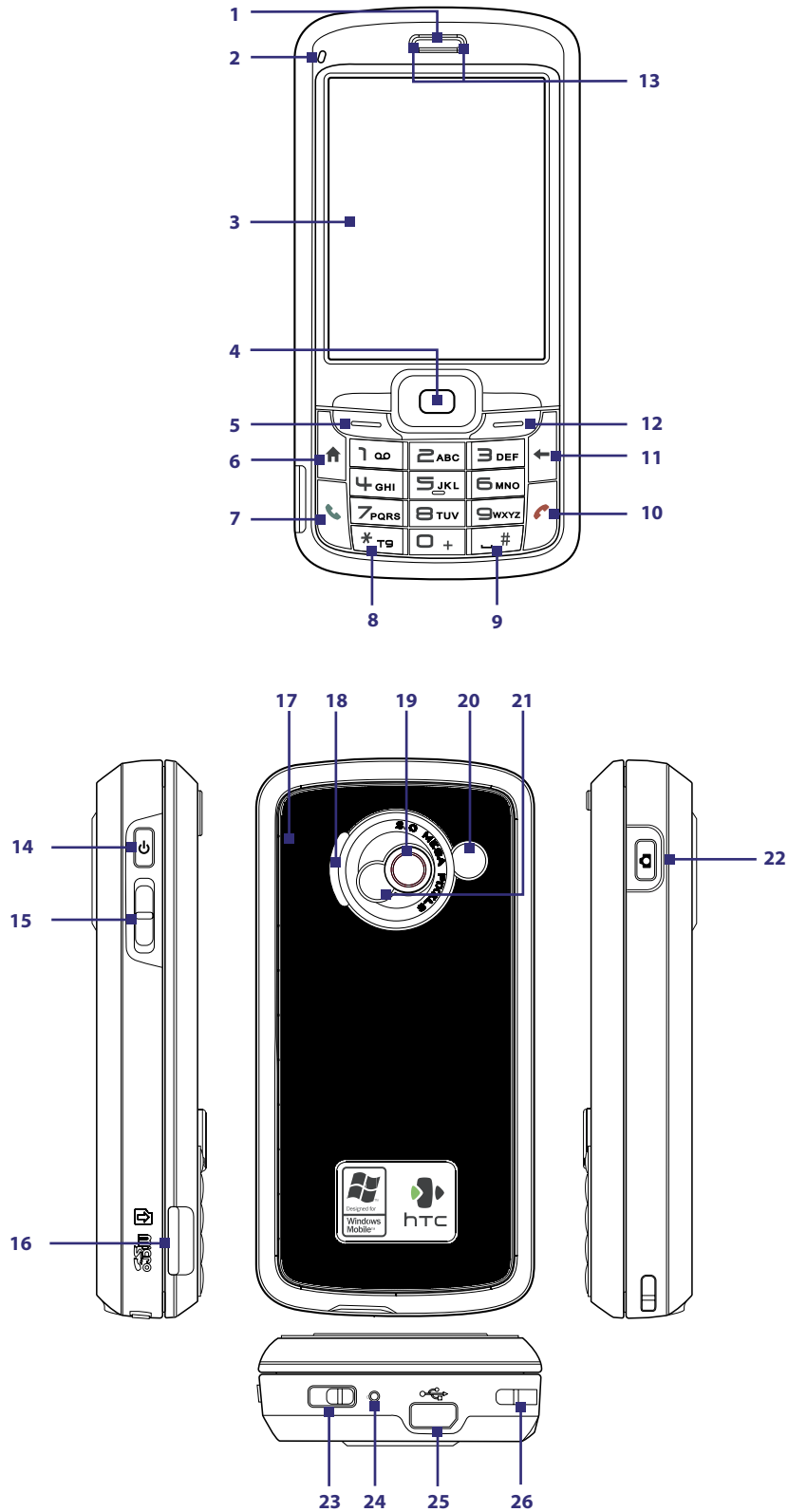

Item	Function
1. Speaker	Listen to phone call.
2. Light Sensor	Sense dark conditions and activate a backlight under the keypad and the QWERTY keyboard automatically, glowing in dark.
3. Display Screen	
4. NAVIGATION CONTROL/ENTER	Use to scroll left, right, up, or down. Press the center to use as the ENTER button..
5. Left SOFT KEY	Press to perform the command shown in the label above the button.
6. HOME	Press to go to the Home screen or press and hold to open Comm Manager.
7. TALK	Press to dial a phone number or answer a call. Press and hold to activate/deactivate speakerphone mode.
8. * T9 Key	Press to change input modes or press and hold to choose an input mode or symbols from the list.
9. _ # Key	Press to add a space or press and hold to display a list of symbols.
10. END	Press to end a call, or press and hold to lock the phone keypad and the keyboard.
11. BACK	Press to go back to the previous screen, or backspace over characters.
12. Right SOFT KEY	Press to perform the command shown in the label above the button.
13. LED Indicators	The left LED indicator (green/red/amber) notifies you of the battery and network status of your phone, while the right LED indicator (blue) notifies you of Bluetooth connectivity status. For more information about LED Indicators, see the table at the end of this section.
14. POWER	Press (about 3 seconds) to turn on and off the phone. Or press and quickly release the POWER button to display the Quick List, which allows you to change profiles, open Comm Manager, and enable/disable lock feature.
15. Volume Adjustment Slider	Slide this up or down to increase or decrease the earpiece volume during a call. Drag and hold the slider down to launch Voice Speed Dial.
16. microSD Slot	Insert a microSD memory card for storing data.
17. Back Cover	Remove to insert or replace battery.
18. Speaker	Listen to audio media or phone call when using speakerphone mode.
19. Camera lens	
20. Car Antenna Connector	Connect your phone to the car antenna while in a car to have better reception quality.
21. Self-Portrait Mirror	Turn the back side of your phone to face yourself so that your image reflects on the mirror when taking self-portrait shots.
22. CAMERA	Press and hold to open the Camera program. If already running, press to capture an image or start recording a video clip.
23. Battery Cover Latch	Slide this latch to release the battery cover.
24. Microphone	Speak into the microphone when receiving or making a phone call or during voice recording.
25. Sync Connector/ Earphone Jack	Use for synchronizing data, recharging the battery, connecting the earphone to listen to audio media, or connecting the phone's hands-free kit.
26. Strap Holder	Attach a strap for carrying your device.

LED indicator lights

Various colors that might display in the two LED Indicators are summarized here.

Left LED	Status
Solid green	Battery is fully charged.
Blank	Battery case is empty or the phone is off.
Solid amber	Battery is charging or the phone is using ActiveSync to synchronize with a PC.
Solid red	Battery is not installed while the phone is charging/synchronizing or battery is over-discharged.
Flashing green	Phone is connected to the network.
Flashing red	Battery very low (less than 10%) or battery fault. Check if the battery is properly installed and its exposed copper part is properly aligned with the protruding copper conductor of the phone body.
Right LED	Status
Flashing blue	Bluetooth mode set to "On" or "Visible" mode.

Accessories

The following accessories are provided with the phone:

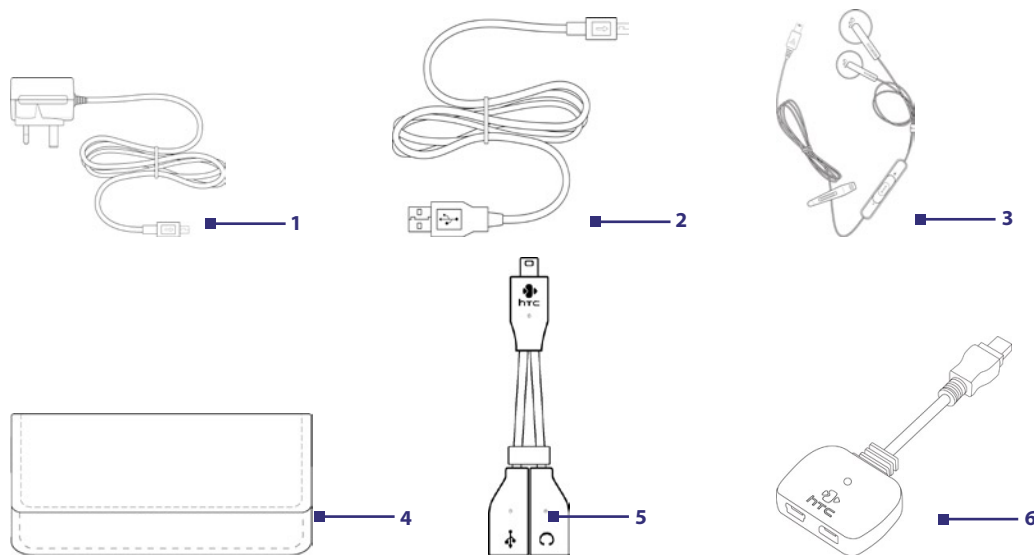

Accessory	Function
1. AC Adapter	Recharges the battery.
2. USB Sync Cable	Connects your device to a PC and synchronizes data.
3. Mini-USB Stereo Headset	Provides a volume control slider and a Send/End button. Press the Send/End button to pick up a call or put a call on hold; press and hold the button to end the call.
4. Pouch	Comes with belt clip. Store your device in the pouch to keep it away from dust and scratches..
5. One-to-two Y-Splitter Cable	Lets you connect the supplied AC adapter and a standard 2.5mm stereo headset to your device at the same time.
6. One-to-two Splitter Adapter	Lets you connect the supplied AC adapter and mini-USB stereo headset to your device at the same time.

1.2 Installing the Battery

1. Slide the battery cover latch to release the back cover.
2. Insert the battery by aligning the exposed copper part of the battery pack with the protruding copper conductor.
3. Gently push the battery into place.
4. Replace the battery cover.

1.3 Installing a microSD Card

You can install a microSD (Secure Digital) card in your phone to have an alternative storage place for your images, video, music, and other phone data.

- Pry open the rubber cover (if any) of the microSD slot on the side of the phone.
- Insert the microSD card into the slot with its gold contacts facing up.
To remove, press the microSD card to pop it out of the slot.

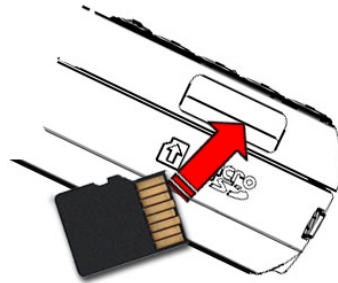

Note A microSD card is not included in the box.

1.4 Turning On and Off the Phone

Press and hold the POWER button for about 3 seconds to turn on or off the phone.

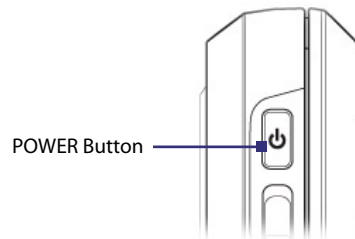

1.5 The Home Screen

The Home screen displays important information, such as upcoming appointments, status indicators, the current date, time, and profile, and icons of programs that you have recently used. You can open a program directly by selecting its icon and pressing ENTER.

- To access the Home screen from anywhere, press HOME.
- To customize the Home screen display, including the background, click **Start > Settings > Home Screen**.



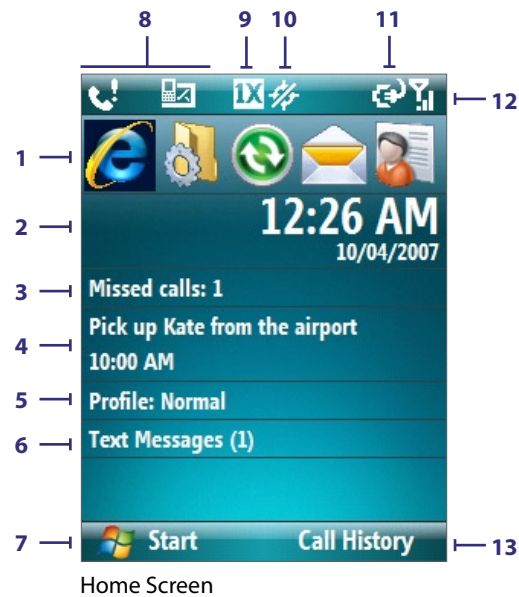









1. Select a recently-used program, and open it directly from the Home screen.
2. Displays the name of your wireless service provider, date, and the time. Click to open Comm Manager.
3. Click to view the details of a missed call.
4. Click to view the details of your next appointment.
5. Displays the current Profile being used. Click to change the current Profile.
6. Displays the new messages that you have received. Click to open the Messages folder.
7. Click to display all program icons.
8. Displays notifications, such as missed calls or new messages.
9. Displays the available network or connectivity status.
10. Displays the location settings.
11. Displays the power status.
12. Displays the network signal strength.
13. Click to open Contacts, Call History, or Messages.



1.6 Programs On Your Phone

The following table lists icons of the programs that are already installed on your phone.

Icon	Program	Description
	ActiveSync	Synchronizes information between your phone and PC.
	Adobe Reader LE	View PDF files.
	Calculator	Do basic arithmetic and calculations.
	Calendar	Keeps track of your appointments, and creates meeting requests.
	Call History	Keeps track of all phone calls made, received, and missed.
	Camera	Captures photos in various modes.
	Clear Storage	Clears the memory and restores the phone back to factory default settings.
	Comm Manager	A central switch where you can manage phone and connection settings.
	Contacts	Keeps track of contact information.
	Excel Mobile	Lets you open, view, edit, and save Excel worksheets on your phone.
	File Explorer	Organize and manage files and folders.
	Games	Play two games: Bubble Breaker and Solitaire come with your phone.
	Internet Explorer	Browse Web and WAP sites, and to download new programs and files from the Internet.
	Java	Download and install Java-based applications, such as games and tools, on your phone.
	Messaging	Send and receive e-mails and text messages.
	Messenger	Connect to the Windows Live Messenger service.

Icon	Program	Description
	Pictures & Videos	Collects, organizes, and sorts media files.
	PowerPoint Mobile	Lets you open, view, and save PowerPoint files on your phone.
	Settings	Personalize your phone to suit the way you use it.
	Speed Dial	Create speed dial entries for dialing frequently-called phone numbers or for opening frequently-accessed programs.
	Task Manager	Keeps track of all running programs on your phone.
	Tasks	Keeps track of your tasks.
	Video Recorder	Captures video clips in various modes and duration.
	Voice Notes	Create short voice recordings.
	Voice Speed Dial	Lets you open a program or call a contact using voice recognition.
	Windows Live	Connect and use the Windows Live services.
	Windows Media Player	Play back video and audio files.
	Wireless Modem	Enables your phone as an external modem for a PC by using a USB port.
	Word Mobile	Lets you open, view, edit, and save Word documents and text files on your phone.

1.7 Start Menu

The Start menu is located at the bottom-left corner of the Home screen and displays various program icons that are spread across one or more screens.

To see the available programs in the Start menu

On the Home screen, click **Start**. To see more programs, click **More** or use the NAVIGATION CONTROL.

Your phone comes with several bundled programs that you can start using immediately. You can also install additional programs from the included Windows Mobile® Getting Started Disc or from the Internet, or purchase mobile phone software from retail stores and install them on your phone.



Start menu

1.8 Quick List

The Quick List offers convenient access to a list of functions, such as locking your phone, and keyboard, opening Comm Manager, and choosing a different profile. For more information about profiles, see Chapter 4.

To access the Quick List

1. Briefly press (press and quickly release) the POWER button. Please note that pressing and holding the POWER button turns off the phone.
2. Scroll through the list and select the desired option. Then, do any of the following:
 - Click **Select**.
 - Press ENTER.
 - Press the corresponding number on the QWERTY keyboard.
3. To exit the Quick List at any time, click **Cancel**.

1.9 Entering Information

You can enter text, numbers, and symbols using the keypad or QWERTY keyboard. The status indicator on the top-right side of the display screen displays the input mode that you are currently using.

abc	Lowercase text input
ABC	Uppercase text input, caps lock
ABC	Uppercase text input
12#	Numeric or symbol (labeled in blue color) input, locked (Keyboard only)
12#	Numeric or symbol (labeled in blue color) input
xT9	XT9 text input mode, lowercase
xT9	XT9 text input mode, uppercase
xT9	XT9 text input mode, caps lock

Use the Keypad

Use the keypad to dial phone numbers or type short text messages.

To change the input mode

1. Press and hold the ***T9** key.
2. On the menu, click the input mode you want.

Use Multipress mode

In Multipress mode, you enter a character by pressing the numeric key on which the character appears.

To enter text in Multipress mode

- To enter the first character on the numeric key, press once. To enter the second character on the numeric key, press twice, and so on.
- To enter character that are on the same numeric key, pause after you enter the first character.
- To enter punctuation, press **1** repeatedly until you see the punctuation you want.

To change the Multipress time out

You can change the length of time to pause between keypresses on the same numeric key.

1. On the Home screen, click **Start > Settings > Accessibility**.
2. In **Multipress time out**, select the length of the pause between keypresses.

Use XT9 mode

To form a word in XT9 mode, press the numeric keys that contain the letters you want. As you enter letters, XT9 analyzes your keypresses and attempts to complete the word. For example, to enter the word "shoe," press **7, 4, 6, 3**.

To enter text in T9 mode

1. Press and hold the ***T9** key.
2. On the menu, click **XT9 English**.
3. Do any of the following to start entering text in XT9 mode:
 - Enter letters by pressing the keys on which the letters appear. Press a key only once for each letter. If there is more than one choice in the XT9 dictionary for your entry, a list of available words is displayed at the bottom of the screen.
 - Press the **_#** key to enter a space after the word.
 - To enter punctuation, press **1**, and then select from the list at the bottom of the screen.

Use Numeric mode

If a text box permits a numeric entry only, such as a phone number, the input mode automatically defaults to Numeric mode. However, if you need to enter numbers within a line of text, change to Numeric mode, and then change back to Multipress or XT9 mode to finish entering the text.

To enter numbers in text boxes

1. Press and hold the ***T9** key to change to Numeric mode (**12#**).
2. On the keypad, enter the number or numbers you want.
3. Change back to Multipress or XT9 input mode by pressing and holding the ***T9** key, and then finish entering your text.

More text entry tasks

In both Multipress and XT9 modes, the first letter of a sentence is by default capitalized.

To change between uppercase, lowercase, and caps lock

- Press the ***T9** key to change between uppercase, lowercase, and caps lock within a text input mode.

To delete characters

- To backspace and delete a single character in any input mode, press (←).
- To backspace and delete an entire text or numeric field in any input mode, press and hold (←).

To enter a space

- In Multipress or XT9 mode, press the **_#** key.

To enter a symbol

1. Press and hold the ***T9** key.
2. On the menu, click **Symbols** to display the Symbol page.
3. Select the symbol you want and press ENTER.

To start a new line

In a multi-line text box such as the notes area of a contact or a calendar appointment, do the following:



- In any input mode, press ENTER.













Use the QWERTY keyboard

Slide the upper half of the phone (with the screen) to the left to reveal the QWERTY keyboard. Use the QWERTY keyboard to type e-mails and long messages.

When you slide open the QWERTY keyboard, the display orientation of the screen automatically changes to landscape mode; when you close it, the screen orientation switches back to portrait mode.

Note To enable/disable the QWERTY keyboard sliding open or closing sound, click **Start > Settings > Sounds**. In **Sliding sound**, select **None** to disable the sound or select a sound to enable the sound.

The LED indicators corresponding to the **Cap** and **Fn** keys on the keyboard display solid amber color when the  and  keys are pressed to turn on their functionality. Pressing a desired corresponding key after use turns them off. You can do the following with the QWERTY keyboard.

- To type lowercase letters, press the keys using your thumbs or fingers.
- To type all uppercase letters, press  first, and then press . To turn off this function, press  first, and then press  again.
- To type a single uppercase letter, press  and then press the corresponding key.
- To enter a number or symbol (labeled in blue color) or to carry out a command like scrolling a page, press  and then press the corresponding key.
- To remain in the scrolling mode or to continue entering numbers or symbols (labeled in blue color), press  twice and then press the corresponding keys.
- Press the left or right SOFT KEY to perform the command shown in the label above the key.
- To enter a symbol, press  and then press .
- To move or scroll through one page at a time, press  or .
- To launch Messaging, press , while for Internet Explorer, press .

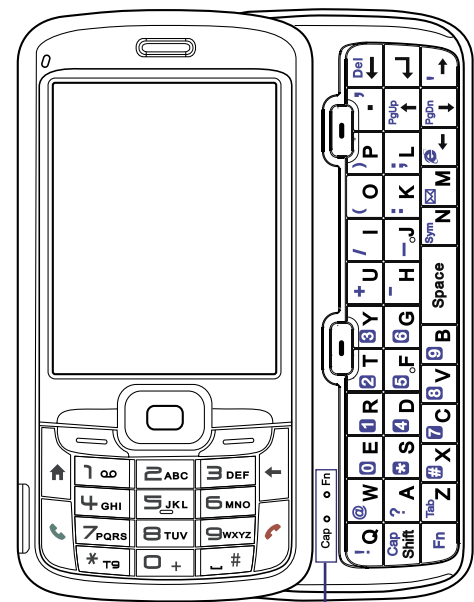

LED indicators for **Cap** and **Fn** keys

1.10 Battery Information

Battery performance depends on many factors, including your wireless service provider's network configuration, signal strength, the temperature of the environment in which you operate your phone, the features and/or settings you select and use, items attached to your phone's connecting ports, and your voice, data, and other program usage patterns.

Battery life estimates (approximations):

- Talk time: Up to 5 hours
- Standby time: Up to 200 hours
- Playing WMV: Up to 8 hours
- Playing WMA: Up to 12 hours

WARNING! To reduce risk of fire or burns:

- Do not attempt to open, disassemble, or service the battery pack.
- Do not crush, puncture, short external contacts, or dispose of in fire or water.
- Do not expose to temperatures above 60°C (140°F).
- Replace only with the battery pack designated for this product.
- Recycle or dispose of used battery as stipulated by local regulation.

To check the battery power

- On the Home screen, click **Start > Settings > Power Management**.

To optimize the power performance

- On the Home screen, click **Start > Settings > Power Management**, and adjust the backlight, display, and light sensor settings.

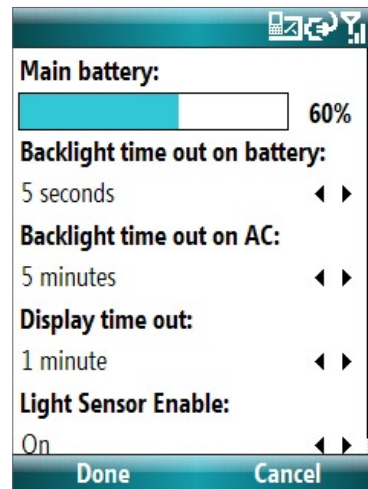

To manage a low battery

When the low-battery warning appears, do the following:

1. Immediately save your current data.
2. Synchronize with your PC or use the AC adapter to charge the battery.
3. Turn off your phone. Turn it back on only when you need to use it.

Note If you turn off the Phone function when you are out of your network coverage area, the phone automatically goes to the power-save mode and displays the following message:

Power-Saved Mode

Press any number key to exit

In this mode, your phone conserves the battery power. To quit this mode, press any number key on the keypad.

To charge the battery

New batteries are shipped partially charged. Before you start using your phone, it is recommended that you install and charge the battery. Some batteries perform best after several full charge/discharge cycles.

You can charge the battery in two ways:

- Connecting your phone directly to an external power source with the AC adapter.
- Connecting your phone to a PC via the provided USB Sync cable or Splitter cable/adapter.

WARNING!

- Do not remove the battery from the phone while you are charging it using the AC adapter.
- As a safety precaution, the battery stops charging when it overheats.

1.11 Status Indicators

The following table lists common status indicators with their description.

Icon	Description	Icon	Description
	New SMS message		Microphone muted
	New e-mail message		Bluetooth headset connected
	Roaming		1xRTT available (1xRTT, 1 times Radio Transmission Technology, is the third-generation data service)
	New MSN Messenger message		EVDO available (EVDO, Evolution Data Optimized, is a high speed data service for wireless broadband and quick Internet access)
	Incoming voice call		Lowercase text input
	Voice call in progress		Uppercase text input, caps lock
	Data call in progress		Uppercase text input
	Missed call		Numeric or symbol (labeled in red color on keyboard) input, locked
	Battery level		Numeric or symbol input (labeled in red color on keyboard)
	Low battery		XT9 text input mode, lowercase
	Very low battery		XT9 text input mode, uppercase
	Battery charging		XT9 text input mode, caps lock
	No battery or battery fault		Ringer off
	Signal strength		Speakerphone on
	Radio connected or no signal		Vibrate call alert
	Radio off		Location settings off
	Voice privacy currently unavailable		Location settings on
	Voice privacy available and turned on		Bluetooth On or Visible mode
	Sync error		

Chapter 2

Using Phone Features

2.1 Using the Phone

2.2 Making a Call

2.3 Receiving a Call

2.4 In-Call Options

2.5 Additional Dialing Information

2.1 Using the Phone

You can use your phone to make, receive, and keep track of voice calls, and send text messages (SMS, Short Message Service) and e-mail messages. You can also dial a phone number directly from Contacts.

Access the Phone screen

From the Phone screen, you can open, call, or find a contact, and even save a new number in Contacts. To access the Phone screen, do any of the following:

- Press TALK ().
- Directly enter the phone number by pressing numeric keys on the phone keypad or the QWERTY keyboard.

Set ring tones

You can choose how to be notified for incoming calls, reminders, new messages, alarms, and more.

To set a ring tone for incoming calls

1. On the Home screen, click **Start > Settings > Sounds**.
2. In the Ring tone list, select a ring tone.
3. Click **Done**.

If you select **Vibrate**, the sound is muted and the phone will vibrate when you receive a call. The Vibrate icon () appears in the title bar. Selecting **None** in the Ring tone list mutes the phone. For more information about sounds, see "Choose how to be notified about events or actions" in Chapter 4.

Note To adjust the earpiece volume during a call, use the volume adjustment slider on the phone's side panel. Adjusting the volume at any other time can affect the ring, notification and MP3 sound levels.

2.2 Making a Call

With your phone, you can make calls from the Home screen, the Phone screen, from Contacts, Speed Dial, or Call History.

Make a call from the Home screen

- Enter the phone number by pressing keys on the phone keypad or the QWERTY keyboard, and press TALK ().
- Press the BACK button or Del key if you need to backspace.

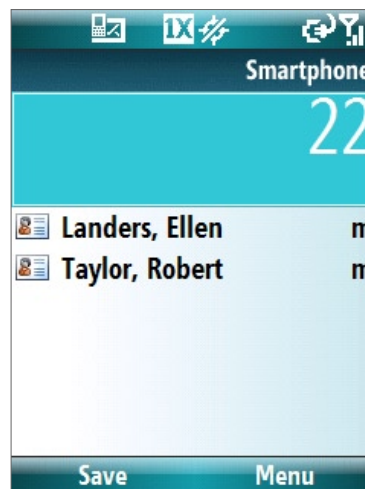

Phone screen

Tip You will notice that when you press a key on the phone keypad or the QWERTY keyboard, a list of names and numbers is displayed as your phone searches Contacts, Call History, and Speed Dial entries to find a matching name or number. When you see the number or name of the person you want to call, select it, and press TALK (📞).

Make a call from Contacts

1. On the Home screen, click **Start > Contacts**.
2. Select the desired contact, and press TALK (📞).

You can also select the desired contact in the contact list, and press the ENTER button twice (once to view the contact details, and once to dial the associated number).

To specify the number to dial

By default, the mobile telephone number (m) of a contact is dialed when you make a call from Contacts; however, you can choose to dial a different phone number.

1. On the Home screen, click **Start > Contacts**.
2. Select the contact.
3. Press NAVIGATION left or right. The letter representing the number changes to m (mobile), w (work), or h (home).

You can also select a contact in the contact list, and press ENTER to view details and different numbers associated with the contact. Select a number and press TALK (📞) or press ENTER to dial the number.

- You may also access the contact list by clicking **Contacts** on the Home Screen.
- To view or edit information associated with the selected contact, click **Menu > Edit**.

Make a call from Call History

1. On the Home screen, click **Start > Call History**.
2. Select a name or number, and press TALK (📞).

In the Call History screen, press ENTER to view details, such as the dialed, missed, or received call, call duration, date, and time. Pressing ENTER again dials the associated number.

To customize calls

You can select various options on the Call History screen to customize and filter the calls made, received, or missed.

- To find a name or number in Contacts, click **Menu > Find Contact**.
- To send a text message, click **Menu > Send Text Message**.
- To send an e-mail, click **Menu > E-mail**.
- To find the duration of a call, click **Menu > View Timers**.
- To remove a call or number from Call History, click **Menu > Delete**.
- To remove the list of calls or numbers from **Call History**, click **Menu > Delete List**.
- To save a name or number in Contacts, click **Menu > Save to Contacts**.
- To categorize the call or number into various call types, click **Menu > Filter**.

Note You can also save a number in Contacts by clicking **Save** on the Call History screen.



Make a call from Speed Dial

You can make calls using Speed Dial. To learn how to use Speed Dial, see “Speed Dial” in Chapter 10.

2.3 Receiving a Call

When you receive a phone call, you have the option to answer it or ignore it.

To answer or ignore an incoming call

- To answer the call, click **Answer**, or press TALK ().
- To ignore the call, click **Ignore**, or press END ().

To end a call

- Press END ().

2.4 In-Call Options

Your phone provides various options for managing calls. During a call, you can use the loudspeaker mode, mute or unmute your voice, or access Contacts, Calendar, and Call History for reference.

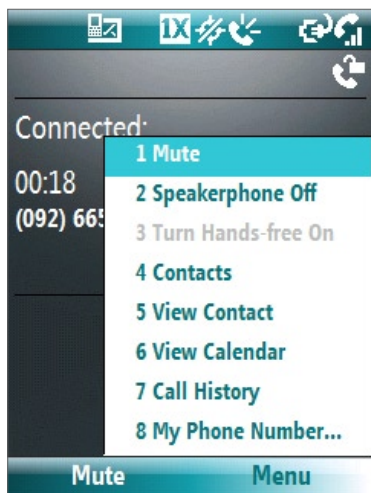

In-Call options

To turn the speakerphone on and off

The built-in speakerphone allows you to talk hands-free or lets other people listen to the conversation.

- During a call, click **Menu > Speakerphone On**. The  icon appears at the top of the screen.
- To turn off the Speakerphone during the call, click **Menu > Speakerphone Off**. Alternatively, the speakerphone can be toggled on and off by pressing and holding TALK during the call.

WARNING! To avoid damage to your hearing, do not hold your phone against your ear when the Speakerphone is turned on.

To mute a call

You can turn off the microphone during a call, so that you can hear the caller but the caller cannot hear you.

- During a call, click **Menu > Mute**.



When the microphone is turned off, the  icon appears on the screen. Click **Menu > Unmute** to turn on the microphone again.

2.5 Additional Dialing Information

Make an emergency call

- Enter the appropriate emergency number for your locale, and press TALK ().

Make an international call

1. Press and hold  on the phone keypad until the + sign appears. The + replaces the international prefix of the country that you are calling.
2. Enter the full phone number, and press TALK (). The full phone number includes country code, area code (without the leading zero, if any), and phone number.

Insert a pause in a dialing sequence

Some international calls require a pause in the dialing sequence in order for the call to process successfully.

1. On the Home screen, click **Start > Contacts**.
2. Select the contact entry that contains the phone number in which you want to insert a pause, and press ENTER to open the contact card.
3. Click **Menu > Edit**.
4. Position the cursor on the phone number where you want to insert a pause.
5. Click **Menu > Insert Pause**.
The letter “p” will appear in the number to indicate where the pause will occur in the dialing sequence.
6. Click **Done**.

Insert a longer pause in a dialing sequence

Some phone numbers may require a longer pause than the default pause in the dialing sequence. In these cases, you can pause as long as you want, and manually continue the dialing sequence.

1. On the Home screen, click **Start > Contacts**.
2. Select the contact entry that contains the phone number in which you want to insert a longer pause, and press ENTER to open the contact card.
3. Click **Menu > Edit**.
4. Position the cursor on the phone number where you want to insert a longer pause.
5. Click **Menu > Insert Wait**.
The letter “w” will appear in the number to indicate where the longer pause (wait) will occur in the dialing sequence.
6. Click **Done**.

Note When you call a number that contains a longer pause, you must press TALK () again to continue dialing.

Chapter 3

Synchronizing Information with Your Computer

3.1 About Synchronization

**3.2 Using Microsoft Windows Mobile®
Device Center**

3.3 Installing and Using Microsoft ActiveSync®

3.4 Synchronizing with Your Computer

3.5 Synchronizing via Bluetooth

3.6 Synchronizing Music and Video

3.1 About Synchronization

You can take information from your computer wherever you go by synchronizing them to your phone. The following types of information can be synchronized:

- **Microsoft Outlook® information**, which include Outlook e-mail, contacts, calendar, tasks, and notes
- **Media**, such as pictures, music and video
- **Favorites**, which are the bookmarked links to your favorite web sites
- **Files**, such as documents and other files

Before you can synchronize, you need to install first the synchronization software to your computer. For information on installing and using the synchronization software on your computer, see “Using Microsoft Windows Mobile Device Center” and “Installing and Using Microsoft ActiveSync” in this chapter.

Ways to synchronize

After you have installed the synchronization software to your computer, synchronize your phone with your computer by using one of the following:

- Connect and synchronize using the supplied USB sync cable.
Upon connecting the sync cable to your phone and your computer, the synchronization process starts automatically.
- Connect and synchronize using Bluetooth.
You must first set up a Bluetooth partnership between your phone and your computer before you can synchronize information between them using Bluetooth. For more information about setting up a Bluetooth partnership, see chapter 8. For information about synchronizing through Bluetooth, see “Synchronizing via Bluetooth” later in this chapter.

Note You can also synchronize Outlook e-mail, contacts, calendar, and tasks on your phone with the Exchange Server at your work. For more information about setting up your phone to synchronize with the Exchange Server, see chapter 7.

3.2 Using Microsoft Windows Mobile® Device Center

Microsoft Windows Mobile® Device Center is the replacement for Microsoft® ActiveSync® on Windows Vista™.

Set up synchronization between your phone and PC

1. Connect your phone to your PC. Windows Mobile Device Center configures itself and then opens.
2. On the license agreement screen, click **Accept**.
3. On the Windows Mobile Device Home screen, click **Set up your device**.

Note Choose **Connect without setting up your device** if you only want to transfer media files, check for updates, and explore your phone but not sync Outlook information.

4. Select the information types that you want to synchronize then click **Next**.
5. Enter a device name for your phone and click **Set Up**.

When you finish the wizard, Windows Mobile Device Center synchronizes your phone automatically. Notice that Outlook e-mails and other information will appear on your phone after synchronization.

3.3 Installing and Using Microsoft ActiveSync®

Follow the steps below to install and set up ActiveSync 4.5 or later on Windows XP or other compatible Windows systems.

Note For a list of compatible Windows systems, please go to <http://www.microsoft.com/windowsmobile/activesync/activesync45.mspx>

Install and set up ActiveSync

1. Insert the Getting Started Disc into the disc drive on your PC.
2. Follow the on-screen instructions to install ActiveSync.
3. After installation is completed, connect your phone to your PC.
4. The Synchronization Setup Wizard automatically starts and guides you to create a synchronization relationship. Click **Next** to proceed.
5. To synchronize your phone with your computer, clear the **Synchronize directly with a server running Microsoft Exchange Server** check box then click **Next**.
6. Select the information types that you want to synchronize and then click **Next**.
7. Click **Finish**.

When you finish the wizard, ActiveSync synchronizes your phone automatically. Notice that Outlook e-mails and other information will appear on your phone after synchronization.

3.4 Synchronizing with Your Computer

Connect your phone to your PC to synchronize the information between your phone and PC. While your phone is connected, ActiveSync (or Windows Mobile Device Center on your PC) synchronizes every time you make a change on either the PC or your phone.

You can also manually start and stop synchronization any time.

To start and stop synchronization when using ActiveSync

1. After connecting your phone to your PC, click **Start > ActiveSync** on your phone.
2. Click **Sync** to start synchronization.

To end synchronization before it completes, click **Stop**.

To change which information is synchronized

You can add or reduce the types of information to synchronize between your phone and PC.

1. Before changing synchronization settings on your phone, disconnect your phone from your PC.
2. On your phone, click **Start > ActiveSync**.
3. Click **Menu > Options**.
4. Select or clear the items you want to synchronize or not synchronize. If you cannot select a check box, you might have to clear the check box for the same information type elsewhere in the list.
5. To customize settings for an item, select that item and click **Settings**. Settings are not available for all items.

Note The check boxes of the Favorites, Files, Media, and OneNote items are always grayed out in ActiveSync Options on your phone. You can only select or clear these items from Windows Mobile Device Center or ActiveSync on your computer.

To synchronize with more than one computer

You can set up your phone to synchronize with more than one PC or with a combination of one or more PCs and Exchange Server. When synchronizing with multiple computers, the items that you synchronize will appear on all of the computers with which they are synchronized.

For example, if you have set up synchronization with two PCs (PC1 and PC2), which have different items, and you synchronize Contacts and Calendar on your phone with both computers, the result is as follows:

Location	New state
PC1	All Outlook contacts and calendar appointments that were on PC2 are now also on PC1.
PC2	All Outlook contacts and calendar appointments that were on PC1 are now also on PC2.
Phone	All Outlook contacts and calendar appointments from both PC1 and PC2 are on your phone.

- Notes**
- Outlook e-mail can be synchronized with only one computer.
 - To stop synchronizing with one PC completely, click **Menu > Options**, click the computer name, then click **Menu > Delete**.

To resolve ActiveSync connection problem

When the PC is connected to the Internet or a local network, in some cases, the PC may disconnect the ActiveSync connection with your phone in favor of the Internet or network connection. If this happens, click **Start > Settings > Connections > USB to PC**, then clear the **Enable advanced network functionality** check box. This makes ActiveSync utilize a serial USB connection with your phone.

3.5 Synchronizing via Bluetooth

You can connect and synchronize your phone with the PC using Bluetooth.

To synchronize with a computer via Bluetooth

1. Set up the synchronization software (Windows Mobile Device Center or ActiveSync) on your computer to use a Bluetooth connection. For more information, see the software Help on your computer.
2. On your phone, click **Start > ActiveSync**.
3. Make sure that Bluetooth on both your phone and the computer are turned on and set to visible mode. For more information, see "Bluetooth" in chapter 8.
4. Click **Menu > Connect via Bluetooth**.
5. If this is the first time you have connected to this computer via Bluetooth, you must first complete the Bluetooth wizard on your phone and set up a Bluetooth partnership between your phone and the computer. For more information about creating a Bluetooth partnership, see "Bluetooth partnerships" in chapter 8.

- Notes**
- To preserve battery power, turn off Bluetooth when not in use.
 - To connect and synchronize your phone with a computer via Bluetooth, your computer must have built-in Bluetooth or installed with a Bluetooth adapter or dongle.

3.6 Synchronizing Music and Video

If you want to carry your music or other digital media along with you while you travel, set up Microsoft Windows Media Player on your computer to synchronize music and video with your phone.

Other than selecting the media information type in ActiveSync to be synchronized, all media synchronization settings must be set in Windows Media Player. Before media can be synchronized, you must do the following:

- Install Windows Media Player Version 11 on the PC. (Windows Media Player 11 works only in Windows XP or later versions).
- Connect your phone to the PC with a USB cable.
- Set up a sync partnership between the phone and Windows Media Player.

For more information about Windows Media Player on your phone, see “Windows Media Player Mobile” in chapter 9.

Chapter 4

Managing your Phone

- 4.1 Personalizing your Phone**
- 4.2 Adding and Removing Programs**
- 4.3 Using Task Manager and Managing Memory**
- 4.4 Managing and Backing Up Files**
- 4.5 Protecting your Phone**
- 4.6 Restarting your Phone**
- 4.7 Resetting your Phone**

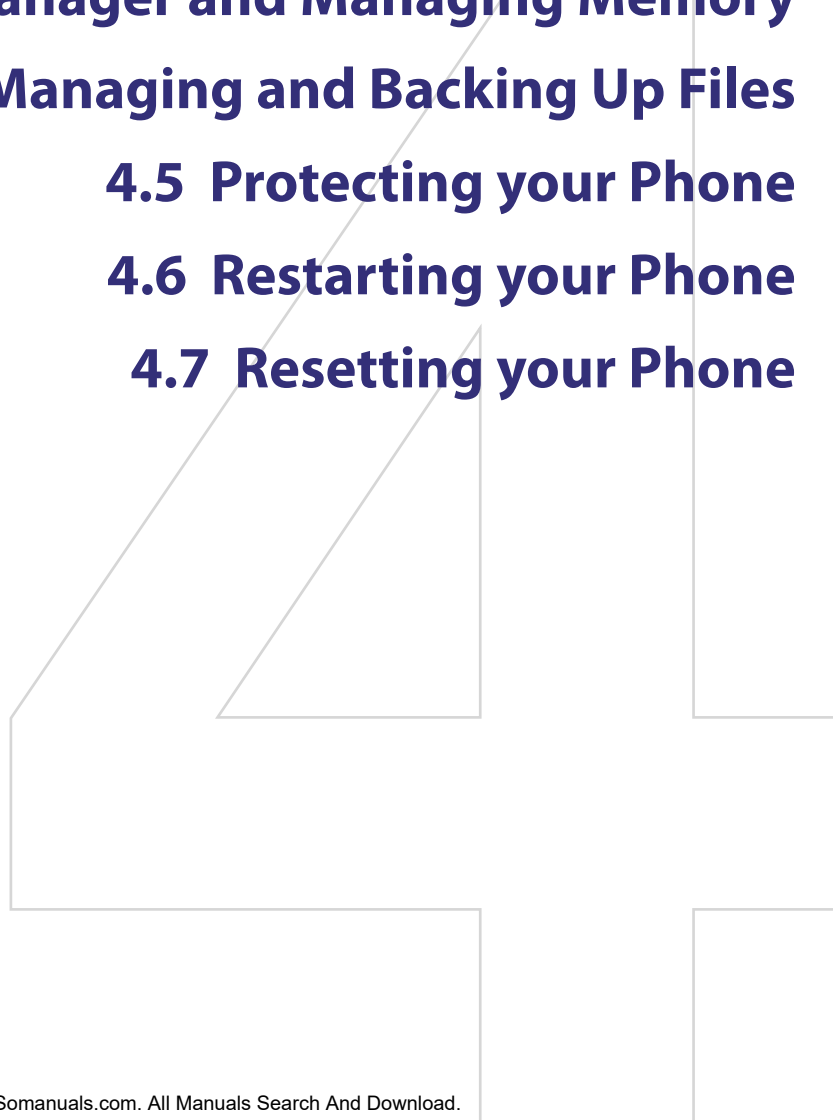

4.1 Personalizing your Phone

Set up the Home screen

The Home screen is your starting place for most tasks. You can gain access to all features and programs from the Home screen.

The top of the Home screen displays icons for the programs that you have most recently used. The center of the Home screen can display your next appointment, the number of new messages (voice mail, text, or e-mail) that you have received, and other important information. When you click an icon or item on the Home Screen, the associated program opens.

To customize the Home screen

1. On the Home screen, click **Start > Settings > Home Screen**.
2. In **Home screen layout**, **Color scheme**, **Background image**, and **Time out**, select the options you want, and click **Done**.

To set a picture as the background

1. On the Home screen, click **Start > Pictures & Videos**.
2. Select the picture you want to set as the background. Click **View** or press ENTER for a larger view of the image.
3. Click **Menu > Use as Home Screen**.
4. Use the NAVIGATION CONTROL to select the portion of the picture you want to use, and click **Next**.

Note If the picture fits the screen, this step is skipped.

5. In **Adjust the transparency**, select a higher percentage for a more transparent picture or a lower percentage for a more opaque picture.
6. Click **Finish**.

Set date, time, language, and other regional options

Your phone should already be set up with the regional settings that are appropriate for your locale.

To change regional settings

You can specify the language, locale, date and time style, as well as number and currency formatting options.

1. On the Home screen, click **Start > Settings > Regional Settings**.
2. In **Language**, select your preferred language.
3. In **Locale**, select the locale for the language you selected. The **Locale** option automatically changes the format of the remaining options (such as date, time, and currency) according to the locale you specify.
4. Click **Done**.

Note You must turn your phone off and on again for the changes to take effect.

To set the date and time

1. On the Home screen, click **Start > Settings > Clock & Alarm > Date and Time**.
2. In **Time zone**, select your time zone.
3. In **Date**, edit the month, day, or year.
4. In **Time**, edit the hour, minute, and second.
5. Click **Done**.

To display digital clock on Unlock message screen

You have the option to choose whether you want to view the current date and time while you unlock the phone.

1. On the Home screen, click **Start > Settings > Unlock Screen Clock**.
2. Select the desired option for date and time, and click **Done**.

Choose how to be notified about events or actions

A profile is a group of settings that determine how your phone will alert you to incoming calls and events, such as e-mail receipt notifications, alarms, or system events. A number of different preset combinations of these settings are included with your phone. Each profile appears with a descriptive name.

To change the current profile

1. On the Home screen, click **Profile: [Type]**. For example, **Profile: Normal**.
2. Choose a new profile, and click **Done**.

Tip To quickly change the profile, briefly press **POWER** to display the Quick List, and choose a profile. You can also change the profile by clicking **Settings > Profiles** from the Comm Manager screen.

To edit a profile

1. On the Home screen, click **Profile: [Type]**. For example, **Profile: Normal**.
2. Select the profile to edit.
3. Click **Menu > Edit**.
4. Do one of the following:
 - Modify the settings, and click **Done**.
 - To cancel without saving changes, click **Cancel**.

Tip To revert to the default profile settings, click **Menu > Reset to default**.

To specify the sound for an event

1. On the Home screen, click **Start > Settings > Sounds**.
2. For the desired event, select a sound. Select **None** if you do not want to hear a sound.
3. Click **Done**.

Note For ring tones, you can use sounds in either .wav, .mid, .wma, or .mp3 file format. For notifications or reminders, you can use .wav or .mid files.

Tip When you select a sound, the sound plays. To hear it again, select **Menu > Play**.

To set sound for the keypad and keyboard

1. On the Home screen, click **Start > Settings > Sounds**.
2. In **Keypad control**, select a sound. Select **Off** if you do not want to hear any sound while pressing a key.
3. Click **Done**.

To copy a sound to your phone

After a sound file is located on your phone, you can use it for a ring tone, notification, or reminder. Sound files in either .wav, .mid, .wma, or .MP3 formats can be used.

1. Connect the phone to your PC using a USB connection.
2. On your PC, copy the sound file you want.

3. In Windows Mobile Device Center, click **File Management > Browse the contents of your device**.
Or
In ActiveSync on your PC, click **Explore** and double-click **My Windows Mobile-Based Device**.
4. Save the sound file on your phone by going to **Application Data > Sounds**, and pasting the file into that folder.

To set an alarm

1. On the Home screen, click **Start > Settings > Clock & Alarm > Alarm**.
2. In **Alarm time**, enter the time for the alarm to go off.
3. In **Alarm**, choose when you want the alarm to go off.
4. Click **Done**.

Set personal information

Entering and displaying owner information are best practices; they allow someone to return the phone to you in case it is lost.

To enter owner information

1. On the Home screen, click **Start > Settings > Owner Information**.
2. Enter the necessary information and click **Done**:

Set performance and maintenance options

To change accessibility settings

1. On the Home screen, click **Start > Settings > Accessibility**.
2. Select your preference for the following:
 - In **System font size**, set the size of the font that is displayed on the screen.
 - In **Multipress time out**, set the length of time between keypresses when entering text in Multipress mode.
 - In **Confirmation time out**, set the delay before an unconfirmed action times out.
 - In **In-call alert volume**, set the volume for incoming call or receiving new message alerts while you are in a call.
3. Click **Done**.

To change power management settings

You can use Power Management to check the battery, and configure settings that prolong battery life.

1. On the Home screen, click **Start > Settings > Power Management**.
2. Adjust the available settings:
 - In **Backlight time out on battery**, select the amount of time for the phone to be idle before the backlight turns off.
 - In **Backlight time out on AC**, select the amount of time for the phone to be idle before the backlight turns off when using AC power.
 - In **Display time out**, select the time limit for the phone to be idle before the screen turns off.
 - In **Light Sensor Enable**, select whether to turn it on or off. If this is turned on, dark conditions sensed on the Light Sensor in front of the phone will activate a backlight under the keypad and keyboard.
3. Click **Done**.

Tip **Main battery** indicates the amount of battery life remaining.

To find the operating system version number

- On the Home screen, click **Start > Settings > About**.
The operating system version number installed on your phone along with the manufacturer copyright information will be listed on the screen.

To find the phone specification

- On the Home screen, click **Start > Settings > System Information**.
The System Information screen displays the details about the phone specification, such as processor, speed, memory, display, model name, and more.

To turn on and off error reporting

- On the Home screen, click **Start > Settings > Error Reporting**.
- Select **Enable** or **Disable** and click Done:



To set up Windows Mobile Update

- On the Home screen, click **Start > Settings > Windows Update**.
- Click **Next** and schedule the update accordingly.

Use phone settings and services

You can customize and set various options for an incoming or outgoing call on your phone, such as voice privacy, location setting, and more. You can also choose to activate and use optional phone services on your phone. Contact your wireless service provider first to ask about the availability of these services before you use them.

The following are some of the optional phone services that can be used on your phone:

Phone Settings and Services	Use
Auto Answer	Provide options to set how quickly incoming calls are automatically answered during hands-free operation. Choose options as 3, 4, 6, 8, or 10 seconds). Choose Never to disable this option. However, these settings do not apply when the ring type is Silent .
Automatic Prepend	Enable this option to automatically add "1" in front of the number for long distance calls, if required.
Call Options	Provide options for setting any key answer to incoming calls, notifying when voice privacy is unavailable, and setting your phone number, voice mail number, country code, and area code.
Location Setting	Turning Location Setting to On will allow the mobile network to detect your your current location via your phone's built-in GPS chip, making some applications easier to use. This is especially useful in times of emergency. Turning location off will hide your location from everyone except 911. Even if Location Setting is turned on in your phone, no service may use your location without your exclusive consent. At the top right of the Phone screen and Home screen, one of these icons appears:  - when Location Setting is set to On  - when Location Setting is set to Emergency Only (E911)
Mode Preference	Provide options to select a connection mode for your phone. While there are options to choose between 1x Only and EVDO Only , it is recommended that you select Automatic to let your phone choose the connection mode on its own.
Network Service	Choose to accept roaming by selecting Standard . Otherwise restrict your device to phone calls from your home network only (by selecting the Home only option).
Plus Code Dialing	Enable this option and enter the international dialing code in front of the number to make international calls, if required.
Time Synchronization	Enable this option if you want your phone to automatically set its time according to changing time zone and clock. Choose Disable if you want to change this manually.
TTY Mode	Allow the use of a TTY (teletypewriter) device with the phone for users who are visually or hearing impaired. Choose Full mode or Off according to the need.

To enable optional phone services

1. Click **Start > Settings > Phone**.
2. Select the service you want to use and press ENTER.
3. Select desired options for the service and click **Done**.

Note You can also access the Phone settings by clicking **Settings > Phone** on the Comm Manager screen.

4.2 Adding and Removing Programs

Before you purchase additional programs for your phone, make sure that they are compatible for Windows Mobile® 6 Standard operating system.

To add programs

1. Download the program to your PC (or insert the disc that contains the program into the CD drive of your PC). You may see a single *.exe file, a *.zip file, a Setup.exe file, or several versions of files for different device types and processors. Be sure to select a program designed for your phone and processor type.
2. Read the installation instructions that come with the program.
3. Connect your phone to the PC and then double-click the *.exe file.

To remove a program

Programs that are pre-installed on the phone cannot be removed.

1. On the Home screen, click **Start > Settings > Remove Programs**.
2. Scroll to the program to remove and click **Menu > Remove**.

4.3 Using Task Manager and Managing Memory

To see how much memory is available

1. On the Home screen, click **Start > Settings > About**.
2. Scroll down to **Available Memory**.

Use Task Manager

Task Manager allows you to view all the programs currently running on your phone in the form of a list.

To start Task Manager

- Click **Start > Task Manager**.

On the Task Manager screen, click **Menu** to open a list that lets you go to a specific program, stop running programs, and view system information.

To stop a running program, select a program on the list and click **Menu > Stop**.

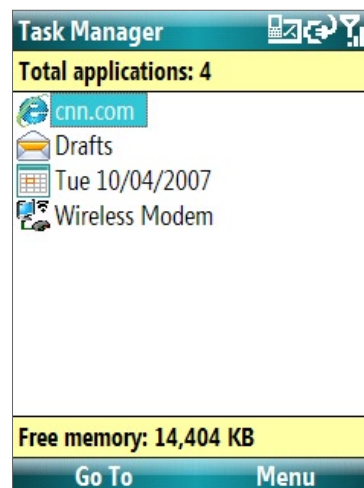

Task Manager

4.4 Managing and Backing Up Files

You can back up files to your PC using Windows Mobile Device Center or ActiveSync or copy files to a storage card that is installed on your phone. You can also efficiently manage your files and folders using File Explorer installed on your phone.

To copy files using Windows Mobile Device Center/ActiveSync to the PC

1. Connect your phone to your PC.
2. In Windows Mobile Device Center, click **File Management > Browse the contents of your device.**
Or
In ActiveSync on your PC, click **Explore**. This opens the Mobile Device folder for your phone.
3. Browse your phone for files that you want to copy to your PC.
4. Select and copy the files [**Ctrl + C**] and then paste them [**Ctrl+V**] to the destination folder in the PC.

Copying a file results in separate versions of a file on your phone and PC. Changes made to one file will not affect the other since the files are not synchronized.

Use File Explorer

File Explorer provides many easy-to-use features for file and folder management.

To start File Explorer

- On the Home screen, click **Start > File Explorer**.

File Explorer operates in the following two views:

- List View
- Icons View

File Explorer displays the entire file structure in your phone's memory. The functions focus primarily on folder management. When initially started, File Explorer is in List View by default. To switch between views, click **Menu > View > Icons** or **List**.

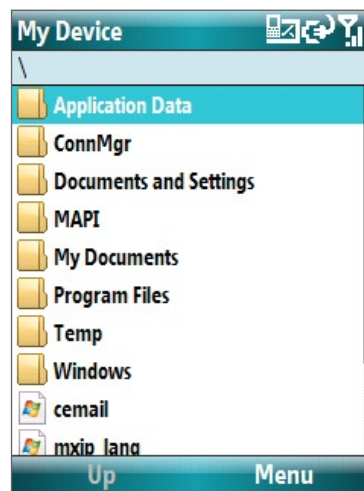

File Explorer - List View

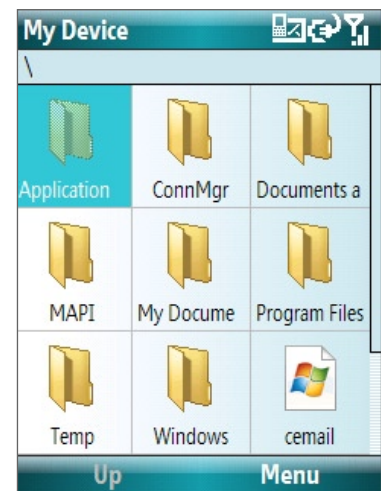

File Explorer - Icons View

In File Explorer, click **Menu** to open a list that lets you send or beam the file, view the file's properties, sort the files, and more.

Storage Card is only available if a microSD is installed on your phone.



To send a file as an e-mail attachment

1. In File Explorer, select a file and click **Menu > Send**.
2. On the Messaging screen, select an e-mail account.
3. The file will automatically be attached to the new message. Specify the recipient and subject, and type your message.
4. Click **Send**.

4.5 Protecting your Phone

You can protect your phone from unauthorized use by requiring a type of password called a simple PIN (personal identification number) or a strong alphanumeric password.

To lock the keypad and keyboard

Locking the keypad and keyboard turns off their functionality. This is a helpful feature if, for example, the phone is turned on and in your pocket, and you want to prevent accidental keypresses.

- On the Home screen, press and hold ().
Once the keypad and keyboard are locked, the left soft key label changes to **Unlock**.

Tip To quickly lock the keypad and keyboard, press POWER briefly, and select **Key lock** from the Quick List.

Note You can still receive calls and make emergency calls when the keypad and keyboard are locked.

To unlock the keypad

- On the Home screen, click **Unlock** and press the ***T9** key.

To enable the phone lock

1. On the Home screen, click **Start > Settings > Security > Device lock**.
2. Select **Prompt if device unused for** then select the amount of time for the phone to be inactive before automatically locking.
3. Select the **Password type** then enter and confirm your password.
4. Click **Done**.

Note Once you configure the phone lock settings, you can enable the phone lock from the Quick List directly without configuring the settings again.

To disable the phone lock

- Click **Unlock** then enter the password you have set to unlock your phone.

To encrypt files on the microSD card

- Click **Start > Settings > Security > Encryption** and select **Encrypt files placed on storage cards**.

4.6 Restarting your Phone

Restart your phone when a program is not performing properly or the phone is not responding to any keypresses.

To restart the phone

1. Remove the battery.
2. Wait 3 seconds, then reinsert the battery and turn on your phone.

WARNING! If the phone is restarted while a program is running, any unsaved work will be lost.

4.7 Resetting your Phone

Resetting your phone will remove all the data from its memory and restore the phone back to the factory default settings.

WARNING! As all of your data will be deleted, it is recommended that you back up your data first before resetting your phone.

To reset your phone

1. Click **Start > Accessories > Clear Storage**.
2. Follow the on-screen instructions to reset the phone.

The phone will restart after it has been reset.

Chapter 5

Organizing Phone Information

5.1 Contacts

5.2 Calendar

5.3 Tasks

5.4 Voice Notes



5.1 Contacts

Contacts is your address book and information storage for the people and businesses you communicate with. If you use Outlook on your PC, you can synchronize contacts between your phone and PC.

Create a contact on your phone

To create a new contact on your phone

1. On the Home screen, click **Start > Contacts > New**.
2. Enter information for the new contact.
 - To easily identify who is calling you, you can assign a custom ring tone to each contact. To assign a custom ring tone, scroll down to and click **Custom ring tone** and select the ring tone you want.
 - To assign a picture to a contact, scroll down to **Pictures** and click **Select a picture** and select the picture you want. To remove the picture, click **Menu > Remove Picture**.
3. Click **Done**.

Tip If someone who is not in your list of contacts calls you or sends you a message, you can quickly create a contact from Call History or from the message by clicking **Menu > Save to Contacts**.

Edit and call a contact

To view and edit a contact's information

1. On the Home screen, click **Start > Contacts**.
2. Select the contact whose information you want to view or edit and click **Menu > Edit**.
3. When finished making changes, click **Done**.

To call a contact from the contact list

1. On the Home screen, click **Start > Contacts**.
2. Select the contact to call and press TALK (📞). The contact's default phone number is dialed.

Tip To call a phone number other than the default, click the contact, scroll to the number you want to dial, and press TALK (📞).

Find a contact

To find a contact

1. On the Home screen, click **Start > Contacts**.

Note If you are not in Name view, click **Menu > View By > Name**.

2. Do one of the following:
 - Begin entering a name or phone number of the contact until the contact is displayed. When you press a key, such as **5**, you find first and last names that begin with **J**, **K**, and **L**, as well as phone numbers that start with **5**. The next key you press continues to narrow the search.
 - If you have assigned categories (e.g. Business) to your Outlook contacts, you can filter the contact list by categories. In the contact list, click **Menu > Filter** and then click a category. To show all contacts again, select **All Contacts**.
 - If you have entered information under **Company** for your Outlook contacts, you can quickly locate the contacts that work for a specific on your phone. In the contact list, click **Menu > View By > Company**. Click the company to see the contacts who work there.

Share contact information

To beam contact information to another device via Bluetooth

1. On the Home screen, click **Start > Contacts** and then select the contact whose information you want to beam.
2. Click **Menu > Send Contact > Beam**.
3. Select the device where you want to beam the contact details to and click **Beam**.

Note Before you can beam, make sure that Bluetooth along with its Visibility is activated on your phone and the target mobile device. For more information, see "Bluetooth" in chapter 8.

To send contact information via a text message

1. On the Home screen, click **Start > Contacts** and then select the contact whose information you want to send.
2. Click **Menu > Send Contact > Text Messages**. Select the contact information that you want to send and click **Done**.
3. In the new text message, enter the mobile phone number of the person to whom you are sending the contact information to and click **Send**.

5.2 Calendar

Use Calendar to schedule appointments, including meetings and other events. If you use Outlook on your PC, you can synchronize appointments between your phone and PC.

Create a personal appointment

To set Calendar options

1. On the Home screen, click **Start > Calendar**.
2. Click **Menu > Tools > Options**.
3. Scroll through the available settings and set your desired default options.
4. Click **Done**.

To schedule an appointment

1. On the Home screen, click **Start > Calendar**.
2. Click **Menu > New Appointment**.
3. Enter information about the appointment.
 - To schedule an all-day event, in **End time**, select **All day event**.
 - To make the appointment recurring, click **Occurs**.
4. Click **Done**.

View your appointments

To view your schedule

You can view your schedule in three different views: Month, Week, and Agenda.

1. On the Home screen, click **Start > Calendar**.
2. Click the left SOFT KEY or click **Menu** and choose the view you want.



An appointment with the  icon indicates that the scheduled appointment has a conflict with one or more existing appointments.

Send appointments

To send a meeting request

You can send meeting requests via e-mail to persons that use Outlook or Outlook Mobile.

1. Click **Start > Calendar**.
2. Schedule a new appointment and then scroll down to **Attendees** and click **No Attendees**. Click **Add Required Attendee** or **Add Optional Attendee** to add the contacts you want to send the meeting request to.

Note You can only specify if an attendee is required or optional if your phone is connected to a Microsoft Exchange 2007 server. Otherwise, all attendees are designated as required. For more information, see chapter 7.

3. Choose the contact(s) you want to send the meeting request to and click **Select**.

Note To remove an attendee from the list, select the attendee and click **Menu > Remove Attendee**.

4. On the New Appointment screen, click **Done**. The meeting request is sent out.

Note When attendees accept your meeting request, the meeting is automatically added to their schedules. When their response is sent back to you, your calendar is updated as well.

5.3 Tasks

Use Tasks to keep track of things you need to do.

To create a task

1. On the Home screen, click **Start > Tasks**.
2. Click **Menu > New Task**.
3. Enter the necessary task information and click **Done**.
 - Set a **Priority** for the task. This item can be referenced when sorting tasks.
 - Enter a **Start date** and **Due date** if the task starts and ends at a specific time.
 - Enter a **Reminder** if you want to be notified if the task is due.
 - Enter the **Categories** (you can set more than one) that best describes the task. This item can be referenced when filtering tasks.

Notes

- You can synchronize information on your phone with your PC to keep your task list up to date in both locations.
- If you create a new task with a reminder on your PC and then synchronize tasks with your phone, the reminder will play at the time that was set on your PC.

To locate a task

1. On the Home screen, click **Start > Tasks**.
2. In the task list, do one of the following:
 - To sort the list, click **Menu > Sort by**, and click a sort option.
 - To filter the list by category, click **Menu > Filter**, and click the category you want displayed.

To mark a task as completed

1. On the Home screen, click **Start > Tasks**.
2. Select the task, and click **Complete**.

5.4 Voice Notes

Use Voice Notes to create short voice recordings. Voice notes are included in the All Notes list and are named consecutively (Recording1, Recording2, and so on).

To create a voice note

1. On the Home screen, click **Start > Voice Notes**.
2. Hold the phone's microphone near your mouth.
3. Click **Record** and say your voice note.
4. Click **Stop** to stop recording a voice note.

To delete a voice note

1. On the Home screen, click **Start > Voice Notes**.
2. Select the voice note to delete.
3. Click **Menu > Delete**.
4. Click **Yes**.

Tip If you delete a voice note that has a default name, such as Recording1, this name becomes available for a new voice note.

To listen to a voice note

1. On the Home screen, click **Start > Voice Notes**.
2. Select the voice note to play, and press ENTER.

Tip To stop listening to the voice note, click **Stop** while the voice note is playing.

To use a voice note as a ring tone

1. On the Home screen, click **Start > Voice Notes**.
2. Select the voice note, and click **Menu > Set As Ringtone**.

Chapter 6

Exchanging Messages

6.1 Messaging

6.2 Text Messages

6.3 Setting Up E-mail Accounts

6.4 E-mail Messages

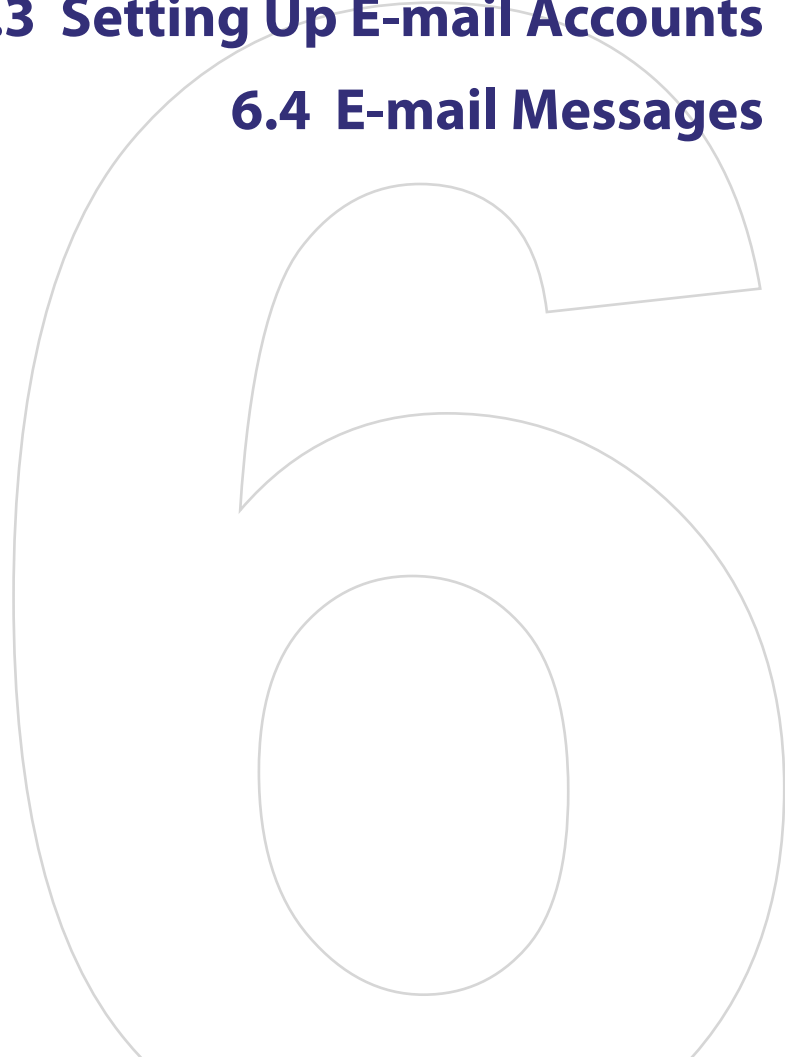

6.1 Messaging

Messaging is where all of your e-mail and text message accounts are located. When you receive a new message, you can open that particular message from the Home screen. Simply scroll to the row where the new message is and click it

To access your message accounts, click **Start > Messaging** and then click the account you want to open.

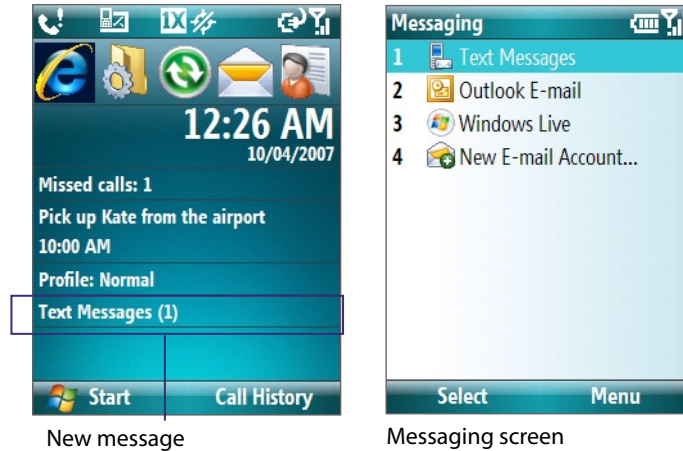

While in a messaging account's main screen, click **Menu > Tools > Switch Accounts** to switch to another message account.

To change message account settings

- On the Messaging screen, select the message account whose settings you want to change and click **Menu > Settings**.
- On a message account's message list, click **Menu > Tools > Options**.

6.2 Text Messages

Send short text messages up to 160 characters long to other mobile phones. For quicker and easier typing, use the sliding keyboard to enter your message.

To compose and send a text message

1. On the Home screen, click **Start > Messaging**.
2. Select **Text Messages** and click **Select**.
3. Click **Menu > New**.
4. Enter the mobile phone number of one or more recipients, separating them with a semicolon (;). To access phone numbers from Contacts, in **To**, press ENTER and select a recipient from the list.
5. Enter your message. You can enter up to 160 characters in one message.
6. Click **Send**.

Tips

- To cancel the text message, click **Menu > Cancel Message**.
- If you want to know if your text message was received, before sending the message, click **Menu > Message Options** and select **Request message delivery notification**.
- To always receive a notification, click **Menu > Tools > Options > Account Settings** in the text message list, and click the **Request delivery notifications** check box.

To receive a text message

Text messages are automatically received when the phone function is turned on. When the phone is turned off, text messages are held by your wireless service provider until the next time the phone is turned on.

To reply to or forward a text message

- Select the message and click **Menu > Reply**, **Menu > Reply All**, or **Menu > Forward**.
- Open the message and click **Reply**, **Menu > Reply All**, or **Menu > Forward**.

6.3 Setting Up E-mail Accounts

Before you can send and receive e-mail, you need to set up your e-mail account on your phone. You can set up the following types of e-mail accounts on your phone:

- Outlook e-mail that you synchronize with your PC or your company's Exchange Server
- Internet e-mail account that you have from an Internet Service Provider (ISP)
- Work account that you access using a VPN connection
- Windows Live Mail
- Other web-based e-mail accounts such as Gmail, Yahoo! Mail, etc.

Set up your phone to synchronize Outlook e-mail with the computer

If you have installed the synchronization software on your PC and created a partnership with your phone, then your phone is ready to send and receive Outlook e-mail. If you have not yet installed the synchronization software nor created a partnership, please do so by following the procedures in chapter 3.

Tip To set up your company e-mail account so that you can access Outlook e-mail messages wirelessly, you must set up your phone to synchronize via a wireless LAN or over-the-air connection with your company's Exchange Server. For more information about synchronizing with your company e-mail server, see chapter 7.

Set up a new e-mail account

You can easily set up an e-mail account that you have with an Internet service provider (ISP), a web-based e-mail or an account that you access using a VPN server connection (typically a work account) on your phone.

1. On the Home screen, click **Start > Messaging > New E-mail Account**.
2. In **E-mail address**, enter the e-mail address for this account.
3. Select **Try to get e-mail settings automatically from the Internet** and click **Next**.
4. If **Auto Setup** is successful, click **Next** to move on to the next screen.
5. In **Your name**, enter your display name for e-mail messages while in **Account display name**, enter a name for the account that should appear on the Messaging screen. Then, click **Next**.

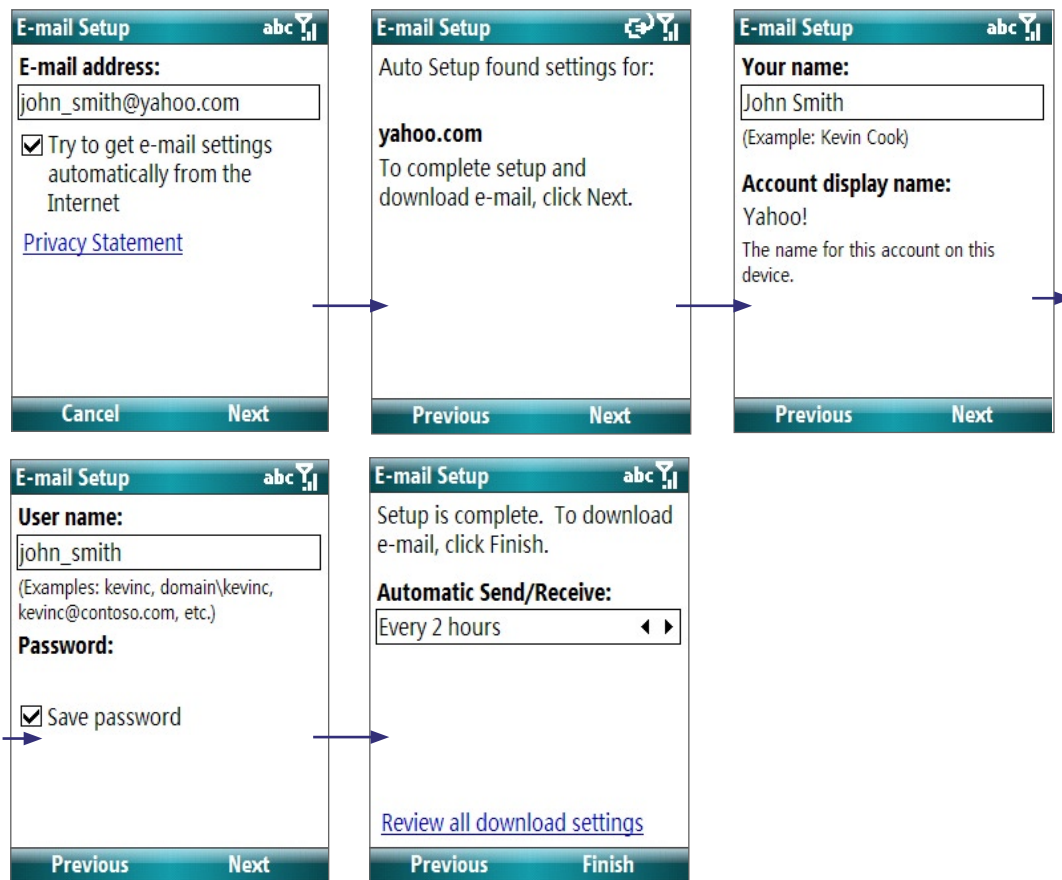

6. The **User name** field automatically gets populated. Select **Save password** and click **Next**. If **Auto Setup** is unsuccessful, contact your ISP or network administrator for the settings.

Note The domain name is not required for an account with an ISP but may be required for a work account.

7. Once setup is complete, click **Finish** to download e-mails.

Note You can view e-mail download settings by clicking **Review download settings**. To configure e-mail download settings, click the **Automatic Send/Receive** box.

6.4 E-mail Messages

After setting up e-mail accounts on your phone, you can start sending and receiving e-mail messages.

Create and reply to e-mails

To compose and send an e-mail

1. Click **Start > Messaging** then select an e-mail account.
2. Click **Menu > New**.
3. Enter the e-mail address of one or more recipients, separating them with a semicolon. To access e-mail addresses stored in Contacts, click **To**.
4. Enter a subject and compose your message. To quickly add common messages, click **Menu > My Text** and click a desired message.
5. Click **Send**.

- Tips**
- To set the priority, click **Menu > Message Options**.
 - If you are working offline, e-mail messages are moved to the Outbox folder and will be sent the next time you connect.

To add an attachment to an e-mail

1. In the message that you are composing, click **Menu > Insert** and click the item you want to attach: **Picture, Voice Note, or File**.
2. Select the file you want to attach, or record a voice note.

View and reply to e-mails

When in an e-mail account, press and hold 0 (zero) to open a shortcut list of often-used commands. Press and hold the shortcut key to execute the command.

To filter the Inbox message list

Filter the e-mail messages in your Inbox to only display the e-mails that contain the sender or e-mail subject you are searching for.

Enter the sender name or e-mail subject you want to look for using the keypad or keyboard. As you press keys, the list narrows down to the conditions you set.

For example, pressing "S" then "A" narrows the list to only the e-mails that contain sender names and e-mail subjects that start with "SA."

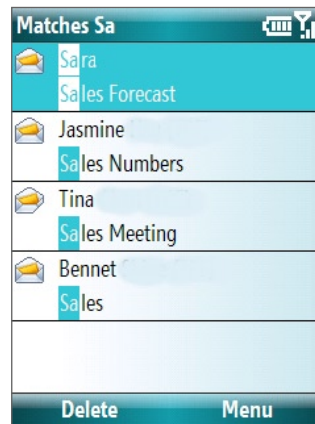

To read incoming messages

By default, only the first few kilobytes of a message are shown when you open and read an incoming message. To read the whole message, do one of the following:

- Scroll down to the end of the message and click **Get the rest of this message**; or
- Click **Menu > Download Message**.

To download an attachment

In an open message with an attachment to download, click the attachment. If there is more than one attachment, click the other attachments to download them. You can directly open the file in the associated program after you download them by clicking the attachment again.

To reply to or forward an e-mail

1. Open the message and click **Menu > Reply > Reply, Reply All, or Forward**.
2. Enter your response. To quickly add common messages, click **Menu > My Text** and choose a desired message.
3. Click **Send**.

- Tips**
- To see more header information, scroll up.
 - To always include the original message, from the list view, click **Menu > Tools > Options > Sending**, and select the **Include copy of original message when replying to e-mail** check box.
 - In the Outlook E-mail account, you will send less data if you do not edit the original message. This may reduce data transfer costs based on your rate plan.

To view and reply to HTML e-mails

You can receive, view and reply to HTML e-mails from any type of e-mail account. The HTML format is retained, without layout shifting or resizing.

Note HTML e-mail support in Outlook Mobile is available only if your company is using Microsoft Exchange Server 2007.

1. Set the message format to HTML. To find out how to set the message format, see "Customize e-mail settings".
2. Click **Start > Messaging**, select your e-mail account, and open an HTML e-mail that you received.
3. Click **Get the rest of this message** that's shown at the bottom of the message to download the whole message.
4. Scroll up (if needed) and click **Click to scroll right** to be able to scroll sideways and get a complete horizontal view of the message.

Note If images do not immediately appear, click **Internet pictures blocked > Download Internet pictures**.

5. Click **Reply** or click **Menu > Reply** and choose whether to reply to the sender(s) or forward the message.
6. Enter your response and click **Send**.

Tip E-mail can contain hyperlinks to Web pages.

Send and download e-mails

The manner in which you send and receive e-mails depends on the type of e-mail account you have.

To send and receive e-mail for an Outlook account

1. Click **Start > ActiveSync**.
2. Connect your phone to your PC.
Otherwise, connect wirelessly if you are synchronizing Outlook e-mail with your company e-mail server. For more information, see chapter 7.
3. Synchronization automatically begins, and your phone sends and receives Outlook e-mail.

Tip You can also manually synchronize anytime by clicking **Sync** in ActiveSync or **Menu > Send/Receive** in Outlook Mobile.

To send and receive e-mail for a POP3/IMAP4 account

If you have an e-mail account with an ISP or a work account that you access using a VPN server connection, you send and receive messages through a remote e-mail server. Before sending and downloading messages, you first need to connect to the Internet or your corporate network.

1. Click **Start > Messaging** and click your POP3/IMAP4 e-mail account.
2. Click **Menu > Send/Receive**. The messages on your phone and e-mail server are synchronized: new messages are downloaded to the phone Inbox folder, messages in the phone Outbox folder are sent, and messages that have been deleted from the server are removed from the phone Inbox folder.

Customize e-mail settings

To change the download size and format for Outlook e-mail

1. Disconnect your phone from the computer.
2. Click **Start > ActiveSync**.
3. Click **Menu > Options**, select **E-mail**, then click **Settings**.

4. On the E-mail Sync screen, set the **Download size limit** and **Message format**.
5. Close ActiveSync and reconnect your phone to the computer.

To change the download size and format for POP3/IMAP4 e-mail

1. On the POP3/IMAP4 e-mail message list, click **Menu > Tools > Options > Account Settings**.
2. Keep clicking **Next** until you reach the last screen where the first item is **Message format**.
3. Set the **Message format** and **Message download limit**.
4. Click **Finish**.

To exclude your e-mail address when replying to all

When you reply to all the recipients of an Outlook e-mail, your own e-mail address will also be added to the recipient list. Customize ActiveSync so that your e-mail address will be excluded from the recipient list.

1. In ActiveSync on your phone, click **Menu > Options**.
2. Select the **E-mail** information type and click **Settings**.
3. Click **Menu > Advanced**.
4. In the **My e-mail addresses** text box, enter your e-mail address.
5. Click **Done**.

Chapter 7

Working with Company E-mails and Meeting Appointments

**7.1 Synchronizing Your Phone with Your
Company E-mail Server**

7.2 Working with Company E-mails

7.3 Managing Meeting Requests

7.4 Finding Contacts in the Company Directory

7.5 E-mail Security

7.1 Synchronizing Your Phone with Your Company E-mail Server

Synchronize your phone with your company's Microsoft Exchange Server to keep you connected with your e-mails, contacts, calendar, and other information.

Set up a company e-mail server connection

Use your phone to access your company e-mails by setting up an Exchange Server connection. You can get the company e-mail server information from your network administrator:

1. Click **Start > Messaging > New E-mail Account**.
2. In the **Your e-mail source** list, select **Exchange server** and click **Next**.
3. On the screen that follows, click **Next**.
4. In **Server address**, enter the Exchange Server name, and click **Next**.
5. Enter your user name, password, and domain, and click **Next**.
6. Select the check boxes for the types of information items that you want to synchronize with the Exchange Server.

Tip To change the rules for resolving synchronization conflicts, click **Menu > Advanced**.

7. To change synchronization settings of an information type, for example, E-mail, select the type of information, and click **Menu > Settings**.

8. Click **Finish**.

Note If you synchronized e-mails with your PC before, open ActiveSync on your phone and click **Menu > Add Server Source** to set up an Exchange Server connection. When you're prompted to select information types for synchronization, you need to clear the **E-mail** check box under the Windows PC item first before you can select the **E-mail** check box under Exchange Server.

Tip To change Exchange Server settings, open ActiveSync on your phone and click **Menu > Configure Server**.

Start synchronization

Before you start synchronizing with the Exchange Server, make sure your phone has been set up with a data connection to the Internet so that you can synchronize wirelessly. See chapter 8 for details.

After you finish setting up an Exchange Server connection, your phone automatically starts synchronization. You can manually start synchronization anytime by clicking **Sync** in ActiveSync.

Note If you connect your phone to your office computer via a USB or Bluetooth connection, you can use this connection to the PC to "pass through" to the network and download Outlook e-mails and other information to your phone.

7.2 Working with Company E-mails

Your phone gives you instant access to your company e-mails and lets you manage your messages easier. Messaging features such as Direct Push, Fetch Mail, and Filtering messages are just some of the tools you can use to manage your e-mails.

Note Some messaging features depend on the Microsoft Exchange Server version used. Please check with your network administrator for the availability of Exchange Server features.

Automatic synchronization through Direct Push

Direct Push technology (push e-mail feature) enables you to receive new e-mails on your phone as soon as they arrive in your Inbox on the Exchange Server. With this feature, items such as contacts, calendar and tasks

are also immediately updated onto your phone when these items have been changed or new entries have been added on the Exchange Server. To make Direct Push work, you need to have a active Internet connection on your phone.

You need to perform a full synchronization between your phone and the Exchange Server first before Direct Push can be enabled.

Requirement The Direct Push feature works for your phone only if your company is using **Microsoft Exchange Server 2003 Service Pack 2 (SP2) with Exchange ActiveSync or higher version.**

To enable Direct Push via Comm Manager

1. Click **Start > Comm Manager**.
2. On the Comm Manager screen, click the **Microsoft Direct Push** button. The button  will turn to , which indicates that you will receive e-mails as they arrive.

When the button is in the  state, you need to manually retrieve your e-mails.

To enable Direct Push via ActiveSync

1. In ActiveSync on your phone, click **Menu > Schedule**.
2. Select **As items arrive** in the **Peak times** and **Off-peak times** boxes.

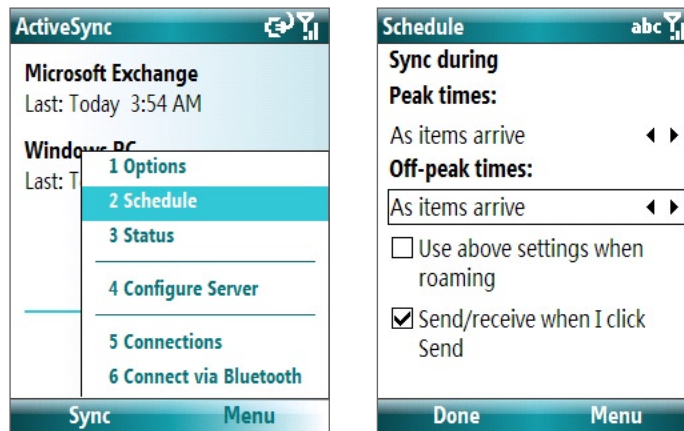

Scheduled synchronization

If you do not want to use Direct Push, you can set a regular schedule for synchronizing Outlook e-mail and information.

1. In ActiveSync on your phone, click **Menu > Schedule**.
2. Select a shorter time interval in the **Peak times** box for you to be able to receive e-mails more frequently.
3. Select a longer interval in the **Off-peak times** box.

Tip Click **Menu > Peak Times** to set the peak and off-peak times.

Instant download through Fetch Mail

Fetch Mail downloads an entire e-mail immediately without the need for you to perform a full Send/Receive action.

Requirement Fetch Mail works for your phone only if your company is using **Microsoft Exchange Server 2007 or higher.**

1. Click **Start > Messaging > Outlook E-mail**.
2. Click an e-mail message to open it.

3. By default, only the first few kilobytes of the message is shown. To download the whole e-mail, scroll to the bottom of the message then click **Get the rest of this message**.
4. A "Downloading message" status appears. Wait for the remainder of the message body to be downloaded.

Tip For information about changing e-mail sync options such as the initial download size limit for e-mail, see "Customize e-mail settings" in chapter 6.

Search for e-mails on the Exchange Server

You can access messages that are not available on your phone by searching your Microsoft Exchange Server mailbox. The search results will be downloaded and displayed in a Search Results folder.

Requirement Your company must be using **Microsoft Exchange Server 2007 or higher**.

1. Click **Start > Messaging > Outlook E-mail**.
2. Click **Menu > Tools > Search Server**.
3. In the **Look for** text box, enter the search keyword.
4. Choose the **Date range** of messages to search from and where to search in **Look in**.
5. Click **Search**.

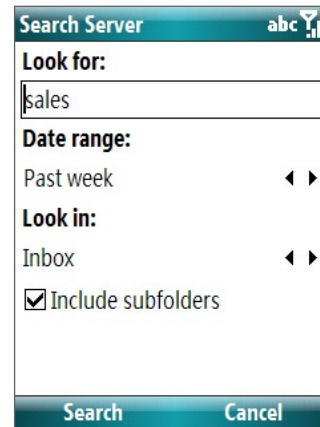

Flag your messages

Flags serve as a reminder to yourself to follow-up on important issues or requests that are indicated in the messages.

Requirement Flags are enabled only if e-mails are synchronized with **Microsoft Exchange Server 2007 or higher**. Flags are disabled or hidden if e-mails are synchronized with earlier versions of Microsoft Exchange Server.

To flag or unflag a message

1. Click **Start > Messaging > Outlook E-mail**.
2. Select a message, or open a message.
3. Click **Menu > Follow Up** and select one of the following options:
 - **Set Flag** Mark the message with a red flag to indicate that it needs follow up.
 - **Complete Flag** Mark the message with a check mark to indicate that the issue or request in the e-mail is already completed.
 - **Clear Flag** Remove the flag to unmark the message.

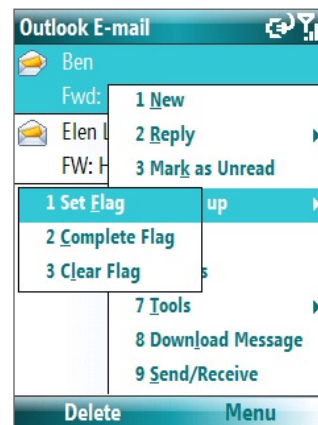

Note E-mail message reminders are displayed on your phone if the messages are flagged with reminders and synchronized from the Exchange Server.

Out-of-office auto-reply

Outlook Mobile allows you to retrieve and change your out-of-office status. Just like desktop Outlook E-mail, Outlook Mobile automatically sends an auto-reply message when you're not available.

Requirement Your company must be using **Microsoft Exchange Server 2007 or higher**.

To send out-of-office auto-reply messages

1. Click **Start > Messaging > Outlook E-mail**.
2. Click **Menu > Tools > Out of Office**.
3. From the **I am currently** list, select **Out of the Office**.
4. Enter your auto-reply message then click **Done**.

View SharePoint documents

When you receive an HTML e-mail containing a link to a SharePoint document, you can click the link to access and view the document on your phone.

Requirement Your company must be using **Microsoft Exchange Server 2007 or higher**.

7.3 Managing Meeting Requests

When you schedule and send meeting requests from your phone, you can invite attendees to your meeting and check their status to know their availability.

When you receive a meeting request, you can reply by accepting or declining the request. The meeting request also clearly indicates whether or not there are conflicting or adjacent meetings.

Requirement Your company must be using **Microsoft Exchange Server 2007 or higher**.

To check the status of invited attendees

1. Click **Start > Calendar**.
2. Follow the procedure in "To send a meeting request" in chapter 5 to invite required and optional attendees and send a meeting request.
3. Wait for the attendees to respond. When their responses are sent back to you, your calendar is updated as well.
4. To check the status of the attendees who responded, click **Start > Calendar** and then click the scheduled meeting.
5. In the meeting details, click **Attendees**.

To reply to a meeting request

1. When there's an incoming e-mail with a meeting request, a notification message will be displayed on your phone's Home screen. Scroll to **Outlook e-mail** and click it.
2. In the Outlook message list, click the e-mail to open it.
3. Click **Accept** to reply and accept the meeting request, or click **Menu > Decline** if you cannot attend the meeting.

- Tips**
- Before responding, you can check your availability during the time of the requested meeting by clicking **View your calendar**.
 - If the time of the meeting conflicts with your other appointments, a "Scheduling Conflict" status appears on top of the e-mail.
3. Choose whether or not to edit the response e-mail before sending and then click **OK**:

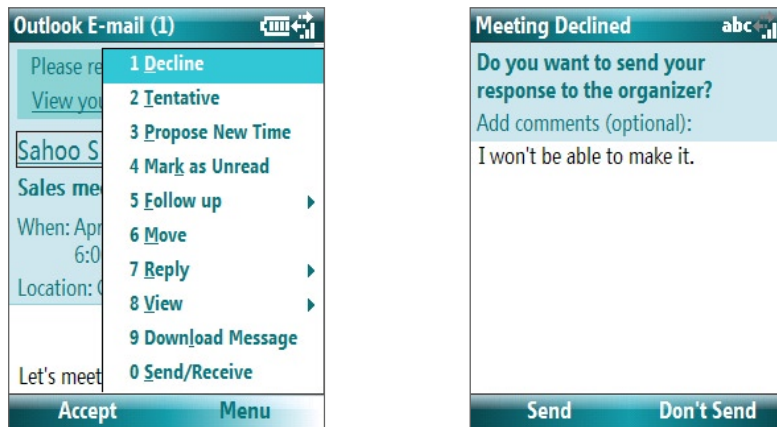

- If you accepted the meeting request, it will automatically be added as an appointment in Calendar on your phone.

7.4 Finding Contacts in the Company Directory

In addition to having contacts on your phone, you can access contact information from your organization's Company Directory.

Requirement Access to the Company Directory is available only if your organization is running **Microsoft Exchange Server 2003 SP2** or higher, and you have completed your first synchronization with the Exchange Server.

- Synchronize with Exchange Server if you have never done so.
- Do any of the following:
 - In Contacts, click **Menu > Company Directory**.
 - In a new e-mail, click the **To** box and then click **Company Directory** at the top of the list or click **Menu > Company Directory**.

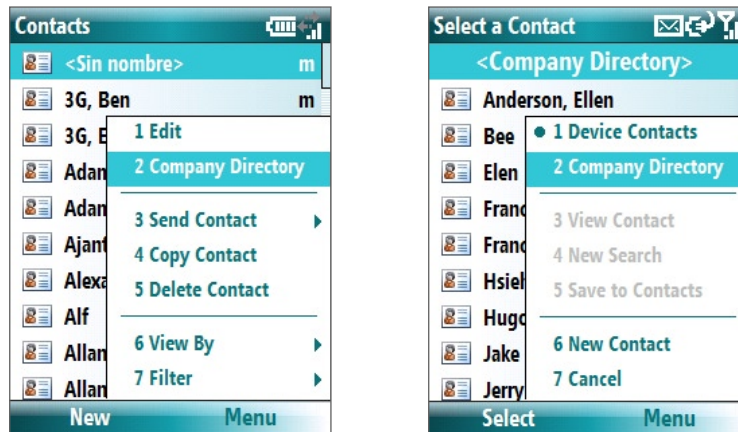

In Contacts

In a new e-mail

- In a new meeting request using Calendar, scroll to **Attendees** and click **No attendees > Add Required Attendee** or **Add Optional Attendee** and then click **Company Directory** at the top of the list.
- Enter the part or full contact name and click **Search**. In the search results list, click a contact to select it.

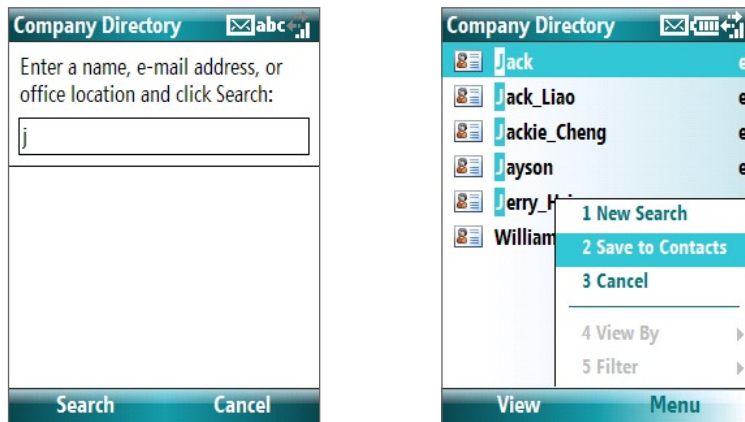

- Notes**
- You can save the contact from the Company Directory to your phone by selecting the contact then clicking **Menu > Save to Contacts**.
 - You can search on the following information as long as that information is included in your organization's Company Directory: First name, Last name, E-mail name, Display name, E-mail address, or Office location.

7.5 E-mail Security

Windows Mobile on your phone protects your Outlook e-mails through Secure/Multipurpose Internet Mail Extension (S/MIME), which allows you to digitally sign and encrypt your messages.

Requirement S/MIME encryption and digital signatures for Windows Mobile-based phones are available only with **Exchange Server 2003 SP2** or a later version that supports S/MIME. If you are not using one of these products, or have not yet synchronized, these options are unavailable.

Note You can encrypt a message with or without a certificate. However, to read an encrypted message, you need a valid certificate to decrypt it.

To individually sign and encrypt a new message

- Click **Start > Messaging > Outlook E-mail**.
- Click **Menu > New** to create a new message.
- Click **Menu > Message Options**.
- From the **Security** list, select whether to encrypt only, sign the message only, or do both.
- Click **Done**.

To verify the digital signature on a signed message you receive

- Open the Outlook e-mail message that has been digitally signed.
- At the top of the message, click **View signature status**.
- Click **Menu > Check Certificate**.

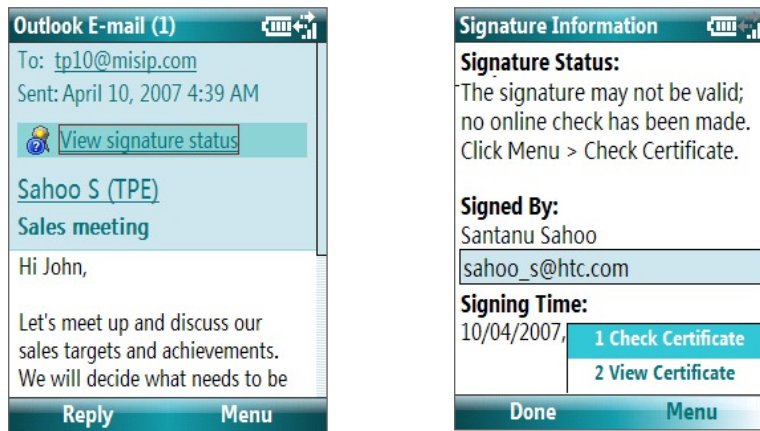

To view the details of the certificate in the message, click **Menu > View Certificate**.

Note There can be several reasons why a digital signature is not valid. For example, the sender's certificate may have expired, it may have been revoked by the certificate authority, or the server that verifies the certificate is unavailable. Contact the sender to report the problem.

To digitally sign and encrypt all messages

You can set up ActiveSync to digitally sign and encrypt all outgoing messages. You must obtain a valid certificate to sign and encrypt e-mail messages successfully.

1. Click **Start > ActiveSync**.
2. Click **Menu > Options**.
3. Select the **E-mail** information type, and click **Settings**. On the E-mail Sync Options screen, click **Menu > Advanced**.

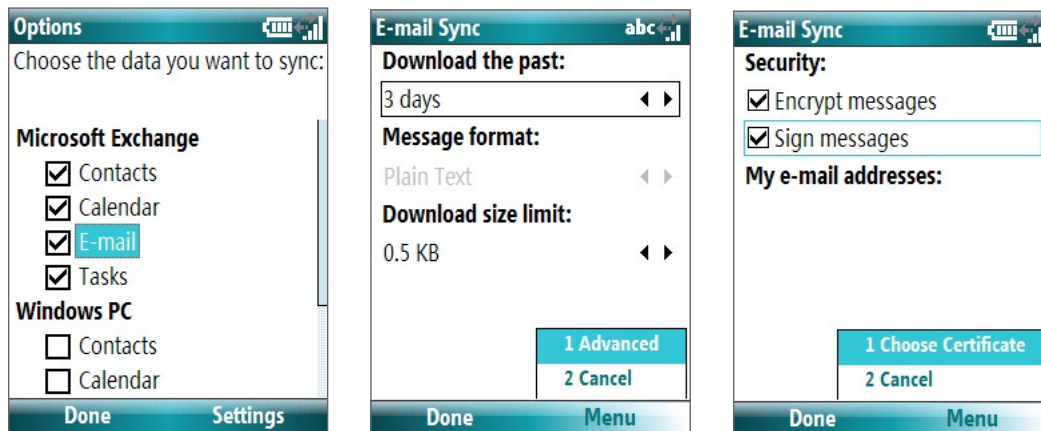

4. Select **Encrypt messages** to protect your e-mails from being viewed except by the intended recipients. Select **Sign messages** so that recipients are certain that e-mails are sent by you and have not been altered.
5. Click **Menu > Choose Certificate** to select a certificate for signing or encrypting outgoing e-mail messages.

Set permissions on an e-mail message

Another way of protecting your e-mail messages is to send messages with restricted permissions using Information Rights Management (IRM).

Requirement This works only with a Microsoft Outlook e-mail account and if your company is using RMS Server SP1.

1. Click **Start > Messaging > Outlook E-mail**.
2. Create a message, then click **Menu > Message Options**.
3. In **Permission**, do one of the following:
 - To allow anyone to read the message, select **Unrestricted Access**.
 - To prevent the message from being forwarded, printed, or copied, select **Do Not Forward**.
4. Click **Done**.

Tip An IRM-protected message received on your phone can only be replied to or forwarded if the message permits it.

Chapter 8

Getting Connected

8.1 Comm Manager

8.2 Connecting to the Internet

8.3 Internet Explorer Mobile

8.4 Wireless Modem

8.5 Bluetooth

8.6 Windows Live Mobile

8.1 Comm Manager

Comm Manager acts like a central switcher that lets you enable or disable phone features as well as manage your data connections easily.

To open Comm Manager:

- Click **Start > Comm Manager** or **Start > Settings > Connections > Comm Manager**.
- Press POWER briefly and select **Comm Manager** from the Quick List.
- Press and hold HOME.

1. Click to toggle between turning on or off Flight mode. Turning on Flight mode turns off the phone and Bluetooth functions.
2. Click to toggle between enabling or disabling the phone. Click **Settings > Phone** to manage Phone settings.
3. Click to toggle between turning on or off Bluetooth. See "Using Bluetooth" for details. Click **Settings > Bluetooth Settings** to configure Bluetooth on your phone.
4. Click to toggle between automatically receiving (as items arrive) or manually retrieving Outlook e-mails. For more information, see "To receive e-mails and synchronize other information instantly" in Chapter 3.
5. Click to stop active data services (e.g. ISP dial-up, 1xRTT, or 1xEVDO). You cannot reconnect data services in Comm Manager.
6. Click to toggle between turning on the phone's ringer or setting it to vibration/mute mode. Click **Settings > Profiles** to edit a profile or customize notification settings.
7. Click to open ActiveSync so you can synchronize the phone and computer. For more information about the configuration settings for ActiveSync, see Chapter 3.

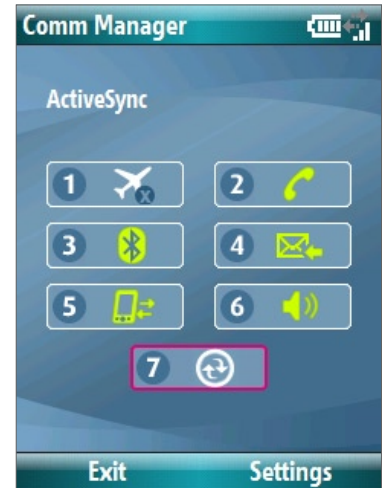

Comm Manager screen

Note You can also change the Phone settings and Profiles from the Comm Manager screen by clicking **Settings**.

8.2 Connecting to the Internet

Your phone's powerful networking capabilities allow you to access the Internet or your corporate network at work through wireless and conventional connections. Specifically, you can configure your phone to establish a connection via Dial-up, Bluetooth, Virtual Private Network (VPN), or Proxy.

If you need to manually set up a connection, it is important that you obtain the following information from your Internet Service Provider (ISP) or the company whose intranet you are trying to access:

- ISP server phone number
- User name
- Password
- Domain name (required for accessing a corporate network or an intranet)

Set up a Dial-up connection

When you use your phone to dial up to your ISP and connect to the Internet or to your corporate network, you will be billed by the number of minutes that you use.

However, there are some high speed and high performance data connection services (such as 1xRTT and 1xEVDO) available on your phone. While 1xRTT (1 times Radio Transmission Technology) is a third-generation data service (equivalent to GPRS), 1xEVDO (1 times Evolution Data Optimized) is another high speed wireless broadband service (equivalent to UMTS) available on your phone for quick Internet access and Direct Push to work. For more information on how to avail these services, contact your network service provider.

To establish a dial-up connection on your phone, you need the same settings that you normally use when you dial up from your computer. This includes the ISP server phone number, your user name, and password.

To set up a dial-up connection for browsing the Internet

1. On the Home screen, click **Start > Settings > Connections > Dial-up**.
2. Click **New** or **Menu > Add**.
3. In **Description**, enter a name for the connection.
4. In **Connects to**, select **The Internet**.
5. Enter the appropriate information in the remaining fields.

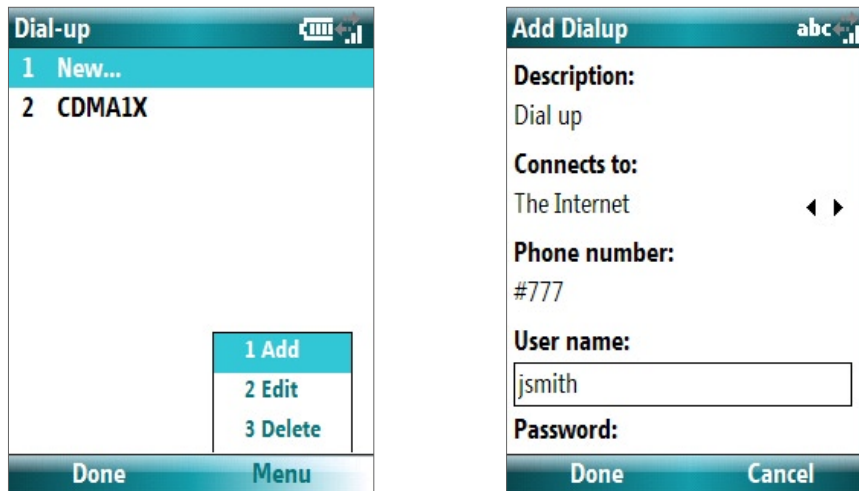

6. Click **Done**. To start browsing the Internet, click **Start > Internet Explorer**.

To set up a dial-up connection to your corporate network

1. On the Home screen, click **Start > Settings > Connections > Dial-up**.
2. Click **Menu > Add**.
3. In **Description**, enter a name for the connection.
4. In **Connects to**, select **Work**.
5. Enter the appropriate information in the remaining fields.
6. Click **Done**.

Note You can also add and set up the following connections:

- **VPN:** A VPN connection is used to access your corporate network by using an existing Internet connection.
- **Proxy:** A Proxy connection is used to access the Internet using an existing connection to your corporate or WAP network.

Advanced options

From the Connections screen, you can access advanced options to specify the service provider, the number of redial attempts, the amount of idle time to wait before disconnecting, and so on.

1. On the Home screen, click **Start > Settings > Connections**.
2. Click **Menu > Advanced**.
3. Select a network service provider for each connection type. You can choose **Automatic** to allow the phone to set a service provider for each connection by default.
4. Click **Menu > Options**.
5. Choose the appropriate information in the remaining fields.
6. Click **Done**.

Add a URL exception

Some URLs for Web pages on your company intranet may use periods, for example: intranet.companyname.com. To view these pages in Internet Explorer Mobile, you must create a URL exception.

1. On the Home screen, click **Start > Settings > Connections**.
2. Click **Menu > Advanced**.
3. Click **Menu > Work URL Exceptions**.
4. Click **Menu > Add**.
5. In **URL Pattern**, enter the URL name.
To add multiple URLs, use a semicolon (;).
6. Click **Done**.

Note You do not need to create URL exceptions for Internet URLs.

8.3 Internet Explorer Mobile

Internet Explorer Mobile is a full-featured Internet browser, optimized for use on your phone.

To open Internet Explorer

- On the Home screen, click **Start > Internet Explorer**.

Note You can also open Internet Explorer by pressing  and then  from the QWERTY keyboard.

Browse the Web

1. In Internet Explorer, click **Menu > Address Bar**.
2. Enter the address and click **Go**.
3. Use the NAVIGATION CONTROL to browse the Web page. Press ENTER when a link is highlighted to access it.

While browsing the Web, click **Menu** to open a list of options that will let you change the view, save Favorites, and set Internet Explorer Mobile preferences, and more.



Click **Menu > Add to Favorites** to save the current Web page in your Favorites folder. Click **Favorites** to access your Favorites folder.



Click **Menu > View** and then select the text size and type of view you want to use while browsing a Web page.



Click **Menu > Tools** to let you send the link via e-mail, view the page's properties, or set Internet Explorer Mobile preferences.

For more information about Internet Explorer Mobile, please go to <http://www.microsoft.com/windowsmobile/help/smartphone/browseinternet.mspx>

8.4 Wireless Modem

With **Wireless Modem**, you can use your phone as an external modem for another device, such as a PDA or a computer.

Note Make sure your phone has an active dial-up modem connection. For information about setting up a dial-up connection on your phone, see "Set up a Dial up connection" in this chapter.

Set up your phone as a USB modem

1. On the Home screen of your phone, click **Start > Wireless Modem**.
2. Select **USB** as the **Connection** type.
3. On your PC, disable ActiveSync. Then connect your phone to the PC using the USB sync cable.

Note To disable ActiveSync on your PC, click **File > Connection Settings** and then clear **Allow USB connections**.

4. On the Wireless Modem screen of your phone, click **Menu > Start**.
The PC will automatically detect that your phone has been connected. The Found New Hardware dialogue box will then appear on your PC.
5. In the Found New Hardware dialogue box, select **Install from a list or specific location (Advanced)** and click **Next**.
6. Select **Search for the best drivers in these locations**.
7. Insert the Getting Started Disc into your CD drive. Select the **Include this location in the search** check box, then click **Browse** and choose the CD drive and root folder where the modem driver is located. Then click **Next**.
8. Wait for the installation to complete, then click **Finish**.
9. On your PC, click **Start > Settings > Control Panel**.
10. Double-click **Phone and Modem Options**.
11. Click the **Modems** tab. Select the new modem from the Modems list, then click **OK**.

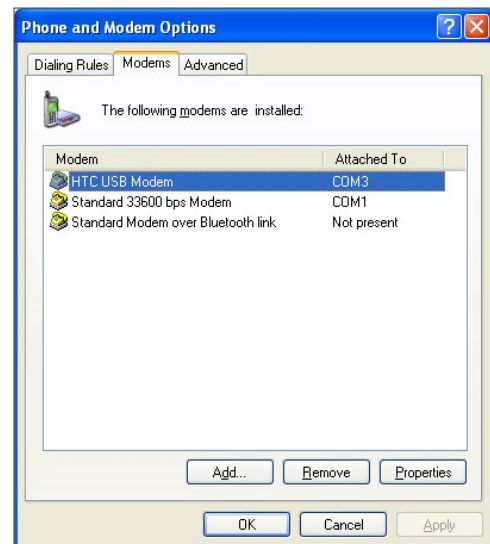

Set up a Dial-up connection on your PC

Once the PC recognizes your phone as a modem, you can set up a dial-up connection on your PC. You will then be able to access the Internet on your PC using your phone.

To dial-up and connect to the Internet

1. On your PC, click **Start > Settings > Control Panel**.
2. Double-click **Network Connections**.
3. Click **File > New Connection**.
4. In the New Connection Wizard, click **Next**.
5. Click **Connect to the Internet**, then click **Next**.

6. Select **Set up my connection manually** and then click **Next**.
7. Select **Connect using a dial-up modem** and then click **Next**.
8. Select the modem that you previously installed, then click **Next**.
9. Enter a descriptive name for your ISP, then click **Next**.
10. Enter your ISP's dial-up phone number and then click **Next**.
11. Under Internet Account Information, enter the user name and password used for dial-up and click **Next**.
12. Click **Finish** to exit the wizard.
13. The Connect dialogue box then opens. Click **Dial** to dial up and connect to the Internet.



Next time you want to dial up again from your computer, click **Start > Settings > Control Panel**, double-click **Network Connections**, then double-click the modem connection.

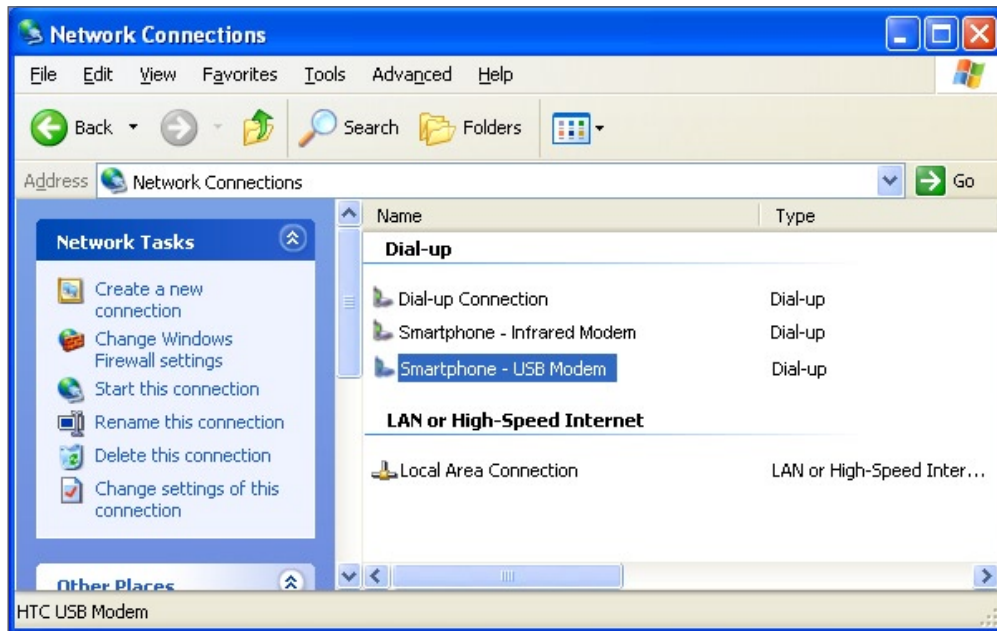

Note To dial up to the Internet from your PC, you can also use the dialer program, USBModem_Dialer.exe, which is included in the Getting Started Disc.

End the modem session

1. On the Wireless Modem screen, click **Menu > Stop**.
2. Finally, click **Done** to exit Wireless Modem.

8.5 Bluetooth

Bluetooth is a short-range wireless communications technology. Phones with Bluetooth capabilities can exchange information within a distance of about 10 meters without requiring a physical connection.

Bluetooth modes

Bluetooth on your phone operates in three different modes:

1. **On.** Bluetooth is turned on. Your phone can detect other Bluetooth-enabled devices, but not vice versa.
2. **Off.** Bluetooth is turned off. In this mode, you can neither send nor receive information using Bluetooth. You might want to turn off the radio at times to conserve battery power, or in situations where radio use is prohibited, such as onboard an aircraft and in hospitals.
3. **Visible.** Bluetooth is turned on, and all other Bluetooth-enabled devices within range can detect your phone.

Note By default, Bluetooth is turned off. If you turn it on, and then turn off your phone or turn on the flight mode, Bluetooth also turns off. When you turn on your phone again or turn off the flight mode, Bluetooth automatically turns on.

To turn on or off Bluetooth on your phone

You can enable Bluetooth by clicking the On/Off switch in Comm Manager. You can also do the following:

1. On the Home screen, click **Start > Settings > Connections > Bluetooth**.
2. Click **Bluetooth > Menu > Turn on Bluetooth**.

To turn off Bluetooth capabilities on your phone, click **Bluetooth > Menu > Turn off Bluetooth**.

To make your phone visible

1. On the Home screen, click **Start > Settings > Connections > Bluetooth**.
2. Click **Bluetooth > Menu > Turn on Visibility**.

Tip Enter a Bluetooth phone name for your phone. This will be the phone name that will be shown on another Bluetooth-enabled device when it searches and detects your phone. To enter a name, on the Bluetooth screen, click **Security** and enter a **Device name**.

Bluetooth partnerships

A Bluetooth partnership is a relationship that you create between your phone and another Bluetooth-enabled device in order to exchange information in a secure manner.

To create a Bluetooth partnership

1. On the Home screen, click **Start > Settings > Connections > Bluetooth**.
2. Click **Bluetooth > Add new device**.
Your phone searches for other Bluetooth-enabled devices and lists them.
3. Select the desired device name in the list and click **Next**.
4. Enter a passcode (1 up to 16 characters) to establish a secure connection, then click **Next**.
5. Wait for the paired device to accept the partnership:
6. On your phone, a message will appear, indicating that your phone has connected with the paired device. Click **OK**.
7. The name of the paired device is then displayed. You may edit and enter a new name for that device, then click **Next**.
8. Select the check boxes of services that you want to use from the paired device and click **Done**.

To accept a Bluetooth partnership

1. Ensure that Bluetooth is turned on and in visible mode.
2. Click **Yes** when prompted to establish a partnership with the other device.
3. Enter a passcode (the same passcode that is entered on the device requesting the partnership) to establish a secure connection.
4. Click **Next**.
5. A message will appear, indicating that your phone has connected with the paired device. Click **OK**.
6. The name of the paired device is then displayed. You may edit and enter a new name for that device, then click **Next**.
7. Select the check boxes of services that you want to use from the paired device.
8. Click **Done**. You can now exchange information with the other device.

To change the display name of a Bluetooth device

1. On the Home screen, click **Start > Settings > Connections > Bluetooth**.
2. Click **Bluetooth** and then on the screen, select a Bluetooth device.
3. Click **Menu > Edit**.
4. Enter a new display name for the Bluetooth device, then click **Next**.
5. Click **Done**.

To delete a Bluetooth partnership

1. On the Home screen, click **Start > Settings > Connections > Bluetooth**.
2. Click **Bluetooth** and then on the screen, select a Bluetooth device.
3. Click **Menu > Delete**, and then click **Yes** in the confirmation screen.
4. Click **Done**.

Connect a Bluetooth hands-free or stereo headset

For hands-free phone conversations or to listen to music, you can use a Bluetooth hands-free or stereo headset.

Note You need a Bluetooth stereo headset to listen to music.

To connect a Bluetooth hands-free or stereo headset

1. Make sure that both your phone and the Bluetooth headset are turned on and within close range, and that the headset is visible. Refer to the manufacturer's documentation to find out how to set the headset in visible mode.
2. On the Home screen, click **Start > Settings > Connections > Bluetooth**.
3. Click **Bluetooth > Add new device**. Your phone searches for other Bluetooth-enabled devices and displays them in the list.

4. Select the name of the headset, and click **Next**.
5. In **Passcode**, enter the alphanumeric passcode for the Bluetooth headset, then click **Next**. The passcode is usually "0000".

A message will appear saying that your phone has connected to the headset, click **OK**.
6. Enter the display name for the headset and click **Next**.

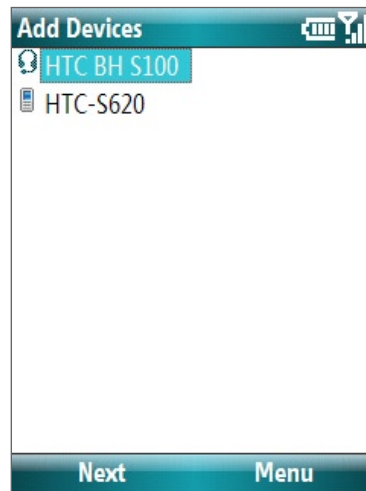

7. Select the check boxes for the **Wireless Stereo** (if available) and **Hands Free** services, and click **Done**.

Note If the Bluetooth stereo headset becomes disconnected, turn the headset on and repeat steps 1 to 2 above. Select the stereo headset and click **Menu > Set as Wireless Stereo**.

Beam information using Bluetooth

You can beam information, such as contacts, calendar items, and tasks, as well as files from your phone to your computer or to another Bluetooth-enabled device.

Notes

- If your computer does not have built-in Bluetooth capabilities, you need to connect and use a Bluetooth adapter or dongle on your computer.
- Before beaming items to your computer, open Bluetooth Configuration or Bluetooth Settings in the Control Panel and check if there's an option for setting a location for saving beamed items.

To beam information from your phone to a computer

1. Set Bluetooth on your phone to visible mode. For information about this, see "To make your phone visible".
2. Next, set Bluetooth on your computer to visible mode, create a Bluetooth partnership, then enable your computer to receive Bluetooth beams.

If your computer has Windows Vista or Windows XP SP2 and your computer's Bluetooth adapter is supported by your Windows version, do the following steps:

- a. On your computer, open **Bluetooth Devices** from the Control Panel then click the **Options** tab.
 - b. For **Windows Vista**, select **Allow Bluetooth devices to find this computer**.

For **Windows XP**, select **Turn discovery on** and **Allow Bluetooth devices to connect to this computer**.
 - c. Create a Bluetooth partnership between your phone and computer. For information about creating a partnership, see "Bluetooth partnerships".
 - d. In the **Options** tab of **Bluetooth Devices**, select **Show the Bluetooth icon in the notification area**.
 - e. To enable your computer to receive Bluetooth beams, right-click the Bluetooth icon at the bottom-right of your computer screen and select **Receive a File**.
3. Now you are ready to beam. On your phone, select an item to beam. The item can be an appointment in your calendar, a task, a contact card, or a file.
 4. Click **Menu > Beam [type of item]**.
 5. Select the device name to which you want to beam to.
 6. Click **Beam**.

- If you beamed a calendar, task, or contact item to your computer and it is not automatically added to Outlook, click **File > Import and Export** to import it to Microsoft Outlook on your computer.

To beam information to a Bluetooth-enabled device such as another phone, create a Bluetooth partnership then do steps 3 to 6 in the above procedure.

Tip The default folder on your computer where beamed items are stored may be
Windows XP: C:\Documents and Settings\your_username\My Documents
Windows Vista: C:\users\your_username\My Documents

8.6 Windows Live Mobile

Windows Live Mobile gives you full Internet experience on your phone.

Windows Live Mobile offers the following key features:

- **Windows Live Search.** Windows Live's search engine for finding information on the web.
- **Windows Live Contacts.** Address book for storing Windows Live Mail, Windows Live Messaging, and Hotmail contacts.
- **Windows Live Messenger Mobile.** Next generation of MSN Messenger Mobile.
- **Windows Live Mail.** Next generation of Hotmail.

Set up Windows Live Mobile

The first time you use Windows Live Mobile, sign in by using your Windows Live ID, which is your Windows Live Mail or Hotmail address, and password.

To set up Windows Live Mobile for the first time

- Click **Start > Windows Live**.
- Click **Sign in to Windows Live**.
- On the next screen, click the links to read the Windows Live Term of Use and the Microsoft Privacy Statement. After reviewing them, click **Accept**.
- Enter your Windows Live Mail or Hotmail address and password, then click **Next**.
- Choose whether or not to show Windows Live's search bar and applications on the Home screen then click **Next**.
- Choose what information you want to synchronize online with your phone.

If you choose to synchronize **Contacts and Messenger**, your online contacts will be added to the contact list and to Windows Live Messenger Mobile on your phone.

If you choose to synchronize **E-mail**, your Windows Live Mail or Hotmail inbox messages will be downloaded to your phone.

- Click **Next**.
- After synchronization is complete, click **Done**.

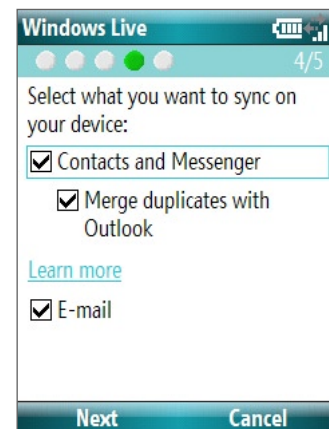
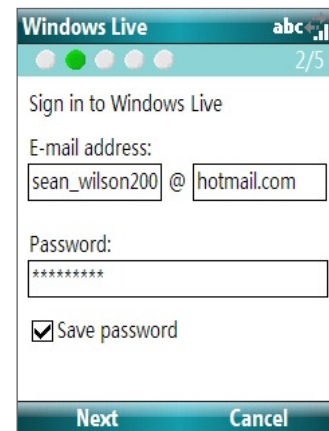

The Windows Live Mobile interface

On the main interface of Windows Live Mobile, you will see a search bar, navigation bar, and an area where you can customize to show your picture.

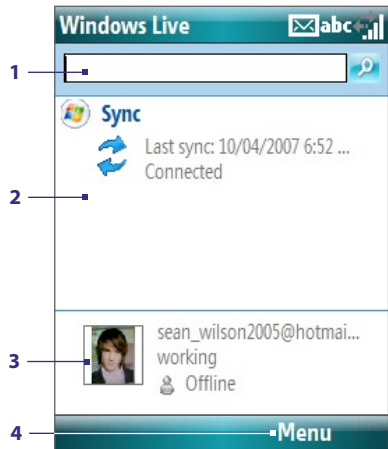

- 1 This is the Windows Live Search bar.
- 2 Press NAVIGATION left or right to switch among Live Mail, Messenger, and Sync status. Click to open/activate the selected Windows Live component.
- 3 Click to access Windows Live Messenger settings.
- 4 Click **Menu** to access and change settings.

If you chose to display the search bar and Windows Live applications on the Home screen when you were setting up Windows Live, you'll see them on the Home screen:

Search bar and
Windows Live applications

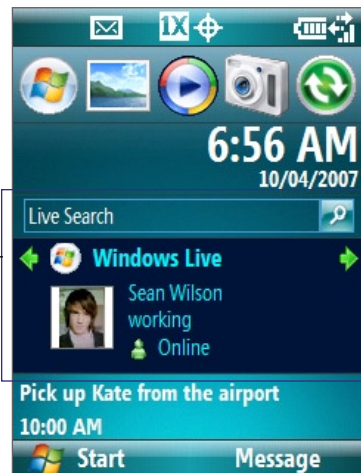

To show or hide them, open Windows Live and click **Menu > Options > Home screen options**.

Chapter 9

Experiencing Multimedia

9.1 Camera and Video Recorder

9.2 Pictures & Videos

9.3 Windows Media Player Mobile

9.4 Java

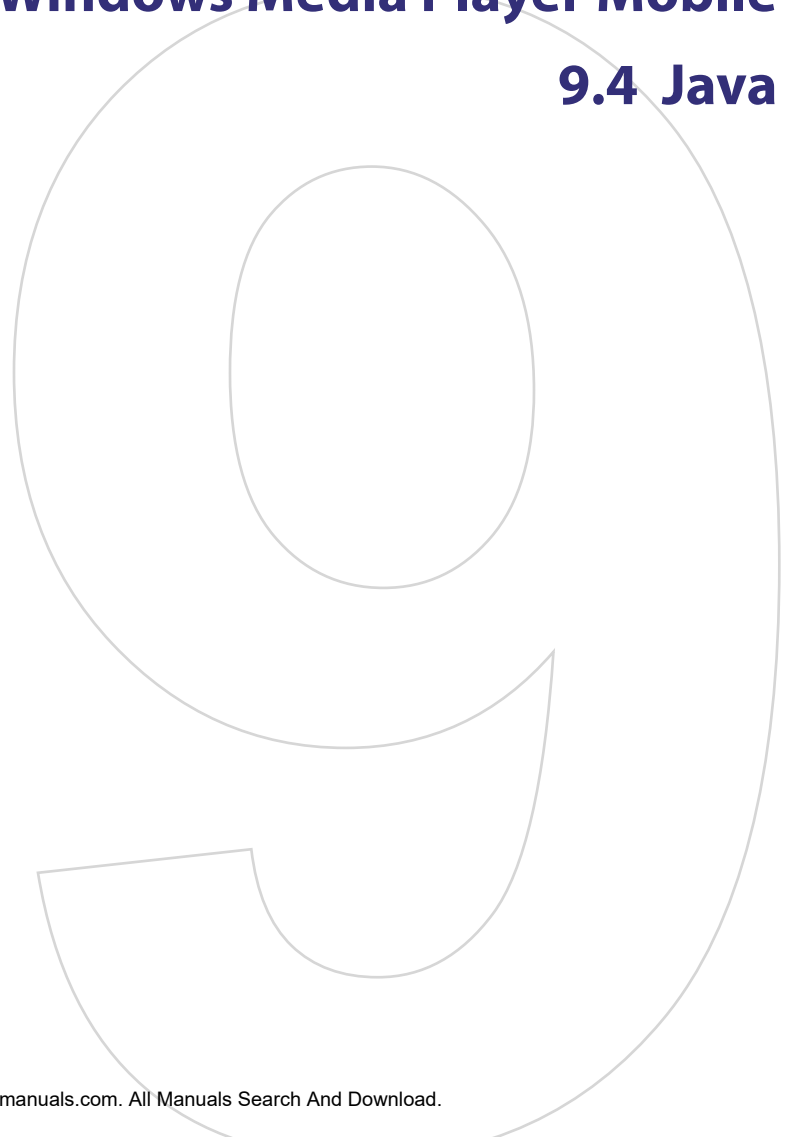

9.1 Camera and Video Recorder

Taking photos and shooting video clips with audio are easy with your phone's built-in camera.

To open Camera or Video Recorder

Do any of the following:

- On the Home screen, click **Start > Camera**.
- On the Home screen, click **Start > Video Recorder**.
- Press and hold the CAMERA button on the right side of the phone.

To exit Camera or Video Recorder

- Press END (📞).

Note Pressing (📞) simply "minimizes" the Camera program, it is still running in the background. To close the Camera program, go to Task Manager.

To capture photos and video clips

Aim the camera at the subject and then press CAMERA or ENTER to take the shot. When capturing video, press CAMERA or ENTER to start recording video; press again to stop recording.

Capture modes

The Camera program lets you capture pictures and video clips using various built-in modes. The title bar displays the active capture mode.



The available capture modes are as follows:

Capture mode	Function
Photo (📷)	Captures standard still images.
Video (📹)	Captures video clips, with or without audio.
Contacts Picture (👤)	Captures a still image suitable for assigning as an identification photo to a contact.
Picture Theme (🖼️)	Captures still images and places them within frames.
Panorama (📷)	Captures a sequence of still images continuously in one direction, and allows stitching of all the images to create a panoramic view of a scenery.
Sports (🏃)	Captures a sequence of still images (3 or 5 frames) automatically for a short duration at a defined frequency.

Using the above capture modes, the camera captures files in the following formats:

Capture type	Format
Still Image	JPEG
Video	Motion-JPEG (.avi) MPEG-4 (.mp4) H.263 baseline (.3gp) 3GPP2 (.3g2)

To change the capture mode

1. On the Camera screen, click  and then keep clicking **Next Setting** to select .
2. Press NAVIGATION right to open the **Mode** list.
3. Click a capture mode from the list and then click **OK**.

Camera mode icons and indicators

The Camera [Photo] screen

- 1 Indicates the current capture mode.
- 2 Indicates the current zoom ratio. Press NAVIGATION up or down to increase or decrease the zoom level.
- 3 Indicates the current image or video size based on the resolution you chose.
- 4 Indicates where the captured images and video clips will be saved.
- 5 Depending on the capture mode, this shows the remaining, available shots of pictures that you can take or remaining duration that can be recorded. While recording video, this shows the recorded duration.
- 6 Click to open the Camera Settings screen.
- 7 Indicates the current Metering mode being used, either **Center Area** (☒) or **Average** (☒).
- 8 Adjust the exposure value from -2 EV to +2 EV (increments of 0.5) by pressing NAVIGATION left or right.
- 9 Indicates the current white balance setting.
- 10 Indicates the current self-timer setting while capturing images.
- 11 Click to view the picture or video in Pictures & Videos.



The Camera [Video] screen



The Recording Status indicator **REC** blinks while video recording is in progress.

The Camera [Picture Theme] screen



Displays the current and total number of photos that can be taken using the selected template.





Use zooming

Before capturing a still image or a video clip, you can first zoom in to make the object in focus move closer, and you can zoom out to make the object move farther away. In all capture modes, press NAVIGATION up on your phone to zoom in, NAVIGATION down to zoom out.

The camera zoom range for a picture or video depends on the capture mode and capture size. Also, please note the capture sizes available for certain capture formats also vary from one capture mode to another.

The Review screen









After capturing a photo or video, you will be presented with options that you can do with the captured media file.

Icon	Function
	Click to go back to Camera screen.
	Click to delete the captured image or video clip.
	Click to send the captured image or video clip to someone via e-mail.
	Click to switch to Pictures & Videos to show the still image, or switch to Windows Media Player to play back the video clip.
	Click to associate the photo to a selected contact. (For Contacts Picture mode only)

Note After you have taken photos in **Sports** mode, the total number of consecutive shots is shown at the lower right corner of the Review screen. Press NAVIGATION up or down to browse through the sequence of photos.

Customize Camera settings

Click  on the Camera screen to open the Camera settings screen where you can activate self-timer, change the ambience, customize capture settings, and more. Use the NAVIGATION CONTROL and the left SOFT KEY to go through the available settings. The following table provides a list of the general options in the menu.

Option	Allows you to
	Select the Self-timer option for capturing images: Off , 2 seconds , or 10 seconds . Selecting 2 seconds or 10 seconds delays the capturing by the specified time after you press ENTER.
	Select whether to save the file in the device memory or on the memory card.
	Only available in Picture Theme mode. Allows you to select a template to use for Picture Theme mode.
	Only available in Panorama mode. Direction determines how the photos will be stitched. Stitch Count determines how many snapshots will be taken for the panoramic photo. When Auto Stitch is On , the camera automatically stitches the snapshots into one single file. When Off , the snapshots are saved as separate files.
	Only available in Sports mode. The Capture Speed option determines the interval between shots. The Snapshots option determines how many shots to take with a single press of ENTER.
	Specify the white balance setting, such as Auto , Daylight , Night , Incandescent , and Fluorescent to suit the lighting environment. You can also choose a special effect, such as Grayscale , Sepia , Cool , or Negative to apply to your photos or video clips.
	Choose the resolution to use and set the metering mode to either Center Area or Average . While capturing images, you can also set the Quality and enable Time Stamp .
	Switch between different capture modes, such as Photo, Video, Contacts Picture, and more. For details, see "Capture modes" earlier in this chapter.
	Access more settings that lets you customize the Camera or Video Recorder functions. You can customize settings such as the capture format, camera shutter sound, flicker adjustment, recording limit, and more.

9.2 Pictures & Videos

The Pictures & Videos program allows you to view and manage media files on your phone.

To copy a picture or video clip to your phone

You can copy pictures from your PC and view them on your phone.

- Copy the pictures and video files from your PC or a storage card to the My Pictures folder on your phone.

For more information about copying files from your PC to your phone, see Windows Mobile Device Center or ActiveSync Help on your PC.

Note You can also copy pictures and video files from your PC to your phone using a memory card. Insert the memory card into the memory card slot on your phone, and then copy them from your PC to the folder you created on the memory card.

To view media files

1. On the Home screen, click **Start > Pictures & Videos**.
2. Select a media file and click **View** or **Play** (if video file) to view or play back the file.

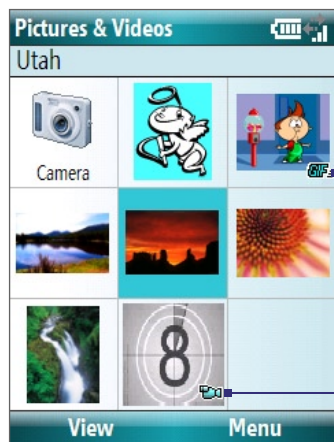

This icon  indicates that the file is a GIF animation file. Click **View** to play back the file.

This icon  indicates that the file is a video file. Click **Play** to play back the file in Windows Media Player Mobile.

Note If you cannot find the media file in the default My Pictures folder, click **Menu > Folders > My Device** to go to other folders.

Pictures & Videos menu

Select a media file onscreen and click **Menu** to open a list of options that you can do with the selected media file. You can choose to send the selected media file via one of your messaging accounts, beam it to another device, play the pictures as a slide show, send the picture to your Windows Live MySpace account, and more.

Click **Options** to customize picture settings and slide show playback preferences.

Note The available menu options depend on the selected media file. When viewing a picture file, click **Menu > Use as Home Screen** to set the picture as your Home Screen background. You can also do minor touch ups to the picture such as rotate and crop by clicking **Menu > Edit**.

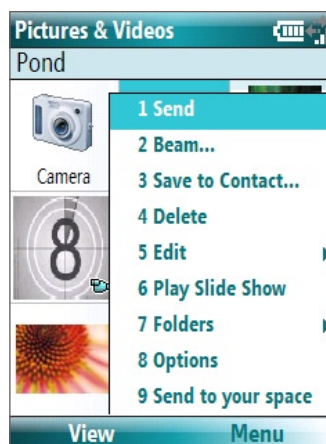

9.3 Windows Media Player Mobile

You can use Microsoft® Windows Media® Player Mobile for Smartphone to play digital audio and video files that are stored on your phone or on a network, such as on a Web site.

To open Windows Media Player Mobile, click **Start > Windows Media**.

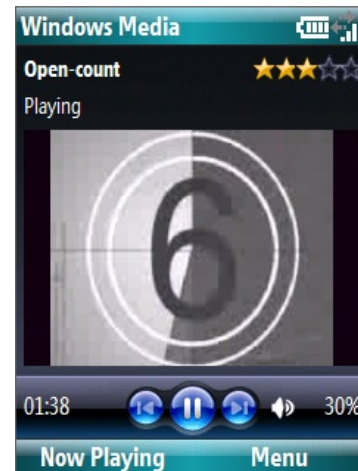

About the controls

By default, these hardware buttons are assigned to Windows Media Player Mobile functions.

Tip To change the assigned hardware buttons, on the Playback screen, click **Menu > Options > Buttons**.

To	Press
Play or pause	ENTER
Skip to a previous file	NAVIGATION left
Skip to the next file	NAVIGATION right
Increase the volume	NAVIGATION up
Decrease the volume	NAVIGATION down
Turn the sound on or off quickly (mute)	#
Switch to full screen during video playback	0
Change rating	*
Fast-forward a file	NAVIGATION right (hold)
Rewind a file	NAVIGATION left (hold)

About the screens and menus

Windows Media Player Mobile has three primary screens:

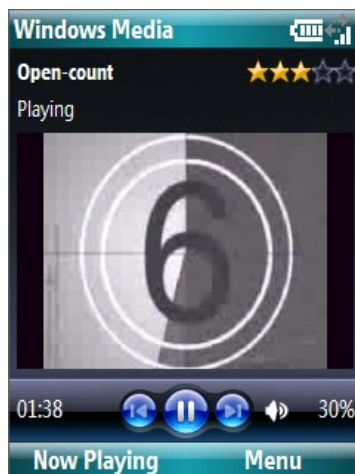

Playback screen

The default screen that displays the playback controls and the video window.

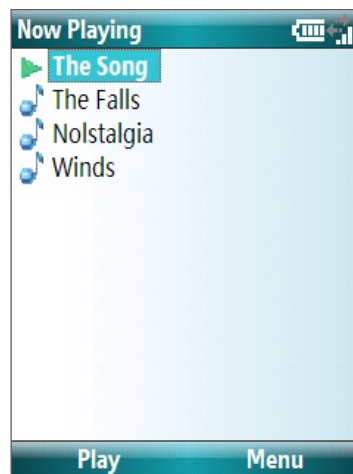

Now Playing screen

This special playlist indicates the current file being played and files that are queued up to play next.

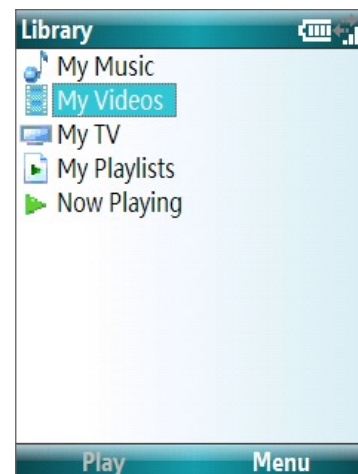

Library screen

The screen that lets you quickly find your audio files, video files, and playlists.

Click **Menu** to open a list of options that you can do in a particular screen. The commands on this menu vary, depending upon which screen you are viewing.

About licenses and protected files

Some media files have associated licenses that protect them from being unlawfully distributed or shared.

If you want to copy a protected file from your PC to your phone, use the Windows Media Player on your PC to synchronize the file to your phone. This will ensure that the license is copied along with the protected file. For more information about synchronizing files to your phone and other mobile devices, see the Windows Media Player Help.

Note You can view the protection status for a file by checking its file properties (**Menu > Properties**).

Copy files to your phone

Use the **Sync** feature in Windows Media Player on your PC to synchronize (copy) digital media files from your PC to your phone. Using **Sync** ensures that protected files and album art (for skins) are copied to your phone correctly.

To synchronize content to your phone automatically

1. On your PC, start Windows Media Player and then connect your phone to your PC.
2. In the Device Setup Wizard, type a name for the phone and click **Finish**.
3. On the leftmost pane, right-click your phone and select **Set Up Sync**.

Note You can also sync your storage card if you have one installed on your phone. To sync, right-click **Storage Card**.

4. On the Device Setup dialog box, select the **Sync this device automatically** and then select the playlist(s) that you want to sync between the PC and your phone.
5. Click **Finish**.

The files begin synchronizing to your phone. The next time you connect your phone to your PC while Windows Media Player is running, synchronization will start automatically.

To synchronize and copy content manually to your phone

1. If you have not set up synchronization between your phone and PC, follow steps 1 to 3 in "To synchronize content to your phone automatically."
2. Click the **Sync** tab on the Windows Media Player. Select a Playlist or a Library on the left panel of the Windows Media Player.
3. From the content list, drag files you want to sync to your phone to the right panel of the Windows Media Player.
4. Click **Start Sync** to start copying files to your phone.

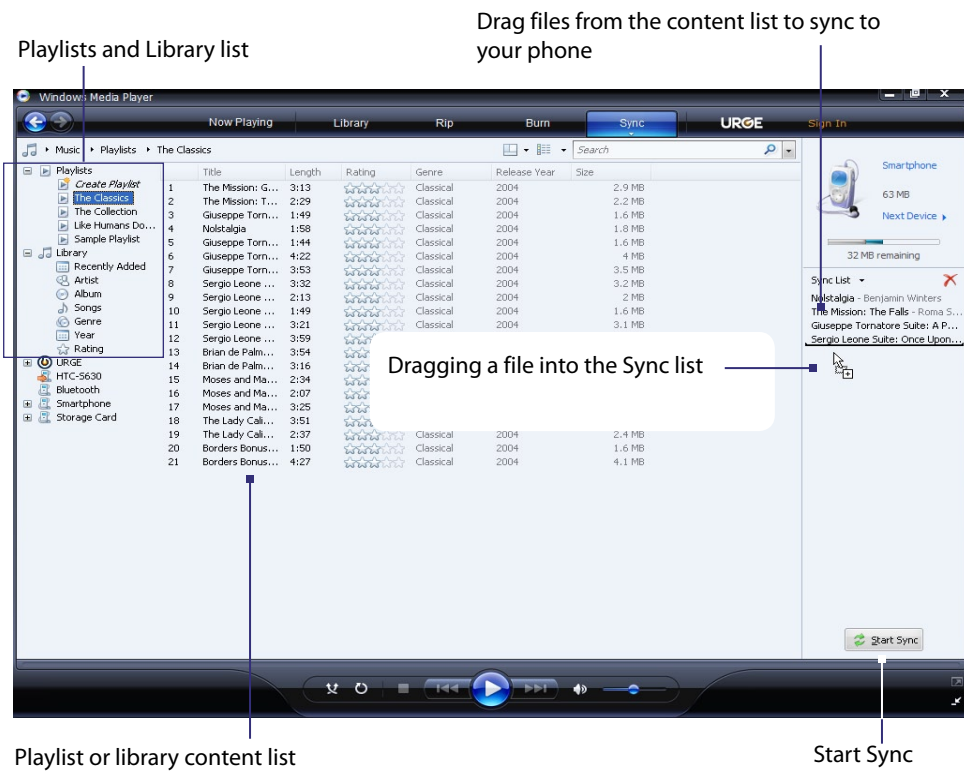

Notes

- Always use Windows Media Player 11 on your PC to synchronize (copy) files to your phone.
- Audio files copy faster if Windows Media Player is configured to automatically set the quality level for audio files copied to your phone. For more information, see the Windows Media Player Help.

Play media

To play media on your phone

Use the library to find and play songs, videos, and playlists that are stored on your phone or storage card.

1. If you are not on the Library screen, click **Menu > Library**.
2. If necessary, on the Library screen, click **Menu > Library**, and then select the library that you want to use.
3. In most cases, Windows Media Player Mobile automatically updates the library. However, you can manually update the library to ensure that it contains new files that you recently copied to your phone or storage card. Click **Menu > Update Library** to manually update the library list.
4. Select a category (for example, **My Music** or **My Playlists**), select the item that you want to play (such as a song, album, or artist name), and then click **Play**.

Note To play a file that is stored on your phone but is not in a library, on the Library screen, click **Menu > Open File**. Select the item that you want to play (such as a file or a folder), and click **Play**.

Troubleshooting

For more information, see the Troubleshooting Windows Media Player Mobile page at the Microsoft Web site (<http://www.microsoft.com/windows/windowsmedia/player/windowsmobile/troubleshooting.aspx>).

9.4 Java

The Java program allows you to download Java-based applications, such as games and tools that are specifically designed for mobile devices.

Install MIDlets

To install MIDlets from the Internet

1. On the Home screen, click **Start > Java**.
2. Click **Menu > Install > Browse** to open Internet Explorer Mobile.
3. Locate the MIDlet/MIDlet suite while connected to the Internet.
4. Select the MIDlet/MIDlet suite to download.
5. To start installing the MIDlet/MIDlet suite, click **Yes**.
6. Click **Done** to confirm the installation.

Notes

- You can cancel the installation at any time.
- Downloaded MIDlets will be automatically saved in the root folder.

To install MIDlets from a PC

You can install the MIDlets/MIDlet suites on your phone from a PC using the USB sync cable or Bluetooth. You can copy the MIDlet file(s) from a PC to any of the following temporary folders on your phone from where the Java program can install them.

- **Device memory:** ../Smartphone/My Documents/My MIDlets
- **Storage card:** ../Smartphone/Storage Card

Note If the My MIDlets folder does not exist in My Documents, you can create one with the same folder name. To create a folder, click **Menu > New Folder** on the Java screen. However, a folder named Storage Card automatically appears after you insert a storage card into your phone.

To install MIDlets from a local folder

1. On the Home screen, click **Start > Java**.
2. Click **Menu > Install > Local Files** to install the MIDlets currently saved in the My MIDlets folder.
3. Select the MIDlet/MIDlet suite from the list using the NAVIGATION CONTROL and click **Install**.
4. Click **Continue** or **Yes** to install.
By default, the MIDlet will be installed in the <root> folder.
Click **Menu > New Folder** to choose another folder.
6. Click **OK** to confirm the installation.

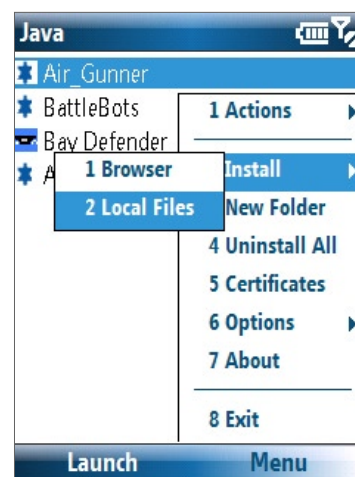

To run MIDlets on your phone

1. On the Home screen, click **Start > Java**.
2. Select a MIDlet from the list using the NAVIGATION CONTROL.
3. Click **Launch** or press ENTER to run the MIDlet.
To stop running a MIDlet(s), click **Yes** on the Terminate MIDlet screen, or press END ().

Manage MIDlets

You can update a MIDlet, run it from a different folder, run it on the background, change its display name, check its security, view its certificate, or uninstall it from your phone.

To change the display name of a MIDlet

1. On the Home screen, click **Start > Java**.
2. Select a MIDlet using the NAVIGATION CONTROL.
3. Click **Menu > Actions > Rename**.
4. Enter a new name for the MIDlet and click **Save**.

Note You cannot change the name of a MIDlet suite.

To uninstall a MIDlet

Before you uninstall a MIDlet/MIDlet suite, make sure that it is not running.

1. On the Java screen, select the MIDlet/MIDlet suite using the NAVIGATION CONTROL.
2. Click **Menu > Actions > Uninstall**.
3. Click **OK** to confirm.

Note Click **Menu > Uninstall All** to uninstall all individual MIDlets from your phone at one go. However, you cannot uninstall a single MIDlet from a MIDlet suite; you must uninstall the complete MIDlet suite.

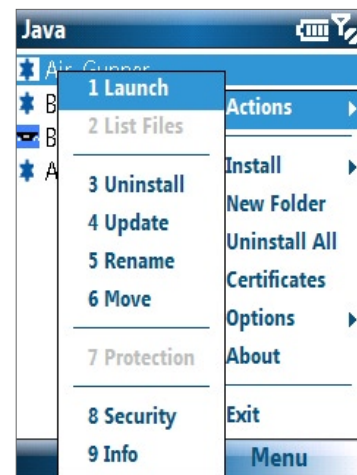

To run a MIDlet on the background

1. On the Java screen, select the MIDlet/MIDlet suite using the NAVIGATION CONTROL.
2. Click **Menu > Options > Background Running**.

To configure MIDlet security

You can adjust security settings for each MIDlet/MIDlet suite.

1. On the Java screen, select a MIDlet using the NAVIGATION CONTROL.
2. Click **Menu > Actions > Security**.
3. Configure the security options, such as **Local Connection**, **Location information access**, **Recording**, **Messaging**, and so on.

Please note that some features may not be available for all MIDlets/MIDlet suites. Following are the security options that you can set for a running MIDlet/MIDlet suite.

Security Option	Description
Local connection	Determines whether a MIDlet/MIDlet suite requires a special cable to function.
Location information access	Determines whether a running MIDlet/MIDlet can access location related information.
Recording	Enables a MIDlet/MIDlet suite to record sound or pictures.
Messaging	Determines whether a MIDlet/MIDlet suite can send and/or receive text (SMS) messages.
Local Connectivity	Enables a MIDlet/MIDlet suite to access services, such as Bluetooth.
Net Access	Determines whether a MIDlet/MIDlet suite can access the Internet.
Auto Start	Enables a MIDlet/MIDlet suite to run at specified times, or any time.
Read user data	Determines whether a running MIDlet/MIDlet can read data from your phone memory or from a storage card installed on your phone.
Write user data	Determines whether a running MIDlet/MIDlet can write data from your phone memory or from a storage card installed on your phone.

Chapter 10

Using Other Applications

10.1 Microsoft® Office Mobile

10.2 Microsoft® Office Word Mobile

10.3 Microsoft® Office Excel® Mobile

10.4 Microsoft® Office PowerPoint® Mobile

10.5 Adobe Reader LE

10.6 Speed Dial

10.7 Voice Speed Dial

10.1 Microsoft® Office Mobile

Microsoft® Office Mobile consists of three applications that let you view and edit Microsoft Office documents. These 3 applications are:

- **Microsoft® Office Word Mobile** lets you view and edit Microsoft Word documents and text files.
- **Microsoft® Office Excel® Mobile** lets you view and edit Microsoft Excel worksheets.
- **Microsoft® Office PowerPoint® Mobile** lets you view Microsoft PowerPoint slides.

To learn how to copy files, see “Managing and Backing Up Files” in Chapter 4.

10.2 Microsoft® Office Word Mobile

Microsoft® Office Word Mobile gives you editing and viewing capabilities for your Word documents and text files.

To open Word Mobile

- Click **Start > Office Mobile > Word Mobile**.

Notes

- Word Mobile does not fully support some features of the PC version of Microsoft Word. Some data and formatting may be lost when you save the document on your phone.
- Currently, Word Mobile also does not support viewing of Office 2007 Word documents. Added support for Office 2007 format may be available in late 2007. Visit Windows Mobile® Web site for details.

Open and view documents

To open a document

1. In Word Mobile, click **Menu** and choose the location where the **.doc**, **.rtf**, or **.txt** file is saved.
2. Locate the file you want to open and click **Select**.

Note You can only open one document at a time. You must close the opened document first before you can open another document.

To change the zoom ratio

- Click **View** and then on the menu, select the zoom ratio to use.
- Click **View > Wrap to Window** to adjust the text flow so that the text wraps based on the screen size. This way, you do not need to scroll right to read long paragraphs or sentences.

Note Text in tables cannot be wrapped.

To change scrolling preference

- Click **Menu > Scroll Up/Down** and then select **By Page** or **By Line**.

To find a word in a document

1. Click **Menu > Find**.
2. Type in the word you want to find in **Find What**. Select **Match case** and/or **Whole words only** if needed.
3. Click **Find**.

To close the document

- Click **Menu > Close File**.

Edit and send documents

In order to edit Word documents or text files, you need to switch to Edit mode. To switch to Edit mode, click **Menu > Edit Mode**.

To type words into the document

1. In the document, use the NAVIGATION CONTROL to position the cursor where you want to insert the text.

Tip Click **Menu > Format** to change the font format. You can use **Bold**, **Italic**, **Underline**, and **Highlight**.

2. Type in the text using the keypad or QWERTY keyboard.

Tip If you are using a formatting style and you want to revert to no formatting style, click **Menu > Format** and select the desired formatting style from the menu.

To save the document

1. Click **Menu > File > Save As**.
2. Type in the **Name** you want to use for the edited document and select the **Location** where you want to save the document.
3. Click **Save**.

To send the document through e-mail

1. Click **Menu > File > Send**.
2. In the Messaging screen, select the e-mail account you want to use to send the document and click **Select**.
3. In the e-mail, the file is automatically appended as an attachment.
4. Enter the recipient name and click **Send**.

10.3 Microsoft® Office Excel® Mobile

Microsoft® Office Excel® Mobile gives you editing and viewing capabilities for your Excel worksheets and workbooks.

To open Excel Mobile

- Click **Start > Office Mobile > Excel Mobile**.

Note Excel Mobile does not fully support some features of the PC version of Microsoft Excel. Some data and formatting may be lost when you save the workbook on your phone.

View worksheets

To open a workbook file

1. In Excel Mobile, click **Menu** and choose the location where the **.xls** file is saved.
2. Locate the workbook file you want to open and click **Select**.

Note You can only open one workbook at a time. You must close the opened workbook (.xls file) first before you can open another.

By default, the worksheet opens in Full Screen mode, to change the view mode, press the left SOFT KEY (to show the View menu) and click **View > Full Screen**.

To view the contents of a cell

There are times that the text in a cell cannot be fully displayed onscreen. To view the text in the cell in its entirety, select the cell and then click **View > Cell Text**.

To immediately view an area in the worksheet

1. In the worksheet, click **View > Overview**.
2. Use the NAVIGATION CONTROL to move the rectangular marquee to the area you want to view.
3. Press ENTER.

To use Freeze Pane

1. Select the cell that is after and below the row and column you want to freeze.
For example, if you want to freeze **column E** and **row 4**, you should select cell **F5**.
2. Click **View > Freeze Panes**. To unfreeze the panes, click **View > Unfreeze Panes**.

To change the zoom ratio

- Click **View > Zoom** and then select the zoom ratio to use.

To switch to another worksheet

If your Excel workbook file has multiple worksheets, you can go to a different worksheet by clicking **View > Sheet** and then selecting the worksheet you want to view.

Edit and send worksheets

In order to edit Excel worksheets, you need to switch to Edit mode. To switch to Edit mode, click **Menu > Edit Mode**.

To edit the cell text

1. Select the cell whose text you want to edit and click **Menu > Edit > Cell Text**.
2. Type in the text and click **Done**.

To delete the cell content

- Select the cell whose content you want to delete and click **Menu > Edit > Clear Cell**.

Tip You can select multiple cells by clicking **Menu > Select** and then choosing what to select in the worksheet.

To edit the cell range of a defined name

If your worksheet contains defined names created in Microsoft Excel on the PC, you can edit the cell range of the defined name.

1. Click **Menu > Edit > Define Name**.
2. In **Range Name**, select the name whose cell range you want to change.
3. In **Refers to**, type in the new cell range.
4. Click **Done**.

To delete cells

- Select the cell you want to delete and click **Menu > Edit > Delete Cells**.

Tip You can select multiple cells to delete by clicking **Menu > Select** and then choosing what to select in the worksheet.

To copy and paste cell contents

1. Select the cell(s) you want to copy and then click **Menu > Edit > Copy**.

Tip You can select multiple cells to delete by clicking **Menu > Select** and then choosing what to select in the worksheet.

2. Select the cell(s) where you want to copy the cell contents to and click **Menu > Edit > Paste**.

To insert a row or column

Select the cell where you want to insert a row or column and then click **Menu > Insert > Row** or **Column**. If you insert a row, the row will be inserted above the selected cell; if you insert a column, the column will be inserted at the left of the selected cell.

Tip You can also shift the contents of a row or column. To shift, select the cell you want to shift and click **Menu > Insert > Shift Right** or **Shift Down**.

To go to a cell

- Click **Menu > Tools > Go To** and then enter the **Cell reference or name**. Click **OK**.

Tip You can also sort and find text in the worksheet by clicking **Menu > Tools > Sort** or **Find**.

To undo and redo an action

- Click **Menu > Undo [Action]** or **Redo [Action]**.

To save the worksheet

1. Click **Menu > File > Save As**.
2. Type in the **Name** you want to use for the edited worksheet and select the **Location** where you want to save the worksheet.
3. Click **Save**.

To send the document through e-mail

1. Click **Menu > File > Send**.
2. In the Messaging screen, select the e-mail account you want to use to send the worksheet.
3. In the e-mail, the file is automatically appended as an attachment.
4. Enter the recipient name and click **Send**.

10.4 Microsoft® Office PowerPoint® Mobile

Microsoft® Office PowerPoint® Mobile gives viewing capabilities for your PowerPoint presentations.

To open PowerPoint Mobile

- Click **Start > Office Mobile > PowerPoint Mobile**.

Note Files created in Office 2007 PowerPoint is currently not supported yet. Added support for Office 2007 format may be available in late 2007. Visit Windows Mobile® Web site for details.

To open a file

1. In PowerPoint Mobile, click **Menu** and choose the location where the **.ppt** file is saved.
2. Locate the file you want to open and click **Select**.

To go through the slides of the presentation

Press NAVIGATION right to go forward in the presentation; press NAVIGATION left to go back to the previous action or slide of the presentation.

You can also go to a particular slide in your presentation by pressing the right SOFT KEY (to show **Menu**) and clicking **Menu > Go to Slide** then choosing the slide to go to.

To view a custom show

You can view custom shows that you created on Microsoft PowerPoint on your phone.

1. Press the right SOFT KEY to show **Menu**.
2. Click **Menu > Custom Show** and then select the custom show you want to view on the list.

To zoom in on a slide

1. Press the right SOFT KEY to show **Menu**.
2. Click **Menu > Zoom In**.

Note You cannot go the next or previous slide when you zoom in. You need to zoom out first to be able to go to the next or previous slide. To zoom out, click **Menu > Zoom Out**.

To set PowerPoint Mobile preferences

1. Press the right SOFT KEY to show **Menu**.
2. Click **Menu > Options**.
3. Set the **Orientation** and **Playback options** and click **Done**.

To show links in a slide

On your phone, you can show and activate hyperlinks in slides that you created on the PC version of Microsoft PowerPoint .

1. Press the right SOFT KEY to show **Menu**.
2. Click **Menu > Show Links**.
3. Press ENTER to activate the hyperlink. If there is more than one hyperlink on the slide, use NAVIGATION CONTROL to select the hyperlink you want to activate.

To end the presentation

- Press the right SOFT KEY (to show **End**) and click **End**.

10.5 Adobe Reader LE

Adobe Reader LE allows you to view Portable Document Format (PDF) files.

When you open a password-protected PDF file, you will be prompted to enter the password before the file can be opened.

To open a PDF file on your phone

1. Click **Start > Document Viewer > Adobe Reader LE**.
2. Click **Open**.
3. Browse to a folder and click the PDF file you want to open.

Note To open another PDF file, click **Open > Menu > Browse For File**. You can also open a PDF file from File Explorer by clicking it.

To navigate through a PDF file

You can do any of the following:

- Use the NAVIGATION CONTROLS to scroll through the pages.
- Click **Menu > Go To** and select an option to go to a specific page in the PDF file.

While reading a PDF file, click **Menu** to open a list of options that lets you zoom in, directly go to a bookmark, find text in the file, and more.

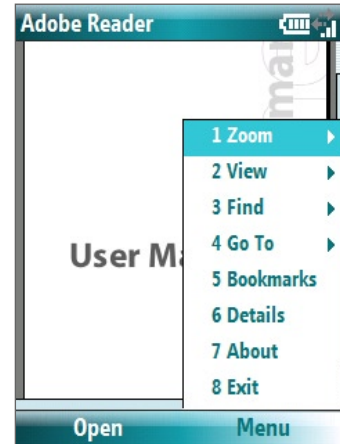

10.6 Speed Dial

You can create speed dial entries for frequently-called numbers or frequently-accessed items so you can dial a number or access an item by pressing a single key.

To create a speed dial entry for a contact

1. On the Home screen, click **Start > Contacts**.
2. Select a contact.
3. Press ENTER to view the contact details.
4. Select the desired phone number and click **Menu > Add to Speed Dial**.
5. Enter appropriate details in Name, Value, and Keyboard assignment.
6. Click **Done**. To quit at any time during this process, click **Menu > Cancel**.

To create a speed dial entry for an item

1. On the Home screen, click **Start** then choose (just highlight) the item you want.
2. Click **Menu > Add Speed Dial**.
3. Enter details in Name, Value, and Keyboard assignment.
4. Click **Done**. To quit at any time during this process, click **Menu > Cancel**.

Note The first speed dial location is generally reserved for your voice mail. Speed Dial uses the next available location by default. If you want to place a number in a location that is already used, the new number replaces the existing number.

To retrieve a voice mail message

- On the Home screen, press and hold 1 to access your voice mailbox, and follow the prompts to retrieve your messages.

To make a call or launch a program using Speed Dial

- If you have assigned a speed dial (for example, the second location) to a contact or a program in Speed Dial, you can simply press and hold the 2 key on the phone keypad to dial the contact's number or open the program.

To delete a speed dial entry

1. On the Home screen, click **Start > Speed Dial**.
2. Select the desired entry and click **Menu > Delete**.

10.7 Voice Speed Dial

You can record a voice tag for a phone number, e-mail address, or Web page address that is stored in Contacts. When you speak out the voice tag using Voice Speed Dial, your phone automatically dials the associated phone number, opens an e-mail message using the associated address, or goes to the associated Web page.

To create a voice tag for a phone number, e-mail address, or URL in Contacts

1. On the Home screen, click **Start > Contacts**.
2. Select the desired contact, and press ENTER to open the contact card.
3. Select the item to which you want to assign a voice tag.
4. Click **Menu > Add Voice Tag**.
5. After a "beep" sound, begin recording the voice tag (preferably one easy-to-recognize word).
6. When the voice tag is successfully trained, the phone will play back the voice tag. Click **OK**.
7. Enter appropriate details in Name, Value, and Keyboard assignment.
8. Click **Done** to save the new voice tag.
To quit at any time during this process, click **Menu > Cancel**.

To create a voice tag for a program

To create a voice tag for a program, for example, Calendar, do the following:

1. On the Home screen, click **Start > Calendar**. (Do not press ENTER when Calendar is selected.)
2. Click **Menu > Add Voice Tag**.
3. After the message/beep, say "Calendar."
4. When the voice tag is successfully trained, the phone will play back the voice tag. Click **OK**.
5. Enter appropriate details in Name, Value, and Keyboard assignment. Click **Done** to save the new voice tag. To quit at any time during this process, click **Menu > Cancel**.

To make a call or launch a program using the voice tag

1. Click **Start > Voice Speed Dial**.
2. After a "beep" sound, say the recorded voice tag that you have assigned to the phone number you want to call or the program you want to launch. The phone plays back the voice tag and then dials the number or launches the associated program.

Note You can also drag and hold the Volume Adjustment Slider down to launch Voice Speed Dial and record voice tags for numbers, e-mail addresses, URL in Contacts, and programs.

Tip If the phone does not recognize your voice tag, please try again and speak clearly and reduce the surrounding noise.

To edit, delete, and play voice tags

1. On the Home screen, click **Start > Speed Dial**.
2. Select the desired voice tag from the list.
3. Do any of the following:
 - To change the voice tag, click **Menu > Edit**, make changes, and click **Done**.
 - To delete the voice tag, click **Menu > Delete**.

To play back an existing voice tag at any time, click **Menu > Play Voice Tag**.

Appendix

A.1 Specifications

A.2 Regulatory Notices

A.3 Additional Safety Information

A.1 Specifications

System information

Processor/Chipset/Speed QUALCOMM™ MSM 7500, 400 MHz

Memory

- ROM-Nand Flash: 128 MB (Standard)
- RAM: 64 MB DDR

Figures are the total ROM and RAM memory available for use and storage. Since the memory is shared by the Operating System, applications, and data, the actual available memory is less than what is written.

Operating system Microsoft® Windows Mobile® 6 Standard

Display

Type 2.4" QVGA Transmissive LCD with white LED backlight

Resolution 240 x 320 dots resolution at 65K Colors

Orientation Portrait and Landscape both

CDMA/EVDO Dual-band module

Functionality CDMA2000

Mode Dual band: 800 and 1900 MHz

Antenna Internal

Camera module

Type 2.0 Megapixels CMOS with fixed lens

Resolution

- UXGA: 1200 x 1600
- SXGA: 960 x 1280
- VGA: 480 x 640
- QVGA: 240 x 320
- QQVGA: 120 x 160

Connection

I/O port HTC ExtUSB™: an 11-pin mini-USB and audio jack in one

(ExtUSB is a proprietary connection interface that is trademarked by HTC)

Bluetooth V 1.2 with A2DP support, Class 2 transmit power

Audio

Microphone/speaker Built-in microphone and speaker, Hands-free

Audio Format AAC/AMR/WMA/WAV/MP3 codec

Physical

Dimension 103.5 mm(L) x 51 mm(W) x 19.2 mm(T)

Weight 120g with battery pack

Controls and lights	
Buttons	<ul style="list-style-type: none"> • CAMERA • NAVIGATION CONTROL/ENTER • POWER (on and off)/Quick List • Left and Right SOFT KEYS • HOME/Comm Manager • BACK • TALK (start call/answer call) • END/Lock • Volume Adjustment Slider/Voice Speed Dial
Keyboard	QWERTY type, 36 keys + 2 SOFT KEYS
LED	<ul style="list-style-type: none"> • One multi-color (red/amber/green) LED for battery, connection, and network status. • One blue-color LED for Bluetooth connection status.
Expansion slot	
microSD slot	microSD memory card
Power supply	
Battery	Li-Ion 1050 mAh removable, rechargeable battery
Talk time	Up to 5 hours
Standby	Up to 200 hours
AC Adapter	<ul style="list-style-type: none"> • Voltage range/frequency: 100 ~ 240V AC, 50/60Hz • DC output: 5V and 1A

A.2 Regulatory Notices

Regulatory Agency Identifications

For regulatory identification purposes, your product is assigned a model number of **LIBR100**.
FCC ID: NM8LIBR100. IC:4115A-LIBR100.

To ensure continued reliable and safe operation of your device, use only the accessories listed below with your **LIBR100**.

The Battery Pack has been assigned a model number of **LIBR160**.

This product is intended for use with a certified Class 2 Limited Power Source, rated 5 Volts DC, maximum 1 Amp power supply unit.

Federal Communications Commission Notice

DECLARATION OF CONFORMITY

This wireless device, **LIBR100**, manufactured by High Tech Computer Corp., complies with part 15 of the FCC Rules. Operation is subject to the following two conditions: (1) This device may not cause harmful interference, and (2) this device must accept any interference received, including interference that may cause undesired operation. Responsible Party: High Tech Computer Corp.

This equipment has been tested and found to comply with the limits for a Class B digital device, pursuant to Part 15 of the FCC Rules. These limits are designed to provide reasonable protection against harmful interference in a residential installation. This equipment generates, uses, and can radiate radio frequency energy and, if not installed and used in accordance with the instructions, may cause harmful interference to radio communications. However, there is no guarantee that interference will not occur in a particular installation. If this equipment does cause harmful interference to radio or TV reception, which can be

determined by turning the equipment on and off, the user is encouraged to try to correct the interference by one or more of the following measures:

- Reorient or relocate the receiving antenna.
- Increase the separation between the equipment and receiver.
- Connect the equipment into an outlet on a circuit different from that to which the receiver is connected.
- Consult the dealer or an experienced radio or television technician for help. Modifications not expressly approved by the manufacturer could void the user's authority to operate the equipment.

FCC RF EXPOSURE INFORMATION

In August 1996, the Federal Communications Commission (FCC) of the United States with its action in Report and Order FCC 96-326 adopted an updated safety standard for human exposure to radio frequency electromagnetic energy emitted by FCC regulated transmitters. Those guidelines are consistent with the safety standard previously set by both U.S. and international standards bodies. The design of this device complies with the FCC guidelines and these international standards.

Modifications

The FCC requires the user to be notified that any changes or modifications made to the device that are not expressly approved by High Tech Computer Corporation may void the user's authority to operate the equipment.

FCC Hearing-Aid Compatibility (HAC) Regulations for Wireless Devices

On July 10, 2003, the U.S. Federal Communications Commission (FCC) Report and Order in WT Docket 01-309 modified the exception of wireless phones under the Hearing Aid Compatibility Act of 1988 (HAC Act) to require digital wireless phones be compatible with hearing-aids. The intent of the HAC Act is to ensure reasonable access to telecommunications services for persons with hearing disabilities.

While some wireless phones are used near some hearing devices (hearing aids and cochlear implants), users may detect a buzzing, humming, or whining noise. Some hearing devices are more immune than others to this interference noise, and phones also vary in the amount of interference they generate.

The wireless telephone industry has developed a rating system for wireless phones, to assist hearing device users find phones that may be compatible with their hearing devices. Not all phones have been rated. Phones that are rated have the rating on their box or a label located on the box.

The ratings are not guarantees. Results will vary depending on the user's hearing device and hearing loss. If your hearing device happens to be vulnerable to interference, you may not be able to use a rated phone successfully. Trying out the phone with your hearing device is the best way to evaluate it for your personal needs.

M-Ratings: Phones rated M3 or M4 meet FCC requirements and are likely to generate less interference to hearing devices than phones that are not labeled. M4 is the better/higher of the two ratings. LIBR100 is rated M3.

Hearing devices may also be rated. Your hearing device manufacturer or hearing health professional may help you find this rating. Higher ratings mean that the hearing device is relatively immune to interference noise. The hearing aid and wireless phone rating values are then added together. A sum of 5 is considered acceptable for normal use. A sum of 6 is considered for better use. A sum of 8 is considered for best use.

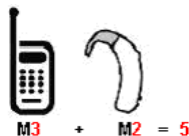

In the above example, if a hearing aid meets the M2 level rating and the wireless phone meets the M3 level rating, the sum of the two values equal M5. This should provide the hearing aid user with "normal usage" while using their hearing aid with the particular wireless phone. "Normal usage" in this context is defined as a signal quality that is acceptable for normal operation.

The M mark is intended to be synonymous with the U mark. The T mark is intended to be synonymous with the UT mark. The M and T marks are recommended by the Alliance for Telecommunications Industries Solutions (ATIS). The U and UT marks are referenced in Section 20.19 of the FCC Rules. The HAC rating and measurement procedure are described in the American National Standards Institute (ANSI) C63.19 standard.

For information about hearing aids and digital wireless phones

FCC Hearing Aid Compatibility and Volume Control:

<http://www.fcc.gov/cgb/dro/hearing.html>

Gallaudet University, RERC:

<http://tap.gallaudet.edu/DigWireless.KS/DigWireless.htm>

SAR Information

- 1.490 W/kg @1g (Head)
- 1.380 W/kg @1g (Body)

THIS MODEL DEVICE MEETS THE GOVERNMENT'S REQUIREMENTS FOR EXPOSURE TO RADIO WAVES.

Your wireless mobile CDMA phone is a radio transmitter and receiver. It is designed and manufactured not to exceed the emission limits for exposure to radio frequency (RF) energy set by the Federal Communications Commission of the U.S. Government. These limits are part of comprehensive guidelines and establish permitted levels of RF energy for the general population. The guidelines are based on the safety standards previously set by both U.S. and international standards bodies:

- American National Standards Institute (ANSI) IEEE. C95.1-1992.
- National Council on Radiation Protection and Measurement (NCRP). Report 86. 1986.
- International Commission on Non-Ionizing Radiation Protection (ICNIRP) 1996.
- Ministry of Health (Canada), Safety Code 6. The standards include a substantial safety margin designed to assure the safety of all persons, regardless of age and health.

The exposure standard for wireless mobile CDMA phone employs a unit of measurement known as the **Specific Absorption Rate**, or **SAR**. The SAR limit set by the FCC is 1.6W/kg*. Tests for SAR are conducted with the device transmitting at its highest certified power level in all tested frequency bands. Although the SAR is determined at the highest certified power level, the actual SAR level of the device while operating can be well below the maximum value. This is because the device is designed to operate at multiple power levels so as to use only the power required to reach the network. In general, the closer you are to a wireless base station antenna, the lower the power output. Before a device model is available for sale to the public, it must be tested and certified to the FCC that it does not exceed the limit established by the government adopted requirement for safe exposure. The tests are performed in positions and locations (e.g., at the ear and worn on the body) as required by the FCC for each model.

The highest SAR value for this model device when tested for use at the ear is 1.490 W/kg @ 1g and when worn on the body, as described in this user guide, is 1.380 W/kg @ 1g. (Body-worn measurements differ among device models, depending upon available accessories and FCC requirements). While there may be differences between the SAR levels of various devices and at various positions, they all meet the government requirement for safe exposure.

The FCC has granted an Equipment Authorization for this model device with all reported SAR levels evaluated as in compliance with the FCC RF exposure guidelines. SAR information on this model device is on file with the FCC and can be found under the Display Grant section of <https://gulfoss2.fcc.gov/prod/oet/cf/eas/reports/GenericSearch.cfm> after searching on FCC ID: NM8LIBR100.

Additional information on Specific Absorption Rates (SAR) can be found on the Cellular Telecommunications & Internet Association (CTIA) web-site as <http://www.phonefacts.net>.

* In the United States and Canada, the SAR limit for mobile CDMA phone used by the public is 1.6 Watts/kg (W/kg) averaged over one gram of tissue. The standard incorporates a substantial margin of safety to give additional protection for the public and to account for any variations in measurements.

Normal condition only to ensure the radiative performance and safety of the interference. As with other mobile radio transmitting equipment, users are advised that for satisfactory operation of the equipment and for the safety of personnel, it is recommended that no part of the human body be allowed to come too close to the antenna during operation of the equipment.

FCC Enhanced 911 (E911) Rules

BACKGROUND

The Federal Communications Commission (FCC) requires wireless carriers to transmit specific latitude and longitude location (Automatic Location Identification = ALI) information as well as "911" calls to Public Safety Answering Points (PSAPs) to identify the location of the caller in case of emergency.

Generally, the rules require that carriers identify an E911 caller's location within 50 meters of the actual location for 67 percent of calls and within 150 meters of the actual location for 95 percent of calls.

LIBR100's ALI CAPABILITY

The **LIBR100** is an ALI-capable smartphone equipped with a GPS (Global Positioning System) receiver supporting a satellite-based GPS ALI-capable network to comply with the FCC's ALI requirements.

The network compliance with the above FCC requirements is dependent on: (a) the use of digital technology by the wireless network; (b) GPS satellite signals being able to reach the handset (such transmissions do not always work indoors, for example) ; and (c) handset signals reaching wireless "base stations" (atmospheric and environmental conditions may cause variations in handset receiving signal strength).

Also the transmission of the ALI information is subject, in part, to system constraints within the wireless network to which the E911 signal is transmitted and over which UT Starcom has no control.

Finally, customers are advised that the **LIBR100's** ALI capability is to be used for E911 purposes only.

For more information about placing emergency calls, see Chapter 2.

Compliance with Other FCC Regulations

OPERATING PROCEDURES

Never violate any of the following Rules and Regulations of the FCC when using your device. Such violations are punishable by fine, imprisonment or both.

- Never use obscene, indecent, or profane language.
- Never use your device to send false distress calls.
- Never wiretap or otherwise intercept a phone call, unless you have first obtained the consent of the parties participating in the call.
- Never make any anonymous calls to annoy, harass, or molest other people.
- Never charge another account without authorization, to avoid payment for service.
- Never willfully or maliciously interfere with any other radio communications.
- Never refuse to yield the line when informed that it is needed for an Emergency Call. Also, never take over a line by stating falsely that it is needed for an emergency.

IC Statement

Operation is subject to the following two conditions:

1. This device may not cause interference; and
2. This device must accept any interference, including interference that may cause undesired operation of the device.

Important Note

IC Radiation Statement:

This equipment complies with IC radiation exposure limits set forth for an uncontrolled environment. End users must follow the specific operating instructions for satisfying RF exposure compliance.

This Class B digital apparatus complies with Canadian ICES-003.

WEEE Notice

The Directive on Waste Electrical and Electronic Equipment (WEEE), which entered into force as European law on 13th February 2003, resulted in a major change in the treatment of electrical equipment at end-of-life.

The purpose of this Directive is, as a first priority, the prevention of WEEE, and in addition, to promote the reuse, recycling and other forms of recovery of such wastes so as to reduce disposal.



The WEEE logo (shown at the left) on the product or on its box indicates that this product must not be disposed of or dumped with your other household waste. You are liable to dispose of all your electronic or electrical waste equipment by relocating over to the specified collection point for recycling of such hazardous waste. Isolated collection and proper recovery of your electronic and electrical waste equipment at the time of disposal will allow us to help conserving natural resources. Moreover, proper recycling of the electronic and electrical waste equipment will ensure safety of human health and environment. For more information about electronic and electrical waste equipment disposal, recovery, and collection points, please contact your local city centre, household waste disposal service, shop from where you purchased the equipment, or manufacturer of the equipment.

RoHS Compliance

This product is in compliance with Directive 2002/95/EC of the European Parliament and of the Council of 27 January 2003, on the restriction of the use of certain hazardous substances in electrical and electronic equipment (RoHS) and its amendments.

A.3 Additional Safety Information

This section provides more safety information in addition to the information at the beginning of the user manual.

When Driving

Do Not Use The PC Functions Of Your Device While Driving Or Walking

Never use the personal computer functions of your device while driving an automobile or any other moving vehicle. Always pull out of traffic and come to a stop in a legally permissible and safe location before using your smartphone. Failure to do so could result in serious bodily injury in a traffic accident.

When driving:

- Always secure your device in its leather pouch.
- Never place your device on the passenger seat or anyplace else in the car where it can become a projectile during a collision or stop.
- An air bag inflates with great force. DO NOT place objects, including either installed or portable wireless equipment, in the area over the air bag or in the air bag deployment area. If in-vehicle wireless equipment is improperly installed and the air bag inflates, serious injury could result.

Never store or transport flammable liquids, gases or explosive materials in the same compartment of your automobile as the device or any of its accessories, as possible sparking in the device could cause ignition or explosion.

Never use your device while walking. Usage while walking could result in bodily injury caused by inattention to automobile traffic or other pedestrian hazards.

Using The Phone Function Of Your Device While Driving Is Extremely Dangerous

Talking on or using your smartphone while driving is extremely dangerous and is illegal in some states. Remember, safety comes first. Check the laws and regulations on the use of phones in the areas where you drive. Always obey them.

If you must use the phone function while driving, please:

- Give full attention to driving. Driving safely is your first responsibility.
- Use hands-free operation and/or one-touch, speed dialing, and auto answer modes.
- Pull off the road and park before making or answering a call.

WARNING: Failure to follow these instructions could lead to serious personal injury and possible property damage.

When Using Your Device Near Other Electronic Devices

Your wireless smartphone is a low power radio transmitter and receiver. When it is ON, it receives and also sends out radio frequency (RF) signals.

Most modern electronic equipment is shielded from RF energy. However, certain electronic equipment may not be shielded against the RF signals from your wireless smartphone; therefore, use of your smartphone must be restricted in certain situations.

In addition, the computer portion of your device produces low levels of RF energy due to the generation of digital timing pulses by its clock oscillator circuits. Your device has been equipped with internal shielding to minimize stray emissions of RF energy. However, use of the computer functions of your device must be restricted in certain situations.

PACEMAKERS

The Health Industry Manufacturers Association recommends that a minimum separation of six (6") inches be maintained between a handheld wireless phone and a pacemaker to avoid potential interference with the pacemaker. These recommendations are consistent with the independent research by and recommendations of Wireless Technology Research.

Never come closer than six (6) inches to a person with a heart pacemaker implant when using your device. Doing so could result in interference with the function of the pacemaker.

Persons with pacemakers:

- Should ALWAYS keep the phone more than six inches from their pacemaker when the phone is turned ON.
- Should not carry the phone in a breast pocket.
- Should use the ear opposite the pacemaker to minimize the potential for interference.
 - Note:** This is not necessary if the smartphone is not held to the ear.
- If you have any reason to suspect that interference is taking place, turn the phone OFF immediately.

HEARING AIDS

Some digital wireless phones may interfere with some hearing aids. In the event of such interference, you may want to consult your service provider, or call the customer service line to discuss alternatives.

For more regulatory information about hearing devices, see "FCC Hearing-Aid Compatibility (HAC) Regulations for Wireless Devices".

OTHER MEDICAL DEVICES

If you use any other personal medical device, consult the manufacturer of your device to determine if it is adequately shielded from external RF energy. Your physician may be able to assist you in obtaining this information.

HOSPITALS AND HEALTH CARE FACILITIES

Turn your device OFF in health care facilities when any regulations posted in these areas instruct you to do so. Hospitals or health care facilities may be using equipment that could be sensitive to external RF energy.

ELECTRONIC DEVICES IN VEHICLES

RF signals may affect improperly installed or inadequately shielded electronic systems in motor vehicles. Check with the manufacturer or its representative regarding your vehicle. You should also consult the manufacturer of any equipment that has been added to your vehicle.

POSTED FACILITIES

Turn your device OFF where posted notices so require.

Turn Off Your Device Before Flying

AIRCRAFT

FCC regulations prohibit using the transmitting and phone functions of your device while in the air. In addition, most airline regulations prohibit the on-board use of portable PCs (and all other portable electronic devices that could potentially emit stray RF energy), particularly during take-offs and landings, to prevent any possible interference with the reception of signals by airborne electronic navigational devices.

Turn your device OFF before boarding an aircraft. Always request and obtain prior consent and approval of an authorized airline representative before using your device aboard an aircraft. Always follow the instructions of the airline representative whenever using your device aboard an aircraft, to prevent any possible interference with airborne electronic equipment.

Turn Off Your Device in Dangerous Areas

BLASTING AREAS

To avoid interfering with blasting operations, turn your device OFF when in a "blasting area" or in areas posted "Turn off two-way radio". Obey all signs and instructions.

POTENTIALLY EXPLOSIVE ATMOSPHERES

Turn your device OFF when in any area with a potentially explosive atmosphere and obey all signs and instructions. Sparks in such areas could cause an explosion or fire resulting in bodily injury or even death.

Areas with a potentially explosive atmosphere are often, but not always, clearly marked. They include fueling areas such as gas stations; below deck on boats; fuel or chemical transfer or storage facilities; vehicles using liquefied petroleum gas (such as propane or butane); areas where the air contains chemicals or articles, such as grain, dust, or metal powders; and any other area where you would normally be advised to turn off your vehicle's engine.

General Safety

Your smartphone is a high quality piece of equipment. Before operating, read all instructions and cautionary markings on the product, battery and adapter/charger.

Failure to follow the directions below could result in serious bodily injury and/or property damage due to battery liquid leakage, fire or rupture.

DO NOT use or store this equipment in a place where it will be exposed to high temperatures, such as near an open flame or heat-emitting equipment.

DO NOT drop your device or subject it to severe shock. When not using, lay down the unit to avoid possible damage due to instability.

DO NOT expose this equipment to rain or spilled beverages.

DO NOT use unauthorized accessories.

DO NOT disassemble the device or its accessories. If service or repair is required, return unit to an authorized UT Starcom cellular service center. If the unit is disassembled, the risk of electric shock or fire may result.

Never allow metallic objects, such as staples and paper clips, to get into the inside of your device.

Never touch the liquid that might leak from a broken liquid crystal display. Contact with this liquid could cause a skin rash. If the crystal display liquid should come into contact with the skin or clothing, wash it immediately with clean water.

In the event that the device emits an unusual odor or sound or generates smoke, immediately disconnect the AC adapter from the power outlet, then detach the battery.

Antenna Safety

Use only the supplied or an approved replacement antenna. Unauthorized antennas, modifications, or attachments could impair call quality, damage your device, or result in violation of FCC regulations. Please contact your local dealer for replacement antenna.

Do not use the device with a damaged antenna. If a damaged antenna comes into contact with the skin, a minor burn may result. Please contact your local dealer for replacement antenna.

Battery Safety

Your device uses a removable and rechargeable lithium ion battery. Please contact customer service for assistance should you need a replacement battery.

DOs

- Only use the battery and charger approved by the manufacturer.
- Only use the battery for its original purpose.
- Try to keep batteries in a temperature between 41°F (5°C) and 95°F (35°C).
- If the battery is stored in temperatures above or below the recommended range, give it time to warm up or cool down before using.
- Completely drain the battery before recharging. It may take one to four days to completely drain.
- Store the discharged battery in a cool, dark, and dry place.
- Purchase a new battery when its operating time gradually decreases after fully charging.
- Properly dispose of the battery according to local regulations.

DON'Ts

- Don't attempt to disassemble the battery – it is a sealed unit with no serviceable parts.
- Don't expose the battery terminals to any other metal object (e.g., by carrying it in your pocket or purse with other metallic objects such as coins, clips and pens). This can short circuit and critically damage the battery.
- Don't leave the battery in hot or cold temps. Otherwise, it could significantly reduce the capacity and lifetime of the battery.
- Don't dispose of the battery into a fire.

Lithium ion batteries are recyclable. When you replace the removable battery, please request the repair center to recycle the battery in accordance with RBRC standards. When disposing of the battery by yourself, please call RBRC at (800) 822-8837 for proper disposal tips.

Never touch any fluid that might leak from the built-in battery. Such liquid when in contact with the eyes or skin, could cause injury to the skin or eyes. Should the liquid come into contact with the eyes, irrigate the eyes thoroughly with clean water and immediately seek medical attention. In the event the liquid comes into contact with the skin or clothing, wash it away immediately with clean water.

Adapter/Charger

Use the Correct External Power Source

A product should be operated only from the type of power source indicated on the electrical ratings label. If you are not sure of the type of power source required, consult your authorized service provider or local power company. For a product that operates from battery power or other sources, refer to the operating instructions that are included with the product.

The AC Adapter/Charger designed by UT Starcom for this unit requires the use of a standard 120 V AC power source for device operation.

Never attempt to disassemble or repair an AC adapter/charger. Never use an AC adapter/charger if it has a damaged or worn power cord or plug. Always contact a UT Starcom authorized service center, if repair or replacement is required.

Never alter the AC cord or plug on an AC adapter/charger. If the plug will not fit into the available outlet, have a proper outlet installed by a qualified electrician.

Never allow any liquids or water to spill on an AC adapter/charger when it is connected to an AC power source.

Always use the authorized UT Starcom AC adapter/charger to avoid any risk of bodily injury or damage to your cellular phone or battery.

Never attempt to connect or disconnect the AC adapter/charger with wet hands. Always unplug the AC adapter/charger from the power source before attempting any cleaning. Always use a soft cloth dampened with water to clean the equipment, after it has been unplugged.

Handling the cord on this product or cords associated with accessories sold with this product, will expose you to lead, a chemical known to the State of California to cause birth defects or other reproductive harm. Wash hands after handling.

Always disconnect the travel charger or desktop charger from the power source when it is not in use.

Index

Symbols

1xEVDO 70
1xRTT 70

A

Accessibility settings

- confirmation time out 38
- in-call alert volume 38
- multipress time out 38
- system font size 38

ActiveSync

- overview 16
- synchronize 31, 60

Add and remove programs 40

Add attachment to message 55

Adobe Reader 16, 99

Alarm 38

Alarm settings 37

Alerts 37

Answer/end call 26

Attachments 55

B

Backlight time out 38

Back up files 41

Battery

- battery information 21
- battery management 38
- check battery power 21
- low battery 21

Beam via Bluetooth 77

Bluetooth

- beaming 77
- hands-free headset 76
- modes 75
- overview 75
- partnerships 75
- stereo headset 76
- synchronize 32
- visible 75

Browsing the Web 72

C

Calculator 16

Calendar 16, 47

Call History 16

Camera

- camera button 82
- icons and indicators 83
- overview 16
- zoom 84

Camera settings 84

Capture formats 82

Capture modes 82

Clear Storage 16, 43

Close running programs 40

Comm Manager 16, 70

Company Directory 64

Compose e-mail message 54

Confirmation time out 38

Connect PC to Internet using Lobster 700TV as modem
73

Connect phone to Internet 71

Connect phone to private network 71

Contacts

- beam contact information 47
- call a contact 46
- create a new contact 46
- find a contact 46
- overview 16
- send contact information via a text message 47
- use 46
- view & edit a contact 46

Contacts picture (capture mode) 82

Copy

- files between phone and PC 41
- media files from PC to phone 77
- pictures and videos 85
- sound file to phone 37

Currency setting 36

Customize Home screen 36

D

Date setting 36

Device lock 42

Dial-up connection 70

Digitally sign messages 65, 66

Digital Rights Management (DRM) 87

Digital signature

- sign 65
- verify 65

Direct Push 60

Display time out 38

E

E-mail

- messages 54
- Outlook 53
- POP3/IMAP4 53
- security 65

Emergency call 27

Encrypt messages 65, 66

Enter text and numbers 18

Error reporting 39

Event notification 37

Excel Mobile 95

- overview 16

Exchange Server

- schedule synchronization 60
- start synchronization 60

Exclude e-mail address when replying to all 57

F

Fetch Mail 61

File Explorer 16, 41

Filter e-mail 55

Find Contacts 64
 Flag your messages 62
 Flight mode 70
 Font size (display) 38
 Forward message 55

G

Games 16

H

Home screen
 - change background 36
 - customize 36
 - overview 15, 36

I

In-call alert volume 38
 Insert Battery 15
 Insert pause in dialing sequence 27
 Install ActiveSync 31
 Install Micro SD Card 15
 Install MIDlets
 - from Internet 89
 - from PC 89
 - locally 89
 International call 27
 Internet 70
 Internet Explorer Mobile 16, 72

J

Java
 - overview 16
 - use 89

K

Keyboard
 - lock 42
 - sound 37

L

Language/locale setting 36
 LED indicator lights 14
 Licensed and protected media 87
 Lock
 - keyboard 42
 - phone 42

M

Make call
 - from Call History 25
 - from Contacts 25
 - from Home Screen 24
 - from Speed Dial 25
 Managing meeting requests 63
 Memory 40
 Messaging 16, 52
 Messenger 16

Microsoft ActiveSync 31
 Microsoft Windows Mobile Device Center 30
 Multipress mode 18
 Mute call 26

N

NAVIGATION CONTROL 13
 Number format 36
 Numeric mode 19

O

Office Mobile 94
 - Excel Mobile 95
 - PowerPoint Mobile 98
 - Word Mobile 94
 Operating system version 39
 Optimize power performance 21
 Out-of-office 63
 Outlook e-mail 53
 Owner information 38

P

Panorama (capture mode) 82
 Parts and accessories 12
 Pause in dialing sequence 27
 PDF 99
 Personal information 38
 Phone program 23
 Phone specification 39
 Photo (capture mode) 82
 Pictures & Videos 17, 85
 Picture theme (capture mode) 82
 Play media 88
 PowerPoint Mobile 98
 - overview 17
 Power management 38
 Profile 37
 Programs
 - ActiveSync 16
 - Adobe Reader 16
 - Calculator 16
 - Calendar 16, 47
 - Call History 16
 - Camera 16, 82
 - Clear Storage 16, 43
 - Comm Manager 16
 - Contacts 16, 46
 - Excel Mobile 16
 - File Explorer 41
 - Games 16
 - Internet Explorer 16, 72
 - Java 16
 - Messaging 16, 52
 - Messenger 16
 - Phone 23
 - Pictures & Videos 17, 85
 - PowerPoint Mobile 17
 - Speed Dial 17, 99
 - Tasks 17, 49

- Task Manager 17, 40
- Video Recorder 17, 82
- Voice Notes 17, 49
- Voice Speed Dial 17
- Windows Live 17
- Windows Media Player Mobile 17, 86
- Wireless Modem 17
- Word Mobile 17

Program icons 16

Q

Quick List 18

QWERTY keyboard 18, 20

R

Receive

- call 26

Regional settings 36

Reply message 55, 57

Reset phone 43

Restart phone 43

Review screen 84

Ring tone 24, 50

Run MIDlets 90

S

Search for e-mails on the Exchange Server 62

Secure/Multipurpose Internet Mail Extension (S/MIME) 65

Send

- email/SMS message 54

Send and download e-mails 56

Send appointments 48

Send messages 54

Settings 17

Setting up e-mail accounts 53

Set up ActiveSync on PC 31

Set up Home screen 36

SharePoint documents 63

Share contact information 47

Sounds 37

Speakerphone 26

Speed Dial 17, 25, 99

Sports (capture mode) 82

Start menu 17

Status indicators 22

Stop programs 40

Synchronize

- ActiveSync 31
- change information types 31
- music and video 33
- schedule synchronization with Exchange Server 60
- via Bluetooth 32
- Windows Media Player 33

System font size 38

T

T9 mode 19

Tasks 17, 49

Task Manager 17, 40

Time setting 36

U

Unlock screen clock 37

V

Verify digital signature 65

Video (capture mode) 82

Video Recorder 17, 82

Viewing media files 85

View your appointments 47

Visible (Bluetooth) 75

Voice Notes 17, 49

Voice Speed Dial 17

Voice tag

- create voice tag for phone number, e-mail address, or URL in Contacts 100
- create voice tag for program 100
- edit, delete, and play voice tags 101

W

Web browser 72

Windows Live 17

Windows Live Mobile 78

Windows Media Player

- file formats 86
- menus 86
- overview 17
- troubleshooting 88

Windows Mobile Device Center 30

Windows Mobile software version 39

Windows Mobile Update 39

Wireless Modem

- USB modem 73
- use 73

Word Mobile 94

- Overview 17

Z

Zoom 84

Free Manuals Download Website

<http://myh66.com>

<http://usermanuals.us>

<http://www.somanuals.com>

<http://www.4manuals.cc>

<http://www.manual-lib.com>

<http://www.404manual.com>

<http://www.luxmanual.com>

<http://aubethermostatmanual.com>

Golf course search by state

<http://golfingnear.com>

Email search by domain

<http://emailbydomain.com>

Auto manuals search

<http://auto.somanuals.com>

TV manuals search

<http://tv.somanuals.com>