



User Guide

HTC Touch Pro2

www.sprint.com

*©2010 Sprint. Sprint and the logo are trademarks of Sprint.
Other marks are the property of their respective owners.*

Consejo

Para encontrar esta guía para usuarios en español, por favor visita a www.sprint.com y haz clic en Support > Phones & Devices.

To find this user guide in Spanish, please visit www.sprint.com and click Support > Phones & Devices.

Table of Contents

Tip Looking for something? If you don't see it in the headings listed here, try the Index on page 227.

Introduction	<i>i</i>
Section 1: Getting Started	1
1A. Setting Up Service	2
Setting Up Your Device	2
Activating Your Device	3
Setting Up Your Voicemail	4
Sprint Account Passwords	4
Getting Help	5
Section 2: Your Device	7
2A. Device Basics	8
Your Device	9
Inside the Box	11
Turning Your Device On and Off	12
Using Your Device's Battery and Charger	12
Navigating on Your Device	14
Using the Zoom Bar	15
The Home Screen	16
Using the Lock Screen	20
Adjusting the Volume	21
Using the Getting Started Application	22
Connecting Your Device to a Computer	23
2B. Entering Text	24
The Sliding QWERTY Keyboard vs. Onscreen Keyboards	24
Using the Sliding QWERTY Keyboard	26
Using the Full QWERTY Layout	27
Using the Phone Keypad	29
Using Predictive Mode	30
Using Numeric and Symbol Mode	31
Text Input Settings	31

2C. Using the Home Screen	32
The Home Screen	32
Home	35
People	38
Mail	46
Messages	47
Calendar	48
Internet	50
Photos and Videos	51
Sprint Music	52
Sprint Navigation	54
Sprint TV	55
Weather	56
Stock	57
Twitter	58
Settings	62
2D. Using Phone Features	63
Displaying Your Phone Number	63
Making Calls from the Phone Screen	63
Making Calls from the Home Screen	66
Answering and Ending Calls	66
In-Call Options	67
Checking Missed Calls	69
Call History	69
Speed Dial	70
Straight Talk	70
Turning the Phone On and Off	73
Phone Services	74
2E. Synchronizing Information With Your Computer	75
About Synchronization	75
Ways to Synchronize	75
Setting Up Windows Mobile Device Center on Windows 7 and Windows Vista	76
Setting Up ActiveSync on Windows XP	77
Synchronizing with Your Computer	78
Synchronizing via Bluetooth	79
Synchronizing Music and Video	79
Synchronizing with Microsoft My Phone	80

2F. <i>Contacts, Calendar, and Tools</i>	82
Contacts	82
Calendar	84
Notes	86
Tasks	87
Calculator	87
Comm Manager	89
Microsoft Office Mobile	90
JETCET Presentation	91
Automatic Speech Recognition (ASR)	93
Voice Recorder	94
WorldCard Mobile (Business Card Scanner)	95
Windows Marketplace	95
JETCET PRINT (Wireless Printing Application)	96
2G. <i>microSD Card</i>	97
Using a microSD Card on Your Device	97
Managing the microSD Card	98
Using Your Device as a USB Drive	99
2H. <i>Bluetooth</i>	100
Using Bluetooth	100
2I. <i>Experiencing Multimedia</i>	105
Taking Photos and Videos	105
Viewing Photos and Videos	112
Using Windows Media Player Mobile	116
Using Audio Booster	118
Using MP3 Trimmer	119
2J. <i>Managing Your Device</i>	121
Copying and Managing Files	121
Settings on Your Device	122
Basic Settings	125
Using Task Manager	128
Connecting to an External Display	129
Protecting Your Device with a Password	130
Managing Memory	130
Adding and Removing Programs	130
Resetting Your Device	131

Section 3: Sprint Service	133
3A. Sprint Service Features: The Basics	134
Voicemail	134
Text Messaging (SMS)	137
Video and Picture Messaging (MMS)	140
Using Caller ID	141
Call Waiting	142
Call Forwarding	142
Making a Three-Way Call	142
Roaming	143
3B. Web and Data Services	146
Ways of Connecting to the Internet	146
Getting Started With Data Services	148
Navigating the Web	151
Using Windows Live	155
The Windows Live Interface	156
Google Mobile App	158
Using RSS Hub	160
Accessing Sprint Instant Messaging	163
Email Messaging	164
Working With Company Email and Meeting Appointments	168
Internet Sharing	173
Using Remote Desktop Mobile	175
3C. Entertainment: TV and Music	176
TV	176
Music – Sprint Music Store	178
Streaming Media	180
YouTube	181
NASCAR Sprint Cup Mobile	183
NFL Mobile Live	186
3D. GPS Navigation	188
Guidelines and Preparation for Using GPS	188
Downloading Location Data via QuickGPS	189
Using Sprint Navigation	189
Bing	192
3E. Sprint Worldwide Wireless Service	193
Your SIM Card	193
Using Your Device in GSM Mode	195
Using Your SIM Card's PhoneBook	199

Setting GSM Services Options	202
Contacting Sprint	203
Services	204
Selecting a Network	205
Section 4: Safety, Regulatory, and Warranty Information.....	207
4A. Important Safety Information	208
Important Health Information and Safety Precautions	208
General Precautions	211
Additional Safety Information	213
4B. Regulatory Notices	218
Regulatory Agency Identifications	218
Federal Communication Commission Interference Statement	218
FCC Hearing-Aid Compatibility (HAC) Regulations for Wireless Devices	219
SAR Information	220
Body-worn Operation	221
Telecommunications & Internet Association (TIA) Safety Information	221
WEEE Notice	222
RoHS Compliance	222
4C. Warranty, Disclaimers and Other Notices	223
Manufacturer's Warranty	223
Privacy Restrictions	225
Weather Disclaimer	225
Warranty Disclaimer	225
Limitation of Damages	225
4D. Copyright, Trademark, and Proprietary Notices	226
Index	227

Introduction

This *User Guide* introduces you to Sprint® service and all the features of your new device. It's divided into four sections:

- ◆ *Section 1: Getting Started*
- ◆ *Section 2: Your Device*
- ◆ *Section 3: Sprint Service*
- ◆ *Section 4: Safety, Regulatory, and Warranty Information*

Throughout this guide, you'll find tips that highlight special shortcuts and timely reminders to help you make the most of your new device and service. The Table of Contents and Index will also help you quickly locate specific information.

You'll get the most out of your device if you read each section. However, if you'd like to get right to a specific feature, simply locate that section in the Table of Contents and go directly to that page. Follow the instructions in that section, and you'll be ready to use your device in no time.

User Guide Note

Because of updates in the device's software, this user guide may not be the most current version for your device. Visit www.sprint.com and log on to My Sprint Wireless to access the most recent version of the user guide.

WARNING

Please refer to Important Safety Information on page 208 to learn about information that will help you safely use your device. Failure to read and follow the Important Safety Information in this user guide may result in serious bodily injury, death, or property damage.

Section 1

Getting Started



Section 1A

Setting Up Service

- ◆ *Setting Up Your Device (page 2)*
- ◆ *Activating Your Device (page 3)*
- ◆ *Setting Up Your Voicemail (page 4)*
- ◆ *Sprint Account Passwords (page 4)*
- ◆ *Getting Help (page 5)*

Setting up and activating your new device is quick and easy. This section walks you through the necessary steps to set up your device, activate your device, set up your voicemail, establish passwords, and contact Sprint for assistance with your Sprint service.

Setting Up Your Device

Note You can also insert a microSD™ card into your device. To learn how to insert a microSD card, see “Using a microSD Card on Your Device” on page 97.

Installing the Battery

1. Remove the back cover by following these steps:
 - Remove the stylus. (You need to temporarily remove the stylus to be able to remove the back cover.)
 - Hold the device with both hands and the front panel facing down.
 - Push the back cover up with your thumb until it disengages from the device and then slide it up to remove.

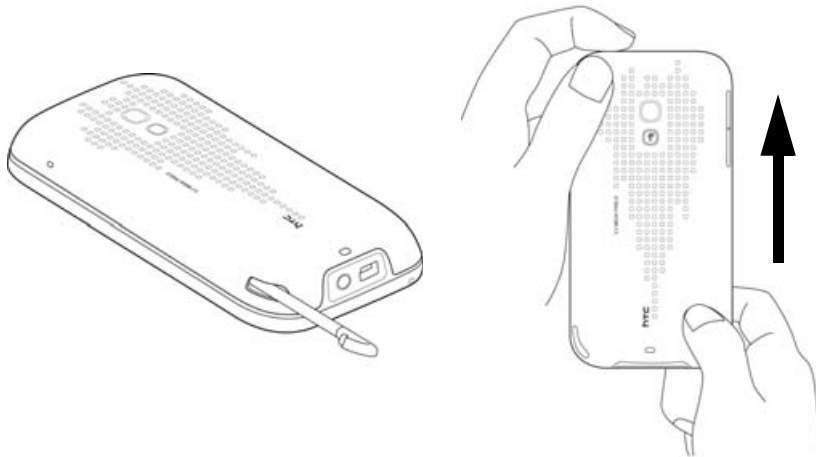

2. Install the battery by following these steps:

- Align the battery's exposed copper contacts with the battery connectors inside the battery compartment.

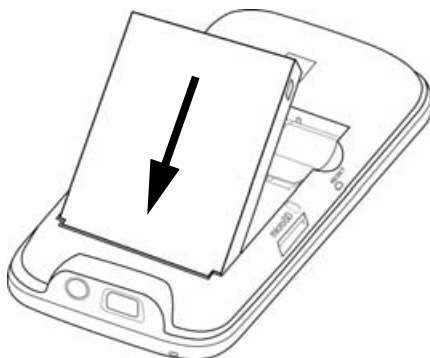

- Insert the contact end of the battery first and then gently push the battery into place.
3. Replace the back cover, and insert the stylus back into the stylus compartment.

Turning the Device On for the First Time

1. Press the **Power** button.
2. When you turn on your device for the first time, your device starts up and guides you to calibrate the touch screen. Follow the onscreen instructions to complete the screen calibration process.
3. Your device will then be activated.
 - If your device is already activated, it will search for Sprint service and then enter standby mode.
 - If your device is not yet activated, see “Activating Your Device” on page 3 for more information.

Note Your device's battery should have enough charge for your device to turn on and find a signal, set up your voicemail, and make a call. You should fully charge your battery as soon as possible. See “Charging the Battery” on page 13 for details.

Activating Your Device

- If you purchased your device at a **Sprint Store**, it is probably activated and ready to use.
- If you received your device in the mail and it is for a new Sprint account or a new line of service, it is designed to activate automatically. To confirm your activation, make a phone call.
- If you received your device in the mail and you are activating a new device for an existing number on your account, you will need to go online to activate your new device.
 - From your computer's Web browser, go to www.sprint.com/activate and complete the onscreen instructions to activate your new device.

When you have finished, make a phone call to confirm your activation. If your device is still not activated or you do not have access to the Internet, contact Sprint Customer Service at **1-888-211-4727** for assistance.

Notes

- Do not press the **End** key while your device is being activated. Pressing the **End** key cancels the activation process.
- If you are having difficulty with activation, contact Sprint Customer Service by dialing **1-888-211-4727** from any other phone.

Making Your First Call

1. Press the **Talk** key to display the Phone screen.

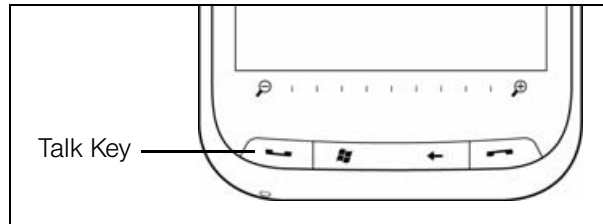

2. Tap the keys on the Phone keypad to enter the phone number.
3. Tap **Talk** to place the call.

For more information about using your device to make and receive phone calls, see “Using Device Features” on page 63.

Setting Up Your Voicemail

1. Press the **Talk** key to display the Phone screen.
2. Touch and hold **1** on the Phone keypad.
3. Follow the system prompts to:
 - Create your passcode.
 - Record your greeting.
 - Record your name announcement.

Note

Voicemail Passcode

Sprint strongly recommends that you create a passcode when setting up your voicemail to protect against unauthorized access. Without a passcode, anyone who has access to your device is able to access your voicemail messages.

For more information about using your voicemail, see “Voicemail” on page 134.

Sprint Account Passwords

As a Sprint customer, you enjoy unlimited access to your personal account information, your voicemail account, and your data services account. To ensure that no one else has access to your information, you will need to create passwords to protect your privacy.

Account User Name and Password

If you are the account owner, you will create an account user name and password when you sign on to www.sprint.com. (Click *Need to register for access?* to get started.) If you are not the account owner (if someone else receives the bill for your Sprint service), you can get a sub-account password at www.sprint.com.

Voicemail Password

You will create your voicemail password (or passcode) when you set up your voicemail. See “Setting Up Your Voicemail” on page 4 for more information on your voicemail password.

Data Services Password

With your Sprint device, you may elect to set up an optional data services password to control data (Web) access and authorize Premium Service purchases.

For more information or to change your passwords, sign on to www.sprint.com or call Sprint Customer Service at 1-888-211-4727.

Getting Help









Managing Your Account

Online: www.sprint.com

You can go online to:

- Access your account information.
- Check your minutes used (depending on your Sprint service plan).
- View and pay your bill.
- Enroll in Sprint online billing and automatic payment.
- Purchase accessories.
- Shop for the latest Sprint devices.
- View available Sprint service plans and options.
- Enable international wireless voice and data services.
- Learn more about data services and other great products like Sprint Picture Mail, games, ringers, screen savers, and more.

From Your Sprint Phone

- From the Phone screen, tap    to check minute usage and account balance.
- From the Phone screen, tap    to make a payment.
- From the Phone screen, tap    to access a summary of your Sprint service plan or get answers to other questions.

From Any Other Phone

- Sprint Customer Service: 1-888-211-4727.
- Business Customer Service: 1-800-927-2199.
- Sprint Worldwide Service: 1-888-226-7212 (option 2).

Sprint 411

Sprint 411 gives you access to a variety of services and information, including residential, business, and government listings; movie listings or showtimes; driving directions, restaurant reservations, and major local event information. You can get up to three pieces of information per call, and the operator can automatically connect your call at no additional charge.

There is a per-call charge to use Sprint 411, and you will be billed for airtime.

- ▶ From the Phone screen, tap    .

Sprint Operator Services

Sprint Operator Services provides assistance when you place collect calls or when you place calls billed to a local telephone calling card or third party.

► From the Phone screen, tap  .

For more information or to see the latest in products and services, visit us online at www.sprint.com.

Section 2
Your Device



Section 2A

Device Basics

- ◆ *Your Device (page 9)*
- ◆ *Inside the Box (page 11)*
- ◆ *Turning Your Device On and Off (page 12)*
- ◆ *Using Your Device's Battery and Charger (page 12)*
- ◆ *Navigating on Your Device (page 14)*
- ◆ *Using the Zoom Bar (page 15)*
- ◆ *The Home Screen (page 16)*
- ◆ *Using the Lock Screen (page 20)*
- ◆ *Adjusting the Volume (page 21)*
- ◆ *Using the Getting Started Application (page 22)*
- ◆ *Connecting Your Device to a Computer (page 23)*

Before you start using your device, take some time to familiarize yourself first with what is available on your device. This section will introduce about the device controls and the home screen on your device. Basic functions such as turning your device on and off and adjusting sound volume will also be covered in this section.

Tip

Device Software Upgrades – *Updates to your device's software may become available from time to time. Sprint will automatically upload critical updates to your device. You can also open the Settings screen to check for and download updates. Slide to the Settings tab, and then tap **Other > Update Firmware** to search for and download available updates.*

Your Device

Top and Front Panels

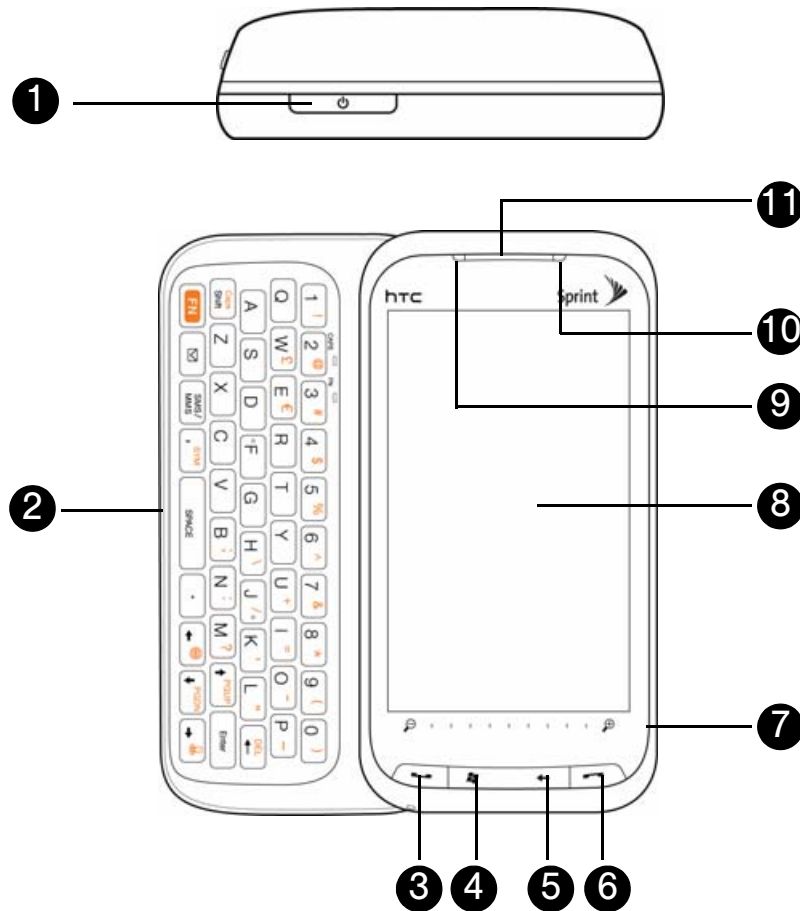

1. **Power Button.** Press to turn off the display temporarily. To turn off the power, press and hold for about five seconds. (For more information, see “Turning Your Device On and Off” on page 12.)
2. **Sliding QWERTY Keyboard.** Slide out the QWERTY keyboard and use it to type messages or documents. (See “Using the Sliding QWERTY Keyboard” on page 26 for details.)
3. **Talk Key.** Press to answer an incoming call or display the Phone screen to place a call. During a call, press and hold to toggle the speakerphone on and off. While viewing a text or email message, press to display the Phone screen so you can call the sender of the message. (See “Using Phone Features” on page 63 for details.)
4. **Start Key.** Press to open or close the Start screen. (See “Start Screen” on page 17 for details.)
5. **Back Key.** Press to return to the previous screen.
6. **End Key.** Press to end a call or return to the Home tab. By default, pressing and holding this key turns Airplane mode on or off. You can reassign pressing and holding of the **End** key to another function. (See “Buttons” in “Personalize” on page 122 for details.)
7. **Zoom Bar.** Slide your finger from left to right to zoom in, or from right to left to zoom out. (See “Using the Zoom Bar” on page 15 for details.)
8. **Touch Screen.** Use finger gestures or the stylus to navigate and interact with the screen. (See “Navigating on Your Device” on page 14 for details.)

9. **Notification LED.** This LED shows the following:

- Flashing green light when there are new text, picture, video, or email messages, missed calls, or reminders.
- Solid green light when the device is connected to the power adapter or a computer and the battery is fully charged.
- Solid amber light when the battery is being charged.
- Flashing amber light when the remaining battery level reaches below 10%.

10. **Light Sensor.** This senses the ambient light and adjusts the screen backlight accordingly.

11. **Earpiece.** Listen to a phone call from here.

Left, Right, and Bottom Panels

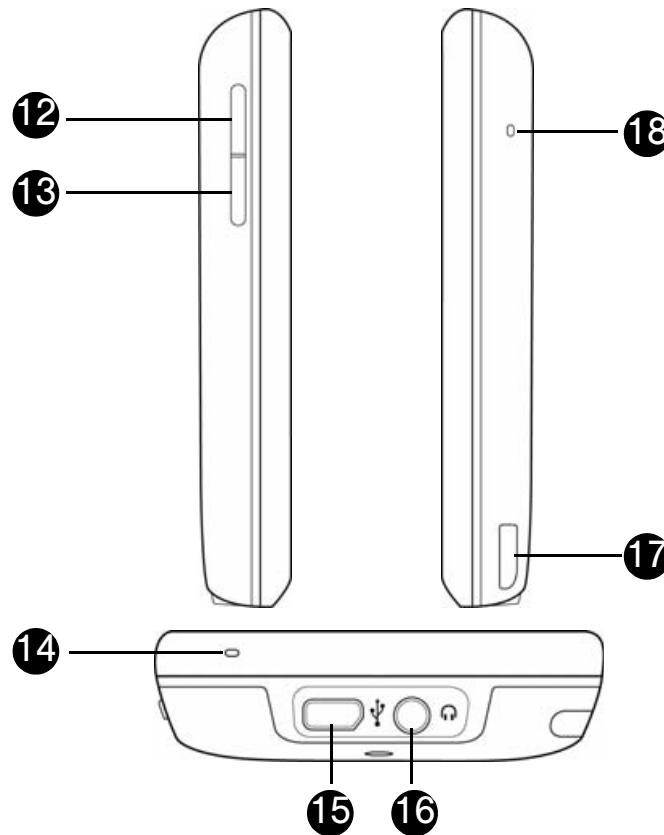

12. **Volume Up Button.** During a call or when playing music, press this button to increase the volume.

13. **Volume Down Button.** During a call or when playing music, press this button to lower the volume.

14. **Primary Microphone.** Speak into this microphone during phone conversations, when recording a voice note, or when giving a voice command.

15. **Sync Connector.** Connect one of the following:

- Connect the AC device charger to recharge the battery.
- Connect the supplied USB cable to a computer so you can synchronize information.
- Connect a USB stereo headset (purchased separately) for hands-free conversation or for listening to audio media.
- Connect a composite video and audio cable (purchased separately) to output the device screen contents and phone audio to an external viewing phone.

16. **Audio Connector.** Connect any standard 3.5mm audio headset.
17. **Stylus.** Use the stylus to write, draw, or select items on the screen. (See “Stylus” on page 15 for details.)
18. **Secondary Microphone.** Both the primary and secondary microphones are enabled when the speakerphone is turned on. (See “Straight Talk” on page 70 for details.)

Back Panel

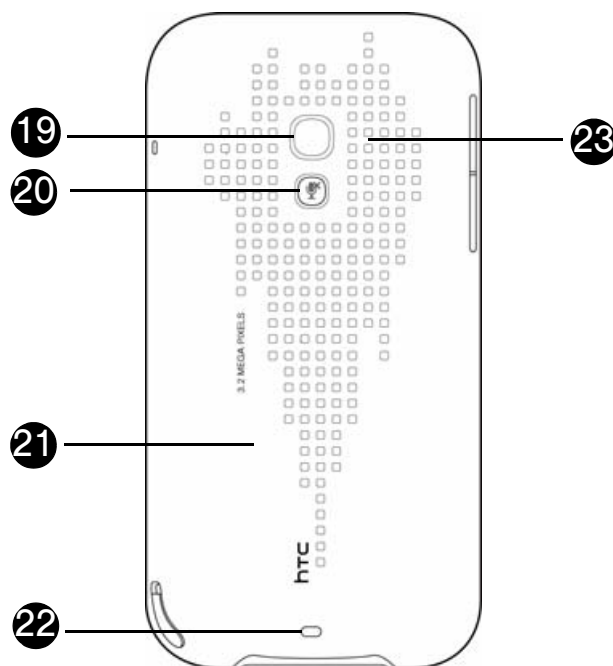

19. **3.2 Megapixel Camera.** Use the camera to take photos and capture video clips. (See “Taking Photos and Videos” on page 105 for details.)
20. **Mute Button.** Press to mute or unmute the dual microphone.
21. **Back Cover.** Push the back cover upward to remove it.
22. **Strap Holder.** Connect a strap or lanyard to easily carry your device.
23. **Dual Speaker.** Use this noise-cancelling dual speaker for three-way calls.

Inside the Box

The product package includes the following items and accessories:

- HTC Touch Pro2
- AC device charger
- USB sync cable
- Battery
- Extra stylus
- LCD screen protector
- Getting Started CD
- Get Started Poster, Basics Guide, Set Up Your Email Guide, and Features Guide

Turning Your Device On and Off

Turning the Power On

- ▶ Press the **Power** button located at the top of your device.

Turning the Power Off

1. Press and hold the **Power** button for about five seconds.
2. Tap **Yes** when a message prompts you to choose whether to turn off the power.

Switching to Sleep Mode When Not In Use

Press and immediately release the **Power** button to turn off the display temporarily and switch your device to **Sleep mode**. Sleep mode suspends your device to a low power state while the display is off in order to save battery power.

Your device automatically goes into sleep mode when you leave the device idle after a certain period of time. You will still be able to receive messages and calls while your device is in sleep mode. Pulling the stylus out of its compartment, pressing the **Power** button again, or incoming calls or messages will wake up your device.

Using Your Device's Battery and Charger

Your device is equipped with a Lithium Ion (Li-Ion) battery. It allows you to recharge your battery before it is fully drained. The battery provides up to 4 hours of continuous digital talk time.

Note

- Long backlight settings, searching for service, vibrate mode, browser use, and other variables may reduce the battery's talk and standby times.
- Watch your device's battery level indicator and charge the battery before it runs out of power.

If you need to purchase extra batteries for your device, Sprint-approved or HTC-approved batteries and accessories can be found at Sprint Stores or through HTC; or call **1-866-343-1114** to order. They're also available at www.sprint.com.

WARNING

Use only Sprint-approved or HTC-approved batteries and chargers with your device. The failure to use a Sprint-approved or HTC-approved battery and charger may increase the risk that your device will overheat, catch fire, or explode, resulting in serious bodily injury, death, or property damage.

To reduce risk of fire or burns:

- Do not attempt to open, disassemble, or service the battery pack.
- Do not crush, puncture, short external contacts, or dispose of in fire or water.
- Do not expose to temperatures above 140°F (60°C).
- Replace only with the battery pack designated for this product.
- Recycle or dispose of used battery as stipulated by local regulations.

Installing and Removing the Battery

Always turn off your device before installing or replacing the battery. You also need to remove the back cover before you can install these components.

To install the battery:

- ▶ See “Setting Up Your Device” on page 2.

To remove the battery:

1. Make sure your device is turned off.
2. Remove the stylus, and then remove the back cover.
3. Lift out the battery from the groove at the upper right side of the battery compartment.

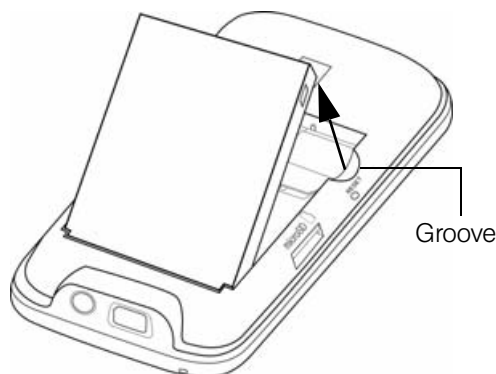

4. Replace the back cover and insert the stylus back into the stylus compartment.

Charging the Battery



Charge your battery as soon as possible so you can begin using your device.

Keeping track of your battery's charge is important. If your battery level becomes too low, your device automatically turns off, and you will lose any information you were just working on. For a quick check of your battery level, glance at the battery charge indicator located in the upper-right corner of your device's display screen. If the battery charge is critically low, the battery icon () will be shown in the title bar.

Always use a Sprint-approved or HTC-approved desktop charger, travel charger, or vehicle power adapter to charge your battery.

To charge the battery:

1. Connect the USB connector of the device charger to the sync connector on your device.
2. Plug in the device charger to an electrical outlet to start charging the battery.

Charging is indicated by an amber light shown on the notification LED of your device. As the battery is being charged while the power is on, a charging icon () also appears in the title bar of the Home screen. After the battery has been fully charged, the notification LED shows a green light, and a full battery icon () appears in the title bar of the Home screen.

For more information about the notification LED, see “Top and Front Panels” on page 9.

WARNING

- Do not remove the battery while you are charging it using the device charger or car adapter.
- As a safety precaution, the battery stops charging when it overheats.

Battery Saving Tips

How long your battery power lasts depends on the battery type and how you use your device. Try the following to help conserve battery life:

- When the device is not in use, press the **Power** button to switch off the display.
- Slide to the Settings tab, and then tap **Sound & Display**. Under **Display** tap **Backlight**. Here, you can specify the time before your device automatically turns off the display and backlight to conserve battery power. For optimum conservation, specify three minutes or less.
- Slide to the Settings tab, and then tap **Sound & Display**. Under **Display** tap **Backlight**. Clear the **Automatically adjust backlight** check box, and manually adjust the backlight brightness settings.
- Use the AC device charger to plug your device into an external power outlet whenever possible, especially when using a modem or other peripherals.
- Turn Bluetooth off when you are not using it. Make your device visible to other devices only when you are trying to establish a Bluetooth partnership. For more information about Bluetooth, see “Using Bluetooth” on page 100.
- Turn Wi-Fi off when you are not using it. For more information, see “Turning Wi-Fi On and Off” on page 147.
- Lower the volume.
- Close battery-intensive programs such as the camera when you are done using them. Make sure the programs are ended and are not continuously running in the background. See “Using Task Manager” on page 128 for information on closing programs.

Navigating on Your Device

You can use finger gestures or the stylus to navigate and interact with the interface of your device:

Finger gestures

You can use finger gestures to select, scroll and pan on the touch screen.

Touching or tapping

When selecting items on the screen, such as the Home screen tabs, Start screen, programs and settings icons, and large onscreen buttons, simply tap them with your finger. Apply some pressure with your finger pad when touching an item on the screen.

“Tapping” is touching the screen lightly and quickly with your finger pad or fingertip. On screens that display smaller-size items, you can more accurately select an item by tapping it with your fingertip.

Finger-scrolling

Finger-scrolling can be used to scroll up and down Web pages, documents, and lists such as the contacts list, file list, message list, calendar appointments list, and more.

To scroll up and down:

- To scroll down, swipe your finger upward on the touch screen. To scroll up, swipe your finger downward on the touch screen. (“Swiping” means dragging your finger vertically on the screen.)
- To auto-scroll, flick your finger upward or downward on the touch screen. Touch the screen to stop scrolling. (“Flicking” is similar to swiping, except that you need to swipe your finger in light, quicker strokes.)

To scroll left and right:

- To scroll towards the right, swipe your finger to the left. To scroll towards the left, swipe your finger to the right.
- To auto-scroll, flick your finger left or right. Touch the screen to stop scrolling.

Finger-zooming

To zoom in on a Web page in Opera Mobile or a photo in Albums, tap your finger twice on the screen. To zoom out, tap twice again on the screen.

For more information about using Opera Mobile, see “Using Opera Mobile” on page 151. For more information about using Albums, see “Viewing Photos and Videos” on page 112.

Finger-panning

You can use finger-panning to move to and view other parts of a zoomed photo, Web page, document, or an email message. To pan, touch and hold on the touch screen and then drag your finger in any direction.

Stylus

To use the stylus, pull it out from the stylus compartment at the bottom right of your device. If the backlight is off, removing the stylus automatically turns the backlight back on.

Tap with the stylus to open programs and select items on the screen, and touch and hold on the screen to open a shortcut menu. You can also use the stylus in a similar way to making finger gestures.

Using the Zoom Bar

The zoom bar located below the touch screen is a handy zoom control that is unique on your device. When you are viewing a Web page in Opera Mobile or a photo in Albums, you can zoom in by sliding your finger from left to right across the Zoom bar, or zoom out by sliding from right to left.

You can also instantly enlarge or shrink the text size when you are reading messages or Word documents. Slide your finger from left to right across the zoom bar to increase the text size, or slide from right to left to decrease. To increase or decrease the text size more, slide across the zoom bar again.

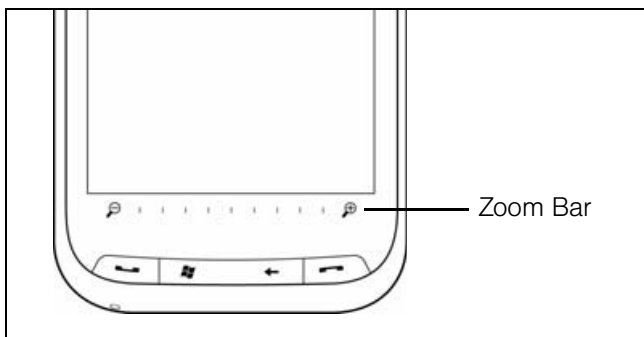

The Home Screen

The default screen of your device is the Home screen which allows finger-touch access to the most important functions such as contacts, text messages, email, calendar, Internet, and more.



1. Open the Start screen for quick access to important features and programs on your device. See “Start Screen” on page 17 for details.
2. Navigate the Home screen. See “Using the Home Screen” on page 32 for details.
3. Open the Phone screen. See “Using Phone Features” on page 63 for details.
4. Open a menu where you can change the Home tab wallpaper, personalize the Home screen tabs, set local time and date settings, and more. See “Using the Home Screen” on page 32 for details.
5. Check the status icons for battery usage, connection status, and more. See “Status Icons” on page 18 for details.

Start Screen

The Start screen gives you one-touch access to the programs and settings of your device. To open the Start screen, tap **Start** on the top-left corner of the screen or press the **Start** key ().



On the Start screen

- Swipe your finger up or down to scroll through the screen.
- Tap the **Today** icon to return to the Home screen. See “The Home Screen” on page 16 for details.
- Tap a program icon to open the corresponding program.
- Tap the **Settings** icon to access the settings of your device.
- Tap **Lock** at the bottom-left corner of the Start screen to lock your device. See “Using the Lock Screen” on page 20 for details.
- Press the **Start** key twice to close the Start screen.

To move an icon to the top of the Start screen

You can move often used icons to the top of the Start screen for easy access.

1. Touch and hold the icon that you want to move.
2. Tap **Move to Top**. The icon is moved to the top of the Start screen.

To return an icon to its original location, touch and hold the icon and then tap **Move Down**.

Status Icons

The following are some of the status icons that you may see on the device.



1		Multiple notifications; tap the icon to view all
		New SMS text messages
		New instant message from Live Messenger
		Missed call
		Speakerphone on
		Roaming
		Alarm
		Other wireless network(s) detected
		Wired headset connected
		Bluetooth on
		Bluetooth visible mode on
		Bluetooth stereo headset connected

2		1xRTT available
		EVDO available
		Connected to a wireless network
		Connection is active
		Connection is not active
		Synchronization in progress

3		Data connection is active but idle
		Data connection is active and transmitting data
		Maximum signal strength
		No signal
		Phone is turned off
		No phone service
		Searching for phone service
		Voice call in progress

4		Vibrate mode
		Sound on
		Sound off

5		Battery charging
		Battery fully charged
		Battery charge level very low

Notifications Screen

When you tap the status icon area of the title bar, the Notifications screen opens to display your connection status and lists all your pending notifications including missed calls, new text messages, new email, event reminders, and more.

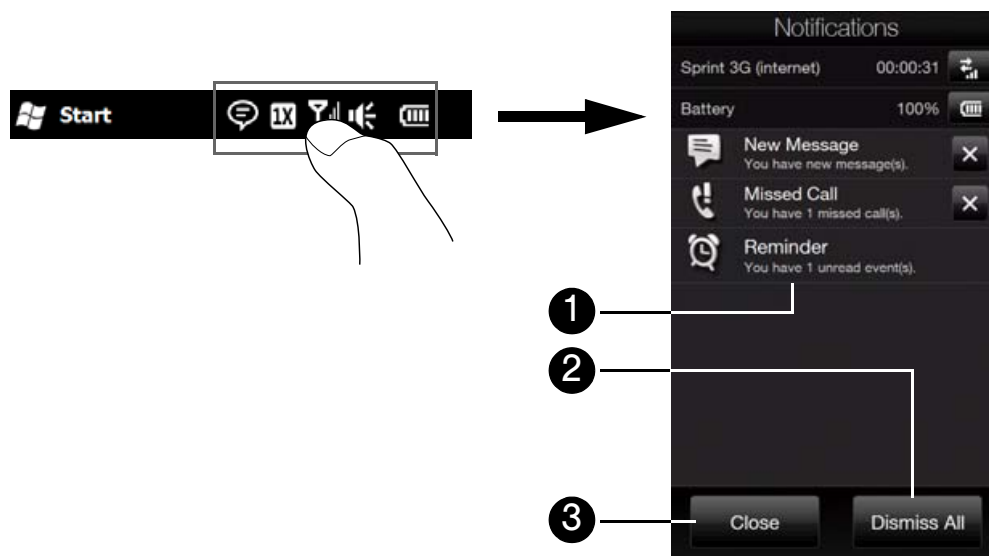

1. Tap an item on the Notifications screen to open the related screen.
2. Tap **Dismiss All** to ignore all notifications.
3. To close the Notifications screen, tap **Close** or press the **Back** key.

Using the Lock Screen

The Lock screen is displayed whenever your device is locked. You can lock your device to prevent accidental button or touchscreen presses when the device is in your bag or pocket.

Locking Your Device

Your device automatically locks when your device is password protected, and the set idle time has elapsed. Your device locks itself and requires the correct password entry to unlock it. For more information about setting a password and idle time for your device, see “Protecting Your Device with a Password” on page 130.

You can also lock the device manually. Tap **Start** and then tap **Lock** in the lower left corner of the Start screen.

Unlocking Your Device

When you see the Lock screen, slide the Lock button () left or right to unlock your device.

Note If you have set a password for your device, you will be prompted for the password when you unlock the device. See “Protecting Your Device with a Password” on page 130 for information on setting a password.

Checking Notifications When the Device Is Locked

When your device is locked, you are still notified of missed calls, new messages, and upcoming appointments. The Lock screen shows the next upcoming appointment and the Lock button shows the number of notifications.

To view the notifications

1. On the Lock screen, tap the Lock button (). Notification buttons representing each type of received information, such as missed calls, new email, and new text messages, are then displayed below the Lock button.
2. Slide a notification button right or left to view the respective information. For instance, slide the Missed Call button to access the Call History and view missed calls.

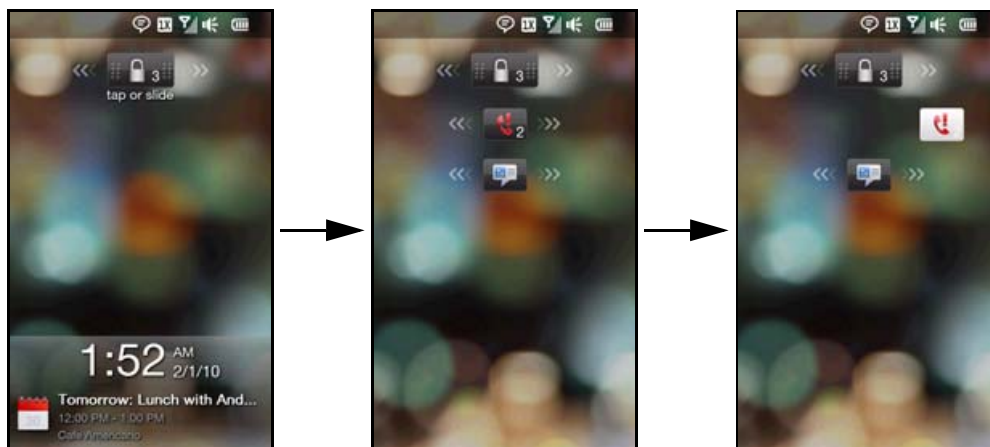

Note If a device password is set, you are prompted for the password before you can view the notification item. See “Protecting Your Device with a Password” on page 130 for information on setting a device password.

Receiving a Call When the Device Is Locked

You can receive and answer calls even when your device is locked. For more information about answering calls, see “Answering and Ending Calls” on page 66.

After you end the call, your device remains locked and the Lock screen is displayed. You need to unlock to use your device.

Adjusting the Volume

By default, your device allows you to set the system volume (notifications and audio/video playback volume) and the phone ring volume separately. If you want to adjust the system volume and ring volume simultaneously, first you will need to enable the **Single Volume** option in the settings.

To adjust the system and ring volumes separately:

1. Press the **Volume Up** or **Volume Down** button on your device.
2. To switch between the System Volume and Ring Volume screens, tap **System** or **Ring** at the top of the screen.
3. To adjust the volume level on either screen, drag your finger up or down the volume bars, or press the **Volume Up** or **Volume Down** button on your device. You can also:
 - Tap **Silent** to mute the volume.
 - Tap **Vibrate** to switch the device to Vibrate mode.

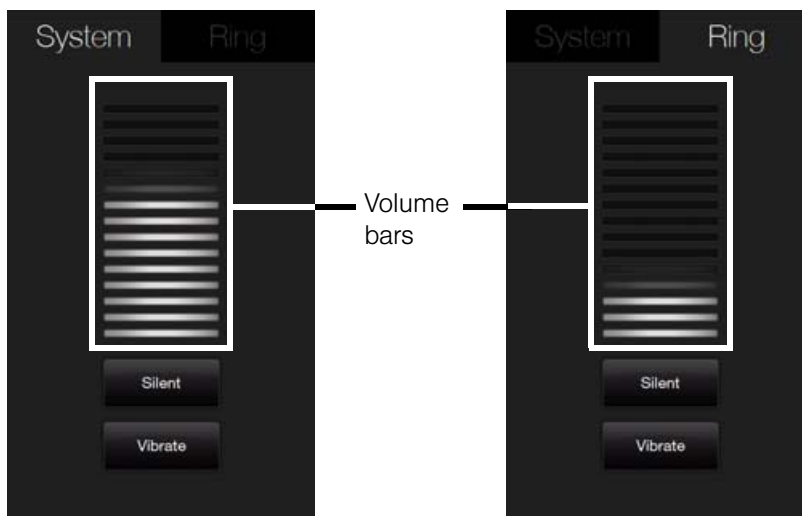
**Tip**

Also press the **Volume Up** or **Volume Down** button when adjusting the conversation phone volume during an ongoing call.

To set a single volume:

1. Slide to the Settings tab, and then tap **Sound & Display**.
2. Turn on the **Single volume** option.

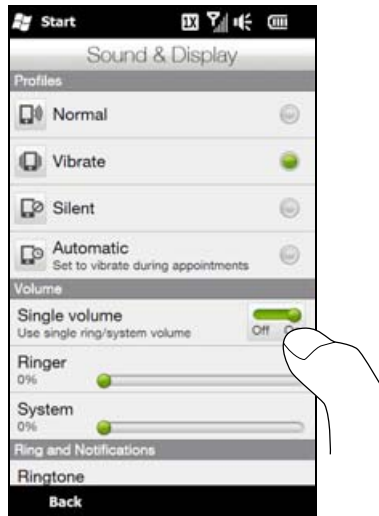

3. Open the Volume screen by pressing either the **Volume Up** or **Volume Down** button on your device.
4. To increase or decrease the volume level, drag your finger up or down the volume bars, or press the **Volume Up** or **Volume Down** button. You can also:
 - Tap **Silent** to mute the volume.
 - Tap **Vibrate** to switch the device to Vibrate mode.
5. The Volume screen automatically closes. You can also tap an empty area of the Volume screen to close it.

Note You can also press the **Volume Up** or **Volume Down** button to adjust the earpiece volume during an ongoing call.

Using the Getting Started Application

The **Getting Started** application is a list of “how to’s” that you can use to learn basic features and settings of your device.

To learn the basics through the **Getting Started** application:

1. Tap **Start > Getting Started**. (You may need to scroll down the screen to see the icon.)
2. In the **Getting Started** application, tap one of the items onscreen to learn how to do a certain task.
3. If there is a link to the screen where you actually perform a selected task, tap the link to go to that screen.

Connecting Your Device to a Computer

Whenever you connect your device to the computer with the USB cable, the Connect to PC screen displays and prompts you to choose the type of USB connection:

ActiveSync

Select this mode when you need to do the following:

- Synchronize Outlook email messages, contacts, calendar appointments, files, and other data between your device and your computer.
- Have read and write access to the whole device.

See “Synchronizing Information With Your Computer” on page 75 for details.

Disk Drive

This mode is available for selection only when you installed a microSD card on your device. Select this mode when you want to use your storage card as a USB thumb drive, and copy files between your device’s storage card and your computer faster.

See “Using Your Device as a USB Drive” on page 99 for details.

Internet Sharing

When you do not have Internet access on your computer, you can select this mode to use your device to provide Internet access to your computer.

For more information about using Internet Sharing, see “Internet Sharing” on page 173.

Entering Text

- ◆ *The Sliding QWERTY Keyboard vs. Onscreen Keyboards (page 24)*
- ◆ *Using the Sliding QWERTY Keyboard (page 26)*
- ◆ *Using the Full QWERTY Layout (page 27)*
- ◆ *Using the Phone Keypad (page 29)*
- ◆ *Using Predictive Mode (page 30)*
- ◆ *Using Numeric and Symbol Mode (page 31)*
- ◆ *Text Input Settings (page 31)*

Your device provides convenient ways to enter letters, numbers, and symbols whenever you are prompted to enter text (for example, when adding a Contacts entry or when using email and SMS text messaging). This section shows you how to enter text using the sliding QWERTY keyboard and various onscreen input methods that are available on your device.

The Sliding QWERTY Keyboard vs. Onscreen Keyboards

You can use either the sliding QWERTY keyboard or one of the onscreen keyboards to enter text.

Sliding QWERTY Keyboard

Your device comes with a sliding QWERTY keyboard, which is similar to a standard keyboard on your computer.

To use the keyboard, slide the screen panel to the right to reveal the keyboard. The screen orientation automatically switches to landscape mode when the keyboard is opened.



For more information about using the QWERTY keyboard, see “Using the Sliding QWERTY Keyboard” on page 26.

Onscreen Keyboards

For single-handed text input in portrait mode, you can use one of the finger-friendly onscreen keyboards: *Full QWERTY*, *Compact QWERTY*, and *Phone Keypad*.

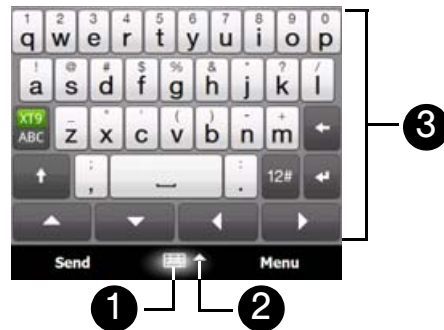

1. When you use a program or select a field that allows you to enter text or numbers, the *Input Panel* icon becomes available at the bottom center of the screen.
2. Tap the *Input Selector* arrow (that appears next to the *Input Panel* icon) to open the Input Method menu where you can select an onscreen keyboard to use for entering text.

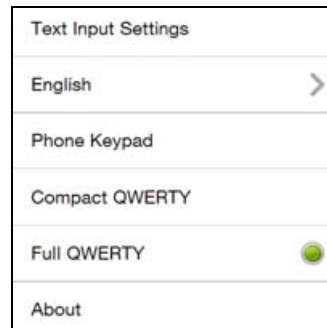

Input Method menu

3. After selecting a type of onscreen keyboard, the selected keyboard layout is displayed on the screen for you to use.

Note When in landscape mode, Phone keypad is not available.

Using the Sliding QWERTY Keyboard

After opening the sliding QWERTY keyboard, you can adjust the angle of the device screen to minimize glare and reflection.

Adjusting the LCD Screen Angle

The maximum tilting angle of the screen is 50 degrees. Do not force the screen to tilt further than the maximum tilting angle as it will break the device.

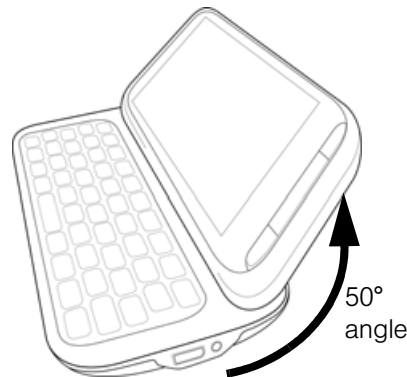

Before you retract the screen, please be sure to adjust the screen angle back to the original horizontal position.



Keys on the Sliding QWERTY Keyboard



- To type lowercase letters and numbers, press the keys using your thumbs or fingers.
- To enter all uppercase letters, press **Caps Shift** twice, or press **FN** first and then press **Caps Shift**.
To change back to all lowercase letters, press **Caps Shift** again.
- To enter a single uppercase letter, press **Caps Shift** and then press the corresponding key.
- To enter a symbol or punctuation mark, or launch the program that is printed on the upper right corner of a key, press **FN** and then press the corresponding key.

- To open the Symbol Pad, press **FN** and then press **SYM**.
 - Press **Enter** to insert a hard return while typing.
 - Press the arrow keys **←** / **→** / **PGUP** / **PGDN** for directional movement.
 - To backspace and delete the previous character, press **DEL**.
 - To delete the next character that appears to the right of the blinking cursor, press **FN** first and then press **DEL**.
- To consecutively delete several characters that appear to the right of the blinking cursor, press **FN** twice and then keep pressing **DEL** until the characters are deleted.
- Press **Ⓜ** to open the Messaging program.
 - Press **SMS/MMS** to open your SMS/MMS messaging account.

Using the Full QWERTY Layout

Full QWERTY is a full onscreen QWERTY keyboard layout similar to a desktop computer keyboard.



1. Tap the keys to enter letters or symbols.
Touch and hold a key to enter a punctuation mark, symbol, or number shown on top of a key.
2. **XT9 ABC** indicates you are in Predictive mode. Tap to change to Normal mode.
XT9 ABC indicates you are in Normal mode. Tap to change to Predictive mode.
3. Tap the **Shift** key to enter an uppercase letter.
Tap the **Shift** key twice to turn on Caps Lock.
4. Use the four arrow keys for directional movement on the screen.
5. Tap the **Enter** key to create a new line.
6. Tap the **Back** key to delete the previous character.
7. Tap **12#** to open a keyboard layout that lets you easily enter numbers and symbols. See “Using Numeric and Symbol Mode” for details.
8. Displays the word candidate list in predictive mode. Tap a word to insert it into your text. (To learn how to enter text using Predictive mode, see “Using Predictive Mode” on page 30.)

To enter text using the Full QWERTY layout:

1. Start a program that accepts text input, such as Word Mobile.
2. Tap the *Input Selector* arrow, and then tap *Full QWERTY*.
3. Start tapping keys on the keyboard as you would on a computer keyboard to enter your text.

To enter accented characters:

1. Touch and hold a key with accent options (for example, vowels) to display the accented characters bar.
2. Slide your finger left or right on the screen to select the desired accented character.

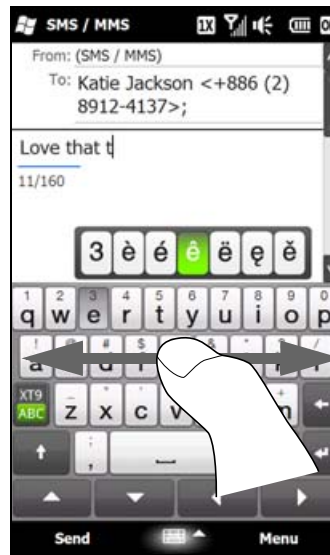





3. When you have selected the desired accented character, release your finger to insert it to your text.

You can also use the Numeric and Symbol mode to enter accented characters. See “Using Numeric and Symbol Mode” on page 31 for details.

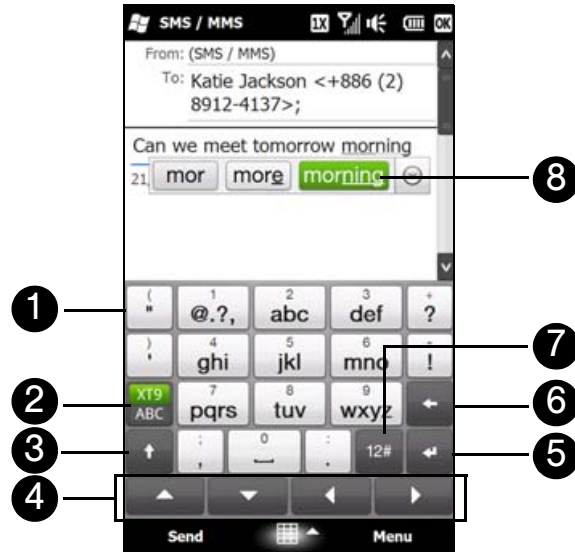
Using the Phone Keypad

The *Phone Keypad* is an onscreen keypad that has a layout similar to mobile phone keypads, plus some additional keys. The Phone keypad has large keys and enhanced input features such as predictive text input, which make it faster for you to enter text in your messages and documents.



1. Tap the keys to enter letters or symbols.
Touch and hold a key to enter a punctuation mark, symbol, or number shown on top of a key.
2.  indicates you are in Predictive mode. Tap to change to Multitap mode.
 indicates you are in Multitap mode. Tap to change to Predictive mode.
3. Tap the **Shift** key to enter an uppercase letter.
Tap the **Shift** key twice to turn on Caps Lock.
4. Use the four arrow keys for directional movement on the screen.
5. Tap the **Enter** key to create a new line.
6. Tap the **Back** key to delete the previous character.
7. Tap  to open a keyboard layout that lets you easily enter numbers and symbols. See “Using Numeric and Symbol Mode” for details.
8. Displays the word candidate list in predictive mode. Tap a word to insert it into your text. (To learn how to enter text using Predictive mode, see “Using Predictive Mode” on page 30.)

To enter text using the Phone keypad:

1. Start a program that accepts text input, such as Word Mobile.
2. Tap the *Input Selector* arrow, and then tap *Phone Keypad*.
3. When in Multitap mode () , enter a character by tapping a key until the desired character is displayed on the screen. As you tap the keys, the activated key displays just above the tapped key.
 - To enter the first letter that shows on a key, tap the key once. To enter the second letter, tap twice, and so on.
 - To enter a punctuation mark, symbol, or number that appears at the top of a key, touch and hold the key.
4. You can also use the Predictive text input mode in Phone Keypad. For more information, see “Using Predictive Mode” on page 30.

Using Predictive Mode

XT9 is a predictive text input mode that displays a word candidate list as you enter the first few characters so you select just the word that you want.

To enter text using Predictive mode:

1. Make sure that the input mode is set to XT9 ().
2. Start entering the first few letters of a word. As you enter each letter, suggested words will be displayed. In the word suggestions list, the leftmost word shows the exact letters that you entered, while the other words are suggested words.

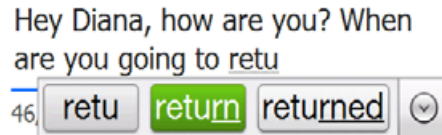

If you don't see the word that you want, tap the down arrow icon () to see more suggested words.



3. Tap the desired word to insert it to your text. If the word is highlighted in the word candidate bar, you can also tap the **Enter** key or the **Space** bar to insert it to your text.

Note If there are several words to choose from, tap the left or right directional arrow keys at the bottom of the onscreen keyboard to navigate through the predicted words on the word candidate bar.

To add a word to the XT9 dictionary:

While entering text using the Full QWERTY, Compact QWERTY, or Phone Keypad, new words can be automatically added to the dictionary. When you tap a suggested word or enter a word followed by a space, the word will automatically be added to the dictionary if it does not exist in the dictionary.

When using the Compact QWERTY or the Phone Keypad, you can also manually add new words to the dictionary.

1. While in XT9 mode, type a letter and then tap the down arrow icon () on the right side of the word suggestions list.
2. Tap **Add Word**.
3. Type the word you want to add and then tap .

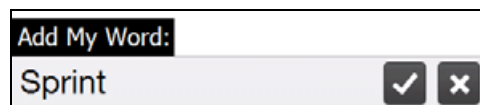

Using Numeric and Symbol Mode

Switch to Numeric and Symbol mode to easily enter numbers and common symbols such as parentheses, braces, currency signs, punctuation marks, and special characters.

To switch to Numeric and Symbol mode:

1. While using the Full QWERTY or Phone keypad, tap .

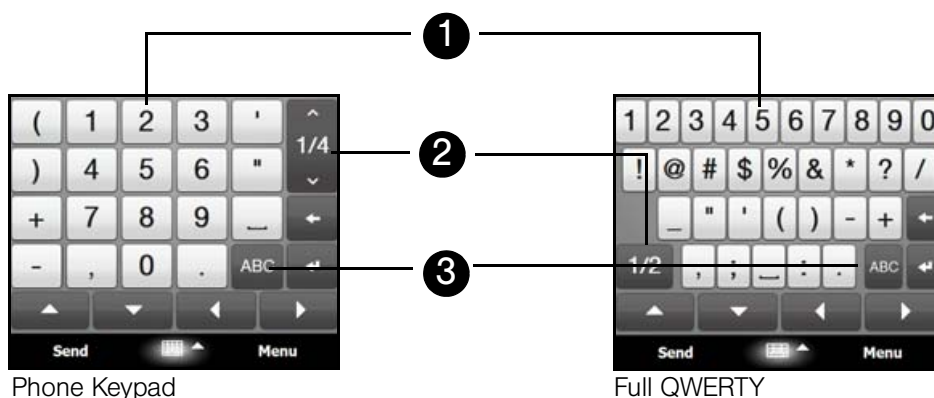

2. Tap a number or symbol to insert it into your text.
3. Tap to go to the previous or next page of symbols.
4. Tap to switch back to the letter keyboard layout.

To automatically switch to the letter keyboard layout:

By default, the onscreen keyboard in Numeric and Symbol mode is locked so you can continuously enter symbols and numbers. Do the following if you want the onscreen keyboard to automatically switch to the letter keyboard layout after you have selected a symbol.

1. Tap the *Input Selector* arrow and then tap *Text Input Settings*.
2. Tap the switch next to *Symbol lock*.
3. Tap *OK*.

Text Input Settings

Text input settings can be accessed either from the keyboard layout selection menu or from the device settings.

- From any of the keyboard layouts, tap the *Input Selector* arrow at the bottom of the screen and then tap *Text Input Settings*.

— or —

- On the Home screen, slide to the Settings tab, and then tap *Locale & text > Text input*.

On the Text Input Settings screen, tap the Off/On switches to enable or disable the various input settings.

Section 2C

Using the Home Screen













- ◆ *The Home Screen (page 32)*
- ◆ *Home (page 35)*
- ◆ *People (page 38)*
- ◆ *Mail (page 46)*
- ◆ *Messages (page 47)*
- ◆ *Calendar (page 48)*
- ◆ *Internet (page 50)*
- ◆ *Photos and Videos (page 51)*
- ◆ *Sprint Music (page 52)*
- ◆ *Sprint Navigation (page 54)*
- ◆ *Sprint TV (page 55)*
- ◆ *Weather (page 56)*
- ◆ *Stock (page 57)*
- ◆ *Twitter (page 58)*
- ◆ *Settings (page 62)*

The Home screen is the quickest route to the essential features of your device, which include People, Messages, Mail, Internet, and more. The tabs at the bottom of the Home screen correspond to the different device features. This section will show you how to navigate the Home screen by simply using finger gestures.

The Home Screen

The Home screen has the following tabs:



Icon	Tab Name	Icon	Tab Name
	Home		Sprint Music
	People		Sprint Navigation
	Mail		Sprint TV
	Messages		Weather
	Calendar		Stocks
	Internet		Twitter
	Photos & Videos		Settings

Switching Between Tabs on the Home Screen

- Tap the desired tab on the Home screen.
— or —
- Touch and hold the active tab, and then slide your finger right or left over the tabs. Release when you have selected the desired tab.

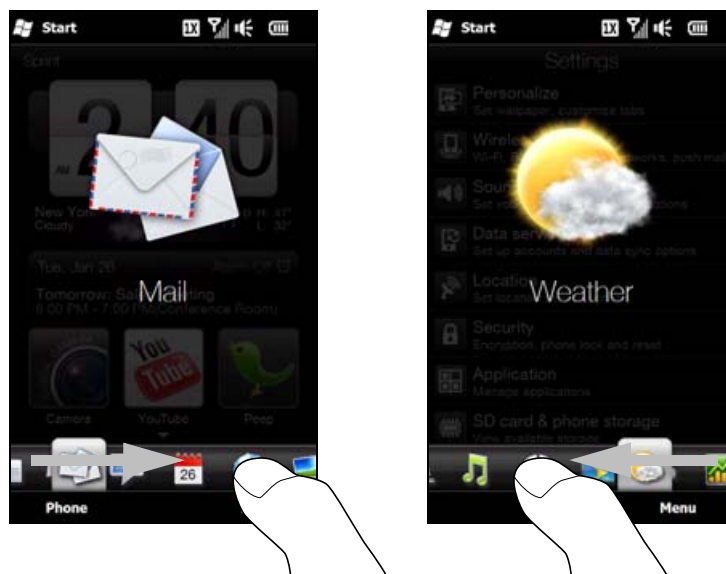

Note Apply some pressure when pressing and holding on the active tab to be able to slide over the tabs.

- or —
- Swipe left across the screen to move to the next tab, and swipe right across the screen to move to the previous tab.
— or —
- When using the sliding QWERTY keyboard, press the right key to move to the next tab, and press the left key to move to the previous tab.

Navigating the Home Screen in Landscape Mode

The Home screen tabs are always displayed when the Home screen is in portrait view. When you slide out the QWERTY keyboard, the Home screen automatically changes to landscape view and temporarily hides the tabs. Tap the *Expand* button () at the bottom left side of the Home screen to display the tabs.



Customizing Home Screen Tabs

You can rearrange or hide the tabs on the Home screen, except for the Home tab. The Settings tab cannot be disabled and hidden also from the Home screen.

1. On the Home tab, tap *Menu* > *Personalize Home Screen Tabs*.
2. To move a tab, touch and hold the icon before the tab name, and then drag it up or down the tabs list. Release the icon when you reach the desired location.
3. To hide a tab, clear the check box at the right of the tab name.
4. Tap *Done*.

Home

The **Home** tab displays the current date, a flip-style digital clock, weather for your current location, and an alarm icon that indicates whether the alarm is on or off. Missed calls, voicemails, and your upcoming calendar appointments are also shown on the Home tab. You can also personalize the Home tab with your own wallpaper and add quick links to your favorite programs, contacts, and websites.

To select an item on the Home tab, simply tap the item.



1. Tap the clock to open the World Clock screen where you can select your location to automatically set the date and time accordingly or you can manually change the date and time. Tap the weather animation or the “My Location” text to display the Weather tab where you can update weather information and display a forecast. You can also access the Alarm Clock screen to change alarm clock settings.
2. Tap to set the date.
3. Tap the upcoming appointment to view or edit the details of the appointment. If there are no listed appointments on the Home tab, tap **Calendar** to go to the Calendar tab and create new appointments. See “Calendar” on page 84 for details.
4. Tap a quick link to open the associated program, contact, or website.
5. Swipe upward on the screen to display the small digital clock and view more quick links. Swipe downward on the screen to change back to the large flip-style digital clock.

Tip When you are on another Home screen tab, press the **END** key to return to the Home tab.

Changing the Wallpaper

On the Home tab, you will see a lifelike animation of your current weather. You can change the wallpaper of this weather animation or choose another animated wallpaper for the Home tab.

On the Home tab, tap **Menu > Home Wallpaper** and do one of the following:

- To choose another wallpaper image for the weather animation, tap **Weather Wallpaper**. On the subsequent screen, select one of the presets to use as your wallpaper.

If you have your own custom wallpaper that you want to use, tap **Albums** and then tap **All**. Scroll through the photos stored on your device and storage card and then tap the photo that you want to use.

- To choose another animated wallpaper, tap **Animated Wallpaper** and select one of the preset animations.

To reset the Home tab back to the weather animation, tap **Menu > Home Wallpaper > Weather Wallpaper** and select any wallpaper image.

Updating Weather Information

Your device can determine your current location and display your local time and weather conditions on the weather clock.

If the weather clock does not show the most recent weather conditions or does not show any weather information for some reason (such as when the auto download option is disabled), tap the weather image or the “My Location” text to go to the Weather tab and then tap **Update Now**. The most recent weather information of your location will then show on both the Weather tab and the Home tab’s weather clock.

You can set the time interval for automatically updating weather information on the Home tab. On the Home tab, tap **Menu > Weather Settings**, and then choose a time interval.

For more information about viewing weather information, see “Weather” later in this chapter.

World Clock

On the Home tab, tap the digital clock to open the **World Clock** tab () where you can select the city where you are located so that the Home tab displays your local time and weather, or select to display the time and weather of another city. If you do not find your city, tap **Add City** to add it.

You can also change the date and time of your local city, remove cities, or rearrange cities on the World Clock tab.

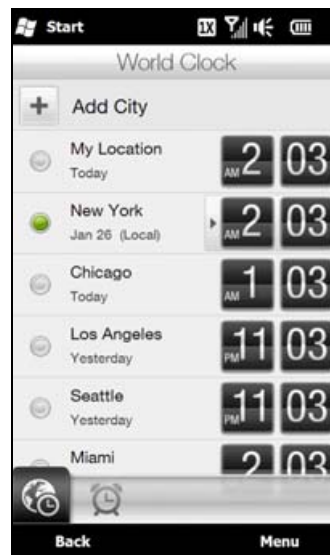

Selecting Another Location to Display on the Home Tab

You can change the Home tab to display the date, time, and weather information of another location.

1. On the Home tab, tap the clock.
2. The World Clock screen opens. Scroll through the list of cities.
3. If the location that you want is not listed, tap **Add City**.
4. On the Add Location screen, enter the first letters of a country or city name. The screen then displays a matching list of locations. Scroll through the list and then tap the name of the desired city.
5. On the World Clock screen, scroll through the list of cities and select a city. To select, tap the circle that appears to the left of the city.

Tip

- You can rearrange or remove cities on the World Clock screen. Tap **Menu > Rearrange Cities** and then drag them to the order that you want. Tap **Menu > Remove Cities** to delete one or more cities.
- Locations that you added to the World Clock screen are also added to the Weather tab.

Changing the Date and Time

If you want to change the date shown on the Home tab, tap the date and then choose another date. When you have finished setting the date, tap **Set**.

To change the local time displayed on the Home tab, tap **Menu > Set Local Time and Date** and set the new time and date. Tap **Done** to change to the selected time and date.

Tip

You can also change the date and time from the World Clock screen.

Alarm Clock

When the alarm clock is not enabled, “Alarm Off” will be shown on the Home tab. Tap it to open the Alarm Clock screen so you can turn on and set the alarm clock.

To set an alarm:

1. On the Alarm Clock screen, tap an alarm time.
2. On the Set Alarm screen, adjust the alarm time (hour and minutes), and then tap the day of the week for the alarm.

Tip

Select multiple days by tapping each desired day. Tap a selected day to exclude it from the alarm.

3. Enter the alarm description, select the alarm ringtone, and then choose whether you want the device to vibrate when the alarm goes off.
4. Tap **Done**.
5. On the Alarm Clock screen, tap the OFF/ON slider to turn on the alarm.

Note

When an alarm goes off, you have the choice to **Snooze** or **Dismiss** the alarm. When you select **Snooze**, the alarm will sound again after 5 minutes.

Adding Quick Links

Quick links are shortcuts that give you one-touch access to your favorite programs, people who matter most to you, and frequently-visited websites. Up front on the Home tab, you can add up to nine quick links.

To add a quick link, tap an empty slot and then choose the type of shortcut to add to the Home tab.

When the first three slots are occupied, swipe your finger up on the screen to access more slots for adding quick links.

Note

When you swipe your finger up on the screen, the appearance of the Home tab changes, showing only the date, time, and alarm icon on a horizontal bar. Tap the horizontal bar when you want to change the date, time, or alarm clock setting. (Tapping the horizontal bar opens the World Clock screen.)

People

On the **People** tab, you can add favorite contacts and quickly make calls or send text and email messages to these contacts.

From the People tab, you can also set up your own contact card, create new contacts, view your stored contacts list, as well as view exchanged calls and text, multimedia and email messages with a contact. If your contacts have Facebook accounts, you can check if they have any Facebook updates and events.

Note You need an active connection to the Internet to link to Facebook.

There are several ways to add contacts to your device. You can:

- Create new contacts on your device. See “Creating New Contacts” on page 39 for details.
- Sync Outlook contacts from your computer to your device. See “Synchronizing Information With Your Computer” on page 75 for details.
- Sync contacts from your existing Microsoft® My Phone account, if you have one. See “Synchronizing with Microsoft My Phone” on page 80 for details.

Setting Up My Contact Card

My Contact Card stores your personal details on your device. There are two ways to add your personal details to My Contact Card.

To enter your personal details to My Contact Card

On your device, enter your personal details directly to My Contact Card.

1. On the Home screen, slide to the People tab and then tap **All People**.
2. Tap **Me** to open the My Contact Card screen.
3. To add your personal photo, tap the Contact Photo icon () in the upper-right corner of the My Contact Card screen. Choose whether to use your Facebook photo, select a photo from Albums, or take a photo using the camera.

If you chose to use your Facebook photo, enter the email address and password that you use for your Facebook account when you are prompted to log into Facebook.

4. Enter your name, phone number, and email address in the fields provided. Scroll down the screen and fill in more personal details.
5. Tap **Done**.

To sync your Outlook contact card from your computer and save to the device's My Contact Card

If you are using Microsoft® Office Outlook® on your computer, you can create your own contact card containing your personal details on your computer and sync it along with other Outlook contacts to your device. To find out how to sync your computer with your device, “Synchronizing Information With Your Computer” on page 75.

After synchronization is complete, do the following:

1. On the Home screen, slide to the People tab and then tap **All People**.
2. Scroll through your contacts list and tap your name.
3. Tap **Menu > Save to My Contact Card**.

Note You can save any contact or SIM contact to My Contact Card.

Creating New Contacts

From the People tab, you can easily create and store the contact details of the people and businesses that you communicate with.

1. On the People tab, tap **All People**.
2. The All People screen then opens and displays the **All** tab (). Tap **New** to create a new contact.
3. To add the contact's photo, tap the square box on the upper-right side of the New Contact Card screen. You can link to the contact's Facebook photo, select an existing photo in Albums, or open Camera and take a photo of the contact.
4. Enter the contact information in the fields provided and then tap **Done**.



Tips

- To link with the contact's Facebook account, scroll down the New Contact Card screen and then tap **Link**. For more information about Facebook, see "Facebook Updates and Events" on page 44.
- Tap **More** at the bottom of the New Contact Card screen to enter additional contact information from Windows Mobile's Contacts program. See "Contacts" on page 82 for details.

To create a SIM contact

1. On the Home screen, slide to the People tab and then tap **All People**.
2. Tap **Menu > New Contact > SIM**.
3. Enter the contact name and phone number, and then tap **Done**.

Note

Importing SIM contacts to your device results in duplicate contact names in the contacts list.

Adding and Selecting Favorite Contacts

You need to have contacts already stored on your device before you can add them as favorite contacts to the People tab. If there are no existing contacts, create them first on your device. See “Creating New Contacts” for instructions.

To add favorite contacts:

You can add up to 15 favorite contacts on the People tab.

Note SIM contacts cannot be added as favorite contacts.





1. On the Home screen, slide to the People tab.
2. Tap an empty slot. (If slots are occupied, scroll down the screen to find more available slots.)
3. Scroll down the contacts list to find the contact that you want to add to the People tab. If you have a long list of contacts, you can filter the list first by entering the first few letters of the person's name in the text box on top of the contacts list.
4. When you find the contact that you want, tap the contact name.
5. Select a phone number or email address to use when calling or sending a message to the selected contact.
6. If this contact does not have an associated photo, the subsequent screen lets you take a photo of the contact or select an existing photo.
7. If you selected the contact photo and it has a large size, you need to crop the photo. On the subsequent screen, a crop box appears on the photo. Center this box on the person's face and then tap **Done**.

Tip To remove favorite contacts from the People tab, tap **Menu** > **Remove Favorite**, tap the photos of the contacts you want to remove, and then tap **Done**.

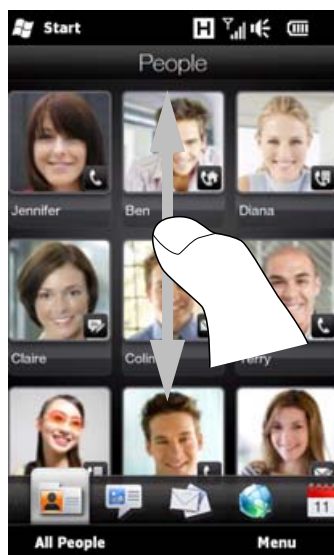
Quickly Calling or Sending a Message to a Favorite Contact

On the Home screen's People tab, the following icons are shown on each photo to indicate the type of contact method that is associated to each favorite contact.



-  Call the contact's mobile phone.
-  Call the contact's work/office phone.
-  Call the contact's home phone.
-  Compose and send a text message.
-  Compose and send an email message.

Scroll through your favorite contacts by swiping your finger up or down the screen. Place a call or create a new message to send to a favorite contact by simply tapping the person's photo.

The icons shown depend on available contact information. For example, the home phone icon () is shown only if the stored contact information includes a home phone number.

Tip To remove the current favorite contact, tap **Menu > Remove Favorite**.

The People Screen

Tap **All People** on the Home tab or People tab to display the People screen where you can view and manage all your contacts. The People screen has the following tabs:

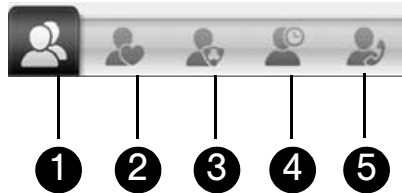

1. **All**. Lists all contacts on your device and on the SIM card. This tab lets you create, delete, or edit a contact, import SIM contacts to your device, or save a contact to your SIM card. Tap a contact to open the Contact Details screen. You can also use this tab to open or update My Contact Card.

Tip If you imported SIM contacts to your device and duplicated contacts are displayed, tap **Menu > View > Contacts** to filter and display only contacts stored on your device.

2. **Favorites**. Shows the favorite contacts that you have added to the People tab. You can also add favorite contacts through this tab.
3. **Groups**. Allows you to create groups of contacts so that you can easily send text, multimedia and email messages to a group of people without having to enter each contact one at a time. See “Contact Groups” on page 44 for details.
4. **Updates and Events**. Displays notifications when there are updates that occurred in Facebook. This tab also shows events of your stored contacts. See “Facebook Updates and Events” on page 44 for details.
5. **Call History**. Lists all your dialed numbers, and received and missed calls. See “Call History” on page 69 for details.

Browsing and Finding Contacts

On the People screen's All tab, swipe upward or downward on the screen to scroll through the contacts list. You can also use the search box or the Quick Scroll bar to search for a certain contact.

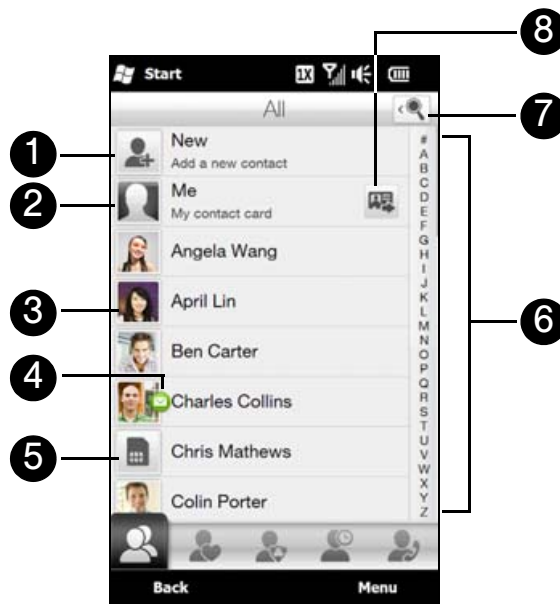

1. Tap **New** to add a new contact. See “Creating New Contacts” on page 39 for details.
2. Tap **Me** to edit your own contact information. See “Setting Up My Contact Card” on page 38 for details.
3. Tap a contact to open the Contact Details screen.
4. An icon appears on a contact when:
 - You receive a new text or email message, or when you have a missed call from the contact.
 - The contact has updated his or her Facebook profile or added events in Facebook.
5. This icon represents a SIM contact.
6. To quickly scroll down through the contacts list, touch and hold the Quick Scroll bar and then slide your finger downward.
7. Tap the search icon to display the search box so you can find a contact by entering the contact name.
8. Tap this icon to send My Contact Card as an attachment in a multimedia message.

The Contact Details Screen

When you tap a contact name in the *All* tab of the People screen or tap the picture of a favorite contact on the center screen of the People tab, the Contact Details screen opens. From this screen, you can view the contact's details, exchange of messages and calls with the contact, and more.

The Contact Details screen has the following tabs:



1. **Details.** Shows a contact's details. From this tab, you can call the contact, send a text or email message, edit the contact details, delete the contact, or save the contact to your SIM card.
2. **Messages.** Displays exchanged text and multimedia messages with the contact. You can also reply with a text message directly on this tab.
3. **Email.** Displays all received email messages from the contact.
4. **Updates and Events.** Displays notifications when the contact has updates on his or her Facebook account. This tab also shows events of the contact. See "Facebook Updates and Events" on page 44 for details.
5. **Call History.** Lists all your incoming, outgoing, and missed calls to and from the contact. This tab also lets you call the contact and delete the phone logs of the contact. See "Call History" on page 69 for details.

Changing the Number for Sending Text and Multimedia Messages

By default, the number that's entered to the Mobile field in the contact details is the primary phone number to which your text and multimedia messages are sent when you tap **Send Message** on the Contact Details screen.

If a contact has two or more mobile phone numbers for personal use and work, you can change the primary phone number on the Contact Details screen for sending messages to the contact.

1. On the Home screen, slide to the People tab and then tap **All People**.
2. Tap a contact from the contacts list.
3. On the Contact Details screen, tap the **Change number** button () that appears on the right side of the Send Message item. On the subsequent screen, tap another phone number to use for sending text messages to the contact.

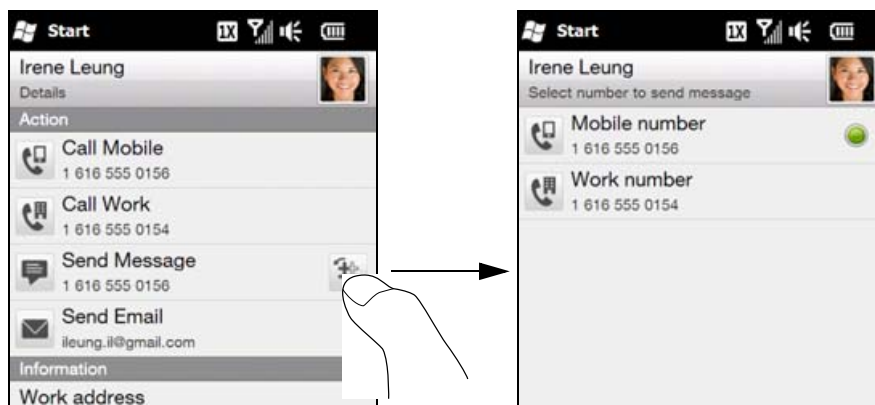



4. A new message is then created. Compose and send your message. (For more information about sending text and multimedia messages, see Chapter 7.)

Contact Groups

By organizing contacts into groups, sending messages to several contacts is a lot easier. Using groups to categorize contacts is also a way of filtering the contacts list so that browsing and finding contacts can be faster and easier.

To create a contact group

1. Create a group of contacts so you can easily send a text or multimedia message to the group without having to add the addressed contacts to your message one by one.
2. On the Home screen, slide to the People tab and then tap **All People**.
3. Tap or slide to the **Groups** tab ().
4. Tap **New**. Enter a group name and then tap the Contact Photo icon () to assign a photo to the group.
5. To add contacts to this group, tap **Add**. Select the contacts you want to add to the group and then tap **OK**.
6. Tap **Done**.

To send a text or multimedia message to a group

When sending a text or multimedia message, by default, the message will be addressed and sent to the Mobile number of each contact in the group. For more information about sending text and multimedia messages, see “Text Messaging (SMS)” on page 137 and “Video and Picture Messaging (MMS)” on page 140.

To filter a contacts list by group

If you have a long list of contacts, you can more easily browse and find the contacts that you want by filtering the list to display only a certain group of contacts.

1. On the Home screen, slide to the People tab and then tap **All People**.
2. Tap **Menu > Filter**.
3. Select the group name that you want and then tap **Done**.

Facebook Updates and Events

If you and your stored contacts have Facebook accounts and you linked to Facebook when you were creating My Contact Card, you can easily check which of your contacts have updates that occurred in Facebook. The types of Facebook updates include changes in profile information and status as well as new photos added to the Facebook album.

You can also easily check which contacts have events that occur on the current day. The types of events include the birthday and anniversary, if specified and stored on the contact details, as well as events that are created in Facebook.

Logging In and Out of Facebook

Easily log in or out of your Facebook account from the Home screen’s Settings tab.

1. On the Home screen, slide to the Settings tab.
2. Tap **Data services**.
3. If you are not connected to your Facebook account, tap Facebook, enter the email address and password that you use for your Facebook account, and then tap **Login**.
4. To log out of Facebook, tap the Off/On switch that appears to the right of the Facebook option. Tap OK to confirm and log out.

Checking for Contacts Who Have Facebook Updates and Events

You can check for Facebook updates and events of contacts from one convenient location, which is on the *Updates and Events* tab of the People screen.

1. From the Home screen, slide to the People tab and then tap *All People*.
2. Tap the *Updates and Events* tab ().
3. If you haven't linked your stored contacts to Facebook, the Updates and Events tab will show a *Link Profiles* option. Tap this option, choose which contacts you want to link to Facebook, and then tap *Done*.
4. To check what Facebook updates you have, tap *Me* while you're on the Updates and Events tab. On the My updates screen, you'll then see the different types of updates, such as unread poke, unread message, unread event invite, and more. Tapping a type of update opens the Web browser and brings you to your Facebook site where you can view the update details.
5. In the *Events* list of the Updates and Events tab, you'll see the events of your contacts, such as someone's birthday or anniversary. Tap a contact in this list to open the Web browser so you can view more details about that contact's events.
6. When you tap a contact in the *Updates* list, you will see the complete status message of the contact and other Facebook updates of the contact.

Notes

- To manually refresh and display the latest Facebook updates, tap *Menu > Update Now*.
- To enable the Facebook updates to be refreshed automatically, tap *Menu > Settings* and then select the *Download data automatically* check box. The refresh is not instant. Your device checks from Facebook in a fixed time period.

Checking a Single Contact's Facebook Updates and Events

To check only for a single contact's Facebook updates and events, you can select the contact from the contacts list first and then go to the Updates and Events tab from the Contact Details screen.

1. From the Home screen, slide to the People tab and then tap *All People*.
2. Browse through the list of contacts and then tap a contact to open the Contact Details screen.
3. Tap the *Updates and Events* tab ().
4. In the *Events* list, tap a Facebook event to open the Web browser and view more information about the event.
5. In the *Updates* list, tap a Facebook update to open the Web browser and view details of that update.

Updating Your Status in Facebook

You can change your status in Facebook directly from your own contact card.

1. On the *All* tab of the People screen, tap *Me* to open My Contact Card.
2. Scroll to the bottom of the screen and then tap the button that displays your Facebook name.
3. Enter your new status and then tap *Share*.

Mail

The **Mail** tab is where you send and receive email messages. Including Outlook Email, you can add up to seven POP3/IMAP4 and Web-based email accounts in this tab. For instructions on how to set up email accounts in the Mail tab, see “Email Messaging” on page 164.

Checking and Reading Email

The icon on the Mail tab and the respective icons of your email accounts show the number of newly received or unread email messages. Select an email account and then swipe your finger up or down on the center screen to browse through received email messages.

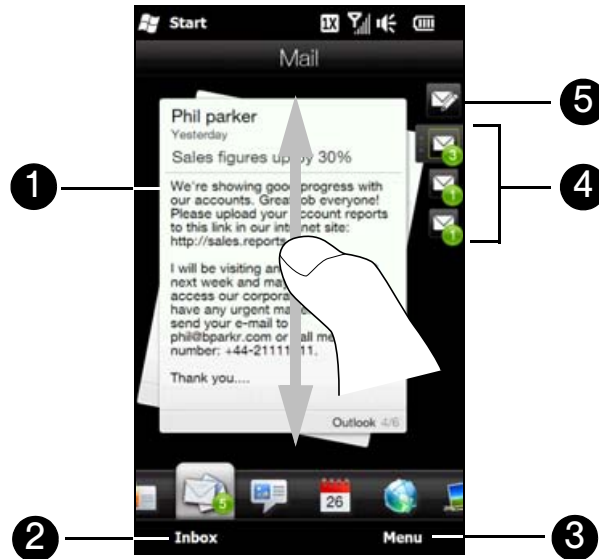

1. Tap the email on the screen to open and read the message.
2. Tap **Inbox** to access all email messages of the currently selected account.
3. Tap **Menu** to choose whether to add an email account, send and receive email, and more.
4. These are your email accounts. When you have newly received or unread email messages, the icon on the Mail tab and the respective icons of your email accounts will show the number of new email messages.
To select an email account:
 - Tap an email account icon to view the email messages in that account.
– or –
 - Touch and hold the icon of the email account that is currently displayed, and then drag your finger up or down the account icons until the desired email account is selected.
5. After selecting an email account, tap this icon to create and send a new email message.

For more information about working with email, see “Email Messaging” on page 164 and “Working With Company Email and Meeting Appointments” on page 168.

Making Calls Directly from an Email Message

You can directly call the sender of the email message that is currently shown on the Mail tab by pressing the **Talk** key.

For more information about directly making calls while viewing email, see “Making a Call from an Email Message” on page 71.

Messages

Quickly browse through and read text messages as they arrive directly from the **Messages** tab. This tab also displays received multimedia messages. An attachment icon is shown to indicate that a received message is a multimedia message. You only see the subject of the multimedia message.

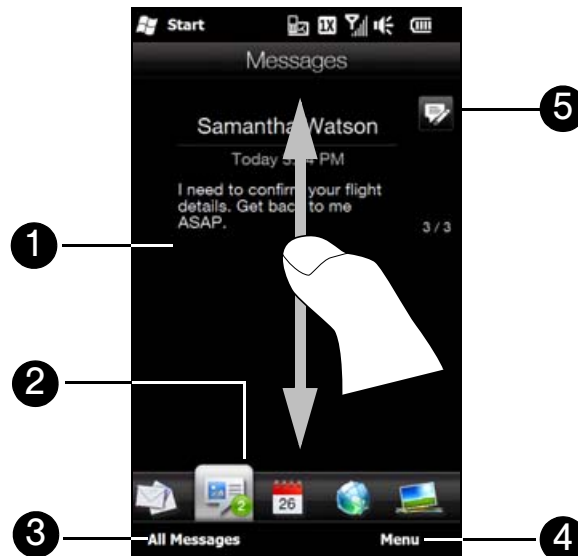

1. Tap the text message to open the Messages tab of the Contact Details screen where you can view all received text messages from the contact and reply to the sender.
2. The icon on the Messages tab shows the number of unread text messages.
3. Tap **All Messages** to access all text messages in your inbox and other folders.
4. Tap **Menu** to choose whether to remove the current message and access more options.
5. Tap the **New** icon to create a new text message.

For more information about working with text messages, see “Text Messaging (SMS)” on page 137.

Making Calls Directly from a Text Message

While reading a text message on the Messages tab, you can directly call the sender of the text message by pressing the **Talk** key.

For more information about making calls while viewing text messages, see “Making a Call from a Text Message” on page 70.

Calendar

Keep track of your important appointments and events with the calendar.

The **Calendar** tab displays a monthly calendar with markers to inform you of the dates that you have appointments and events. You can also change the tab to display in day, week, year, or agenda view.

Note *Agenda view displays appointments for the next seven days, including the current day.*

Creating an Appointment

You can create appointments for the current day which is highlighted on the month calendar, or you can select another date for creating your new appointments.

1. On the Home screen, slide to the Calendar tab.
2. If you are creating an appointment for the current date, tap **Menu > New**. Otherwise, tap another date on the calendar, and then tap **New Appointment**.

Note *To select another month in the calendar, swipe our finger up or down the screen. You can also tap the Up or Down arrow shown beside the month and year.*

3. Enter a name for the appointment in the **Title** box and the location.
4. Set the **Start** and **End** dates and times.
Otherwise, if it is a special occasion such as a birthday or a whole-day event, select the **All Day** check box.
5. Under **Reminder**, choose how soon before the appointment you want to be notified.
6. Select the type of category for the appointment so that it can be grouped with other related appointments. Tap the box under **Category**, and then select a preset category (Business, Holiday, Personal, or Seasonal).
7. Fill in other details of the appointment.
8. When finished, tap **OK** to return to the Calendar tab.

Viewing and Managing Your Appointments

In month view, the highlighted date indicates that it is the current date. Dates with appointments are indicated by a triangle () at the upper-right corner of the date box.

To change between different calendar views

On the Calendar tab, tap **Menu** and then choose whether to display the calendar in **Agenda**, **Day**, **Week**, **Month**, or **Year** view.

To check your appointments

To check what appointments you have during a certain date, tap a date on the month calendar. The Calendar tab then changes to Day view and displays all your appointments and the weather information for that day.



Note The weather information appears only if you have set your local time to a city on the World Clock tab, and if the appointment date is within the 5-day forecast on the Weather tab. See “World Clock” on page 36 and “Weather” on page 56 for details.

In Day view, tap an appointment to view complete details of that appointment. On the subsequent screen, you can tap **Menu** to choose whether to edit or delete the appointment.

When in month view, swipe your finger up or down the screen to display the next or previous month on the calendar. You can also tap the Up and Down arrows that appear on the left and right sides of the month.

Tip

- Your upcoming appointments also appear on the Home tab. See “Home” on page 35 for details.
- You can also use the Windows Mobile Calendar program to create, view, and send appointments. To open the Calendar program, tap **Start > Outlook > Calendar**. For more information about using Windows Mobile Calendar, refer to the “Help & How-To” topics on the Windows Mobile website.

Internet

On the *Internet* tab, you can browse the Web and search for information.

Navigating the Web

The Internet tab uses Opera Mobile™ as the Web browser.

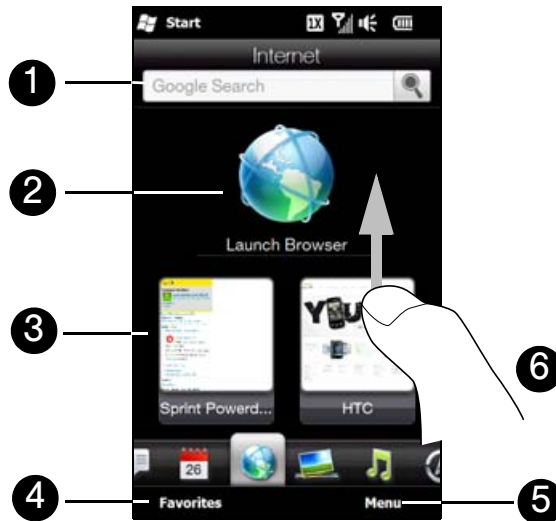

1. To search for information on the Web using Opera Mobile, enter your text in the provided text box and then tap the **Search** icon ().
2. Tap the globe image or tap **Launch Browser** to browse the Web using Opera Mobile.
3. Tap a Favorite shortcut to open the website.
4. Tap **Favorites** to add, view or delete Web favorites in Opera Mobile.
5. Tap **Menu** and choose whether add or delete a Favorite shortcut.
6. Swipe your finger upward when you need to scroll down the screen.

Note When you open a Web page in Opera Mobile, the page may be displayed in its smallest size. To reformat Web pages to fit the screen of your device so that the content is readable, set Opera Mobile to display in **Mobile View**. Tap , tap **Settings > Display**, and then select the **Mobile view** check box.

For more information about navigating the Web with Opera Mobile, see “Using Opera Mobile” on page 151.

Adding Web favorites

To quickly access frequently-visited websites, you can add them as Web favorites to the Internet tab. You can add up to 10 Web favorites.

1. On the Internet tab, tap an empty slot and then tap Add Favorite.
2. Enter a title and the website address, select a folder in which to save the favorite, and then tap **Done**.

When the first two slots are occupied, swipe your finger up on the screen to access more slots for adding Web favorites

Photos and Videos

The *Photos & Videos* tab lets you flip through your photos and video clips and view them full-screen. From this tab, you can also launch the camera so you can take pictures and record video clips.

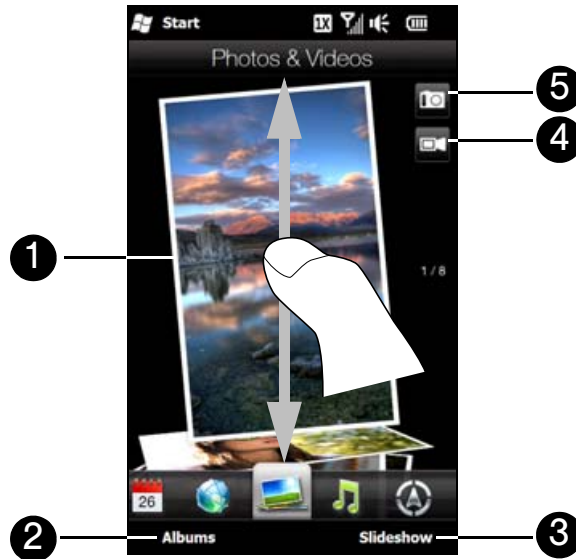

1. To flip through photos and videos, swipe your finger up or down the screen. Tap the photo or video on the screen to view or play it full-screen.
2. Tap *Albums* to open the Albums program. See “Viewing Photos and Videos” on page 112 for details.
3. Tap *Slideshow* to view the photos as a slideshow. If a video is selected, tap *Play*.
4. Tap the video camera icon to shoot video.
5. Tap the camera icon to take a photo.

Tips

- The file formats that can be viewed on the Photos & Videos tab are the same as the Albums program.
- To transfer media files from a computer and view them on the Photos & Videos tab, copy or synchronize them to a folder under \My Device (the device memory) or \Storage Card.

Setting an Album as a Favorite

The Photos & Videos tab displays pictures and video files from the current favorite album. By default, the Camera Shots album, which stores the pictures and videos that you captured using the device camera, is set as the favorite. You can change to another favorite album, if preferred.

1. On the Photos & Videos tab, tap *Albums* to open the Albums program.
2. Tap *Albums* and then select one of the listed favorite albums.
3. Tap *Menu > Set Album as Favorite*. and then tap *OK* on the confirmation screen.

Sprint Music

The **Sprint Music** tab allows you to visually browse through albums and music tracks that are on your device and play music. The albums and music tracks that you see on this tab are from the **Now Playing** list of the Library.

Note Your device searches for all music files that have the following audio formats: MP3 (.mp3), WMA (.wma), AAC/AAC+ (.aac), and MPEG-4 (.m4a). It searches for music from the following locations:
Device: My Music (including all subfolders)
My Documents (including all subfolders)
Storage: \Storage Card (including all subfolders)

From the Sprint Music tab, you can also access the Sprint Music Store to purchase and download music. For more information about purchasing and downloading music onto your device, see “Music – Sprint Music Store” on page 178.

Playing Music

- ▶ On the Sprint Music tab, swipe your finger up or down the screen to browse through all music tracks stored in your device and storage card and find the music that you want.



1. Tap to update album covers. (You can also tap **Menu** > **Update Album Art** and choose what to download and update.)

Note Updating album covers may result in additional data charges.

2. Touch and hold the thin bar below the album art to display the progress bar. Drag your finger right or left on the progress bar to move forward or backward in the current track.
3. Tap the **Previous** button to go to the previous music track.
4. Tap **Library** to access the Library. See “The Library” on page 53 for details.
5. Tap **Menu** to set music playback to repeat, turn shuffle on or off, and more. You can also tap **Sprint Music Store** to download music from Sprint Music Store. See “Music – Sprint Music Store” on page 178 for details.
6. Tap the **Next** button to go to the next music track.
7. Tap the **Play** button to play or the **Pause** button to pause playback.

8. Shows whether shuffle mode is on or off.
9. Shows the repeat mode (Repeat All, Repeat One, or Repeat Off).

To advance forward or backward in the music:

- ▶ Touch and hold on the thin bar below the album art to display the progress bar:



Drag your finger right or left on the progress bar to move forward or backward in the current music track.

To set repeat and shuffle modes:

The icons on the upper-right side of the Sprint Music tab show whether repeat and shuffle modes are enabled.



- Tap **Menu > Repeat** and choose whether to repeat the current track, repeat all tracks in the current album or playlist, or do not repeat.
- To turn shuffle mode on or off, tap **Menu > Shuffle**.

The Library

The Library organizes music into categories, such as **Now Playing**, **Artists**, **Albums**, **Genres**, **All Songs**, and more. When you add more albums or music tracks to your device, go to the Library to locate and play the new albums or music tracks.

To browse and play music in the Library:

1. On the Sprint Music tab, tap **Library** to open the Library screen.
2. The tabs at the bottom of the Library screen correspond to the different categories. To browse music under a certain category, slide to the tab that corresponds to the desired category.
3. Keep tapping an item on a category tab (for example, an artist) until the music tracks display on the screen.
4. Tap a music track to play it.

Note When you select a category in the Library such as Artists and play its music, the Now Playing list will be replaced with the music tracks from that category.

Playlists

You can group your favorite music into a playlist and then play back the playlist.

Types of Playlists

There are two types of playlists that can be shown on the **Playlists** tab:

- **Custom playlists.** Playlists that are created on the Sprint Music tab.
- **Windows Media Player playlists.** Playlists that are in Windows Media Player Mobile's Library (which is synchronized with Windows Media Player on your computer). They are indicated by the Windows Media Player icon (). These playlists cannot be edited.

Note If a Windows Media Player playlist contains a combination of music, video and image files, only music files in the playlist will be synchronized to your device and other media types will be filtered out.

To create a new playlist:

1. On the Sprint Music tab, tap **Library**.
2. Tap or slide to the Playlists tab.
3. Tap **Menu > New**, enter a playlist name, and then tap **Done**.
4. On the **Playlists** screen, tap the playlist you have just created, and then tap **Add Songs**.
5. On the subsequent screen, tap or slide your finger across the tabs to select a category. For instance, to select music tracks from a certain album, tap the **Albums** tab and then tap the album that you want.
6. Select the check boxes of the music tracks that you want to add to your playlist, or tap **Menu > Select All** to choose all the music tracks.
7. Tap **Done**.
8. Tap **Add Songs** again and repeat step 5 to 7 to add more music tracks. When you have finished adding music tracks to your playlist, tap **Back** to return to the Playlists screen.

To play back a playlist:

1. On the Sprint Music tab, tap **Library**.
2. On the **Playlists** tab, tap a playlist to open it.
3. Tap the first track in the playlist. The Sprint Music tab starts playing the first track. After each track, the next one in the playlist will be played.

Note Playlists are not automatically updated when music files have been deleted from the device memory or the microSD card.

Sprint Navigation

The **Sprint Navigation** tab allows you to connect to Sprint's wireless data network and use GPS navigation services. If this is your first time to use Sprint Navigation, tapping any of the icons on this tab will prompt you to log into the Sprint Navigation service.



For more information about using Sprint Navigation, see “Using Sprint Navigation” on page 189.

Sprint TV

On the *Sprint TV* tab, you can watch live TV and catch up on episodes of your favorite shows – anywhere on the Nationwide Sprint Network.

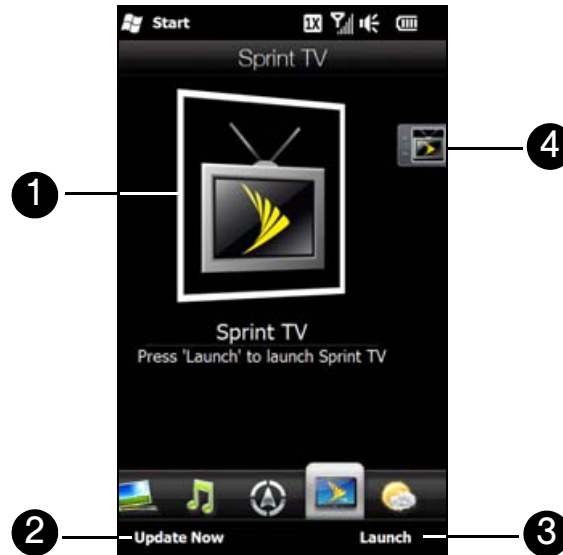

1. If this is your first time to use Sprint TV, tap the center image to connect to Sprint data services using the data connection and download channels. Afterwards, tap the displayed channel on the center of the screen to watch the channel.
2. Tap **Update Now** to download the latest preset channel list from Sprint.
3. Tap **Launch** to open the Sprint TV application so you can connect to Sprint data services, access all available channels, and choose to which channels you want to subscribe.
4. Preset channel selections are listed on the strip at the right side of the screen.

To watch a preset channel:

- ▶ Tap the icon on the right that corresponds to the desired channel.
— or —

Touch and hold on the highlighted channel icon to display a slide-out bar, and then slide your finger up or down. Release your finger when you have selected the desired channel.

For more information about using Sprint TV, see “TV” on page 176.

Weather

Your device automatically connects to the Internet to download weather information. On the **Weather** tab, it displays the weather information of your current location and other preselected cities. The current day's weather as well as the weather conditions for the next four days of the week are displayed.



1. Swipe your finger up or down the screen to view the weather in other cities.
2. Tap **Update Now** to download the latest weather information.
3. Tap **Menu** to add or delete a city, change the temperature to Celsius or Fahrenheit, and more. You can also tap **Enable My Location** to allow the device to download the weather for your location.
4. Shows the last weather update. Tap this item or tap **Update Now** at the bottom-left side of the screen to download the latest weather information.

Note Tap **More Detail Online** to open the Web browser and view more weather information on the website. (This option is not available when you are viewing the weather for your current location.)

Adding a City

1. On the Weather tab, tap **Menu > Add Location**.
2. On the **Add Location** screen, enter the first letters of a country or city name. The screen then displays a matching list of locations. Scroll through the list and then tap the name of the desired city.

Your device then downloads the weather information of the city that you selected and adds it to the Weather tab.

Weather Settings

You can change the displayed temperature to Celsius or Fahrenheit on the Weather tab. You can also enable or disable auto download options and change the download time.

1. On the Weather tab, tap **Menu** and then choose whether to display temperature in Celsius or Fahrenheit.
2. To change other weather settings, tap **Menu > Settings** and then choose from the following options:
 - **Download weather automatically.** When this option is selected, weather information is automatically downloaded at the set download time whenever you select the Weather tab.

To change the download time, tap the box that shows the preset time and then choose another time interval. Clear this option if you prefer to manually download weather information.

- **Download weather when roaming.** Select this option only if you want to allow automatic download of weather data when roaming. This may incur additional data charges.

Stock

The **Stocks tab** allows you to add, view, and analyze stocks and stock market movements using updated financial information.

Note Downloading stock or stock market information may incur additional fees from your mobile operator. Contact your mobile operator for details.

Adding Stock Quotes

1. On the Home screen, slide to the Stocks tab and then tap **Menu > Add Stock**.
2. On the Add Stock screen, enter the company name, stock market index, or ticker symbol in the search box, and then tap the Search button ().
3. Matched search results will then be displayed. Swipe upward to scroll down the screen and access more search results.
4. Tap the company name, stock market index, or ticker symbol to display it on the Stocks tab.
5. On the Add Stock screen, enter the company name, stock market index, or ticker symbol in the search box, and then tap the **Search** icon
6. To add another stock quote or stock market index, repeat steps 1 to 3.

Viewing Stock Information

The Stocks tab lists all your stock quotes and stock market indexes including the current price or volume, and the change in price or volume from the previous trading day. The change in price or volume box indicates whether the stock or stock market has gained (green) or declined (red).



1. Tap the stock quote or stock market index name to view its intraday chart and other details. Swipe your finger upward to scroll down the list of stock quotes on the Stocks tab.

2. Tap **Menu** to add, delete or rearrange the stock quotes and market indexes. (When rearranging the list, drag items up or down the list to change their order.)
3. Shows the current trading price or volume.
4. Tap the green or red box to switch between showing the change in points/price or percentage from the previous trading day.
5. Shows the last stock information update. Tap this item or tap **Update Now** at the bottom-left side of the screen to download the latest stock information.

Twitter

Share your thoughts with people in Twitter anytime, anywhere. Directly from your Home screen's **Twitter** tab, it is simple and convenient to use this popular Internet social networking service.

Logging in to Your Twitter Account

If you do not have a Twitter account yet, you can sign up for free on the following Twitter website using your computer or your device's Web browser: <http://twitter.com/signup>.

1. On the Home screen, slide to the Twitter tab, and then tap the Twitter icon () on the center screen.

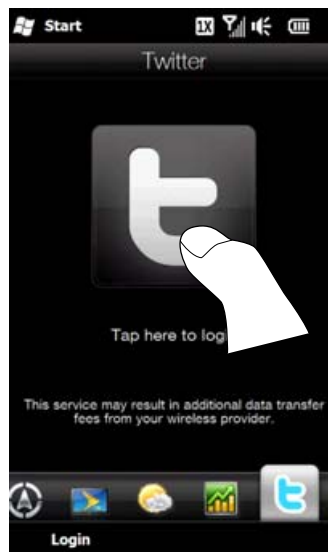

2. Enter the user name or email address and the password that you use for your Twitter account.
3. Tap **Login**.

Once you are logged in, you're ready to send and follow tweets on your device.

Viewing Tweets

On the Home screen's Twitter tab, you can see tweets of the people that you follow and your sent tweets, starting with the most recent. Swipe your finger up or down the screen to scroll through the tweets.



- To use more Twitter functions, tap any tweet or tap **All Tweets** at the bottom of the screen.
- The All Tweets screen opens, listing all tweets organized by date. Tap a tweet to access more Twitter functions, such as sending replies or direct messages, viewing someone's profile, and more.



You can also tap or slide across the tabs on the bottom row to change among the following types of tweets:

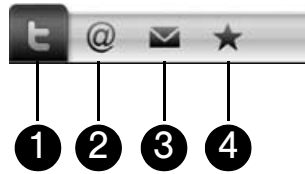

1. Shows tweets from all the Twitter users you follow and the tweets that you sent grouped by date.
2. Shows only tweet responses that people addressed to you.
3. Shows private messages sent to you.
4. Shows tweets you have marked as favorites.

Sending Tweets

You can send tweets either from the Home screen's Twitter tab or from the All Tweets screen.

1. Tap the text box that shows the words "What are you doing?"
2. On the subsequent screen, enter your tweet message.
3. In your tweet, you can also share your photo and location information. See "Sharing a Photo in Twitter" on page 61 for details.
4. Tap **Update** to send your tweet.

Sending Mentions and Direct Messages

A mention (reply) is just the same as any tweet message, except that it's specifically addressed to a person and his or her name will appear in your sent tweet. Whereas a direct message is a private message sent to someone and cannot be seen by everyone else in Twitter.

1. On the Home screen, slide to the Twitter tab and then tap **All Tweets**.
2. Tap a tweet from the person whom you want to send a reply or direct message.
3. In the Options menu, choose the type of tweet (**Reply** or **Send Direct Message**) you want to send.
4. Enter your message and then tap **Update** to send it.

Searching for Twitter Users to Follow

You can search for people or topics of interest and follow them so you can readily see their latest tweet updates on your device.



1. From the Home screen's Twitter tab or the All Tweets screen, tap **Menu > Search**.
2. Tap the text box that shows the words "Search tweet". Enter the Twitter username or a search keyword, and then tap the **Search** button ().
3. From the search results, tap the photo of the person or topic you want to follow.
4. The Profile screen is then displayed, showing details about the person or topic. Tap **Follow**.

If you want to stop following a certain Twitter user or topic, go back to the All Tweets screen, tap the photo of that user or topic, and then tap **Unfollow**.

Sharing a Photo in Twitter

Photos that you share on Twitter are uploaded to a photo hosting service that's specified in your device's Twitter settings. To find out how to select the hosting service, see "Changing Twitter Settings" on page 61.

You can upload only one photo at a time. Create a new tweet first, and then select a photo or use the Camera to take a photo. The URL location of your photo will be inserted into your tweet message.

1. Create a new tweet. See "Sending Tweets" on page 60 for instructions.
2. On the screen where you've entered your tweet message, tap the Camera button ().
3. Browse through your photos. If you do not see the photo that you want, tap **Albums** and select the album that contains the photo you want to share.
4. When you see the photo that you want, tap the photo to select it. You can also tap the Camera icon () to take a photo using your device's Camera.
5. Your device then begins uploading the photo to the Twitter photo host. When the upload is done, the URL location of the photo is then entered to your tweet message.
6. Tap **Update** to send your tweet along with the URL of the photo so other people can see it in Twitter.

When you return to the Home screen's Twitter tab and tap All Tweets, you will see the sent tweet that contains the URL of your shared photo.

Changing Twitter Settings

On the Home screen's Twitter tab or the All Tweets screen, tap **Menu > Settings** when you want to change the number of tweets to download, download time, photo hosting site, URL shortening host, and more.

Logging Out of Twitter

While your device is connected to the Internet, you're always logged on to your Twitter account on your device. You can log out of Twitter from the Home screen's Twitter tab.

1. On the Home screen, slide to the Twitter tab.
2. Tap **Menu > Settings**.
3. To log out, tap your Twitter account name and then tap **Yes**.

Tip

You can also log out of Twitter from the Home screen's Settings tab. From this tab, tap **Data services**, tap the **Twitter Off/On** switch, and then tap **OK**.

Settings

Changing or tweaking settings is as easy as one-two-three. With the device settings neatly organized on the Settings tab and labeled with clear descriptions, you can easily find what you are looking for and just tap your way to the setting you want to change.

For more information about changing device settings, see “Settings on Your Device” on page 122.



Using Phone Features

- ◆ *Displaying Your Phone Number (page 63)*
- ◆ *Making Calls from the Phone Screen (page 63)*
- ◆ *Making Calls from the Home Screen (page 66)*
- ◆ *Answering and Ending Calls (page 66)*
- ◆ *In-Call Options (page 67)*
- ◆ *Checking Missed Calls (page 69)*
- ◆ *Call History (page 69)*
- ◆ *Speed Dial (page 70)*
- ◆ *Straight Talk (page 70)*
- ◆ *Turning the Phone On and Off (page 73)*
- ◆ *Phone Services (page 74)*

The same as with a standard mobile phone, you can use your device's phone to make, receive, keep track of calls, and send text messages. This section will show you how to use the phone features of your device.

Displaying Your Phone Number

In case you forget what your phone number is, you can check your number from the Phone screen.

1. Press the **Talk** key to display the Phone screen.
2. Tap **Menu > My Phone Number**. (Your phone number and account information will be displayed.)

- | | |
|--------------|---|
| Notes | <ul style="list-style-type: none">• To view information about your device, tap Menu > Device Information on the Phone screen.• Your Sprint phone number is the same for both CDMA and GSM (international roaming). |
|--------------|---|



Making Calls from the Phone Screen

The Phone program's *Smart Dial* feature makes it easy for you to call a phone number or contact. When you start entering a phone number or contact name, Smart Dial automatically searches and sorts the contact entries in Contacts and the phone numbers in Call History (including incoming, outgoing, and missed calls). You can then select the desired number or contact to call from the filtered list.

You can enter the first letter of the name or number of a contact. Smart Dial will search for contact phone numbers and the first character of a contact name as well as from the character that appears after a space, dash, or underscore in a contact name. For example, if you tap **2**, which is associated with [a, b, and c] on the Phone keypad, contact names such as "**B**en Miller," "George **A**dams," "John-**C**arter," "**C**arter, Ellen," "Dixon, Allan," "Thomas_**C**lark," "Jane**C**ampbell" would appear as matches.

If the matching list is long and you want to narrow down the search further, enter another letter. Using the same example above, if you continue to tap "3" which is associated with [d, e, f], the matching list will be narrowed down to the following names: "**B**en Miller," "George **A**dams," "**C**arter, Ellen," "**D**ixon, Allan."

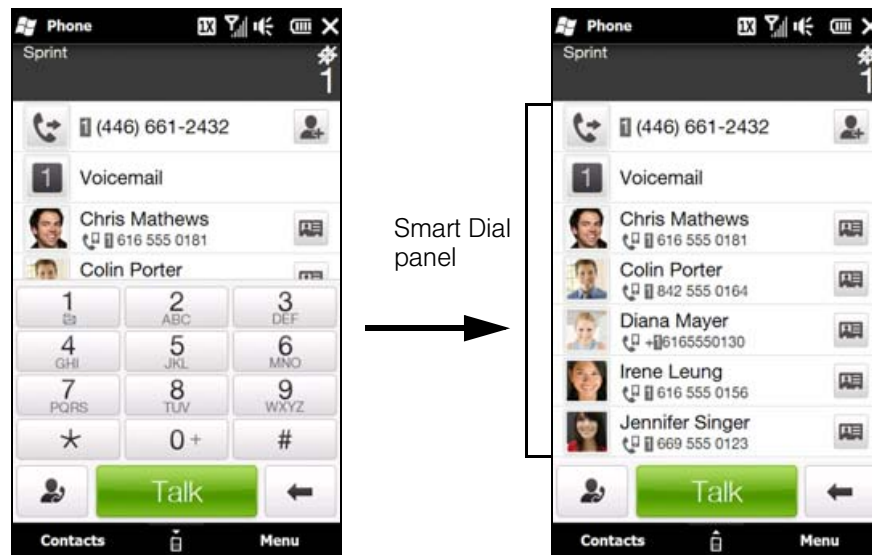

Calling a Phone Number or Contact

1. Press the **Talk** key to display the Phone screen.
2. Begin entering the first few numbers or characters by tapping the keys on the Phone keypad. As you enter numbers or letters, the Smart Dial panel will display matches found.
If you tapped a wrong number or character, tap  to erase each subsequent digit or character. To erase the entire entry, touch and hold .
3. Tap  to close the Phone keypad and to see if there are more matching numbers or contacts in the Smart Dial panel. To browse through the filtered list, flick through the list or slide your finger up or down the list slowly.



4. To call a number or contact, either:
 - Tap the desired phone number or contact from the list.
 - or —
 - Call a different phone number associated with the displayed contact by tapping the contact card icon () at the right side of the contact name. On the Contact Details screen, tap the number you want to call.

Tips

- When in a call, use the **Volume Up** or **Down** button on the side of the device to adjust the phone volume.
- After entering a digit and the phone number you are dialing is not found in your contacts, a **Save to Contacts?** button will appear above the Phone keypad. Tap it to save the number to your Contacts.
- To save a phone number listed on the Phone screen to your Contacts, tap .
- To send a text message to a contact listed on the Phone screen, tap his or her contact card icon () and then tap **Send Text Message**. For more information about sending text messages, see “Text Messaging (SMS)” on page 137.

Global Smart Dialing (International Calls)

When the Global Smart Dialing feature is enabled, placing international calls is a lot easier. You can preconfigure the country where you are calling from and the country to call to, and then simply enter the 10-digit number when placing your international call. Both the international access code and country code will automatically be prepended to the number.

Configuring Global Smart Dialing

To enable Global Smart Dialing and preconfigure the dialing codes:

1. Press the **Talk** key to open the Phone screen.
2. Tap **Menu**, scroll down the menu, and then tap **Global Smart Dialing**.
3. Select the **Enable Global Smart Dialing** check box.
4. By default, the international access code has already been set to that for the United States. You do not need to change it if you are making international calls from the United States.
However, if you are placing international calls from another country, select the country in which you are located from the **Dial from** list. If the country is not in the list, enter its international access code in the **International Direct Dialing Code** box.
5. Select the country you are calling from the **Dial to** list. The corresponding country code will appear in the **Country Code** box. (You cannot change the country code.)
6. Tap **Done**.

Note You can also configure Global Smart Dialing to automatically prepend the U.S. country code (1) when you place domestic calls. Select **United States** from both the **Dial from** and **Dial to** lists. When you place your call, you only need enter the 10-digit number.

Using Global Smart Dialing

To use Global Smart Dialing to place an international call:

1. On the Phone screen, directly enter the 10-digit number to call. This number includes the area code and phone number.
2. Tap  on the Phone screen or press the **Talk** key to place the call. Your device will dial the complete number including the international access code, the country code, and the 10-digit number.



Direct Dial

Note When Global Smart Dialing is not enabled, or when the number you want to call (area code and phone number) contains fewer than 10 digits, you need to use direct dialing to place international calls.

To use direct dialing to place an international call:

- ▶ Enter the international access code, the country code, the city or area code, and the phone number, and then tap  to complete the call.

Calling Voicemail

- ▶  is reserved for your voicemail. Touch and hold  on the Phone keypad to call voicemail and retrieve your voicemail messages. For more information about using voicemail, see “Voicemail” on page 134.

Making Calls from the Home Screen

You can add favorite contacts to the Home screen's People tab and easily place calls to your favorite contacts. See "Adding and Selecting Favorite Contacts" on page 40 for details.

From the Home screen's People tab, you can also access the complete list of stored contacts and select a contact to call. See "Browsing and Finding Contacts" on page 42 and "The Contact Details Screen" on page 43 for details.

Tip You can also use Windows Mobile's Contacts program to access your stored contacts and select a contact to call. See "Contacts" on page 82 for details.

Answering and Ending Calls

Your device notifies you of incoming calls in the following ways:

- The device rings or vibrates.
- The **Talk** key flashes a white light.
- The backlight illuminates, if your device was in sleep mode.
- The device displays the Incoming Voice Call screen. If the incoming call is from a phone number stored in your Contacts, the caller's name is displayed. The caller's phone number and picture may also be displayed, if available.

Accepting or Rejecting an Incoming Call

When there is an incoming call, you can choose to accept or reject the call.

To answer the call:

- ▶ Press the **Talk** key.

— or —

On the incoming call screen, slide the center button of the *Answer/Ignore* bar to the left.



Note If you receive a call when a password has been set and the device is locked, the onscreen buttons are unavailable except for **End** and **Unlock**. Tap **Unlock** to unlock the device and have access to the onscreen buttons.

To mute the ringing sound without rejecting the call:

- ▶ Tap **Mute Ring** when you receive an incoming call.

— or —

Press the **Volume Down** button.

— or —

Place your device face down.

To reject the call:

- ▶ Press the **End** key.

— or —

On the Incoming Voice Call screen, slide the center button of the *Answer/Ignore* bar to the right.

To reject a call and send a text message:

When you reject a call, you can choose to automatically send a text message to the caller.

1. On the Phone screen, tap **Menu > Options... > Advanced** tab.
2. Select the **Reject call with text message** check box.
3. Change the default text message if needed, and then tap **OK**.

When **Reject call with text message** is enabled, tap **Send Text** to reject the call and send the text message to the caller. To automatically send the text message, clear the **Edit text message before sending** check box.

Ending a Call

When a call is in progress, tap **End Call** or press the **End** key to hang up.

In-Call Options

When a call is in progress, use the onscreen buttons to turn on the speakerphone, put a call on hold, accept a second call and swap between the callers, set up a three-way call, and more.

For more information about starting a three-way call, see “Making a Three-Way Call” on page 142.

Putting a Call on Hold

1. Tap  or press the **Talk** key to take the second call, and put the first one on hold.
2. To end the second call and return to the first call, tap **End Call** or press the **End** key on your device.

Swapping Between Two Calls

▶ Tap .

— or —

Press the **Talk** key on your device.

Writing Down Notes While in a Call

1. Tap **Menu > Create Note** or pull out the stylus.
2. The Notes program automatically opens, with some information already entered in the notes, such as the caller name, phone number, and more. Use the sliding QWERTY keyboard or an onscreen keyboard to enter additional notes. For more information about using the sliding QWERTY keyboard and onscreen keyboards, see “Entering Text” on page 24.
3. When you have finished entering your notes, tap **OK** to save your notes.

The file is saved in the Notes file list. To open the program and locate your file, tap **Start > Outlook > Notes**. To learn more about using Notes, see “Notes” on page 86.

Turning the Speakerphone On or Off

During a call, do one of the following to turn the speakerphone on or off:

▶ Tap  to turn the speakerphone on. Tap this button again to turn the speakerphone off.

— or —

Place your device face down to automatically turn on the speakerphone. To turn the speakerphone off, place your device face up.



— or —

Press and hold the **Talk** key during a call to turn the speakerphone on or off.

Note The speakerphone icon () appears in the title bar when the speakerphone is on.

WARNING To avoid damage to your hearing, do not hold your device against your ear when the speakerphone is turned on.

Muting the Microphone During a Call

▶ Tap  to turn the microphone on or off. When the microphone is turned off, the mute icon () appears on the screen.

Turning Noise Reduction On or Off

When you are using the earpiece and not the speakerphone during a call, you can tap **Menu > Noise Reduction On** to reduce ambient noise if the other party cannot hear your voice clearly. When noise reduction is not needed, tap **Menu > Noise Reduction Off** to disable it and save battery power.

You can also turn noise reduction on or off in the Phone settings. Slide to the Settings tab, and then tap **Wireless controls > Phone > Advanced** tab. Select one of the following settings in the **Reduce noise in phone calls** drop-down list:

- **Automatically.** Analyzes ambient noise only at the beginning of a connected call and applies a certain noise reduction setting based on the detected noise. However, when you move to a noisier environment during the call, your device will not further decrease noise based on your new location.
- **Always.** Always reduces ambient noise during the entire course of your phone call.
- **Never.** Turns off noise reduction.

Notes

- If you want to change the noise reduction setting to **Automatically**, make sure to do this before starting a call.
- Noise reduction is not used when you have a wired or Bluetooth headset connected.

Checking Missed Calls

Missed Call Notification

The missed call icon () is displayed in the title bar when you missed a call.

To check who the caller was:

- ▶ On the Home screen, slide to the People tab, tap *All People*, and then tap the *Call History* tab (rightmost tab).

– or –

When you see the missed call icon () in the title bar, tap the title bar to open the Notifications screen, and then tap *Missed Call*.



– or –

Press the Talk key to open the Phone dialer and then tap *Menu > Call History*.

Call History

Call History shows you your incoming calls, outgoing calls, and missed calls. Call History makes redialing a number fast and easy. It is continually updated as new numbers are added to the beginning of the list and the oldest entries are removed from the bottom of the list.

Each entry contains the phone number (if it is available) and Contacts entry name (if the phone number is in your Contacts). An icon appears to the left of the number, and it indicates the type of call:

	<i>Missed.</i> These are incoming calls that you were not able to answer, and they are routed to your voicemail.
	<i>Received.</i> These are incoming calls that were answered.
	<i>Dialed.</i> These are outgoing calls that you made.

Notes

- *Call History* records only those calls that occur while the device is turned on. If a call is received while your device is turned off, it will not be added to the *Call History*.
- If you have a long list of calls in the *Call History* tab, tap *Menu > Filter* and then select the type of call that you want to display.
- To view the exchange of calls with a particular contact only, tap the *Contact Card* button () that appears to the right of the contact.

To make a call from *Call History*:

- ▶ Tap a phone number you want to call.

To delete *Call History* entries:

- ▶ Tap *Menu > Delete* and select the *Call History* entries you want to delete and then tap *Done*.

Tip

To delete all *Call History* entries, from the *Delete Call History* screen, tap *Menu > Select All*, and then tap *Done*.



Speed Dial

Use *Speed Dial* to call frequently-used numbers with a single tap. For example, if you assign a contact to the location 2 in Speed Dial, you can touch and hold  on the Phone keypad to dial the contact's number.

To create a Speed Dial entry:

1. Tap **Talk** to open the Phone dialer screen.
2. Tap **Menu > Speed Dial**.
3. Tap **Menu > New**.
4. Tap a contact, and then select the phone number of the contact that you want assigned to the speed dial key.
5. In **Location**, select an available key to use as the speed dial key.
6. Tap **OK**.

Notes

- Number  and  keys are reserved and cannot be assigned as speed dial keys. The number  key is reserved for voicemail. You can set any number between "2" and "99" as a speed dial key.
- When you assign a new phone number in an occupied speed dial key, the new phone number will replace the existing one.
- To delete a speed dial entry, in the **Speed Dial** list, touch and hold the desired entry, and then tap **Delete**.

To make a call using Speed Dial:

If you have assigned a speed dial key to a contact, do the following to dial the contact's number:

- ▶ Touch and hold the assigned key, if it is a single-digit speed dial number.
 - or –
- To dial a two-digit speed dial number, tap the first number key first, and then touch and hold the second number key.

Straight Talk

Your device features Straight Talk™, a technology that integrates messaging, voice call, and three-way calling. With a dual microphone and speaker that enhance voice quality and reduce noise, Straight Talk turns your device into a conference room speakerphone system.

Making a Call from a Text Message

While you are viewing a text message on the Messages tab or in the Inbox, you can directly call the sender of the message.

1. While viewing the text message, press the **Talk** key.
2. The Phone screen then opens, with the sender's phone number automatically filled in and ready to be dialed. To place the call, tap the **Talk** button on the Phone screen or press the **Talk** key again.

Tapping a phone number that is displayed in the body of the text message also allows you to call that number.

For more information about viewing text messages on the Messages tab, see "Messages" on page 47. For more information about working with text messages, see "Text Messaging (SMS)" on page 137.

Making a Call from an Email Message

While viewing a received email message, you can directly place a call to the sender of the message. Tapping a phone number that is displayed in the body of the email message also allows you to call that number.

Note To receive email, set up your email account first on your device. See "Email Messaging" on page 164 for instructions.

From the Home screen Mail Tab or Inbox

- ▶ When you are browsing email messages on the Mail tab or in the Inbox, select a received email and then press the **Talk** key. To call the sender, follow the same steps in "Making a Call from a Text Message" on page 70.

For more information about browsing through email on the Mail tab, see "Mail" on page 46. For more information about working with email messages, see "Email Messaging" on page 164.

From an Open Email

1. From the Home screen, slide to the Mail tab.
2. Swipe your finger up or down the screen to browse through received messages. Tap an email message to open it.
3. To place a call, you can do the following:
 - If the sender is a contact that is stored with a phone number on your device, tap the **Talk** button () that is displayed to the right of the sender name to directly dial the sender's phone number.

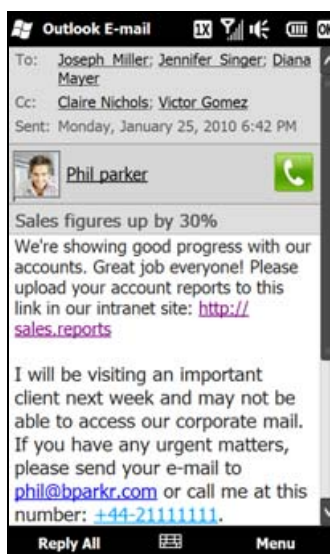

- To call a phone number that is contained in the email message, tap that phone number.

4. While the call is in progress, you can view the email message directly on the Phone screen. An email indicator is shown on the **Keypad** button (). Tap this button to view the message.

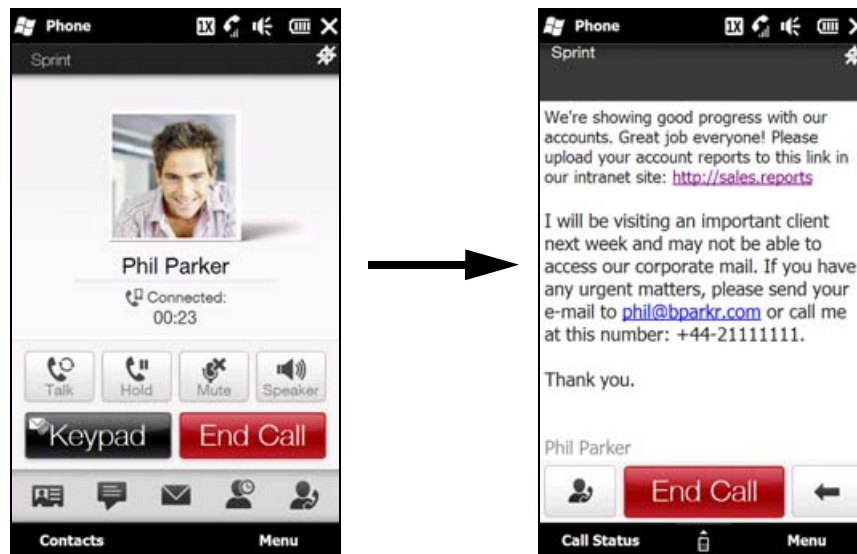

Making a Call from a Meeting Request or Reminder

When you receive a calendar reminder or meeting request email that contains a phone number, you can tap the number to directly place the call.

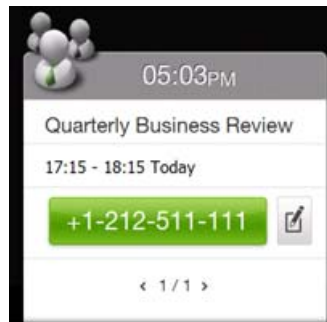

For example, if you are traveling and need to join a conference bridge call back in the home office, rest assured that you can join the call without delay. Appointment reminders you receive on your device will conveniently display the phone number and PIN, ready for you to dial.

If you made a call from a meeting request email, you can view the meeting details in the email directly on the Phone screen while the call is in progress. Tap the **Keypad** button () to view the meeting details.

Turning On the Speakerphone During a Call

While a call or three-way call is in progress, you can turn on the speakerphone by simply placing your device face down.

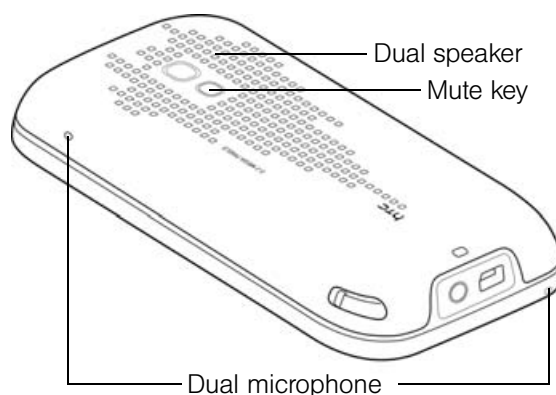

Your device provides crystal-clear sound quality and voice reception during three-way calls. When the speakerphone is on, your device also enables the dual microphone to enhance your voice quality and reduce noise.

When you need to temporarily mute the dual microphone so that the three-way call participants will not hear you, press the **Mute** button. Press it again to unmute.

Note For instructions on how to make a three-way call, see "Making a Three-Way Call" on page 142.

Turning the Phone On and Off

In many countries, you are required by law to turn off the phone while on board an aircraft.

Enabling or Disabling the Phone

1. Slide to the Settings tab, and then tap **Wireless controls** to open the Comm Manager.
2. Tap the **OFF/ON** slider at the right side of the **Phone** option to enable or disable the phone function.
When enabled, the **ON** indicator is activated.

Enabling or Disabling Airplane Mode

Another way to turn off the phone function is to switch your device to **Airplane Mode**.

1. Slide to the Settings tab, and then tap **Wireless controls** to open the Comm Manager.
2. On the Comm Manager screen, tap **Airplane Mode** to enable or disable Airplane Mode. When enabled, the **ON** indicator is activated.

When you enable Airplane Mode, all wireless radios on your device are turned off, including the phone function, Bluetooth, and Wi-Fi. When you disable Airplane Mode, the phone function is turned back on and the previous states of Bluetooth and Wi-Fi are restored.

Note When you return from an international trip and you disable Airplane Mode after landing in the United States, your device will first search for GSM networks if your device has been set to Global mode and was connected to a GSM network before. A "No Service" status message may first appear on your device. Please wait for your device to scan for CDMA service and connect to the Nationwide Sprint Network or a CDMA roaming network.

Phone Services

When you are using your device in the United States, you can configure CDMA (domestic) phone services for your device.

To access and change settings for domestic phone services:

1. Slide to the Settings tab, and then tap **Wireless controls > Phone > CDMA Services** tab.
2. Tap the service you want to change, and then tap **Get Settings**.
3. Tap **OK** after changing settings.

The following are some of the services that you can configure for your device:

Service	Usage
Location Setting	Allows the network to detect your current location using your device's built-in GPS chip. This is especially useful in emergencies.
TTY Mode	Allows the use of a TTY (teletypewriter) device with the phone for users who are visually or hearing impaired. Choose one of the following modes, depending on the operation mode that is supported by the TTY device: <ul style="list-style-type: none">● Full mode: Send and receive text during an ongoing call.● VCO mode: Voice Carry Over mode, which allows users to send voice and receive text during an ongoing call.● HCO mode: Hearing Carry Over mode, which allows users to send text and receive voice during an ongoing call.● Off: Disable TTY mode, and send and receive voice during an ongoing call.
Roaming	To better control roaming costs, you can set your device to roam only on certain networks. The Data Roam Guard also helps you to manage your roaming costs. For more information about roaming, see "Roaming" on page 143.
Time Synchronization	Allows the system time on your device to be synchronized with the time information of the mobile phone network.
Voicemail	Allows you to delete voicemail messages and clear the voicemail icon if it appears on the screen.
Roaming Alert	Enables sound alerts on your device so that you can be notified when your device enters or goes out of the network coverage area.
DDTM Mode	By default, voice calls take precedence over data. If, for instance, you are browsing the Web or streaming media, the data connection may be interrupted when you have an incoming call. To avoid interrupting the data connection, you can turn on DDTM Mode so that voice calls can be automatically sent to voicemail and the data connection will not be interrupted.

For more information about customizing settings of phone services, see Help on your device.

Synchronizing Information With Your Computer

- ◆ *About Synchronization (page 75)*
- ◆ *Ways to Synchronize (page 75)*
- ◆ *Setting Up Windows Mobile Device Center on Windows 7 and Windows Vista (page 76)*
- ◆ *Setting Up ActiveSync on Windows XP (page 77)*
- ◆ *Synchronizing with Your Computer (page 78)*
- ◆ *Synchronizing via Bluetooth (page 79)*
- ◆ *Synchronizing Music and Video (page 79)*
- ◆ *Synchronizing with Microsoft My Phone (page 80)*

You can take information from your computer wherever you go by synchronizing them to your device. This section explains how to connect your device to the computer and synchronize your data.

About Synchronization

The following types of information can be synchronized between your computer and your device:

- **Microsoft® Office Outlook® information**, which includes Office Outlook email messages, contacts, calendar, tasks, and notes
- **Notes**, which are created using Microsoft® Office OneNote® 2007
- **Media**, such as pictures, music, and video
- **Favorites**, which are the bookmarked links to your favorite websites
- **Files**, such as documents and other files

Before you can synchronize, you first need to install and set up the synchronization software on your computer. For more information, see “Setting Up Windows Mobile Device Center on Windows 7 and Windows Vista” and “Setting Up ActiveSync on Windows XP” in this section.

Ways to Synchronize

After you have installed the synchronization software on your computer, connect and synchronize your device with your computer by:

- Using the supplied USB sync cable.
 - Upon connecting the sync cable to your device and your computer, the synchronization process automatically starts.
- Using Bluetooth.
 - You must first set up a Bluetooth partnership between your device and your computer before you can synchronize information between them using Bluetooth. For more information about setting up a Bluetooth partnership, see “Bluetooth Partnerships” on page 101. For information about synchronizing through Bluetooth, see “Synchronizing via Bluetooth.”
- Using Microsoft My Phone
 - If you have a Microsoft My Phone account, you can sync and restore the contacts, calendar appointments, photos, and other information that you stored on your account to your current Windows phone. See Synchronizing with Microsoft My Phone (page 80) in this chapter for details.

Try to synchronize regularly in order to keep information up-to-date in both your device and your computer.

Note You can also synchronize Outlook email messages, contacts, calendar, and tasks on your device with the Exchange Server at your workplace. For more information about setting up your device to synchronize with the Exchange Server, see "Working With Company Email and Meeting Appointments" on page 168.

Setting Up Windows Mobile Device Center on Windows 7 and Windows Vista

Microsoft Windows Mobile® Device Center is the replacement for Microsoft® ActiveSync® on Windows® 7 and Windows Vista®.

Note Some versions of Windows 7 and Windows Vista come with Windows Mobile Device Center already installed. If Windows Mobile Device Center is not available in your Windows 7 or Windows Vista installation, you can install it from the Getting Started CD that came with your device.

Setting Up Synchronization in Windows Mobile Device Center

When you connect your device to your computer and start Windows Mobile Device Center for the first time, you are asked to create a Windows Mobile partnership with your device. To create a partnership:

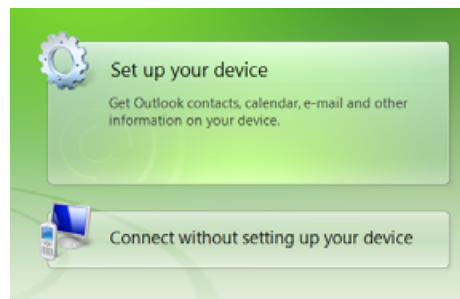

1. Connect your device to your computer. Windows Mobile Device Center configures itself, and then opens.
2. On the license agreement screen, click **Accept**.
3. On the Windows Mobile Device Center's Home screen, click **Set up your device**.

Note Choose **Connect without setting up your device** if you only want to transfer media files, check for updates, and explore your device but not synchronize Outlook information.

4. Select the items you want to synchronize, and then click **Next**.
5. Enter a device name, and then click **Set Up**.

When you finish the setup wizard, Windows Mobile Device Center synchronizes your device automatically. Outlook email messages and other information appear on your device after synchronization.

Using Windows Mobile Device Center

To open Windows Mobile Device Center, click *Start > All Programs > Windows Mobile Device Center* on your Windows 7 or Windows Vista computer.

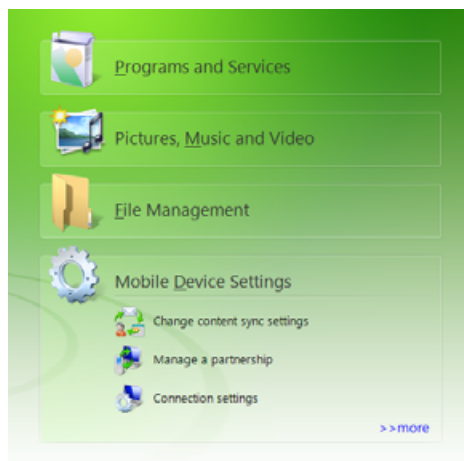

Within Windows Mobile Device Center, you can do the following:

- Click **Mobile Device Settings** to change synchronization settings.
- Click **Pictures, Music and Video > __new pictures/video clips are available for import**, and a wizard will guide you through tagging and transferring photos from your device to the Photo Gallery on your computer.
- Click **Pictures, Music and Video > Add media to your device from Windows Media Player** to synchronize music and video files using Windows Media Player. For more information, see “Using Windows Media Player Mobile” on page 116.
- Click **File Management > Browse the contents of your device** to view documents and files on your device.

Note See *Windows Mobile Device Center Help* for more information.

Setting Up ActiveSync on Windows XP

On a Windows® XP computer, you need to use Microsoft ActiveSync® 4.5 or later. If you do not have this software on your computer, you can install it from the Getting Started CD that came with your device.

Setting Up Synchronization in ActiveSync

1. Connect your device to your computer. The Synchronization Setup Wizard automatically starts and guides you to create a synchronization partnership. Click **Next** to proceed.
2. To synchronize your device with your computer, clear the **Synchronize directly with a server running Microsoft Exchange** check box, and then click **Next**.
3. Select the information types that you want to synchronize, and then click **Next**.
4. Select or clear the **Allow wireless data connections** check box according to your preference.
5. Click **Finish**.

When you finish the wizard, ActiveSync synchronizes your device automatically. Notice that Outlook email messages and other information appear on your device after synchronization.

Synchronizing with Your Computer

Connect and synchronize your device with your computer using the USB cable or Bluetooth connection.

Starting and Stopping Synchronization

You can manually synchronize from either your device or your computer.

From Your Device



► From the Home screen, slide to the Settings tab, and then tap **Data services > ActiveSync > Sync now**.

– or –

Tap **Start > Tools > ActiveSync**, and then tap **Sync**. To end synchronization before it completes, tap **Stop**.



Tip To delete a partnership with one computer completely, disconnect your device from that computer. In ActiveSync on your device, tap **Menu > Options...**, tap the computer name, and then tap **Delete**.

From Windows Mobile Device Center

1. Click **Start > All Programs > Windows Mobile Device Center**.
2. Click  at the lower left of the Windows Mobile Device Center. To end synchronization before it completes, click .

From ActiveSync on Your Computer

When you connect your device to your computer, ActiveSync automatically opens on your computer and synchronizes.

- To manually start synchronization, click .
- To end synchronization before it completes, click .

Specifying What Information Is Synchronized

You can change the information types and the amount of information to synchronize for each type on either your device or your computer. Follow the steps below to change synchronization settings on your device.

Note Before changing synchronization settings on your device, disconnect it from your computer.

1. In ActiveSync on your device, tap **Menu > Options**.
2. Select the check box for any items you want to synchronize. If you cannot select a check box, you might have to clear the check box for the same information type elsewhere in the list.
3. To change synchronization settings for an information type (for example, **E-Mail**), select it, and tap **Settings**. You can then set the download size limit, specify the time period of information to download, and more.

Notes

- Some information types such as **Favorites**, **Files**, and **Media** cannot be selected in ActiveSync Options on your device. You can select or clear these items only from your computer's Windows Mobile Device Center or ActiveSync.
- A computer can have sync partnerships with many different Windows Mobile powered devices, but a device can have sync partnerships with at most two computers. To ensure that your device will synchronize properly with both computers, set up the second computer using the same synchronization settings you used on the first computer.
- Outlook email messages can be synchronized with only one computer.

Troubleshooting Sync Connection Problems

In some cases, when the computer connects to the Internet or a local network, it may disconnect the connection with your device in favor of the Internet or network connection.

If this happens, slide to the Settings tab, and then tap **Other > USB to PC**, and then clear the **Enable faster data synchronization** check box. This makes your computer use a serial USB connection with your device.

Synchronizing via Bluetooth

You can connect and synchronize your device with the computer using Bluetooth.

Note To connect and synchronize your device with a computer via Bluetooth, your computer must have built-in Bluetooth or must be installed with a Bluetooth adapter or dongle.

1. Set up Windows Mobile Device Center or ActiveSync on your computer to synchronize through Bluetooth. See the program's Help for instructions.
2. Make sure that Bluetooth on both your device and the computer are turned on and set to visible mode. See "Using Bluetooth" on page 100 for details.
If this is the first time you have connected to this computer via Bluetooth, you must first complete the Bluetooth wizard on your device and set up a Bluetooth partnership between your device and the computer. For more information about creating a Bluetooth partnership, see "Bluetooth Partnerships" on page 101.
3. On your device, tap **Start > Tools > ActiveSync**.
4. Tap **Menu > Connect via Bluetooth > Add a device**.
5. Tap the name of your computer, select **Bluetooth Serial Port**, and then tap **Continue**.

Note To conserve battery power, turn off Bluetooth when not in use.

Synchronizing Music and Video

If you want to carry your music or other digital media along with you while you travel, set up Windows Media® Player on your computer to synchronize music and video with your device.

Other than selecting the **Media** information type to be synchronized, all media synchronization settings must be set in Windows Media Player. Before media can be synchronized, you must do the following:

- Install Windows Media Player Version 11 on your computer. (Windows Media Player 11 works only with Windows XP or later versions).
- Connect your device to the computer with a USB cable. If your device is currently connected using Bluetooth, you must end that connection before media can be synchronized.
- Set up a sync partnership between your device and your computer's Windows Media Player.

For more information about using Windows Media Player Mobile, see "Using Windows Media Player Mobile" on page 116.

Synchronizing with Microsoft My Phone

Microsoft My Phone syncs information between your device and a password-protected website hosted by Microsoft. You can back up and restore your contacts, calendar appointments, photos, and other information.

Note You can sync contacts, calendar, and tasks with My Phone only if your device does not have a sync partnership with an Exchange Server.

Setting up Your My Phone account

Whether you are setting up a new account or synchronizing to an existing account, the first step is to set up My Phone on your device.

1. Tap **Start > Microsoft My Phone**.
2. Follow the instructions in the wizard to set up your My Phone account. During setup:
 - Sign in using your Hotmail® or Windows Live™ address and password.
 - Set the sync method to Automatic or Manual, depending on your preference.
 - Install updated My Phone software if you are asked to do so.

Changing Sync Settings

To change sync settings such as the sync schedule and items to synchronize, you need to access the settings from the menu.

To change which items to sync

1. Tap **Start > Microsoft My Phone**.
2. Tap **Menu > Sync Options**.
3. Select the items you want to include or exclude during synchronization.
4. Tap **Done**.

To adjust sync schedule and roaming settings

1. Tap **Start > Microsoft My Phone**.
2. Tap **Menu > Sync Schedule**.
3. Select from the available schedule options.
4. To enable automatic sync while roaming (when you are out of range of your home network), select the **Use these settings when roaming** check box.
5. Tap **Done**.

Stopping Sync Partnership with Your My Phone Web Account

You can stop synchronizing with your My Phone Web account on your device. This does not delete the data that were synchronized to your device and the data stored on your My Phone Web account.

1. Tap **Start > Microsoft My Phone**.
2. Tap **Menu > Account**.
3. Tap **Stop Using Service**, and then tap **Yes**.

Managing Your My Phone Web Account from Your Computer

You can use a Web browser on your computer to access your My Phone Web account and:

- Add, edit, or delete contacts, calendar appointments, and other types of information. Changes will be synchronized with your device.
- View photos and videos that are stored on your My Phone account, delete them, save them to your computer, and more.
- Share photos directly on Facebook, Flickr™, MySpace™ and Windows Live.
- Locate your device if you lose it, or protect your sensitive data (charges apply for some services).

To access your My Phone Web account from your computer, go to <http://myphone.microsoft.com>, and sign in using your Hotmail or Windows Live address and password.

Contacts, Calendar, and Tools

- ◆ *Contacts (page 82)*
- ◆ *Calendar (page 84)*
- ◆ *Notes (page 86)*
- ◆ *Tasks (page 87)*
- ◆ *Calculator (page 87)*
- ◆ *Comm Manager (page 89)*
- ◆ *Microsoft Office Mobile (page 90)*
- ◆ *JETCET Presentation (page 91)*
- ◆ *Automatic Speech Recognition (ASR) (page 93)*
- ◆ *Voice Recorder (page 94)*
- ◆ *WorldCard Mobile (Business Card Scanner) (page 95)*
- ◆ *Windows Marketplace (page 95)*
- ◆ *JETCET PRINT (Wireless Printing Application) (page 96)*

Your device is equipped with several personal information management features that help you manage your busy lifestyle. Document viewers, voice recognition and recording programs, a business card reader, and other useful tools are also available. This section shows you how to use these features and tools.

Contacts

Adding New Contacts

You can use the Windows Mobile **Contacts** program to store and manage the contact information of the people and businesses you communicate with. You can add the following types of contacts to your device:

- **Outlook contacts.** Contacts that are stored on your device, which can be created on your device or synchronized with your computer or the Exchange Server.
- **Windows Live™ contacts.** Contacts that you communicate with using Windows Live™ Messenger or MSN.

Notes

- You can also add contacts to your device through the **All** tab of the People screen which is accessed from the Home screen. See “People” on page 38 for details.
- You can add Windows Live™ contacts only after setting up Windows Live™ on your device. See “Adding Windows Live Contacts” on page 158 for details.

To open the Contacts screen:

- ▶ Tap **Start > Outlook > Contacts**.

To add a contact on your device:

1. Open the Contacts screen.
2. Tap **New**, select **Outlook Contact**, and enter the contact information.
3. In the **File as** field, choose how you want the contact name to appear in the contact list.
4. To add a photo of the contact, tap **Select a picture**, and then select the picture file or tap **Camera** to take a photo of the contact.

5. To assign a ringtone to the contact, tap the **Ring tone** field, scroll through the list of tones, and then select a desired tone.
6. When finished, tap **OK**.

Tips

- If a person who is not in your list of contacts called you and you want to save that person's phone number, you can tap **Yes, Create new contact** on the pop-up window that appears after the call is ended.
- To save a phone number that is contained in a message, open the message, tap the underlined phone number, and then tap **Save To Contacts**.
- To edit contact information, tap the contact name on the Contacts screen and then tap **Menu > Edit**.

Managing Contacts

To group similar contacts:

For easier management, you can group similar contacts by assigning them to categories.

1. Create a new Outlook contact or edit an existing Outlook contact.
2. Tap **Categories**.
3. Select a preset category such as Business or Personal, or tap **New** to create your own category.
4. When finished, tap **OK**.

To find a contact on your device:

There are several ways to find a contact when your contact list is long:

- Begin entering a contact name in the provided text box until the contact you want is displayed.
- On the Quick Scroll bar on the right of the Contacts screen, scroll to or tap a letter to go directly to the part of the contacts list where contact names start with that letter.



Note

You can disable the Quick Scroll bar by tapping **Menu > Options...** and selecting the **Show alphabetical index** check box. This will show the alphabetical index at the top of the Contacts list.

- Filter the list by categories. In the contact list, tap **Menu > Filter**, and then tap a category you've assigned to a contact. To show all contacts again, select **Menu > Filter > All Contacts**.

To send contact information via Bluetooth:

You can quickly send contact information to another mobile phone or device through Bluetooth.

1. Touch and hold a contact on the Contacts screen.
2. Tap **Send via Bluetooth**, and then select a device where to send the contact to.

Note Before sending, make sure Bluetooth is turned on and set to visible mode on your device and the target mobile device. You can also send contact information to your computer. See "Sending and Receiving Information Using Bluetooth" on page 102 for details.

Calendar

You can use the Windows Mobile **Calendar** program to create appointments, including meetings and other events, as well as synchronize Calendar appointments between your device and computer.

Note You can also create appointments through the Calendar tab of the Home screen. See "Calendar" on page 48 for details.

To open the Calendar screen:

- ▶ Tap **Start > Outlook > Calendar**.

Creating Appointments

To schedule an appointment:

1. Open the Calendar screen and then tap **Menu > New Appointment**.
2. Enter a name for the appointment in the **Subject** field.
3. Do one of the following:
 - If it is a special occasion such as a birthday or an all-day event, set the **All Day** option to **Yes**.
 - If there is a time frame for the appointment, set the start and end dates and times.
4. Specify the type of category for your appointment, so that it can be grouped with other related appointments. Tap **Categories**, and then select a preset category (Business, Holiday, Personal, or Seasonal), or tap **New** to create your own category.
5. When finished, tap **OK** to return to the calendar.

Notes

- All-day events do not occupy blocks of time; instead, they appear in banners at the top of the calendar.
- To remove an appointment, tap **Menu > Delete Appointment**.

To set the reminder time for new appointments:

By default, Calendar has been set to display a reminder alert when you have new upcoming appointments. You can change the reminder time.

1. On the Calendar screen, tap **Menu > Tools > Options... > Appointments** tab.
2. Make sure the **Set reminders for new items** check box is selected.
3. Set the time when you want the reminder to alert you, and then tap **OK** to return to the Calendar screen.

The Calendar Screen

By default, Calendar displays appointments in *Agenda* view. You can also look at your appointments in *Day*, *Week*, *Month*, and *Year* views.

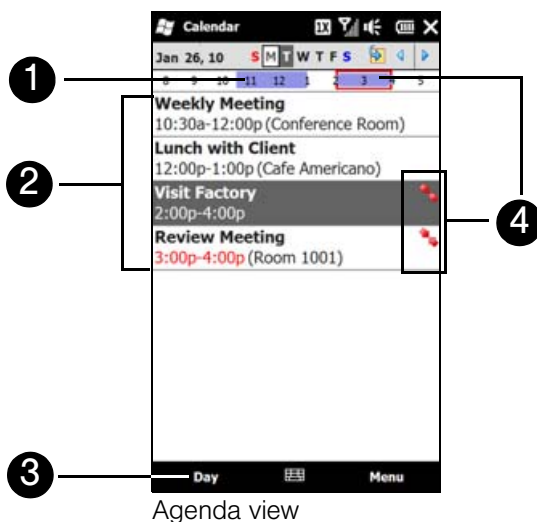

1. The highlighted hours indicate the time of your appointments.
2. Tap an appointment to view details about the appointment.
3. Tap the lower-left side of the screen to change the calendar view to one of the following: *Day*, *Week*, *Month*, *Year*, or *Agenda*.
4. The red box and red arrows indicate there are conflicting appointments.

Viewing Appointments

- To see detailed appointment information in any view, tap the appointment.
- To view appointments by category, tap *Menu > Filter*, and then select the desired category.
- To change the default view that Calendar uses to display appointments, tap *Menu > Tools > Options... > General* tab. Tap the *Start in* box, and then choose the calendar view.
- When in Month view, you will see the following indicators:
 - ▣ Morning appointment
 - ▤ Afternoon or evening appointment
 - Both morning and afternoon or evening appointments
 - All-day event

Sending Appointments

Sending a Meeting Request

Use Calendar to schedule meetings via email with contacts who use Outlook or Outlook Mobile.

1. Open the Calendar screen, and then create an appointment or tap *Menu > Edit* to open an appointment.
2. Tap *Attendees*, and then tap *Add Required Attendee* or *Add Optional Attendee* and add the contacts whom you want to invite.

Note You can specify whether an attendee is required or optional only if your device is connected to a Microsoft Exchange 2007 server. Otherwise, all attendees are designated as required. For more information, see "Managing Meeting Requests" on page 172.

3. When you have finished adding attendees, tap **Done**.
4. Tap **OK** to send.

Notes

- To choose the email account to use for sending meeting requests, tap **Menu > Tools > Options... > Appointments** tab. Tap the **Send meeting requests via** box and choose to send via your Outlook Email, Internet email (POP3/IMAP4), or Windows Live™ account.
- If you're sending the meeting request using your Outlook Email account, it will be sent to the attendees the next time you synchronize your device with your computer or Exchange Server.
- When attendees accept your meeting request, the meeting is automatically added to their schedules. When their response is sent back to you, your calendar is updated as well.

Notes

Using **Notes**, you can create handwritten and typed notes, record voice notes in WAV format, convert handwritten notes to text for easy readability, and more.

To create a note:

1. Tap **Start > Outlook > Notes**. In the note list, tap **New**.
2. Use the sliding QWERTY keyboard or choose an onscreen keyboard to enter your text.

Tip For more information about using the sliding QWERTY keyboard or onscreen keyboard, see "Entering Text" on page 24.

3. When finished, tap **OK** to save and return to the note list.

Notes



- To select handwritten text, touch and hold next to the writing. As soon as dots appear, and before they form a complete circle, quickly drag across the writing.
- If a letter crosses three ruled lines, it is treated as a drawing rather than text.

To draw in a note:

1. Create or open a note file.
2. Use the stylus to draw on the screen. A selection box then appears around your drawing.
3. Tap **OK** to save.

Note To select a drawing (for example, to copy or delete it), touch and hold the drawing briefly. When you lift the stylus, the drawing is selected.

To record a voice note:

1. Tap **Start > Outlook > Notes**.
2. If you do not see the Recording toolbar, tap **Menu > View Recording Toolbar**.
To create a stand-alone recording, record from the note list. You can also create or open a note first, and then add a recording to a note.
3. Tap the **Record** icon () to begin recording your voice. Tap the **Stop** icon () to stop recording.

Tip To select the voice recording format, return to the note list and then tap **Menu > Options... > Global Input Options** link (at the bottom of the Options screen). On the Input screen, tap the **Options** tab and choose the desired format from the Voice recording format list.

Tasks

Use **Tasks** to keep track of things you need to do. A task can occur once or repeatedly (recurring).

Your tasks are displayed in a task list. Overdue tasks are displayed in red. A reminder will be displayed when you have new tasks to be completed.

To create a task:

1. Tap **Start > Outlook > Tasks**.
2. Tap **Menu > New Task**, enter a subject for the task, and fill in information such as start and due dates, priority, and so on.
3. Specify the type of category for your task, so that it can be grouped with other related tasks. Tap **Categories**, and then select a preset category (Business, Holiday, Personal, or Seasonal), or tap **New** to create your own category.
4. When finished, tap **OK**.

To change the priority of a task:

Before you can sort tasks by priority, you need to specify a priority level for each task.

1. Tap **Start > Outlook > Tasks**.
2. Tap the task you want to change the priority for.
3. Tap **Edit**, and tap a priority level in the **Priority** box.
4. Tap **OK** to return to the task list.

Note All new tasks are assigned a Normal priority by default.

To show start and due dates in the task list:

1. Tap **Start > Outlook > Tasks**, and then tap **Menu > Options**.
2. Select the **Show start and due dates** check box, and then tap **OK**.

Calculator

Calculator features basic calculation functions, and also works as an advanced scientific calculator.

Basic Calculator



Use the Simple Calculator to do basic arithmetic such as addition, subtraction, multiplication, and division. You can also work with numbers you store in the calculator memory.

To use the Basic Calculator:

1. Tap **Start > Tools > Calculator**
2. Operate the calculator the same as you would a handheld calculator by tapping the onscreen keys to enter numbers, clear the entered number, and perform calculations.
3. You can also tap the respective buttons on the left side of the screen to add values to the calculator memory, display the stored number from the calculator memory, or clear the calculator memory.

Notes

- A maximum of 9 digits can be entered for each number.
- Tap **Copy** at the lower-left side of the screen to copy the displayed value so that you can paste it to another program that has a paste function, such as Notes.
- The Basic Calculator can only be used when the screen display is in portrait mode.

Scientific Calculator

Use the Scientific Calculator to perform more complex calculations such as square roots, logarithmic and trigonometric functions, percentages, and more.

To display the Scientific Calculator:

1. Tap **Start > Tools > Calculator**
2. Slide open the QWERTY keyboard to display the Scientific Calculator.

To use the Scientific Calculator:

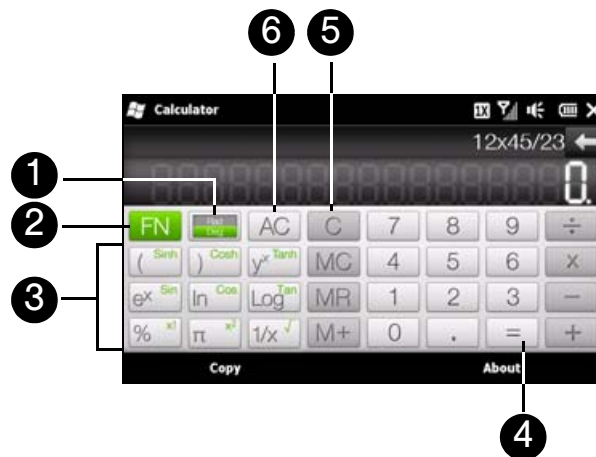

1. Tap to toggle between degrees or radian measurement.
2. Tap to display the second layer of scientific calculation buttons.
3. When you tap one of these function buttons after entering a number, the corresponding operand or operator is displayed. You can continue to enter numbers, operands and operators to build the formula expression.
4. Tap to compute and display the calculation result.
5. Tap to clear the calculation result so you can build another equation.
6. Tap to clear the formula expression or calculation result.

Comm Manager

Comm Manager is a central location where you can easily turn on and off the communication features of your device such as the phone connection, Wi-Fi, data connection, Bluetooth, and more.

To access the *Comm Manager*:

- ▶ Slide to the Home screen's Settings tab, and then tap *Wireless controls*.



1. Switch Airplane Mode on or off. Turning on Airplane Mode turns off the phone connection, Wi-Fi, and Bluetooth functions. For more information, see “Enabling or Disabling Airplane Mode” on page 73.
2. Access the phone settings, configure phone services, and more.
3. Connect a Bluetooth headset or other Bluetooth-enabled device. For more information, see “Using Bluetooth” on page 100.
4. Connect to a wireless network. See “Connecting via Wi-Fi” on page 147 for details.
5. Open ActiveSync and configure the push mail settings. See “Working With Company Email” on page 169 for details.
6. Open the Connections screen to check or manage data connection settings.
7. Tap *Menu* when you need to access and change the following settings:
 - **Connections** Set up one or more types of modem connection for your device, such as phone dial-up and GPRS, so that your device can connect to the Internet or a private local network. See “Web and Data Services” on page 146 for details.
 - **Domain Enroll** Enroll your device in your company's domain to let System Center Mobile Device Manager manage the device. Ask your network administrator for more details.
 - **USB to PC** Set the type of USB connection to your PC. Select the **ActiveSync** option for synchronizing data, **Disk Drive** mode for transferring files, or **Internet Sharing** to use your device as a modem for your computer.
8. Connect or disconnect the current data connection.
9. Switch between automatically receiving (as items arrive) or manually retrieving Outlook email messages. See “Automatic Synchronization Using Direct Push” on page 169 for details.
10. Switch Wi-Fi on or off. Tap *Settings > Wireless LAN* to configure wireless network connection settings. See “Connecting via Wi-Fi” on page 147 for details.

11. Switch Bluetooth on or off. Tap **Settings > Bluetooth** to configure Bluetooth on your device. See “Using Bluetooth” on page 100 for details.
12. Switch the phone connection on or off. Tap **Settings > Phone** to set the ringtone, services, and other phone settings. See “Using Phone Features” on page 63 and “Managing Your Device” on page 121 for details.

Microsoft Office Mobile

Microsoft® Office Mobile consists of the following applications:

- **Microsoft® Office Excel® Mobile** lets you create and edit Excel workbooks and templates on your device.
- **Microsoft® Office OneNote® Mobile** lets you create notes with text, photos, and voice recordings for synchronization later with Microsoft Office OneNote 2007 on your computer.
- **Microsoft® Office PowerPoint® Mobile** allows you to view (but not create) slide show presentations in *.ppt and *.pps formats.
- **Microsoft® Office Word Mobile** lets you create and edit documents and templates in Word Mobile and save them as *.doc, *.rtf, *.txt, and *.dot files.

To use Microsoft Office Mobile:

1. Tap **Start > Office Mobile**.
2. Tap the Office Mobile application that you want to use.

When working with Word Mobile and Excel Mobile files, you can use the Zoom bar on your device for zooming:

- To zoom in, slide your finger from left to right across the Zoom bar.
- To zoom out, slide your finger from right to left across the Zoom bar.

Word Mobile and Excel Mobile do not fully support all features of Microsoft Office Word and Microsoft Office Excel. To see a complete list of features that are not supported in Word Mobile and Excel Mobile, see Help on your device.

Tips

- By default, Word Mobile saves documents in .docx format, while Excel Mobile saves workbooks in .xlsx format. If you want to open these types of files on a computer that uses Microsoft Office 2000, Office XP, or Office 2003, you need to download and install the **File Format Converter** in your computer. You can find this converter at <http://www.microsoft.com/downloads/details.aspx?FamilyId=941B3470-3AE9-4AEE-8F43-C6BB74CD1466&displaylang=en>.
- If you want Word Mobile to save documents in .doc format, tap **Menu > Tools > Options...** (or **Menu > Options...** when no document is opened), and then change the **Default template** to **Word 97-2003 Document (.doc)**.
- If you want Excel Mobile to save workbooks in a format that is compatible with Microsoft Office 2000, Office XP, or Office 2003, tap **Menu > Options...** (with no workbook opened), and then change **Template for new workbook** to **Blank 97-2003 Workbook**.

JETCET Presentation

If you are away from your office and urgently need to make a presentation, you can use *JETCET Presentation* to create a PowerPoint file and present it from your device.

JETCET Presentation also allows you to open and display presentations that were created in Microsoft PowerPoint 97, PowerPoint 2000, PowerPoint 2002 (XP), or PowerPoint 2003.

Opening JETCET Presentation

- ▶ Tap *Start > JETCET Presenter*.

Creating a New Presentation

When you open JETCET Presentation, the main screen displays a folder tree. Tap *Menu > Cancel* first and then tap *Menu > File > New* to create a new presentation. You can then enter text, insert graphics, and add more slides.

To add text to a slide:

1. Tap *Edit > Shape > Insert*, tap , and then tap *OK*.
2. Drag your finger or stylus to draw a text box on the slide.
3. While the text box is selected, set the font type, size and style first and then start entering your text using the hardware keyboard or onscreen keyboard.
4. While the text box is selected, tap *Menu > Paragraph* and then set the paragraph alignment, indentation, and line spacing.
5. To format the text with automated bullets or numbering, tap *Menu > Paragraph > Bullets*.
6. To modify the properties of the text box, select the text box and then tap *Edit > Shape > Modify*. You can change the fill color, add or remove the border, and more. To wrap text inside the text box, tap the *Text Box* tab and then select the *Word wrap text in AutoShape* check box.

To edit text:

1. Select the text box that contains the text you want to edit.
2. Tap *Edit > Text > Modify* and then change your text. Tap within the text region to place the cursor exactly where you want to start editing.

To insert an object shape:

1. Tap *Edit > Shape > Insert*.
2. Tap an object, for example, an arrow, from the *Autoshape Objects* and then tap *OK*.
3. Drag on the slide to draw the select shape.

Tip To insert a picture, tap *Edit > Shape > Picture*.

To add and edit slides:

1. Tap *Edit > Slide > New* to add a new slide.
2. To change the background color of a slide, tap *Edit > Slide > Background*.
3. In *Background fill*, tap *Fill Effects* to apply a gradient or tap *More Colors* to choose a solid color.
4. Tap *Apply* to change the background color of the current slide, or tap *Apply to All* to change all slides.
5. To apply a transition effect to the slides, tap *Edit > Slide > Transition*.

6. In **Effect**, select the type of transition effect to use and then select a speed.
7. Choose whether to advance slides on mouse click or automatically. If you select to auto-display slides, set the time delay.
8. To make the changes to the current slide only, tap Apply. For the changes to affect all slides in the presentation, tap **Apply to All**.

To save the presentation:

- ▶ If this is your first time to save your presentation, tap **Menu > File > Save As** and then enter a new file name. To save changes made to your presentation, tap **Menu > File > Save**.

Displaying the Presentation

You can connect your device to a large-screen display such as a television and show your presentation to an audience as a full-screen slideshow. For more information about connecting your device to a large-screen display, see “Connecting to an External Display” on page 129

To display the presentation as a slideshow:

1. Tap the PowerPoint file in the folder tree to open the file, or tap **File > Open** and then tap the PowerPoint file.
2. Tap **Menu > Show > Set Up Show**. Select whether to advance slides **Manually** or **Using timings, if present**, and then tap **OK**.
3. Tap **Menu > Show > View Show**. The presentation is then displayed in landscape and in full screen.
4. Slide open the hardware keyboard. If you have set up the slideshow to advance manually, press the right arrow key to advance one slide forward and the left arrow key to go back one slide.

Another way to advance one slide forward is to tap the screen.

You can also tap the arrow watermark at the lower-left corner of the screen to open a selection menu, and then tap **Next** or **Previous** to move between slides.



Arrow watermark

To exit the slideshow:

- ▶ Tap the arrow watermark, tap the down arrow to scroll down the selection menu, and then tap **End Show**.

For more information about using JETCET Presentation, tap  on the toolbar of JETCET Presentation to view the program help.

Automatic Speech Recognition (ASR)

Your device's built-in ASR lets you make phone calls, open programs, play back music, get calendar information, and more, just by using your voice. It only responds to a set of predefined commands and does not allow you to record your own commands.

This section gives a few examples on how to use ASR. For more information, see ASR help on the device. To access help, tap **Start > Help** tab, tap **Help for Added Programs**, and then tap **Voice Command**.

To use ASR:

1. Press and hold the **Talk** key, and a microphone icon () will appear on the title bar.
2. Hold your device a few inches away from your mouth. In a clear voice, say a command.
For example, say "Help" to ask for information about using ASR.
3. The ASR software then asks you a question. Say your answer.

To place a call:

You can call contacts that are stored on your device, dial a phone number, redial, and place a return call.

1. Press and hold the **Talk** key until the microphone icon () appears on the title bar.
2. In a clear voice, say one of the following commands:
 - "Call [contact name]" to call a contact.
 - "Dial [number]" to dial a phone number.
 - "Redial" to repeat the last call made.
 - "Callback" to return the last call received.
 - "Call [contact name] at [location]" to call a contact at a specific number.
For example, say:
"Call Ann at mobile"
"Call Ann at home"
"Call Ann at work"
3. The ASR software will then confirm with you the contact or number to call. Say "Yes" or "Correct."
If the ASR software is wrong about the contact or number to call, say "No" or "Incorrect" to try again.
4. Your device starts to call the contact or number.

To open a program:

1. Press and hold the **Talk** key until the microphone icon () appears on the title bar.
2. In a clear voice, say "Start", "Open", or "Show" then the program name.

To request information from your calendar:

1. Press and hold the **Talk** key until the microphone icon () appears on the title bar.
2. In a clear voice, ask for the information you want to retrieve.
For example, say:
"What's my next appointment?"
"What's my next meeting?"
"What's my schedule tomorrow?"

To request for date and time:



1. Press and hold the **Talk** key until the microphone icon () appears on the title bar.
2. In a clear voice, say “What date is it?” The ASR software then tells you the current date.
3. Press and hold the **Talk** key again, and then say “What time is it?”
4. The ASR software then tells you the current time.

Voice Recorder

Voice Recorder lets you record your voice and quickly send it as an email attachment, send it in a picture message, or set the recorded voice as your ringtone.

Note *Voice Recorder saves voice recordings in AMR-NB (Adaptive Multi-Rate Narrowband) format only. This is a common speech audio format used in mobile devices.*

To record your voice:

1. Tap **Start > Tools > Voice Recorder**.
2. Hold the device’s microphone close to sound source.
3. Tap  to start recording. Tap  to end the recording.

Tip *You can also tap **Add recording** on the **All Recordings** screen to create a new voice recording.*

4. Tap  to play back the voice recording.
5. To control playback:
 - Use the onscreen controls to stop or pause playback.
 - Drag your finger right or left on the progress bar in the middle of the screen to move forward or backward in the voice recording.

Tip *You can leave the Voice Recorder screen while a recording is in progress and the recording will continue in the background. The recording status is shown on the notifications screen. Tap the notification to return to the Voice Recorder screen.*

To send a voice recording

1. Open the voice recording you want to send.
2. On the Voice Recorder screen, tap **Share**, and then choose a send option:
 - **Send via Bluetooth.** If prompted to turn on Bluetooth, tap **Yes**. Select a device to send the voice recording to. For more information about using Bluetooth, see “Bluetooth” on page 100.
 - **Send via Mail.** If prompted, select the email account you want to use to send the voice recording. The voice recording is added as an attachment to a new email. Compose your email and tap **Send**. For more information about sending email, see “Email Messaging” on page 164.
 - **Send via MMS.** The voice recording is added as an attachment to a new multimedia message. Compose your message and tap **Send**. For more information about sending multimedia messages, see “Video and Picture Messaging (MMS)” on page 140.

To set a voice recording as your ringtone:

1. Open the voice recording you want to set as your ringtone.
2. Tap **All Recordings**, and then tap **Menu > Set As Ringtone**.
3. Tap **OK**.



WorldCard Mobile (Business Card Scanner)

WorldCard Mobile uses your device's built-in camera to scan business cards and import the information into your Contacts.

To access *WorldCard Mobile*:

- ▶ Tap **Start > Tools > WorldCard Mobile**.

To capture a business card and import the information to Contacts:

1. Tap  on the WorldCard Mobile screen to open the Camera program.
2. Tap the Virtual Camera button () to take a photo of the business card, and then tap the Back button (). For more information about using the Camera, see "Taking Photos and Videos" on page 105.

Tip Make sure that lighting is adequate and that the entire business card is visible on the Camera screen before taking a picture.

3. On the WorldCard Mobile screen, tap **Recognize**.

Tips

- If you want to retake the shot, tap **Re-Capture**.
- For better recognition, choose the **Language** and **Region** based on the language used in the business card.

4. The screen will display contact information captured from the business card. Use the onscreen keyboard to edit the contact information, if needed.

Tip Uncheck the box beside any contact information that you do not want to appear in your Contacts.

5. Tap **Export** to transfer the captured data to Contacts.
6. Tap **Start > Outlook > Contacts** to view the contact.

For more information about using WorldCard Mobile, tap  on the WorldCard Mobile screen to view the program help.

Windows Marketplace

On Windows® Marketplace for Mobile, it's easy to download new programs that fit your needs and make your device truly personal. A wide range of free and premium programs is available, from games to powerful business applications. You can shop securely and download programs straight to your device or via your computer.

To access *Windows Marketplace* on your device

- ▶ Tap **Start > Marketplace**.

JETCET PRINT (Wireless Printing Application)

JETCET PRINT™ lets you print image files or documents from your device directly to a Bluetooth or network printer. You can also print email messages, email attachments, appointments, contacts, and tasks.

To open JETCET PRINT:

- ▶ Tap **Start > Tools > JETCET PRINT 5**.

To set up a printer:

- ▶ On the JETCET PRINT screen, tap the **Settings** () tab, and then tap:
 - **Add Network Printer** to set up and connect to a shared network printer.

Note The device will wait continuously if you have entered an incorrect IP address while setting up a network printer.

– or –

- **Add Bluetooth Printer** to set up and connect to a Bluetooth printer.

To print a document, image, email, or other types of information:

1. On the JETCET PRINT screen, select what you want to print (document, picture, or email/PIM) by tapping the corresponding tabs on top of the screen.
2. If you want to print a calendar appointment, contact or task, tap , and then select which type of information you want to print.

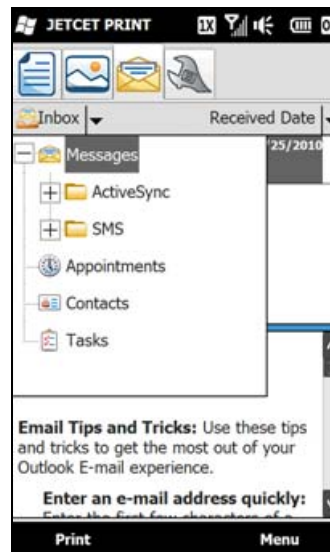

3. Touch and hold the file, picture, or item that you want to print, and then tap **Print**.
4. Select the printer to use and the paper size, and then tap **Next**.
5. Choose a page layout from the list, and then tap **Next** to start printing.

Tip You can also print document and image files from File Explorer. To print, use File Explorer to locate the file you want to print. Touch and hold the file, and then tap **Print via JETCET 5...** on the pop-up menu.

For more information about using JETCET PRINT, tap **Menu > Help > Contents** on the JETCET PRINT screen to view the program help.

Section 2G

microSD Card

- ◆ *Using a microSD Card on Your Device (page 97)*
- ◆ *Managing the microSD Card (page 98)*
- ◆ *Using Your Device as a USB Drive (page 99)*

Your device lets you insert a microSD™ card to expand the available storage space. This highly secure digital card enables you to exchange images, music, and other data between SD-compatible devices, and also provides additional storage space on your device.

Using a microSD Card on Your Device

Note A microSD card is not included with your device.

Inserting the microSD Card

The microSD card slot is located under the back cover of your device.

1. Remove the back cover. (See “Installing the Battery” on page 2.)
2. Insert the microSD card into the slot with the gold contacts facing down (in the same orientation as the image above the card slot).

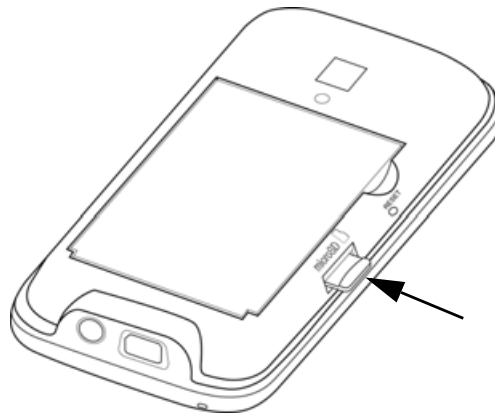

3. Replace the back cover.

Removing the microSD card

1. Remove the back cover. (See “Installing the Battery” on page 2.)
2. Remove the microSD card by pressing on the exposed edge and releasing. The card should pop out partway.

Managing the microSD Card

Copying Files to the microSD Card

1. Tap **Start** > **File Explorer** and navigate to the appropriate folder.
2. Touch and hold the file you want to copy, and then tap **Copy**.
3. Tap the down arrow (▼), and then tap **Storage Card** in the list.
4. Touch and hold an empty area on the screen and then select **Paste** on the menu.

Tip

You can configure programs such as Word Mobile and Excel Mobile to directly save edited files to the microSD card. In the program's file list, tap **Menu** > **Options...**, and then select **Storage Card** in the **Save to** box.

Encrypting Files on the microSD Card

You can set your device to encrypt files as they are saved on the microSD card.

1. Slide to the Settings tab, and then tap **Security** > **Encryption**.
2. Select the **Encrypt files when placed on a storage card** check box, and then tap **OK**.

Notes

- Encrypted files can only be read on the device that encrypted them.
- Encrypted files are opened just like other files, provided you are using the device that encrypted them. There is no separate step for you to take to read these files.

Important

If **Encrypt files when placed on a storage card** is enabled, back up all files from the microSD card before using **Clear Storage**, **hard reset**, or **updating the ROM system software**. Otherwise you will no longer be able to access the encrypted files on the microSD card. Use **ActiveSync** or **Windows Mobile Device Center** to transfer files between your microSD card and computer. After the procedure, copy those files back to the microSD card.

Checking the Available microSD Card Memory

- Slide to the Settings tab, and then tap **SD card & phone storage**.

If your device is running low on memory, try the following to free memory on your device:

- Close programs that are not in use.
- Move files and email attachments to the microSD card.
- Delete unnecessary files. Tap **Start** > **File Explorer**. Touch and hold the file, and tap **Delete**.
- Delete large files. To find large files on your device, tap **Start** > **Tools** > **Search Phone**. In the **Type** list, tap **Larger than 64 KB**, and tap **Search**.
- In Opera Mobile or Internet Explorer Mobile, delete temporary Internet files and clear history information.
- Remove programs you no longer use.
- Reset your device.

Using Your Device as a USB Drive

You can use an installed microSD card as a USB flash drive, allowing you to take pictures, music, documents, and other files with you on the go.

To use your microSD card as a USB flash drive:

- ▶ Whenever you connect your device to your computer, the Connect to PC screen will be displayed. Select **Disk Drive** mode on this screen.
 - or –
- Slide to the Settings tab, tap **Other > USB to PC** and then select **Disk Drive** mode.

When **Disk Drive** mode is enabled while your device is connected to the computer:

- You will not be able to use your device to access files from the microSD card or run applications that are installed on the microSD card.
- Your computer will connect only to the device's microSD card. When you access your device from the computer, you will only see the contents of the microSD card.

Remember to change back to **ActiveSync** mode when you need to synchronize data between your device and your computer.

Bluetooth

◆ Using Bluetooth (page 100)

Your device features built-in Bluetooth technology, allowing you to share information more easily than ever before.

Bluetooth is a short-range communications technology that allows you to connect wirelessly to a number of Bluetooth devices, such as headsets and hands-free car kits, and Bluetooth-enabled handhelds, computers, printers, and wireless phones. The Bluetooth communication range is usually up to approximately 30 feet.

This section shows you how to use Bluetooth on your device, including turning Bluetooth on and off, connecting to another Bluetooth device such as a Bluetooth stereo headset, and more.

Using Bluetooth

Bluetooth Modes

Bluetooth on your device has three different modes:

- **On.** Bluetooth is turned on. Your device can detect other Bluetooth-enabled devices within range, but cannot be detected by other Bluetooth-enabled devices.
- **Visible.** Bluetooth is turned on, and all other Bluetooth-enabled devices within range can detect your device.
- **Off.** Bluetooth is turned off. In this mode, you can neither send nor receive information using Bluetooth.

Notes	<ul style="list-style-type: none">• <i>By default, Bluetooth is turned off. If you turn it on and then turn off your device, Bluetooth also turns off. When you turn on your device again, Bluetooth automatically turns on.</i>• <i>Turn off Bluetooth when not in use to conserve battery power, or in places where using a wireless device is prohibited, such as aboard an aircraft and in hospitals.</i>
--------------	--

Turning Bluetooth On and Making Your Device Visible

The first time you use Bluetooth, follow the steps below to turn Bluetooth on and make your device visible to other Bluetooth-enabled devices.

1. Slide to the Settings tab, and then tap **Wireless controls > Bluetooth**.
2. When prompted to turn on Bluetooth, tap **Yes**.
3. Tap the Settings tab (), and then tap **Not Discoverable**.
4. Tap the drop-down menu and then select **Always Visible**.

Note	<i>If you select Visible for 60 seconds, Bluetooth visibility will turn off automatically when the time elapses and your device has not yet connected to another Bluetooth device.</i>
-------------	---

5. Tap **Done**. The   icon then appears in the title bar to indicate that your device is in visible mode.

To easily switch Bluetooth off or back on, slide to the Settings tab, tap **Wireless controls** to open the Comm Manager and then tap Bluetooth's OFF/ON slider. Your device remembers whether visible mode was previously enabled or disabled. If you did not disable visible mode, switching Bluetooth on in the Comm Manager also puts your device in visible mode automatically. For more information about using the Comm Manager, see "Comm Manager" on page 89.

Bluetooth Partnerships

A Bluetooth partnership is a relationship that you create between your device and another Bluetooth-enabled device in order to exchange information in a secure manner.

Creating a Bluetooth Partnership

1. Slide to the Settings tab, and then tap *Wireless controls > Bluetooth*.
2. On the Settings tab (), tap *Add a device*.
3. Tap a Bluetooth device to connect with.
4. Specify a passcode, which can be 1 up to 16 characters, to establish a secure connection, and then tap *OK*.

Note *Your device uses Bluetooth 2.1 with Secure Simple Pairing feature. If the other Bluetooth device you are pairing with also supports the same feature, the passcode will be automatically created and displayed on both devices. Both you and other party simply need to verify that the passcode is the same and tap Yes to establish the partnership.*

5. After the receiving party accepts the partnership, the Bluetooth device name is shown on the screen, including all Bluetooth services that you can use with it. Select the check boxes of the Bluetooth services you want to use, and then tap *Done*.
6. If you selected to use the Bluetooth Serial Port service of the paired device, select a local serial port to assign for the paired device, and then tap *Continue*.

The connected Bluetooth device now appears in the *Devices* tab ().

Tip *Tap Properties to change the paired device name. Tap Menu > Update to update the list of services that you can use with the paired device.*

Creating a Bluetooth partnership between two devices is a one-time process. Once a partnership is created, the devices can recognize the partnership and exchange information without entering a passcode again.

Accepting a Bluetooth Partnership

1. Ensure that Bluetooth is turned on and in visible mode.
2. When prompted, enter or accept the passcode (the same passcode from the device requesting the partnership) to establish a secure connection.
3. Tap *OK*. The paired device now appears in the *Devices* tab (). You can now exchange information with the paired device.

Tip *To delete a Bluetooth partnership, select the device's name on the Devices tab, and then tap Menu > Delete. When prompted to confirm, tap Yes.*

Connecting a Bluetooth Hands-free or Stereo Headset

For hands-free phone conversations, you can use a Bluetooth hands-free headset such as a car kit with your device. Your device also supports A2DP (Advanced Audio Distribution Profile) which allows you to use a Bluetooth stereo headset for hands-free phone conversations and for listening to stereo music.

To connect a Bluetooth hands-free or stereo headset:

1. Make sure that both your device and the Bluetooth headset are turned on and within range, and that the headset is visible. Refer to the manufacturer's documentation to find out how to set the headset in visible mode.
2. Slide to the Settings tab, and then tap *Wireless controls > Bluetooth*.

3. On the Settings tab (), tap **Add a device**.
4. Select the hands-free or stereo headset device in the list, and then tap **Select**. Your device will automatically connect with the Bluetooth headset.

Note Your device will automatically try one of the preconfigured passcodes (0000, 8888) to pair with the Bluetooth headset. If this fails, you have to manually enter the passcode delivered with your headset.

5. When connected, the hands-free or stereo headset device is shown on the screen, including the Bluetooth services (Hands-free and Stereo Audio) that you can use with it. Make sure these services are selected, and then tap **Done**.

The paired headset now appears in the **Devices** tab ().

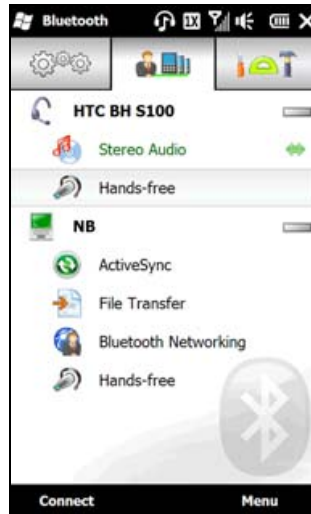

The double arrowhead () that is displayed to the right of a service indicates that the service is connected with your headset. If you turn off your headset, the double arrowhead disappears to indicate that the service has been disconnected. Next time you turn on and use your headset again, you need to manually reconnect each service. Tap a service and then tap **Connect**.

Sending and Receiving Information Using Bluetooth

You can send the following types of information from your device to your computer or to another Bluetooth-enabled device: Outlook email messages, contacts, tasks, notes, calendar items, audio files, ringtones, Images, and videos.





Note If your computer does not have built-in Bluetooth capability, you need to connect and use a Bluetooth adapter or dongle on your computer.

To send information from your device to a computer (Windows Vista or Windows XP SP2 [or higher] only):

1. On your computer, open **Bluetooth Devices** from the Control Panel, click the **Options** tab on the **Bluetooth Devices** window, and then do the following.
 - In **Windows Vista** and **Windows 7**, select **Allow Bluetooth devices to find this computer**.
 - In **Windows XP**, select **Turn discovery on** and **Allow Bluetooth devices to connect to this computer**.

Note If the Bluetooth adapter or dongle on your computer was installed using a third-party driver, open the Bluetooth software that came with the Bluetooth adapter or dongle and enable the adapter or dongle to be discovered by other devices. Refer to the Bluetooth adapter's documentation for more information.

2. In the **Options** tab of **Bluetooth Devices** on your computer, select **Show the Bluetooth icon in the notification area**.

3. To enable your computer to receive files or information through Bluetooth, right-click the Bluetooth icon  in the notification area at the bottom right corner of your computer screen and select **Receive a File**. Your computer is now ready to receive files or information.
4. Turn on Bluetooth on your device, and make your device visible. For information about this, see “Turning Bluetooth On and Making Your Device Visible” on page 100
5. Create a Bluetooth partnership between your device and computer. For instructions, see “Creating a Bluetooth Partnership” on page 101.
6. On your device’s Bluetooth screen, tap the **Accessories** tab (), and then tap **BT Send Object**.
7. To switch between the types of information that can be sent, tap  or . Select the check boxes of items you want to send.



8. Tap **Send**.
9. Select the Bluetooth device to which you want to send the items, and then tap **Select**.
10. If you sent Outlook Email messages, calendar items, tasks, or contacts to your computer and they are not automatically added to Outlook, select **File > Import and Export** in Outlook to import them.

To send information to a Bluetooth-enabled device such as another Windows Mobile-powered device, follow steps 4 to 9 in the above procedure.

Tips By default, data or files that you send to your computer will be stored in your “My Documents” folder or one of its subfolders depending on the file type..

To send a file to another Bluetooth-enabled device:



1. Tap **Start > File Explorer**.
2. Navigate to the folder that contains the file you want to send.
3. Touch and hold the desired file, and then tap **Send via Bluetooth**.
4. Tap the name of the Bluetooth device to which you want to send the file.

To receive information from another Bluetooth-enabled device:

1. When you receive information such as calendar items, tasks, or contacts sent from another Bluetooth-enabled device, tap **Accept**.
2. After your device has finished saving the information, tap **Done**.

To change the folder for saving received files:

Files that you receive from another Bluetooth-enabled device are saved in \My Documents on your device. You can change the destination folder for saving received files:

1. Slide to the Settings tab, and then tap **Wireless controls > Bluetooth**.
2. On the Settings tab (), tap **Advanced**.
3. Scroll down and then tap **File Transfer**.
4. Tap **Search** ().
5. Select the new destination folder, and then tap **Select**.

Tip To save received files on your storage card when it is inserted on your device, select **Save files to storage card when present**. Files will be saved on the root folder of your storage card.

6. Tap **Done**.

Printing via Bluetooth

Connect your device to a Bluetooth printer to print your pictures.

Note Before you start printing, make sure to turn on the Bluetooth printer and turn on Bluetooth on your device. For instructions, see "Turning Bluetooth On and Making Your Device Visible" on page 100.

To print a picture:

1. Slide to the Settings tab, and then tap **Wireless controls > Bluetooth**.
2. Tap the **Accessories** tab (), and then tap **Print Images**. Your device then searches for pictures that are stored on your device and storage card.
3. Tap each picture that you want to select for printing. To select all pictures, tap **Menu > Select All**.

Tip To clear a selected picture, tap that picture again.

4. After you have finished selecting pictures, tap **Next**.
5. Select the name of the Bluetooth printer, and then tap **Select**.
6. Select the **Print Layout** to use, and then tap **Print**.

Experiencing Multimedia

- ◆ *Taking Photos and Videos (page 105)*
- ◆ *Viewing Photos and Videos (page 112)*
- ◆ *Using Windows Media Player Mobile (page 116)*
- ◆ *Using Audio Booster (page 118)*
- ◆ *Using MP3 Trimmer (page 119)*

Your device's multimedia features give you the ability to capture full color digital pictures and videos, view your pictures and videos, and more. This section explains how to use these multimedia features.

Taking Photos and Videos

Use your device's built-in camera to take photos and record video clips.

To launch the camera:

- ▶ From the Home screen, slide to the Photos & Videos tab, and then tap the camera icon (). The screen orientation automatically switches to landscape mode.

Tip You can also tap Start > Camera to launch the camera.

To turn off the camera:

- ▶ Tap  and then tap  on the camera screen.

Capture Modes

The camera on your device allows you to capture pictures and video clips by using various built-in modes that provide you flexibility in taking your shots.







To change the capture mode:

- ▶ Tap  and then tap the middle icon at the bottom of the screen. (The icon displayed is based on the current capture mode.)

The Capture Mode menu then opens. Tap the capture mode you want to use.



You can select from the following capture modes:

Icon	Capture mode
	Photo. Captures standard still images.
	Video. Captures video clips, with or without accompanying audio.
	Panorama. Captures a sequence of still images continuously in one direction, and allows stitching of all the images to create a panoramic view of a scenery.
	MMS Video. Captures video clips suitable for sending via video messaging.
	Contacts Picture. Captures a still image and gives you the option to immediately assign it as a Photo ID for a contact.
	Picture Theme. Captures still images and places them within frames.

Supported File Formats

Using the available capture modes, the camera in your device captures files in the following formats:

Capture mode	Format
Photo / Contacts Picture / Picture Theme / Panorama	JPEG
Video	H.263 (.3gp) 3GPP2 (.3g2) MPEG-4 (.mp4) H.264 (.3gp)
MMS Video	H.263 (.3gp) 3GPP2 (.3g2) MPEG-4 (.mp4)

Zooming

Before capturing a photo or a video clip, you can zoom in or out on your subject.

To zoom in or out, slide your finger up or down on the Zoom bar while holding the device sideways. While you are sliding your finger on the Zoom bar, the level of zoom is shown on the zoom control bar at the left side of the screen.





The camera zoom range for a photo or a video clip depends on the capture mode and resolution. Refer to the resolution and zoom range table for more information.

Capture mode	Resolution		Zoom range
Photo	3M	Normal: 2048 x 1536 Widescreen: 2048 x 1216	1.0x to 1.6x
	2M	Normal: 1600 x 1200 Widescreen: 1600 x 960	1.0x to 1.6x
	1M	Normal: 1280 x 960 Widescreen: 1280 x 768	1.0x to 1.6x
	L	Normal: 640 x 480 Widescreen: 640 x 384	1.0x to 1.6x
	M	Normal: 320 x 240 Widescreen: 320 x 192	1.0x to 3.2x
Video	CIF	352 x 288	1x and 1.6x
	M	176 x 144	1x and 1.6x
	S	128 x 96	1x and 1.6x
MMS Video	M	176 x 144	1x and 1.6x
	S	128 x 96	1x and 1.6x
Panorama	L	640 x 480	1x and 1.6x
	M	320 x 240	1.0x to 3.2x
Contacts Picture	M	272 x 272	1.0x to 3.2x
Picture Theme	Determined by the current template		Depends on the size of the selected template

Using Focus

Use the Auto Focus or Touch Focus function to capture sharp and crisp photos and videos.

Auto Focus

Auto Focus sets the focus on the object at the center of the screen and is available for all capture modes. By default, touching and holding the **Virtual Camera** button () activates Auto Focus and a flashing white bracket () appears in the center of the screen. When focus is set, the bracket changes to a steady green bracket (), and then the Camera takes the photo or starts to record the video.

Touch Focus

Touch Focus allows you to focus on a particular area of the screen. Touch Focus is enabled by default and is only available when you are using Photo or Contacts Picture mode.

Note To disable Touch Focus, see "Settings on the Advanced Options Screen" on page 111.

To use Touch Focus:



1. Set the Camera to Photo or Contacts Picture mode.
2. Touch the area on the screen that you want to focus. The Touch Focus indicator () positions itself on the selected area.

Note If you tap outside the effective focus area, a white box appears to indicate the area where you can use Touch Focus.





3. Tap to activate Auto Focus on the selected area and take the photo. See “Auto Focus” on page 107 for more information.
4. To move the Touch Focus indicator back to the center of the screen, tap .

Capturing Photo or Recording Video

By default, the Camera automatically takes the shot or starts capturing video after you have set the focus.

- In **Photo** or **Contacts Picture** mode, touch the **Virtual Camera** button () to activate Auto Focus. When focus is set, the Camera automatically takes the shot.
- In **Video** or **MMS Video** mode, touch the **Virtual Camera** button () to activate Auto Focus. When focus is set, the Camera automatically starts recording. Touch the **Virtual Camera** button again to stop recording.
- In **Picture Theme** or **Panorama** mode, touch the **Virtual Camera** button () to activate Auto Focus. When focus is set, the Camera automatically takes the first shot. Do the same for each shot you need to take.

After capturing a photo or recording video, the Review screen is displayed. Tap one of the following icons at the bottom of the screen:

Icon	Function
	Back. Return to the live camera screen.
	View. View the captured image or video in the Albums program.
	Delete. Delete the captured image or video.
	Send. Send the captured image via email or picture messaging. You can also send a captured video via email or video messaging.
	Assign to Contact. After capturing in Contacts Picture mode, tap this icon to assign the photo to a selected contact.

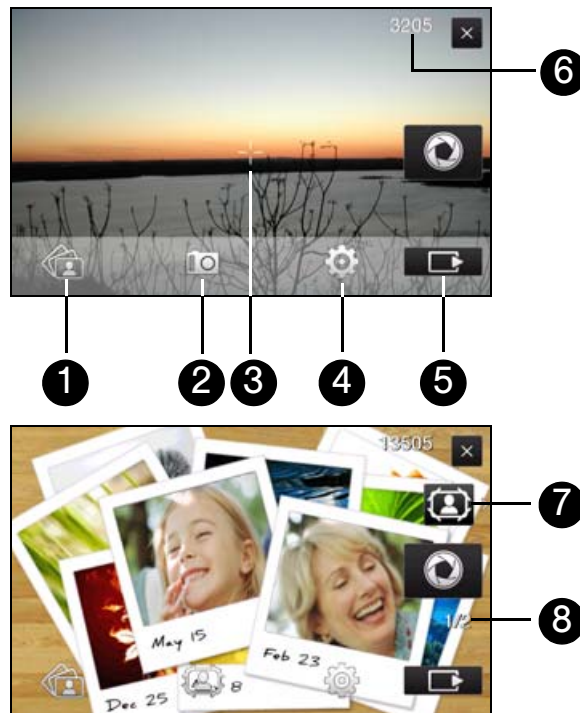

Onscreen Controls and Indicators

Tap  to display onscreen controls and indicators.







1. **Albums.** Open the Albums program to view your captured photos and video clips. See “Viewing Photos and Videos” on page 112 for details.
2. **Capture mode.** See “Capture Modes” on page 105 for details.
3. **Touch Focus / Auto Focus indicator.** See “Using Focus” on page 107 for details.
4. **Menu.** See “Menu Panel” on page 110 for details.
5. **Remaining information indicator.** In Photo, Contacts Picture, Picture Theme, and Panorama modes, this shows the remaining number of pictures you can take based on the current settings. In Video and MMS Video modes, this shows the remaining duration that can be recorded. While recording video, this shows the recorded duration.
6. **Show/Hide icon.** Show or hide the onscreen controls and indicators.
7. **Template Selector icon.** In Picture Theme mode, tap to select another frame.
8. **Progress indicator.** In Picture Theme and Panorama modes, this shows the number of consecutive shots.

Menu Panel

The Menu panel lets you quickly adjust common camera settings and provides access to more advanced camera settings. To open the Menu panel, tap  on the Camera screen, and then tap . To adjust a setting, repeatedly tap a button, for instance, **White Balance**, to cycle through the available settings.

Note The available Menu Panel buttons depend on the selected capture mode.

Icon	Function
	Select the white balance setting according to the current lighting condition to capture colors more accurately.
	Open the Brightness bar and adjust the brightness level. Tap outside the Brightness bar to apply the change.
	Set the ISO level manually to 100 , 200 , 400 , or 800 , or set it back to AUTO . Higher ISO numbers are better for taking pictures in low light conditions. When set to AUTO , the camera automatically adjusts the ISO level up to 400 only.
	Set the self-timer to 2 seconds , 10 seconds , or Off when in Photo or Contacts Picture mode.
	Open the advanced camera settings. See "Setting Advanced Options" (below) for details.

Setting Advanced Options

Tap **Advanced** on the Menu panel to open the Advanced screen where you can configure settings for your selected capture mode.

Navigating the Advanced Screen

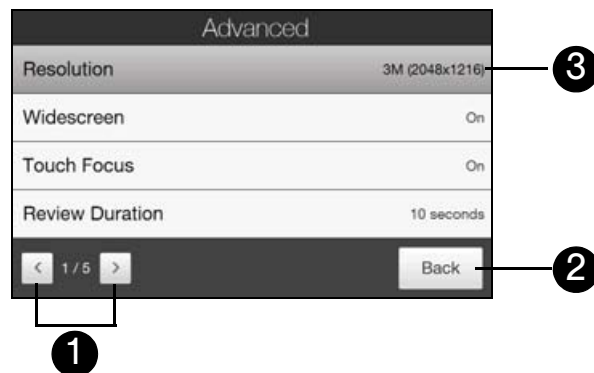

1. Tap the left and right arrows to go through the different pages of settings.
2. Tap **Back** to go back to the live camera screen.
3. Tap an item to change the setting.

Settings on the Advanced Options Screen

- **Resolution.** Select the resolution to use. See “Zooming” on page 106, and refer to the resolution and zoom range table for the available resolutions.
- **Widescreen** (Photo mode). When set to **On** (default), you can use the entire screen as viewfinder. See “Zooming” on page 106, and refer to the resolution and zoom range table for the available widescreen resolutions.
- **Touch Focus** (Photo and Contacts Picture modes). Enables or disables the Touch Focus function. Touch Focus is **On** by default. See “Touch Focus” on page 107 for details.
- **Review Duration.** Set a time length for displaying the captured image or video on the Review screen. Select **No Limit** if you do not want to impose a time limit. Select **No Review** to immediately return to the live camera screen after capturing and saving.
- **Quality.** Select the image quality level for captured photos. Choose from **Basic**, **Normal**, **Fine**, and **Super Fine**.
- **Capture Format** (Video and MMS Video modes). Select the file format for recorded videos.
- **Time Stamp** (Photo mode). Include the date and time on captured photos.
- **Storage.** Select where to save photos and videos. You can either save the files to the main memory, or to a storage card if available.
- **Keep Backlight.** Turn the backlight on or off. This overrides your device backlight settings while you are using the camera.
- **Shutter Sound.** Choose whether you want the camera to make a shutter sound when you touch and hold the **Virtual Camera** button.
- **Image Properties.** Adjust the **Contrast**, **Saturation**, and **Sharpness** before capturing.
- **Effect.** Choose a special effect such as Grayscale or Sepia to apply to your photos or video clips.
- **Metering Mode.** Select a metering mode to allow the camera to measure the amount of light and calculate the best-fit exposure value before capturing. Choose either **Center Area** to measure light using the center area of the subject, or **Average** to measure light using the area around the subject.
- **Prefix.** The file name of a newly captured photo or video is set to “IMAGE” or “VIDEO” followed by a sequential number, for example: IMAGE_001.jpg. You can also choose the current date or date and time as the file name prefix.

Note You can not change the file name prefix when saving captured photos to a storage card. Captured photos are named using the convention IMAGnnnn.jpg (where 'nnnn' is the counter), and are saved to the \DCIM\100MEDIA folder on the storage card.

- **Counter.** Reset the file numbering back to 1.
- **Flicker Adjustment.** When taking indoor shots under fluorescent lighting, keep this setting on **Auto** or change it to the proper frequency (50Hz or 60Hz) of the power in your country to reduce flicker (60Hz throughout the United States).
- **Grid** (Photo mode). Show a grid on the screen so you can easily frame and center your subjects.
- **Record with Audio** (Video or MMS Video mode). Select **On** to record videos with audio, or **Off** to record videos without audio.
- **Recording Limit** (Video mode). Set the maximum duration or file size for recording video.
- **Template** (Picture Theme mode). Select a frame.
- **Template Folder** (Picture Theme mode). By default, templates are stored in the \My Documents\Templates folder on the device's **Main Memory**. If you transferred some templates to a storage card, set this option to **Main + Card**.
- **Show Reminder** (Contacts Picture mode). Select **On** if you want the Camera to prompt you to assign the captured picture to a contact.
- **Direction** (Panorama mode). Choose the direction in which to stitch the photos in a panorama.
- **Stitch Count** (Panorama mode). Select the number of shots to take and stitch into a panorama.

Viewing Photos and Videos

Use *Albums* to view photos and videos on your device. *Albums* also offers a host of features that allow you to play a photo slideshow, share photos and videos, and more.

Launching *Albums*

To open *Albums*:

- ▶ From the Home screen, slide to the Photos & Videos tab and tap *Albums*.
 - or –
 - Tap *Start* > *Albums*.
 - or –
 - On the Camera screen, tap .

Note When you open *Albums* from the Camera, the screen orientation of *Albums* is switched to landscape mode.

The *Albums* Screen

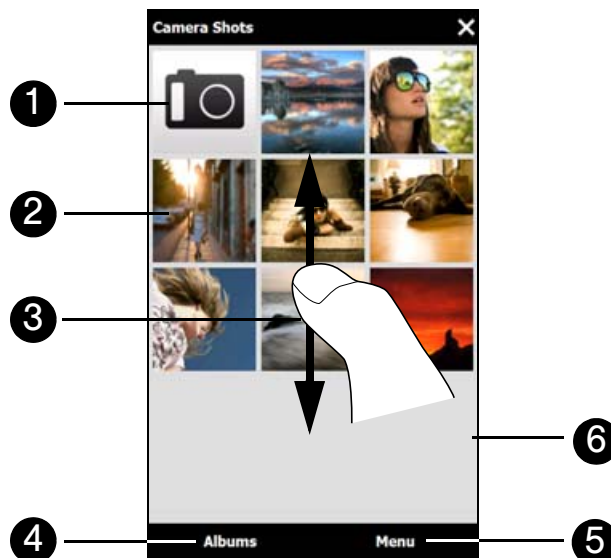

1. Tap the **Camera** icon when you want to use Camera.
2. Tap an image to view it in full-screen mode. See “Viewing a Photo” (below) for details.
3. Browse through the available photos and videos by sliding your finger upward or downward.
4. Tap **Albums** to open a selection menu and choose another album to view. The contents of the album are then displayed on the main *Albums* screen.
5. Tap **Menu** to open a selection menu and choose whether to play a photo slideshow, delete photos or video clips from the current album, and more.
6. Tap a video file (files with the  icon) to play back the video file. See “Playing Videos” on page 115 for details.

Note Animated GIF and video files will not be played back in a slideshow. See “Viewing a Photo Slideshow” on page 115 for details.

Viewing a Photo

While viewing a photo in full-screen mode, tap the screen to open the onscreen menu.

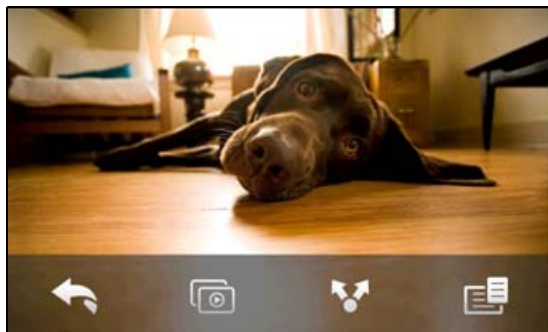

Icon	Function
	Back. Return to the main Albums screen, Photos & Videos tab, or the Camera screen.
	Slideshow. Start a photo slideshow.
	Share. Send the photo using email or MMS, or upload it to Facebook.
	Menu. Open a menu where you can save the screen image as a photo for a contact, save the current image as a new file, delete the image, and view file properties

Tip You can delete multiple files at once by selecting **Menu > Delete Items** on the main Albums screen and then selecting the files to delete.

To view the next or previous photo in the album:

When you are holding your device upright, view the next or previous image by swiping your finger up or down the screen.

When you turn your device sideways, view the next or previous photo by swiping your finger left or right across the screen.

To zoom in or out on a photo:

Double-tap the area on the photo you want to zoom in on. To zoom out, double-tap the screen again.

Tips

- Use the Zoom bar to zoom in on the center of the photo. Slide your finger to the right of the Zoom bar to zoom in. Slide to the left of the Zoom bar to zoom out.
- When you zoom in on a photo, touch and hold the screen to pan and view other areas of the photo. When you zoom in on a photo, tap the screen, tap and then select **Save Screen Image** to save the zoomed in photo as a new file.

To set a favorite album

The Photos & Videos tab on the Home screen displays photos and video files from the current favorite album. By default, the Camera Shots album which stores the photos and videos you captured using the Camera is set as the favorite album. You can change to another favorite album, if preferred.

1. On the Albums main screen, tap **Albums**.
2. On the Albums tab (), tap the album you want to set as your favorite.





3. Tap **Menu > Set Album as Favorite**, and then tap **OK**.

Viewing Facebook Photos

You can use Albums to view photos you and your friends have shared on Facebook. You must be logged in to your Facebook account to be able to view Facebook photos.

1. On the Albums main screen, tap **Albums**.
2. Tap or slide to the Facebook tab ().
If you have not logged in to Facebook, the subsequent screen lets you log in to your Facebook account.
3. Tap the person whose photos you want to view, and then tap an album.
4. Tap a photo to display it in full screen.





While viewing a photo, tap the screen to display and use the onscreen controls.

Icon	Function
	Back. Return to the previous screen.
	Share. Send the photo using email or MMS.
	Reload. Reload the current photo.

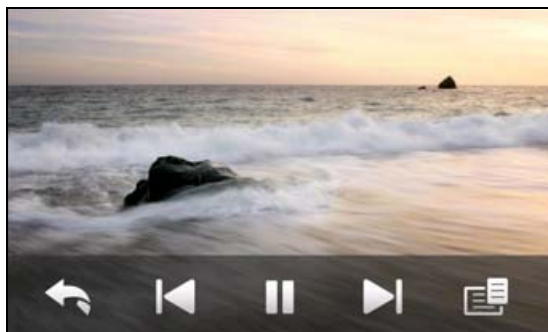
Viewing a Photo Slideshow

To start a photo slideshow, tap the screen, and then tap . While viewing the slideshow, tap the screen to show playback controls.





Icon	Function
	Back. Return to the main Albums screen or the Photos & Videos tab.
	Previous. Go back to the previous photo.
	Play/Pause. Play or pause the slideshow.
	Next. Go to the next photo.
	Menu. Open a menu where you can change slideshow options, such as set the transition effect to use, time per slide, and orientation of the images.

Tip If the photos are in your favorite album, you can start the slideshow from the Photos & Videos tab on the Home screen. On the Photos & Videos tab, tap **Slideshow**.

Playing Videos

While watching a video, tap the screen to display and use playback controls. Tap the playback control icons to pause, resume, stop playback, jump to the start of the video, or switch the display mode. You can also drag your finger across the progress bar to go forward or backward in the video.

Closing Albums

Close Albums by tapping  on the main Albums screen. When viewing files in full-screen mode, tap the screen to show the onscreen menu or playback controls and then tap  to go back to the main Albums screen.

Using Windows Media Player Mobile

Windows Media® *Player Mobile* plays digital audio and video files that are stored on your device or on a network, such as on a website.

To open Windows Media Player Mobile:

- ▶ Tap **Start > Multimedia > Windows Media**.

Windows Media Player Mobile opens and displays the Library screen.

Playing Media

To update the library

In most cases, Windows Media Player Mobile automatically updates the library. However, you can manually update the library to ensure that it contains new files that you recently copied to your device or to the storage card. Tap **Menu > Update Library...** to manually update the library list.

To Play Audio or Video Files

1. On the Library screen, tap the Library arrow (near the top of the screen), and then tap the media storage that you want use, for example, **Storage Card**.
2. Select a category (for example, My Music or My Playlists).
3. Touch and hold the item that you want to play (such as a song, album, or artist name), and then tap **Play**.

The Playback screen opens and plays the audio or video file. Use the playback controls to pause, resume, stop playback, play in full screen, and more.

Synchronizing Video and Audio Files

Use the latest version of Windows Media Player on your computer to synchronize digital media files from your computer to your device. This ensures that protected files and album art (for skins) are copied to your device correctly.

Synchronizing Content to Your Device Automatically

1. On your computer, open Windows Media Player, and then connect your device to your computer.
2. In the Device Setup Wizard, select **Yes, search my computer now**.

Note If you have previously opened Windows Media Player and searched for media on your computer, you will not be prompted to search your computer.

3. On the Device Setup dialog box, enter a name for your device and click **Finish**. Windows Media starts synchronizing the music files in the computer with the device.
4. Click **Stop Sync** and then on the left panel of Windows Media Player, right-click the name of your device and click **Set Up Sync**.
5. Select the playlist(s) that you want to sync between your computer and device, and then click **Add**.

Note On the Device Setup dialog box, make sure that the **Sync this device automatically** check box is selected.

6. Click **Finish**.

The files will begin synchronizing to your device. The next time you connect your device to your computer while Windows Media Player is running, synchronization will start automatically.

Synchronizing Content Manually to Your Device

1. If you have not set up media synchronization between your device and computer, follow steps 1 to 3 in "Synchronizing Content to Your Device Automatically."
2. Click the **Sync** tab on the Windows Media Player of your computer. Select a Playlist or a Library on the left panel of the Windows Media Player.
3. From the Content List, drag the media files that you want to sync to your device and drop them to the Sync List.



1	Playlists and Library List
2	Content List
3	Sync List

4. Click **Start Sync** to start synchronizing the selected files to your device.

Notes

- Use Windows Media Player 11 or higher on your computer to synchronize media files to your device.
- Audio files copy faster if Windows Media Player is configured to automatically set the quality level for audio files copied to your device. For more information, see the Windows Media Player Help.

Playlists

In Windows Media Player Mobile, you can create a new playlist by saving the current Now Playing playlist and giving it a new name.

To save a new playlist:

1. If you are not on the Library screen, tap **Menu > Library**.
2. Tap to select a category (for example, My Music or My Playlists).
3. Select a media file that you want, and then tap **Menu > Queue Up**. This adds the file to the Now Playing list. Repeat this step until you have added all desired media files to the Now Playing list.

Note You cannot select multiple files at the same time.

4. After adding the media files, tap **Menu > Now Playing**.
5. On the Now Playing screen, tap **Menu > Save Playlist**.
6. Enter the playlist name, and then tap **Done**.
7. To play back the playlist you created, tap My Playlists in the Library, select your playlist, and then tap **Play**.

Troubleshooting

If you encounter a problem while using the Windows Media Player Mobile, see the Troubleshooting Windows Media Player Mobile page at the Microsoft website: (<http://www.microsoft.com/windowsmobile/en-us/help/more/windows-media-player.msp>).

Using Audio Booster

Audio Booster optimizes sound for a better listening experience. It provides preset moods, such as hip-hop, jazz, and rock, and several enhancement presets that suit different types of music.

Note To open and use Audio Booster, you need to connect a headset to your device.

To open Audio Booster:

- ▶ Tap **Start > Multimedia > Audio Booster**.

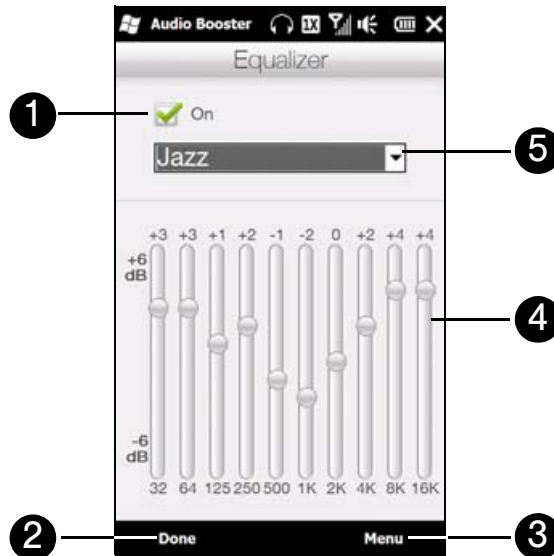

Control	Use
1 <i>On</i>	Select the check box to enable or disable the equalizer.
2 <i>Done</i>	Tap to apply the modified settings.
3 <i>Menu</i>	<ul style="list-style-type: none">● Tap <i>Menu > Cancel</i> to exit Audio Booster without applying the modified settings:● Tap <i>Menu > Save as Preset</i> or <i>Delete Preset</i> to save or delete preset equalizer settings.
4 <i>Frequency Band</i>	Drag the sliders to adjust the frequency.
5 <i>Equalizer Presets</i>	Tap to choose the Equalizer preset to use.

To use an Equalizer preset:

- ▶ Tap the list box and then select a preset.

To create a custom equalizer preset:

1. Adjust the frequency bands by dragging the equalizer controls. The selected values are indicated on top of the sliders.
2. Save equalizer settings as a preset by tapping *Menu > Save as Preset*.
3. Enter a preset name and then tap *Done*. The preset you created will be added to the list box.

Note To delete a custom equalizer preset, select it on the preset list box and then tap *Menu > Delete Preset*. You cannot delete pre-installed equalizer presets.

Using MP3 Trimmer

Use *MP3 Trimmer* to trim MP3 files. You can choose to save a trimmed file as a new file or set it as a ringtone.

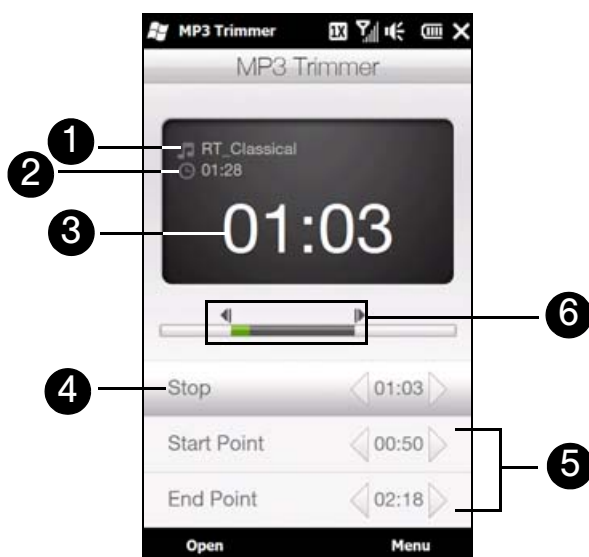

1. Shows the title of the MP3 file.
2. Shows the duration of the trimmed portion.
3. Shows the elapsed playback time.
4. Tap *Play* to start playback, or tap *Stop* to end the playback.
5. For more precise trimming, you can also tap the *Start Point* and *End Point* controls to step backward and forward in one-second increments.
6. The two arrows show the “mark in” and “mark out” points in the music. Use them to mark the part of the music that will be used as the new file or ringtone. Drag the left arrow to mark the start time (*Start Point*), and then drag the right arrow to mark the end time (*End Point*).

To trim the MP3 file:

1. Tap *Start > Multimedia > MP3 Trimmer*.
2. Tap *Open* to find an MP3 file.
3. On the MP3 Trimmer screen, drag the two arrows to adjust the mark in and mark out points.
 - After you set the mark in point, the song will play back starting from the mark in point.
 - After you set the mark out point, the song will play back starting from five seconds before the mark out point.

4. Tap **Play** to play back the trimmed song.
5. Tap **Menu** and select to whether set the file as the default ringtone, save the file to the ringtone folder, or save it using another file name.

Tip

*If you only want to save the song to the ringtone folder for future use, tap **Menu > Save to ringtone folder**. Later on, you can slide to the **Settings** tab and tap **Sound & Display** and then tap **Ringtone** to set it as your ringtone.*

Managing Your Device

- ◆ *Copying and Managing Files (page 121)*
- ◆ *Settings on Your Device (page 122)*
- ◆ *Basic Settings (page 125)*
- ◆ *Using Task Manager (page 128)*
- ◆ *Connecting to an External Display (page 129)*
- ◆ *Protecting Your Device with a Password (page 130)*
- ◆ *Managing Memory (page 130)*
- ◆ *Adding and Removing Programs (page 130)*
- ◆ *Resetting Your Device (page 131)*

You can customize your device to sound, look, and operate just the way you want it to. This section describes how to customize your device to best suit your needs.

Copying and Managing Files

You can copy files between your device and computer, or copy files to the microSD card of your device. You can also efficiently manage your files and folders using File Explorer.

To copy files using Windows Mobile Device Center or ActiveSync:

1. Connect your device to the computer.
2. Click **File Management > Browse the contents of your device** in Windows Mobile Device Center on your computer, or click **Explore** in ActiveSync on your computer. This opens Windows Explorer on your computer and displays the contents of your device.
3. To copy a file from your device to your computer, browse the contents of your device, right-click the file you want to copy, and then click **Copy**.
Right-click a folder on your computer, and then click **Paste**.
4. To copy a file from your computer to your device, browse the folders on your computer, right-click the file you want to copy, and then click **Copy**.
Right-click a folder on your device, and then click **Paste**.

To manage files on your device using File Explorer:

File Explorer lets you browse and manage the contents of your device. The root folder on the device is named **My Device**, and contains the following folders: My Documents, Program Files, Windows, and more.

1. Tap **Start > File Explorer** and then tap a folder or file to open it.
2. To return to an upper level folder, tap **Up**.
3. To quickly delete, rename, or copy a file, touch and hold the file, and then choose the desired operation on the shortcut menu. To copy or delete multiple files, tap and drag over the desired files to select, touch and hold the selection, and then choose the desired operation on the shortcut menu.

Settings on Your Device

To access your device's settings, from the Home screen slide to the Settings tab. The tables below describe about the different settings that you will find on the Settings tab.

Note On the Home screen's Settings tab, tap **Menu > All Settings** to access more settings.

Personalize

Setting	Description
Home tab wallpaper	Select a wallpaper for the Home tab.
Lock screen wallpaper	Change the wallpaper of the Lock screen.
Home screen tabs.	Rearrange or hide Home screen tabs.
Font	Adjust the screen font size to improve readability in some applications.
Vibration	Choose whether to allow your device to vibrate when you tap buttons on certain screens, such as tabs on the Home screen, Phone dialer's keypad, onscreen keyboard, and more.

Wireless Controls

Easily manage and turn on or off connections, including the phone connection, GPRS/3G, Wi-Fi, Bluetooth, and more. See "Comm Manager" on page 89 for details.)

Sound & Display

Setting	Description
Profiles	Choose a profile to automatically set your device with the proper volume level that suits your environment.
Volume	Set a single volume for the ringer and your device, or separately set their volume.
Ring and Notifications	Choose a ringtone and ring type, set different notification sounds for different events such as reminders, new messages, and more. You can also turn <i>Quiet ring on pickup</i> and <i>Pocket mode</i> features on or off.
Display	Turn on the auto brightness feature, or manually set the screen brightness. You can also change the timeout period for dimming the backlight and turning off the display (switching the device to Sleep mode) to conserve battery power.
G-Sensor	Recalibrate the G-Sensor of the device. Do this when screen auto rotation is not working properly.

Data Services

Setting	Description
ActiveSync	Set your device to auto sync your Outlook work email and other information as they arrive in your Exchange Server inbox (Direct Push feature), or set a sync schedule. You can also change the information types to sync and start synchronization manually.
Utilities	Set auto download settings for stocks and weather. You can also enable or disable the option for synchronizing your device with Internet time.
Social Networks	Easily log in or out of your social network accounts such as Facebook, Twitter, and YouTube by simply tapping the Off/On switch of each account.
E-Mail	Set the sync schedule for the Internet email accounts that you have set up on your device.

Location

You can turn location service on or off. When turned on, your current location can be easily determined and used by certain applications on your device. This provides you with accurate information, such as weather in your current location which is displayed on the Home screen.

Security

Setting	Description
Encryption	Encrypt files on your storage card. Encrypted files are only readable on your device.
Certificates	See information about certificates that are installed on your device.
Phone lock	Set a password for your device.
Factory reset	Reset your device to factory default settings.

Application

Setting	Description
Remove programs	Uninstall programs that you previously installed on your device.
Managed programs	Displays the programs that were installed on your device using System Center Mobile Device Manager.

SD Card & Device Storage

Check the storage space and usage information of your device and storage card.

Date & Time

Set local time settings and time format.

Locale & text

Setting	Description
Regional	Set the regional configuration to use, including the format for displaying numbers, currency, date, and time on your device.
Text input	Turn on or off input features such as symbol lock, typing sound, and XT9 predictive settings. You can also view a basic tutorial on entering text with the onscreen keyboard.

Updates & feedback

Setting	Description
Customer feedback	Set your device to automatically send information about how you use Windows Mobile. By default, this option is disabled.
Error reporting	Enable or disable the device's error reporting function. When this function is enabled and a program error occurs, technical data about the state of the program and your computer is logged in a text file and delivered to Microsoft's technical support if you choose to send it.

Other

Setting	Description
Keyboard Sliding Sound	Select a sound to play when you open and close the hardware keyboard.
Hearing Aid Compliance	Enable this setting to reduce interference when using the phone while wearing a hearing aid.
Voice Command	Choose which functions you want to access with voice commands.
TV Out	Set the video format to use when outputting to an external display.
Text Messaging	Choose to view text messages as threaded conversations or individual, unthreaded messages.
Update Profile	Renew or establish information needed to access network voice or data services.
Update PRL	Download the most recent Preferred Roaming List.
Update Firmware	Download the most recent firmware.
Microsoft My Phone	Set up your My Phone account so you can connect your device with the Microsoft hosted website and back up or restore contacts, calendar appointments, photos, and other information wirelessly.
Uploader	Shows the upload progress when you are uploading photos or videos to social networks. Tap <i>History</i> to see what photos or videos you have previously uploaded.
USB to PC	Set the type of USB connection to your PC. Select the <i>ActiveSync</i> option for synchronizing data, or use <i>Disk Drive</i> mode for transferring files.

About phone

Setting	Description
Phone identity	Specify a name to be used for identifying the device to other devices. You can also see basic information such as the model number, IMEI, and serial number of your device.
Hardware information	Shows device specifications such as processor type and speed, storage size, display resolution, and more.
Software information	Shows information such as the Windows Mobile version, ROM version, duration of calls, and more.
Battery	Check the remaining battery power. There is also an option that allows you to enable or disable charging your device's battery when the device is connected to your computer.
About	Shows copyright information.

Basic Settings

Changing Sound and Display Settings

From the Sound & Display screen, you can choose sound settings for your device, such as profile, ringtone, volume level, and different notification sounds. You can also adjust screen brightness.



To select a phone profile

A profile is a preset that determines how your device will alert you when you have incoming calls. Each profile is preconfigured with a sound setting that suits your environment. For instance, **Silent** mutes the ringtone and is ideal for use when you're in a meeting. **Automatic** sets your device to vibrate only when you receive phone calls during scheduled appointments in your Calendar.

- On the Home screen, slide to the Settings tab, tap **Sound & display**, and then select a profile that suits your current environment.

To change the ringtone and ring type

1. On the Home screen, slide to the Settings tab, and then tap **Sound & display**.
2. Scroll down to the **Ring and Notifications** settings.
3. Tap **Ringtone**. Select the ringtone you want to use and then tap **Done**.
4. Tap **Ring Type**. Select the ring type you want to use and then tap **Done**.

Tips

- You can use *.wav, *.mid, *.mp3, *.wma, or other types of sound files that you downloaded from the Internet or copied from your computer. For a complete list of supported audio file formats, see "Specifications" in the Appendix.
- To use your sound files as ringtones, copy them first to the /My Documents/My Ringtones folder on your device, and then select the sound from the Ringtones list of your device. For more information about copying files, see "Copying and Managing Files" in this chapter.

To adjust the system and ring volumes separately

1. On the Home screen, slide to the Settings tab, and then tap **Sound & display**.
2. Turn off the **Single volume** setting by tapping its **Off/On** switch.
3. Drag your finger across the Ringer slider to adjust the ringer volume, and drag across the System slider to adjust the device volume.

Another way is to press the VOLUME UP/DOWN button on the left panel of your device to open the Volume screen. Switch between the Ring Volume and System Volume screens by tapping **Ring** or **System** at the top of the screen, and then drag your finger up or down the volume bars to adjust the volume.

To set notification sounds

You can personalize your device with unique notification sounds for different events such as missed calls, new text messages, new email, reminders, and more.

1. On the Home screen, slide to the Settings tab, and then tap **Sound & display > Notification sounds**.

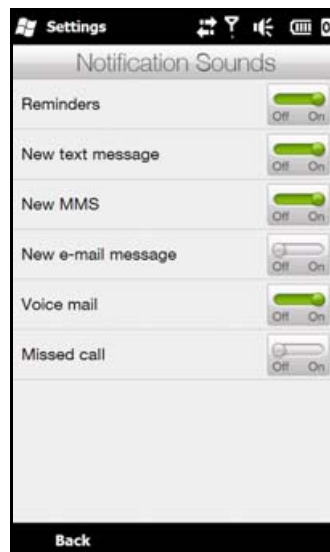

2. On the Notification Sounds screen, tap the left side of the screen that shows the types of events to choose the sound to use for each event. Tapping the **Off/On** switches on the right turns on or off the notification sounds.

To adjust screen brightness

By default, your device automatically adjusts the screen brightness according to the ambient lighting. Turn off auto brightness if you want to be able to adjust the screen brightness.

1. On the Home screen, slide to the Settings tab, and then tap **Sound & display**.
2. Scroll down to the Display setting and then tap **Backlight**.
3. Clear the **Automatically adjust backlight** check box.
4. Adjust the brightness by dragging the slider under **On battery power** and **On external power**.
5. Tap **Done**.

To change backlight and automatic Sleep mode settings

Dimming the backlight and switching the device to Sleep mode help save battery power. You can change the idle time before the backlight automatically dims. You can also change the idle time before the device goes into Sleep mode.

1. On the Home screen, slide to the Settings tab, and then tap **Sound & display**.
2. Scroll down to the **Display** setting and then tap **Backlight**.
3. Under the **On Battery Power** and **On External Power** group of settings, do the following:
 - Make sure the **Dim backlight if device is not used for** option is selected. Tap the box below this option to select a backlight timeout duration.
 - Make sure the **Turn off device if not used for** option is selected. Tap the box below this option to select a sleep mode timeout period.
4. Tap **Done**.

Tip If you do not want the backlight to dim, clear the **Dim backlight if device is not used for** check boxes. To turn off automatic Sleep mode, clear the **Turn off device if not used for** check boxes.

To recalibrate the touch screen:

The device touch screen is calibrated before shipment. Recalibrate the touch screen if it does not accurately respond to screen taps.

1. While the device is on, press and hold the **Volume Up** and **Volume Down** buttons at the same time, and then tap the screen with the stylus to open the align screen.
2. Follow the onscreen instructions to complete the calibration.

Specifying a Device Name

Specify a name to use for identifying your device to other devices, for instance, when synchronizing with a computer, connecting to a network, or restoring information from a backup.

Note If you sync multiple phones with the same computer, each device must have a unique name.

1. On the Home screen, slide to the Settings tab and then tap **About phone > Phone identity**.
2. Enter a device name and then tap **Done**.

Notes

- The device name must begin with a letter, consist of letters from A to Z, numbers from 0 to 9, and cannot contain spaces. Use the underscore character to separate words.
- If you enroll your device to your company's domain, the device name will be changed to be the same as the one used to enroll your device.

Changing Settings of Phone Services

You can change the settings of various phone services for your device. Phone services may include call forwarding, call waiting, voicemail, and more. Contact your mobile operator to find out about the availability of phone services for your device.

1. On the Home screen, slide to the Settings tab, and then tap *Wireless controls*.
2. On the Comm Manager screen, tap *Phone*.
3. Tap the service whose settings you want to change, and then choose your desired options.
4. When finished, tap *OK*.

Using Task Manager

Task Manager shows which programs and processes are currently running on your device.

When you close a program by tapping the Close button  on the top-right corner of the screen, the program still runs in the background. Use Task Manager to switch between programs or stop running programs.

1. Tap *Start > Task Manager*.
2. To switch to a running program, tap the program name and then tap *Menu > Switch To*.
3. To stop running a program, tap the program name and then tap *End Task*.
4. To stop running all programs, tap *Menu > End All Tasks*.
5. Tap *Menu > Exit* to close and stop running Task Manager.

Connecting to an External Display

The TV Out function allows you to view your device's onscreen content on an external display (such as a television) that has composite jacks and uses a standard RCA connection cable.

Important

- You need a TV Out cable accessory to be able to connect your device to an external display. The TV Out cable accessory is sold separately.
- The TV Out feature cannot be used with Sprint TV.

To connect the device to an external display:

1. Turn off the external display.
2. Connect the ends (red, white, and yellow RCA plugs) of the TV Out cable accessory to the corresponding jacks on the external display.



3. Plug the other end of the TV Out cable accessory into your device's sync connector. The TV Out screen opens.
4. Choose **NTSC** and then tap **Done**.

Note If you need to change the video format option again, slide to the **Settings** tab, and then tap **Other > TV Out**.

5. Select the type of media you want to output.
6. Turn on the external display and then switch it to the input signal where you connected your device (for example, Video 1).

The screen orientation is always in landscape mode while your device is connected to the external display.

Protecting Your Device with a Password

You can help keep your data more secure by requiring a password every time the device is turned on.

To set a password:

1. On the Home screen, slide to the Settings tab, and then tap **Security > Phone lock**.
2. Select the **Prompt if phone unused for** check box, and then specify the idle time before the device requires a password. If you choose 0 Minutes, you will need to input the password every time you wake the device up from Sleep mode. For more information, see "Switching to Sleep Mode When Not In Use" on page 12.
3. In the **Password type** box, select the type of password you would like to use.

Tip If your device is configured to connect to a network, use an alphanumeric password for increased security.

4. Enter the password in both the **Password** and **Confirm** boxes.
5. Tap **OK**.

Notes

- To ensure that you can always make emergency calls, do not begin your password with the digits of your local emergency number.
- If you entered a hint, the hint will be displayed after the wrong password is entered five times.
- If you forget your password, you can hard reset or clear the device's memory. For more information about hard resetting the device and clearing the memory, see "Resetting Your Device" on page 131.

Managing Memory

To see how much memory is available for use:

- ▶ Slide to the Settings tab, and then tap **SD Card & Phone Storage**.

The amount of memory allocated to data storage versus program storage is displayed, as well as the amount of memory in use versus the available memory.

Adding and Removing Programs

Additional programs that you purchased can be installed and uninstalled on your device. Your device does not allow you to uninstall most of the preinstalled programs.

Note Before you purchase additional programs for your device, make sure that they are compatible with your device.

Before you launch the program installer, check first whether the installer can directly run on Windows Mobile or needs to be run on a computer.

To install a program directly on your device:

1. If the installer is a .cab file, directly download or copy it to your device.
2. On your device, open **File Explorer** and navigate to the installer file.
3. Tap the file to launch the installer.
4. Choose whether to install the program into the main memory or your storage card, if one is installed on your device.
5. Wait for the installation to complete.

Note You may be prompted to restart your device after installation is completed.

To install a program from your computer:

1. If the installer is an **.exe** file such as **Setup.exe**, the installer will probably need to be run on a computer. Download or copy it to your computer.
2. Connect your device to your computer using the USB cable, and then double-click the installer file on your computer to launch the installer.
3. Follow the onscreen instructions on your computer and your device to complete the installation.

To uninstall a program:

1. Slide to the Settings tab, and then tap **Application > Remove programs**.
2. In the **Programs in storage memory** list, select the program you want to remove, and then tap **Remove**.

Resetting Your Device

Soft Reset

Occasionally, you may need to reset your device. A soft (or normal) reset of your device clears all active program memory and shuts down all active programs. This can be useful when your device is running slower than normal, or a program is not performing properly. A soft reset is also necessary after the installation of some programs. If a soft reset is performed when programs are running, unsaved work will be lost.

To perform a soft reset:

1. Pull out the stylus.
2. Remove the back cover. For instructions, see step 1 in "Installing the Battery" on page 2.
3. Use the stylus tip to press the **Reset** button located at the back of the device.

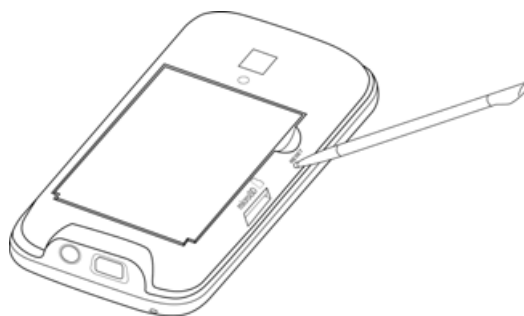

Your device restarts and displays the Home screen.

4. Replace the back cover and insert the stylus back into its compartment.

Hard Reset

You can also perform a hard reset (also known as a full reset). A hard reset should only be performed if a normal reset does not solve a system problem. After a hard reset, the device is restored to its default settings—the way it was when you first purchased it and turned it on. Any programs you installed, data you entered, and settings you customized on your device will be lost. Only Windows Mobile software and other preinstalled programs will remain.

Warning

Your device will revert to factory default settings. Make sure that any additional installed programs or user data have been backed up before you perform a hard reset.

Important

If **Encrypt files when placed on a storage card** is enabled, back up all files from the microSD card before using **Clear Storage**, **hard reset**, or **updating the ROM system software**. Otherwise you will no longer be able to access the encrypted files on the microSD card. Use **ActiveSync** or **Windows Mobile Device Center** to transfer files between your microSD card and computer. After the procedure, copy those files back to the microSD card.

To perform a hard reset:

1. With the device turned off, press and hold the **Talk** and **End** keys first, and then press and hold the **Power** button until you see the following message on the screen:

This operation will delete all your personal data, and reset all settings to manufacturer default. Press VolUp to restore manufacturer default, or press other keys to cancel.

2. Release the **Talk** key, **End** key, and **Power** button.
3. Press the **Volume Up** button to restore the device to factory default status.
– or –
Press any other front panel key to cancel the hard reset and just power on the device.

Clearing Storage

If you can access the device settings, you can use **Clear Storage** to reset your device back to factory default settings.

1. Slide to the **Settings** tab, and then tap **Security > Factory reset**.
2. Enter “1234” and then tap **Yes**.

Section 3

Sprint Service



Sprint Service Features: The Basics

- ◆ Voicemail (page 134)
- ◆ Text Messaging (SMS) (page 137)
- ◆ Video and Picture Messaging (MMS) (page 140)
- ◆ Using Caller ID (page 141)
- ◆ Call Waiting (page 142)
- ◆ Call Forwarding (page 142)
- ◆ Making a Three-Way Call (page 142)
- ◆ Roaming (page 143)

Now that you've explored your device's fundamentals, it's time to learn about the calling features that enhance your Sprint service. This section outlines your basic Sprint service features.

Voicemail

Setting Up Your Voicemail

- ▶ For instructions on how to set up your voicemail, see "Setting Up Your Voicemail" on page 4.

New Voicemail Message Alerts

When you receive a new voice message, your device alerts you that you have voicemail by displaying an icon in the title bar and a pop-up message.

To call your voicemail:

- ▶ New voicemail messages are indicated on the Notifications screen. Tap the notification to call your voicemail. (See "Notifications Screen" on page 19 for more information on the Notifications screen.)

— or —

Press the **Talk** key to display the Phone screen, and then touch and hold  on the Phone keypad.

Retrieving Your Voicemail Messages

You can listen to voice messages directly from your device or from any other touch-tone phone.

Note When you are roaming off the Nationwide Sprint Network, you may not receive notification of new voicemail messages. It is recommended that you periodically check your voicemail by dialing 1 + area code + your wireless phone number. When your voicemail answers, touch  and enter your passcode. You will be charged roaming rates when accessing voicemail while roaming off the Nationwide Sprint Network.

Your device accepts messages even when it is turned off. However, you are notified of new messages only when your device is turned on and you are in a Sprint service area.

Using One-Touch Message Access

- ▶ Press the **Talk** key to display the Phone screen, and then touch and hold  on the Phone keypad.

Using Another Phone to Access Messages













1. Dial your wireless phone number.
2. When your voicemail answers, press *.
3. Enter your passcode.

Tip

When you call into voicemail, you first hear the header information (date, time, and sender information) for the message. To skip directly to the message, touch  during the header.

Voice Mail Key Guide

Below are some Phone keypad functions that you can use while listening to voicemail messages. For further details and menu options, see “Voicemail Menu Key” on page 136.

 Date/Time	 Send Reply	 Advance
 Replay	 Rewind	 Forward
 Erase	 Return Call	 Save
 Cancel	 Help	 Skip





Voice Mail-to-Voice Mail Message Reply

Reply to a voice message received from any other Sprint Voicemail user.

1. After listening to a voice message, tap  on the Phone keypad.
2. Follow the voice prompts to record and send your reply.

Using Expert Mode

Using the Expert Mode setting for your personal voicemail box helps you navigate through the voicemail system more quickly by shortening the voice prompts you hear at each level.

1. Touch and hold  to access your voicemail. (If your voicemail box contains any new messages, tap  to access the main voicemail menu.)
2. Tap  to change your Personal Options, following the system prompts.
3. Tap  for Expert Mode.
4. Tap  to turn Expert Mode on or off.



Voice Mail-to-Voice Mail Message Forwarding

Forward a voice message, except those marked “Private,” to other Sprint Voicemail users.

1. After listening to a voice message, tap  on the Phone keypad.
2. Follow the voice prompts to enter the phone number.
3. Follow the voice prompts to record your introduction and forward the voice message.























Extended Absence Greeting









When your device is turned off or you are off the Nationwide Sprint Network for an extended period, your device can play this greeting instead of your normal personal greeting.

1. From the main voicemail menu, tap  on the Phone keypad for Personal Options.
2. Tap  for Greetings.
3. Tap  to record an Extended Absence Greeting.

Voicemail Menu Key

Following the prompts on the voicemail system, you can use the keypad on the Phone screen to navigate through the voicemail menu. The following list outlines the voicemail menu structure.

-  Listen
 -  Date and Time Information
 -  Send a Reply Message
 -  Advance a Few Seconds
 -  Replay
 -  Rewind a Few Seconds
 -  Forward Message
 -  Erase
 -  Return This Call
 -  Save
 -  Options
 -  Skip to the Next Message
-  Send a Message
-  Personal Options
 -  Settings
 -  Skip Passcode
 -  Autoplay
 -  Play Back Date, Time, and Caller Info.
 -  Change Passcode
 -  Group Distribution Lists
 -  Numeric Paging
 -  Return to Personal Options Menu

- 2  Greetings
 - 1  Personal Greetings
 - 2  Name Announcement
 - 3  Extended Absence Greeting
 - *  Return to Personal Options Menu
- 3  Expert Mode
- 8  Place a Call
- *  Exit

Text Messaging (SMS)

With Text Messaging (SMS), you can send and receive instant text messages between your device and another messaging-ready device. When you receive a new text message, it will notify you by sounding the assigned alert or ringer type and then displaying the SMS icon () in the title bar.

Text Messaging includes a variety of preset messages, such as “I’m running late,” “I’ll be right there,” and more, which make composing messages fast and easy. You can use your device to customize your own preset messages.

Creating a New Text Message

From the Home Screen

1. From the Home screen, slide to the Messages tab.
2. Tap the **New** icon () on the upper right side of the screen.

Tip To send a text message to a favorite contact, first tap the name of the desired contact in the **People** tab to open his or her contact card and then tap **Send Message**. For more information about working with favorite contacts, see “People” on page 38.

From the Messaging Screen

1. Tap **Start > Text**.
2. Tap **Menu > New > SMS**.

From the Contacts List

1. From the Home screen, slide to the **People** tab and then tap **All People**.
2. Tap the contact’s name to open his or her contact card.
3. Tap **Send Message**.

From Windows Mobile Contacts

1. Tap **Start > Outlook > Contacts**.
2. Tap the contact’s name to open his or her contact card.
3. Tap **Send text message**.

Composing and Sending a Text Message

After creating a new text message, follow the steps below to enter your message and then send it.

1. Add recipients. In the **To** field you can:
 - Start entering the first few letters of the recipient's name to display a matching list of names from your stored contacts. Each recipient in the results list may have several phone numbers. Tap the number to which you want to send your text message. To add another recipient, repeat the process.
 - Enter each recipient's mobile phone number separated by a semicolon (;).
 - Tap **Menu > Add Recipient** and then tap a contact from the list.
2. Tap the text box that shows "Tap to compose text" and then enter your text message.
To select from a list of common text messages, tap **Menu > Quick Text** and choose one to insert to your message.
3. When you have finished composing your text message, tap **Send**.

For more information about entering text and symbols, see "Entering Text" on page 24.

Copying and Pasting Text

You can copy words or lines of text from a received message and then paste them to a new text message.

To copy and paste text to your new text message:

1. Open the message where you want to copy text from.
2. Touch and hold the text you want to copy and tap **Make Selection** from the menu that appears.
3. Tap on the starting point where you want to begin copying, and then drag your finger to select the words or lines of text.
4. After selecting the text, touch and hold the selected text, and then tap **Copy**.
5. Create a new message. In the body of the message, touch and hold the position where you want to paste the text, and then tap **Paste**.

Managing Threaded Text Messages

Text messages that are sent to and received from a contact (or number) are grouped as a single thread in your inbox. Threaded text messaging lets you see exchanged messages (similar to a chat program) with a contact on the screen.



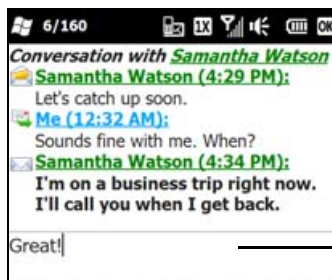

To reply to a text message:

1. In the SMS / MMS inbox, tap a message thread to open it.
2. At the bottom of the screen, type your reply message and then tap **Send**.



Enter your reply message here

To delete a message in the thread:

1. In the SMS / MMS inbox, tap a message thread to open it.
2. Tap the **Input Selector** icon on the bottom of the screen and then select an onscreen keyboard such as **Full QWERTY** or **Phone Keypad**. Tap  or  to navigate up or down the thread and select a message that you want to delete.
3. Tap **Menu > Delete**.

To delete all messages in a thread:

1. In the SMS / MMS inbox, touch and hold a message thread that you want to delete.
2. Tap **Delete**.

To reply to a text message with an MMS message:

You can reply to a text message in a thread using an MMS message.

1. In the SMS / MMS inbox, tap a message thread to open it.
2. Tap **Menu > Insert**, and then in the menu, select the item you want to insert: **Video**, **Picture**, **Audio**, **vCard**, **vCalendar**, or **Attachment**.

Note A **vCard** is a contact card containing details about a selected contact, whereas a **vCalendar** is a calendar appointment.

3. Compose your picture or video message and add text, emoticons, audio, or more attachments. See "Video and Picture Messaging (MMS)" on page 140 for details.
4. Tap **Send**.

Video and Picture Messaging (MMS)

Sending video and picture messages to your friends and family is fun and easy. You can include text with emoticons, videos or photos, audio, and file attachments.

Notes

- If your Sprint service plan does not include Video and Picture Messaging, you will first be prompted to subscribe to the service for an additional monthly charge.
- Make sure the size of the picture or video message is within the allowed limits while sending it to another wireless phone user or to an email address.

Creating and Sending Video and Picture Messages



You can compose a video or picture message in a combination of various slides, where each slide can contain text with emoticons, a video clip or a photo, an audio clip, and file attachment(s).

To compose a picture or video message:

1. Before creating a picture message, set the resolution first for photos to be sent in your picture messages. In the SMS / MMS inbox, tap **Menu > Pics/Video Options**, and then select a photo resolution on the **Preferences** tab. Tap **OK** when done.
2. From the Home screen, slide to the Messages tab and then tap **All Messages**.
– or –
Tap **Start > Text**.
3. Tap **Menu > New > Video Message** or **Picture Message**.
4. In **To**, enter each recipient's phone number or email address separated by a semicolon (;).
– or –
Start entering the first few letters of the recipient's name to display a matching list of names from your stored contacts. Each recipient in the results list may have several phone numbers. Tap the number to which you want to send your text message. To add another recipient, repeat the process.
– or –
Tap **To**, select a contact name, and then select the phone number or email address to send to.

Tip

To send a copy of your video or picture message to others, drag the scrollbar up to display the **Cc** and **Bcc** fields, and then enter their phone numbers or email addresses.

5. Enter a subject for your message.
6. Tap **Insert video** or **Insert photo** to select a video or photo and insert it.
 - To record a new video, tap the **Capture Video** icon ().
 - To capture a new photo, tap the **Capture Image** icon ().
7. Tap **Insert text here** to enter text as well as add emoticons, URL of a favorite website, a preset message, contact information of a certain contact, and/or calendar appointment details. Tap **OK** when done inserting.
8. To add audio, tap **Insert audio**. You can select an existing audio file, or record a new audio clip by tapping the audio recording buttons at the bottom of the screen.
9. When you are ready to send your video or picture message, tap **Send**.



Tips

While composing your video or picture message, you can also do the following:

- To remove a video, photo, text, or audio, open the sliding QWERTY keyboard or an onscreen keyboard, and then use the Up or Down key to highlight the item you want to delete. After selecting the item, tap **Menu > Remove > [item]**.
- Tap **Menu > Slides > Insert Slide** to add a new slide. Tap **Menu > Slides > Delete Slide** to remove a slide.
- If you have added several slides, tap **Menu > Slides > Organize Slides** to rearrange the slides or set the playback duration.

Viewing and Replying to Video and Picture Messages

To view a received video or picture message:



1. In the SMS / MMS inbox, tap a received video or picture message to open it.
2. The video message is then played, or the picture message is displayed. Use the playback controls at the bottom of the screen to stop or resume playback, display in full screen, and switch between slides if there are several slides contained in the message.
3. Tap **Contents** to see a list of files included in the message. On the Message Contents screen, you can do the following:
 - To select a file, open the sliding QWERTY keyboard and then press  or .
 - To save a selected file, tap **Menu > Save**.
 - To save the contents of a text file to the My Text list, tap **Menu > Save into My Text**.
 - To associate a photo to one of your contacts, tap **Menu > Assign to Contact**.

To reply to a video or picture message:

1. In the SMS / MMS inbox, highlight a received video or picture message. To highlight a message, open the sliding QWERTY keyboard or an onscreen keyboard and use its Up or Down key to highlight.
2. Tap **Menu > Reply**.
3. Select whether to reply using a video message or picture message, and then tap **Done**.
4. Compose your video or picture message, and then tap **Send**. For more information about creating and composing a video or picture message, see "Creating and Sending Video and Picture Messages" on page 140.

Using Caller ID

Caller ID allows people to identify a caller before answering the phone by displaying the number of the incoming call. If you do not want your number displayed when you make a call while you are within the Nationwide Sprint Network or a CDMA roaming network, follow these steps.

1. Press the **Talk** key to display the Phone screen.
2. Tap    on the Phone keypad.
3. Enter the number you want to call.
4. Press the **Talk** key to place the call.

To permanently block your number, call Sprint Customer Service.

Call Waiting

When you're on a call, Call Waiting alerts you to incoming calls by sounding two beeps. Your device's screen informs you that another call is coming in and displays the caller's phone number (if it is available and you are in digital mode).



To respond to an incoming call while you're on a call:

- ▶ Press the **Talk** key. (This puts the first caller on hold and answers the second call.)

To switch back to the first caller:

- ▶ Press the **Talk** key again.

To temporarily disable Call Waiting:



- ▶ For those calls where you don't want to be interrupted, you can temporarily disable Call Waiting by tapping    before placing your call. Call Waiting is automatically reactivated once you end the call.

Call Forwarding





Call Forwarding lets you forward all your incoming calls to another phone number – even when your device is turned off. You can continue to make calls from your device when Call Forwarding is activated.

- Notes**
- You cannot forward your calls to an international number.
 - You are charged a higher rate for calls you have forwarded.

To activate Call Forwarding:

1. On the Phone keypad, tap   .
2. Enter the area code and phone number to which your future calls should be forwarded.
3. Press the **Talk** key. (You will see a message and hear a tone to confirm the activation of Call Forwarding.)



To deactivate Call Forwarding:

1. On the Phone keypad, tap    .
2. Press the **Talk** key. (You will see a message and hear a tone to confirm the deactivation.)

Making a Three-Way Call

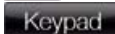
With three-way calling, you can talk to two people at the same time. When using three-way calling on the Nationwide Sprint Network, the normal airtime rates will be charged for each of the two calls. Roaming charges apply when you are roaming off the Nationwide Sprint Network.

1. Place the first call or accept an incoming call.
2. To put the first call on hold and display the phone keypad so you can make the second call, you can do one of the following:
 - Press the **Talk** key.
 - On the Phone screen, tap .
 - On the Phone screen, tap .

3. Tap the phone keypad keys to enter the second phone number, and then press the **Talk** key to make the second call.
4. When you're connected to the second party, do one of the following to begin the three-way call:
 - Press the **Talk** key.
 - On the Phone screen, tap .
 - On the Phone screen, tap .

If one of the parties in the current call hangs up, you and the remaining caller still remain connected.

To end the three-way call, press the **End** key or tap . All other callers will be disconnected.

Roaming

Roaming is the ability to make and receive calls, send and receive text messages, or use data services when you are off the Nationwide Sprint Network. Your device works anywhere on the Nationwide Sprint Network and allows you to roam on other 1900 and 800 MHz digital networks where Sprint has implemented roaming agreements.

Your device allows both voice and data roaming if these services are included in your service plan. Contact Sprint to find out about roaming services and rates.

Recognizing the Roaming Icon on the Display Screen

Your device's display screen always lets you know when you are off the Nationwide Sprint Network. Anytime you are roaming, the device displays the roaming icon () in the title bar.

Tip Remember, when you are using your device off the Nationwide Sprint Network, always dial numbers using 11 digits (1 + area code + number).

Roaming on Other Digital Networks

When you are roaming on digital networks, your call quality and security will be similar to the quality you receive when making calls on the Nationwide Sprint Network. However, you may not be able to access certain features, such as data services, depending on the available network.

Note If you're on a call when you leave the Nationwide Sprint Network, your call is dropped. If your call is dropped in an area where you think Sprint service is available, turn your device off and on again to reconnect to the network.

Checking for Voicemail Messages While Roaming

When you are roaming off the Nationwide Sprint Network, you may not receive on-phone notification of new voicemail messages. Callers can still leave messages, but you will need to periodically check your voicemail for new messages if you are in a roaming service area for an extended period of time.

1. Press the **Talk** key to display the Phone screen.
2. Enter **1**, the area code, and then your phone number.
3. Press the **Talk** key again to call your voicemail.
4. When you hear your voicemail greeting, tap  on the Phone keypad.
5. Enter your passcode at the prompt and follow the voice prompts.

When you return to the Nationwide Sprint Network, voicemail notification will resume as normal.

Setting Roaming Options for Your Device

You can set roaming options for your device to better control your roaming costs.

1. On the Phone screen, tap **Menu > Options... > CDMA Services** tab.
— or —
Slide to the Settings tab, and then tap **Wireless controls > Phone > CDMA Services** tab.
2. Select **Roaming**, and then tap **Get Settings**. The Phone: Roaming screen then appears where you can set options such as the roaming mode as well as Call Guard notification and Data Roam Guard notifications.

Choosing a Roaming Mode

On the Phone: Roaming screen, you can enable or disable roaming by choosing one of the following modes:

- **Sprint Only** to prevent roaming on other networks.
- **Automatic** to seek service on the Nationwide Sprint Network. When Sprint service is unavailable, your device searches for an alternate system.

Using Call Guard

Your device has two ways of alerting you when you are roaming off the Nationwide Sprint Network: the onscreen roaming icon and Call Guard. Call Guard makes it easy to manage your roaming by requiring an extra step before you can place or answer a roaming call. (This additional step is not required when you make or receive calls while on the Nationwide Sprint Network)

To turn Call Guard on or off:

- ▶ On the Phone: Roaming screen, select **On** or **Off**.

Note	<ul style="list-style-type: none">• Call Guard is turned off by default on your phone.• Automatic speed recognition (ASR) and speed dialing are not available when you are roaming with Call Guard enabled.
-------------	--

To place roaming calls with Call Guard on:

1. Press the **Talk** key to display the Phone screen.
2. Enter **1**, the area code, and then the seven-digit number. After entering the number, press the **Talk** key.
3. A pop-up message then appears, informing you that roaming rates will apply. Tap **Dismiss** to close the message, and then tap **1** to place the call.

To answer incoming roaming calls with Call Guard on:

- ▶ When you have an incoming roaming call, tap **Answer** if you want to accept the roaming call.

Note	<i>If the Call Guard feature is set to On, you may need to take extra steps to make and receive roaming calls.</i>
-------------	--

Using Data Roam Guard

Depending on service availability and roaming agreements, your device may be able to access data services while roaming on certain digital systems. You can use the **Data Roam Guard** to alert you when you are roaming off the Nationwide Sprint Network and try to use data services such as messaging.

To set your Data Roam Guard notification:

On the Phone: Roaming screen:

- Select **Never ask** and the **Allow roaming** check box to always allow data roaming without prior notification.
- Select **Never ask** and then clear the **Allow roaming** check box to always disable data roaming.
- Select **Always ask** to enable the Data Roam Guard to always display a confirmation message and alert whenever your device enters a roaming network.
- Select **Default** to enable data roaming internationally. The Data Roam Guard may display a confirmation message and alert.

To use data services when Data Roam Guard is active:

When a notification message appears informing you that data roam charges may apply:

- Tap **Roam** or **OK** to allow data roaming.
- Tap **Cancel** if you don't want to allow data roaming.

Note *If this is your first time using data roaming, the Data Roam Guard will display a second message, informing you about how to change the notification setting.*

Web and Data Services

- ◆ *Ways of Connecting to the Internet (page 146)*
- ◆ *Getting Started With Data Services (page 148)*
- ◆ *Navigating the Web (page 151)*
- ◆ *Using Windows Live (page 155)*
- ◆ *Google Mobile App (page 158)*
- ◆ *Using RSS Hub (page 160)*
- ◆ *Accessing Sprint Instant Messaging (page 163)*
- ◆ *Email Messaging (page 164)*
- ◆ *Working With Company Email and Meeting Appointments (page 168)*
- ◆ *Internet Sharing (page 173)*
- ◆ *Using Remote Desktop Mobile (page 175)*



Your device allows you to wirelessly connect to the Internet, and with Sprint data services, you have access to a dynamic variety of data services you will really use. Data services such as Web browsing, email, instant messaging, and RSS feeds let you have fun, stay in touch, and stay informed no matter where you go on the Nationwide Sprint Network, on a CDMA roaming network, or on a GSM international network when traveling in other countries.

Ways of Connecting to the Internet

Your device's networking capabilities allow you to wirelessly access the Internet or your corporate network through one of the following connections:

- Wi-Fi (see "Connecting via Wi-Fi" on page 147)
- Data Services (see "Getting Started With Data Services" on page 148)

Note You can also add and set up the following connections:

- **Dial-up:** A Dial-up connection is used to dial up to your Internet Service Provider (ISP) and connect to the Internet or to your corporate network. To set up a dial-up connection, slide to the Settings tab, tap **Wireless controls > Data connection**, and then tap **Add a new modem connection**. To get help instructions, tap  and refer to the Help.
- **VPN:** A VPN connection is used to access your corporate network by using an existing Internet connection. For information about setting up a VPN connection, see the **Set Up Your Email** guide.
- **Proxy:** A Proxy connection is used to access the Internet using an existing connection to your corporate or WAP network. To set up a proxy connection, slide to the Settings tab, tap **Wireless controls > Data connection**, and then tap **Set up my proxy server**. To get help instructions, tap  and search for the word proxy in Help.

Connecting via Wi-Fi

Wi-Fi provides wireless Internet access over distances of up to 300 feet (100 meters). To use Wi-Fi on your device, you need access to a wireless access point or “hotspot.”

Note *The availability and range of your device's Wi-Fi signal depends on factors such as the number of walls and other objects through which the signal must pass and background interference caused by microwave ovens and other phones that generate RF signals.*

Connecting to a Wireless Network for the First Time

1. Slide to the Settings tab, and then tap **Wireless controls** to open the Comm Manager.
2. On the Comm Manager screen, tap **Wi-Fi**. Detected wireless networks are then displayed on the screen.
3. Tap the desired wireless network.
 - If you selected to connect to an open (unsecured) network, your device will be automatically connected to the network.
 - If you selected a secured network, enter the security key and then tap **Done**. Your device will then be connected to the network.
4. Tap **Back** to return to the Comm Manager, and then tap **Done** to close the Comm Manager.

When enabled, the **On** indicator is activated and available wireless networks will be detected. Follow the steps in “Connecting to a Wireless Network for the First Time” to choose and connect to a wireless network.

The next time you connect your device to the same secured wireless network, you will not be prompted to enter the network key again (unless you perform a hard reset or clear storage which will erase custom settings on your device).

Note *Wi-Fi networks are self-discoverable, which means no additional steps are required for your device to connect to a Wi-Fi network. It may be necessary to provide a user name and password for certain closed wireless networks.*



Turning Wi-Fi On and Off

Once you have connected to a wireless network, you can turn Wi-Fi off when you do not need Internet access and turn Wi-Fi back on anytime when you need to reconnect to the wireless network.

1. Slide to the Settings tab, and then tap **Wireless controls** to open the Comm Manager.
2. On the Comm Manager screen, tap the **Off/On** switch for Wi-Fi to turn it on or off.
3. If you want to change the Wi-Fi connection to another wireless network, follow the same steps in “Connecting to a Wireless Network for the First Time.”

Checking Wireless Network Status

You can check the current wireless connection status from any of the following screens of your device:

- **Title bar.** When you enable Wi-Fi on your device, the Wi-Fi ON icon  appears on the title bar. After Wi-Fi is turned on, your device scans for available wireless networks and the wireless signal icon  appears on the title bar. The arrows in this icon move back and forth while your device is scanning for a wireless network signal. Once your device successfully connects to a wireless network, the arrows stop moving.
- **Wireless LAN screen.** Slide to the Settings tab, and then tap **Wireless controls > Wi-Fi > Advanced**. On the **Main** tab, you will see the wireless network that your device is currently connected to. The configuration and signal quality of the wireless network are also shown

- **Configure Wireless Networks screen.** Slide to the Settings tab, and then tap *Menu > All Settings > Connections > Wi-Fi* and then tap the **Wireless Networks** button. This screen displays all available Wi-Fi networks in range.
 - Tap a wireless network in the list to view or change its connection settings.
 - To manually add a new wireless network, if available, tap **Add New** and enter or select the required information in the subsequent screens.
 - To connect to a wireless network in the list, touch and hold the desired network, and then tap **Connect**.

Saving Battery Power While Using Wi-Fi

Using Wi-Fi quickly consumes battery power. Turn off Wi-Fi when not in use. You can also enable power saving settings.

1. Slide to the Settings tab, and then tap *Wireless controls > Wi-Fi > Advanced > Power Mode* tab.
2. Move the **Power Save Mode** slider to a position that optimizes performance with the least power consumption.
For example, move the slider to the left (**Best Performance**) to have the optimal wireless network performance; move to the right (**Best Battery**) to obtain the maximum battery usage.

Getting Started With Data Services

Sprint enhances data services with increased broadband speed, and gives you clearer, high-quality visuals and sound when you preview videos and music online. It also offers you exciting services such as Sprint TV, the Sprint Music Store, and YouTube. (For more information about Sprint TV, the Sprint Music Store, and YouTube, see “Entertainment: TV and Music” on page 176.)

Data Services

Here is a brief list of the data services available for your device. For more information, please visit us online at www.sprint.com.

Web Browsing – Experience full-color graphic versions of popular websites from your device. You can use the Opera Mobile (page 151) or Internet Explorer Mobile browser (page 154) to search and browse websites.

Messaging – Send and receive instant messages (page 163) and email messages (page 164) on your device.

Information Services – View the latest news, sports, stock quotes, travel information, and more using the built-in RSS Hub program (page 160).

Your User Name

When you buy your device and sign up for service, you’re automatically assigned a user name. When you use data services on your device, your user name is submitted to identify you to the Nationwide Sprint Network. Your user name will be automatically programmed into your device. You don’t have to enter it.

Finding Your User Name

If you aren’t sure what your user name is, you can easily find it on your device.

- ▶ Slide to the Settings tab, and then tap *About phone > Phone identity*.

Tip

If you choose to change your user name and select a new one online, you must then update the user name on your device. Slide to the Settings tab, and then tap *Other > Update Profile*.

Connecting to Data Services

To connect to data services and access the Internet, you can simply launch the Web browser on your device. You can also connect to data services from the Connections settings screen or the Comm Manager.

Connecting to Data Services Using a Web Browser

- ▶ The fastest way to access data services is by simply launching the Opera Mobile browser from the Internet tab on the Home screen. From the Home screen, slide to the Internet tab and then tap **Launch Browser**.

– or –

You can also launch Opera Mobile by tapping **Start > Opera Browser**.

– or –

To access data services using Internet Explorer Mobile, tap **Start > Internet Explorer**.

Your data connection starts and the Sprint Powerdeck home page is displayed:



Sprint Powerdeck Home Page

Note When you open a Web page in Opera Mobile, the page may be displayed in its smallest size. To reformat Web pages to fit the screen of your device so that the content is readable, set Opera Mobile to display in Mobile View. Tap  > Settings > Display, and then select the Mobile view check box.

Connecting to Data Services from the Connections Screen

1. Slide to the Settings tab, and then tap **Wireless controls > Data connection**.
2. Under the **Sprint** item, tap **Manage existing connections**.
3. Touch and hold **Sprint** to open a shortcut menu, and then tap **Connect**.

Connecting to Data Services from the Comm Manager

1. On the Home screen, slide to the Settings tab, and tap *Wireless controls* to open the Comm Manager.
2. Tap the switch next to *Data Connection*. The switch is in the ON position when your device is connected to data services.

Data Connection Status Icons

Your device displays the current status of your data connection through status icons at the top of the screen. The following symbols are used for data connections:

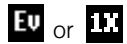
 A high-speed connection to the Sprint Mobile Broadband network (EVDO) or a Sprint 1xRTT data connection is available. These icons in conjunction with the data connection icons below let you know what type of connection your device is using.

 An HSDPA, 3G, GPRS or EDGE network connection when you are roaming internationally.

 Your device has an active connection to the Sprint Mobile Broadband (EVDO), Sprint 1xRTT data network, or a 3G/GPRS/EDGE international network. When active, data is being transferred and you cannot receive calls.

 Your device's data connection is idle. You can receive incoming calls.

If none of the above status icons are displayed, your device does not have a current data connection. To launch a connection, see "Connecting to Data Services" on page 149.

Disconnecting from Data Services

When you do not need to use data services, disconnect your data connection to save battery power and data cost.

1. On the Home screen, slide to the Settings tab, and tap *Wireless controls* to open the Comm Manager.
2. Tap the switch next to *Data Connection*. The switch is in the OFF position when your device has disconnected from data services.

Navigating the Web

To search, browse, and navigate the Web on your device, you can use either the Opera Mobile or Internet Explorer Mobile application.

Using Opera Mobile



Opera Mobile™ is a full-featured Internet browser, optimized for use on your device.

Opening Opera Mobile and Entering a Web Address

1. From the Home screen, slide to the Internet tab and then tap *Launch Browser*.

— or —

Tap *Start > Opera Browser*.

2. If the address bar does not appear, tap  at the bottom-right corner of the screen to display it.
3. Tap the address bar, enter the URL, and then tap .

Note When you open a Web page in Opera Mobile, the page may be displayed in its smallest size. To reformat Web pages to fit the screen of your device so that the content is readable, set Opera Mobile to display in Mobile view. Tap  > Settings > Display, and then select the Mobile view check box.

The Browser Screen

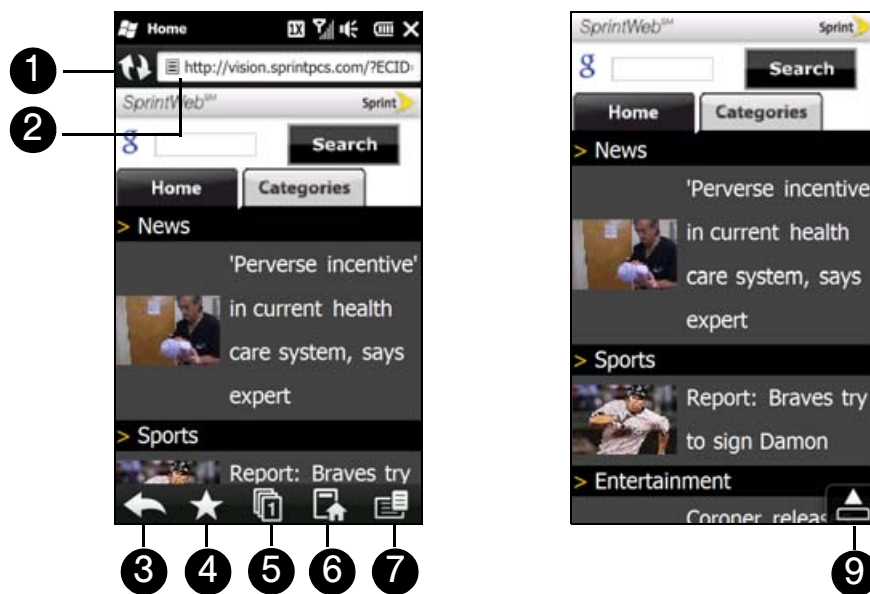

1. **Refresh.** Tap to reload the Web page being viewed.
2. **Address bar.** Enter the URL of a website here.
3. **Back.** Tap to go back to the previous Web page viewed.
4. **Favorites.** Tap to go to the Favorites screen where you can add a favorite, edit favorite Web pages, and send the favorite URL link via one of the Messaging accounts.
5. **Tabs.** Tap to add a new browsing tab or switch to another existing browsing tab.
6. **Home.** Tap to go to the Home page.

7. **Menu.** Tap to open a menu where you can change Opera Mobile settings, check downloads, view History, and more.
8. **Exit Full Screen mode.** When browsing the Web, Opera Mobile automatically switches to full-screen mode. Tap to show the address and Menu bars again.

Searching for Information on the Web

1. On the Opera Mobile screen, tap the address bar.
2. Enter a keyword on the Search field, and then tap .



Viewing Web Pages

While browsing Web pages, use finger gestures to pan and zoom on the Web page. To zoom in, slide to the right of the Zoom bar. To zoom out, slide your finger to the left.

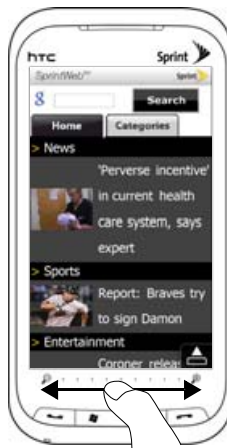

You can also tap the screen twice to zoom in, and tap twice again to zoom out.

Tip Touch and hold an empty area on a Web page to open a shortcut menu that lets you go back to the previous page, reload the page, add the page as a Favorite, and more. You can also touch and hold a link or image on a Web page to open a menu with different options.

Changing the Screen Orientation

► Change the screen orientation by simply turning your device sideways.



Opera Mobile Menu

On the menu bar, tap  to open the menu.

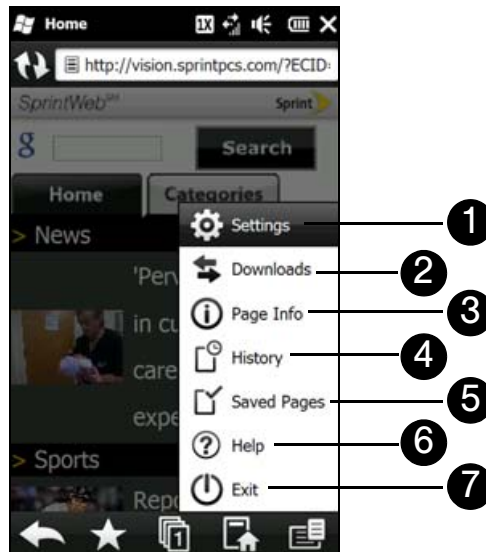

1. **Settings.** Tap to open the Settings screen where you can set the default home page, change display settings, set privacy settings, and more.
2. **Downloads.** Tap to view items being downloaded. You can also resume or stop current downloads.
3. **Page Info.** Tap to view information about the Web page you are browsing.
4. **History.** Tap to see Web pages that you have viewed.
5. **Saved Pages.** Tap to manage and view Web pages that you have saved.
6. **Help.** Tap to open the Opera Mobile help file.
7. **Exit.** Tap to close Opera Mobile completely. Opera Mobile will not run in the background.

Note For more information about using Opera Mobile, go to: <http://www.opera.com/products/mobile/>.

Using Internet Explorer Mobile

Internet Explorer® Mobile is the standard Web browser that is included with Windows Mobile. To use Internet Explorer Mobile, tap **Start > Internet Explorer**.

The Browser Screen

Internet Explorer Mobile displays in two modes: full-screen and normal viewing modes. Full-screen mode hides the address bar and the browser controls. To change from full-screen to normal viewing mode, tap the Restore icon () at the bottom right corner of the browser screen

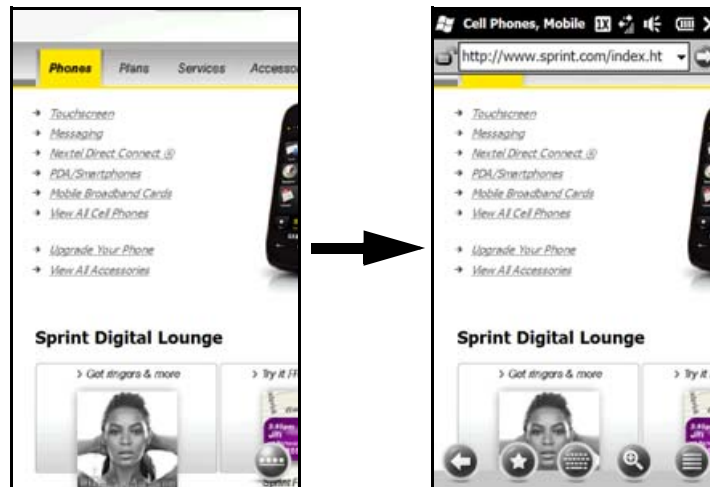



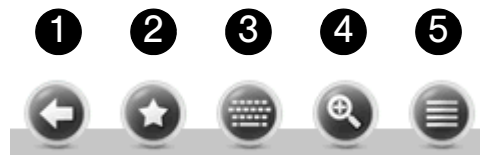

In normal viewing mode, you can use the following browser controls:



1. Return to the previous Web page viewed.
2. Open the Favorites screen where you can add, edit, or delete Web favorites.
3. Display or hide the onscreen keyboard of your device.
4. Display the onscreen zoom slider so you can zoom in or out of the page.
5. Open the browser menu and choose display options and other settings.

Entering a Website Address and Adding it to Your Favorites

1. If Internet Explorer is in full-screen mode, tap the **Restore** icon ().
2. Tap on the address bar, enter the address of the website, and then tap the **Go** icon ().
3. After browsing the website, tap the **Restore** icon () again to display the browser controls, and then tap the **Favorites** icon ().
4. Tap **Add Favorite**.
5. Use the provided title or enter a descriptive title for the website.
6. To save the website address as a favorite, tap **Done**.

Zooming and Panning

Tap the Zoom icon () at the bottom of the browser screen to display and use the onscreen zoom slider. While viewing a Web page, slide your finger up on the onscreen zoom slider to zoom in, or slide down to zoom out.

While zoomed in, drag your finger in any direction to move around the Web page.

Using Windows Live

Windows Live™ gives you a full Internet experience on your device. Windows Live™ helps you to find information, pursue your interests, and get in touch with friends and family on the Internet easier.

Windows Live offers the following key features:

- **Live Messenger**, the next generation of MSN Messenger Mobile.
- **Live Mail**, the next generation of Hotmail.
- **Bing**, which lets you find locations, browse maps, and check for directions. See “Bing” on page 192 for details.
- **Live Contacts**, your address book for storing Live Mail, Live Messenger, and Hotmail contacts.

Setting Up Windows Live

The first time you use Windows Live, sign in using your Windows Live ID, which is your Windows Live Mail or Hotmail address, and password.

To set up Windows Live for the first time:

1. Tap **Start > Windows Live**.
2. Tap the links to read the Windows Live Term of Use and the Microsoft Privacy Statement. After reviewing them, tap **Accept**.
3. Enter your Windows Live Mail or Hotmail address and password, ensure that the **Save password** check box is selected, and then tap **Next**.
4. Tap **Next**.
5. Choose what information you want to sync online with your device.
 - If you select **Store Windows Live contacts in your mobile phone's contact list**, your Windows Live contacts will be added to the contact list and to Windows Live Messenger on your device.
 - If you select **Sync e-mail**, your Windows Live Mail or Hotmail inbox messages will be downloaded to your device.
6. Tap **Next**.
7. After synchronization is complete, tap **Done**.

The Windows Live Interface

On the Windows Live main screen, you will see a search bar, navigation buttons, and an area where you can show and customize your profile.



1. **Display Picture.** Tap your display picture to change your display name, picture, or personal message.
2. **Menu Items.** Tap the menu items to access Windows Live Messenger, Windows Live Mail, or to synchronize your Windows Live contacts.
3. **Search Bar.** To search for websites, enter search keywords and then tap .
4. **Menu.** Tap **Menu** to access and change settings.

Windows Live Messenger

With this mobile version of Windows Live Messenger, you enjoy many of the same features that you get from the desktop version, which include the following:

- Instant messaging via text and voice
- Multiple conversations
- Inserting emoticons
- Contact list with online or offline status
- Sending and receiving files (including photos)
- Changing the status and display name
- Viewing contacts by online status, groups, and more
- Sending messages even when a contact is offline

Note Before you can use Windows Live Messenger, your device must be connected to the Internet. To find out how to connect your device to the Internet, see "Ways of Connecting to the Internet" on page 146.

Launching Messenger and Signing In

- To open Windows Live Messenger:
 - Tap **Start > Messaging > Messenger**.
 - or –
 - On the Windows Live main screen, tap **Messenger**.
- Tap **Sign in** on the Messenger screen.
- If this is your first time to sign in, a message appears to inform you that your messenger contacts will be added to the contact list on your device. Tap **OK** to add them. Signing in may take several minutes, depending on your connection speed.

Tip To sign out from Windows Live Messenger, tap **Menu > Sign out**.

Starting and Ending Conversations

- Select a contact, and then tap **Send IM** to open a message screen. Enter your text message in the text entry area of the message screen.

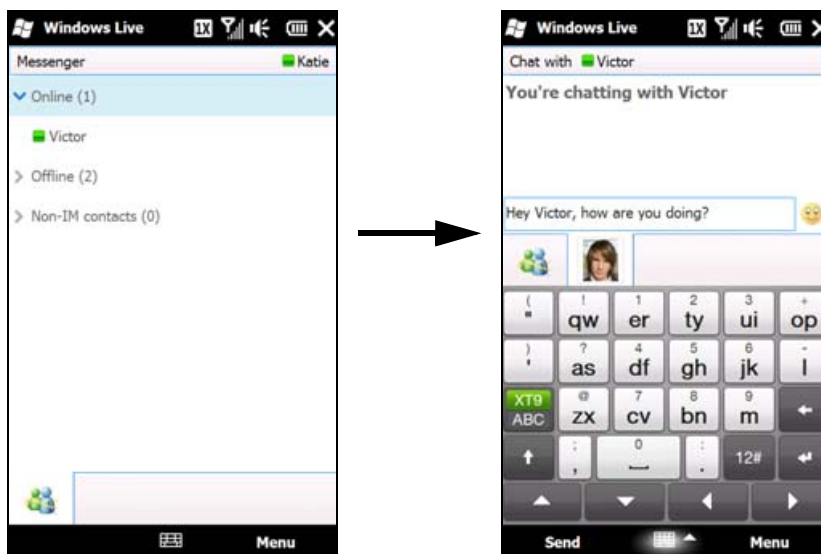

- To add an emoticon, tap 😊 and then tap an icon from the list.
- Tap **Send**.
- To end a conversation with the current contact, tap **Menu > End conversation**.

Tips

- To send a file, tap **Menu > Send**. You can choose to send a picture, voice clip or any file.
- To invite one or more contacts to the conversation, tap **Menu > Options... > Add participant**.
- To send a voice message, tap **Voice clip** on the chat screen and then start talking. After you have recorded a message, tap **Send**.

Adding Windows Live Contacts

You can add new Windows Live contacts in Windows Live Messenger or in Contacts.

To add a Windows Live contact in Live Messenger:

1. Tap **Menu** > **Add new contact**.
2. Enter the email address of the contact, and then tap **OK**.

To add a Windows Live contact in Windows Mobile Contacts:

1. Tap **Start** > **Outlook** > **Contacts**.
2. Tap **New**, and then tap **Windows Live**.
3. In the **IM** box, enter the email address of the contact, which can be a Windows Live ID or any other email address.

Tip You can fill in other information about the contact, if desired. This is not necessary if you will communicate with the contact only through Live Messenger or Live Mail.

4. Tap **OK**.
5. Follow the onscreen instructions to add the new contact to your Windows Live contact list.

Google Mobile App

Google Mobile App features a convenient toolbar that gives you access to Google mobile applications, which include the following:

- **Google search bar.** Allows you to enter keywords and search for information on the Web using Google Search.
- **Google Mail.** Allows you to access your Google Mail account on the Opera Mobile browser.
- **Google Maps.** Allows you to download, install and use the Google Maps Mobile application on your device.
- **YouTube.** Allows you to download, install and use Google YouTube application on your device.
- **Other Google applications.** Includes Google mobile applications such as Calendar, News, Picasa Web Albums, and more.

Warning There is already a preinstalled YouTube program available on your device which is different from Google YouTube. Installing Google YouTube will remove and replace the original YouTube program.





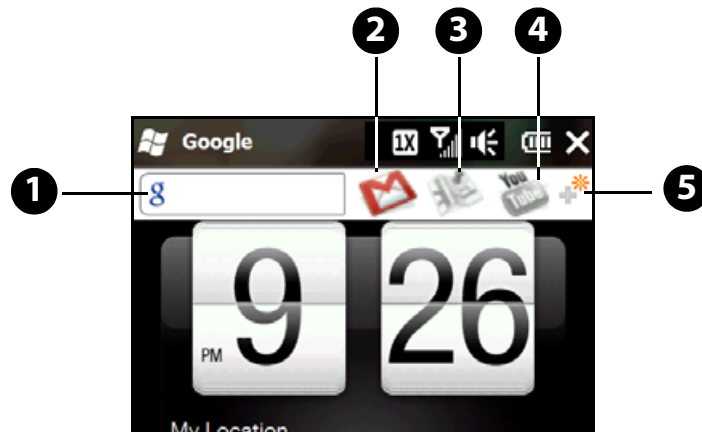

Installing Google Mobile App

1. Tap **Start** > **Google**.
2. Opera Mobile then opens and displays a Google Web page containing a hyperlink to the Google Mobile App. Tap the **Download Google Mobile App** hyperlink.
3. The next screen displays a message, asking whether you want to install the application. Tap **Open** and follow the onscreen instructions to complete the installation.

Displaying the Google Mobile App

Tap **Start** > **Google Mobile App** to display the Google Mobile App. You will then see a toolbar on top of the screen, right below the title bar.



1. **Google search bar**. To find information on the Web, use the sliding QWERTY keyboard or an onscreen keyboard to enter a search keyword on the search bar and then press the **Enter** key on the keyboard. Opera Mobile then opens and displays search results.
2. **Google Mail** (). Tap to open Opera Mobile and display the Google Mail sign-in Web page so you can log in and access your Google Mail messages.
3. **Google Maps** (). This icon appears grayed out when the Google Maps Mobile application has not yet been downloaded and installed on your device. Tap the grayed icon to download and install the application. After installation is completed, open Google Mobile App to display the toolbar again and then tap  to start using Google Maps Mobile.
4. **Google YouTube** (). This icon appears grayed out when the Google YouTube application has not yet been downloaded and installed on your device. Tap the grayed icon to download and install the application. After installation is completed, open Google Mobile App to display the toolbar again and then tap  to start using Google YouTube.
5. **More From Google** (). Tap to access more Google mobile applications.

Using RSS Hub

RSS Hub is an RSS reader that keeps you up-to-date with the latest news from the Internet. It monitors Internet news channels and downloads the most current news updates and podcasts so you are instantly informed of breaking news and events.

This section provides basics on using RSS Hub. For more information and tips on using RSS Hub, see the RSS Hub Help on your device. Tap **Start > Help**, tap **Help for Added Programs**, and then tap **RSS Hub**.

Note Make sure you have an active Internet connection before using RSS Hub. To find out how to connect to the Internet, see "Ways of Connecting to the Internet" on page 146.

Subscribing to and Organizing News Channels

You must subscribe to news channels before you can receive RSS feeds.

To subscribe to news channels:

1. Tap **Start > Tools > RSS Hub**, and then tap **Continue**.
2. On the New Channel Wizard screen, select the **Choose from a list of known Channels** option, and then tap **Next**. A list of RSS channels is displayed.
3. Channels are grouped by categories. To select all channels in a category, select the category check box. You can also select the check boxes of individual RSS channels that you want to subscribe to.

Note If the RSS channel you want to subscribe to is not in the list of known channels, tap **Back**, and then select another option on the New Channel Wizard screen. For more information about the available options, see the RSS Hub Help on your device.

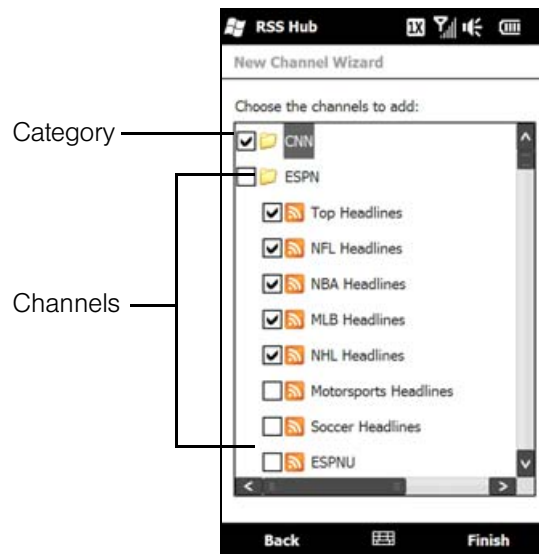

4. After selecting the desired channels, tap **Finish**.
5. The list of your selected channels appears. Tap **Refresh** to update the channels.

6. After the refresh is completed, the number of headlines per channel will be displayed on the right side of the screen.



To add new channels:

1. In the channel list, tap **Menu > Channel > New** to open the New Channel Wizard screen.
2. Select an option, and then follow screen instructions to add new channels. For more information on New Channel Wizard options, see the RSS Hub Help on your device.

To filter the channels in the display:

In the channel list, tap **Menu > View**, and then select:

- **All** to display all subscribed channels.
- **Updated** to display only those channels with unread headlines.





To manage channel categories:

- To view all the channels in a particular category, tap **All Categories** in the upper left area of the channel list, and then tap the category you want to display.
- To add a new category, tap **Menu > Categories** in the channel list to display all categories, and then tap **Menu > New**.
- To rename or delete a category, tap **Menu > Categories** in the channel list to display all categories, select a category, and then tap **Menu > Rename** or **Menu > Delete**.
- If you want to change the channel category, touch and hold the channel in the channel list, and then tap **Change Category**. Select a new category and then tap **OK**.

Viewing Headlines

Tap a channel in the channel list to display the headlines for that channel.



1.  New or unread headlines display in bold and are marked with a blue newspaper icon. When you tap the headline, a news summary will be displayed. Scroll down the summary screen and then tap **Read More Online...** to open the Opera Mobile browser and view the complete headline.
2.  Headlines that have been read are marked with a gray newspaper icon.
3.  Tap this icon to download the podcast or image attachment.
4.  indicates that the podcast or image attachment is downloading.
5.  After download is completed, tap this icon to play back the podcast or view the image.

Tip After downloading a podcast, tap **Menu > Podcast > Save** to save a copy of the file to the device main memory or microSD card (if one is installed.)

Sharing the Headline Link

To share a headline that you have read with other people, you can send the link to the headline in a text, picture, video, or email message.

1. Tap a headline to view the news summary.
2. On the news summary screen, tap **Menu > Send Link via Email**.
3. Messaging opens and displays the Account Picker screen. Tap the account you want to use to send the headline link.
4. Specify the recipients, and then send it.

Accessing Sprint Instant Messaging

The Sprint Instant Messaging application provides you with access to popular instant messaging (IM) communities, including AOL® Instant Messenger™, MSN® Messenger, and Yahoo!® Messenger.

1. To launch Sprint Instant Messaging, tap **Start > Instant Messaging**.
2. A message appears, informing you to add a messaging and data plan to your service plan. Tap **OK** to close the message.
3. Tap a community: **AOL Instant Messenger**, **MSN Messenger**, or **Yahoo! Messenger**.

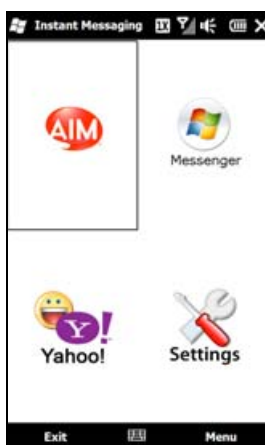

4. Enter the required sign-in information for the selected community, such as user name or password, and then tap **Sign In**.

Note The information required to sign in will vary depending on the instant messaging community you are accessing.

The instant messaging screen for your selected community will then be displayed, and you can start chatting online with your friends or family.

Email Messaging

Types of Email Accounts

You can set up the following types of email accounts on your device:

- Outlook email messages that you sync with your computer or the Exchange Server.
- Email accounts that you have with an Internet Service Provider (ISP) or other email provider.
- Web-based email accounts.
- Work accounts that you access using a VPN connection. See the *Set Up Your Email* guide for details.
- Custom domain email accounts. The email domain name is hosted by a different email provider. For more information, tap *Start > Help* and then search for *custom domain e-mail* in Help.

Synchronizing Outlook Email with the Computer

If you have installed the synchronization software on your computer and created a partnership with your device, and then your device is ready to send and receive Outlook email messages.

If you have not yet installed the synchronization software nor created a partnership, see “Setting Up Windows Mobile Device Center on Windows 7 and Windows Vista” on page 76 or “Setting Up ActiveSync on Windows XP” on page 77 for instructions.

Tip

To set up your company email account so that you can access Outlook email messages wirelessly, you must set up your device to synchronize via an over-the-air connection with your company's Exchange Server. For more information about synchronizing with your company email server, see “Setting Up an Exchange Server Connection” on page 168.

Setting Up an Internet Email Account

Use *Mail Setup* to easily add Web-based email accounts.

1. From the Home screen, slide to the Mail tab.
2. If this is your first time to set up an email account, tap *Add Account*. If you are setting up subsequent accounts, tap *Menu > Add Account*. The Mail Setup screen then opens, guiding you to set up your email account.
3. Enter your email address and password, and then tap *Next*.
4. Enter your name and the account display name, and then tap *Next*. Mail Setup then searches for the email provider settings on your device.

If the settings are not found on your device, you will be prompted to enter the email account settings manually, such as the *Incoming mail server* and *Outgoing mail server*. Obtain the email account settings from your email provider.

5. Tap *Send/Receive email automatically*, and then choose how often you want email messages to be automatically sent and downloaded on your device.
6. Tap *Done*.

Creating and Sending an Email Message

After setting up email accounts on your device, you can start sending and receiving email messages.

Starting from an Empty Email Message

1. From the Home screen, slide to the Mail tab.
2. Select the email account you want to use on the right side of the screen.
3. Tap the **New Mail** icon () to create a new email message.

Sending an Email Message to a Favorite Contact

1. From the Home screen, slide to the **People** tab.
2. Swipe your finger on the screen to flip through the photos of your favorite contacts.
3. When the photo of the desired contact is displayed, tap the contact's name and then tap **Send Email**.

For more information about working with favorite contacts, see "People" on page 38.

Tip To send email to a contact that is not on the People tab, tap **All People**, scroll through the list, tap the desired contact name, and then tap **Send Email**.

Composing and Sending an Email Message

After opening a new email message, follow the steps below to enter your message and then send it.

1. To add recipients:
 - Start entering the first few letters of the recipient's name to display a matching list of names with email addresses from your stored contacts. Tap the email address to which you want to send your email.
 - Enter their email addresses, separating them with a semicolon.
 - Tap **To** if you want to add email addresses stored in Contacts.
2. Enter a subject and compose your message.
3. To choose from preset messages, tap **Menu > My Text** and tap a desired message. To check the spelling, tap **Menu > Spell Check**.
4. To add an attachment to your message, tap **Menu > Insert** and tap the item you want to attach: **Picture**, **Voice Note**, or **File**. Select the file or picture you want to attach, or record a voice note.
5. Tap **Send**.

Tip

- For more information about entering text and symbols, see "Entering Text" on page 24.
- If you are working offline, email messages are moved to the Outbox folder and will be sent the next time you connect.

Filtering the Inbox Message List

When the Inbox on your device is full of messages, you can filter your Inbox to display only the messages that contain a particular sender or subject you are searching for.

To filter your Inbox:

1. Tap **Start > E-mail** and then tap an email account.
2. Enter the sender name or email subject you want to look for. As you type characters, the message list narrows down to the sequence of characters you have entered.

For example, entering "B", and then "E" narrows the list to only the email messages that contain sender names and email subjects that start with "BE."

Viewing and Replying to Email Messages

To view an email message:

1. From the Home screen, slide to the Mail tab, select an email account, and then tap **Inbox**.
2. Swipe your finger up or down the screen to browse through received email messages.
3. Tap an email message to open it.

To download a complete email message:

By default, each email received in the inbox on your device contains only the first few kilobytes of the message. When you open an email message, it displays only the headers and part of the message. You must download the whole email to view the complete content.

To download a complete email message, open the email and then do one of the following:

- ▶ Finger-scroll to the end of the message, and tap **Get entire message and any attachments** (POP3 email account) or tap **Get the rest of this message** (IMAP4 and Outlook email accounts).
— or —
Tap **Menu > Download Message**.

Notes

- The Fetch Mail feature, which is available for POP3 and IMAP4 Internet email accounts, downloads an entire email without the need for you to perform a full synchronization. This limits the download to just the email message that you want and helps save data cost. Fetch Mail is also available for Outlook Email. See “Instant Email Download Using Fetch Mail” on page 170 for details.
- Downloading may take some time, depending on the speed of your Internet connection, email file size, and whether file attachments are automatically downloaded.

To download file attachments:

- **POP3 email account:** File attachments of a POP3 Internet email account are automatically downloaded when you download a complete email.
- **IMAP4 and Outlook email accounts:** File attachments appear below the subject of an email message. Tapping an attachment opens the attachment if it has been fully downloaded or marks it for download the next time you send and receive email.

You can set automatic downloading of file attachments. See “Customizing Email Settings” on page 167 for details.

To reply to or forward a message:

1. Open the message and tap **Menu > Reply**, **Menu > Reply All**, or **Menu > Forward**.
2. Enter your response, and then tap **Send**.

Notes

You can receive and view HTML email from any type of email account. The HTML format is retained, without layout shifting or resizing. HTML email support in Outlook Mobile is available only if you are synchronizing your device with Microsoft Exchange Server 2007.

Synchronizing Email

Synchronizing email ensures that new email is downloaded to the device Inbox folder, that in the Outbox folder is sent, and that email deleted from the server is removed from your device. The exact way that you synchronize email depends on the type of email account you have.

To automatically synchronize an Outlook email account:

- ▶ Connect your device to your computer through USB or Bluetooth. Otherwise, connect through Wi-Fi or a data connection if you are synchronizing Outlook email messages with the Exchange Server. For more information, see “Ways of Connecting to the Internet” on page 146.

Synchronization automatically begins, and your device sends and receives Outlook email messages.

To manually synchronize your Outlook or Internet email account:

1. Slide to the Mail tab on the Home screen, or tap **Start > E-mail**.
2. Select your email account.
3. Tap **Menu > Send/Receive**.

Customizing Email Settings

You can make changes to your email account settings or customize the email download and size settings.

To modify Internet email account settings

1. From the Home screen's Mail tab, tap **Menu > Account Settings**.
2. Tap the email account that you want to modify and make the necessary changes. You can change your email address, password, email provider settings, and more, if you mistyped or chose any wrong options when you were setting up your account.

To change the sync schedule for an Internet email account

1. On the Home screen, slide to the Settings tab, and then tap **Data services**.
2. Scroll down the screen to see your email accounts.
3. Tap the email account whose sync schedule you want to change.
4. Make sure the **Send/Receive E-mail automatically** option is selected, and then tap the box under this option to choose a time interval for synchronizing email.
5. Tap **Done**.

To customize advanced settings for an Internet email account

1. Tap **Start > E-mail**.
2. Tap **Menu > Options** and then tap the email account that you want to modify.
3. On the subsequent screen, you can:
 - Tap **Edit Account Setup** to modify settings such as your email address, password, and more, if you mistyped or chose any wrong options when you were setting up your email account.
 - Tap **Send/Receive Schedule** to select the number of days of messages to download to your device.
 - Tap **Download Size Settings** to set the message format to either HTML or plain text, select a download size for email messages, and choose whether or not to include file attachments when downloading email (for IMAP4 accounts only).

To modify settings for Outlook email

1. Disconnect your device from the computer.
2. Tap **Start > Tools > Active Sync**.
3. Tap **Menu > Options...**, select **E-mail**, and then tap **Settings**.
4. On the E-mail Sync Options screen:
 - Under **Message format**, select HTML or Plain text.
 - Under **Download size limit**, select the desired email size.
 - Select whether to include file attachments when downloading email to your device.
5. Close ActiveSync and reconnect your device to the computer.

Storing Attachments on the microSD Card

1. Tap **Start > E-mail**.
2. Tap **Menu > Options > Storage** tab.
3. Select the **When available, use this storage card to store attachments** check box

Working With Company Email and Meeting Appointments

To keep up-to-date with your company email and meeting schedules while you're out of the office, you can connect your device to the Internet through Wi-Fi or your Sprint connection and synchronize with your company's Exchange Server.

Setting Up an Exchange Server Connection

Before you can synchronize or access information on the Exchange Server, you need to set up an Exchange Server connection on your device. You need to get the following information from your network administrator and enter them on your device:

- Exchange Server name (must be Outlook Web Access server name)
- Domain name
- User name and password that you use at work

If you have not synchronized your device with your computer, follow these steps to set up an Exchange Server connection.

1. From the Home screen, slide to the Mail tab.
2. Tap **Add Account** at the bottom-right of the screen if this is your first time to set up an account. Otherwise, if you have previously added other accounts on the Mail tab, tap **Menu > Add Account**.
3. On the subsequent screen, tap **Outlook**.
4. Enter your work email address and password, and then tap **Next**.

Mail Setup will download Exchange Server settings to your device.

Note *If Exchange Server settings cannot be downloaded to your device, you need to obtain the Exchange Server settings, such as the domain and Exchange Server address, from your network administrator and enter them in the provided text boxes. (The server address must be the Outlook Web Access address.)*

*Also consult your network administrator if the option, **This server requires an encrypted (SSL) connection**, needs to be enabled or disabled.*

5. Select **Mail** and other information types to sync with the Exchange Server.

6. By default, your device is set to use Direct Push so that Outlook email and other information can be instantly synchronized to your device as they arrive or are updated on the Exchange Server at work.

If you do not want to use Direct Push, you can set a regular schedule for synchronizing Outlook email and other information to your device. Tap **Advanced Settings** and then set the **Peak time** and **Non-peak time** accordingly.

Tip You can select a shorter interval in the **Peak time** box and a longer interval in the **Non-peak time** box so that Outlook email and other information are synchronized more frequently during your work hours.

7. Tap **Done**. Your device then syncs with the Exchange Server and downloads your email messages.

Starting Synchronization

Before you start synchronizing with the Exchange Server, make sure your device has been set up with a Wi-Fi or data connection to the Internet so that you can synchronize over the air. For more information about connections, see “Ways of Connecting to the Internet” on page 146.

After you finish setting up an Exchange Server connection, your device automatically starts synchronization.

To manually start synchronization:

1. On the Home screen, slide to the Settings tab, and then tap **Data services**.
2. Tap **ActiveSync**.
3. Tap **Sync now**.

Note If you connect your device to your office computer via a USB or Bluetooth connection, you can use this connection to the computer to “pass through” to the network and download Outlook email messages and other information to your device.

Working With Company Email

Your device gives you instant access to your company email and lets you manage your messages easier. Direct Push, Fetch Mail, Remote email search, and email flags are just some of the tools you can use to manage your email messages. This section shows you how to use these tools to manage your email.

Note Some messaging features depend on the Microsoft Exchange Server version used in your company. Check with your network administrator for the availability of these features.

Automatic Synchronization Using Direct Push

Direct Push technology (push email feature) enables you to receive new email messages on your device as soon as they arrive in your Inbox on the Exchange Server. Items such as contacts, calendar, and tasks are also immediately updated onto your device when these items have been changed or new entries have been added on the Exchange Server. To make Direct Push work, you need to have a Wi-Fi or data connection on your device.

You need to perform a full synchronization between your device and the Exchange Server first before Direct Push can be enabled.

Requirement The Direct Push feature works for your device only if your company is using Microsoft Exchange Server 2003 Service Pack 2 (SP2) with Exchange ActiveSync or higher version.

You can turn on Direct Push in the Comm Manager or ActiveSync.

To turn on Direct Push in Comm Manager:

1. Slide to the Settings tab, and then tap **Wireless controls**.
2. On the Comm Manager screen, tap Microsoft Direct Push's **OFF/ON** switch.

To turn on Direct Push in ActiveSync:

1. Disconnect the device from your computer.
2. Tap **Start > Tools > ActiveSync > Menu > Schedule**.
3. Select **As items arrive** in the **Peak times** and **Off-peak times** boxes.

Note When Direct Push is off, you need to manually retrieve your email messages.

Scheduled Synchronization

If you do not want to use Direct Push, you can set a regular schedule for synchronizing Outlook email messages and information.

1. Disconnect the device from your computer.
2. Tap **Start > Tools > ActiveSync > Menu > Schedule**.
3. Select a shorter time interval in the **Peak times** box for you to be able to receive email messages more frequently. (Peak times usually refer to your working hours when email volume is high).
4. Select a longer interval in the **Off-peak times** box.

Tip To set the days and hours that make up your peak and off-peak times, tap the **peak times** link at the bottom of the screen.

Instant Email Download Using Fetch Mail

The **Fetch Mail** feature downloads an entire email message immediately without the need for you to perform a full Send/Receive action. This limits the download to just the email message that you want and helps to reduce data service charges.

Requirement Fetch Mail works for your device only if your company is using Microsoft Exchange Server 2007 or higher.

1. From the Home screen, slide to the Mail tab, select your **Outlook** account, and then tap **Inbox**.
2. Open an email message.
3. By default, only the first few words of the message is shown. To download the whole email message, finger-scroll to the end of the message, and then tap **Get the rest of this message**.
4. Wait for the remainder of the message body to download.

Notes

- For information about changing email sync options such as setting the download size for email, see "Customizing Email Settings" on page 167.
- When you receive an email message that contains a link to a document such as a PDF or Microsoft Office document located on SharePoint or an internal file server, you can tap the link to view the document on your device. You can view the document only if you have a Microsoft Outlook account that synchronizes with Microsoft Exchange Server 2007 or later. Exchange Server must also be set up to allow access to SharePoint document libraries or internal file servers.

Searching for Email on the Exchange Server

You can access email that is not available on your device by searching your Microsoft Exchange Server mailbox. The search results are downloaded and displayed in a Search Results folder.

Requirement Your company must be using Microsoft Exchange Server 2007 or higher.

1. Tap **Start > E-mail > Outlook E-mail**.
2. Tap **Menu > Tools > Search Server**.
3. In the **Look for** text box, enter the search keyword.
4. Choose the date range of messages to search from.
5. In the **Look in** list, specify whether to search in the **Inbox**, **Sent Items**, or **All Folders**.
6. Tap **Search**.

Tip To clear the search results and return to the message list, tap **Menu > Clear Results**.

Flagging Your Messages

Flags serve as a reminder for you to follow up on important issues or requests contained in email messages. Flagging messages, which has been a useful feature on desktop Outlook Email, can also be done in Outlook Mobile on your device. You can flag received email messages on your device.

Requirement Flags are enabled only if email messages are synchronized with Microsoft Exchange Server 2007 or higher. Flags are disabled or hidden if email is synchronized with earlier versions of Microsoft Exchange Server.

To flag or unflag a message:

1. Open Outlook on your device and access the Inbox.
2. Select a message or open a message.
3. Tap **Menu > Follow Up** and select one of the following options:
 - **Set Flag** to mark the message with a red flag to indicate that it needs following up.
 - **Complete Flag** to mark the message with a check mark to indicate that the issue or request in the email is already completed.
 - **Clear Flag** to remove the flag to unmark the message.

Note Email message reminders are displayed on your device if the messages are flagged with reminders and synchronized from the Exchange Server.

Out-of-office Auto-reply

Outlook Mobile allows you to retrieve and change your out-of-office status. Just like desktop Outlook Email, Outlook Mobile automatically sends an auto-reply message when you're not available.

To send out-of-office auto-reply messages:

1. Tap **Start > E-mail > Outlook E-mail**, and then tap **Menu > Tools > Out of Office**.
2. In the **I am currently** list, select **Out of the Office**.
3. Enter your auto-reply message, and then tap **Done**.

Managing Meeting Requests

When you schedule and send meeting requests from your device, you can invite attendees to your meeting and check their status to know about their availability.

When you receive a meeting request, you can reply by accepting or declining the request. The meeting request also clearly indicates whether there are conflicting or adjacent meetings.

Requirement Your company must be using Microsoft Exchange Server 2007 or higher.

To reply to a meeting request:

1. When you receive a meeting request by email, a notification will be displayed on your device. Open the email.
2. Tap **Accept** to reply and accept the meeting request, or tap **Menu > Decline** if you cannot attend the meeting.

Tips

- Before responding, you can check your availability during the time of the requested meeting by tapping **View your calendar**.
- If the time of the meeting conflicts with your other appointments, a "Scheduling Conflict" status appears on top of the email.

3. Choose whether to edit your response email before sending it, and then tap **OK**.

If you accepted the meeting request, it will automatically be added as an appointment in Calendar on your device.

To view the list of meeting participants:

1. Tap **Start > Outlook > Calendar**.
2. Tap a meeting request that you sent and then tap **Attendees**. The required and optional attendees will be listed.

Icons indicating whether each attendee has accepted or declined the meeting request will also be displayed.

Tips

- To see the icon indicators in the attendees list, make sure Calendar is synchronized with the Exchange Server.
- For information about creating a meeting request, see "Sending a Meeting Request" on page 85.
- To view an attendee's contact information, tap the attendee's name. If the attendee is included in your contacts list, you will see the contact information immediately. If the attendee is not in your contacts list, tap **Company Directory** to view the contact information.

Finding Contacts in the Company Directory

In addition to having contacts on your device, you can access contact information from your organization's Company Directory. By having over-the-air access to the Company Directory, you can easily send email messages and meeting requests to anyone in your company.

Requirement Access to the Company Directory is available only if your organization is running Microsoft Exchange Server 2003 SP2 or higher, and you have completed your first synchronization with the Exchange Server.

When Browsing Contacts, Composing Email, or Creating a Meeting Request

1. Synchronize with the Exchange Server.
2. Do any of the following:
 - While browsing through your contacts on the Contacts or Phone screen, tap **Menu > Company Directory**.
 - In a new email message, tap the **To** box (or tap **Menu > Add Recipient**), and then tap **Company Directory** on the top of the list.
 - When creating a meeting request and selecting required and optional attendees in Calendar, tap **Company Directory**.
3. Enter a partial or full contact name and tap **Search**. In the search results list, tap a contact to select it.

- | | |
|--------------|---|
| Notes | <ul style="list-style-type: none"> • You can save a contact from the Company Directory to your device by selecting the contact, and then tapping Menu > Save to Contacts. • You can search on the following information as long as that information is included in the Company Directory: First name, Last name, Email name, Display name, Email address, or Office location. |
|--------------|---|

When Viewing a Received Outlook Email Message

1. Open a received Outlook email message.
2. If a **Search** button () appears to the right of the sender name in the email message, tap this button to search for the sender in the Company Directory.
3. If the sender is found, the contact details will be displayed. You can then choose to save the sender to your contacts, call the sender, and more.

Internet Sharing

Internet Sharing connects your computer to the Internet by using your device's data connection. You can connect via USB or Bluetooth.

- | | |
|--------------|--|
| Notes | <ul style="list-style-type: none"> • To use a Bluetooth connection, make sure your computer has built-in Bluetooth capability. If your computer does not have Bluetooth, you can connect and use a Bluetooth adapter or dongle on your computer. • When you launch Internet Sharing, ActiveSync will automatically disconnect. |
|--------------|--|

Internet Sharing Using USB

1. On your device, tap **Start > Tools > Internet Sharing**.
2. In the **PC Connection** list, select **USB**.
3. In the **Network Connection** list, select the name of the connection that your device uses to connect to the Internet.
4. Plug in the USB Sync cable between your device and the computer, and then tap **Connect**.

Internet Sharing Using Bluetooth

1. On your device, turn on Bluetooth and set it to visible mode by following the steps in "Turning Bluetooth On and Making Your Device Visible" on page 100.
2. Initiate a Bluetooth partnership from your device by following the steps in "Creating a Bluetooth Partnership" on page 101.
3. Tap **Start > Tools > Internet Sharing**.
4. Select **Bluetooth PAN** as the **PC Connection**.

5. From the **Network Connection** list, select the name of the connection that your device uses to connect to the Internet.
6. Tap **Connect**.
7. On your computer, set up a Bluetooth Personal Area Network (PAN) with your device:
For Windows 7:
 - a. Click **Start > Control Panel > Network and Internet > Network and Sharing Center**.
 - b. Under **Change your networking settings**, click **Set up a new connection or network**.
 - c. Click **Connect to a Bluetooth personal area network (PAN)**, and then click **Next**.
 - d. In the Bluetooth Personal Area Network Devices dialog box, select your device and then click **Connect using > Direct connection**.*For Windows Vista:*
 - a. Click **Start > Control Panel > Network and Internet > Network and Sharing Center**.
 - b. Click **Manage network connections** and then under **Personal Area Network**, double-click **Bluetooth Network Connection**.
 - c. In the Bluetooth Personal Area Network Devices dialog box, select your device, and then click **Connect**.*For Windows XP:*
 - a. Click **Start > Control Panel > Network Connections**.
 - b. Under **Personal Area Network**, click the **Bluetooth Network Connection** icon.
 - c. Under **Network Tasks**, click **View Bluetooth network devices**.
 - d. In the Bluetooth Personal Area Network Devices dialog box, select your device, and then click **Connect**.

Note If the Bluetooth adapter or dongle on your computer was installed using a third-party driver, open the Bluetooth software that came with the Bluetooth adapter or dongle to connect your computer and device via Bluetooth. Refer to the Bluetooth adapter or dongle documentation for more information.

8. On your device, tap **Accept** to connect to your computer.

Turning Off Internet Sharing

To end a USB connection

- ▶ On the Internet Sharing screen, tap **Disconnect**.

To end a Bluetooth connection

- ▶ On the Private Networking screen, tap **Menu > Remove**.

Using Remote Desktop Mobile

Remote Desktop Mobile lets you access your computer remotely from your device through the USB, Bluetooth, Wi-Fi, or data connection and use programs which are available on your computer.

To configure the remote desktop display:

Before you connect to your remote computer, configure the Remote Desktop Mobile to optimize the remote computer display on your device.

1. Tap **Start > Tools > Remote Desktop Mobile**.
2. Tap **Options**.
3. On the **Display** tab, do any of the following:
 - In the **Colors** option, select **256 Colors**.
 - Select the **Full screen** check box to display the remote desktop in full-screen mode.
 - When using programs which are specifically configured for use with your device, select the **Fit remote desktop to screen** check box to adjust the desktop proportions to fit your device's screen.
4. Tap the **Resources** tab, and then do the following:
 - In the **Device storage** option, select whether to map device storage to the remote computer or disable mapping.
 - In the **Remote desktop sound** option, select **Mute** to mute audio, select **Play on remote computer** to play audio on the remote computer, or select **Play on this device** to play audio on your device.
5. Tap **OK**.

To connect to a remote computer:

1. Tap **Start > Tools > Remote Desktop Mobile**.
2. On the Remote Desktop Mobile screen, enter the computer name (or IP address), user name, password, and domain of the remote computer, and then select the **Save password** check box.
3. Tap **Connect**. When connected, you can now access and start using the desktop computer programs on your device.

To disconnect from the remote computer:

- ▶ Tap **Disconnect** on your device.
- or –

When in full-screen mode, tap **Start > Shut Down**, tap **Log Off**, and then tap **OK**.

Entertainment: TV and Music

- ◆ *TV (page 176)*
- ◆ *Music – Sprint Music Store (page 178)*
- ◆ *Streaming Media (page 180)*
- ◆ *YouTube (page 181)*
- ◆ *NASCAR Sprint Cup Mobile (page 183)*
- ◆ *NFL Mobile Live (page 186)*

Sprint TV gives you the ability to listen to audio clips and to view video clips right from your device's display. Watch live TV and catch up on episodes of your favorite shows – anywhere on the Nationwide Sprint Network.

Sprint Music lets you preview, purchase, download, and listen to over a million songs right on your device. You can even add songs from your own library to round out your on-the-go playlist.

TV

Your Sprint TV Channel Options

The Sprint TV application offers a wide variety of accessible channels. Subscription options include comprehensive basic packages as well as a full menu of “a la carte” channels. Visit www.sprint.com for more information on channels and pricing.

Some of the available categories may include:

- Sprint Radio
- Sprint Power View
- Primetime TV
- Music Videos
- Sprint TV Live
- Music & Radio
- Sports
- Entertainment
- Cartoons
- News & Weather
- Movies & Shorts
- Mobile Previews

Tip Available categories and content are subject to change.





Playing a Video or Audio Clip

1. From the Home screen, slide to the Sprint TV tab and then tap **Launch**.
– or –
Tap **Start > Sprint TV**.
2. Tap **Continue** to connect to data services.
3. Select **Sprint TV**, **Sprint Radio**, **Sprint Movies**, or **Premium Channels** to display channel options.

4. Select a channel from the Sprint TV listings or select an available category.

Note The first time you access a channel, you will be prompted to purchase access (unless the channel doesn't have a monthly fee). Select **Subscribe** to purchase access, or select **Preview** to view a preview of the selected channel.

5. If applicable, select a clip and tap **OK** to view the program. The clip will automatically load and begin playing.

Tip While you are playing a clip, open the sliding QWERTY keyboard and then press  or  to surf to a different channel. A small pop-up screen will be displayed that tells you which channel you are watching as well as other channels that you have access to. Press  or  to scroll through the channels. Once you find a channel that you want to watch or listen to, scroll to it and tap **OK** (or simply wait approximately three seconds), and the channel will begin loading.

TV FAQs

1. **How long are the clips? Will I know the estimated time it will take to play the clip prior to accessing it?**

Once you have selected a channel, you will see a listing of the available clips, with each clip's length displayed after the clip's title. In general, a clip's duration will depend on the story or content being provided, and can be fairly short or as long as a few minutes.

2. **Can I access a clip wherever I am, as long as I have my device?**

As long as you are on the Nationwide Sprint Network, you will have access to the audio and video clips.

3. **Are the videos that I'm viewing "live" videos?**

It depends on the content provider. Some of the channels available through Sprint TV stream live content. Others provide media on demand with video and audio clips that are refreshed throughout the day, but that are not "live."

4. **After purchasing access to an Available Channel for a monthly fee, do I receive any confirmation? That is, how do I know it has been purchased?**

The next time you access the channel, you bypass the Preview/Purchase page and go directly to the available content.

5. **If I don't subscribe to a data services plan from Sprint, will I still be able to view the multimedia clips?**

Yes. For service access charges, please consult your Sprint service plan or [visit www.sprint.com](http://www.sprint.com).





6. **What does it mean when the video pauses and I see the word "loading" at the bottom of the screen?**

This happens when the device is loading the data necessary to play the clip. It typically occurs when there is heavy traffic on the network.

7. **How can I cancel service if I decide I don't want it?**

To cancel your Sprint TV service, visit www.sprint.com and sign on to My Sprint Wireless with your account number and password. From this page, you have the ability to cancel the service or any channels to which you subscribe.

8. **Can I surf to a different channel while I am playing a clip?**

Yes. While you are playing a clip, you can open the sliding QWERTY keyboard and then press  or  to surf to a different channel. A small pop-up screen will be displayed that tells you which channel you are watching as well as other channels that you have access to. Press  or  to scroll through the different channels. Once you find a channel that you want to watch, scroll to it and touch it (or simply wait approximately three seconds), and the channel will begin loading.

Music – Sprint Music Store

The *Sprint Music Store* enables you to purchase and download digital music files to play on your device.

Accessing the Sprint Music Store

From the Sprint Music tab of the Home screen, you can connect to the Nationwide Sprint Network and access the Sprint Music Store. When you enter the store for the first time, you will be prompted to set up your user identification and password.

1. On the Sprint Music tab of the Home screen, tap *Menu > Sprint Music Store*.



2. Follow the onscreen instructions to establish your User ID and password.

Tip Your User ID for the Sprint Music Store is your 10-digit wireless phone number. The password may be any 4-digit number.

3. After you have entered your password, highlight *Create New Account* and tap *OK*.
4. Use the sliding QWERTY keyboard to explore the store.

Purchasing and Downloading Music

Now that you're in the store, you can shop for songs to purchase and download to your device's main memory or a microSD card.

1. From the Sprint Music Store opening page, select an option to browse the store:
 - **Search** gives you the option of searching for specific songs or artists. Just use one of the onscreen keypads of your device to enter your search criteria in the available field.
 - **Featured** offers a revolving selection of highlighted songs and artists.
 - **Genres** allows you to choose from different types of music such as Hip Hop/Rap, R&B, Pop, Inspirational songs, and more.
 - **Categories** allows you to choose from other types of categories.
2. Select a song by tapping on the song title. and tap *OK*. (The song information screen will be displayed.)
3. Tap *Preview* to play the selected song.

4. When you are ready to purchase the song, tap on the displayed price. This confirms your purchase and begins the download process.

The song will be downloaded to your device (\Music).

Note If you have a microSD card inserted, you have the option to download the song to it.

Once the song has been downloaded to your device's memory, you will be able to immediately listen to it, add it to a playlist, or continue shopping.

Playing Music

- ▶ The Sprint Music tab of the Home screen allows you to play the song that you purchased and downloaded to your device. See "Sprint Music" on page 52 for details.

Receiving an Incoming Call While Playing Music

An incoming call causes the currently played music file to be paused while the phone call is active. Once the current call is ended, you can select to resume any paused applications. (Music will resume playing automatically.)

1. When you receive an incoming call, tap **Answer** on the Phone screen.
2. When you are done with your call, tap **End Call** on the Phone screen or press the **End** key to end the call. The previously paused application then resumes.

Backing Up Your Downloaded Music Files

Sprint recommends you back up your downloaded music files to your computer. Although the downloaded files can only be played on your device and on your account, backing them up to your computer lets you access the files in case your microSD card is lost or damaged, or if you install a new microSD card.

1. Use your computer to navigate to the Music folder of your device (that is, go to this path: \Music).

Note If you downloaded the music files to the microSD card, go to \Storage Card.

2. Select and copy the music files to a folder on your computer's hard drive.

Note Although you can store purchased and downloaded music files on your computer, they will only be playable on your device and on your account.

Streaming Media

Streaming Media lets you stream live broadcasts or on-demand media content from the Web. The media is sent in a continuous stream to your device and is played as it arrives, along with the audio.

The Streaming Media program allows you to play 3GP and MPEG-4 files. It also supports playback of SDP (Session Description Protocol) files.

To access streaming content via the Web browser:

In a Web browser such as Opera Mobile, you can open a Web page containing RTSP (Real Time Streaming Protocol) links to streaming media content then play the content in the Streaming Media program.

1. From the Home screen, slide to the Internet tab, and then tap **Browser**.
2. In the address bar, enter the URL address of the Web page that contains the RTSP link to the desired *.3gp, *.mp4, or *.sdp file.
3. On the Web page, tap the RTSP link.
4. Streaming Media then automatically opens and starts playing the file. During playback, use the button controls to play or pause the stream, switch to full-screen mode, rewind, and fast forward.

To stream media files directly on the Streaming Media Player:

Streaming Media only supports RTSP links when you stream *.3gp and *.mp4 files directly on the program.

Note Before you launch the Streaming Media program, make sure that you are connected to the Internet.

1. Tap **Start > Multimedia > Streaming Media**.
2. From the program, tap **Menu > Connect**.
3. Enter the address for the website (rtsp://) and the file name.
4. Tap **Connect**.
5. Streaming Media then starts playing the file. During playback, use the onscreen button controls to play or pause the stream, switch to full-screen mode, rewind, and fast forward.

To view streaming video information:

- ▶ Tap **Menu > Properties** to view the properties and general information of a streaming video clip, such as video codec, audio codec, dimension, frames, and duration of the video.

To configure streaming video connection settings:

- ▶ Tap **Menu > Options** to configure the Streaming Media settings. You can set the media buffer, select the connection to use, and set all streaming videos to play in full screen.

YouTube

YouTube™ lets you browse, search, and watch video clips from the YouTube server.

Note You need an active connection to use YouTube. If you are using a data connection, your data connection bill may increase significantly due to large file sizes of the videos.

To open YouTube:

- ▶ Tap **Start > YouTube**.

Introducing the YouTube Screen

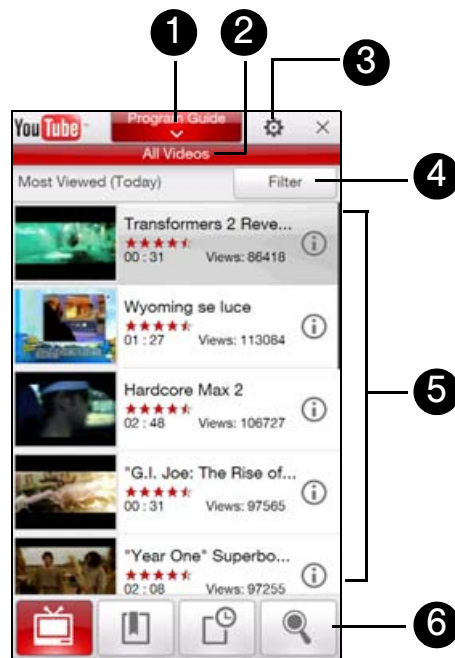

1. **Program Guide.** Tap to open the Program Guide list. The Program Guide list only appears if you are subscribed to a channel.
2. **Channel.** Displays the current program channel being viewed.
3. **Settings.** Tap to set the quality of downloaded videos and site (country) preference.
4. **Filter.** Tap to filter the list by type of video (**Featured**, **Most Viewed**, **Top Favorited**, or **Top Rated**) and by the time period when videos were uploaded to the YouTube server.
5. **Video List.** Displays the available videos for the selected program channel. Tap a video to watch it.
Tap **i** to view details about the video.
6. **Tabs.** Tap these tabs to switch between the different YouTube screens: **Bookmarks**, **History** and **Search**.



Searching for Videos

1. On the YouTube screen, tap .
2. On the Search screen, enter the video information and then tap **Search**.
YouTube searches for the video, and then displays all related videos on the screen.
3. Tap a video to play it.

Using the Program Guide

The Program Guide categorizes videos into channels so you can browse and watch related videos available on YouTube. You can also add your favorite video channel in the Program Guide.

To add a new channel:

1. Search the channel or video you want to add to the Program Guide. See “Searching for Videos” for details.
2. In the search results list, tap  at the right side of the video or channel to open the details screen.
3. Tap  and then tap **OK** on the confirmation screen.

The channel you just subscribed to will now be shown when you tap **Program Guide**.

Tip You can also add a search information as a program channel.

To change the program channel:

1. On the Videos screen, tap **Program Guide** at the top of the screen.
2. On the Program Guide menu, scroll through the available channels and then select a channel.
The video list refreshes to display the available videos for the newly selected channel.

To delete a program channel:

You can only delete program channels that you have added to the Program Guide.

1. Tap **Program Guide** at the top of the screen.
2. Scroll down to the channel you want to delete and then tap .
3. On the confirmation screen, tap **Yes**.

Watching Videos

Tap a video on any YouTube tab, program guide channel, or search results list to play the video. Use the onscreen controls at the bottom of the player to control the playback.

To adjust the playback volume, press the **Volume Up** or **Volume Down** button on the left panel of the device.

After you stopped or finished watching the video, you can add the video to Bookmarks, send the link to this video by email, choose to watch other related videos, and more.



Bookmarks

You can save frequently viewed videos to Bookmarks for quick access.

To view Bookmarks:

- ▶ On the YouTube screen, tap . Tap a video to watch it.

To add a video into Bookmarks:

- ▶ After watching a video, tap .
- or –
- On the list of videos, tap  on the video you want to add to Bookmarks and then tap .

To delete a video from Bookmarks:

1. On the Bookmarks screen, tap *Edit*.
2. Tap  on the video you want to remove from Bookmarks.
3. On the confirmation screen, tap *Yes*.
4. Tap *Done*.

History

View recently watched videos on the History screen. On the YouTube screen, tap  and then tap a video to watch it.

To clear the History list, tap *Clear*.

NASCAR Sprint Cup Mobile

*NASCAR Sprint Cup Mobile*sm keeps all NASCAR related information in one convenient location on your device and enables you to personalize the content with your favorite driver. When you are away from the track, you can follow races via streaming MRN/PRN race broadcast coverage and in-car audio. NASCAR Sprint Cup Mobile delivers real-time, race-day statistics and telemetry from all 43 NASCAR Sprint Cup Series™ drivers and offers video on demand from NASCAR.com, SPEED and more.

NASCAR Sprint Cup Mobile provides the following features:

- Personalize the program view to track your favorite driver
- Live MRN/PRN race broadcasts
- Live driver/team audio communications
- Real-time race-day statistics and telemetry for all 43 NASCAR Sprint Cup Series drivers
- 24-hour access to breaking NASCAR Sprint Cup Series news including insight and analysis from industry experts
- Delivers race and qualifying results including NASCAR Sprint Cup Series points standings and season statistics
- Offers video on demand from NASCAR.com, SPEED programming and more

Note While using this program, incoming calls may go directly to voicemail.

The NASCAR Sprint Cup Mobile Home Screen

Whenever you open NASCAR Sprint Cup Mobile, the NASCAR Home screen will be displayed, showing your favorite NASCAR driver banner with statistics. Swipe your finger upward to scroll down the screen and browse through more content.

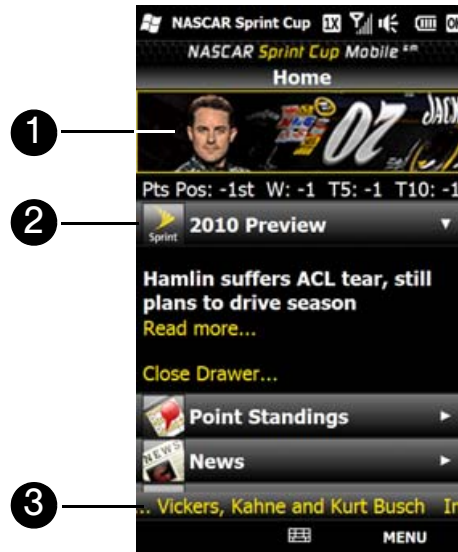

1. **Driver banner.** Shows your favorite NASCAR driver with key statistics. Tap the banner to view the driver profile.
2. **Drawer.** Information on the NASCAR Home screen is organized into several drawers. When a drawer is open, it shows a down arrow at the right side of the drawer. Tap to close the drawers. To view information in another drawer, tap the drawer to open it.
3. **Ticker.** Shows breaking news ticker.

Note The NASCAR Home screen looks different on race days and non-race days below the driver banner.

The Menu Bar











Tap **MENU** at the bottom-right side of the screen to display the Menu Bar and access more features of the NASCAR Sprint Cup Mobile.



Navigating the Menu Bar

1. Drag your finger left or right across the Menu Bar to scroll through the available feature.
2. Tap an icon to select it and display the corresponding information.

Menu Bar Icons

Icon	Description
	Home Returns you to the NASCAR Home screen.
	My Driver Displays your favorite driver's profile, season and race statistics, news and downloads.
	News Displays current driver and racing news as well editorial and recent race photos.
	Stats & Schedules Includes race results, point standings, and season statistics. The NASCAR season schedule is included here as well.
	NASCAR on SPEED View live SPEED programming or recorded video.
	Audio/Video Gives you access to the most recent NASCAR video and audio clips.
	Sprint FanZone Learn about the latest Sprint promotions, and see the recent winners in the Sprint All-Star Sweepstakes.
	Fantasy View NASCAR Fantasy league-related articles and videos.
	Alerts & Personalization Allows you to: <ul style="list-style-type: none"> ● Change your primary favorite driver ● Add or delete any of the four secondary favorite drivers ● Subscribe and unsubscribe to free Sprint Cup SMS text alerts ● Set your default in-car audio
	Help Displays the NASCAR Sprint Cup Mobile Help.
	Exit When you want to close the program, select <i>Exit</i> , and then tap <i>YES</i> .

NFL Mobile Live

NFL Mobile Live keeps you up to date on all NFL (National Football League) games and information while you are on the go. Using NFL Mobile Live, you can watch and listen to live video, hear the latest scores, get alerts, and customize the program to track your favorite team.

Note While using this program, incoming calls may go directly to voicemail.

The NFL Central Screen

Whenever you open NFL Mobile Live, the NFL Central screen will be displayed, providing listings of league-wide news, top videos and articles, access to NFL blogs, and more. Swipe your finger upward to scroll down the screen and browse through more content.

Information on the NFL Central screen is organized into several drawers. Tap a drawer (for example “News & Opinions”) to open it. Tap the drawer again to close it.

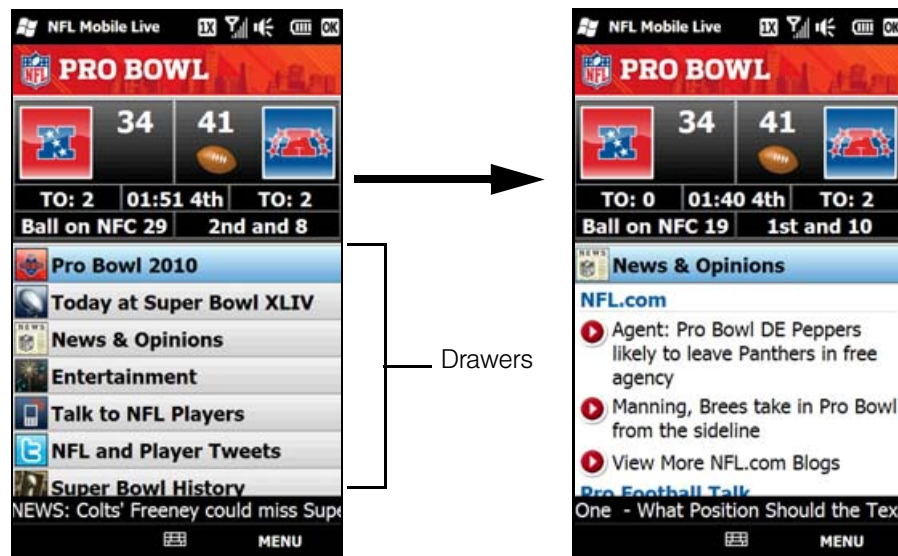

The Menu Bar



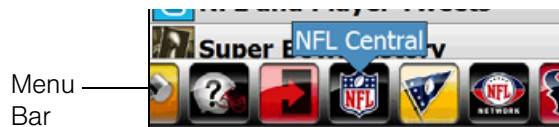









Tap **MENU** at the bottom-right side of the screen to display the Menu Bar and access more features of the NFL Mobile Live.



Navigating the Menu Bar

1. Drag your finger left or right across the Menu Bar to scroll through the available feature.
2. Tap an icon to select it and display the corresponding information.

Menu Bar Icons

Icon	Description
 NFL Central	Returns you to the NFL Central screen.
 FanZone	Learn about the latest Sprint promotions.
 NFL Network	Allows you to view content from the live TV broadcast of the NFL Network and view various On Demand clips, including Total Access. You can also view the NFL Network channel broadcast schedule to see when your favorite show will be on.
 My Team	Lets you stay on top of the latest news and videos for your favorite team. You can also view your team statistics, photos, schedules and results, standings, and more.
 Fantasy	Allows you to manage your fantasy team, and also offers articles, videos and analysis to keep you informed on the hottest players
 Teams & Standings	Lets you check the standings for both the AFC and NFC.
 Scores & Schedules	Allows you to view the season schedule week by week. Press the left or right arrow to move from week to week, and press the Enter key while highlighting a game to go to the Game Center focused on that match up
 News & Photos	Presents a large number of League news articles, feature articles, as well as transaction news. It also contains a photo gallery with images from recent games. Select a Photo Gallery title to see the images contained within.
 Audio & Video	Collects videos that are spread throughout the application all into one location. Here, you can view content such as Fantasy videos, Game highlights, and even Can't Miss Plays.
 Statistics	Lets you view various stats like Weekly Leaders and League Leaders. You can also use the Team stats and Player stats sections to search for any team or player to quickly bring up their statistics.
 Alerts & Personalization	Allows you to change your Favorite team, and view all the alerts you've received today. In the sections below, you can also set and manage your Game Alerts, Team alerts, Fantasy alerts and Player alerts.
 Help	Displays the NFL Mobile Live Help.
 Exit	When you want to close the program, select Exit , and then tap YES .

GPS Navigation

- ◆ *Guidelines and Preparation for Using GPS (page 188)*
- ◆ *Downloading Location Data via QuickGPS (page 189)*
- ◆ *Using Sprint Navigation (page 189)*
- ◆ *Bing (page 192)*

Use your device's built-in GPS capabilities and the Sprint Navigation software to easily access both directional information and location-specific features such as nearby businesses, services or other points of interest. Sprint Navigation also provides turn-by-turn driving directions onscreen and by voice right on your device.

Guidelines and Preparation for Using GPS

Please follow these guidelines before and when using your device as a GPS device.

- Do not attempt to set or adjust the GPS system while driving.
- When using the device inside a vehicle, use the car holder to mount the device securely in place. Avoid placing the device in the areas shown in the following diagram:

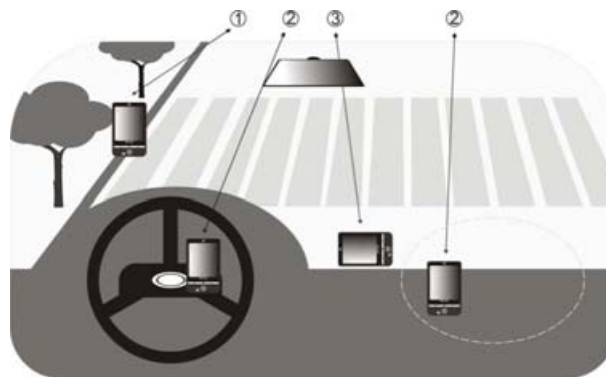

1. Do not place where it will block the driver's vision.
 2. Do not place where air bags could deploy.
 3. Do not place anywhere in the vehicle without securing the device in the holder.
- The GPS signal cannot pass through solid non-transparent objects. Signal reception may be affected by obstructions such as high-rise buildings, tunnels, bridges, forests, and weather conditions. Even metal in the overhead visors could block GPS reception.
 - Wireless communication products (such as mobile phones or radar-detecting devices) may interfere with the satellite signal, resulting in unstable signal reception.
 - The Global Positioning System (GPS) is maintained by the United States Department of Defense. Any changes that the DOD makes may affect the accuracy and function of the GPS system.
 - Do not leave your device in a vehicle or expose the device to direct sunlight to avoid overheating the battery, which could cause damage to the device or the vehicle.

Downloading Location Data via QuickGPS

Before using your device for GPS navigation, open QuickGPS to download ephemeris data (current satellite position and timing information). QuickGPS significantly speeds up the time for determining your GPS position. QuickGPS downloads ephemeris data from Web servers, instead of from satellites, using your device's Internet connection via Wi-Fi, ActiveSync or GPRS/3G.

To open QuickGPS:

- ▶ Tap **Start > Tools > QuickGPS**.

To download data:

- ▶ Tap **Download** on the QuickGPS screen.

You will initially see onscreen the **Valid time** of the downloaded data. As time passes, the remaining days and hours of validity will be shown.

To speed up GPS positioning, download the latest ephemeris data when the validity of the data expires.

Download Options

- **Download satellites automatically.** Automatically download ephemeris data. This may incur additional data charges.
- **Download satellites when roaming.** Automatically download ephemeris data when you are out of range of your home network. This may incur additional data charges.
- **Download satellites when connected to a PC via ActiveSync.** Automatically download ephemeris data when it is connected to your computer via ActiveSync. Your computer must be connected to the Internet to download ephemeris data.

Note The data is stored on Web servers. QuickGPS is preconfigured to connect to these servers.

Using Sprint Navigation

Sprint Navigation™ utilizes GPS positioning technology and access to Sprint's wireless data network to provide you with driving directions and a host of other services including:

- GPS navigation that gives you turn-by-turn directions to any destination address in the continental United States. If you miss a turn or get off track, Sprint Navigation will calculate a new route for you. You can enter a destination address by using Sprint Navigation's automatic voice recognition system or by typing on the your device's onscreen keypad.
- Audio and visual traffic alerts while driving or viewing maps, as well as traffic rerouting capabilities to minimize delays.
- Maps of the area around your current location, a marked Favorite, or an address you enter manually or have previously entered. You can pan the map (adjust left/right/up/down) and zoom in or out.

Using Sprint Navigation for the First Time

1. To launch Sprint Navigation on your device, slide to the *Navigation* tab on the Home screen and then tap any of the four icons on the screen.



2. You will see a splash screen for a few seconds and then the terms of service. Read through the terms, and then tap **Accept** after you have viewed the information.
3. Type in your phone number, first name, last name, and email address, and then tap **Go**. Sprint Navigation will then allow you to log into the service.
4. You will then see a safety warning. If you agree to the conditions listed, tap **Go**.
5. Tap **Back** at the bottom-left side of the screen to display the Sprint Navigation main screen.

Using Sprint Navigation

The Main Screen

After logging into Sprint Navigation, you will be taken to the application's main screen.



- **Drive To** lets you get driving directions by address, recently entered locations, airport code or business name.
- **Search** provides you with different ways to provide the addresses and phone numbers of banks, restaurants, gas stations, emergency services, and other hard to find locations.
- **Maps & Traffic** allows you to view map and traffic information for your current location, favorite places, a business, specific addresses, and more.
- **Share & More** gives you more options. You can share an address, record a location, set preferences, and more.

Entering an Address

With Sprint Navigation, there are two ways to enter an address – by typing it or by speaking it. To access the address entry menu, tap **Drive To** and then tap **Address**. You will then see the following options:

- **Type It** allows you to enter a street address by typing it in the appropriate fields.

1. On the Address screen, tap **Type It**.
2. Enter the street name. You may type in a partial entry (five or more letters) for the street name.

Note You can always leave the street address field blank and type in a city to perform a city search. The **City** and **State** fields have an auto-fill feature, so you usually will not have to type in the whole name of the city or state.

3. Tap **Done** to submit the address.

Note To quickly clear the fields, choose **Options > Clear All** on the address screen.

4. Sprint Navigation checks to see if the address you entered can be found. Sprint Navigation prompts you to modify the address if it is too new to be found in the mapping database or if the street number cannot be found for some other reason.

After submitting the address, you will be taken to the trip confirmation screen and you are ready to begin your trip.

- **Speak It** allows you to enter a street address by calling in and dictating the address.

1. On the Address screen, tap **Speak It**.
2. Follow the voice prompts to enter your destination address.
3. After a successful entry, hang up and you will be taken back to the screen you were viewing prior to making the call. The location you just entered will now be displayed at the top of your Recent Places list. You may need to tap **Refresh Recent Places** to make the address available.

You should now have a basic understanding of how to enter an address and get driving directions. For more information about using Sprint Navigation, visit the support page at <http://www.sprint.com/navigation>.

Note The Sprint Navigation software gets routing directions, maps, and its directory of businesses and points of interests from the Sprint Navigation servers. You need to subscribe to a data plan in order to access this information. If you do not have a data plan yet, check Sprint Navigation's website at <http://www.sprint.com/navigation> for subscription rates.

Bing

Microsoft® Bing™ is a separate program that offers you a fast and easy way to find and view maps and local information on your device.



With Bing, you can:

- Get up-to-date local information such as movies and gas prices.
- Find your location with or without using GPS.
- Search places by voice.
- Browse listings by category.
- Locate nearby restaurants, shopping centers, etc., and check for their street addresses and phone numbers.
- View maps and get directions for reaching a destination.
- View traffic information (US only at present).

To open Bing:

1. Tap **Start > Live Search**.
2. The first time you launch Bing, you will be asked to read the Service Agreement. If you agree with the terms of service, tap **Accept**, and then tap **OK** on the subsequent screen.

Note You may be prompted to install an update for Bing. Tap **Yes** to install the update

Sprint Worldwide Wireless Service

- ◆ *Your SIM Card (page 193)*
- ◆ *Using Your Device in GSM Mode (page 195)*
- ◆ *Using Your SIM Card's PhoneBook (page 199)*
- ◆ *Setting GSM Services Options (page 202)*
- ◆ *Contacting Sprint (page 203)*
- ◆ *Services (page 204)*
- ◆ *Selecting a Network (page 205)*

Your device allows you to roam throughout the world using both CDMA (Code Division Multiple Access) and GSM (Global System for Mobile Communications) networks. For a complete list of countries and features available, visit www.sprint.com/sww.

Note To use Sprint international roaming services, you must be a current Sprint subscriber. You must also meet international toll authorization and credit requirements to roam in most places outside of the United States. Depending on your overseas location and coverage, you may not have access to all features. Service may be interrupted if you change phones or phone numbers before traveling abroad.

Your SIM Card

Your device comes with a preinstalled SIM (Subscriber Identity Module) card to support roaming on compatible GSM networks. The SIM card must be activated for international wireless service prior to its initial use (outside of the United States).

To activate Sprint Worldwide service:

- ▶ Visit www.sprint.com/international.
 - Click **Chat with us** to talk online with a Sprint representative
 - or –
 - Click **Email us** to send an email to a Sprint representative
 - or –
- ▶ Call **1-888-226-7212, option 2**, to speak to a Sprint representative.

For more help with Sprint Worldwide international setup, tap **Start > International Usage** to display a brief set of onscreen GSM setup instructions.

Note Your SIM card should be preinstalled. If you need to reinstall your SIM card, see "Removing Your SIM Card" on page 194. The SIM card included with your device contains information specific to your device and should be retained with the device for use on GSM networks.

Removing Your SIM Card

The SIM card comes preinstalled but can be removed if necessary.

1. Remove the back cover.
 - Remove the stylus. (You need to temporarily remove the stylus to be able to remove the back cover.)
 - Hold the device with both hands and the front panel facing down.
 - Push the back cover up with your thumb until it disengages from the device and then slide it up to remove.

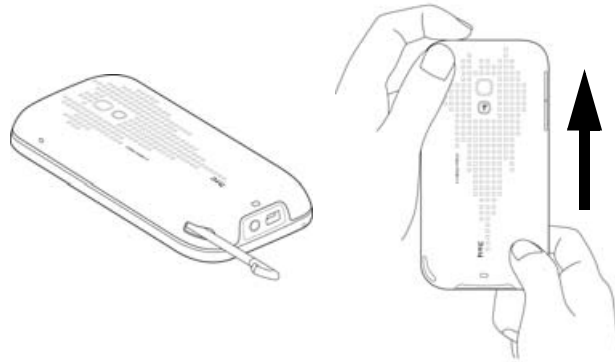

2. Remove the battery if it is installed. To remove, lift out the battery from the groove at the upper right side of the battery compartment.

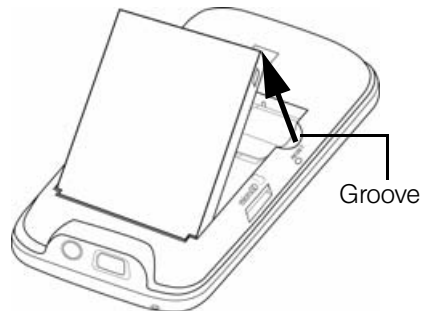

3. To remove the SIM card, first insert the tip of the stylus into the small hole above the SIM card slot, and then push the SIM card out with the stylus. Slide the SIM card out from the slot with your thumb or finger.

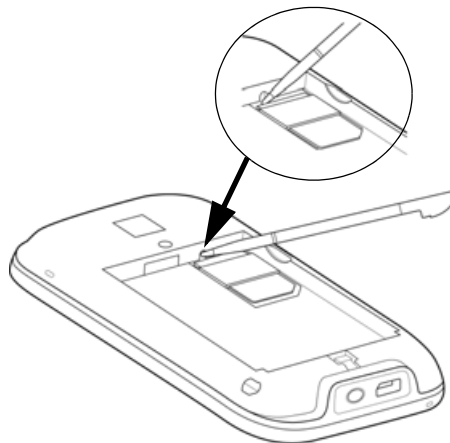

4. Press the **Power** button to turn the device on.
 - Your device will turn on, search for Sprint service, and then enter standby mode.
 - If your device is not yet activated, see “Activating Your Device” on page 3 for more information.
 - By default, your device is set to Global mode. If there is no SIM card on your device, your device will display a message to inform you that it will switch to CDMA mode.

Note Your device's battery should have enough charge to turn on, find a signal, set up your voicemail, and make a call. You should fully charge your battery as soon as possible. See “Charging the Battery” on page 13 for details.

Using Your Device in GSM Mode

Note Sprint offers service on CDMA and GSM networks around the world; contact Sprint Worldwide Customer Service before your trip to confirm that your service allows for international dialing. In countries where CDMA service is not available you will need access to a GSM network.

Entering GSM Mode

By default, your device operates in Global mode. With a SIM card installed, Global mode allows your device to seamlessly switch from a CDMA network to a GSM network when you are traveling in another country and there is no CDMA service available in your location.

If necessary, you can also manually change the network mode setting of your device to GSM-only mode.

To change the network mode to GSM:

1. Slide to the Settings tab, and then tap **Wireless controls > Phone > Network** tab.
2. From the **Mode of operation** list, select **GSM/UMTS only**.
3. Tap **OK**.

Note While in the United States, your device will operate only in CDMA mode; domestic GSM networks will not be accessible via this device.

Making and Answering Calls in GSM Mode

When traveling on international GSM networks while in GSM mode, you can place and answer calls the same as in CDMA mode. See “Using Phone Features” on page 63. Certain features and services are not available in all countries.

Visit www.sprint.com/swv for more information on services that are available while roaming.

Calling Emergency Numbers in GSM Mode

When traveling on international GSM networks while in GSM mode, you can place calls to emergency services (even if your account is restricted or Call Barring is active.)

To place calls to emergency services:

1. Press the **Talk** key to open the Phone screen.
2. Tap  .

Plus (+) Code Dialing and Global Smart Dialing

Placing calls from one country to another country is simple with the Plus Code Dialing. When you place international calls, Plus Code Dialing automatically fills in the international access code for your location (for example, 011 for international calls placed from the United States).

When the Global Smart Dialing feature is enabled, you can preconfigure the country to call. Plus Code Dialing also becomes automatic when you use Global Smart Dialing. You simply enter the 10-digit number when placing your international call. Both the “+” symbol and country code will automatically be prepended to the number.

Configuring Global Smart Dialing in GSM Mode

1. Press the **Talk** key to open the Phone screen.
2. Tap **Menu**, scroll down the menu, and then tap **Global Smart Dialing**.
3. Select the **Enable Global Smart Dialing** check box.
4. Select the countries from the Dial from and Dial to list. The corresponding codes will appear.
5. Tap **Done**.

Using Plus Code Dialing with Global Smart Dialing in GSM Mode

1. On the Phone screen, directly enter the 10-digit number to call. This number includes the area code (without the leading zero, if any) and phone number.
2. Tap  on the Phone screen or press the **Talk** key to place the call.
(The Phone screen will then display the complete number, including the “+” symbol followed by the country code and the 10-digit number. The “+” symbol automatically inserts the access code for international dialing.)

Note When Global Smart Dialing is not enabled, you need to manually enter the “+” symbol and the country code of the person you are calling. Touch and hold  to enter the “+” symbol, and then enter the country code, followed by the city or area code and the phone number.

Direct Dial in GSM Mode

Note When the number you want to call (area code and phone number) contains fewer than 10 digits, you need to use direct dialing to place international calls.

To use direct dialing to place an international call:

- ▶ Enter the international access code, the country code, the city or area code, and the phone number, and then tap  to complete the call.



Making Calls Within a Country (Local or Long Distance Dialing)

The steps for making an international call within the same country are identical to those for calling country-to-country, except it is not necessary to enter the country code.

Calling the United States from Another Country in GSM Mode

To place a call to the United States from another country:

1. Follow the same steps in “Configuring Global Smart Dialing in GSM Mode” on page 196 to enable Global Smart Dialing, making sure to select the United States in the *Dial to* list.
2. On the Phone screen, enter the area code without the leading zero, followed by the number of the person you are calling. (The area code and phone number should total 10 digits.)
3. Tap  on the Phone screen or press the **Talk** key to place the call.
(The “+” symbol and U.S. country code are automatically prepended to the dialed number. Also, the “+” symbol automatically inserts the exit code for the country from which you are calling.)

Note When Global Smart Dialing is not enabled, you need to manually enter the “+” symbol and the U.S. country code to place the call. Touch and hold  to enter the “+” symbol, tap  to insert the U.S. country code, and then enter the city or area code followed by the phone number.

Calling Other Countries in GSM Mode

To place a call from one country to another country:





1. Follow the same steps in “Configuring Global Smart Dialing in GSM Mode” on page 196.
2. On the Phone screen, enter the complete local number according to the dialing sequence used by the country to which you are calling. For instance, the standard dialing sequence used in many countries comprises the area code without the leading zero, followed by the phone number. (The complete local number should total 10 digits.)
3. Tap  on the Phone screen or press the **Talk** key to place the call.
(The “+” symbol and country code are automatically prepended to the dialed number. Also, the “+” symbol automatically inserts the exit code for the country from which you are calling.)

Note When Global Smart Dialing is not enabled, you need to manually enter the “+” symbol and the country code of the person you are calling. Touch and hold  to enter the “+” symbol, and then enter the country code, followed by the city or area code and the phone number.

Retrieving Voicemail Messages

Your device uses the same Voicemail box for both Sprint CDMA and GSM modes.

To retrieve voicemail messages:

1. Enter the international access code (or if in GSM mode, touch and hold  until a “+” symbol appears on the Phone screen).
2. Enter  followed by your 10-digit phone number.
3. When you hear the voice greeting, tap  and enter your password, followed by .

International Data Roaming

Sprint Worldwide Wireless Service can also keep you connected via email and Web browsing when traveling in countries in which Sprint offers data service. Data services are available on both CDMA and GSM networks; check www.sprint.com/international to determine the services available where you are traveling.

Note Prior to using your Sprint Worldwide GSM Data Services, you must establish and utilize your CDMA data services domestically on the Nationwide Sprint Network.

Getting Started with Data Services

Before you can use Sprint Worldwide Data Services, you must first have these services activated on your account.

► To activate, visit www.sprint.com/international.

- Click *Chat with us* to talk online with an International Services representative.

– or –

- Click *Email us* to send an email to an International Services representative.

– or –

Call **1-888-226-7212, option 2**, to speak with an International Services representative.

Once your services are activated, you may need to select a GSM data services provider for the country you're in. (See "Selecting a Network" on page 205.)

Accessing Your Email and Data Services on CDMA Networks

Since your device is set to Global mode by default, it automatically detects CDMA networks. If a data service is available on a CDMA network, you do not need to manually set your device to CDMA mode. You also do not need to select the specific carrier. Selecting a specific carrier is necessary only for providers on the GSM network.

If you changed the network mode setting of your device to GSM-only mode while you are traveling, you need to set it back to Global mode or CDMA-only mode to access CDMA data services.

To change the network mode from GSM to Global or CDMA-only mode:

1. Slide to the Settings tab, and then tap *Wireless controls > Phone > Network* tab.
2. From the *Mode of operation* drop-down list, select *Global* or *CDMA only*.
3. Tap *OK*.

Visit www.sprint.com/international for a list of services available for each country.

Using Your SIM Card's PhoneBook

Your SIM card contains its own phone book that is separate from your device's internal Contacts list. You can update and maintain the SIM PhoneBook whenever your SIM card is installed on your device, even if you are not in a GSM service area.

When saving a Contacts entry to your SIM card, note that only the name and number are saved. Entries stored on the card do not contain any detailed information that may be stored in the device's internal memory. To store additional information for a particular contact, such as email addresses or dates, it is important to save that information to your device's onboard memory.

When a SIM card is active, the People screen that can be accessed from the People tab will then display two types of entries:



Each Contacts entry stored on the SIM card can use only one phone number, and the entry's name can be a maximum of 12 characters.

Adding Entries to the SIM PhoneBook

There are two ways to add new entries to your SIM card's phonebook. You can add contact entries using the *Windows Mobile Contacts* program or the *SIM Manager*.

Adding Entries Using Windows Mobile Contacts

1. Tap *Start > Outlook > Contacts*.
2. On the Contacts screen, tap *New*, and then tap *SIM Contact*.
3. Enter a name and phone number for the new entry. (See "Entering Text" on page 24.)
4. Tap *OK*.

Adding Entries Using SIM Manager

1. Tap *Start > Calls > SIM Manager* and then tap *New*.
2. Enter a name and phone number for the new entry. (See "Entering Text" on page 24.)
3. Tap *Save*.

Copying Contacts Entries to the SIM PhoneBook

You can also copy entries from your device's Contacts to your SIM PhoneBook using either *Windows Mobile Contacts* or the *SIM Manager*.

Copying Entries Using Windows Mobile Contacts

1. Tap **Start > Outlook > Contacts**.
2. Tap **Menu**, scroll down the menu, and then tap **Select Contacts**. Do one of the following:
 - Tap **All** to select all contacts.
 - or –
 - Tap **Several**, and then in the contacts list, tap each contact that you want to select to copy to the SIM Phonebook. Tap a contact again to deselect.
3. Tap **Menu > Copy Contact** and then select a copy option:
 - **To SIM** to copy the selected contacts from your device to your SIM card. Note that only the name and number will be saved to the card.
 - **To Contacts** to copy the selected contacts from your SIM Card to your device's onboard memory.

Copying Entries Using SIM Manager

To copy contacts to the SIM card:

When you copy a contact that has several phone numbers to your SIM card, SIM Manager automatically saves each number as a separate entry on the SIM card. Each entry shows the same contact name but with an indicator appended at the end of the name. By default, /M, /W, and /H are appended to indicate mobile, work, and home phone numbers respectively.

Tip To edit the default indicators and to select which other types of numbers to save to the SIM card, tap **Menu > Tools > Options** and change the indicators.

1. Tap **Start > Calls > SIM Manager**.
2. Tap **Menu > Contacts to SIM**.
3. The check boxes of all available phone numbers stored on your device are selected. Clear the check boxes of those phone numbers that you do not want to copy to your SIM card.

Tip Tap **Menu > Uncheck All** to clear all checkboxes.

4. Tap **Done**.

To copy SIM contacts to your device:

If you have saved contacts on your SIM card, you can copy them to the contacts list on your device.

1. Tap **Start > Calls > SIM Manager**.
2. On the SIM Manager screen, you can:
 - Select all SIM contacts by tapping **Menu > Select All**.
 - or –
 - Open the sliding QWERTY keyboard or an onscreen keyboard, and use the Up or Down key of the keyboard to highlight and select a SIM contact.
3. Tap **Menu > Save to Contacts**.

Deleting SIM PhoneBook Entries

Use the *SIM Manager* to delete some or all SIM PhoneBook entries.

To delete some entries from the SIM Phonebook:

1. Tap *Start > Calls > SIM Manager*.
2. Tap *Menu > Delete Contacts*.
3. Select the check boxes of the entries that you want to delete from the SIM Phonebook.
4. Tap *Delete*.

To delete all SIM Phonebook entries:

1. Tap *Start > Calls > SIM Manager*.
2. Tap *Menu > Check All*.
3. Tap *Delete*.

Copying Text Messages to the SIM Card

When your SIM card is installed on your device, you can save text messages to your SIM card.

1. From the Home screen, slide to the Messages tab and then tap *All Messages*.
2. In the SMS/MMS inbox, tap a message thread.
3. The exchange of text messages between you and the sender is then displayed. Open the sliding QWERTY keyboard or an onscreen keyboard, and use the Up or Down key of the keyboard to highlight the text message that you want to copy to the SIM card.
4. Tap *Menu > Copy to SIM*.

Notes

- You cannot copy a sent text message from the thread to the SIM card.
- Copying text messages from your device to the SIM card results in duplicate messages when you are viewing the Inbox.

Setting GSM Services Options

There are several user options available for GSM operation under your device's Phone settings. All these options require that your device be in Global or GSM-only mode and in a GSM roaming coverage area. (See www.sprint.com/sww for a list of countries where international GSM coverage is available, and see "Entering GSM Mode" on page 195.)

To configure GSM services options:

1. Slide to the Settings tab, and then tap **Wireless controls > Phone > GSM/UMTS Services** tab.
2. Tap the service you want to configure and then tap **Get Settings**.
3. Choose your desired options, and then tap **OK**.

The following are some of the GSM services that you can configure.

GSM Services	Usage
Call Barring	Allows you to block certain types of incoming and outgoing calls on your device. This would be useful, for example if you allowed someone to use your device for a short period of time. (See "Using Call Barring (GSM)" below for details.)
Caller ID	Allows you to set caller ID options. (See "Caller ID" on page 204 for details.)
Call Waiting	Allows you to enable or disable call waiting. (See "Call Waiting" on page 204 for details.)
Call Forwarding	Allows you to divert incoming calls to another specified phone number.
Voice Mail and Text Messages	Shows the text messages service center phone number and your voicemail number for accessing voicemail messages when you are roaming on GSM networks. (See "Voicemail and Text Messages" on page 204 for details.)
Location Setting	Allows the GSM network to detect your current location via your device's built-in GPS chip. This is especially useful in emergencies.
TTY Mode	Allows the use of a TTY (teletypewriter) with the phone for users who are visually or hearing impaired. The available modes are the same as in CDMA. See "Phone Services" on page 74 for details.
Time Synchronization	Allows you to choose whether to synchronize the time on your device with the GSM network.

Using Call Barring (GSM)

To activate Call Barring (GSM):

1. Slide to the Settings tab, and then tap **Wireless controls > Phone > GSM/UMTS Services** tab.
2. Tap **Call Barring** and then tap **Get Settings**.
3. Under **Block incoming calls** and **Block outgoing calls**, choose when you want to block phone calls.
4. Tap **OK**.

Contacting Sprint

Sprint Worldwide Customer Service is available to answer your questions 24 hours a day, 7 days a week. Visit www.sprint.com/international and click **Chat with us** to talk online with an International Services representative; or click **Email us** to send an email to an International Services representative; or you can call the numbers below if you need assistance.

While in the United States:

- ▶ Call 1-888-226-7212, *option 2*.

While traveling outside the United States:

- ▶ Call +1-817-698-4199, *option 2*.

There is no charge for this call from your Sprint wireless device.

From a landline phone when outside the United States:

Sprint Worldwide Customer Service can be reached from a landline phone at +1-817-698-4199, *option 2*. Access or connection fees may apply. The toll-free numbers below can also be used to contact Sprint Worldwide Customer Service in the following countries.

<i>Country</i>	<i>From Landline Phone</i>
Anguilla	1-888-226-7212
Barbados	1-888-226-7212
Cayman Islands	1-888-226-7212
Dominican Republic	1-888-226-7212
France	0800-903200
Germany	0800-180-0951
Italy	800-787-986
Mexico	001-877-294-9003
Trinidad and Tobago	1-800-201-7545
United Kingdom	0808-234-6616

Note This toll-free service is available through ordinary landline phones and some public payphones. Additional fees may be incurred if you call this service from hotels.

Services

Caller ID

Caller ID displays the number (and name, if in your PhoneBook) of incoming calls. Caller ID in GSM mode must be enabled by the user.

To enable or disable caller ID:

1. Slide to the Settings tab, and then tap *Wireless controls > Phone > GSM/UMTS Services* tab.
2. Tap *Caller ID* and then tap *Get Settings*.
3. Select *Everyone*, *No one*, or *Only to contacts* and tap *OK*.

Call Waiting

Call Waiting notifies you of an incoming call even while you're in a call. You can then accept, reject, or ignore the incoming call. Unlike Call Waiting in CDMA mode, Call Waiting in GSM mode must first be activated.

To use Call Waiting Internationally:

1. Slide to the Settings tab, and then tap *Wireless controls > Phone > GSM/UMTS Services* tab.
2. Tap *Call Waiting* and then tap *Get Settings*.
3. Select the *Notify me* option and tap *OK*.

Voicemail and Text Messages

To activate voicemail settings:

1. Slide to the Settings tab, and then tap *Wireless controls > Phone > GSM/UMTS Services* tab.
2. Tap *Voice Mail and Text Messages* and then tap *Get Settings*.
3. The text messages service center number and your voicemail number are then displayed. To change the voicemail number, open the sliding QWERTY keyboard or an onscreen keyboard, and then use the keyboard to enter a new number.
4. Tap *OK*.

Note *The voicemail number is automatically set up when you receive your device. You will probably not need to change it unless otherwise instructed by your carrier.*

Selecting a Network

To access your email and browse the Web when traveling, you may need to manually select the carrier that provides Sprint service in your location. You can find a list of carriers for each country where GSM data service is offered at www.sprint.com/sww. Then, follow the instructions below to select the appropriate carrier network on your device.

To select a GSM data service for a specific country:

1. Slide to the Settings tab, and then tap **Wireless controls > Phone**.
 - On the **Network** tab of the Phone settings screen, the Current Network field displays a description of the currently active network.
2. In **Mode of operation**, make sure that **GSM/UMTS only** is selected.
3. From the **GSM Network selection** field, select **Automatic** or **Manual** and then tap **Find Network**.
 - If you selected **Automatic**, the system will provide the best available network in your area and then assign it to your device.
 - If you selected **Manual**, you will need to choose from the onscreen list of available networks and then manually make the assignment.
 - Tap to highlight an available network and then tap **OK**. The settings are then sent to the network.
4. Tap **OK** to complete the process and save the new settings.

Note When traveling, it may be necessary to select a new compatible GSM data service carrier each time you enter a new country.

Viewing Your Preferred Networks

1. Slide to the Settings tab, and then tap **Wireless controls > Phone**.
 - On the **Network** tab of the Phone settings screen, the Current Network field displays a description of the currently active network.
2. In **Mode of operation**, make sure that **GSM/UMTS only** is selected.
3. From the **GSM Network selection** field, select **Manual**.
4. Tap **Set Networks**.

Preferred networks are displayed with a selected check box next to them.

To add a new preferred network:

1. Repeat the steps in “Viewing Your Preferred Networks” to access the Phone: Preferred networks screen.
2. Tap **New Network**.
3. Select **Add a network from the list**, browse through the available list, and then tap a network.
4. Tap **OK**. (This newly added network then appears on the Phone: Preferred networks screen.)

Section 4

***Safety, Regulatory, and
Warranty Information***



Important Safety Information

- ◆ *Important Health Information and Safety Precautions (page 208)*
- ◆ *General Precautions (page 211)*
- ◆ *Additional Safety Information (page 213)*

This User Guide contains important operational and safety information that will help you safely use your device. Failure to read and follow the information provided in this guide may result in serious bodily injury, death, or property damage.

Important Health Information and Safety Precautions

When using this product, the safety precautions below must be taken to avoid possible legal liabilities and damages.

Retain and follow all product safety and operating instructions. Observe all warnings in the operating instructions on the product.

To reduce the risk of bodily injury, electric shock, fire, and damage to the equipment, observe the following precautions.

Electrical Safety

This product is intended for use when supplied with power from the designated battery or power supply unit. Other usage may be dangerous and will invalidate any approval given to this product.

Safety Precautions for Proper Grounding Installation

CAUTION: Connecting to an improperly grounded equipment can result in an electric shock to your device.

This product equipped with a USB Cable for connecting with desktop or notebook computer. Be sure your computer is properly grounded (earthed) before connecting this product to the computer. The power supply cord of a desktop or notebook computer has an equipment-grounding conductor and a grounding plug. The plug must be plugged into an appropriate outlet which is properly installed and grounded in accordance with all local codes and ordinances.

Safety Precautions for Power Supply Unit

- **Use the correct external power source.** A product should be operated only from the type of power source indicated on the electrical ratings label. If you are not sure of the type of power source required, consult your authorized service provider or local power company. For a product that operates from battery power or other sources, refer to the operating instructions that are included with the product.
- **Handle battery packs carefully.** This product contains a Li-ion battery. There is a risk of fire and burns if the battery pack is handled improperly. Do not attempt to open or service the battery pack. Do not disassemble, crush, puncture, short external contacts or circuits, dispose of in fire or water, or expose a battery pack to temperatures higher than 140°F (60°C).

WARNING

Danger of explosion if battery is incorrectly replaced. To reduce risk of fire or burns, do not disassemble, crush, puncture, short external contacts, expose to temperature above 60°C (140°F), or dispose of in fire or water. Replace only with specified batteries. Recycle or dispose of used batteries according to the local regulations or reference guide supplied with your product.

**● Take extra precautions:**

- Keep the battery or device dry and away from water or any liquid as it may cause a short circuit.
- Keep metal objects away so they don't come in contact with the battery or its connectors as it may lead to short circuit during operation.
- The device should be only connected to products that bear the USB-IF logo or have completed the USB-IF compliance program.
- Do not use a battery that appears damaged, deformed, or discolored, or the one that has any rust on its casing, overheats, or emits a foul odor.
- Always keep the battery out of the reach of babies and small children, to avoid swallowing of the battery. Consult the doctor immediately if the battery is swallowed.
- Only use the battery with a charging system that has been qualified with the system per this standard, IEEE-Std-1725-2006. Use of an unqualified battery or charger may present a risk of fire, explosion, leakage or other hazard.
- Replace the battery only with another battery that has been qualified with the system per this standard, IEEE-Std-1725-2006. Use of an unqualified battery may present a risk of fire, explosion, leakage or other hazard.
- Avoid dropping the device or battery. If the device or battery is dropped, especially on a hard surface, and the user suspects damage, take it to a service centre for inspection.
- If the battery leaks:
 - Do not allow the leaking fluid to come in contact with skin or clothing. If already in contact, flush the affected area immediately with clean water and seek medical advice.
 - Do not allow the leaking fluid to come in contact with eyes. If already in contact, DO NOT rub; rinse with clean water immediately and seek medical advice.
 - Take extra precautions to keep a leaking battery away from fire as there is a danger of ignition or explosion.

Safety Precautions for Direct Sunlight

Keep this product away from excessive moisture and extreme temperatures. Do not leave the product or its battery inside a vehicle or in places where the temperature may exceed 60°C (140°F), such as on a car dashboard, window sill, or behind a glass that is exposed to direct sunlight or strong ultraviolet light for extended periods of time. This may damage the product, overheat the battery, or pose a risk to the vehicle.

Prevention of Hearing Loss

CAUTION: Permanent hearing loss may occur if earphones or headphones are used at high volume for prolonged periods of time.

Safety in Aircraft

Due to the possible interference caused by this product to an aircraft's navigation system and its communications network, using this device's phone function on board an airplane is against the law in most countries. If you want to use this device when on board an aircraft, remember to turn off your phone by switching to Airplane Mode.

Environment Restrictions

Do not use this product in gas stations, fuel depots, chemical plants or where blasting operations are in progress, or in potentially explosive atmospheres such as fuelling areas, fuel storehouses, below deck on boats, chemical plants, fuel or chemical transfer or storage facilities, and areas where the air contains chemicals or particles, such as grain, dust, or metal powders. Please be aware that sparks in such areas could cause an explosion or fire resulting in bodily injury or even death.

Explosive Atmospheres

When in any area with a potentially explosive atmosphere or where flammable materials exist, the product should be turned off and the user should obey all signs and instructions. Sparks in such areas could cause an explosion or fire resulting in bodily injury or even death. Users are advised not to use the equipment at refueling points such as service or gas stations, and are reminded of the need to observe restrictions on the use of radio equipment in fuel depots, chemical plants, or where blasting operations are in progress. Areas with a potentially explosive atmosphere are often, but not always, clearly marked. These include fueling areas, below deck on boats, fuel or chemical transfer or storage facilities, and areas where the air contains chemicals or particles, such as grain, dust, or metal powders.

Road Safety

Vehicle drivers in motion are not permitted to use telephony services with handheld devices, except in the case of emergency. In some countries, using hands-free devices as an alternative is allowed.

Safety Precautions for RF Exposure

- Avoid using your device near metal structures (for example, the steel frame of a building).
- Avoid using your device near strong electromagnetic sources, such as microwave ovens, sound speakers, TV and radio.
- Use only original manufacturer-approved accessories, or accessories that do not contain any metal.
- Use of non-original manufacturer-approved accessories may violate your local RF exposure guidelines and should be avoided.

Interference with Medical Equipment Functions

This product may cause medical equipment to malfunction. The use of this device is forbidden in most hospitals and medical clinics.

If you use any other personal medical device, consult the manufacturer of your device to determine if they are adequately shielded from external RF energy. Your physician may be able to assist you in obtaining this information.

Turn your device OFF in health care facilities when any regulations posted in these areas instruct you to do so. Hospitals or health care facilities may be using equipment that could be sensitive to external RF energy.

Hearing Aids

Some digital wireless phones may interfere with some hearing aids. In the event of such interference, you may want to consult your service provider, or call the customer service line to discuss alternatives.

Nonionizing Radiation

Your device has an internal antenna. This product should be operated in its normal-use position to ensure the radiative performance and safety of the interference. As with other mobile radio transmitting equipment, users are advised that for satisfactory operation of the equipment and for the safety of personnel, it is recommended that no part of the human body be allowed to come too close to the antenna during operation of the equipment.

Use only the supplied integral antenna. Use of unauthorized or modified antennas may impair call quality and damage the device, causing loss of performance and SAR levels exceeding the recommended limits as well as result in non-compliance with local regulatory requirements in your country.

To assure optimal phone performance and ensure human exposure to RF energy is within the guidelines set forth in the relevant standards, always use your device only in its normal-use position. Contact with the antenna area may impair call quality and cause your device to operate at a higher power level than needed. Avoiding contact with the antenna area when the phone is IN USE optimizes the antenna performance and the battery life.

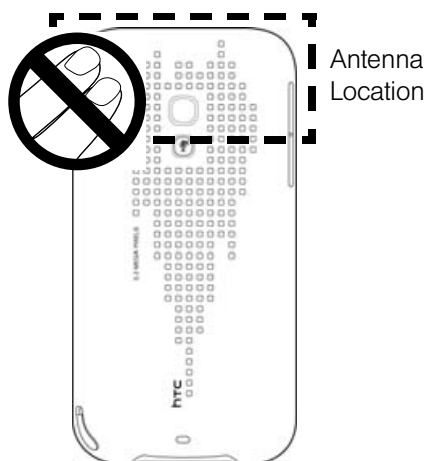

General Precautions

- **Avoid applying excessive pressure to the device.** Do not apply excessive pressure on the screen and the device to prevent damaging them and remove the device from your pants' pocket before sitting down. It is also recommended that you store the device in a protective case and only use the device stylus or your finger when interacting with the touch screen. Cracked display screens due to improper handling are not covered by the warranty.
- **Device getting warm after prolonged use.** When using your device for prolonged periods of time, such as when you're talking on the phone, charging the battery or browsing the Web, the device may become warm. In most cases, this condition is normal and therefore should not be interpreted as a problem with the device.
- **Heed service markings.** Except as explained elsewhere in the Operating or Service documentation, do not service any product yourself. Service needed on components inside the device should be done by an authorized service technician or provider.

- **Damage requiring service.** Unplug the product from the electrical outlet and refer servicing to an authorized service technician or provider under the following conditions:
 - Liquid has been spilled or an object has fallen onto the product.
 - The product has been exposed to rain or water.
 - The product has been dropped or damaged.
 - There are noticeable signs of overheating.
 - The product does not operate normally when you follow the operating instructions.
- **Avoid hot areas.** The product should be placed away from heat sources such as radiators, heat registers, stoves, or other products (including amplifiers) that produce heat.
- **Avoid wet areas.** Never use the product in a wet location.
- **Avoid using your device after a dramatic change in temperature.** When you move your device between environments with very different temperature and/or humidity ranges, condensation may form on or within the device. To avoid damaging the device, allow sufficient time for the moisture to evaporate before using the device.

NOTICE: When taking the device from low-temperature conditions into a warmer environment or from high-temperature conditions into a cooler environment, allow the device to acclimate to room temperature before turning on power.
- **Avoid pushing objects into product.** Never push objects of any kind into cabinet slots or other openings in the product. Slots and openings are provided for ventilation. These openings must not be blocked or covered.
- **Mounting accessories.** Do not use the product on an unstable table, cart, stand, tripod, or bracket. Any mounting of the product should follow the manufacturer's instructions, and should use a mounting accessory recommended by the manufacturer.
- **Avoid unstable mounting.** Do not place the product with an unstable base.
- **Use product with approved equipment.** This product should be used only with personal computers and options identified as suitable for use with your equipment.
- **Adjust the volume.** Turn down the volume before using headphones or other audio devices.
- **Cleaning.** Unplug the product from the wall outlet before cleaning. Do not use liquid cleaners or aerosol cleaners. Use a damp cloth for cleaning, but NEVER use water to clean the LCD screen.

Additional Safety Information

This section provides more safety information in addition to the information at the beginning of the user manual.

When Driving

Do Not Use The PC Functions Of Your Device While Driving Or Walking

Never use the personal computer functions of your device while driving an automobile or any other moving vehicle. Always pull out of traffic and come to a stop in a legally permissible and safe location before using your device. Failure to do so could result in serious bodily injury in a traffic accident.

When driving:

- Always secure your device in its leather pouch.
- Never place your device on the passenger seat or anyplace else in the car where it can become a projectile during a collision or stop.
- An air bag inflates with great force. DO NOT place objects, including either installed or portable wireless equipment, in the area over the air bag or in the air bag deployment area. If in-vehicle wireless equipment is improperly installed and the air bag inflates, serious injury could result.

Never store or transport flammable liquids, gases or explosive materials in the same compartment of your automobile as the device or any of its accessories, as possible sparking in the device could cause ignition or explosion.

Never use your device while walking. Usage while walking could result in bodily injury caused by inattention to automobile traffic or other pedestrian hazards.

Using The Phone Function Of Your Device While Driving Is Extremely Dangerous

Talking on or using your device while driving is extremely dangerous and is illegal in some states. Remember, safety comes first. Check the laws and regulations on the use of phones in the areas where you drive. Always obey them.

If you must use the phone function while driving, please:

- Give full attention to driving. Driving safely is your first responsibility.
- Use hands-free operation and/or one-touch, speed dialing, and auto answer modes.
- Pull off the road and park before making or answering a call.

Warning

Failure to follow these instructions could lead to serious personal injury and possible property damage.

When Using Your Device Near Other Electronic Devices

Your wireless handheld portable device is a low power radio transmitter and receiver. When it is ON, it receives and also sends out radio frequency (RF) signals.

Most modern electronic equipment is shielded from RF energy. However, certain electronic equipment may not be shielded against the RF signals from your wireless device; therefore, use of your device must be restricted in certain situations.

In addition, the computer portion of your device produces low levels of RF energy due to the generation of digital timing pulses by its clock oscillator circuits. Your device has been equipped with internal shielding to minimize stray emissions of RF energy. However, use of the computer functions of your device must be restricted in certain situations.

Pacemakers

The Health Industry Manufacturers Association recommends that a minimum separation of six (6") inches be maintained between a handheld wireless phone and a pacemaker to avoid potential interference with the pacemaker. These recommendations are consistent with the independent research by and recommendations of Wireless Technology Research.

Never come closer than six (6) inches to a person with a heart pacemaker implant when using your device. Doing so could result in interference with the function of the pacemaker.

Persons with pacemakers:

- Should ALWAYS keep the device more than six inches from their pacemaker when the phone is turned ON.
- Should not carry the device in a breast pocket.
- Should use the ear opposite the pacemaker to minimize the potential for interference.

Note *This is not necessary if the device is not held to the ear.*

- If you have any reason to suspect that interference is taking place, turn the device OFF immediately.

Hearing Aids

Some digital wireless phones may interfere with some hearing aids. In the event of such interference, you may want to consult your service provider, or call the customer service line to discuss alternatives.

For more regulatory information about hearing devices, see "FCC Hearing-Aid Compatibility (HAC) Regulations for Wireless Devices" on page 219.

Other Medical Devices

If you use any other personal medical device, consult the manufacturer of your device to determine if it is adequately shielded from external RF energy. Your physician may be able to assist you in obtaining this information.

Hospitals and Health Care Facilities

Turn your device OFF in health care facilities when any regulations posted in these areas instruct you to do so. Hospitals or health care facilities may be using equipment that could be sensitive to external RF energy.

Electronic Devices in Vehicles

RF signals may affect improperly installed or inadequately shielded electronic systems in motor vehicles. Check with the manufacturer or its representative regarding your vehicle. You should also consult the manufacturer of any equipment that has been added to your vehicle.

Posted Facilities

Turn your device OFF where posted notices so require.

Turn Off Your Device Before Flying

Aircraft

FCC regulations prohibit using the transmitting and phone functions of your device while in the air. In addition, most airline regulations prohibit the on-board use of portable PCs (and all other portable electronic devices that could potentially emit stray RF energy), particularly during take-offs and landings, to prevent any possible interference with the reception of signals by airborne electronic navigational devices.

Turn your device OFF before boarding an aircraft. Always request and obtain prior consent and approval of an authorized airline representative before using your device aboard an aircraft. Always follow the instructions of the airline representative whenever using your device aboard an aircraft, to prevent any possible interference with airborne electronic equipment.

Turn Off Your Device in Dangerous Areas

Blasting Areas

To avoid interfering with blasting operations, turn your device OFF when in a “blasting area” or in areas posted “Turn off two-way radio”. Obey all signs and instructions.

Potentially Explosive Atmospheres

Turn your device OFF when in any area with a potentially explosive atmosphere and obey all signs and instructions. Sparks in such areas could cause an explosion or fire resulting in bodily injury or even death.

Areas with a potentially explosive atmosphere are often, but not always, clearly marked. They include fueling areas such as gas stations; below deck on boats; fuel or chemical transfer or storage facilities; vehicles using liquefied petroleum gas (such as propane or butane); areas where the air contains chemicals or articles, such as grain, dust, or metal powders; and any other area where you would normally be advised to turn off your vehicle’s engine.

General Safety

Your pocket PC is a high quality piece of equipment. Before operating, read all instructions and cautionary markings on the product, battery and adapter/charger.

Failure to follow the directions below could result in serious bodily injury and/or property damage due to battery liquid leakage, fire or rupture.

DO NOT use or store this equipment in a place where it will be exposed to high temperatures, such as near an open flame or heat-emitting equipment.

DO NOT drop your device or subject it to severe shock. When not using, lay down the unit to avoid possible damage due to instability.

DO NOT expose this equipment to rain or spilled beverages.

DO NOT use unauthorized accessories.

DO NOT disassemble the device or its accessories. If service or repair is required, return unit to an authorized cellular service center. If the unit is disassembled, the risk of electric shock or fire may result.

Never allow metallic objects, such as staples and paper clips, to get into the inside of your device.

Never touch the liquid that might leak from a broken liquid crystal display. Contact with this liquid could cause a skin rash. If the crystal display liquid should come into contact with the skin or clothing, wash it immediately with clean water.

In the event that the device emits an unusual odor or sound or generates smoke, immediately disconnect the AC adapter from the power outlet, and then detach the battery.

Antenna Safety

Use only the supplied or an approved replacement antenna. Unauthorized antennas, modifications, or attachments could impair call quality, damage your device, or result in violation of FCC regulations. Please contact your local dealer for replacement antenna.

Do not use the device with a damaged antenna. If a damaged antenna comes into contact with the skin, a minor burn may result. Please contact your local dealer for replacement antenna.

Battery Safety

Your device uses a removable and rechargeable lithium ion battery. Please contact customer service for assistance should you need a replacement battery.

DOs

- Only use the battery and charger approved by the manufacturer.
- Only use the battery for its original purpose.
- Try to keep batteries in a temperature between 41°F (5°C) and 95°F (35°C).
- If the battery is stored in temperatures above or below the recommended range, give it time to warm up or cool down before using.
- Completely drain the battery before recharging. It may take one to four days to completely drain.
- Store the discharged battery in a cool, dark, and dry place.
- Purchase a new battery when its operating time gradually decreases after fully charging.
- Properly dispose of the battery according to local regulations.

DON'Ts

- Don't attempt to disassemble the battery – it is a sealed unit with no serviceable parts.
- Don't expose the battery terminals to any other metal object (e.g., by carrying it in your pocket or purse with other metallic objects such as coins, clips and pens). This can short circuit and critically damage the battery.
- Don't leave the battery in hot or cold temps. Otherwise, it could significantly reduce the capacity and lifetime of the battery.
- Don't dispose of the battery into a fire.

Lithium ion batteries are recyclable. When you replace the removable battery, please request the repair center to recycle the battery in accordance with RBRC standards. When disposing of the battery by yourself, please call RBRC at (800) 822-8837 for proper disposal tips.

Never touch any fluid that might leak from the built-in battery. Such liquid when in contact with the eyes or skin, could cause injury to the skin or eyes. Should the liquid come into contact with the eyes, irrigate the eyes thoroughly with clean water and immediately seek medical attention. In the event the liquid comes into contact with the skin or clothing, wash it away immediately with clean water.

Adapter/Charger

Use the Correct External Power Source

A product should be operated only from the type of power source indicated on the electrical ratings label. If you are not sure of the type of power source required, consult your authorized service provider or local power company. For a product that operates from battery power or other sources, refer to the operating instructions that are included with the product.

The AC Adapter/Charger designed for this unit requires the use of a standard 120 V AC power source for device operation.

Never attempt to disassemble or repair an AC adapter/charger. Never use an AC adapter/charger if it has a damaged or worn power cord or plug. Always contact an authorized service center, if repair or replacement is required.

Never alter the AC cord or plug on an AC adapter/charger. If the plug will not fit into the available outlet, have a proper outlet installed by a qualified electrician.

Never allow any liquids or water to spill on an AC adapter/charger when it is connected to an AC power source.

Always use the authorized AC adapter/charger to avoid any risk of bodily injury or damage to your cellular phone or battery.

Never attempt to connect or disconnect the AC adapter/charger with wet hands. Always unplug the AC adapter/charger from the power source before attempting any cleaning. Always use a soft cloth dampened with water to clean the equipment, after it has been unplugged.

Handling the cord on this product or cords associated with accessories sold with this product, will expose you to lead, a chemical known to the State of California to cause birth defects or other reproductive harm. Wash hands after handling.

Always disconnect the travel charger or desktop charger from the power source when it is not in use.

Section 4B

Regulatory Notices

- ◆ *Regulatory Agency Identifications (page 218)*
- ◆ *Federal Communication Commission Interference Statement (page 218)*
- ◆ *FCC Hearing-Aid Compatibility (HAC) Regulations for Wireless Devices (page 219)*
- ◆ *SAR Information (page 220)*
- ◆ *Body-worn Operation (page 221)*
- ◆ *Telecommunications & Internet Association (TIA) Safety Information (page 221)*
- ◆ *WEEE Notice (page 222)*
- ◆ *RoHS Compliance (page 222)*

This section provides more safety information and regulation statement for using your device.

Regulatory Agency Identifications

For regulatory identification purposes, your product is assigned a model number of RHOD400.

To ensure continued reliable and safe operation of your device, use only the accessories listed below with your RHOD400.

The Battery Pack has been assigned a model number of RHOD160.

Operating temperature range: 32°F to 104°F (0°C to 40°C)

Note	<i>This product is intended for use with a certified Class 2 Limited Power Source, rated 5 Volts DC, maximum 1 Amp power supply unit.</i>
-------------	---

Federal Communication Commission Interference Statement

This equipment has been tested and found to comply with the limits for a Class B digital device, pursuant to Part 15 of the FCC Rules. These limits are designed to provide reasonable protection against harmful interference in a residential installation. This equipment generates, uses and can radiate radio frequency energy and, if not installed and used in accordance with the instructions, may cause harmful interference to radio communications. However, there is no guarantee that interference will not occur in a particular installation. If this equipment does cause harmful interference to radio or television reception, which can be determined by turning the equipment off and on, the user is encouraged to try to correct the interference by one of the following measures:

- Reorient or relocate the receiving antenna.
- Increase the separation between the equipment and receiver.
- Connect the equipment into an outlet on a circuit different from that to which the receiver is connected.
- Consult the dealer or an experienced radio or television technician for help.

FCC Caution: Any changes or modifications not expressly approved by the party responsible for compliance could void the user's authority to operate this equipment.

This device complies with Part 15 of the FCC Rules. Operation is subject to the following two conditions: (1) This device may not cause harmful interference, and (2) this device must accept any interference received, including interference that may cause undesired operation.

Important Note

Radiation Exposure Statement:

This equipment complies with FCC radiation exposure limits set forth for an uncontrolled environment. End users must follow the specific operating instructions for satisfying RF exposure compliance. To maintain compliance with FCC RF exposure compliance requirements, please follow operation instruction as documented in this manual.

This transmitter must not be co-located or operating in conjunction with any other antenna or transmitter, except the transmitters built-in with the device.

FCC Hearing-Aid Compatibility (HAC) Regulations for Wireless Devices

On July 10, 2003, the U.S. Federal Communications Commission (FCC) Report and Order in WT Docket 01-309 modified the exception of wireless phones under the Hearing Aid Compatibility Act of 1988 (HAC Act) to require digital wireless phones be compatible with hearing-aids. The intent of the HAC Act is to ensure reasonable access to telecommunications services for persons with hearing disabilities. While some wireless phones are used near some hearing devices (hearing aids and cochlear implants), users may detect a buzzing, humming, or whining noise. Some hearing devices are more immune than others to this interference noise, and phones also vary in the amount of interference they generate. The wireless telephone industry has developed a rating system for wireless phones, to assist hearing device users find phones that may be compatible with their hearing devices. Not all phones have been rated. Phones that are rated have the rating on their box or a label located on the box. The ratings are not guarantees. Results will vary depending on the user's hearing device and hearing loss. If your hearing device happens to be vulnerable to interference, you may not be able to use a rated phone successfully. Trying out the phone with your hearing device is the best way to evaluate it for your personal needs.

M-Ratings: Phones rated M3 or M4 meet FCC requirements and are likely to generate less interference to hearing devices than phones that are not rated. M4 is the better/higher of the two ratings.

T-Ratings: Phones rated T3 or T4 meet FCC requirements and are likely to be more usable with a hearing aid's telecoil than phones that are not rated. T4 is the better/higher of the two ratings.

RHOD400 complies with the FCC's requirements for hearing aid compatibility when using the CDMA air interface. The M rating in this mode is M4 and the T rating in this mode is T3.

Your hearing device manufacturer or hearing health professional may help you find this rating. Higher ratings mean that the hearing device is relatively immune to interference noise. The hearing aid and wireless phone rating values are then added together. A sum of 5 is considered acceptable for normal use. A sum of 6 is considered for better use. A sum of 8 is considered for best use.

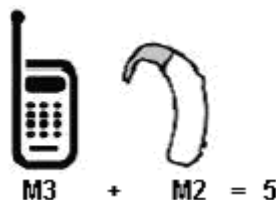

In the above example, if a hearing aid meets the M2 level rating and the wireless phone meets the M3 level rating, the sum of the two values equal M5. This should provide the hearing aid user with "normal usage" while using their hearing aid with the particular wireless phone. "Normal usage" in this context is defined as a signal quality that is acceptable for normal operation.

This methodology applies equally for T ratings. The M mark is intended to be synonymous with the U mark. The T mark is intended to be synonymous with the UT mark. The M and T marks are recommended by the Alliance for Telecommunications Industries Solutions (ATIS). The U and UT marks are referenced in Section 20.19 of the FCC Rules. The HAC rating and measurement procedure are described in the American National Standards Institute (ANSI) C63.19 standard.

For information about hearing aids and digital wireless phones

FCC Hearing Aid Compatibility and Volume Control:

<http://www.fcc.gov/cgb/dro/hearing.html>

Gallaudet University, RERC:

<https://fallfoss.fcc.gov/oetcf/eas/reports/GenericSearch.cfm>

This handset complies with the FCC's requirements for Hearing Aid Compatibility when using the CDMA air interface at both the PCS (1900 MHz) and Cellular (800 MHz) frequency bands. Hearing Aid Compatibility testing has resulted in an acoustic HAC rating of Mx and a T-Coil rating of Tx for CDMA operation. This handset is not configured to use the GSM/UMTS air interface in the United States. Hearing aid or cochlear implant users may have a slightly degraded experience when roaming internationally onto GSM or UMTS networks. Hearing aid or cochlear implant users should consult the service provider about its return and exchange policies and for information on hearing aid compatibility.

SAR Information

1.410 W/kg @ 1g (FCC)

THIS MODEL DEVICE MEETS THE GOVERNMENT'S REQUIREMENTS FOR EXPOSURE TO RADIO WAVES. For body worn operation, this phone has been tested and meets the FCC RF exposure guidelines when used with the HTC Corporation accessories supplied or designated for this product. Use of other accessories may not ensure compliance with the FCC RF exposure guidelines.

Your wireless mobile phone is a radio transmitter and receiver. It is designed and manufactured not to exceed the emission limits for exposure to radio frequency (RF) energy set by the Federal Communications Commission of the U.S. Government. These limits are part of comprehensive guidelines and establish permitted levels of RF energy for the general population. The guidelines are based on the safety standards previously set by both U.S. and international standards bodies:

- American National Standards Institute (ANSI) IEEE. C95.1-1992.
- National Council on Radiation Protection and Measurement (NCRP). Report 86. 1986.
- International Commission on Non-Ionizing Radiation Protection (ICNIRP) 1996.

The exposure standard for wireless mobile phone employs a unit of measurement known as the Specific Absorption Rate, or SAR. The SAR limit set by the FCC is 1.6 W/kg*.

The FCC has granted an Equipment Authorization for this model device with all reported SAR levels evaluated as in compliance with the FCC RF exposure guidelines. SAR information on this model device is on file with the FCC and can be found under the Display Grant section of <https://fallfoss.fcc.gov/oetcf/eas/reports/GenericSearch.cfm> after searching on FCC ID: NM8RHOD400. Additional information on Specific Absorption Rates (SAR) can be found on the Cellular Telecommunications & Internet Association (CTIA) website as <http://www.phonefacts.net>.

* In the U.S., the SAR limit for mobile phone used by the public is 1.6 Watts/kg (W/kg) averaged over one gram of tissue. The standard incorporates a substantial margin of safety to give additional protection for the public and to account for any variations in usage.

Normal condition only to ensure the radiative performance and safety of the interference. As with other mobile radio transmitting equipment, users are advised that for satisfactory operation of the equipment and for the safety of personnel, it is recommended that no part of the human body be allowed to come too close to the antenna during operation of the equipment.

Body-worn Operation

This device was tested for typical body-worn operations. To comply with RF exposure requirements, a minimum separation distance of 1.5 cm must be maintained between the user's body and the handset, including the antenna. Third-party belt-clips, holsters, and similar accessories used by this device should not contain any metallic components. Body-worn accessories that do not meet these requirements may not comply with RF exposure requirements and should be avoided.

Use only the supplied or an approved antenna. Unauthorized antennas, modifications, or attachments could impair call quality, damage the phone, or result in violation of regulations. Do not use the phone with a damaged antenna. If a damaged antenna comes into contact with the skin, a minor burn may result. Please contact your local dealer for replacement antenna.

Telecommunications & Internet Association (TIA) Safety Information

Pacemakers

The Health Industry Manufacturers Association recommends that a minimum separation of six inches be maintained between a handheld wireless phone and a pacemaker to avoid potential interference with the pacemaker. These recommendations are consistent with the independent research by and recommendations of Wireless Technology Research. Persons with pacemakers:

- Should ALWAYS keep the phone more than six inches from their pacemaker when the phone is turned ON.
- Should not carry the phone in a breast pocket.
- Should use the ear opposite the pacemaker to minimize the potential for interference. If you have any reason to suspect that interference is taking place, turn the phone OFF immediately.

Hearing Aids

Some digital wireless phones may interfere with some hearing aids. In the event of such interference, you may want to consult your service provider, or call the customer service line to discuss alternatives.

Other Medical Devices

If you use any other personal medical device, consult the manufacturer of your device to determine if they are adequately shielded from external RF energy. Your physician may be able to assist you in obtaining this information.

Turn the phone OFF in health care facilities when any regulations posted in these areas instruct you to do so. Hospitals or health care facilities may be using equipment that could be sensitive to external RF energy.

WEEE Notice

The Directive on Waste Electrical and Electronic Equipment (WEEE), which entered into force as European law on 13th February 2003, resulted in a major change in the treatment of electrical equipment at end-of-life.

The purpose of this Directive is, as a first priority, the prevention of WEEE, and in addition, to promote the reuse, recycling and other forms of recovery of such wastes so as to reduce disposal.



The WEEE logo (shown at the left) on the product or on its box indicates that this product must not be disposed of or dumped with your other household waste. You are liable to dispose of all your electronic or electrical waste equipment by relocating over to the specified collection point for recycling of such hazardous waste. Isolated collection and proper recovery of your electronic and electrical waste equipment at the time of disposal will allow us to help conserving natural resources. Moreover, proper recycling of the electronic and electrical waste equipment will ensure safety of human health and environment. For more information about electronic and electrical waste equipment disposal, recovery, and collection points, please contact your local city center, household waste disposal service, shop from where you purchased the equipment, or manufacturer of the equipment.

RoHS Compliance

This product is in compliance with Directive 2002/95/EC of the European Parliament and of the Council of 27 January 2003, on the restriction of the use of certain hazardous substances in electrical and electronic equipment (RoHS) and its amendments.

Warranty, Disclaimers and Other Notices

- ◆ *Manufacturer's Warranty (page 223)*
- ◆ *Privacy Restrictions (page 225)*
- ◆ *Weather Disclaimer (page 225)*
- ◆ *Warranty Disclaimer (page 225)*
- ◆ *Limitation of Damages (page 225)*

Your device has been designed to provide you with reliable, worry-free service. If for any reason you have a problem with your equipment, please refer to the manufacturer's warranty in this section. For information regarding the terms and conditions of service for your device, please visit www.sprint.com or call Sprint Customer Service at 1-888-211-4727.

Manufacturer's Warranty

12 Month Limited Warranty

HTC Corporation (the Company) warrants to the original retail purchaser of this HTC handheld portable cellular telephone, that should this product or any part thereof during normal consumer usage and conditions, be proven defective in material or workmanship that results in product failure within the first twelve (12) month period from the date of purchase, such defect(s) will be repaired or replaced (with new or rebuilt parts) at the Company's option, without charge for parts or labor directly related to the defect(s).

The antenna, keypad, display, rechargeable battery and battery charger, if included, are similarly warranted for twelve (12) months from date of purchase.

This Warranty extends only to consumers who purchase the product in the United States or Canada and it is not transferable or assignable.

This Warranty does not apply to:

- (a) Product subjected to abnormal use or conditions, accident, mishandling, neglect, unauthorized alteration, misuse, improper installation or repair or improper storage;
- (b) Product whose mechanical serial number or electronic serial number has been removed, altered or defaced;
- (c) Damage from exposure to moisture, humidity, excessive temperatures or extreme environmental conditions;
- (d) Damage resulting from connection to, or use of any accessory or other product not approved or authorized by the Company;
- (e) Defects in appearance, cosmetic, decorative or structural items such as framing and non-operative parts;
- (f) Product damaged from external causes such as fire, flooding, dirt, sand, weather conditions, battery leakage, blown fuse, theft or improper usage of any electrical source.

The Company disclaims liability for removal or reinstallation of the product, for geographic coverage, for inadequate signal reception by the antenna or for communications range or operation of the cellular system as a whole.

When sending your wireless device to HTC Corporation for repair or service, please note that any personal data or software stored on the device may be inadvertently erased or altered. Therefore, we strongly recommend you make a back up copy of all data and software contained on your device before submitting it for repair or service. This includes all contact lists, downloads (i.e. third-party software applications, ringtones, games and graphics) and any other data added to your device. In addition, if your wireless device utilizes a SIM or Multimedia card, please remove the card before submitting the device and store for later use when your device is returned, HTC Corporation is not responsible for and does not guarantee restoration of any third-party software, personal information or memory data contained in, stored on, or integrated with any wireless device, whether under warranty or not, returned to HTC Corporation for repair or service.

To obtain repairs or replacement within the terms of this Warranty, the product should be delivered with proof of Warranty coverage (e.g. dated bill of sale), the consumer's return address, daytime phone number and/or fax number and complete description of the problem, transportation prepaid, to the Company at the address shown below or to the place of purchase for repair or replacement processing. In addition, for reference to an authorized Warranty station in your area, you may telephone in the United States (888) 870-4736.

THE EXTENT OF THE COMPANY'S LIABILITY UNDER THIS WARRANTY IS LIMITED TO THE REPAIR OR REPLACEMENT PROVIDED ABOVE AND, IN NO EVENT, SHALL THE COMPANY'S LIABILITY EXCEED THE PURCHASE PRICE PAID BY PURCHASER FOR THE PRODUCT.

ANY IMPLIED WARRANTIES, INCLUDING ANY IMPLIED WARRANTY OF MERCHANTABILITY OR FITNESS FOR A PARTICULAR PURPOSE, SHALL BE LIMITED TO THE DURATION OF THIS WRITTEN WARRANTY. ANY ACTION FOR BREACH OF ANY WARRANTY MUST BE BROUGHT WITHIN A PERIOD OF 18 MONTHS FROM DATE OF ORIGINAL PURCHASE. IN NO CASE SHALL THE COMPANY BE LIABLE FOR AN SPECIAL CONSEQUENTIAL OR INCIDENTAL DAMAGES FOR BREACH OF THIS OR ANY OTHER WARRANTY, EXPRESS OR IMPLIED, WHATSOEVER. THE COMPANY SHALL NOT BE LIABLE FOR THE DELAY IN RENDERING SERVICE UNDER THIS WARRANTY OR LOSS OF USE DURING THE TIME THE PRODUCT IS BEING REPAIRED OR REPLACED.

No person or representative is authorized to assume for the Company any liability other than expressed herein in connection with the sale of this product.

Some states or provinces do not allow limitations on how long an implied warranty lasts or the exclusion or limitation of incidental or consequential damage so the above limitation or exclusions may not apply to you. This Warranty gives you specific legal rights, and you may also have other rights, which vary from state to state.

IN USA AND CANADA:

HTC Corporation
5950 Corporate Dr.
Houston, TX 77036

Privacy Restrictions

Some countries require full disclosure of recorded telephone conversations, and stipulate that you must inform the person with whom you are speaking that the conversation is being recorded. Always obey the relevant laws and regulations of your country when using the recording feature of your device.

Weather Disclaimer

THE WEATHER INFORMATION, DATA AND DOCUMENTATION ARE PROVIDED “AS IS” AND WITHOUT WARRANTY OR TECHNICAL SUPPORT OF ANY KIND FROM HTC. TO THE MAXIMUM EXTENT PERMITTED BY APPLICABLE LAW, HTC AND ITS AFFILIATES expressly disclaim any and all representations and warranties, express or implied, arising by law or otherwise, regarding the Weather Information, Data, Documentation, or any other Products and services, including without limitation any express or implied warranty of merchantability, express or implied warranty of fitness for a particular purpose, non-infringement, quality, accuracy, completeness, effectiveness, reliability, usefulness, that the Weather Information, Data and/or Documentation will be error-free, or implied warranties arising from course of dealing or course of performance.

Without limiting the foregoing, it is further understood that HTC and its Providers are not responsible for Your use or misuse of the Weather Information, Data and/or Documentation or the results from such use. HTC and its Providers make no express or implied warranties, guarantees or affirmations that weather information will occur or has occurred as the reports, forecasts, data, or information state, represent or depict and it shall have no responsibility or liability whatsoever to any person or entity, parties and non-parties alike, for any inconsistency, inaccuracy, or omission for weather or events predicted or depicted, reported, occurring or occurred. WITHOUT LIMITING THE GENERALITY OF THE FOREGOING, YOU ACKNOWLEDGE THAT THE WEATHER INFORMATION, DATA AND/OR DOCUMENTATION MAY INCLUDE INACCURACIES AND YOU WILL USE COMMON SENSE AND FOLLOW STANDARD SAFETY PRECAUTIONS IN CONNECTION WITH THE USE OF THE WEATHER INFORMATION, DATA OR DOCUMENTATION.

Warranty Disclaimer

Your warranty is invalidated if you open or tamper with the device's outer casing.

For details about warranty coverage, see “Manufacturer’s Warranty” on page 223.

Limitation of Damages

TO THE MAXIMUM EXTENT PERMITTED BY APPLICABLE LAW, IN NO EVENT SHALL HTC OR ITS PROVIDERS BE LIABLE TO USER OR ANY THIRD PARTY FOR ANY INDIRECT, SPECIAL, CONSEQUENTIAL, INCIDENTAL OR PUNITIVE DAMAGES OF ANY KIND, IN CONTRACT OR TORT, INCLUDING, BUT NOT LIMITED TO, INJURY, LOSS OF REVENUE, LOSS OF GOODWILL, LOSS OF BUSINESS OPPORTUNITY, LOSS OF DATA, AND/OR LOSS OF PROFITS ARISING OUT OF, OR RELATED TO, IN ANY MANNER, OR THE DELIVERY, PERFORMANCE OR NONPERFORMANCE OF OBLIGATIONS, OR USE OF THE WEATHER INFORMATION, DATA OR DOCUMENTATION HEREUNDER REGARDLESS OF THE FORESEEABILITY THEREOF.

Copyright, Trademark, and Proprietary Notices

©2010 Sprint. Sprint and the logo are trademarks of Sprint. Other marks are the property of their respective owners.

HTC, the HTC logo, HTC Innovation, ExtUSB, HTC Sense, HTC Touch Pro, HTC Peep, and HTC Care are trademarks and/or service marks of HTC Corporation.

Microsoft, Windows, Windows Mobile, Windows XP, Windows Vista, ActiveSync, Windows Mobile Device Center, Internet Explorer, MSN, Hotmail, Windows Live, Outlook, Excel, PowerPoint, Word, OneNote and Windows Media are either registered trademarks or trademarks of Microsoft Corporation in the United States and/or other countries.

Bluetooth and the Bluetooth logo are trademarks owned by Bluetooth SIG, Inc.

Wi-Fi is a registered trademark of the Wireless Fidelity Alliance, Inc.

Java, J2ME and all other Java-based marks are trademarks or registered trademarks of Sun Microsystems, Inc. in the United States and other countries.

microSD is a trademark of SD Card Association.

Opera Mobile from Opera Software ASA. Copyright 1995-2010 Opera Software ASA. All Rights Reserved.

Google, Google Maps, and YouTube are trademarks of Google, Inc. in the United States and other countries.

All other company, product and service names mentioned herein are trademarks, registered trademarks or service marks of their respective owners.

Index

A

- A2DP 101
- ActiveSync 77, 78
- Adding and Removing Programs 130
- Airplane Mode 73, 89
- Alarm Clock 37
- Album
 - About 112
 - Closing Album 115
 - Playing Back Video 115
 - Viewing a Photo 113
- Attachment
 - Downloading 166
- Audio Booster 118

B

- Basic Settings 125
- Battery
 - Battery Saving Tips 14
 - Charging the Battery 13
 - Installing the Battery 2
 - Removing the Battery 13
 - Using Your Device's Battery and Charger 12
- Bing 192
- Bluetooth
 - About 100
 - Connecting a Bluetooth Hands-free or Stereo Headset 101
 - Modes 100
 - Partnerships (Pairing) 101
 - Printing 104
 - Sending and Receiving Information 102
 - Turning Bluetooth On and Making Your Device Visible 100
 - Turning Bluetooth On and Off 90
- Business Card Scanner (see "WorldCard Mobile") 95

C

- Calendar
 - Creating Appointments 84
 - Sending Appointments 85
 - Viewing Appointments 85
- Call Barring (GSM) 202
- Call Forwarding (CDMA) 142
- Call Guard (CDMA) 144

- Call Waiting
 - CDMA 142
 - GSM 204
- Caller ID
 - CDMA 141
 - GSM 204
- Camera
 - Auto Focus 107
 - Capture Modes 105
 - Onscreen Controls and Indicators 109
 - Zooming 106
- Checking Missed Calls 69
- Clear Storage 132
- Comm Manager 89
- Company Directory 172
- Connecting to an External Display 129
- Connecting to Data Services 149
- Contacts 42, 82
- Contacts Picture capture mode 106
- Copying and Managing Files 121

D

- Data Connection 19, 149, 150
- Data Roam Guard (CDMA) 145
- Device Name 128
- Direct Dial
 - CDMA 65
 - GSM 196
- Direct Push 90, 169
- Downloading
 - Downloading a Complete Email Message 166
 - File Attachments 166
 - Satellite Data 189
 - Web Feeds 160

E

- Email
 - Customizing Email Settings 167
 - Internet Email 164
 - Mail Tab 46
 - Outlook Email 164
 - Replying To or Forwarding a Message 166
 - Sending 165
 - Types of Email Accounts 164
- Emoticon
 - Windows Live Messenger 157
- Encryption 98
- Exchange Server 168, 169

F

Facebook Updates and Events 44
Favorite Contacts 38
File Explorer 121
Finding Contacts
 Company Directory 172
Full QWERTY 27

G

Global Mode 195
Global Smart Dialing
 CDMA 65
 GSM 196
GPS 188
GSM 195, 202

H

Hard Reset 132
Home Screen 16, 32
Home Tab 35

I

Input Methods
 Full QWERTY 27
 Phone Keypad 29
Inserting the microSD Card 97
Instant Messaging 163
International Calls
 CDMA 65
 GSM 196
Internet Email 164
Internet Explorer Mobile 154
Internet Sharing 173
Internet Tab 50

J

JETCET Presentation 91
JETCET PRINT 96

L

Library
 Music Tab 53
Live Messenger 156
Live Search
 See Bing

M

Mail Tab 46

Making a Call
 International Call (CDMA) 65
 International Call (GSM) 196
 Phone Screen 63
 Three-Way Call (CDMA) 142
Meeting Requests 172
Memory 130
Messaging
 Email 164
 Instant Messaging 163
 Text Messaging 137
 Windows Live Messenger 156
Messenger 156
Microsoft My Phone 80
Microsoft Office Mobile 90
Missed Call Notification 69
MMS Video Capture Mode 106
MP3 Trimmer 119

N

Network Selection (GSM) 205
News Channels (Web Feeds) 160
Notes 86
Numeric and Symbol Mode 31

O

Office Mobile 90
Opera Mobile 151

P

Panorama Capture Mode 106
People Tab 38
Phone 63
Phone Keypad 29
Phone Services 74
Photo Capture Mode 106
Photos and Videos Tab 51
Picture Theme Capture Mode 106
Playing Music
 Music Tab 52
Playlists
 Music Tab 53
 Windows Media Player Mobile 117
Plus (+) Code Dialing (GSM) 196
Predictive Mode 30
Putting a Call On Hold 67

Q

QuickGPS 189

R

Recording

Camera 105

Voice Recorder 94

Remote Desktop Mobile 175

Removing the microSD card 97

Replying

Email 166

Text (SMS) 139

Resetting

Clear Storage 132

Hard Reset 131

Soft Reset 131

Roaming 143

S

Selecting a Network (GSM) 205

Sending

Email 165

Meeting Request 85

Text Message 138

Video and Picture Messages 140

Sending and Receiving Information Using

Bluetooth 102

Settings Tab 62

SIM Card 193

SIM Manager 199, 200, 201

SIM Phonebook 199

Sleep Mode 12

SMS 47, 137

Soft Reset 131

Sound and Display Settings 125

Speakerphone 68

Speed Dial 70

Sprint Instant Messaging 163

Sprint Music Store 178

Sprint TV 176

Sprint TV Tab 55

Start Screen 17

Status Icons 18

Streaming Media 180

Switching Between Two Calls 67

Synchronizing

ActiveSync 78

Choosing What Information Is Synchronized 78

Exchange Server 168

Music and Videos 79

Using Bluetooth 79

Video and Audio Files 116

Windows Mobile Device Center 76

Your Device With Your Computer 78

T

Task Manager 128

Tasks 87

Text Messages

Creating a New Text Message 137

Messages Tab 47

Sending 138

Three-Way Call (CDMA) 142

Touch Focus 107

Troubleshooting

Sync Connection 79

Windows Media Player Mobile 118

Turning the Phone On and Off 73, 90

Turning Your Device On and Off 12

Twitter 58

U

Updates and Events (Facebook) 44

Updating weather information 36

USB to PC 79

Using Your Device as a USB Drive 98

V

Vibrate 19

Video Capture Mode 106

Voice Recorder 94

Voicemail 4, 65, 134, 197, 204

W

Weather Tab 56

Wi-Fi 89, 147

Windows Live 155

Windows Live Messenger 156

Windows Marketplace 95

Windows Media Player Mobile 116

Windows Mobile Device Center 76

Wireless printing (see "JETCET Print") 96

World Clock 36

WorldCard Mobile 95

Y

YouTube 181

Z

Zooming

Camera 106

Zoom Bar 15

Free Manuals Download Website

<http://myh66.com>

<http://usermanuals.us>

<http://www.somanuals.com>

<http://www.4manuals.cc>

<http://www.manual-lib.com>

<http://www.404manual.com>

<http://www.luxmanual.com>

<http://aubethermostatmanual.com>

Golf course search by state

<http://golfingnear.com>

Email search by domain

<http://emailbydomain.com>

Auto manuals search

<http://auto.somanuals.com>

TV manuals search

<http://tv.somanuals.com>