

User Manual

READ

Please Read Before Proceeding

THE BATTERY IS NOT CHARGED WHEN YOU TAKE IT OUT OF THE BOX.

DO NOT REMOVE THE BATTERY PACK WHEN THE DEVICE IS CHARGING.





YOUR WARRANTY IS INVALIDATED IF YOU OPEN OR TAMPER WITH THE DEVICE'S OUTER CASING.

PRIVACY RESTRICTIONS

Some countries require full disclosure of recorded telephone conversations, and stipulate that you must inform the person with whom you are speaking that the conversation is being recorded. Always obey the relevant laws and regulations of your country when using the recording feature of your PDA Phone.

INTELLECTUAL PROPERTY RIGHT INFORMATION

Copyright © 2008 HTC Corporation. All Rights Reserved.

 ,  ,  ,  , ExtUSB, and HTC Care are trademarks and/or service marks of HTC Corporation.

Microsoft, MS-DOS, Windows, Windows NT, Windows Server, Windows Mobile, Windows XP, Windows Vista, ActiveSync, Windows Mobile Device Center, Internet Explorer, MSN, Hotmail, Windows Live, Outlook, Excel, PowerPoint, Word, OneNote and Windows Media are either registered trademarks or trademarks of Microsoft Corporation in the United States and/or other countries.

Bluetooth and the Bluetooth logo are trademarks owned by Bluetooth SIG, Inc.

Copyright © 2008, Adobe Systems Incorporated. All Rights Reserved.

Opera® Mobile from Opera Software ASA. Copyright 1995-2008 Opera Software ASA. All Rights Reserved.

Google is a registered trademark of Google, Inc. in the United States and other countries.

YouTube is a trademark of Google, Inc.

Copyright © 2001-2008, Spb Software House. All Rights Reserved.

Copyright © 2008, Esmertec AG. All Rights Reserved.

Copyright © 2003-2008, ArcSoft, Inc. and its licensors. All Rights Reserved. ArcSoft and the ArcSoft logo are registered trademarks of ArcSoft, Inc. in the United States and/or other countries.

Copyright © 2004-2008, Ilium Software, Inc. All Rights Reserved.

All other company, product and service names mentioned herein are trademarks, registered trademarks or service marks of their respective owners.

HTC shall not be liable for technical or editorial errors or omissions contained herein, nor for incidental or consequential damages resulting from furnishing this material. The information is provided "as is" without warranty of any kind and is subject to change without notice. HTC also reserves the right to revise the content of this document at any time without prior notice.

No part of this document may be reproduced or transmitted in any form or by any means, electronic or mechanical, including photocopying, recording or storing in a retrieval system, or translated into any language in any form without prior written permission of HTC.

Disclaimers

THE WEATHER INFORMATION, DATA AND DOCUMENTATION ARE PROVIDED "AS IS" AND WITHOUT WARRANTY OR TECHNICAL SUPPORT OF ANY KIND FROM HTC. TO THE MAXIMUM EXTENT PERMITTED BY APPLICABLE LAW, HTC AND ITS AFFILIATES expressly disclaim any and all representations and warranties, express or implied, arising by law or otherwise, regarding the Weather Information, Data, Documentation, or any other Products and services, including without limitation any express or implied warranty of merchantability, express or implied warranty of fitness for a particular purpose, non-infringement, quality, accuracy, completeness, effectiveness, reliability, usefulness, that the Weather Information, Data and/or Documentation will be error-free, or implied warranties arising from course of dealing or course of performance.

Without limiting the foregoing, it is further understood that HTC and its Providers are not responsible for Your use or misuse of the Weather Information, Data and/or Documentation or the results from such use. HTC and its Providers make no express or implied warranties, guarantees or affirmations that weather information will occur or has occurred as the reports, forecasts, data, or information state, represent or depict and it shall have no responsibility or liability whatsoever to any person or entity, parties and non-parties alike, for any inconsistency, inaccuracy, or omission for weather or events predicted or depicted, reported, occurring or occurred. WITHOUT LIMITING THE GENERALITY OF THE FOREGOING, YOU ACKNOWLEDGE THAT THE WEATHER INFORMATION, DATA AND/OR DOCUMENTATION MAY INCLUDE INACCURACIES AND YOU WILL USE COMMON SENSE AND FOLLOW STANDARD SAFETY PRECAUTIONS IN CONNECTION WITH THE USE OF THE WEATHER INFORMATION, DATA OR DOCUMENTATION.

Limitation of Damages

TO THE MAXIMUM EXTENT PERMITTED BY APPLICABLE LAW, IN NO EVENT SHALL HTC OR ITS PROVIDERS BE LIABLE TO USER OR ANY THIRD PARTY FOR ANY INDIRECT, SPECIAL, CONSEQUENTIAL, INCIDENTAL OR PUNITIVE DAMAGES OF ANY KIND, IN CONTRACT OR TORT, INCLUDING, BUT NOT LIMITED TO, INJURY, LOSS OF REVENUE, LOSS OF GOODWILL, LOSS OF BUSINESS OPPORTUNITY, LOSS OF DATA, AND/OR LOSS OF PROFITS ARISING OUT OF, OR RELATED TO, IN ANY MANNER, OR THE DELIVERY, PERFORMANCE OR NONPERFORMANCE OF OBLIGATIONS, OR USE OF THE WEATHER INFORMATION, DATA OR DOCUMENTATION HEREUNDER REGARDLESS OF THE FORESEEABILITY THEREOF.

Important Health Information and Safety Precautions

When using this product, the safety precautions below must be taken to avoid possible legal liabilities and damages.

Retain and follow all product safety and operating instructions. Observe all warnings in the operating instructions on the product.

To reduce the risk of bodily injury, electric shock, fire, and damage to the equipment, observe the following precautions.

ELECTRICAL SAFETY

This product is intended for use when supplied with power from the designated battery or power supply unit. Other usage may be dangerous and will invalidate any approval given to this product.

SAFETY PRECAUTIONS FOR PROPER GROUNDING INSTALLATION

CAUTION: Connecting to an improperly grounded equipment can result in an electric shock to your device.

This product equipped with a USB Cable for connecting with desktop or notebook computer. Be sure your computer is properly grounded (earthed) before connecting this product to the computer. The power supply cord of a desktop or notebook computer has an equipment-grounding conductor and a grounding plug. The plug must be plugged into an appropriate outlet which is properly installed and grounded in accordance with all local codes and ordinances.

SAFETY PRECAUTIONS FOR POWER SUPPLY UNIT

- **Use the correct external power source**

A product should be operated only from the type of power source indicated on the electrical ratings label. If you are not sure of the type of power source required, consult your authorized service provider or local power company. For a product that operates from battery power or other sources, refer to the operating instructions that are included with the product.

- **Handle battery packs carefully**

This product contains a Li-ion battery. There is a risk of fire and burns if the battery pack is handled improperly. Do not attempt to open or service the battery pack. Do not disassemble, crush, puncture, short external contacts or circuits, dispose of in fire or water, or expose a battery pack to temperatures higher than 60°C (140°F).



WARNING: Danger of explosion if battery is incorrectly replaced. To reduce risk of fire or burns, do not disassemble, crush, puncture, short external contacts, expose to temperature above 60°C (140°F), or dispose of in fire or water. Replace only with specified batteries. Recycle or dispose of used batteries according to the local regulations or reference guide supplied with your product.



Li-ion



- **Take extra precautions**

- Keep the battery or device dry and away from water or any liquid as it may cause a short circuit.
- Keep metal objects away so they don't come in contact with the battery or its connectors as it may lead to short circuit during operation.
- Do not use a battery that appears damaged, deformed, or discolored, or the one that has any rust on its casing, overheats, or emits a foul odor.
- Always keep the battery out of the reach of babies and small children, to avoid swallowing of the battery. Consult the doctor immediately if the battery is swallowed.
- If the battery leaks:
 - Do not allow the leaking fluid to come in contact with skin or clothing. If already in contact, flush the affected area immediately with clean water and seek medical advice.
 - Do not allow the leaking fluid to come in contact with eyes. If already in contact, DO NOT rub; rinse with clean water immediately and seek medical advice.
 - Take extra precautions to keep a leaking battery away from fire as there is a danger of ignition or explosion.

SAFETY PRECAUTIONS FOR DIRECT SUNLIGHT

Keep this product away from excessive moisture and extreme temperatures. Do not leave the product or its battery inside a vehicle or in places where the temperature may exceed 60°C (140°F), such as on a car dashboard, window sill, or behind a glass that is exposed to direct sunlight or strong ultraviolet light for extended periods of time. This may damage the product, overheat the battery, or pose a risk to the vehicle.

PREVENTION OF HEARING LOSS

CAUTION: Permanent hearing loss may occur if earphones or headphones are used at high volume for prolonged periods of time.

SAFETY IN AIRCRAFT

Due to the possible interference caused by this product to an aircraft's navigation system and its communications network, using this device's phone function on board an airplane is against the law in most countries. If you want to use this device when on board an aircraft, remember to turn off your phone by switching to Airplane Mode.

ENVIRONMENT RESTRICTIONS

Do not use this product in gas stations, fuel depots, chemical plants or where blasting operations are in progress, or in potentially explosive atmospheres such as fuelling areas, fuel storehouses, below deck on boats, chemical plants, fuel or chemical transfer or storage facilities, and areas where the air contains chemicals or particles, such as grain, dust, or metal powders. Please be aware that sparks in such areas could cause an explosion or fire resulting in bodily injury or even death.

EXPLOSIVE ATMOSPHERES

When in any area with a potentially explosive atmosphere or where flammable materials exist, the product should be turned off and the user should obey all signs and instructions. Sparks in such areas could cause an explosion or fire resulting in bodily injury or even death. Users are advised not to use the equipment at refueling points such as service or gas stations, and are reminded of the need to observe restrictions on the use of radio equipment in fuel depots, chemical plants, or where blasting operations are in progress. Areas with a potentially explosive atmosphere are often, but not always, clearly marked. These include fueling areas, below deck on boats, fuel or chemical transfer or storage facilities, and areas where the air contains chemicals or particles, such as grain, dust, or metal powders.

ROAD SAFETY

Vehicle drivers in motion are not permitted to use telephony services with handheld devices, except in the case of emergency. In some countries, using hands-free devices as an alternative is allowed.

SAFETY PRECAUTIONS FOR RF EXPOSURE

- Avoid using your phone near metal structures (for example, the steel frame of a building).
- Avoid using your phone near strong electromagnetic sources, such as microwave ovens, sound speakers, TV and radio.
- Use only original manufacturer-approved accessories, or accessories that do not contain any metal.
- Use of non-original manufacturer-approved accessories may violate your local RF exposure guidelines and should be avoided.

INTERFERENCE WITH MEDICAL EQUIPMENT FUNCTIONS

This product may cause medical equipment to malfunction. The use of this device is forbidden in most hospitals and medical clinics.

If you use any other personal medical device, consult the manufacturer of your device to determine if they are adequately shielded from external RF energy. Your physician may be able to assist you in obtaining this information.

Turn your phone OFF in health care facilities when any regulations posted in these areas instruct you to do so. Hospitals or health care facilities may be using equipment that could be sensitive to external RF energy.

HEARING AIDS

Some digital wireless phones may interfere with some hearing aids. In the event of such interference, you may want to consult your service provider, or call the customer service line to discuss alternatives.

NONIONIZING RADIATION

Your device has an internal antenna. This product should be operated in its normal-use position to ensure the radiative performance and safety of the interference. As with other mobile radio transmitting equipment, users are advised that for satisfactory operation of the equipment and for the safety of personnel, it is recommended that no part of the human body be allowed to come too close to the antenna during operation of the equipment.

Use only the supplied integral antenna. Use of unauthorized or modified antennas may impair call quality and damage the phone, causing loss of performance and SAR levels exceeding the recommended limits as well as result in non-compliance with local regulatory requirements in your country.

To assure optimal phone performance and ensure human exposure to RF energy is within the guidelines set forth in the relevant standards, always use your device only in its normal-use position. Contact with the antenna area may impair call quality and cause your device to operate at a higher power level than needed. Avoiding contact with the antenna area when the phone is IN USE optimizes the antenna performance and the battery life.

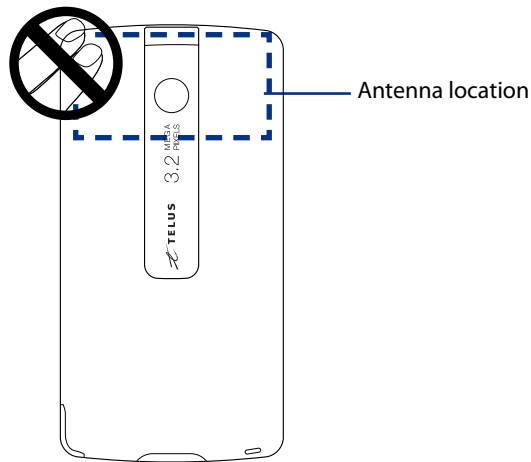

General Precautions

- **Avoid applying excessive pressure to the device**

Do not apply excessive pressure on the screen and the device to prevent damaging them and remove the device from your pants' pocket before sitting down. It is also recommended that you store the device in a protective case and only use the device stylus or your finger when interacting with the touch screen. Cracked display screens due to improper handling are not covered by the warranty.

- **Heed service markings**

Except as explained elsewhere in the Operating or Service documentation, do not service any product yourself. Service needed on components inside the device should be done by an authorized service technician or provider.

- **Damage requiring service**

Unplug the product from the electrical outlet and refer servicing to an authorized service technician or provider under the following conditions:

- Liquid has been spilled or an object has fallen into the product.
- The product has been exposed to rain or water.
- The product has been dropped or damaged.
- There are noticeable signs of overheating.
- The product does not operate normally when you follow the operating instructions.

- **Avoid hot areas**

The product should be placed away from heat sources such as radiators, heat registers, stoves, or other products (including amplifiers) that produce heat.

- **Avoid wet areas**

Never use the product in a wet location.

- **Avoid using your device after a dramatic change in temperature**

When you move your device between environments with very different temperature and/or humidity ranges, condensation may form on or within the device. To avoid damaging the device, allow sufficient time for the moisture to evaporate before using the device.

NOTICE: When taking the device from low-temperature conditions into a warmer environment or from high-temperature conditions into a cooler environment, allow the device to acclimate to room temperature before turning on power.

- **Avoid pushing objects into product**

Never push objects of any kind into cabinet slots or other openings in the product. Slots and openings are provided for ventilation. These openings must not be blocked or covered.

- **Mounting accessories**

Do not use the product on an unstable table, cart, stand, tripod, or bracket. Any mounting of the product should follow the manufacturer's instructions, and should use a mounting accessory recommended by the manufacturer.

- **Avoid unstable mounting**

Do not place the product with an unstable base.

- **Use product with approved equipment**

This product should be used only with personal computers and options identified as suitable for use with your equipment.

- **Adjust the volume**

Turn down the volume before using headphones or other audio devices.

- **Cleaning**

Unplug the product from the wall outlet before cleaning. Do not use liquid cleaners or aerosol cleaners. Use a damp cloth for cleaning, but NEVER use water to clean the LCD screen.

- **For magnetic devices**



Please avoid putting any media that contains magnets, e.g. magnetic card, credit cards, bank cards, audio/video tape or magnetic memory devices, directly on the device or stylus without any distance.



It is highly recommended to put the media containing magnets in a security distance of at least 5 cm. If you carry your wallet or billfold which contains magnetic cards next to the device or its stylus, information stored on these cards could be destroyed.

Please make sure that there is an adequate distance between the device or its stylus and other magnetic sensitive devices, e.g., a mechanical watch or measure instruments.

- **For pacemakers**



The functionality of pacemakers can be interfered by the device and its stylus. Always keep the device and its stylus in a fair distance to your pacemaker, which at least will be 5 cm. In any case, please do not carry the device and/or its stylus in the front pockets of your shirt or coat.



For information about other medical active implants, please contact the producer or a doctor to ensure such active implants will not be interfered by magnetic field.

Contents

Chapter 1 Getting Started	15
1.1 Getting to Know Your Touch Phone and Accessories	16
Top panel	16
Front panel	16
Bottom panel	16
Left panel	17
Back panel	17
Right panel	17
Accessories	17
1.2 Installing the Battery	18
Battery	18
1.3 Charging the Battery	19
1.4 Using the Strap Holder	19
1.5 Starting Up	20
Turn your device on and off	20
Switch to Sleep mode when not in use	20
1.6 Navigating Your Device	20
Finger-touch control	20
Stylus	21
Navigation Control	21
1.7 Home Screen	22
1.8 Status Icons	22
1.9 Start Menu	24
1.10 Quick Menu	24
1.11 LED Alerts	25
1.12 Adjusting the Volume	25
1.13 Using your Device as a USB Drive	26
Chapter 2 Using Phone Features	27
2.1 Using the Phone	28
The Phone screen	28
2.2 Voice Call	28
Make a call	28
Answer a call	29
End a call	30
Call History	30

Speed Dial	30
Turn the phone function on and off	31
2.3 Smart Dial	31
Make a call or send a text message using Smart Dial.....	32

Chapter 3 TouchFLO™ 3D 33

3.1 About TouchFLO™ 3D.....	34
3.2 Using the TouchFLO 3D Home Screen	34
Home	35
People.....	36
Messages	37
Mail	37
Photos and Videos.....	38
Music.....	39
Internet.....	41
Weather.....	41
Settings	42
Programs.....	42
3.3 Finger Gestures.....	43
Finger scrolling.....	43
Finger zooming	43
Finger panning.....	43

Chapter 4 Entering Text 45

4.1 Selecting an Input Method	46
4.2 Using the Full QWERTY	46
4.3 Using the Compact QWERTY	47
4.4 Using the Phone Keypad	48
4.5 Using Multitap and T9 Modes	48
Multitap mode.....	48
T9 mode.....	48
4.6 Using Numeric and Symbol Mode	49
4.7 Using Block Recognizer	50
4.8 Using Letter Recognizer	50
4.9 Using Transcriber	50

Chapter 5 Synchronizing Information With Your Computer 53

5.1 About Synchronization	54
Ways to synchronize.....	54
5.2 Setting Up Windows Mobile® Device Center on Windows Vista®	54
Set up synchronization in Windows Mobile Device Center	54

Use Windows Mobile Device Center.....	55
5.3 Setting Up ActiveSync® on Windows XP®	55
Install ActiveSync.....	55
Set up synchronization in ActiveSync.....	55
5.4 Synchronizing With Your Computer	56
Start and stop synchronization	56
Change which information is synchronized	56
Troubleshoot sync connection problem.....	56
5.5 Synchronizing via Bluetooth	57
5.6 Synchronizing Music and Video.....	57
Chapter 6 Exchanging Messages	59
6.1 Messaging	60
6.2 Text Messages	60
Create a new text message	60
Compose and send a text message	61
Manage text messages.....	61
6.3 Types of E-mail Accounts.....	62
Set up your device to synchronize Outlook e-mail with the computer.....	62
Add an e-mail account	62
6.4 E-mail Setup Wizard.....	62
Set up an Internet e-mail account.....	62
Set up a custom domain e-mail	63
6.5 Using E-mail.....	64
Create a new e-mail message	64
Compose and send an e-mail	64
Filter the Inbox message list.....	65
View and reply to messages	65
Synchronize e-mails.....	66
Customize e-mail settings.....	66
Chapter 7 Working With Company E-mails and Meeting	
Appointments	69
7.1 Synchronizing with the Exchange Server	70
Set up an Exchange Server connection.....	70
Start synchronization	70
7.2 Working With Company E-mails	71
Automatic synchronization through Direct Push	71
Scheduled synchronization	71
Instant download through Fetch Mail	71
Search for e-mails on the Exchange Server.....	72

Flag your messages	72
7.3 Managing Meeting Requests	73
Out-of-office auto-reply	73
7.4 Finding Contacts in the Company Directory	74

Chapter 8 Internet **75**

8.1 Ways of Connecting to the Internet.....	76
Wi-Fi.....	76
Dial-up.....	78
8.2 Starting a Data Connection.....	78
8.3 Using Opera Mobile™.....	79
View Web pages.....	80
Opera Mobile menu	80
8.4 Using YouTube™.....	81
Browse for videos	81
Watching videos	82
Bookmarks	83
History	83
8.5 Using Windows Live™.....	84
Set up Windows Live™.....	84
The Windows Live™ interface.....	84
Windows Live™ Messenger	85
Launch Messenger and sign in.....	85
Add Windows Live™ contacts.....	85
8.6 Using Your Device As a Modem (Wireless Modem)	86
Activate your device as a modem	86
Add your device as a modem to your notebook	86
Create a modem dial-up connection	88
Dial up and connect to the Internet	90
8.7 Using RSS Hub.....	91
Subscribe to and organize news channels.....	91
View and organize headlines	92
View the news summary.....	92

Chapter 9 Bluetooth **95**

9.1 Bluetooth Modes	96
9.2 Bluetooth Partnerships	96
9.3 Connecting a Bluetooth Hands-free or Stereo Headset	97
9.4 Beaming Information Using Bluetooth.....	97
9.5 Bluetooth Explorer and Bluetooth File Sharing	98
9.6 Printing Files via Bluetooth.....	99

Chapter 10 Navigating on the Road	101
10.1 Guidelines and Preparation for Using GPS	102
10.2 Downloading Satellite Data via QuickGPS	103
Download options	103
Chapter 11 Experiencing Multimedia	105
11.1 Taking Photos and Videos	106
Capture modes	106
Camera controls	107
On-screen controls and indicators	107
Menu Panel	108
Zooming	109
The Review screen	110
Advanced Options	110
11.2 Viewing Photos and Videos Using Album	112
Select a photo or video to view	112
View an image	113
Play back video	115
Close Album	115
11.3 Using Windows Media® Player Mobile	115
About the controls	116
About the screens and menus	116
Synchronize video and audio files	116
Play media	117
Playlists	118
Troubleshooting	118
11.4 Using Audio Booster	118
11.5 Using MP3 Trimmer	119
Chapter 12 Programs on your Device	121
12.1 Programs on your Device	122
Programs in the Start Menu	122
Programs screen	122
12.2 Adding and Removing Programs	123
12.3 Adobe® Reader® LE	124
12.4 Calendar	124
Create appointments	124
View appointments	125
Send appointments	125
12.5 Contacts	126
Add new contacts	126

Organize and search contacts.....	127
Share contact information	127
12.6 Comm Manager.....	128
12.7 Microsoft® Office Mobile	128
12.8 Notes.....	129
12.9 Tasks.....	130
12.10 Voice Recorder	131
12.11 ZIP	132
Chapter 13 Managing Your Device	133
13.1 Copying and Managing Files	134
13.2 Settings on your Device	135
Personal tab.....	135
System tab	135
Connections tab.....	136
13.3 Changing Basic Settings	136
Date and time	136
Regional settings	137
Display settings	137
Device name.....	137
Ringer settings.....	137
Alarms and notifications	138
Phone services.....	138
13.4 Using Task Manager.....	139
13.5 Protecting Your Device	140
Protect your device with a password	140
13.6 Managing Memory	141
13.7 Resetting Your Device.....	141
Soft reset.....	141
Hard reset	142
Clear Storage.....	142
13.8 Windows Update.....	143
13.9 Battery Saving Tips.....	144
Appendix	145
A.1 Specifications.....	146
A.2 Regulatory Notices	147
Regulatory Agency Identifications.....	147
Federal Communication Commission Interference Statement.....	147
Industry Canada statement	148

FCC Hearing-Aid Compatibility (HAC) Regulations for Wireless Devices	148
SAR Information.....	149
IC Statement.....	150
Telecommunications & Internet Association (TIA) Safety Information	150
WEEE Notice	150
RoHS Compliance.....	151
A.3 Additional Safety Information.....	151
When Driving	151
When Using Your Device Near Other Electronic Devices.....	151
Turn Off Your Device Before Flying	152
Turn Off Your Device in Dangerous Areas.....	153
General Safety.....	153
Antenna Safety.....	153
Battery Safety.....	153
Adapter/Charger.....	154

Index

155

Chapter 1

Getting Started

1.1 Getting to Know Your Touch Phone and Accessories

1.2 Installing the Battery

1.3 Charging the battery

1.4 Using the Strap Holder

1.5 Starting Up

1.6 Navigating Your Device

1.7 Home Screen

1.8 Status Icons

1.9 Start Menu

1.10 Quick Menu

1.11 LED Alerts

1.12 Adjusting the Volume

1.13 Using your Device as a USB Drive

1.1 Getting to Know Your Touch Phone and Accessories

Top panel

POWER

Press to turn off the display temporarily. To turn off the power, press and hold for about 5 seconds. For more information, see "Starting Up" in this chapter.

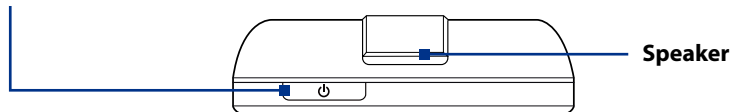

Front panel

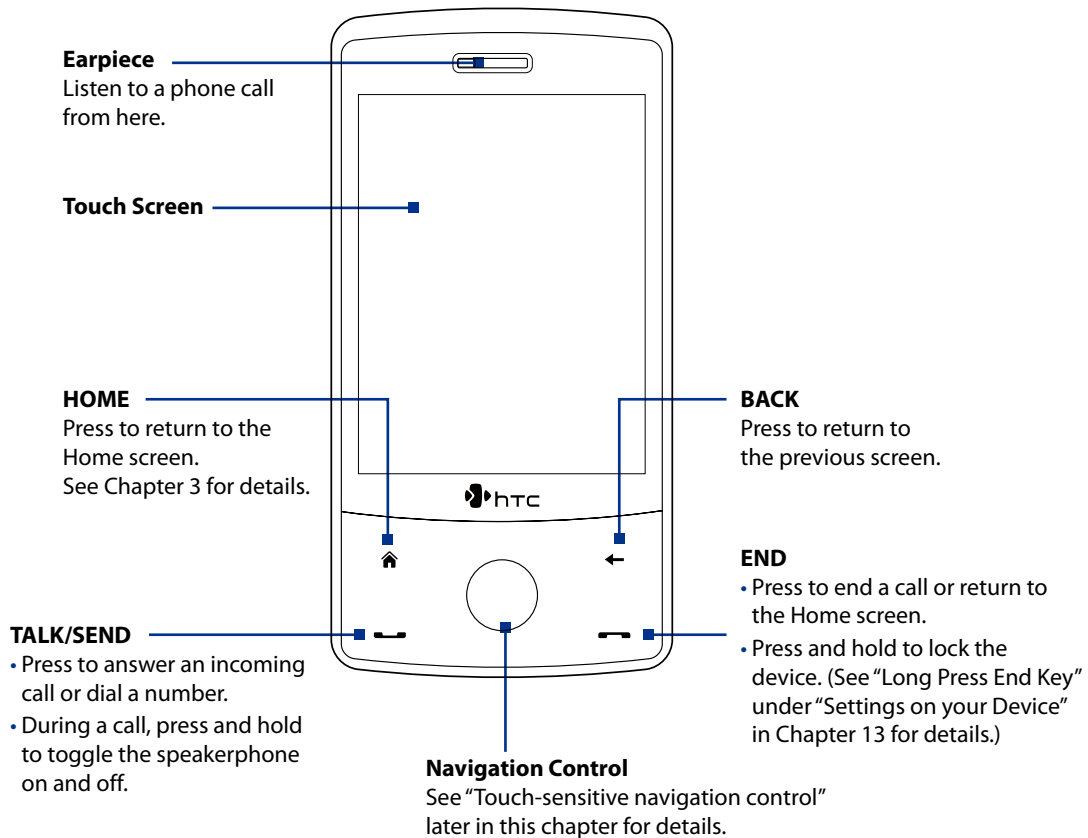

Bottom panel

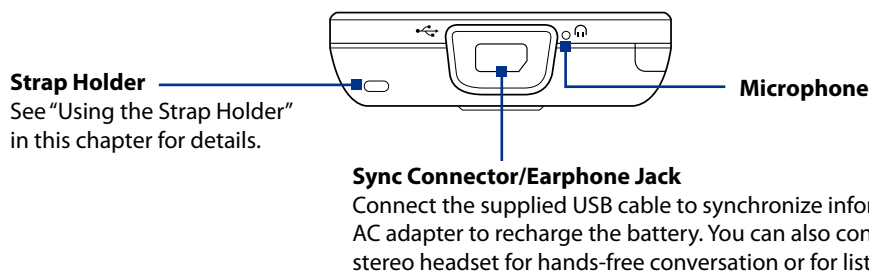

Note When using the four buttons — HOME, BACK, TALK/SEND, and END — and the Navigation Control, please observe the following precautions:

- Make sure to press on the icons of the four buttons for the best accuracy. When pressing on the Navigation Control, make sure to press the outer areas near the ENTER button for directional control.
- For best results, press with your fingertip. Do not wear gloves.

Left panel

VOLUME UP

During a call or when playing music, press this button to increase the volume.

VOLUME DOWN

During a call or when playing music, press this button to lower the volume.

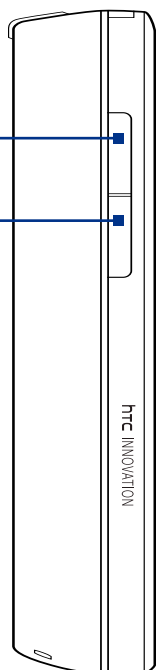

Back panel

3.2 Megapixel Camera

See "Taking Photos and Videos" in Chapter 11 for details.

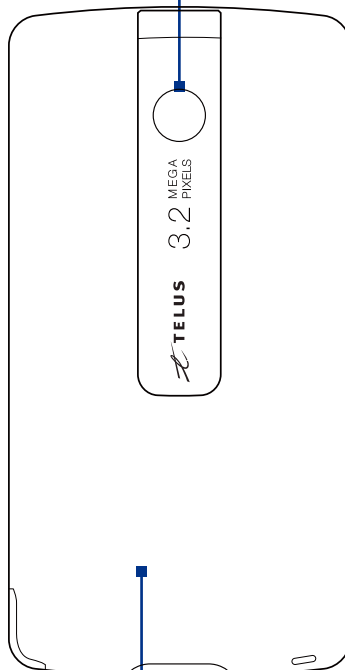

Back Cover

Push the back cover upward to remove it.

Right panel

Stylus

(See "Stylus" in this chapter for details.)

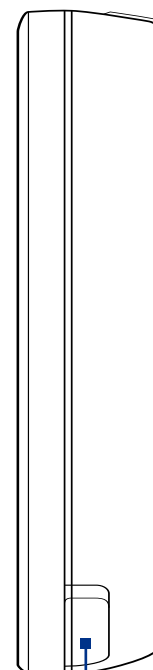

Accessories

The product package includes the following items and accessories:

- Battery
- AC adapter
- Screen protector
- Stereo headset
- USB sync and charging cable
- Multifunction audio cable
- Quick Start Guide
- Getting Started CD
- Pouch
- Extra stylus

1.2 Installing the Battery

Always turn off your device before installing or replacing the battery. You also need to remove the back cover before you can install these components.

To remove the back cover

1. Make sure your device is turned off.
2. Hold the device with both hands and the front panel facing down.
3. Push the back cover up with your thumb until it disengages from the device and then slide it up to remove.

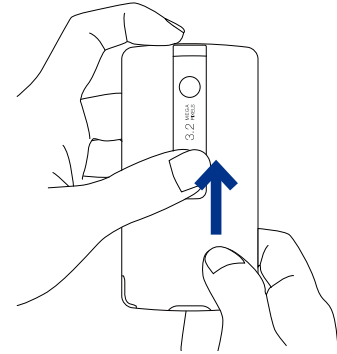

Battery

Your device comes with a rechargeable Lithium-ion or Lithium-ion polymer battery and is designed to use only manufacturer-specified original batteries and accessories. Battery performance depends on many factors, including network configuration, signal strength, the temperature of the environment in which you operate your device, the features and/or settings you select and use, items attached to connecting ports, and your voice, data, and other program usage patterns.

Battery life estimates (approximations):

- Standby time: Up to **350** hours
- Talk time: Up to **250** minutes

Note Battery life is subject to network and phone usage.

Warning!

To reduce risk of fire or burns:

- Do not attempt to open, disassemble, or service the battery pack.
- Do not crush, puncture, short external contacts, or dispose of in fire or water.
- Do not expose to temperatures above 60°C (140°F).
- Replace only with the battery pack designated for this product.
- Recycle or dispose of used battery as stipulated by local regulations.

To install the battery

1. Align the battery's exposed copper contacts with the battery connectors inside the battery compartment.
2. Insert the contact's side of the battery first and then gently push the battery into place.
3. Replace the back cover.

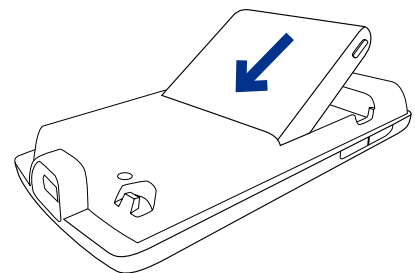

To remove the battery

1. Make sure your device is turned off.
2. Remove the back cover.
3. The top right side of the battery has a protruding grip. Lift the protruding grip to remove the battery.

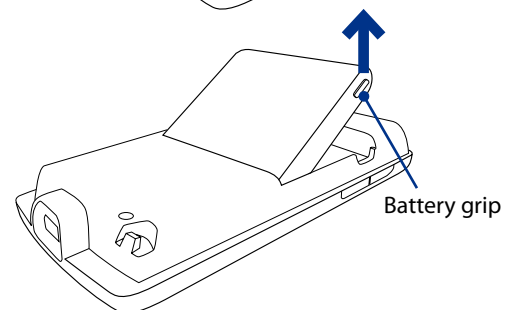

1.3 Charging the Battery



New batteries are shipped partially charged. Before you start using your device, it is recommended that you install and charge the battery. Some batteries perform best after several full charge/discharge cycles.

To charge the battery

1. Connect the USB connector of the AC adapter to the sync connector on your device.
2. Plug in the AC adapter to an electrical outlet to start charging the battery.

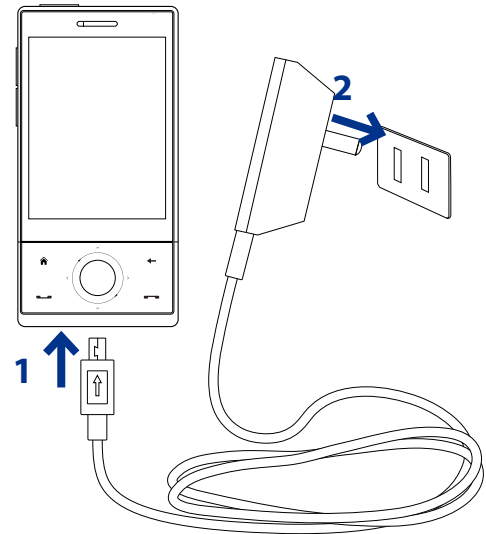
Note Only the AC adapter and USB sync cable provided with your device must be used to charge the device.



Charging is indicated by a “breathing” white light around the Navigation Control. As the battery is being charged while the power is on, a charging icon () also appears in the title bar of the Home screen. After the battery has been fully charged, the Navigation Control LED shows a solid white light and a full battery icon () appears in the title bar of the Home screen.

For more information about the Navigation Control LED, see “LED Alerts” in this chapter.

- Warning!**
- Do not remove the battery from the device while you are charging it using the AC or car adapter.
 - As a safety precaution, the battery stops charging when it overheats.

1.4 Using the Strap Holder

The strap holder at the bottom panel of your device allows you to attach a wrist strap, neck lanyard, or string accessory.

To attach a strap, lanyard or string accessory to the strap holder

1. Remove the back cover.
2. Insert the loop of the strap, lanyard or string accessory through the strap holder hole on the back cover.

Tip To pass through the strap holder easier, push the loop into the strap holder hole using a pointed object such as a needle or toothpick.

3. Use the stylus to pry the rubber cap on the small hook at the bottom of the back side of the device, then attach the loop over the small hook.
4. Slightly pull the strap, lanyard or string accessory to fix it securely in place, then replace the rubber cap.
5. Replace the back cover.

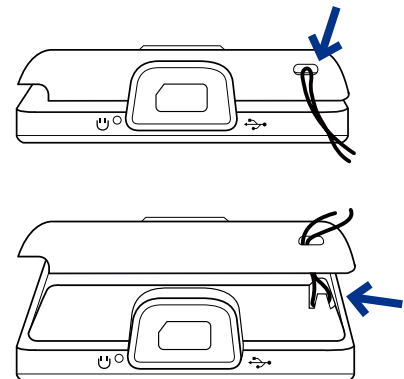

1.5 Starting Up

After installing and charging the battery, you can now power on and start using your device.

Turn your device on and off

To turn on the power

1. Press and hold the POWER button for a few seconds.
2. When you turn on your device for the first time, a Quick Start Wizard guides you to set up regional settings, date and time, and password. For more information about these settings, see Chapter 13. After the Quick Start Wizard finishes, the device installs customization settings, then restarts.

Note After the device restarts, you may be prompted to set up an e-mail account. For instructions on how to set up an e-mail account, see Chapter 6.

To turn off the power

1. Press and hold the POWER button for a few seconds.
2. Tap **Yes** when a message prompts you to choose whether or not to turn off the device completely.

Switch to Sleep mode when not in use

Press and immediately release the POWER button to turn off the display temporarily and switch your device to **Sleep mode**. Sleep mode suspends your device to a low power state while the display is off in order to save battery power.

Your device automatically goes into Sleep mode when you leave the device idle after a certain period of time. You will still be able to receive messages and calls while your device is in Sleep mode. Pressing the POWER button again or incoming calls/messages will wake up your device.

1.6 Navigating Your Device

There are different ways you can navigate and interact with the interface of your device.

Finger-touch control

A quick and easy way to interact with the home screen and the whole interface of your device is by touch. Basically, the following are the types of actions, called finger gestures, you would do when interacting with your device:

Touch or tap

When selecting items on the screen, such as the Home screen tabs, Start menu, programs and settings icons, and large on-screen buttons, simply touch them with your finger. Apply some pressure with your finger pad when touching an item on the screen.

Tapping means to touch lightly and quickly with your finger pad or fingertip. On screens that display smaller-size items, you can more accurately select an item by tapping it with your fingertip.

Swipe

To swipe means to drag your finger vertically or horizontally across the screen. The following are some instances when you would use swiping:

- **Flipping on the Home screen**

Swipe your finger vertically to flip through favorite contacts, messages, music albums, photos, and more. For more information, see "Using the TouchFLO 3D Home Screen" in Chapter 3.

- **Scrolling**

When browsing the contacts list, web pages, documents, and certain selection lists on the Home screen (such as the **All Programs** list), slowly swipe your finger vertically across the screen to scroll. This allows you to scroll by page and to view the content or available selections as you scroll.

The direction of swiping resembles the way you move a printed document as you are reading it. For detailed instructions, see "Finger scrolling" in Chapter 3.

Slide

Sliding on the touch screen also involves dragging with your finger, but you need to press and hold your finger with some pressure before you start to drag. While dragging, do not release your finger until you have reached the target position.

The following are some instances when you would use sliding:

- **Switching between Home screen tabs**

Slide your finger left and right to switch between the Home screen tabs. For more information, see “Using the TouchFLO 3D Home screen” in Chapter 3.

- **Advancing playback**

In players that have a progress bar, such as the Home screen’s **Music** tab and Windows Media® Player Mobile, slide your finger horizontally on their progress bar to advance forward or move backward in the music or video you are playing.

For more information about the Home screen’s Music tab, see “Music” in Chapter 3.

For more information about Windows Media® Player Mobile, see “Using Windows Media® Player Mobile” in Chapter 11.

Flick

Flicking the screen is similar to swiping, except that you need to swipe your finger in light, quicker strokes. This finger gesture is always in a vertical direction, such as when flicking the contacts list. See “Finger scrolling” in Chapter 3 for details.

Finger zooming and panning

In programs such as Album and Opera Mobile, you can use finger gestures when zooming and panning. See Chapter 3, 8 and 11 for details.

Stylus

You can use the stylus to navigate and interact with the touch screen. To use the stylus, pull it out from the stylus compartment at the bottom of the right panel of your device. If the backlight is off, removing the stylus automatically turns the backlight back on.

The stylus is magnetic and sticks to the side when held close to the device. This prevents you from accidentally losing or misplacing the stylus.

Basically, you tap with the stylus to open programs and select items on the screen, and you tap and hold on the screen to open a shortcut menu. You can also use the stylus the same way as what you do with finger gestures, such as swiping, sliding and flicking on the screen.

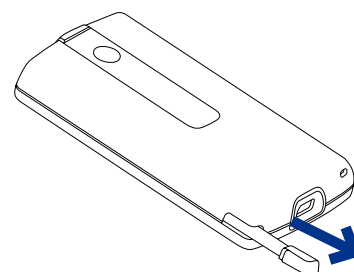

Navigation Control

On the home screen and in many programs on your device, you can use the Navigation Control for directional control. Press the directional arrows to navigate up, down, left, and right on the screen. When an item has been selected on the screen, press the ENTER button (the center button) to confirm your selection.

The Navigation Control is also touch sensitive and can be used for zooming. Slide your finger clockwise around the Navigation Control to zoom in, counterclockwise to zoom out.

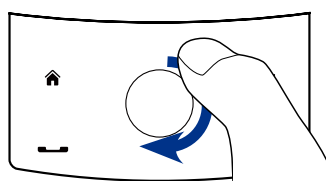

Sliding your finger clockwise

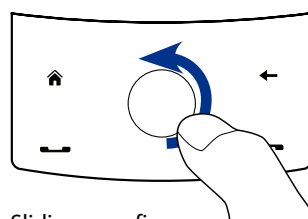

Sliding your finger counterclockwise

The following programs allow you to use the Navigation Control for zooming:

- Album
- Camera
- Opera Mobile
- Word Mobile and Excel Mobile

Tip If you purchase and install GPS navigation software on your device, you can also use the Navigation Control for zooming in the GPS software.

On the Home screen's **Music** tab, you can advance forward in the music you are playing by sliding clockwise around the Navigation Control. To move backward in the music, slide counterclockwise. See "Music" in Chapter 3 for details.

1.7 Home Screen

The default home screen of the device is the TouchFLO™ 3D Home screen which allows finger-touch access to the most important functions such as contacts, text messages, e-mail, Internet, and more.

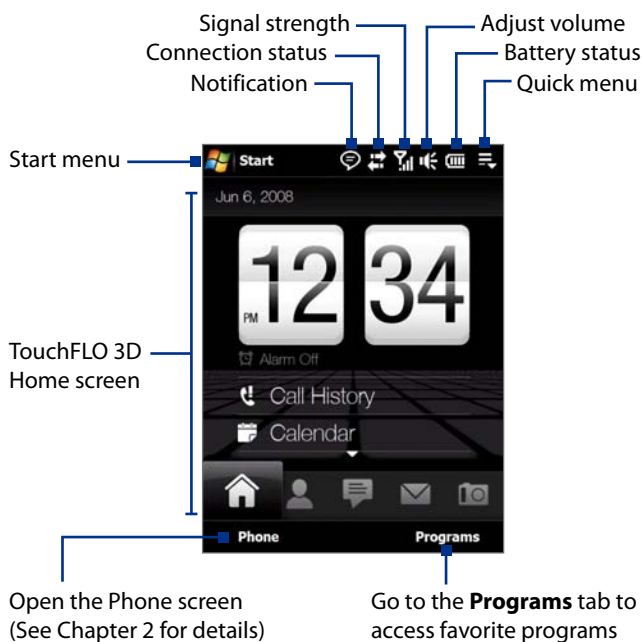

For more information about using the TouchFLO 3D Home screen, see Chapter 3.

1.8 Status Icons

When you touch or tap the icon area of the title bar, the System Status screen opens and displays larger status icons so you can touch them with your finger more easily and accurately.

Tip The System Status screen can be disabled in TouchFLO settings. See "Settings on Your Device" in Chapter 13 for details.

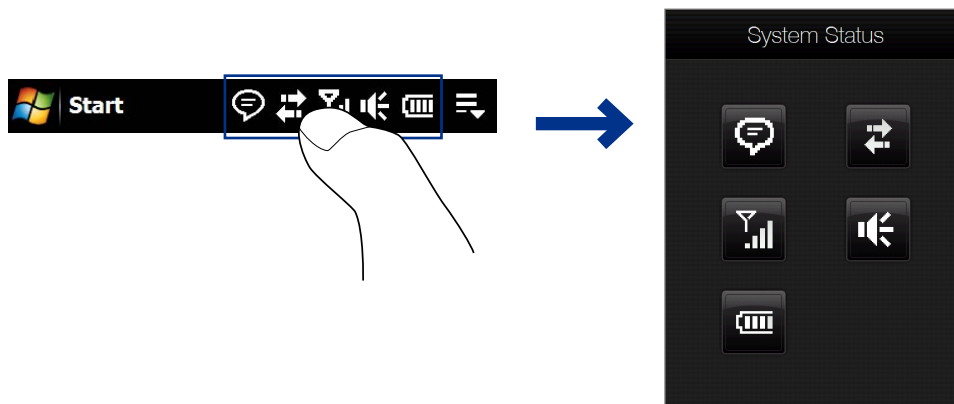

The following are some of the status icons that you may see on the device.



1

Icons that appear in this area

-  Multiple notifications; tap the icon to view all

-  New e-mail messages

-  New text messages; SMS notification of voice mail

-  New Windows Live™ message

-  Missed call

-  Speakerphone on

-  Roaming

-  Alarm

-  Other wireless network(s) detected

-  Wired headset connected

-  Bluetooth on

-  Bluetooth visible mode on

-  Bluetooth stereo headset connected

-  ActiveSync notification

-  Synchronization error

2

Icons that appear in this area

-  1xRTT available

-  EVDO available

-  Connected to a wireless network

-  Connection is active

-  Connection is not active

-  Synchronization in progress

3

Icons that appear in this area

-  Data connection is active but idle

-  Data connection is active and transmitting data

-  Maximum signal strength

-  No signal

-  Phone is turned off

-  No phone service

-  Searching for phone service

-  Voice call in progress

4

Icons that appear in this area

-  Vibrate mode

-  Sound on

-  Sound off

5

Icons that appear in this area

-  Battery charging

-  Battery full

-  Battery very low

1.9 Start Menu

The Start menu, which can be opened from the top left corner of the screen, gives you access to all the programs and settings of your Windows Mobile-powered device. Touch or tap to select an item on the Start menu.

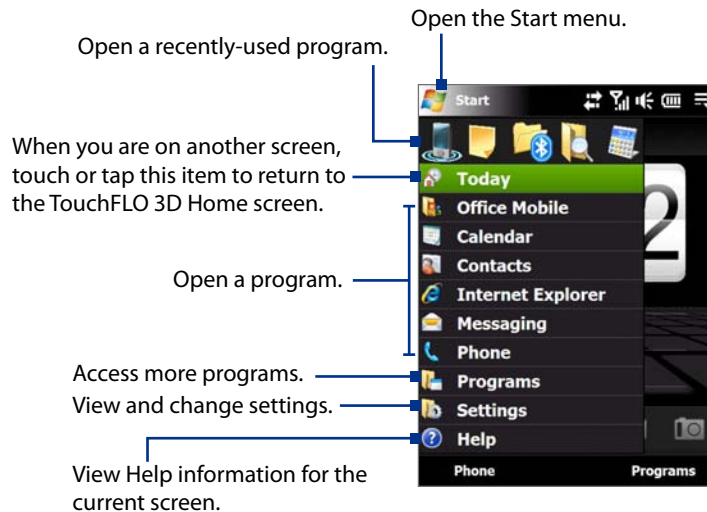

By default, the Start menu is displayed in a large size to make it easier for you to touch menu items with your finger when selecting them from the Start menu. The Start menu can also be displayed in a smaller size, if preferred. Tap **Start > Settings > System** tab > **TouchFLO** and then clear the **Enable large Start menu** check box to display a smaller Start menu.

1.10 Quick Menu

The Quick menu, which can be opened from the top right corner of the screen, shows the currently running programs. You can quickly switch between running programs, stop programs, and see how much program memory is being used.

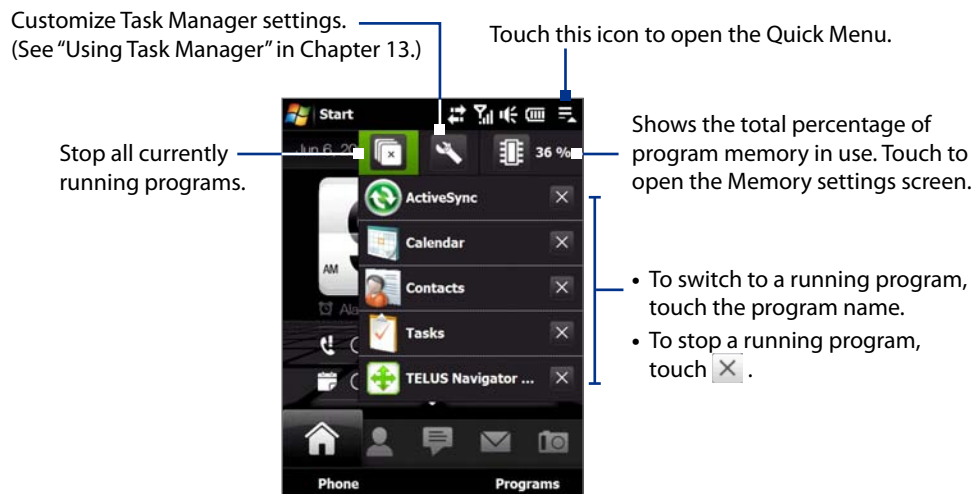

1.11 LED Alerts



The buttons below the touch screen and the exterior edge of the Navigation Control which is an LED ring will light up in the following situations:

Controls	Light Behavior
SEND button	Light flashes when there is an incoming call.
END button	Light stays solid when there is an incoming call.
Navigation Control	<ul style="list-style-type: none"> • The LED ring shows a “breathing” white light when the battery is being charged. • The LED ring shows a solid white light when the battery is fully charged. • The LED ring flashes a white light once when the battery level is low and reaches down to about 10%. • The top and bottom parts of the LED ring flashes a white light twice when there is a new e-mail, voice mail, or meeting reminder. • A white light goes around the LED ring counterclockwise twice starting from the top when there is a missed call or new SMS message.

The LED ring, HOME, BACK, SEND, and END buttons will flash a white light once when one of the buttons or Navigation Control is pressed.

1.12 Adjusting the Volume

Adjusting the system volume changes the volume level of sound notifications and audio/video playback, whereas adjusting the ring volume affects only the volume of the phone ring. The system volume and ring volume can be separately adjusted.

1. Touch the icon area in the title bar and then touch the **Speaker** icon () on the System Status screen.
2. To switch between the Ring Volume and System Volume screens, touch the **Back** and **Next** icons ( / ) on top of the screen.
3. On either screens, you can do the following:
 - To increase or decrease the volume level, drag your finger up or down the volume bars. You can also press the VOLUME UP/DOWN buttons on the left panel of your device.
 - Touch **Vibrate** to enable or disable Vibrate mode.
 - Touch **Silent** to mute both the system and ring volume.

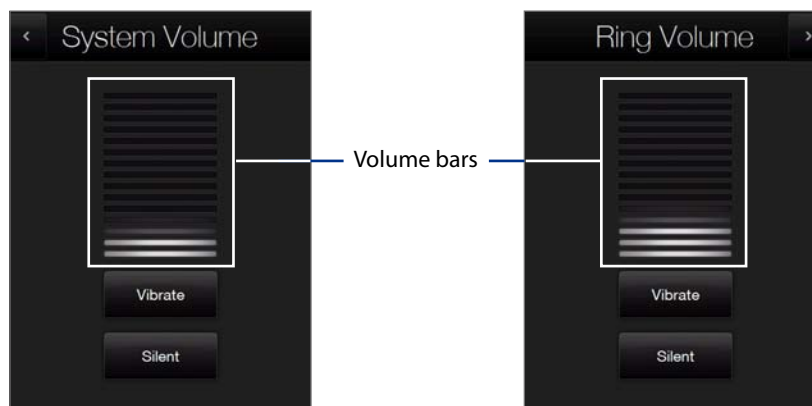

4. The System Volume or Ring Volume screen automatically closes. You can also manually close the screen by touching the screen.

Note On certain screens that do not show the volume status icon on the title bar, you need to use the VOLUME UP/DOWN buttons on the left panel of your device to adjust the volume. Also use these buttons to adjust the conversation phone volume during an ongoing call.

1.13 Using your Device as a USB Drive

To easily carry media and other files with you, you can use the internal storage of your device as a USB flash drive. Touch **Start > Settings > Connections** tab > **USB to PC** and then select **Disk Drive** mode. This allows you to copy files from your computer to the device and vice versa faster.

When **Disk Drive** mode is used:

- You will not be able to use your device to access files from the internal storage while it is connected to your PC.
- Your PC will only connect to the device's internal storage. When you access your device from the PC, you will only see the contents of the device's internal storage.

Remember to change back to **ActiveSync** mode when you need to synchronize data between your device and your PC.

Chapter 2

Using Phone Features

2.1 Using the Phone

2.2 Voice Call

2.3 Smart Dial



2.1 Using the Phone

Like a standard mobile phone, you can use your device to make, receive, and keep track of calls and send messages.

The Phone screen

To open the Phone screen, do one of the following:

- On the Home screen, tap **Phone**.
- Press the TALK/SEND button.

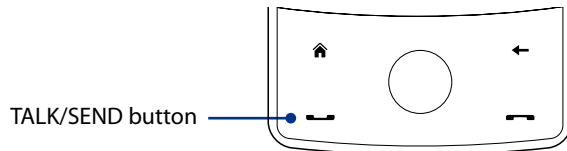



2.2 Voice Call

Make a call

To make a call from the Phone screen

1. On the Home screen, tap **Phone**.
2. Tap the keys on the keypad to enter the phone number.

Note If you tapped a wrong number, tap  to erase each subsequent digit of a number. To erase the entire number, tap and hold .
3. Press the TALK/SEND button to place the call.



Tip When in a call, use the VOLUME UP/DOWN buttons on the side of the device to adjust the phone volume.

Note After tapping 6 keys and the number you are dialing is not in your contacts, a **Save to Contacts?** button will appear above the keypad. Tap it to save the number to your Contacts.

To make a call from Contacts

On the Home screen, tap **Start > Contacts** to open the Contacts screen.

Do one of the following:

- Select the contact to call and then press TALK/SEND.

Note If the contact has more than one number stored, press Navigation right/left to select the number you want to call before pressing TALK/SEND.
- Tap the contact to open the contact details and then tap the phone number you want to call.
- Tap and hold the contact you want to call and then from the menu, select **Call Work**, **Call Home**, or **Call Mobile**.

To make a call from the TouchFLO 3D Home screen

Refer to Chapter 3 to learn how to make a call from the TouchFLO 3D Home screen.

To make an emergency call

Enter the international emergency number for your locale, and press the TALK/SEND button on your device.

To make an international call

1. Tap and hold the **number 0** key on the Phone screen until the plus (+) sign appears. The plus (+) sign replaces the international prefix of the country that you are calling.
2. Enter the full phone number you want to dial, and press the TALK/SEND button on your device. The full phone number includes the country code, area code (without the leading zero, if any), and phone number.

To call voice mail

Number 1 is generally reserved for your voice mail. Tap and hold this button on the Phone screen keypad to call voice mail and retrieve your voice mail messages.

Answer a call

When you receive a phone call, a message will appear, giving you the option to either answer or ignore the incoming call. The TALK/SEND button will also flash when you receive a call.

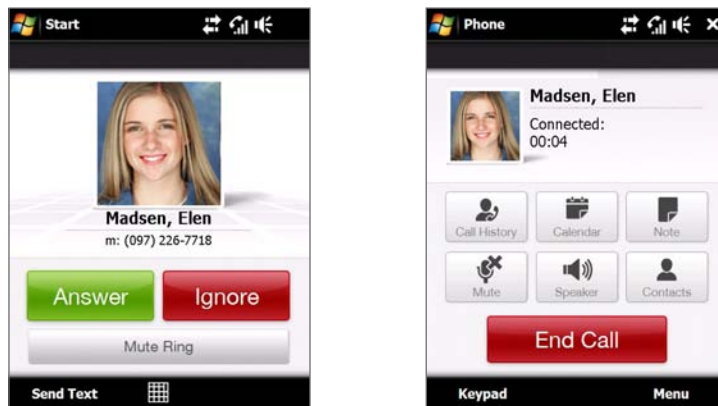

To answer or reject an incoming call

- To answer the call, tap **Answer**, or press the TALK/SEND button.
- To reject the call, tap **Ignore**, or press the END button.
- To mute the ringing sound without rejecting the call, tap **Mute Ring**.

Tip You can also place your phone face down to mute the ring without rejecting the call.

To reject a call and send a text message

When you reject a call, you can choose to automatically send a text message to the mobile phone of the caller.

1. On the Phone screen, tap **Menu > Options > Advanced** tab.
2. Select the **Reject call with text message** check box.
3. Change the default text message if needed, then tap **OK**.

When **Reject call with text message** is enabled, tap **Send Text** to reject the call and send the text message to the caller.

To put a call on hold



Your device notifies you when you have another incoming call, and gives you the option of rejecting or accepting the call. If you are already on a call and accept the new call, you can choose to switch between the two callers, or set up a conference call between all three parties.

1. Tap **Answer** to take the second call, and put the first one on hold.
2. To end the second call and return to the first call, tap **End Call** or press END on your device.

To switch between two calls

Press the TALK/SEND button.



To turn on and off the Speakerphone

During a call, tap  to toggle between turning on or off the speakerphone. The speakerphone icon  appears in the title bar when the speakerphone is on.

Tip You can also press and hold TALK/SEND to toggle between turning on or off the speakerphone.

Warning! To avoid damage to your hearing, do not hold your device against your ear when the Speakerphone is turned on.

To mute the microphone during a call

Tap  to toggle between turning on or off the microphone. When the microphone is turned off, the mute icon  appears on the screen.

To open Notes while in a call

Tap  or pull out the stylus.

To vibrate the device when the call is established

You can set the device to vibrate once to alert you that the call has been established with the other party.

1. On the Phone screen, tap **Menu > Options > Advanced** tab.
2. Select the **Vibrate device when connection is established** check box and then tap **OK**.

End a call

When a call is in progress, tap **End Call** or press the END button to hang up.

To add a new phone number to Contacts after a call



If the phone number of the person who called is not in Contacts, you can choose to save the number after you hang up.

1. On the Phone screen, tap **Menu > Options > Advanced** tab.
2. Select the **Add new phone number to Contacts at end of call** check box, then tap **OK**.

When you enable this option, a pop-up message appears after you end the phone call and lets you add the phone number to Contacts.

To check a missed call

You will see the  icon in the title bar when you missed a call. To check who the caller was, do one of the following:

- Tap the title bar, then tap  and then tap **View**.
- On the Phone screen, tap **Menu > Call History** and then tap .

Call History

Use Call History to check for missed calls, dialed numbers, and calls received. To open the Call History screen, tap **Menu > Call History** on the Phone screen.

Speed Dial

Use **Speed Dial** to call frequently-used numbers with a single tap. For example, if you assign a contact to the location **2** in Speed Dial, you can tap and hold the **number 2** key on the Phone screen keypad to dial the contact's number.

To create a Speed Dial entry

1. On the Phone screen, tap **Menu > Speed Dial**.
2. Tap **Menu > New**.
3. Tap a contact, then select the phone number of the contact that you want assigned to the speed dial key.
4. In **Location**, select an available key to use as the speed dial key.

5. Tap **OK**.

Note When you assign a new phone number in an occupied speed dial key, the new phone number will replace the existing one.

Tip To delete a Speed Dial entry, in the **Speed Dial** list, tap and hold the desired entry, then tap **Delete**.

Turn the phone function on and off

In many countries, you are required by law to turn off the phone while on board an aircraft.

To enable or disable the phone function

1. Tap **Start > Settings > Connections tab > Comm Manager**.
2. On the Comm Manager screen, tap the **Phone** button to enable or disable the phone function. When enabled, the ON indicator is activated.

To enable or disable Airplane Mode

Another way to turn off the phone function is to switch your device to **Airplane Mode**.

When you enable Airplane Mode, all wireless radios on your device are turned off, including the phone function and Bluetooth.

When you disable Airplane Mode, the phone function is turned back on and the previous state of Bluetooth is restored.

1. Tap **Start > Settings > Connections tab > Comm Manager**.
2. On the Comm Manager screen, tap the **Airplane Mode** button to enable or disable Airplane Mode. When enabled, the ON indicator is activated.

2.3 Smart Dial

Smart Dial makes it easy for you to dial a phone number.

When you start entering a phone number or contact name, Smart Dial automatically searches and sorts the contact entries in Contacts, and the phone numbers in Call History (including incoming, outgoing, and missed calls). You can then select the desired number or contact from the filtered list to dial.

Smart Dial panel

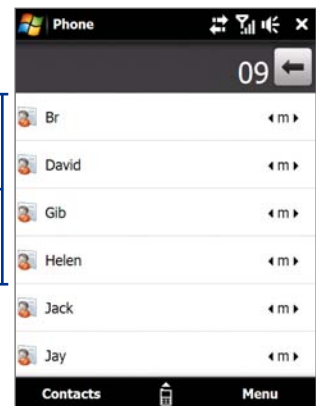

To find a contact name or number

You can just enter the first letter of the name or number of a contact. Smart Dial will search for contact phone numbers and the first character of a contact name as well as from the character that appears after a space, dash, or underscore in a contact name. For example, if you tap number "2" on the phone keypad, which is associated with [a, b, and c] on the Phone keypad, contact names such as the following will be considered matches: "Ben Miller", "George Adams", "John-Carter", "Carter, Ellen", "Dixon, Allan", "Thomas_Clark", "JaneCampbell".

If the matching list is long and you want to narrow down the search further, enter another letter. Using the same example above, if you continue to tap "3" which is associated with [d, e, f], the matching list will be narrowed down to the following names: "Ben Miller", "George Adams", "Carter, Ellen", "Dixon, Allan".

Make a call or send a text message using Smart Dial

1. On the Home screen, tap **Phone**.
2. Begin entering the first few numbers or characters. When you start entering a number or letter, the Smart Dial panel will display matches found.
Tip Tap  to close the phone keypad to see if there are more matching contacts.
3. In the Smart Dial panel, flick and slide your finger on the touch screen or press Navigation up/down to browse the list or select a contact.
4. You can do one of the following:
 - Tap the contact to call the selected contact.
 - To send a text message to the selected contact, tap **Menu > Send Text Message**.
 - To call a different phone number associated with the selected contact, select the contact and then press Navigation left/right to select the number to call.

Chapter 3

TouchFLO™ 3D

- 3.1 About TouchFLO™ 3D**
- 3.2 Using the TouchFLO 3D Home Screen**
- 3.3 Finger Gestures**



3.1 About TouchFLO™ 3D

TouchFLO™ 3D gives you touch control over your Windows Mobile-powered device. TouchFLO 3D provides the following features:

- A Home screen that allows finger-touch access to the most widely-used functions, such as People, Messages, Mail, Music, Internet, and more.
- Allows you to use finger gestures to navigate screens.

3.2 Using the TouchFLO 3D Home Screen

The TouchFLO 3D Home screen have the following tabs:



To switch between the tabs of the Home screen

Do one of the following:

- Touch or tap the desired tab on the Home screen.
- Press Navigation right or left to move to the next or previous tab.
- Press and hold your finger on the active tab, then slide your finger right or left over the tabs. Release when you have selected the desired tab.



Note Apply some pressure when pressing and holding on the active tab to be able to slide over the tabs.

- Swipe left across the screen to move to the next tab, and swipe right across the screen to move to the previous tab.

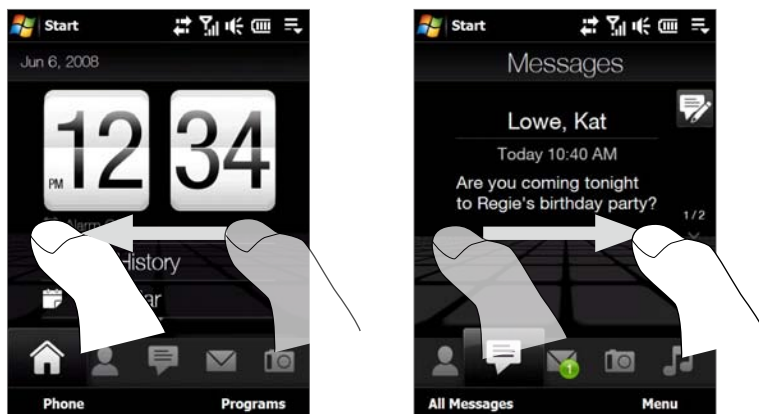

Home

The **Home** tab displays the current date, a flip-style clock, and an **Alarm** icon that indicates whether the alarm is on or off. Missed calls and your upcoming calendar appointments are also shown on the **Home** tab.

To select an item on the Home tab

- Touch the item; or
- Press Navigation up or down first to navigate to the item you want to select and then press ENTER.

Touch the date or the flip clock to open the Clock & Alarms screen where you can set the date, time, and alarm. (See Chapter 13 for details.)

Touch this area to view details about missed calls in the Call History. (See Chapter 2 for details.)

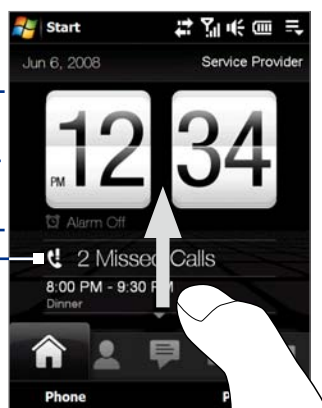

Home tab with flip clock

Swipe upward on the screen to display the smaller digital clock and view more appointments.

One all-day appointment and up to two timed appointments can be displayed. Touch this area to create, edit or view an appointment. (See "Calendar" in Chapter 12 for details.)

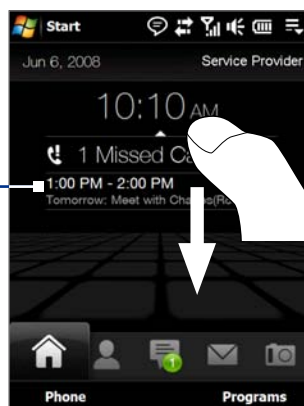

Home tab with smaller digital clock

Swipe downward on the screen to change back to the flip clock.

People

On the **People** tab, you can add favorite contacts who you most frequently communicate with. This allows you to quickly make calls, send text messages, and send e-mails to your favorite contacts.

Tip You can add up to 15 favorite contacts on the **People** tab.

To add favorite contacts

You should already have created or synchronized contacts on your device before you can add them to the **People** tab.

1. On the Home screen, slide your finger to the **People** tab.
2. Touch the small or big **Plus** icon, or touch **Add Favorite**.



3. On the Select a Contact screen, touch the name of the desired contact.

Tip To create a new contact, touch **Menu > New Contact**. See “Contacts” in Chapter 12 for details.

4. Select a phone number or e-mail address to associate to the favorite contact.

Note If there is no picture associated with the contact, the next screen prompts you to assign a picture to the contact.

5. To add another favorite contact, touch the small **Plus** icon () at the right side of the screen and repeat steps 3 and 4.

To choose from your favorite contacts

- Do any of the following:



To flip through the contact pictures one at a time, swipe your finger up or down the screen. You can also press Navigation up or down to flip through the contact pictures.



On the picture strip at the right side of the People screen:

- Touch the picture of the desired favorite contact; or
- Press and hold on the currently selected contact picture to display a slide-out bar, and then slide up or down the picture strip. Release your finger when the desired favorite contact is selected.

- After selecting a favorite contact, touch the right arrow icon (➤), the phone number or e-mail address shown below the contact picture to place a call, send a text message, or send an e-mail to the contact.
- Touch the picture of the contact on the center screen to access his or her contact card. On the contact card, you will see the last outgoing or incoming call as well as contact details such as phone numbers, e-mail address, and more.

- Tips**
- On the **People** tab, touch **All People** to access all contacts that are stored on your device.
 - To remove the current favorite contact, touch **Menu > Remove Favorite**.

Messages

On the **Messages** tab, you can read text messages as they arrive and create a new text message. When there are new incoming text messages, the icon on the **Messages** tab will show the number of new messages. For example,  indicates that there is a new message received.

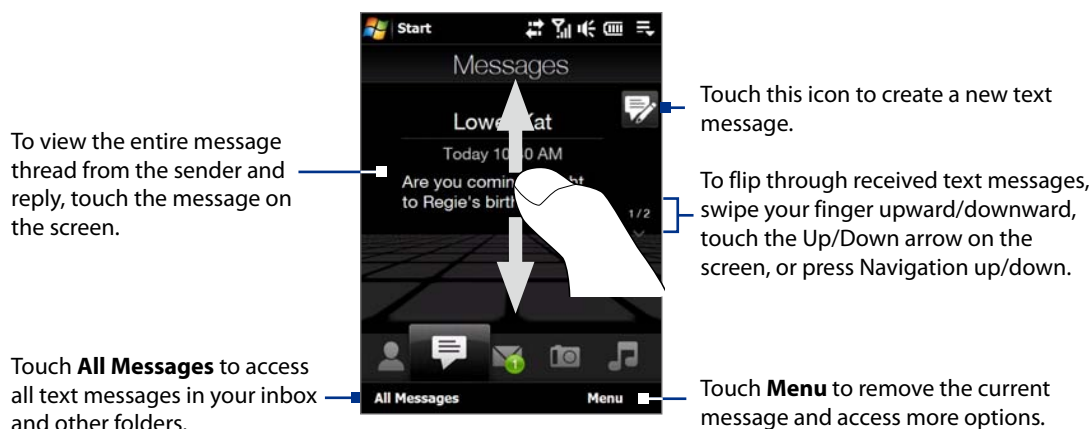

For more information about working with text messages, see “Text Messages” in Chapter 6.

Mail

The **Mail** tab is where you send and receive e-mail messages. Including Outlook E-mail, you can add up to four POP3/IMAP4 and Web-based e-mail accounts in this tab.

To add an e-mail account

1. On the Home screen, slide your finger to the **Mail** tab.
2. If this is your first time to add an e-mail account, touch **New Account** on the bottom-right side of the screen.
3. Set up your e-mail account using the E-mail Setup wizard.
4. To add another e-mail account, touch **Menu > Accounts > New Account** and use the E-mail Setup wizard to set up your account.

For detailed instructions on setting up e-mail accounts using the E-mail Setup wizard, see Chapter 6.

To check e-mail

When there are new e-mails, the icon on the **Mail** tab and the respective icons of the e-mail accounts will show the number of newly received messages.

- To browse through received e-mails, swipe up or down on the envelope image or press Navigation up/down.
- Touch the e-mail on the screen to open and read the message.

Touch **Inbox** to access all e-mail messages of the currently selected account.

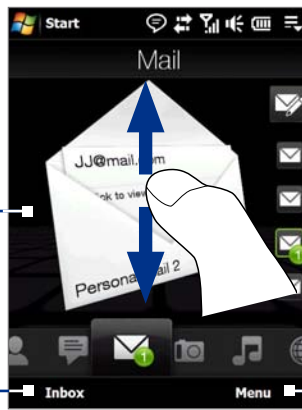

After selecting an e-mail account, touch this icon to create and send a new e-mail message.

These are your e-mail accounts. Touch an icon to select an e-mail account and view the new e-mails received in that account.

Touch **Menu** to access more options.

For more information about working with e-mails, see Chapter 6 and 7.

Photos and Videos

The **Photos and Videos** tab lets you visually flip through your photos and video clips and view them in full screen. From this tab, you can also activate the Camera so you can take pictures and record video clips.

The **Photos and Videos** tab displays pictures and video files from the current favorite album. By default, the Camera Shots album which stores the pictures and videos that you captured using the device camera is set as the favorite. You can change to another favorite album, if preferred.

To set an album as a Favorite

1. On the **Photos and Videos** tab, touch **Album** to open the Album program.
2. Touch **Albums** and then select one of the listed favorite albums.
3. Tap **Menu** > **Set as Favorite**. and then tap **OK** on the confirmation screen.

To view photos and videos

Touch the photo or video on the screen to view or play it in full screen.

Touch here to open the Album program. (See "Viewing Photos and Videos Using Album" in Chapter 11 for details.)

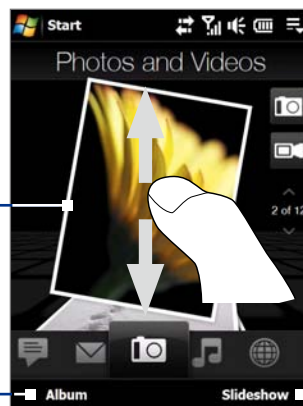

Touch here to take a photo.

Touch here to shoot video.

To flip through photos and videos, swipe upward/downward, touch the Up/Down arrow, or press Navigation up/down.

Touch **Slideshow** to view the photos as a slideshow. If a video is selected, touch **Play**.

- Tips**
- For more information about viewing in full screen, see "View an image" and "Play back video" in Chapter 11. The file formats that can be viewed on the **Photos and Videos** tab are the same as the Album program.
 - To transfer media files from a computer and view them on the **Photos and Videos** tab, copy or synchronize them to a folder under **\My Device** (the device memory) or **\Internal Storage** (the built-in storage).

Music

The **Music** tab allows you to visually browse through albums and music tracks and play music. The albums and music tracks that you see on the **Music** tab are from the **Now Playing** list of the Library.

Note Your device searches for all music files that have the following audio formats: MP3 (.mp3), WMA (.wma), AAC/AAC+ (.aac), and MPEG-4 (.m4a). It searches for music from the following locations:

Device: \My Music (including all subfolders)
 \My Documents (including all subfolders)
 Storage: \Internal Storage (including all subfolders)

To play music

On the **Music** tab, flip through albums and all the music in each album, then touch the **Play** icon on the middle-right side of the screen to start playback.

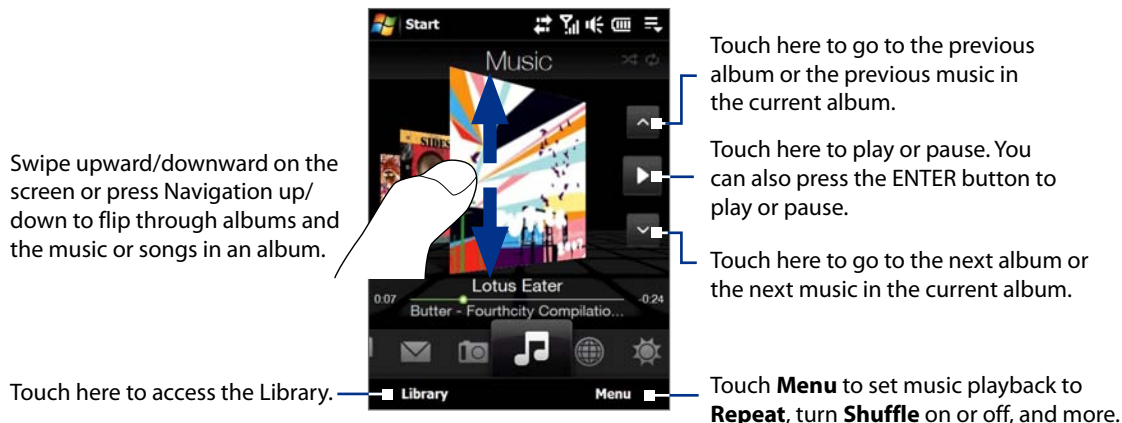

To advance forward or backward in the music

Do one of the following:

- Touch and hold on the thin bar below the album art to display the progress bar:



Drag your finger right or left on the progress bar to move forward or backward in the current music.

- Slide your finger around the Navigation Control as follows:

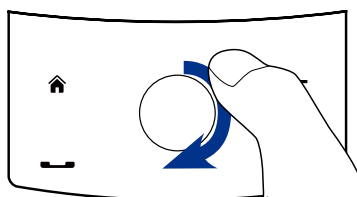

Slide your finger clockwise to advance forward in the music.

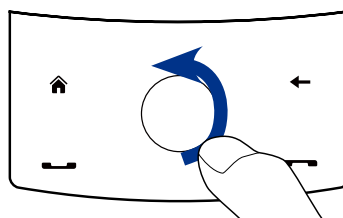

To move backward in the music, slide your finger counterclockwise.

To set repeat and shuffle modes

Touch **Menu** > **Repeat** and choose whether to repeat once, repeat all, or do not repeat. To toggle shuffle mode on and off, touch **Menu** > **Shuffle** and then select **Shuffle On** or **Shuffle Off**.

The icons on the upper-right side of the **Music** tab show whether repeat and shuffle modes are enabled.

Repeat [One] Repeat [All] Shuffle [On]

To browse and play music in the Library

The Library organizes music into categories, such as **Now Playing, Artists, Albums, Genres, All Songs**, and more. When you add more albums or music tracks to your device, go to the Library to locate and play the new albums or music tracks.

1. On the **Music** tab, touch **Library** to open the Library screen.
2. The tabs at the bottom of the Library screen correspond to the different categories. To browse music under a certain category, slide to the tab that corresponds to the desired category.
3. Tap a music track to play it.

Note When you select a category in the Library such as Artists and play its music, the Now Playing list will be replaced with the music tracks from that category.

To use playlists

You can group your favorite music into a playlist and then play back the playlist.

- To create a new playlist:
 1. Select the desired music on the **Music** tab or the **Library**.
 2. Touch **Menu > Add to Playlist**.
 3. Touch **<New Playlist>**, enter a **Playlist name** and then touch **OK**.
- To add more music files to a playlist:
 1. On the **Playlists** tab, touch a playlist to open it.
 2. Touch **Menu > Edit**.
 3. Touch **Menu > Add**.
 4. Select the check boxes of the music you want to add to the playlist, or touch **Menu > Select All** to choose all the music.
 5. Touch **OK** three times and then touch **Up** to return to the **Playlists** tab.
- To play back a playlist:
 1. On the **Playlists** tab, touch a playlist to open it.
 2. Touch the first song in the playlist. The **Music** tab starts playing the first song. After each song, the next one in the playlist will be played.

Note Playlists are not automatically updated when music files have been deleted from the device memory or internal storage.

There are two types of playlists that can be shown on the **Playlists** tab:

- **Custom playlists.** Playlists that are created on the **Music** tab.
- **Windows Media® Player playlists.** Playlists that are in Windows Media® Player Mobile's Library (which is synchronized with Windows Media® Player on your computer). They are indicated by the Windows Media® Player icon (Ⓜ). These playlists cannot be edited.

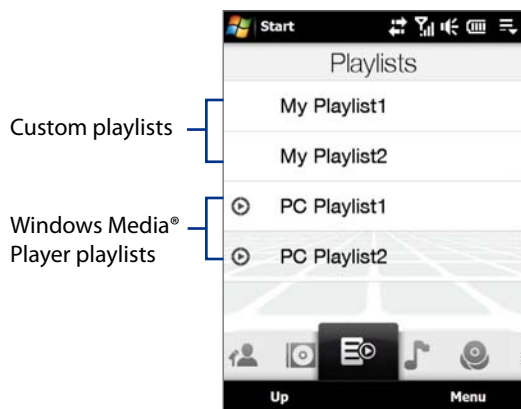

Note If a Windows Media® Player playlist contains a combination of music, video and image files, only music files in the playlist will be synchronized to your device and other media types will be filtered out.

Internet

On the **Internet** tab, you can open Opera Mobile™ to browse the Web and add Web favorites for one-touch access to your favorite Web sites.

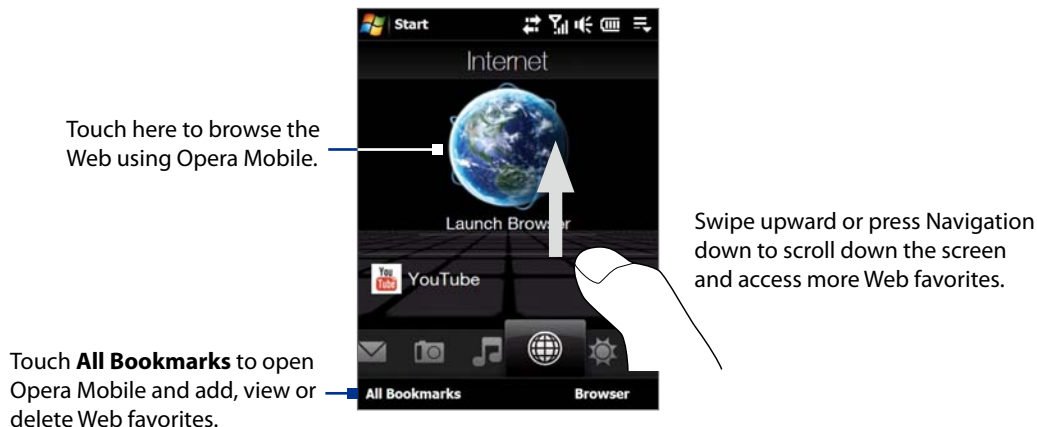

For more information about using Opera Mobile, see Chapter 8.

Weather

The **Weather** tab shows you the current weather as well as weather information for the next five days of the week.

To add a city

The **Weather** tab can display weather information of your local city and other added cities. Follow the steps below to add a city on this tab.

Tip You can add up to 10 cities in the **Weather** tab.

1. On the **Weather** tab, touch **Menu > Add Location**.
2. The Select Country screen then appears. Flick your finger on the screen repeatedly in light, quick strokes to continuously scroll down the list of countries. You can also slowly scroll through the country list by dragging your finger upward on the screen. Touch the desired country to select it.
3. The Select City screen then appears. Flick your finger on the screen repeatedly in light, quick strokes to continuously scroll down the list of cities. You can also slowly scroll through the city list by dragging your finger upward on the screen. Touch the desired city to select it.

To view weather information

Your device automatically connects to the Internet via the data connection or Wi-Fi to download and display weather information. The current temperature, temperature range, type of weather (sunny, cloudy, showers, or others), and the time of day (daytime or nighttime) are shown on the **Weather** tab. To see the weather information for the next five days of the week, touch the screen or touch **5-day** at the bottom-left side of the screen.

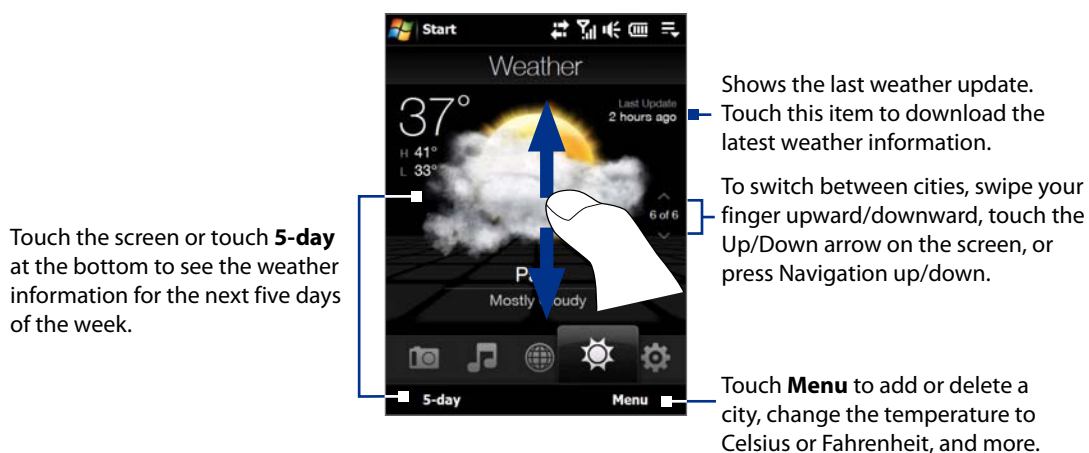

To choose download options

1. On the **Weather** tab, touch **Menu > Settings**.

Tip You can also slide to the **Settings** tab and then touch **Data**.

2. You can choose from the following options:
 - **Download weather automatically.** When this option is selected, weather information is automatically downloaded from the AccuWeather Web site whenever you select the **Weather** tab, if the data has not been updated within the last three hours. Weather data is also downloaded every time an ActiveSync connection is established (through over-the-air or USB connections). Clear this option if you prefer to manually download weather information.
 - **Download weather when roaming.** Select this option only if you want to allow automatic download of weather data when roaming. This may incur additional costs.

Settings

The **Settings** tab allows you to synchronize information with your computer or the Exchange Server, change sound settings such as the ring tone, and choose a different wallpaper for the **Home** tab. You can also easily turn on and off the communications features of your device such as Wi-Fi, Bluetooth, and more.



Programs

The **Programs** tab allows you to add your favorite programs for one-touch access.

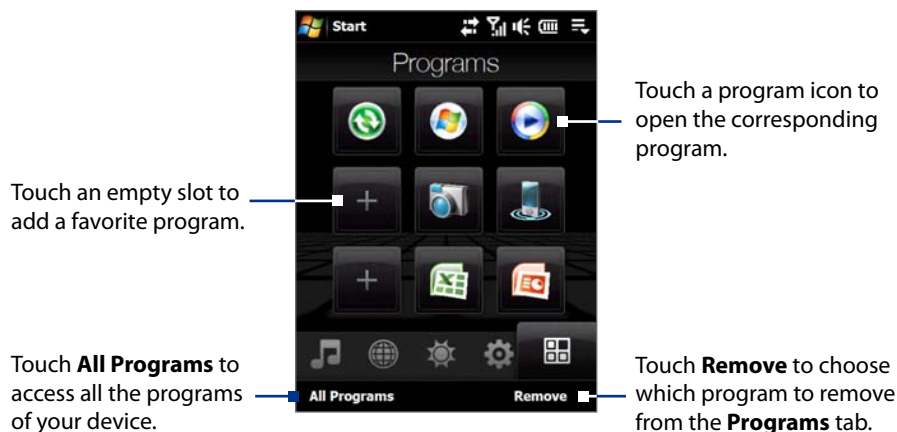

When you have filled up the screen with programs, scroll down the **Programs** tab to access more empty slots and add more programs. To scroll down, press and hold on the screen and then drag your finger upward. You can add up to 18 favorite programs.

To scroll back up, press and hold on the screen and then drag your finger downward.

Note To replace a slot with another program, you must delete the occupying program shortcut first and then add your desired program.

3.3 Finger Gestures

You can use finger gestures to scroll, zoom and pan on the touch screen.

Finger scrolling

Finger scrolling can be used to scroll up and down Web pages, documents, and lists such as the contacts list, file list, message list, calendar appointments list, and more.

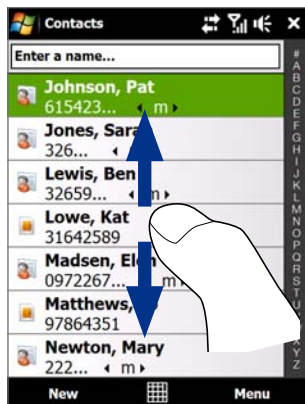

When finger scrolling, swipe or flick your finger on the touch screen.

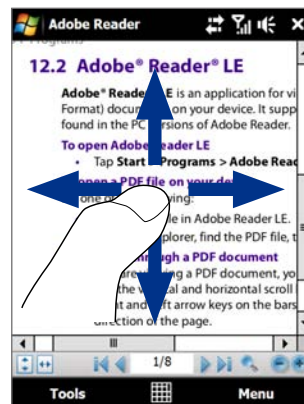

To scroll up and down

- To scroll down, swipe your finger upward on the touch screen. To scroll up, swipe your finger downward on the touch screen.
- To auto-scroll, flick your finger upward or downward on the touch screen. Touch the screen to stop scrolling.

To scroll left and right

- To scroll towards the right, swipe your finger to the left. To scroll towards the left, swipe your finger to the right.
- To auto-scroll, flick your finger left or right. Touch the screen to stop scrolling.

Finger zooming

The type of finger gesture to use when zooming varies in different programs.

- To zoom in on a Web page in Opera Mobile, tap your finger twice on the screen. See “Using Opera Mobile” in Chapter 8 for details.
- To zoom in on a photo in Album, make a full-circle swipe on the touch screen. See “Viewing Photos and Videos Using Album” in Chapter 11 for details.

Finger panning

You can use finger panning to move to and view other parts of a zoomed photo, Web page, document, or an e-mail. To pan, touch and hold on the touch screen and then drag your finger in any direction.

Tip To enable or mute finger scrolling and panning sound, touch **Start > Settings > System tab > TouchFLO**, and then select or clear the **Enable sound when finger scrolling and panning** check box.



Chapter 4

Entering Text

- 4.1 Selecting an Input Method**
- 4.2 Using the Full QWERTY**
- 4.3 Using the Compact QWERTY**
- 4.4 Using the Phone Keypad**
- 4.5 Using Multitap and T9 Modes**
- 4.6 Using Numeric and Symbol Mode**
- 4.7 Using Block Recognizer**
- 4.8 Using Letter Recognizer**
- 4.9 Using Transcriber**

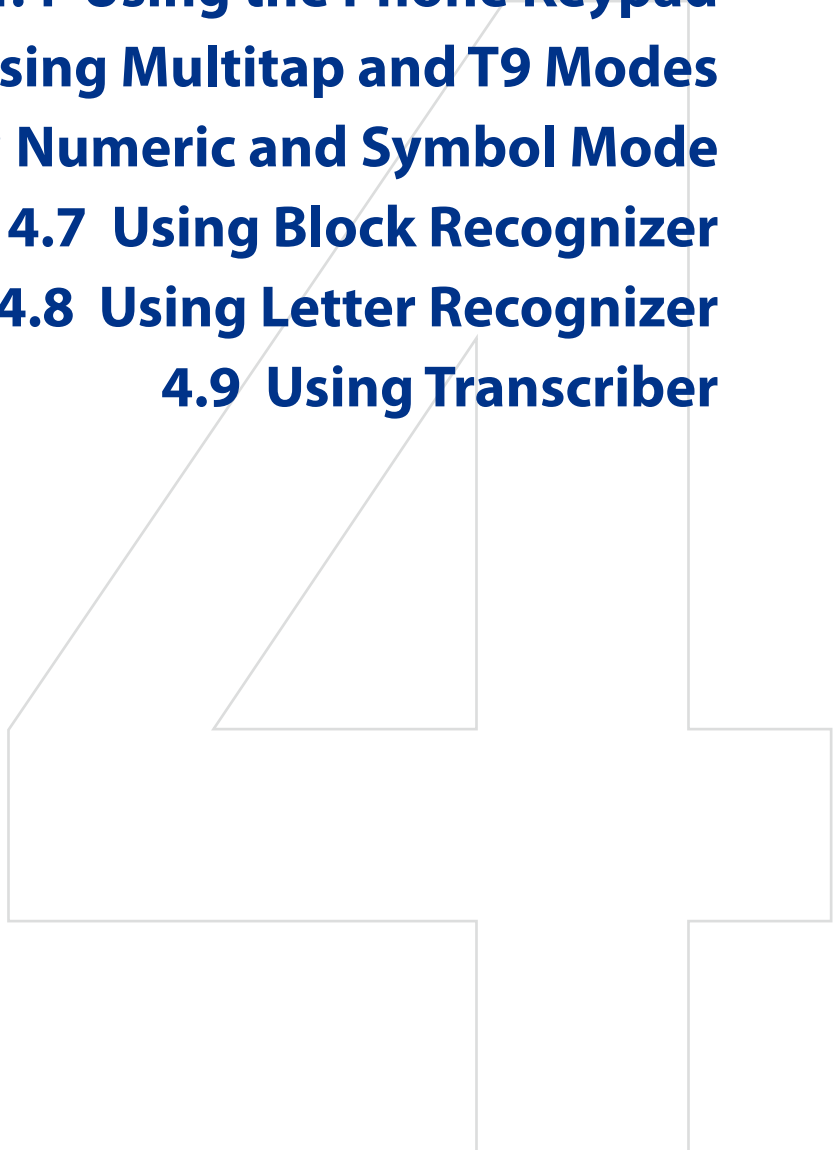

4.1 Selecting an Input Method

When you start a program or select a field that requires text or numbers, the **Input Panel** icon becomes available on the menu bar.

Tap the **Input Selector** arrow (that appears next to the **Input Panel** icon) to open a menu where you can select a text input method and customize input options. After selecting a text input method, the corresponding **Input Panel** is displayed, which you can use to enter text.

Tip Select **Other Input Methods** to display more input methods.

To show or hide the Input Panel, tap the **Input Panel** icon.

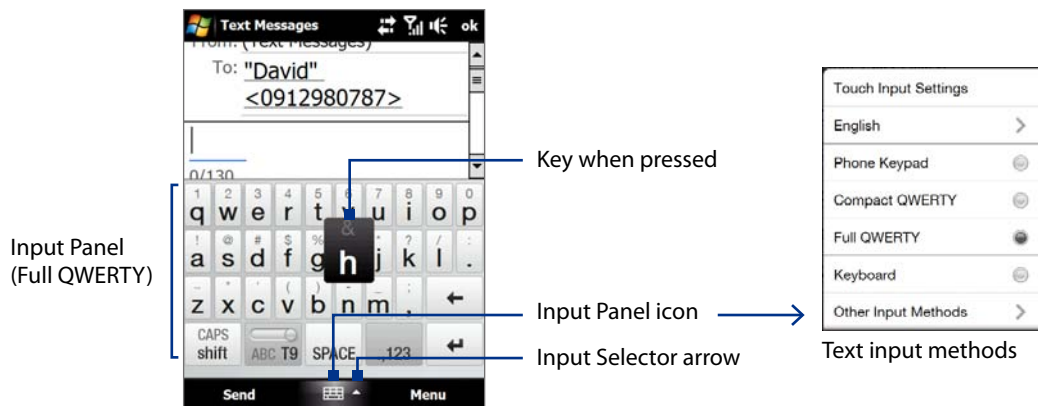

Icon	Input method	Icon	Input method
	Full QWERTY		Letter Recognizer or Block Recognizer
	Compact QWERTY		Transcriber
	Phone Keypad		Keyboard

- Notes**
- Some text input methods may not be available in certain language versions of the device.
 - When in landscape mode, the **Compact QWERTY** and **Phone Keypad** are not available.

4.2 Using the Full QWERTY

The **Full QWERTY** is a full on-screen QWERTY keyboard layout similar to a desktop PC keyboard.

Tip You can also use the Windows Mobile on-screen keyboard which also has a QWERTY keyboard layout by selecting **Keyboard** (or **Other Input Methods > Keyboard**) on the Text input method menu.

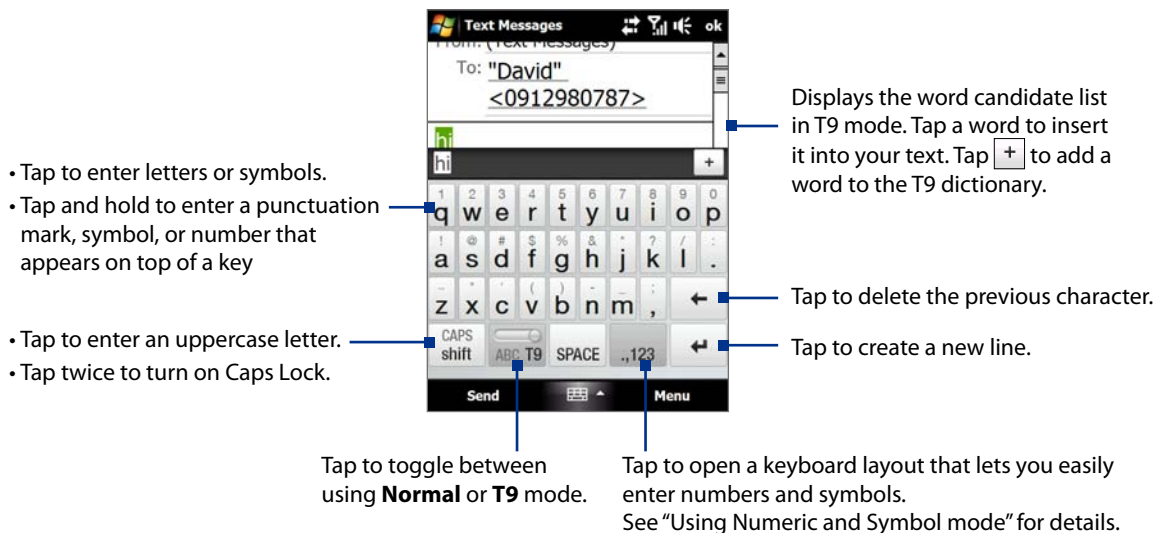

To enter text using the Full QWERTY

1. Start a program that accepts text input, such as Word Mobile.
2. Tap the **Input Selector** arrow, then tap **Full QWERTY**.
3. Start tapping keys on the keyboard as you would on a PC keyboard to enter your text. To learn how to enter text using T9 mode, see "Using Multitap and T9 modes" in this chapter.

4.3 Using the Compact QWERTY

The **Compact QWERTY** is a type of on-screen keyboard which features 20 keys. With its large, touch-friendly keys and enhanced features such as T9 predictive input, you can enter text faster and more accurately.

The image shows a screenshot of a mobile text messaging application with the Compact QWERTY keyboard displayed. The text input field contains "hi gi hu gu". The keyboard has 20 keys arranged in a grid. Callouts point to various keys and features:

- Tap to enter letters or symbols.
- Tap and hold to enter a punctuation mark, symbol, or number that appears on top of a key
- Tap to enter an uppercase letter.
- Tap twice to turn on Caps Lock.
- Displays the word candidate list in T9 mode. Tap a word to insert it into your text. Tap to add a word to the T9 dictionary.
- Tap to delete the previous character.
- Tap to create a new line.
- Tap to toggle between using **Multitap** or **T9** mode.
- Tap to open a keyboard layout that lets you easily enter numbers and symbols. See "Using Numeric and Symbol mode" for details.

Tip You can tap and hold to immediately open the numeric keyboard.

To enter text using the Compact QWERTY

1. Start a program that accepts text input, such as Word Mobile.
2. Tap the **Input Selector** arrow, then tap **Compact QWERTY**.
3. Start tapping keys on the keyboard to enter your text. To learn how to enter text using Multitap or T9 mode, see "Using Multitap and T9 modes" in this chapter.

4.4 Using the Phone Keypad

The **Phone Keypad** is a 12-key on-screen keypad that has a layout similar to mobile phone keypads, plus some additional keys. The Phone Keypad has large keys and enhanced input features such as T9 predictive input, which makes it faster for you to enter text in your messages and documents.

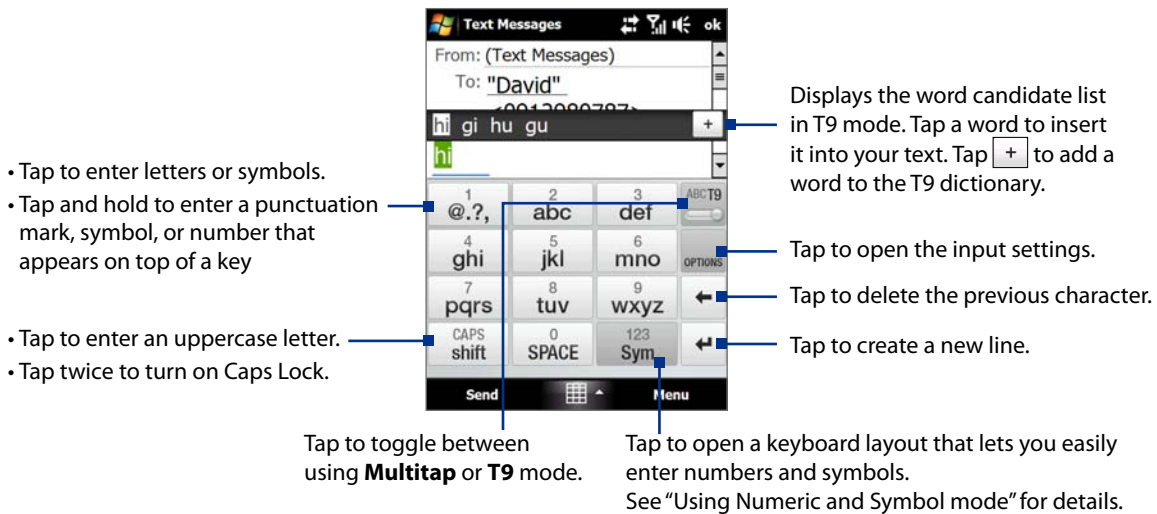

Tip You can tap and hold  to immediately open the numeric keyboard.

To enter text using the Phone Keypad

1. Start a program that accepts text input, such as Word Mobile.
2. Tap the **Input Selector** arrow, then tap **Phone Keypad**.
3. Start tapping keys on the keyboard to enter your text. To learn how to enter text using Multitap or T9 mode, see "Using Multitap and T9 modes" in this chapter.

4.5 Using Multitap and T9 Modes

When using the on-screen keyboards, you can choose to enter text using Multitap or T9 mode.

Multitap mode

In **Multitap** mode (for Compact QWERTY and Phone Keypad), enter a character by tapping a key until the desired character is displayed on the screen.

- To enter the first letter that shows on a key, tap the key once. To enter the second letter, tap twice.
- To enter a punctuation mark, symbol, or number that appears on top of a key, tap and hold the key.

T9 mode

T9 is a predictive text input mode which displays a word candidate list as you enter the first few characters so you just select the word that you want.

To enter text using T9 mode

1. Start entering the first few letters of a word. As you enter each letter, predicted words will appear above the keyboard.
2. Tap the desired word to immediately insert it to your text.

Note Navigate through the word candidate list if there are more words to choose from.

To add a word to the T9 dictionary

If the word that you have entered is not found in the dictionary, you can add it to the dictionary.

1. While in T9 mode, type a letter and then tap  on right side of the word candidate list.
2. Type the word you want to add and then tap **ADD**.



To customize Touch Input settings



1. Tap the **Input Selector** arrow, then tap **Touch Input Settings**.
2. On the Touch Input Settings screen, select or clear the following options according to your preferences:
 - **Spell Correction.** Lets you correct typographical errors by selecting from a list of possible words that reflect the characters of the keys you have tapped as well as characters of nearby keys.
 - **Word Completion in T9 mode.** Lets you select from a list of possible words based on the keys that you have tapped and on the words available in the dictionary.
 - **Word Completion in ABC mode.** Lets you select from a list of possible combinations based on the characters that appear on the keys that you tapped.
 - **Auto-Substitution.** Automatically inserts an apostrophe when you type common contracted words (for example, "dont" automatically becomes "don't").
3. Tap **Done**.

4.6 Using Numeric and Symbol Mode

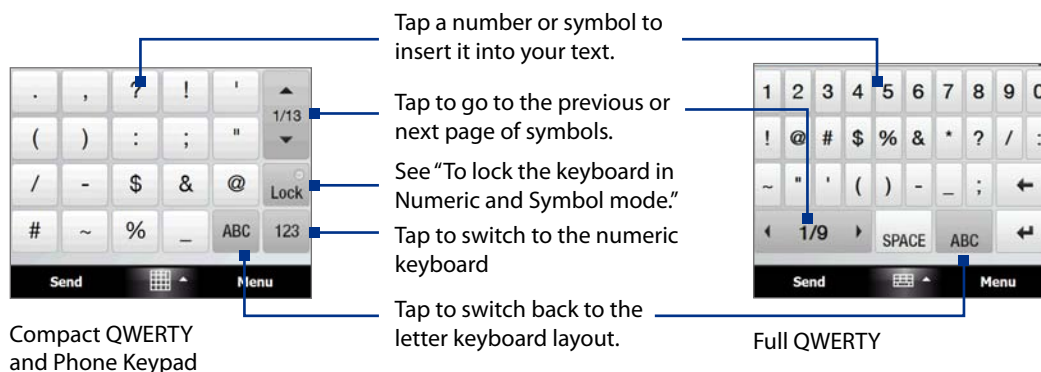
Switch to Numeric and Symbol mode to let you easily enter numbers and common symbols such as parentheses, braces, currency signs, punctuation marks, special characters, and more. Numeric and Symbol mode is available when using the **Full QWERTY**, **Compact QWERTY**, and **Phone Keypad**.



To switch to Numeric and Symbol mode

1. While using Full QWERTY, Compact QWERTY, or Phone Keypad, tap  / .
2. Locate the number or symbol, then tap it to insert it into your text.

To lock the keyboard in Numeric and Symbol mode

You can lock the keyboard in Numeric and Symbol mode so you can continuously enter symbols and numbers.

1. Tap the **Input Selector** arrow and then tap **Other Input Methods > Options**.
2. In the **Input Method** tab, select a **Touch** input method in the **Input method** list, then tap **Options**.
3. Clear the **Turn on one-touch symbol entry** check box.

Tip In Compact QWERTY and Phone Keypad, tap  /  to toggle between locking the keyboard in Numeric and Symbol mode and switching back to the letter keyboard layout after tapping a symbol or number.

4.7 Using Block Recognizer

With **Block Recognizer**, you use a single stroke to write letters, numbers, symbols, and punctuation, which are then converted into typed text.

To use Block Recognizer

1. From a program, tap the **Input Selector** arrow and then tap **Other Input Methods > Block Recognizer**.
2. Write characters, numbers, and symbols in the designated writing area.
 - Enter letters by writing in the **abc** (left) area of the box.
 - Enter numbers by writing in the **123** (right) area of the box.
 - Enter symbols and punctuation by tapping the left or right area of the box (a gray dot appears), then writing the desired character.

Tip For help with writing characters, tap the question mark near the writing area.

4.8 Using Letter Recognizer

With **Letter Recognizer**, you can write individual letters, numbers, and punctuation marks, which are then converted into typed text.

To use Letter Recognizer

1. From a program, tap the **Input Selector** arrow and then tap **Other Input Methods > Letter Recognizer**.
2. Write characters, numbers, and symbols in the designated writing area.
 - Enter uppercase letters by writing in the **ABC** (left) area of the box.
 - Enter lowercase letters by writing in the **abc** (middle) area of the box.
 - Enter numbers by writing in the **123** (right) area of the box.
 - Enter punctuation and symbols by writing the desired character in the **123** (right) area of the box.

Tip For help with writing characters, tap the question mark near the writing area.

4.9 Using Transcriber

Transcriber is a handwriting recognition program that enables you to write in cursive, print, or a combination of both.

To write using Transcriber

1. Open a program that accepts user input, such as Word Mobile.
2. Tap the **Input Selector** arrow and then tap **Other Input Methods > Transcriber**. The Transcriber introductory screen appears. Read the introduction and tap **OK**.
3. Position the cursor where you want text to appear.
4. Use the stylus to write anywhere on the screen. The handwriting will be converted to text shortly after you lift the stylus from the screen.

To enter punctuation and symbols

Transcriber comes with an on-screen keyboard that provides an easy way to add punctuation or a special symbol to existing text. To use this on-screen keyboard, tap  on the Transcriber toolbar.

The keyboard remains visible until you tap the button again.

- Tips**
- To reposition the keyboard, tap and hold the title bar, then drag to the desired location.
 - When no text is selected, you can open the keyboard by using the  gesture (draw a line straight down and then straight up). For more information about using Transcriber gestures, see Help on your device.

To edit text

1. In a program, draw a line from left to right across the text you want to edit.
2. After you lift the stylus from the screen, the line disappears and the selected text will be highlighted.
3. Do either of the following:
 - Rewrite the text.
 - Use gestures to capitalize letters, insert a space, and so on. For information about using Transcriber gestures, see Help on your device.

Chapter 5

Synchronizing Information With Your Computer

- 5.1 About Synchronization**
- 5.2 Setting Up Windows Mobile® Device Center
on Windows Vista®**
- 5.3 Setting Up ActiveSync® on Windows XP®**
- 5.4 Synchronizing With Your Computer**
- 5.5 Synchronizing via Bluetooth**
- 5.6 Synchronizing Music and Video**

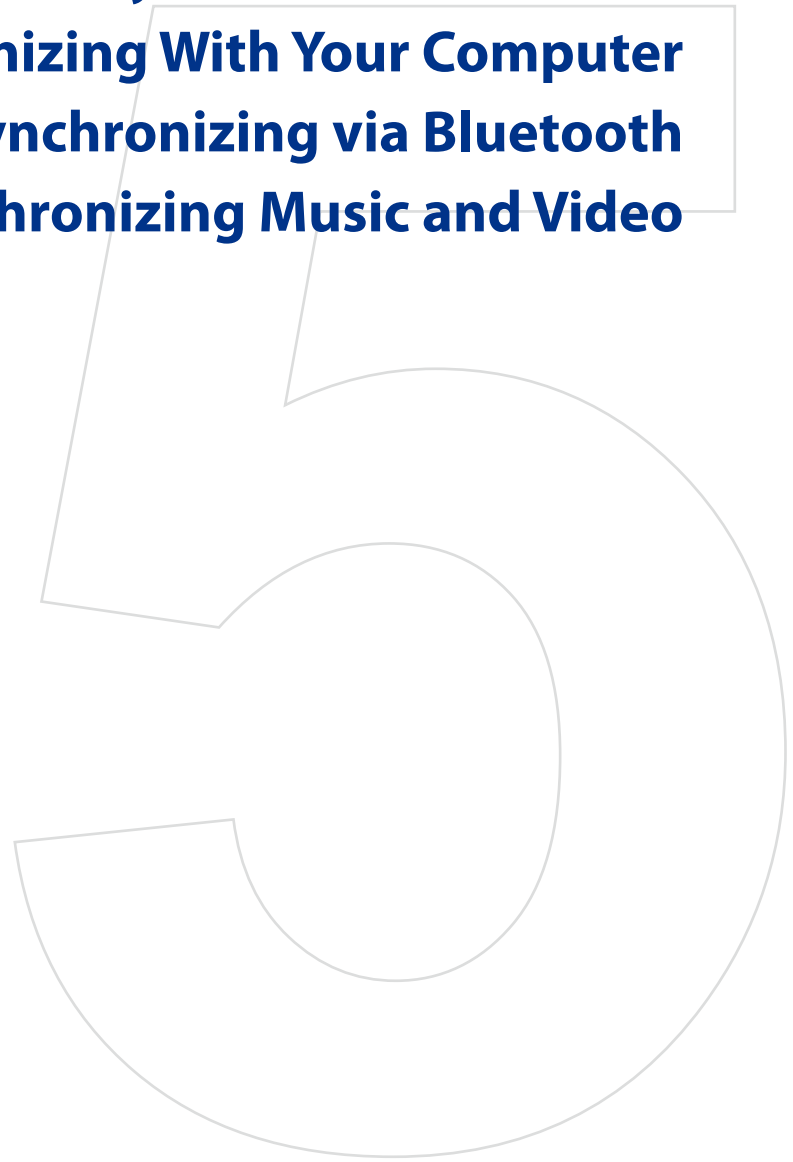

5.1 About Synchronization

You can take information from your computer wherever you go by synchronizing them to your device. The following types of information can be synchronized between your computer and your device:

- **Microsoft® Office Outlook® information**, which include Office Outlook e-mail, contacts, calendar, tasks, and notes
- **Notes**, which are created using **Microsoft® Office OneNote® 2007**
- **Media**, such as pictures, music, and video
- **Favorites**, which are the bookmarked links to your favorite Web sites
- **Files**, such as documents and other files

Before you can synchronize, you need to install and set up first the synchronization software on your computer. For more information, see “Setting Up Windows Mobile Device Center on Windows Vista®” and “Setting Up ActiveSync® on Windows XP®” in this chapter.

Ways to synchronize

After you have installed the synchronization software on your computer, connect and synchronize your device with your computer by:

- Using the supplied USB sync cable.
Upon connecting the sync cable to your device and your computer, the synchronization process automatically starts.
- Using Bluetooth.
You must first set up a Bluetooth partnership between your device and your computer before you can synchronize information between them using Bluetooth. For more information about setting up a Bluetooth partnership, see Chapter 9. For information about synchronizing through Bluetooth, see “Synchronizing via Bluetooth” later in this chapter.

Try to synchronize regularly in order to keep information up-to-date in both your device and your computer.

Note You can also synchronize Outlook e-mail, contacts, calendar, and tasks on your device with the Exchange Server at your work. For more information about setting up your device to synchronize with the Exchange Server, see Chapter 7.

5.2 Setting Up Windows Mobile® Device Center on Windows Vista®

Microsoft Windows Mobile® Device Center is the replacement for Microsoft® ActiveSync® on Windows Vista®.

Note Some versions of Windows Vista® come with Windows Mobile Device Center already installed. If Windows Mobile Device Center is not available on your Windows Vista®, you can install it from the Getting Started CD that came with your device.

Set up synchronization in Windows Mobile Device Center

When you connect your device to your computer and start Windows Mobile Device Center for the first time, you are asked to create a Windows Mobile partnership with your device. To create a partnership:

1. Connect your device to your computer. Windows Mobile Device Center configures itself, then opens.
2. On the license agreement screen, click **Accept**.
3. On the Windows Mobile Device Center's Home screen, click **Set up your device**.

Note Choose **Connect without setting up your device** if you only want to transfer media files, check for updates, and explore your device but not synchronize Outlook information.

4. Select the items you want to synchronize, then click **Next**.
5. Enter a device name, then click **Set Up**.



When you finish the setup wizard, Windows Mobile Device Center synchronizes your device automatically. Notice that Outlook e-mails and other information appear on your device after synchronization.

Use Windows Mobile Device Center

To open Windows Mobile Device Center, click **Start > All Programs > Windows Mobile Device Center** on your Windows Vista computer.



On Windows Mobile Device Center, you can do the following:

- Click **Mobile Device Settings** to change synchronization settings.
- When you click **Pictures, Music and Video > XX new pictures/video clips are available for import**, a wizard guides you to tag and transfer photos from your device to the Photo Gallery on your computer.
- Click **Pictures, Music and Video > Add media to your device from Windows Media Player** to synchronize music and video files using Windows Media® Player. For more information, see “Using Windows Media® Player Mobile” in Chapter 11.
- Click **File Management > Browse the contents of your device** to view documents and files on your device.

Note See Windows Mobile Device Center Help for more information.

5.3 Setting Up ActiveSync® on Windows XP®

The Getting Started CD that comes with your device contains Microsoft ActiveSync 4.5 or later. Follow the steps in this section to install and set up ActiveSync on Windows XP or other compatible Windows systems.

Note For a list of compatible Windows systems, go to <http://www.microsoft.com/windowsmobile/activesync/activesync45.mspix>.

Install ActiveSync

1. Place the Getting Started CD to the disc drive of your computer.
2. Click **Setup and Installation**.
3. Select the **ActiveSync** check box, then click **Install**.
4. Read the license terms, then click **Accept**.
5. When installation is completed, click **Done**.
6. On the Getting Started with Windows Mobile screen, click **Close**.

Set up synchronization in ActiveSync

1. Connect your device to your computer. The Synchronization Setup Wizard automatically starts and guides you to create a synchronization partnership. Click **Next** to proceed.
2. To synchronize your device with your computer, clear the **Synchronize directly with a server running Microsoft Exchange** check box, then click **Next**.
3. Select the information types that you want to synchronize, then click **Next**.
4. Select or clear the **Allow wireless data connections** check box according to your preference.
5. Click **Finish**.

When you finish the wizard, ActiveSync synchronizes your device automatically. Notice that Outlook e-mails and other information appear on your device after synchronization.

5.4 Synchronizing With Your Computer

Connect and synchronize your device with your computer using the USB cable or Bluetooth connection.

Start and stop synchronization



You can manually synchronize either from your device or computer.

From your device

- On the TouchFLO 3D Home screen, slide to the **Settings** tab and then touch **Sync Data**; or
- Tap **Start > Programs > ActiveSync**, then tap **Sync**. To end synchronization before it completes, tap **Stop**.



Tip To delete a partnership with one computer completely, disconnect your device from that computer first. In ActiveSync on your device, tap **Menu > Options**, tap the computer name, then tap **Delete**.

From Windows Mobile Device Center

1. Click **Start > All Programs > Windows Mobile Device Center**.
2. Click  at the lower left of the Windows Mobile Device Center. To end synchronization before it completes, click .

From ActiveSync on your computer

When you connect your device to your computer, ActiveSync automatically opens on your computer and synchronizes.

- To manually start synchronization, click .
- To end synchronization before it completes, click .

Change which information is synchronized

You can change the information types and the amount of information to synchronize for each type either on your device or your computer. Follow the steps below to change synchronization settings on your device.

Note Before changing synchronization settings on your device, disconnect it from your computer.

1. In ActiveSync on your device, tap **Menu > Options**.
2. Select the check box for any items you want to synchronize. If you cannot select a check box, you might have to clear the check box for the same information type elsewhere in the list.
3. To change synchronization settings for an information type, for instance, **E-mail**, select it and tap **Settings**.

You can then set the download size limit, specify the time period of information to download, and more.

- Notes**
- Some information types such as Favorites, Files and Media cannot be selected in ActiveSync Options on your device. You can only select or clear these items from your computer's Windows Mobile Device Center or ActiveSync.
 - A computer can have sync partnerships with many different Windows Mobile powered devices, but a device can have sync partnerships with at most two computers. To ensure that your device will synchronize properly with both computers, set up the second computer using the same synchronization settings you used on the first computer.
 - Outlook e-mail can be synchronized with only one computer.

Troubleshoot sync connection problem

In some cases, when the computer connects to the Internet or a local network, it may disconnect the connection with your device in favor of the Internet or network connection.

If this happens, tap **Start > Settings > Connections** tab > **USB to PC**, then clear the **Enable advanced network functionality** check box. This makes your computer utilize a serial USB connection with your device.

5.5 Synchronizing via Bluetooth

You can connect and synchronize your device with the computer using Bluetooth.

Note To connect and synchronize your device with a computer via Bluetooth, your computer must have a built-in Bluetooth or installed with a Bluetooth adapter or dongle.

To synchronize with a computer via Bluetooth

1. Set up Windows Mobile Device Center or ActiveSync on your computer to synchronize through Bluetooth. See the program's Help for instructions.
2. On your device, tap **Start > Programs > ActiveSync**.
3. Make sure that Bluetooth on both your device and the computer are turned on and set to visible mode. See "Bluetooth Modes" in Chapter 9 for details.

If this is the first time you have connected to this computer via Bluetooth, you must first complete the Bluetooth wizard on your device and set up a Bluetooth partnership between your device and the computer. For more information about creating a Bluetooth partnership, see "Bluetooth Partnerships" in Chapter 9.

4. Tap **Menu > Connect via Bluetooth**. Make sure the Bluetooth function of both your device and the computer are turned on and set to visible mode.

Note To conserve battery power, turn off Bluetooth when not in use.

5.6 Synchronizing Music and Video

If you want to carry your music or other digital media along with you while you travel, set up Windows Media® Player on your computer to synchronize music and video with your device.

Other than selecting the **Media** information type to be synchronized, all media synchronization settings must be set in Windows Media® Player. Before media can be synchronized, you must do the following:

- Install Windows Media® Player Version 11 on your computer. (Windows Media® Player 11 works only in Windows XP or later versions).
- Connect your device to the computer with a USB cable. If your device is currently connected using Bluetooth, you must end that connection before media can be synchronized.
- Set up a sync partnership between your device and your computer's Windows Media® Player.

For more information about using Windows Media® Player Mobile, see Chapter 11.

Chapter 6

Exchanging Messages

6.1 Messaging

6.2 Text Messages

6.3 Types of E-mail Accounts

6.4 E-mail Setup Wizard

6.5 Using E-mail



6.1 Messaging

Messaging is a central location where you will find all types of messaging accounts, which include text messages (SMS) and e-mail accounts.

To select a messaging account

Do one of the following:

- On the TouchFLO 3D Home screen, slide to the **Mail** tab and then touch **Menu > Accounts > Accounts**. The Account Picker screen then opens where you can select an account.
- Tip** You can also tap **Start > Messaging** to access the Account Picker screen.
- While you are in a message list of a certain account, for example **Text Messages**, tap **Menu > Go To** to switch to other types of messaging accounts.

To configure message account settings

- Tap **Menu > Options** on the Account Picker screen; or
- Tap **Menu > Tools > Options** while you're in a message list.

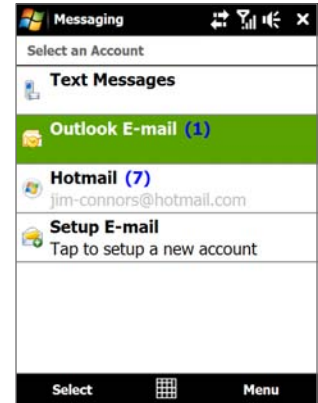

Account Picker screen

To automatically add a signature in outgoing messages

You can automatically add your name and other information as your signature in outgoing SMS and e-mail messages:

Note You need to specify your signature for each type of messaging account.

1. Tap **Start > Messaging**, then tap **Menu > Options**.
2. Tap **Signatures**.
3. Select a messaging account in which to add a signature.
4. Select the **Use signature with this account** check box.
5. In the provided text box, enter the information that will be displayed as your signature.
6. If you want the signature to be added whenever you reply or forward messages, select the **Use when replying and forwarding** check box, then tap **OK**.
7. Repeat the steps to add a signature to other messaging accounts.

6.2 Text Messages

Send short text messages (SMS) up to 160 characters long to other mobile phones.

Create a new text message

Depending on your preference, there are a number of alternative ways you can create a new text message.

From the TouchFLO 3D Home screen

1. On the Home screen, slide to the **Messages** tab.
2. Touch the **New** icon () on the upper right side of the screen.

Tip To send a text message to a favorite contact, first select the photo of the desired contact in the **People** tab to open his or her contact card and then touch **Send text message**. For more information about working with favorite contacts, see "People" in Chapter 3.

From the Account Picker screen

1. Tap **Start > Messaging > Text Messages**.
2. Tap **Menu > New**.

From the Contacts screen

1. Tap **Start > Contacts**.
2. Tap the contact's name to open his or her contact card.
3. Touch **Send text message**.

Compose and send a text message

After creating a new text message, follow the steps below to enter your message and then send it.

1. To add recipients, enter their mobile phone numbers in the **To** field, separating them with a semicolon. You can also tap **To** or tap **Menu > Add Recipient** to add mobile phone numbers from Contacts.
2. Enter your message.

Tip To choose from preset messages, tap **Menu > My Text** and tap a desired message. To check the spelling, tap **Menu > Spell Check**.

3. Tap **Send**.

- Tips**
- For more information about entering text and symbols, see Chapter 4.
 - If you want to know when a text message is received, before sending the message that you are composing, tap **Menu > Message Options**, then select the **Request message delivery notification** check box.
 - To always receive a delivery notification, tap **Menu > Tools > Options** in the text message list, tap **Text Messages**, then select the **Request delivery notifications** check box.

Manage text messages

Text messages that are sent to and received from a contact (or number) are grouped as a single thread in your inbox. Threaded SMS lets you see exchanged messages (similar to a chat program) with a contact on the screen.

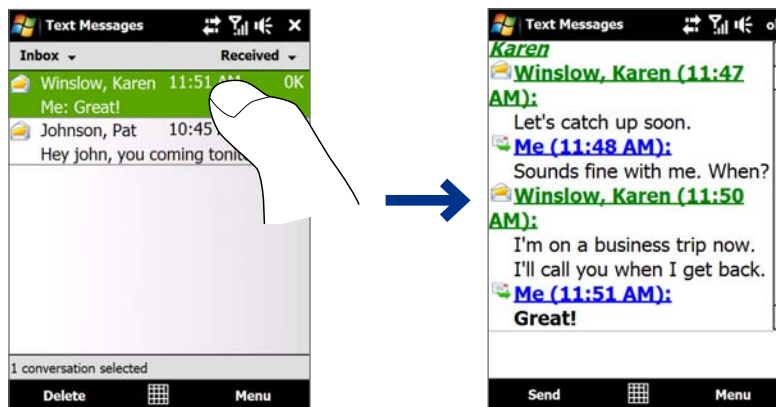

To reply to a text message

1. In the Text Messages inbox, tap a message thread to open it.
2. At the bottom of the screen, type your reply message and then tap **Send**.

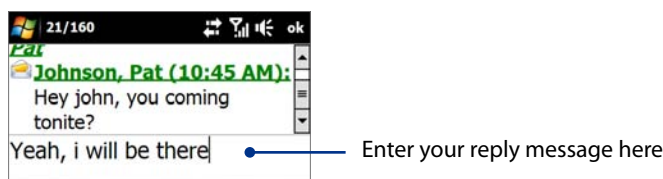

To delete a message in the thread

1. In the Text Messages inbox, tap a message thread to open it.
2. Use the Navigation Up or Down control to select a message in the thread that you want to delete.
3. Tap **Menu > Delete**.

To delete all messages in a thread

1. In the Text Messages inbox, select a message thread using the Navigation Up or Down control.
2. Tap **Delete**.

6.3 Types of E-mail Accounts

You can set up the following types of e-mail accounts on your device:

- Outlook e-mail that you sync with your computer or the Exchange Server.
- E-mail account that you have from an Internet Service Provider (ISP) or other e-mail provider.
- Web-based e-mail accounts such as Gmail®, Yahoo!® Mail Plus, AOL®, and others.
- Work account that you access using a VPN connection.

Set up your device to synchronize Outlook e-mail with the computer

If you have installed the synchronization software on your computer and created a partnership with your device, then your device is ready to send and receive Outlook e-mail.

If you have not yet installed the synchronization software nor created a partnership, do so by following the procedures in Chapter 5.

Tip To set up your company e-mail account so that you can access Outlook e-mail messages wirelessly, you must set up your device to synchronize via an over-the-air connection with your company's Exchange Server. For more information about synchronizing with your company e-mail server, see Chapter 7.

Add an e-mail account

To add a new e-mail account, you can do one of the following:

- On the TouchFLO 3D Home screen, slide to the **Mail** tab and then touch **Menu > Accounts > New Account**; or
- Tap **Start > Messaging > Setup E-mail**.

The E-mail Setup wizard then opens and lets you enter your e-mail account settings. See "E-mail Setup Wizard" in this chapter for details.

6.4 E-mail Setup Wizard

Windows Mobile's **E-mail Setup** wizard walks you through the process of setting up your e-mail account. It has an Auto Setup feature which can automatically set up your e-mail account based on the e-mail address and password that you enter, if your e-mail provider settings are preconfigured on your device. If the settings are not found on your device, Auto Setup then attempts to retrieve the settings online for which you may be charged when your device connects to the Internet and downloads them. If it cannot find the e-mail settings online, you need to enter them manually.

Note For more information about setting up your company Outlook e-mail account, see Chapter 7.

Set up an Internet e-mail account

Set up a POP3 or IMAP4 e-mail account on your device if you have an e-mail account from an Internet service provider (ISP) or other e-mail service provider, or a Web-based account such as Gmail, Yahoo! Mail Plus, or AOL. You can also add a work account that you access using a VPN server connection as a POP3/IMAP4 account.

1. Add a new e-mail account. See "Add an e-mail account" for instructions.
2. Enter your **E-mail address** and the **Password** for your e-mail account and select the **Save password** option. Tap **Next**.
3. If e-mail provider settings are found preconfigured on your device, the E-mail Setup wizard shows a successful message. Tap **Next**.

If the settings are not found on your device, select the **Try to get e-mail settings automatically from the Internet** checkbox to find and download e-mail server settings from the Internet and then tap **Next**.

4. Enter **Your name** and the **Account display name** and then tap **Next**.

Note If the E-mail Setup wizard was unsuccessful in finding and downloading settings from the Internet, select **Internet e-mail** from the **Your e-mail provider** list on the next screen. You will be asked to enter e-mail server settings. See "To specify e-mail server settings" for details.

5. In the **Automatic Send/Receive** list, choose how frequent you want e-mail messages to be automatically sent and downloaded on your device.

Note Tap **Review all download settings** to select download options, set the e-mail format as HTML or plain text, and more. For more information, see "To customize download and format settings."

6. Tap **Finish**.

To specify e-mail server settings

If Auto Setup is unsuccessful, contact your ISP or e-mail provider for the **Incoming mail server** and **Outgoing mail server** settings so you can enter them on your device.

Other options that you can select include the following:

- Select the **Outgoing server requires authentication** check box, if required by your provider.
- If the outgoing e-mail server requires a different user name and password for sending e-mail, clear the **Use the same user name and password for sending e-mail** check box. You will be prompted to enter this information.
- Tap **Advanced Server Settings**, then select the **Require SSL** check boxes if your e-mail provider uses an SSL connection for more secured e-mail. From the **Network connection** list, select the data connection that you use for connecting to the Internet.

To customize download and format settings

Before you tap **Finish** when setting up your POP3 or IMAP4 e-mail account, you can tap the **Review all download settings** link at the bottom of the screen to choose download options, message format, and other settings.

Options	Description
Automatic Send/Receive	You can select a time interval for connecting to the Internet automatically to send and receive messages.
Download messages	Set the number of days of messages that you want to be downloaded to your device.
Send/receive when I click Send	By default, messages are immediately delivered when you tap Send . If you prefer to save outgoing messages to the Outbox folder first, clear the check box. (In this case, you will need to manually send messages by tapping Menu > Send/Receive).
Use automatic send/receive schedule when roaming	This allows your device to data roam when there is a set time interval for connecting to the Internet automatically. Since this may result in higher connection costs, you may want to leave the check box cleared.
When deleting messages	Choose whether to delete messages from the mail server when you delete them on your device.
Message format	Select HTML or Plain Text.
Message download limit	Select the e-mail download size. If you have large volumes of e-mail, use a lower size or select to download headers only.

Set up a custom domain e-mail

When you are using an e-mail domain name that is hosted by a different e-mail provider (for example, your e-mail address may be Benjamin@startup.com but Email.com hosts the e-mail account and provides e-mail services), select the **Custom Domain** option in the E-mail Setup wizard to set up your e-mail account on your device.

1. Add a new e-mail account. See "Add an e-mail account" for instructions.
2. Enter your **E-mail address** and the **Password** for your e-mail account and select the **Save password** option. Tap **Next**.
3. Clear the **Try to get e-mail settings automatically from the Internet** and then tap **Next**.
4. In **Your e-mail provider**, select **Custom domain** and then tap **Next**.

5. Enter the domain of your e-mail provider and then tap **Next**.
6. The E-mail Setup wizard then tries to find the e-mail provider settings on your device or from the Internet. If the settings are found, it shows a successful message. Tap **Next**.
7. Enter **Your name** and the **Account display name** and then tap **Next**.

Note If the E-mail Setup wizard was unsuccessful in finding the settings, you will be prompted to enter e-mail server settings on the succeeding screens. See "To specify e-mail server settings" for details.
8. In the **Automatic Send/Receive** list, choose how frequent you want e-mail messages to be automatically sent and downloaded on your device.

Note Tap **Review all download settings** to select download options, set the e-mail format as HTML or plain text, and more. For more information, see "To customize download and format settings."
9. Tap **Finish**.

6.5 Using E-mail

After setting up e-mail accounts on your device, you can start sending and receiving e-mail messages.

Create a new e-mail message

Depending on your preference, there are two ways you can create a new e-mail message.

To start from an empty message

1. On the TouchFLO 3D Home screen, slide to the **Mail** tab.
2. Select the e-mail account you want to use on the right side of the screen.

Tip To choose from other e-mail accounts that are not displayed on the **Mail** tab, touch **Menu > Accounts > Accounts** and then select an e-mail account from the Account Picker screen.
3. Touch the **New Mail** icon () to create a new e-mail.

To send an e-mail to a favorite contact

1. On the TouchFLO 3D Home screen, slide to the **People** tab.
2. Swipe your finger on the screen to flip through the photos of your favorite contacts.
3. When the photo of the desired contact is displayed, touch the displayed photo and then touch **Send e-mail**.

For more information about working with favorite contacts, see "People" in Chapter 3.

Tip You can also touch **Start > Contacts**, select a contact name, and then touch **Send e-mail**.

Compose and send an e-mail

After creating a new e-mail, follow the steps below to enter your message and then send it.

1. To add recipients, enter their e-mail addresses, separating them with a semicolon. You can also tap **To** if you want to add e-mail addresses stored in Contacts.
2. Enter a subject and compose your message.

Tip To choose from preset messages, tap **Menu > My Text** and tap a desired message. To check the spelling, tap **Menu > Spell Check**.
3. Tap **Send**.

Tips

- For more information about entering text and symbols, see Chapter 4.
- To set the message priority, tap **Menu > Message Options**.
- If you are working offline, e-mail messages are moved to the Outbox folder and will be sent the next time you connect.

To add an attachment to a message

1. In the message that you are composing, tap **Menu > Insert** and tap the item you want to attach: **Picture, Voice Note, or File**.
2. Select the file or picture you want to attach, or record a voice note.

Filter the Inbox message list

When the Inbox on your device is full of messages, you can filter your Inbox to display only the messages that contain a particular sender or subject you are searching for.

To filter your Inbox

Enter the sender name or e-mail subject you want to look for. As you type characters, the message list narrows down to the sequence of characters you have entered.

For example, entering "B", then "E" narrows the list to only the e-mails that contain sender names and e-mail subjects that start with "BE."

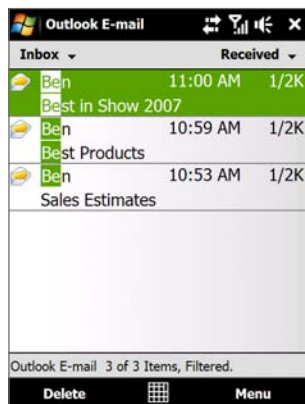

View and reply to messages

To download a complete e-mail

By default, each e-mail received in the inbox on your device contains only the first few kilobytes of the message. When you open an e-mail, it displays only the headers and part of the message. You must download the whole e-mail to view the complete content.

To download a complete e-mail message, open the e-mail and then do one of the following:

- Finger-scroll to the end of the message, and tap **Get entire message and any attachments** (POP3 e-mail account) or tap **Get the rest of this message** (IMAP4 and Outlook e-mail accounts).
- Tap **Menu > Download Message**.

Notes • The Fetch Mail feature, which is available for POP3 and IMAP4 Internet e-mail accounts, downloads an entire e-mail without the need for you to perform a full synchronization. This limits the download to just the e-mail message that you want and helps save data cost. Fetch Mail is also available for Outlook E-mail. See "Instant download through Fetch Mail" in Chapter 7 for details.

- Download may take some time, depending on the speed of your Internet connection, size of the whole e-mail, and whether file attachments are automatically downloaded.

To download file attachments

- **POP3 e-mail account:** File attachments of a POP3 Internet e-mail account are automatically downloaded when you download a complete e-mail.
- **IMAP4 and Outlook e-mail accounts:** File attachments appear below the subject of an e-mail message. Tapping an attachment opens the attachment if it has been fully downloaded or marks it for download the next time you send and receive e-mail.

You can set automatic download of file attachments. See "Customize e-mail settings" in this chapter for details.

To reply to or forward a message

1. Open the message and tap **Menu > Reply**, **Menu > Reply All**, or **Menu > Forward**.
2. Enter your response, then tap **Send**.

- Notes**
- You can receive and view HTML e-mails from any type of e-mail account. The HTML format is retained, without layout shifting or resizing. HTML e-mail support in Outlook Mobile is available only if you are synchronizing your device with Microsoft Exchange Server 2007.
 - When replying using an Outlook e-mail account, you can customize ActiveSync to exclude addresses, including your own, from being added to the recipient list. Tap **Menu > Options** in ActiveSync, select the **E-mail** item, tap **Settings**, then tap **Advanced**. In the **My e-mail addresses** text box, enter e-mail addresses you want to exclude.

Synchronize e-mails

Synchronizing e-mails ensures that new e-mails are downloaded to the device Inbox folder, e-mails in the Outbox folder are sent, and e-mails deleted from the server are removed from your device. The manner in which you synchronize e-mails depends on the type of e-mail account you have.

To automatically synchronize an Outlook e-mail account

1. Connect your device to your computer through USB or Bluetooth. Otherwise, connect through Wi-Fi or a data connection if you are synchronizing Outlook e-mail with the Exchange Server. For more information, see Chapter 7.
2. Synchronization automatically begins, and your device sends and receives Outlook e-mail.

To manually synchronize your Outlook or Internet e-mail account

1. Select your Internet e-mail account. (See “To select a messaging account” in this chapter.)
2. Tap **Menu > Send/Receive**.

Customize e-mail settings

To change the download size and format for Outlook e-mail

1. Disconnect your device from the computer.
2. Tap **Start > Programs > ActiveSync**.
3. Tap **Menu > Options**, select **E-mail**, then tap **Settings**.
4. On the E-mail Sync Options screen:
 - Under **Message format**, select HTML or Plain text.
 - Under **Download size limit**, select the desired e-mail size.
5. Close ActiveSync and reconnect your device to the computer.

To change the download size and format for Internet e-mail

1. Tap **Menu > Options** on the Account Picker screen, or tap **Menu > Tools > Options** while you're in a message list.
2. Tap your POP3 or IMAP4 Internet e-mail account.
3. Tap **Download Size Settings**.
 - Under **Message format**, select HTML or Plain text.
 - Under **Download size limit**, select the desired e-mail size.
4. Tap **Done**.

To automatically receive attachments on Outlook e-mails

1. Tap **Start > Programs > ActiveSync**.
2. Tap **Menu > Options**.
3. Tap **E-mail > Settings**, then select **Include file attachments**.

To automatically receive attachments on IMAP4 e-mails

1. Tap **Menu > Options** on the Account Picker screen, or tap **Menu > Tools > Options** while you're in a message list.
2. Tap the name of your IMAP4 e-mail account.
3. Tap **Download Size Settings**.
4. In **Download attachments**, select a download size or select **All attachments**.
5. Tap **Done**.

To store attachments on the internal storage

1. Tap **Start > Messaging**.
2. Tap **Menu > Options > Storage** tab.
3. Select the **When available, use this storage card to store attachments** check box.

Chapter 7

Working With Company E-mails and Meeting Appointments

7.1 Synchronizing with the Exchange Server

7.2 Working With Company E-mails

7.3 Managing Meeting Requests

7.4 Finding Contacts in the Company Directory



7.1 Synchronizing with the Exchange Server

To keep up-to-date with your company e-mails and meeting schedules while you're out of the office, you can connect your device to the Internet through Wi-Fi or a data connection and synchronize with your company's Exchange Server.

Set up an Exchange Server connection

Before you can synchronize or access information on the Exchange Server, you need to set up an Exchange Server connection on your device. You need to get the following information from your network administrator and enter them on your device:

- Exchange Server name (must be Outlook Web Access server name)
- Domain name
- User name and password that you use at work

If you have not synchronized your device with your computer, follow these steps to set up an Exchange Server connection.

1. Add a new e-mail account. See "Add an e-mail account" in Chapter 6 for instructions.
2. Enter the **E-mail address** and **Password** for the e-mail account and select the **Save password** option. Tap **Next**.
3. Clear the **Try to get e-mail settings automatically from the Internet** option and tap **Next**.
4. In **Your e-mail provider**, select **Exchange server** and tap **Next**.
5. Tap **Next** again.
6. Select the **Attempt to detect Exchange Server Settings automatically** option and tap **Next**.
7. Enter the **Domain** name and tap **Next**.
8. In **Server address**, enter the Exchange Server address and tap **Next**.
9. Select the items that you want to sync with the Exchange Server.

- Tips**
- To change synchronization settings of an information item, for example, **E-mail**, select the item, then tap **Settings**.
 - To change the rules for resolving synchronization conflicts, tap **Menu > Advanced**.

10. Tap **Finish**.

- Notes**
- If you synchronized e-mails with your computer before, open ActiveSync on your device, then tap **Menu > Add Server Source** to set up an Exchange Server connection. When prompted to select information types for synchronization, you must first clear the **E-mail** check box under the Windows PC item before you can select **E-mail** under Exchange Server.
 - To change Exchange Server settings, open ActiveSync on your device, then tap **Menu > Configure Server**.

Start synchronization

Before you start synchronizing with the Exchange Server, make sure your device has been set up with a Wi-Fi or data connection to the Internet so that you can synchronize over the air. For more information about connections, see Chapter 8.

After you finish setting up an Exchange Server connection, your device automatically starts synchronization.

To manually start synchronization, you can do one of the following:

- On the TouchFLO 3D Home screen, slide to the **Settings** tab and then touch **Sync Data**; or
- Tap **Start > Programs > ActiveSync** and then tap **Sync**.

Note If you connect your device to your office computer via a USB or Bluetooth connection, you can use this connection to the computer to "pass through" to the network and download Outlook e-mails and other information to your device.

7.2 Working With Company E-mails

Your device gives you instant access to your company e-mails and lets you manage your messages easier. Direct Push, Fetch Mail, Remote e-mail search, and e-mail flags are just some of the tools you can use to manage your e-mails.

Note Some messaging features depend on the Microsoft Exchange Server version used in your company. Check with your network administrator for the availability of these features.

Automatic synchronization through Direct Push

Direct Push technology (push e-mail feature) enables you to receive new e-mails on your device as soon as they arrive in your Inbox on the Exchange Server. Items such as contacts, calendar and tasks are also immediately updated onto your device when these items have been changed or new entries have been added on the Exchange Server. To make Direct Push work, you need to have a Wi-Fi or data connection on your device.

You need to perform a full synchronization between your device and the Exchange Server first before Direct Push can be enabled.

Requirement The Direct Push feature works for your device only if your company is using **Microsoft Exchange Server 2003 Service Pack 2 (SP2) with Exchange ActiveSync or higher version.**

You can turn on Direct Push in the Comm Manager or ActiveSync.

To turn on Direct Push in Comm Manager

1. To open the Comm Manager, slide to the **Settings** tab on the TouchFLO 3D Home screen and then touch **Communications**.
2. On the Comm Manager screen, touch **Microsoft Direct Push**.

To turn on Direct Push in ActiveSync

1. Tap **Start > Programs > ActiveSync** and then tap **Menu > Schedule**.
2. Select **As items arrive** in the **Peak times** and **Off-peak times** boxes.

Note When Direct Push is off, you need to manually retrieve your e-mails.

Scheduled synchronization

If you do not want to use Direct Push, you can set a regular schedule for synchronizing Outlook e-mail and information.

1. In ActiveSync on your device, tap **Menu > Schedule**.
2. Select a shorter time interval in the **Peak times** box for you to be able to receive e-mails more frequently. (Peak times usually refer to your working hours when e-mail volume is high).
3. Select a longer interval in the **Off-peak times** box.

Tip To set the days and hours that make up your peak and off-peak times, tap the **peak times** link at the bottom of the screen.

Instant download through Fetch Mail

The **Fetch Mail** feature downloads an entire e-mail immediately without the need for you to perform a full Send/Receive action. This limits the download to just the e-mail message that you want and helps save data cost.

Requirement Fetch Mail works for your device only if your company is using **Microsoft Exchange Server 2007 or higher.**

1. On the TouchFLO 3D Home screen, slide to the **Mail** tab, select your **Outlook** account, and then tap **Inbox**.
2. Open an e-mail message.
3. By default, only the first few words of the message is shown. To download the whole e-mail, finger-scroll to the end of the message, then tap **Get the rest of this message**.
4. Wait for the remainder of the message body to download.

- Notes**
- For information about changing e-mail sync options such as setting the download size for e-mail, see "Customize e-mail settings" in Chapter 6.
 - When you receive an e-mail that contains a link to a document such as a PDF or Microsoft Office document located on SharePoint or an internal file server, you can tap the link to view the document on your device. You can view the document only if you have a Microsoft Outlook account that synchronizes with Microsoft Exchange Server 2007 or later. Exchange Server must also be set up to allow access to SharePoint document libraries or internal file servers.

Search for e-mails on the Exchange Server

You can access e-mails that are not available on your device by searching your Microsoft Exchange Server mailbox. The search results are downloaded and displayed in a Search Results folder.

Requirement Your company must be using **Microsoft Exchange Server 2007 or higher**.

1. Tap **Start > Messaging > Outlook E-mail**.
2. Tap **Menu > Tools > Search Server**.
3. In the **Look for** text box, enter the search keyword.
4. Choose the date range of messages to search from.
5. In the **Look in** list, specify whether to search in the **Inbox, Sent Items, or All Folders**.
6. Tap **Search**.

Tip To clear the search results and return to the message list, tap **Menu > Clear Results**.

Flag your messages

Flags serve as a reminder for you to follow-up on important issues or requests contained in e-mail messages. Flagging messages, which has been a useful feature on desktop Outlook E-mail, can also be done in Outlook Mobile on your device. You can flag received e-mail messages on your device.

Requirement Flags are enabled only if e-mails are synchronized with **Microsoft Exchange Server 2007 or higher**. Flags are disabled or hidden if e-mails are synchronized with earlier versions of Microsoft Exchange Server.

To flag or unflag a message

1. Open Outlook on your device and access the Inbox.
2. Select a message or open a message.
3. Tap **Menu > Follow Up** and select one of the following options:

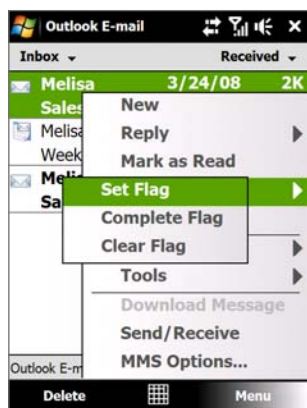

- **Set Flag** Mark the message with a red flag to indicate that it needs follow up.
- **Complete Flag** Mark the message with a check mark to indicate that the issue or request in the e-mail is already completed.
- **Clear Flag** Remove the flag to unmark the message.

Note E-mail message reminders are displayed on your device if the messages are flagged with reminders and synchronized from the Exchange Server.

Out-of-office auto-reply

Outlook Mobile allows you to retrieve and change your out-of-office status. Just like desktop Outlook E-mail, Outlook Mobile automatically sends an auto-reply message when you're not available.

To send out-of-office auto-reply messages

1. Tap **Start > Messaging > Outlook E-mail**.
2. Tap **Menu > Tools > Out of Office**.
3. In the **I am currently** list, select **Out of the Office**.
4. Enter your auto-reply message, then tap **Done**.

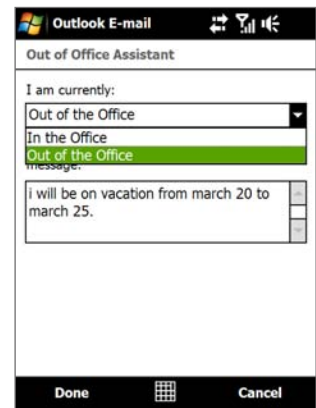

7.3 Managing Meeting Requests

When you schedule and send meeting requests from your device, you can invite attendees to your meeting and check their status to know about their availability.

When you receive a meeting request, you can reply by accepting or declining the request. The meeting request also clearly indicates whether or not there are conflicting or adjacent meetings.

Requirement Your company must be using **Microsoft Exchange Server 2007 or higher**.

To reply to a meeting request

1. When you receive a meeting request e-mail, a notification will be displayed on your device. Open the e-mail.
2. Tap **Accept** to reply and accept the meeting request, or tap **Menu > Decline** if you cannot attend the meeting.
 - Tips**
 - Before responding, you can check your availability during the time of the requested meeting by tapping **View your calendar**.
 - If the time of the meeting conflicts with your other appointments, a "Scheduling Conflict" status appears on top of the e-mail.
3. Choose whether or not to edit your response e-mail before sending, then tap **OK**.

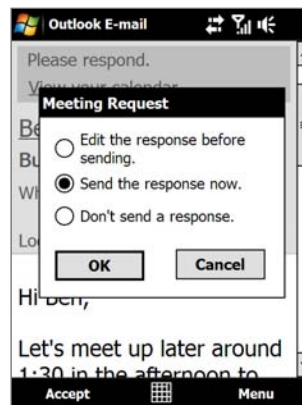
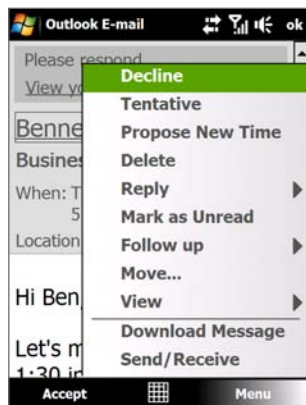

If you accepted the meeting request, it will automatically be added as an appointment in Calendar on your device.

To view the list of meeting participants

1. Tap **Start > Calendar**.
2. Tap a meeting request that you sent and then tap **Attendees**. The required and optional attendees will be listed.

Icons indicating whether each attendee has accepted or declined the meeting request will also be displayed.

Note To see the icon indicators in the attendees list, make sure Calendar is synchronized with the Exchange Server.

- Tips**
- For information about creating a meeting request, see “To send a meeting request” in Chapter 12.
 - To view an attendee’s contact information, tap the attendee’s name. If the attendee is included in your contacts list, you will see the contact information immediately. If the attendee is not in your contacts list, tap **Company Directory** to view the contact information.

7.4 Finding Contacts in the Company Directory

In addition to having contacts on your device, you can access contact information from your organization’s Company Directory. By having over-the-air access to the Company Directory, you can easily send e-mail messages and meeting requests to anyone in your company.

Requirement Access to the Company Directory is available only if your organization is running **Microsoft Exchange Server 2003 SP2 or higher**, and you have completed your first synchronization with the Exchange Server.

1. Synchronize with the Exchange Server.
2. Do any of the following:
 - In Contacts, tap **Menu > Company Directory**.
 - In a new e-mail message, tap the To box (or tap **Menu > Add Recipient**), then tap **Company Directory** on the top of the list.

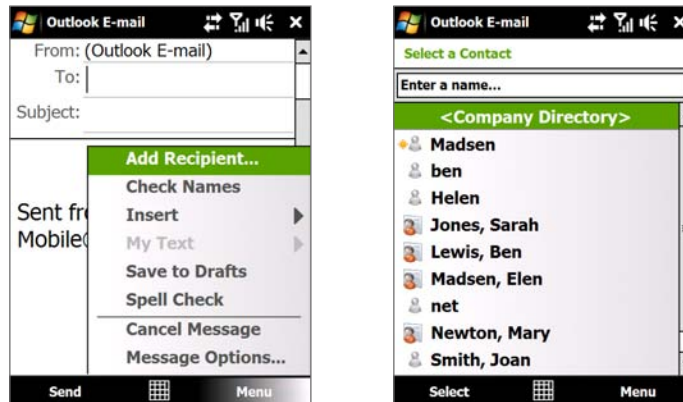

- When creating a meeting request and selecting required and optional attendees in Calendar, tap **Company Directory**.
2. Enter a partial or full contact name and tap **Search**. In the search results list, tap a contact to select it.

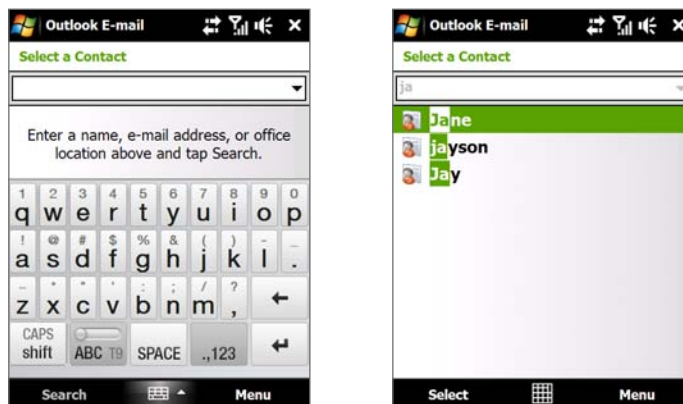

- Note**
- You can save a contact from the Company Directory to your device by selecting the contact, then tapping **Menu > Save to Contacts**.
 - You can search on the following information as long as that information is included in the Company Directory: First name, Last name, E-mail name, Display name, E-mail address, or Office location.

Chapter 8

Internet

8.1 Ways of Connecting to the Internet

8.2 Starting a Data Connection

8.3 Using Opera Mobile™

8.4 Using YouTube™

8.5 Using Windows Live™

**8.6 Using Your Device As a Modem
(Wireless Modem)**

8.7 Using RSS Hub

8.1 Ways of Connecting to the Internet

Your device's networking capabilities allow you to access the Internet or your corporate network at work through one of the following connections:

- Wi-Fi
- Dial-up

Note You can also add and set up the following connections:

- **VPN:** A VPN connection is used to access your corporate network by using an existing Internet connection.
- **Proxy:** A Proxy connection is used to access the Internet using an existing connection to your corporate or WAP network.

Wi-Fi

Wi-Fi provides wireless Internet access over distances of up to 300 feet (100 meters).

To use Wi-Fi on your device, you need access to a wireless access point or "hotspot".

Note The availability and range of your device's Wi-Fi signal depends on the number, infrastructure, and other objects through which the signal passes:

To turn Wi-Fi on and off

1. On the Home screen, slide to the **Settings** tab.
2. On the Settings screen, tap **Communications** > **Wi-Fi** to enable/disable the wireless function.

When enabled, the **On** indicator is activated and available wireless networks will be detected.

To connect to a wireless network

After Wi-Fi is turned on, your device scans for available wireless networks in your area.

1. The network names of the detected wireless networks are displayed on a pop-up message window. Tap the desired wireless network, then tap **OK**.

Note When you select an open (unsecured) network, you will be automatically connected to the network after tapping **OK**. You do not need to do steps 2 and 3.

2. On the next pop-up message window, do one of the following:
 - Tap **The Internet** if the wireless network connects your device to the Internet.
 - Tap **Work** if the wireless network connects your device to a private network.
3. Enter the key and then tap **Connect**.

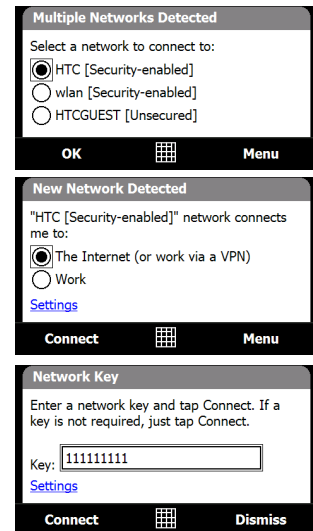



Next time you use your device to detect wireless networks, you will not see the pop-up message windows again, and you will not be prompted to enter the network key of the previously accessed wireless network (unless you perform a hard reset which will erase custom settings on your device).

Note Wi-Fi networks are self-discoverable, which means no additional steps are required for your device to connect to a Wi-Fi network. It may be necessary to provide a username and password for certain closed wireless networks.

To check wireless network status

You can check the current wireless connection status from any of the following screens of your device:

- **Title bar.** When you enable Wi-Fi on your device, the Wi-Fi ON icon  appears on the title bar. After Wi-Fi is turned on, your device scans for available wireless networks and the wireless signal icon  appears on the title bar. The arrows in this icon move back and forth while your device is scanning for a wireless network signal. Once your device successfully connects to a wireless network, the arrows stop moving.
- **Wireless LAN screen.** On the Home screen, slide to the **Settings** tab and then tap **Menu > Wireless Networks**. On the **Main** tab, you will see the wireless network that your device is currently connected to. The configuration and signal quality of the wireless network are also shown.

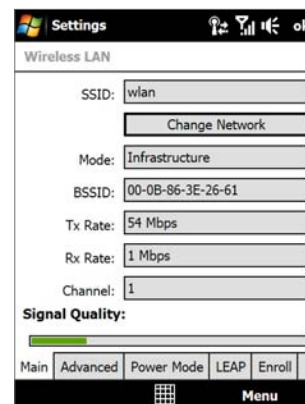

- **Configure Wireless Networks screen.** On the Home screen, slide to the **Settings** tab and then tap **All Settings**. In the **Connections** tab, tap **Wi-Fi**. This screen displays the wireless networks currently available. To connect to a wireless network in the list, tap and hold on the desired network, then tap **Connect**. Tap a wireless network in the list to view or change its connection settings. You can also add new wireless networks, if available, by tapping **Add New**.



To save battery power while connected to a wireless network

Using Wi-Fi quickly consumes battery power. Turn off Wi-Fi when not in use. You can also enable power saving settings.

1. On the Home screen, slide to the **Settings** tab.
2. On the Settings screen, tap **Menu > Wireless Networks > Power Mode** tab.
3. On the **Power Mode** tab, move the **Power Save Mode** slider to a position that optimizes performance with the least power consumption.

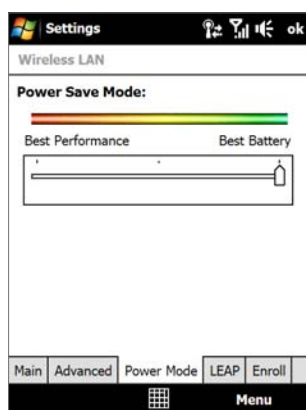

For example, move the slider to the left (Best Performance) to have the optimal wireless network performance; move to the right (Best Battery) to obtain the maximum battery usage.

Dial-up

Your device's networking capability allows you to access the Internet through the dial-up connection. Settings for connecting to your service provider's 1xRTT/EVDO network are already preconfigured on your device, and your device is ready to connect to the Internet. Please do not change these settings as this may cause your data connection to stop working.

If you need to use another dial-up connection from an ISP (Internet Service Provider), you can manually add it to your device. To establish a dial-up connection on your device, you need the same settings that you normally use when you dial up from your computer. This includes the ISP server phone number, your user name and password.

1. On the Home screen, slide to the **Settings** tab and then tap **All Settings**.
2. On the **Connections** tab, tap **Connections**.
3. Under **TELUS**, tap **Add a new modem connection**.
4. On the Make New Connection screen, enter a name for the connection and select **Cellular Line** in the **Select a modem** list, then tap **Next**.
5. Enter the ISP server phone number, then tap **Next**.
6. Enter your user name, password, and any other information required by your ISP, then tap **Finish**.

8.2 Starting a Data Connection

After setting up a data connection on your device, you can now connect your device to the Internet. The connection is started automatically when you begin using a program that accesses the Internet such as Opera Mobile.

To manually start a data connection

If you have set up multiple types of data connections on your device, you can manually start a connection.

1. On the Home screen, slide to the **Settings** tab and then tap **All Settings**.
2. On the **Connections** tab, tap **Connections**.
3. Tap **Manage existing connections**.
4. Tap and hold the name of the desired connection, then tap **Connect**.

To disconnect active data connections

1. Tap **Start > Settings > Connections** tab > **Comm Manager**.
2. Tap the **Data Connection** button.

Note You cannot reconnect a data connection in Comm Manager.

8.3 Using Opera Mobile™

Opera Mobile™ is a full-featured Internet browser, optimized for use on your device.

Note You can also use Internet Explorer® Mobile to browse the Web. To open Internet Explorer Mobile, tap **Start > Internet Explorer**.

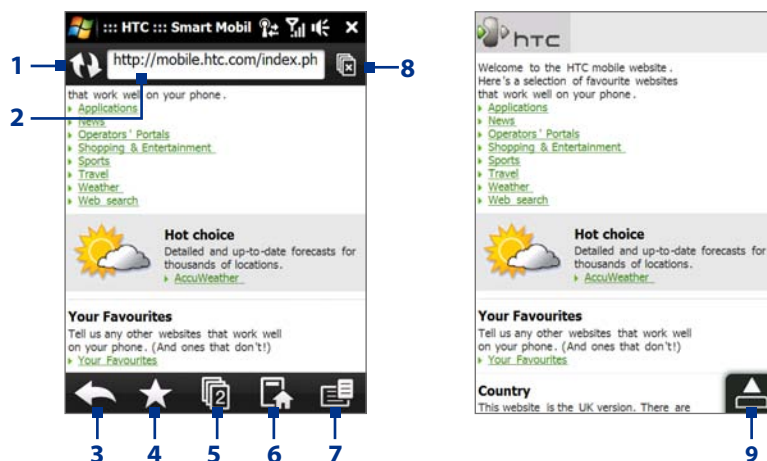

- 1 **Refresh.** Tap to reload the Web page being viewed.
- 2 **Address bar.** Enter the URL of the Web site here.
- 3 **Back.** Tap to go back to the previous Web page viewed.
- 4 **Favorites.** Tap to go to the Favorites screen where you can add a favorite, edit favorite Web pages, and send the favorite URL link via one of the Messaging accounts.
- 5 **Tabs.** Tap to add a new browsing tab or switch to another existing browsing tab.
- 6 **Home.** Tap to go to the Home page.
- 7 **Menu.** Tap to open a list where you can change Opera Mobile settings, check downloads, view History, and more.
- 8 **Close tab.** Tap to close the current tab. This is only enabled if you have more than one tab opened.
- 9 **Exit Full Screen mode.** When browsing the Web, Opera Mobile automatically switches to Full screen mode. Tap to show the address and Menu bars again.

To open Opera Mobile

On the Home screen, slide to the **Internet** tab and then tap **Browser**.

To go to a Web site

1. On the Opera Mobile screen, tap the address bar.
2. Enter the URL address and tap .

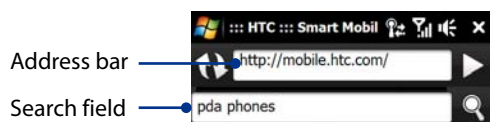

Tip When you tap the address bar, a search field also appears. Quickly search the Web by entering the search item and tapping .

View Web pages

While browsing Web pages, use finger gestures to pan and zoom on the Web page. To zoom in, tap your finger twice on the screen. To zoom out, tap your finger twice on the screen again.

Tip Touch and hold an empty area on a Web page to open a shortcut menu that lets you go back to the previous page, reload the page, add the page as a Favorite, and more. You can also tap and hold a link or image on a Web page to open a menu with different options.

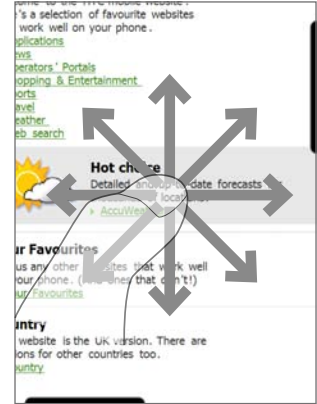

To change the screen orientation

Change the screen orientation by simply turning your device sideways.



Opera Mobile menu

On the menu bar, tap  to open the menu.

- Tap to open the Settings screen where you can set the default home page, change display settings, set privacy settings, and more.
- Tap to view items being downloaded. You can also resume or stop current downloads.
- Tap to view information about the Web page you are browsing.
- Tap to see web pages that you have viewed.
- Tap to manage and view web pages that you have saved.
- Tap to open the Opera Mobile help file.
- Tap to close Opera Mobile completely. Opera Mobile will not run in the background.

Note For more information about using Opera Mobile, go to: <http://www.opera.com/products/mobile/>

8.4 Using YouTube™

YouTube™ lets you browse, search, and watch video clips from the YouTube server.

Note You need an active connection to use YouTube. If you are using a data connection, your data connection bill may increase significantly due to large file sizes of the videos.

To open YouTube

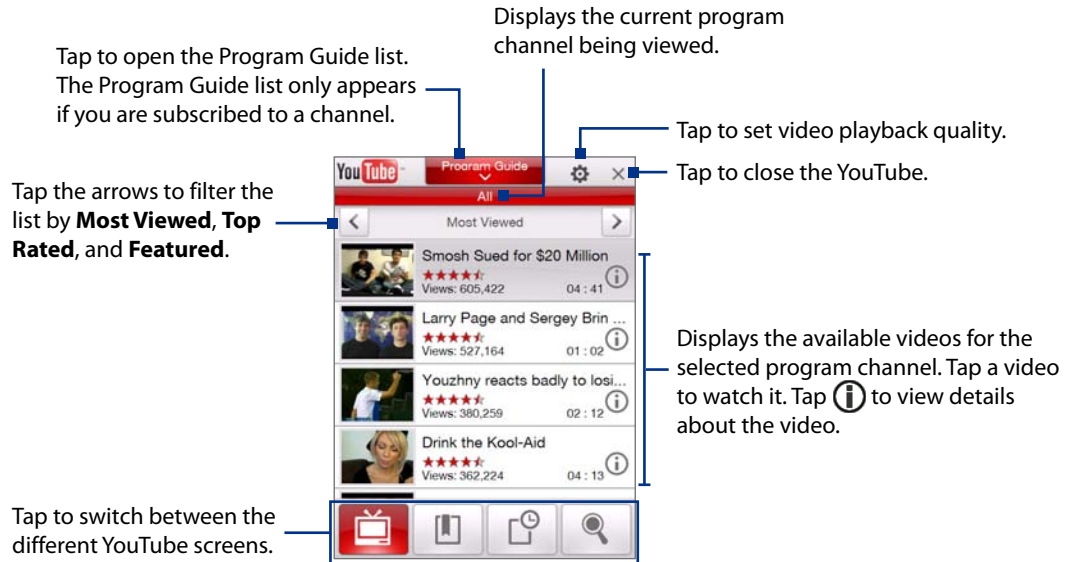

Tap **Start > Programs > YouTube**.



Browse for videos

The Program Guide list lets you change the program channel so you can browse different types of videos available on the YouTube server. By default, there is only one channel in the Program Guide.

To add a new program channel into the Program Guide list

1. On the YouTube screen, tap .
2. On the **Search** screen, enter the channel you want to add to the Program Guide list.
3. Tap **Search**. YouTube searches for the channel and then displays the available videos from it.
4. Tap  and then on the confirmation screen, tap **OK**. The channel you just subscribed to will now be shown when you tap **Program Guide**.



Tip You can also add a YouTube user as a program channel. To add, tap  in any of the YouTube screens and then tap .

To change the program channel

1. On the **Videos** screen, tap **Program Guide** at the top of the screen.
2. On the Program Guide list, select a channel.
3. The video list refreshes to display the available videos for the newly selected channel.

To delete a program channel from the Program Guide list

You can only delete program channels that you have added to the Program Guide list.

1. On the **Videos** screen, tap **Program Guide**.
2. Scroll down to the channel you want to delete and then tap .
3. On the confirmation screen, tap **Yes**.

Watching videos

In the Videos, Bookmarks, or History screen, tap a video to launch the YouTube Video Player.

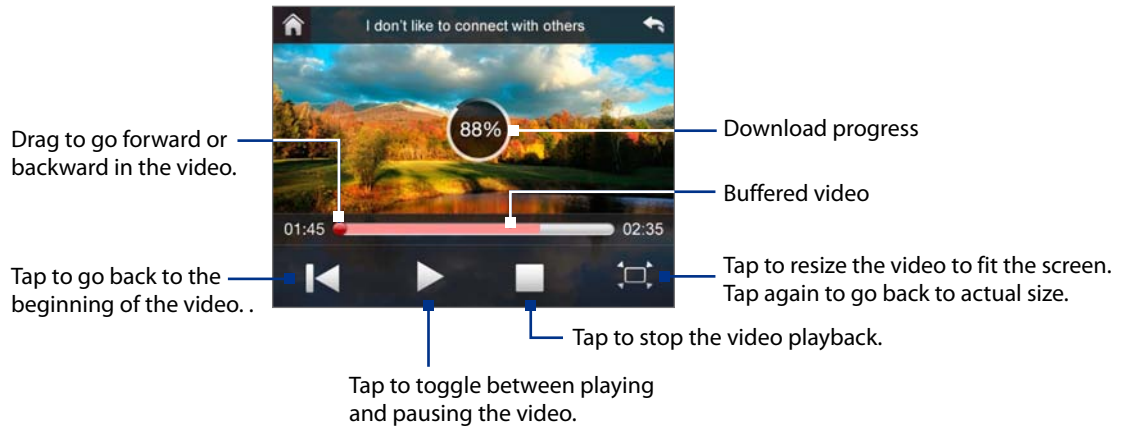

Tip To adjust the volume, press the **VOLUME CONTROLS** on the side of the device.

Navigation Control

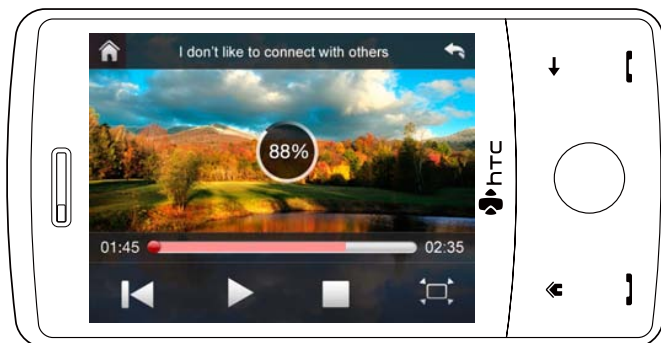

This control	Does this
ENTER	Toggle between playing and pausing video playback.
Navigation Right (Landscape orientation)	Press and hold to go forward in the video.
Navigation Left (Landscape orientation)	Press and hold to go back in the video
VOLUME BUTTONS	Press to adjust the volume.

When you tap Stop () or finish watching the entire video, you are presented with options on what you can do next.

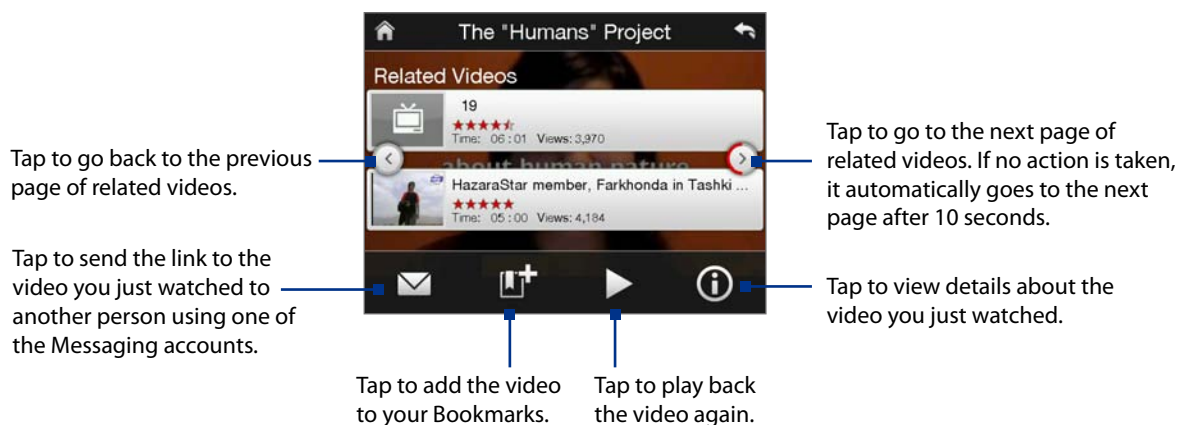

Bookmarks



You can store frequently viewed videos into Bookmarks for quick access.

To view Bookmarks

On the YouTube screen, tap . Tap a video to watch it.

To add a video into Bookmarks.

Do one of the following:

- After watching a video, tap .
- On the list of videos, tap  on the video you want to add to Bookmarks and then tap **Bookmark**.

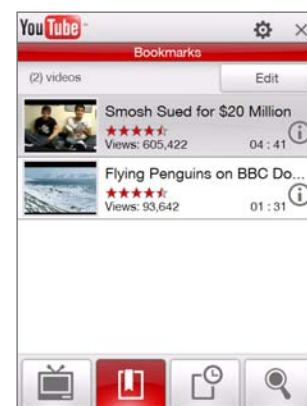

To delete a video from Bookmarks

1. On the **Bookmarks** screen, tap **Edit**.
2. Tap  on the video you want to remove from Bookmarks.
3. On the confirmation screen, tap **Yes**.
4. Tap **Done**.

History

View recently watched videos on the History screen.

To view History

On the YouTube screen, tap . Tap a video to watch it.

Note To clear the History list, tap **Clear**.

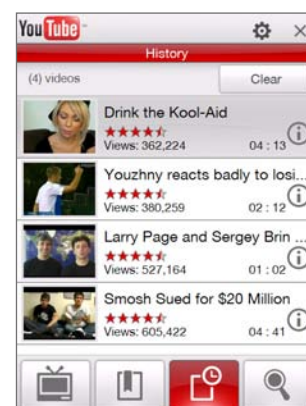

8.5 Using Windows Live™

Windows Live™ gives you a full Internet experience on your device. Windows Live™ helps you to find information, pursue your interests, and get in touch with friends and family on the Internet easier.

Windows Live™ offers the following key features:

- **Live Search Bar**, which lets you search for information on the Web.
- **Live Messenger**, the next generation of MSN Messenger Mobile.
- **Live Mail**, the next generation of Hotmail.
- **Live Contacts**, your address book for storing Live Mail, Live Messenger and Hotmail contacts.

Set up Windows Live™

The first time you use Windows Live™, sign in using your Windows Live™ ID, which is your Windows Live™ Mail or Hotmail address, and password.

To set up Windows Live™ for the first time

1. Tap **Start > Programs > Windows Live** and then tap **Sign in to Windows Live**.
2. Tap the links to read the Windows Live™ Term of Use and the Microsoft Privacy Statement. After reviewing them, tap **Accept**.
3. Enter your Windows Live™ Mail or Hotmail address and password, select the **Save password** checkbox, then tap **Next**.
4. Tap **Next**.
5. Choose what information you want to sync online with your device.

If you select **Store Windows Live contacts in your mobile phone's contact list**, your Windows Live™ contacts will be added to the contact list and to Windows Live™ Messenger on your device.

If you select **Sync e-mail**, your Windows Live™ Mail or Hotmail inbox messages will be downloaded to your device.

6. Tap **Next**.
7. After synchronization is complete, tap **Done**.

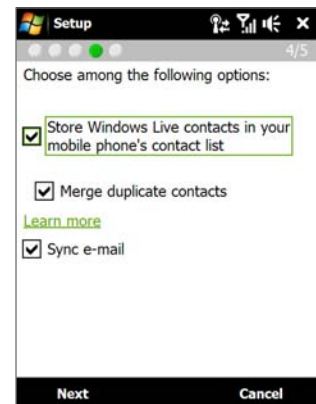

The Windows Live™ interface

On the Windows Live™ main screen, you will see a search bar, navigation buttons, and an area where you can show and customize your profile.

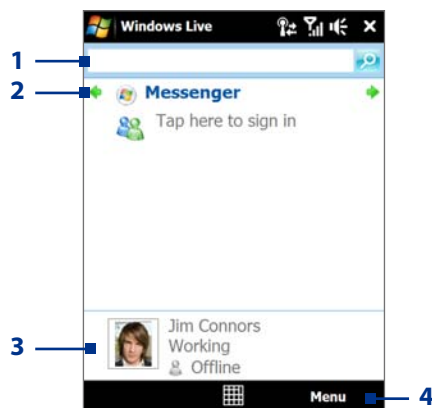

- 1 Search bar
- 2 Navigation buttons. Tap the left or right arrow to switch between Windows Live™ Messenger, Windows Live™ Mail, and Sync status.
- 3 Tap to change the display name, picture, or personal message.
- 4 Tap **Menu** to access and change settings.

Windows Live™ Messenger

With this mobile version of **Windows Live™ Messenger**, you enjoy many of the same cool features that you get from the desktop version, which include the following:

- Instant messaging via text and voice
- Multiple conversations
- Insert emoticons
- Contact list with presence
- Send and receive files including photos
- Change status/display name
- View contacts by online status, groups, and more
- Send messages even when a contact is offline

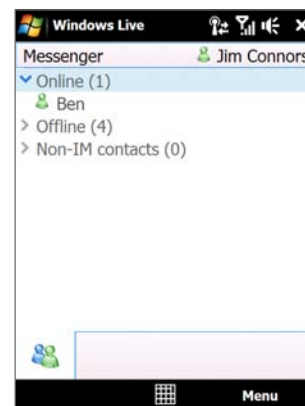

Note Before you can use Windows Live™ Messenger, your device must be connected to the Internet. For information about setting up an Internet connection, see “Ways of Connecting to the Internet” in this chapter.

Launch Messenger and sign in

To open Windows Live™ Messenger

Do one of the following:

- Tap **Start > Programs > Messenger**.
- On the Windows Live™ main screen, tap the left or right arrow until you see **Messenger**, then tap it.

To sign in and out

1. Tap **Sign in** on the Messenger screen.
2. If this is your first time to sign in, a message appears to inform you that your messenger contacts will be added to the contact list on your device. Tap **OK** to add them. Signing in may take several minutes, depending on your connection speed.
3. To sign out, tap **Menu > Sign Out**.

To start and end conversations

1. In the contact list, select a contact, then tap **Send IM** to open a message screen.
2. Enter your text message in the text entry area of the message screen.
3. To add an emoticon, tap **Menu > Add emoticon** then tap an icon from the list.
4. Tap **Send**.
5. To end a conversation with the current contact, tap **Menu > End conversation**.

- Tips**
- To send a file, tap **Menu > Send**. You can choose to send a picture, voice clip or any file.
 - To invite one or more contacts to the conversation, tap **Menu > Options > Add participant**.
 - To send a voice message, tap Voice Clip on a message screen then start talking. After you have recorded a message, tap **Send**.

Add Windows Live™ contacts

You can add new Windows Live™ contacts in Windows Live™ Messenger or in Contacts.

To add a Windows Live™ contact in Live Messenger

1. Tap **Menu > Add new contact**.
2. Enter the e-mail address of the contact, then tap **OK**.

To add a Windows Live™ contact in Contacts

1. On the Home screen, slide to the **People** tab and then tap **All People**.
2. Tap **New**, then tap **Windows Live**.

- In the **IM** box, enter the e-mail address of the contact, which can be a Windows Live ID or any other e-mail address.

Tip You can fill in other information about the contact, if desired. This is not necessary if you will communicate with the contact only through Windows Live™ Messenger or Live Mail.
- Tap **OK**.
- Follow the remaining instructions to add the new contact to your Windows Live™ contact list.

8.6 Using Your Device As a Modem (Wireless Modem)

While traveling, you can use your Windows Mobile powered device as a modem for your notebook. **Wireless Modem** allows you to use your device as a USB modem.

Note When you activate Wireless Modem, ActiveSync will be disabled automatically.

Activate your device as a modem

Connect your device to your notebook using the USB cable, then follow the steps below to activate your device as a modem.

- On your device, tap **Start > Programs > WModem**.
- Tap **Menu > Start**.
- The next thing to do is to add your device as a modem onto your notebook.

Add your device as a modem to your notebook

After you tap **Menu > Start** on the Wireless Modem screen of your device, your notebook will automatically detect that your device has been connected. The Found New Hardware dialog box will then appear on your computer.

To add your device as a modem to a Windows Vista notebook

- Click **Cancel** to close the Found New Hardware dialog box.
- Open the Control Panel, then click **Device Manager**.
- Right-click **Generic Serial**, then click **Update Driver Software**.

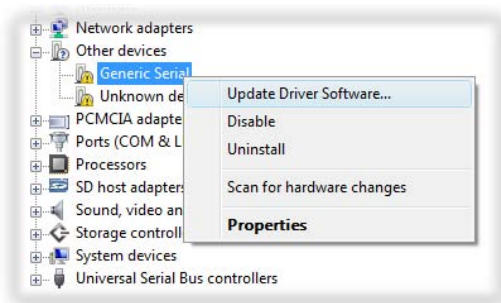

- Click **Browse my computer for driver software**, then click **Let me pick from a list of device drivers on my computer**.

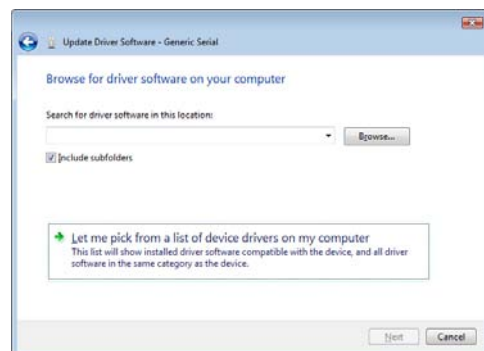
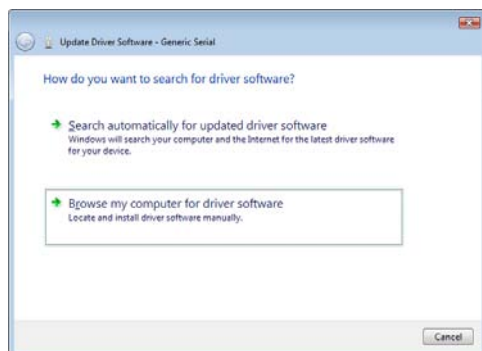

- Click **Show All Devices**, then click **Have Disk** and browse the Getting Started Disc to locate the USB modem driver for your device.

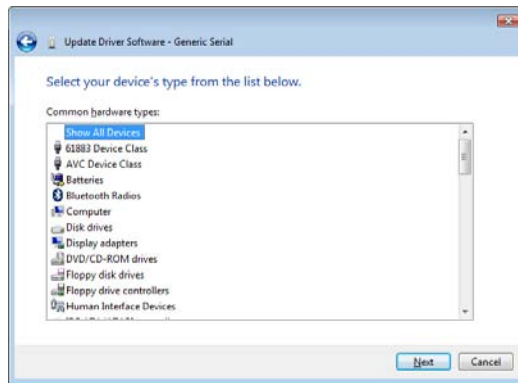

- HTC USB Modem** will then be displayed. Select this modem driver then click **Next**.
- If you see the Update Driver Warning message, simply click **Yes** to continue with the installation.
- In the Windows Security dialog box, click **Install this driver software anyway** to continue with the installation.
- Wait for the installation of the HTC USB Modem to complete, then tap **Close**.

To add your device as a modem to a Windows XP notebook

- In the Found New Hardware dialog box, select **Install from a list or specific location (Advanced)** and click **Next**.
- Select **Search for the best drivers in these locations**.
- Insert the Getting Started Disc into your CD drive. Select the **Include this location in the search** check box. Click **Browse** and choose the CD drive and root folder where the modem driver is located, then click **Next**.
- Wait for the installation to complete, then click **Finish**.
- Click **Start > Settings > Control Panel**.
- Double-click **Phone and Modem Options**.
- Click the **Modems** tab. Select the new modem from the **Modem** list, then click **OK**.
- You can now connect your computer to the Internet. Follow the steps in "Dial up and connect to the Internet."

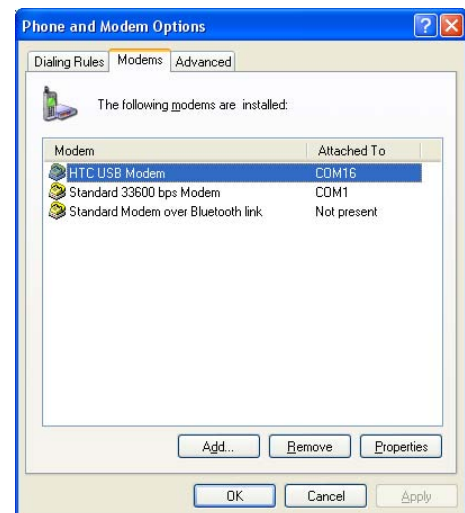

Create a modem dial-up connection

After your notebook recognizes your device as a modem, create a modem dial-up connection on your notebook.

To set up a modem dial-up connection in a Windows Vista notebook

1. On your notebook, click **Start > Control Panel**.
2. Double-click **Network and Sharing Center**.
3. On the left-hand panel of the Network and Sharing Center, click **Set up a connection or network**.

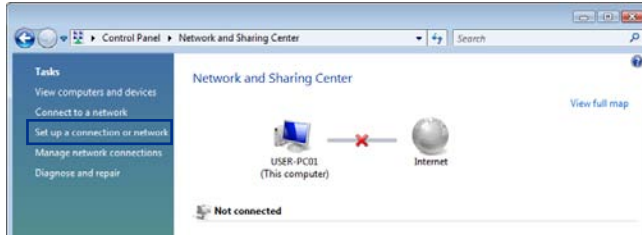

4. Click **Set up a dial-up connection** then click **Next**.
5. Enter the following information: dial-up phone number (**#777**), your user name and password. Also select the **Remember this password** check box.



6. When you have finished entering the information, click **Connect**. Your notebook then starts to dial up to the Internet using your device as a modem.
7. When you see a dialog box that shows you are connected to the Internet, click **Close**.
8. In the Set Network Location dialog box, choose the type of location where you will use the dial-up connection.

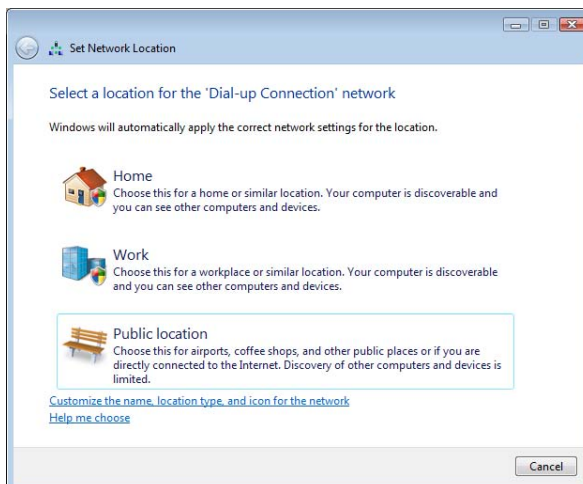

To set up a dial-up connection in a Windows XP notebook

1. On your computer, click **Start > Settings > Control Panel**.
2. Double-click **Network Connections**.
3. Click **File > New Connection**.
4. In the **New Connection Wizard**, click **Next**.
5. Click **Connect to the Internet** then click **Next**.
6. Select **Set up my connection manually** then click **Next**.
7. Select **Connect using a dial-up modem** then click **Next**.
8. Select the USB modem that you previously installed, then click **Next**.

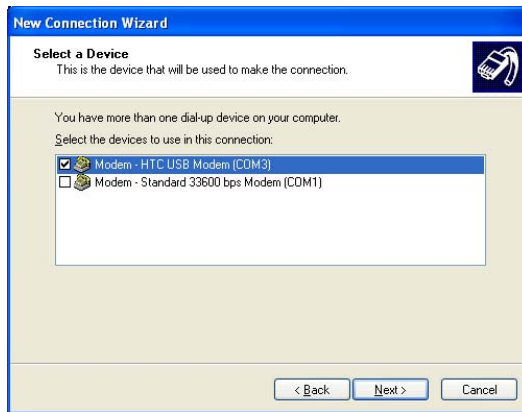

9. Enter a descriptive name for this connection, then click **Next**.
10. Enter **#777** as the dial-up phone number then click **Next**.
11. Under **Internet Account Information**, enter your user name and password then click **Next**.
12. Click **Finish** to exit the wizard.
13. The Connect dialog box then opens. Click **Dial** to dial up and connect to the Internet.



Dial up and connect to the Internet

Whenever you want to dial up to the Internet on your notebook using your device as a modem, tap **Menu > Start** in Wireless Modem of your device, then do the following steps to connect to the Internet.

1. If Wireless Modem has not yet been activated on your device, select the type of connection (USB or Bluetooth) then tap **Menu > Start**.
2. On a Windows Vista notebook, click **Start > Connect to**, select the name of the dial-up connection, then tap **Connect**.

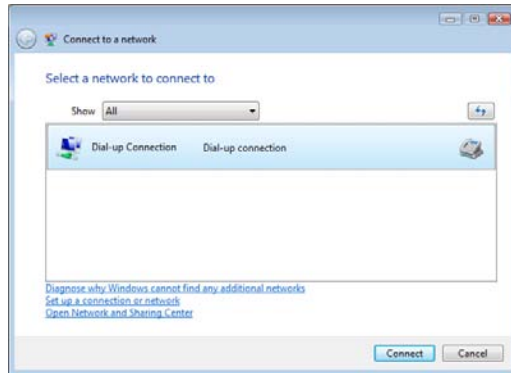

3. On a Windows XP notebook, click **Start > Settings > Control Panel**, double-click **Network Connections**, then double-click the modem connection.
4. The Connect dialog box then opens. Click **Dial** to dial up and connect to the Internet.



To end the modem session

On the Wireless Modem screen, tap **Done** or tap **Menu > Stop**.

8.7 Using RSS Hub

RSS Hub is an RSS reader that keeps you up-to-date with the latest news from the Internet. It monitors Internet news channels and downloads the most current news updates and podcasts so you are instantly informed of breaking news and events.

For more information and tips on using RSS Hub, see Help on your device.

Note Make sure you have an active Internet connection (such as a data connection) before using RSS Hub.

Subscribe to and organize news channels

You must subscribe to news channels before you can receive RSS feeds.

To subscribe to news channels

1. Tap **Start > Programs > RSS Hub**, then tap **Continue**.
2. In the New Channel Wizard screen, select the **Choose from a list of known Channels** option, then tap **Next**. A list of RSS channels is displayed.

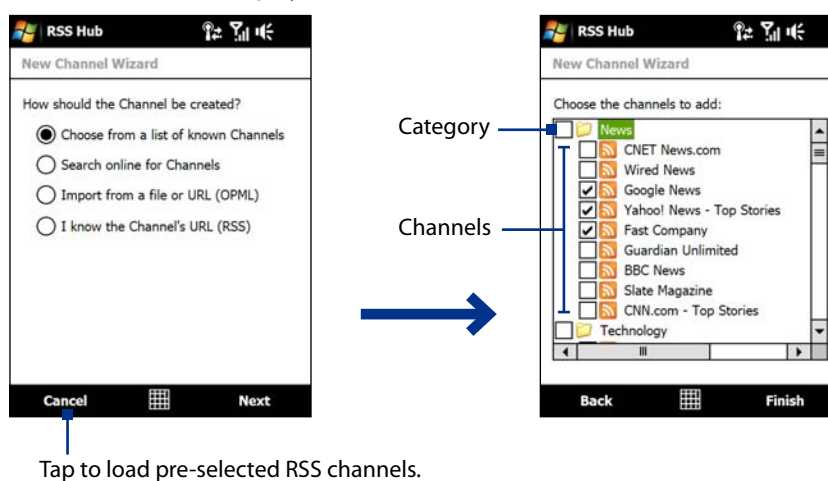

Note If the RSS channel you want to subscribe to is not in the list of known channels, tap **Back**, then select another option on the New Channel Wizard screen. For more information on these other options, see the Help on your device.

3. Select the checkboxes of the RSS channels you want to subscribe to, then tap **Finish**.

Tip Channels are grouped by categories. If you want to select all channels in a category, select the category check box.

4. The channel list appears. Tap **Refresh** to update the channels.

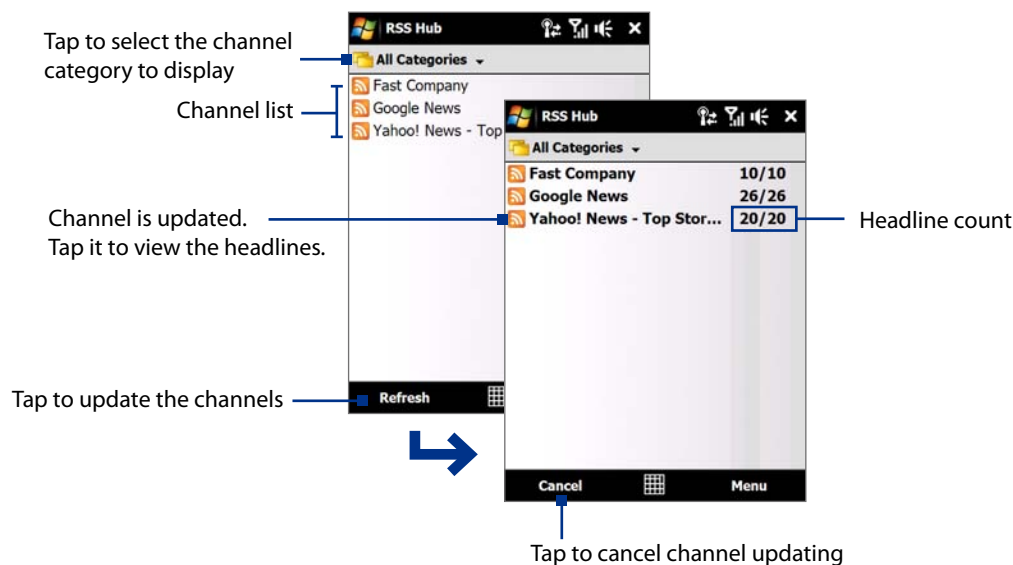

To add new channels

1. In the channel list, tap **Menu > Channel > New** to open the New Channel Wizard screen.
2. Select an option, then follow screen instructions to add new channels. For more information on New Channel Wizard options, see Help on your device.

To filter the channels in the display

In the channel list, tap **Menu > View**, then select:

- **Updated** to display only those channels with unread headlines.
- **All** to display all subscribed channels.

To manage channel categories

- To view all the channels in a particular category, tap **All Categories** in the upper left area of the channel list, then tap the category you want to display.
- To add a new category, tap **Menu > Categories** in the channel list to display all categories, then tap **Menu > New**.
- To rename or delete a category, tap **Menu > Categories** in the channel list to display all categories, select a category, then tap **Menu > Rename** or **Menu > Delete**.
- If you want to change the channel category, tap and hold the channel in the channel list, then tap **Change Category**. Select a new category and tap **OK**.

View and organize headlines

Tap a channel in the channel list to display the headlines for that channel.

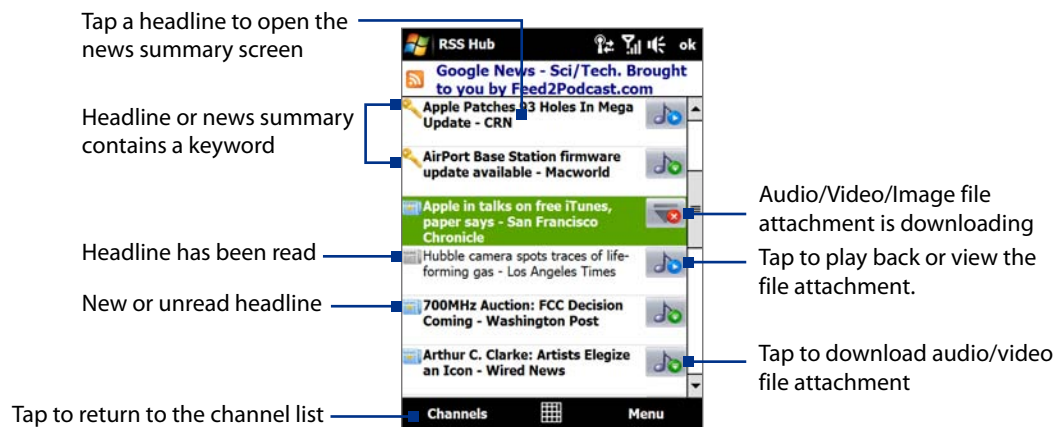

New or unread headlines display in bold and are marked with a blue newspaper icon. Headlines that have been read are marked with a gray newspaper icon.

View the news summary

Tap a headline in the headline list to display the news summary.

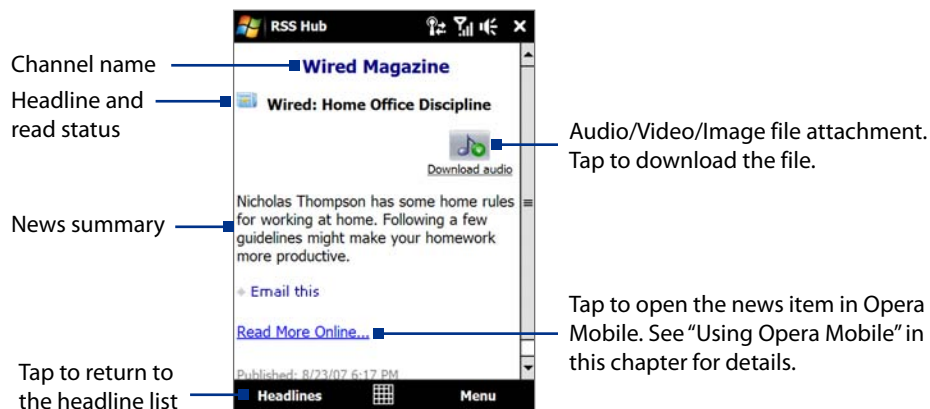

To change view options

In the news summary screen, tap **Menu** to change the text size, fit the text to the screen (text wrap), or enable **ClearType** for better viewing.

To download, play, or save podcasts

1. When you see an audio or video file attachment in the news summary, do one of the following to download the file:



- Tap **Menu > Podcasts > Start Download**.
- Tap the **Download audio/Download video** link below the audio/video file icon.

Tip To cancel the file download, tap **Menu > Podcasts > Cancel Download**, or tap **Cancel download** below the audio/video file icon.

2. After downloading the file, do one of the following:
 - Tap **Menu > Podcasts > Play** or tap **Play audio/Play video** below the audio/video file icon to play back the file.
 - Tap **Menu > Podcast > Save** to save a copy of the file to the device main memory or internal storage.

To send the headline link via e-mail

1. In the news summary screen, tap **Menu > Send Link via Email**.
2. Messaging opens and displays the Account Picker screen. Tap the e-mail account you want to use to send the headline link. A new e-mail message is then created with the headline link.
3. Specify the e-mail recipients, then send it.

Note For more information on how to compose e-mails, see "Using E-mail" in Chapter 6.

To view the next or previous news summary

In the news summary screen, tap **Menu > Next** or **Menu > Previous**, or press Navigation left or right.

For more information about the features and configuring RSS Hub, refer to the online help. To open the online help, tap **Start > Help** while in RSS Hub.

Chapter 9

Bluetooth

9.1 Bluetooth Modes

9.2 Bluetooth Partnerships

**9.3 Connecting a Bluetooth Hands-free
or Stereo Headset**

**9.4 Beaming Information
Using Bluetooth**

**9.5 Bluetooth Explorer and
Bluetooth File Sharing**

9.6 Printing Files via Bluetooth

9.1 Bluetooth Modes

Bluetooth is a short-range wireless communications technology. Devices with Bluetooth capabilities can exchange information over a distance of about eight meters without requiring a physical connection.

Bluetooth on your device operates in three different modes:

- **On.** Bluetooth is turned on. Your device can detect other Bluetooth-enabled devices, but not vice versa.
- **Visible.** Bluetooth is turned on, and all other Bluetooth-enabled devices can detect your device.
- **Off.** Bluetooth is turned off. In this mode, you can neither send nor receive information using Bluetooth.

Notes • By default, Bluetooth is turned off. If you turn it on, then turn off your device, Bluetooth also turns off. When you turn on your device again, Bluetooth automatically turns on.

- Turn off Bluetooth when not in use to conserve battery power, or in places where using a wireless device is prohibited, such as on board an aircraft and in hospitals.

To turn Bluetooth on and make your device visible

1. On the Home screen, slide to the **Settings** tab and then tap **Menu > Bluetooth Devices > Mode** tab.
2. Select the **Turn on Bluetooth** and **Make this device visible to other devices** check boxes.
3. Tap **OK**. The Title bar will show  to indicate that the device is in Visible mode.

To turn off Bluetooth visibility after a certain period of time

You can automatically turn off Bluetooth visibility after a specified period of time.

1. On the Home screen, slide to the **Settings** tab and then tap **Menu > Bluetooth Devices > Timeout** tab.
2. In **Turn off Visible mode**, select the time before your device's Bluetooth visibility turns off. Tap **OK**.

9.2 Bluetooth Partnerships

A Bluetooth partnership is a relationship that you create between your device and another Bluetooth-enabled device in order to exchange information in a secure manner.

To create a Bluetooth partnership

1. On the Home screen, slide to the **Settings** tab and then tap **Menu > Bluetooth Devices > Devices** tab.
2. Tap **Add new device**. Your device displays the names of other Bluetooth devices within range.
3. Tap the device name in the box, then tap **Next**.
4. Specify a passcode to establish a secure connection. The passcode can be 1 up to 16 characters.
5. Tap **Next**.
6. Wait for the paired device to accept the partnership. The receiving party needs to enter the same passcode that you specified.
7. The name of the paired device is then displayed. You may edit and enter a new name for that device.
8. Select the check boxes of services that you want to use from the paired device, then tap **Finish**.

Note Creating a Bluetooth partnership between two devices is a one-time process. Once a partnership is created, the devices can recognize the partnership and exchange information without entering a passcode again.

To accept a Bluetooth partnership

1. Ensure that Bluetooth is turned on and in visible mode.
2. Tap **Yes** when prompted to establish a partnership with the other device.
3. Enter a passcode (the same passcode that is entered on the device requesting the partnership) to establish a secure connection. The passcode must be between 1 and 16 characters.
4. Tap **Next**.
5. Tap **Finish**. You can now exchange information with the paired device.

Tips • To rename a Bluetooth partnership, tap and hold the partnership's name on the **Devices** tab of the Bluetooth screen, then tap **Edit**.

- To delete a Bluetooth partnership, tap and hold the partnership's name on the **Devices** tab, then tap **Delete**.

9.3 Connecting a Bluetooth Hands-free or Stereo Headset

For hands-free phone conversations, you can use a Bluetooth hands-free headset such as a car kit with your device. Your device also supports A2DP (Advanced Audio Distribution Profile) which allows you to use a Bluetooth stereo headset for hands-free phone conversations and for listening to stereo music.

To connect a Bluetooth hands-free or stereo headset

1. Make sure that both your device and the Bluetooth headset are turned on and within close range, and that the headset is visible. Refer to the manufacturer's documentation to find out how to set the headset in visible mode.
2. On the Home screen, slide to the **Settings** tab and then tap **Menu > Bluetooth Devices > Devices** tab > **Add new device**.
3. Tap the name of the Bluetooth headset, then tap **Next**. The device will automatically pair the device with the Bluetooth headset.

Windows Mobile will automatically try one of the preconfigured passcodes (0000, 1111, 8888, 1234) to pair the Bluetooth headset with the device. If this fails, you have to enter the passcode delivered with your headset manually.

Note If the Bluetooth stereo headset becomes disconnected, turn the headset on and repeat step 1 to 2 above. Tap and hold the name of the Bluetooth stereo headset and tap **Set as Wireless Stereo**.

9.4 Beaming Information Using Bluetooth

You can beam information, such as contacts, calendar items, tasks, and files from your device to your computer or to another Bluetooth-enabled device.

Note If your computer does not have built-in Bluetooth capability, you need to connect and use a Bluetooth adapter or dongle on your computer.

To beam information from your device to a computer

1. Turn on Bluetooth on your device, and make your device visible. For information about this, see "To turn Bluetooth on and make your device visible".
2. Set Bluetooth on your computer to visible mode, create a Bluetooth partnership, then enable your computer to receive Bluetooth beams.

Note If the Bluetooth adapter or dongle on your computer was installed using a third-party provided driver, open the Bluetooth software that came with the Bluetooth adapter/dongle and enable the adapter/dongle to be discovered by other devices. Refer to the Bluetooth adapter's documentation for more information.

If your computer has **Windows Vista** or **Windows XP SP2** and your computer's Bluetooth adapter is supported by your Windows version, do the following steps:

- a. On your computer, open **Bluetooth Devices** from the Control Panel, then click the **Options** tab on the **Bluetooth Devices** window.
 - b. For **Windows Vista**, select **Allow Bluetooth devices to find this computer**. For **Windows XP**, select **Turn discovery on** and **Allow Bluetooth devices to connect to this computer**.
 - c. Create a Bluetooth partnership between your device and computer. For information about creating a partnership, see "Bluetooth partnerships".
 - d. In the **Options** tab of **Bluetooth Devices**, select **Show the Bluetooth icon in the notification area**.
 - e. To enable your computer to receive Bluetooth beams, right-click the Bluetooth icon  in the notification area at the bottom-right corner of your computer screen and select **Receive a File**. You are now ready to beam.
3. On your device, select an item to beam. The item can be an appointment in your calendar, a task, a contact card, or a file.
 4. To beam a contact, tap **Menu > Send Contact > Beam**. To beam other types of information, tap **Menu > Beam [type of item]**.

5. Tap the device name to which you want to send the item.
6. If you beamed a calendar, task, or contact item to your computer and it is not automatically added to Outlook, select **File > Import and Export** in Outlook to import it.

To beam information to a Bluetooth-enabled device such as another Windows Mobile-powered device, follow steps 1 to 5 in the above procedure.

- Tips**
- The default folder on your computer where beamed items are stored may be C:\Documents and Settings\your_username\My Documents in Windows XP or C:\Users\your_username\My Documents in Windows Vista.
 - For your device to receive Bluetooth beams, tap **Start > Settings > Connections** tab > **Beam** and make sure the **Receive all incoming beams** check box is selected.

9.5 Bluetooth Explorer and Bluetooth File Sharing

Bluetooth Explorer searches for other Bluetooth devices that have file sharing enabled and lets you access their Bluetooth shared folder. You can copy files from and to their shared folder, and create subfolders in it. When you enable **Bluetooth file sharing** on your device, other Bluetooth-enabled devices will also be able to access your Bluetooth shared folder.

To enable Bluetooth Explorer and Bluetooth file sharing on your device

1. On the Home screen, slide to the **Settings** tab and then tap **Menu > Bluetooth Devices > FTP** tab.
2. Select the **Enable Bluetooth Explorer** check box. This makes the **\Bluetooth** device folder visible in the File Explorer.
3. Select the **Enable File Sharing** check box. You can use the default Bluetooth shared folder, or tap **Browse** to use another folder as your shared folder.
4. Tap **OK**.

To use Bluetooth Explorer

1. Bluetooth Explorer is integrated with the File Explorer program. You can open it by tapping **Start > Programs > Bluetooth Explorer** or by tapping the down arrow (▼) on the upper left of File Explorer screen then tapping **Bluetooth**.
2. Bluetooth Explorer then scans for other Bluetooth devices that have file sharing enabled. From the list, tap to select a Bluetooth device you want to connect to. You may need to enter a passcode in order for you to connect to the selected device. If there are files contained in the Bluetooth shared folder on the other device, you will be able to see them on the Bluetooth Explorer screen.



3. Select one or more files, then tap **Menu > Edit** and choose to cut or copy the files.
4. Tap **Up** twice.
5. Navigate to the folder where you want to paste the files on your device, then tap **Menu > Edit > Paste**.

9.6 Printing Files via Bluetooth

Connect your device to a Bluetooth printer to print contact information, appointment details, images, and other file types.

Note You can print files in the **.txt**, **.jpg**, **.xhtml**, **.vcf**, **.vcs** file formats.

Before you start printing, make sure to turn on the Bluetooth printer and to turn on Bluetooth on your device. To turn on Bluetooth, tap **Start > Settings > Connections** tab > **Comm Manager**, then tap the **Bluetooth** button.

To print contact information

1. On the Home screen, slide to the **People** tab and then tap **All People**.
2. Select the contact whose information you want to print.
3. Tap **Menu > Print via Bluetooth > Menu > Search Devices**. Your device starts to search for Bluetooth devices.
4. Select the Bluetooth printer and tap **Menu > Send File**.
5. Set the printing options you want, then tap **Print**.

To print a calendar appointment

1. Tap **Start > Calendar**, then select (highlight) the appointment whose details you want to print.
2. Follow steps 3 to 5 in the "To print contact information" procedure.

To print a JPEG file

1. In Pictures & Videos, locate the JPEG file you want to print.
2. Tap and hold the JPEG image file and then on the menu, tap **Print via Bluetooth**.
3. Follow steps 3 to 5 in the "To print contact information" procedure:

To print a text file

1. In File Explorer, locate the text file you want to print.
2. Tap and hold the txt file and then on the menu, tap **Print via Bluetooth**.
3. Follow steps 3 to 5 in the "To print contact information" procedure:

Chapter 10

Navigating on the Road

**10.1 Guidelines and Preparation
for Using GPS**

**10.2 Downloading Satellite Data
via QuickGPS**



10.1 Guidelines and Preparation for Using GPS

If you install a GPS software on your device, please follow these guidelines before and when using your device as a GPS device.

- Do not operate the GPS system while driving. The plotted GPS route is only for driving reference. It should not interfere with actual driving behavior.
- When using the device inside a vehicle, use the car holder to mount the device securely in place. Avoid placing the device in the areas shown in the following diagram:

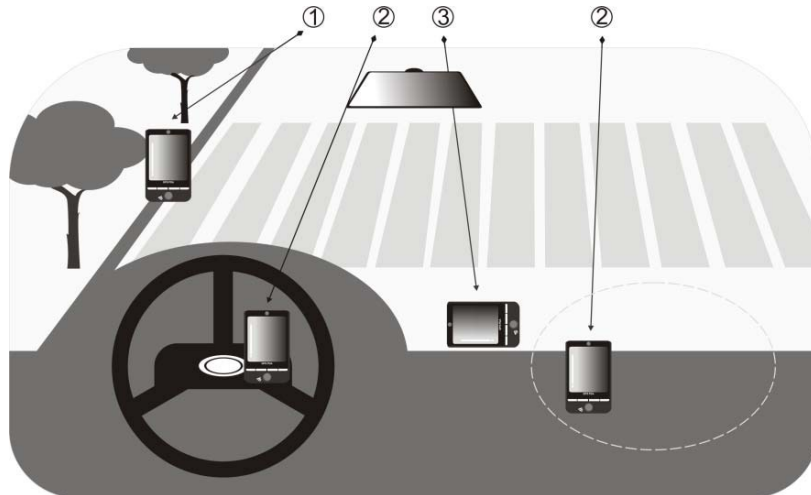

- 1 Do not place where it will block the driver's vision.
- 2 Do not place where air bags could deploy.
- 3 Do not place anywhere in the vehicle without securing the device in the holder.

- Please use the GPS system cautiously. Users shall be liable for any damages resulting from negligent operation of the system.
- The GPS signal cannot pass through solid non-transparent objects. Signal reception may be affected by obstructions such as high-rise buildings, tunnels, bridges, forests, weather (rainy or cloudy days), etc. If the vehicle's visor contains metal, it will be difficult for the GPS signal to pass through.
- Wireless communication products (such as mobile phones or radar-detecting devices) may interfere with the satellite signal, resulting in unstable signal reception.
- The Global Positioning System (GPS) is built and operated by the US Defense Department. The Department is responsible for the accuracy and maintenance of the system. Any changes that the Department makes may affect the accuracy and function of the GPS system.
- Do not leave your device in a vehicle or expose the device to direct sunlight to avoid overheating the battery, which could pose damage to the device or risk to the vehicle.

10.2 Downloading Satellite Data via QuickGPS

Before you start using your device for GPS navigation, open the **QuickGPS** program first to download ephemeris data (current satellite position and timing information) onto your device. This data is needed to determine the GPS position of your current location.

QuickGPS downloads ephemeris data from a Web server, instead of from the satellites, using the Internet connection on your device, which can be via Wi-Fi, ActiveSync or data connection. This significantly speeds up the time for determining your GPS position.

To open QuickGPS

Tap **Start > Programs > QuickGPS**.

To download data

Tap **Download** on the QuickGPS screen.

On the screen, initially, you will see the **Valid time** of the downloaded data. As time passes, the remaining days and hours of validity will be shown.

To speed up GPS positioning, download the latest ephemeris data when the validity of the data expires.



Download options

To configure download times, tap **Menu > Options** and choose from the available options:

- **Remind me when data expires.** Enables your device to display a reminder message when the validity of the ephemeris data has expired. When you see the reminder message, tap **Menu** to dismiss the reminder or to set the snooze time so that you will be reminded again. Tap **OK** to open the QuickGPS program and download the latest data.
- **Autodownload when data expires.** Allows ephemeris data to be automatically updated onto your device when the data has expired.
- **Autodownload when connected to PC via ActiveSync.** Allows ephemeris data to be automatically downloaded via ActiveSync to your device when your device is connected to your computer. Your computer must be connected to the Internet in order to download data.

Note The ephemeris data is stored on HTC Web servers. QuickGPS is preconfigured to connect to these servers.

Chapter 11

Experiencing Multimedia

11.1 Taking Photos and Videos

11.2 Viewing Photos and Videos Using Album

11.3 Using Windows Media® Player Mobile

11.4 Using Audio Booster

11.5 Using MP3 Trimmer



11.1 Taking Photos and Videos

Use **Camera** to take photos and record video clips. You can either use the camera to take photos or shoot videos.

To open the Camera screen

On the Home screen, slide to the **Photos and Videos** tab and then tap the camera icon (). The screen orientation automatically switches to landscape mode when you open Camera.

Tip You can also tap **Start > Programs > Camera** to open the Camera program.

To exit the Camera

Tap the **Exit** icon () on the Camera screen. Tap the screen to show the Camera screen icons.

Capture modes

The camera on your device allows you to capture pictures and video clips by using various built-in modes that provide you flexibility in taking your shots.





To change the capture mode

- Press Navigation left or right (Landscape orientation).
- Tap the middle icon at the bottom of the screen (the icon displayed is based on the current Capture mode). On the on-screen menu, tap the Capture mode you want to use.



Current Capture mode

You can select from the following capture modes:



Icon	Capture Mode
	Photo Captures standard still images.
	Video Captures video clips, with or without accompanying audio.
	Panorama Captures a sequence of still images continuously in one direction, and allows stitching of all the images to create a panoramic view of a scenery.
	Contacts Picture Captures a still image and gives you the option to immediately assign it as a Photo ID for a contact.
	Picture Theme Captures still images and places them within frames.

Supported file formats

Using the available capture modes, the camera in your device captures files in the following formats:

Capture mode	Format
Photo / Contacts Picture / Picture Theme / Panorama	JPEG
Video	H.263 (.3gp) ; MPEG-4 (.mp4)

Camera controls

The camera comes with an auto-focus function to let you capture sharp and crisp photos and videos of your subjects. Depending on the **Shoot Option** you have chosen, you will need to either touch or press the ENTER button to activate auto-focus. When auto-focus is activated, it is indicated by a flashing white bracket (). When focus is set, the bracket changes to a steady green bracket ().

Note For more information about the different shoot options, see “Advanced Options” in this chapter.

By default, you only need to press the ENTER button once to activate auto-focus and to take the photo or start capturing video. For example, in Photo mode, press ENTER to activate auto-focus; when focus is set, Camera automatically takes the shot.

Notes • In **Video** mode, press ENTER again to stop recording.



• In **Picture Theme** or **Panorama** mode, press ENTER for each shot you need to take.

On-screen controls and indicators

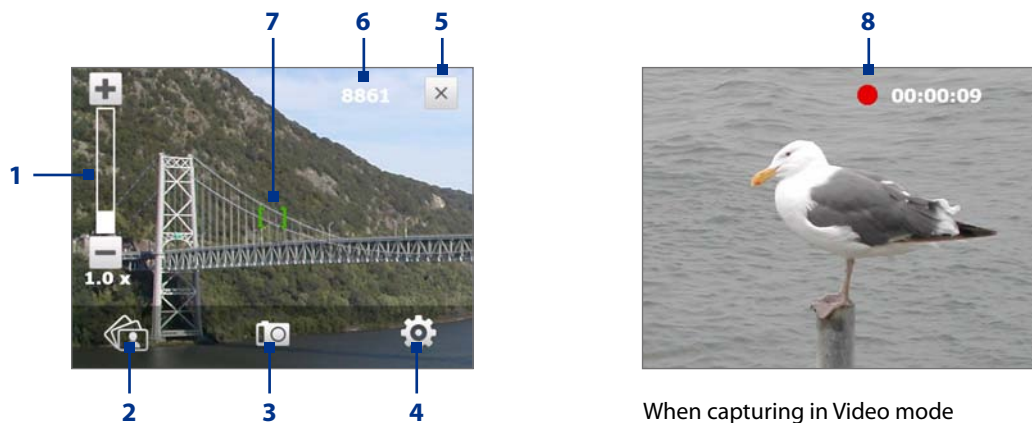
Tap the screen to display the controls and indicators.



Photo, Video, and Contacts Picture modes

1 Zoom control. Tap  to zoom in, or  to zoom out.

Tip You can also press Navigation up/down (Landscape orientation) or slide your finger clockwise or counterclockwise on the center Navigation Control to zoom in or out.

2 Album. Tap to open Album. See “Viewing Photos and Videos Using Album” for details.

3 Capture mode. Displays the current capture mode. Tap to open an on-screen menu where you can choose the capture mode.

4 Menu. Tap to open the Camera Settings screen. See “Menu Panel” for details.

5 Exit. Tap to exit the Camera program.

6 Remaining information indicator. In Photo, Contacts Picture, Picture Theme, and Panorama modes, this shows the remaining/available shots of pictures based on the current settings.

In Video mode, this shows the remaining duration that can be recorded. While recording video, this shows the recorded duration.

7 Auto-focus indicator. Displays a flashing bracket () when focusing. When focus is set, the flashing bracket changes to a steady green bracket ().

8 Recording indicator. Flashes when recording a video.

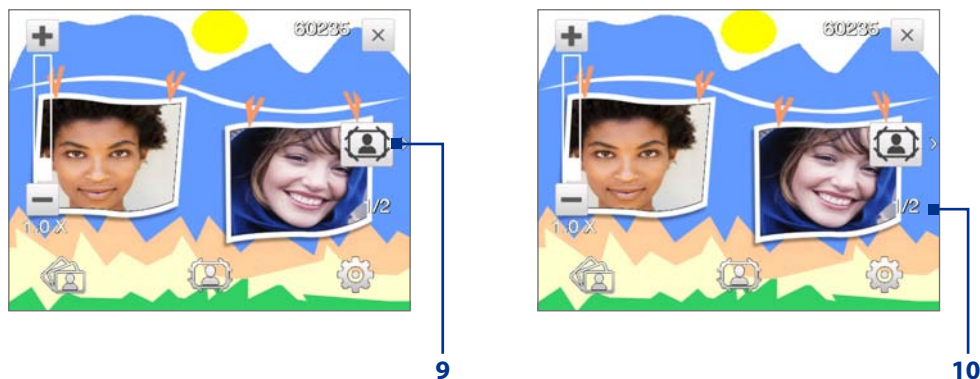

Picture Theme mode



9 Template Selector icon. In Picture Theme mode, tap to toggle among different templates.

10 Progress indicator. In Picture Theme and Panorama modes, this shows the number of consecutive shots.

Menu Panel

The Menu Panel provides a quick way of adjusting most common camera settings and lets you access more advanced camera settings. On the Camera screen, tap  to open the Menu Panel. To adjust a setting, keep tapping a button on the panel, for instance, **Resolution**, to cycle through the available settings. To access advanced options, tap .

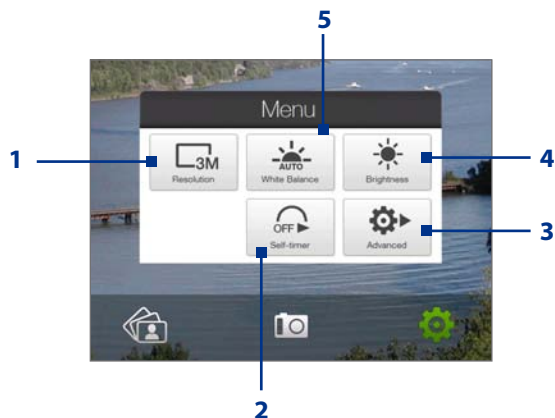

Note The available settings on the panel depend on the selected Capture mode.







1 Resolution. Tap to change the resolution (capture size). See the table in the following pages for the supported resolutions.

2 Self-timer. Tap to set the self-timer to **2 seconds**, **10 seconds**, or **Off** when in the Photo or Contacts Picture mode. When you press the ENTER button to capture a still image, it starts to count down, then captures a still image after the time expires.

3 Advanced. Tap to open the advanced camera settings. See “Advanced Options” for details.

4 Brightness. Tap to open the Brightness bar at the bottom of the screen. On the Brightness bar, tap  to decrease, or  to increase the brightness level. Tap outside the Brightness bar to apply the change.

5 White Balance. White balance enables the camera to capture colors more accurately by adjusting to different lighting conditions. White balance settings include: Auto () , Daylight () , Night () , Incandescent () , and Fluorescent () .

Zooming

Before capturing a photo or a video clip, you can zoom in to make the object in focus move closer, or zoom out to make the object move farther away.

To zoom in







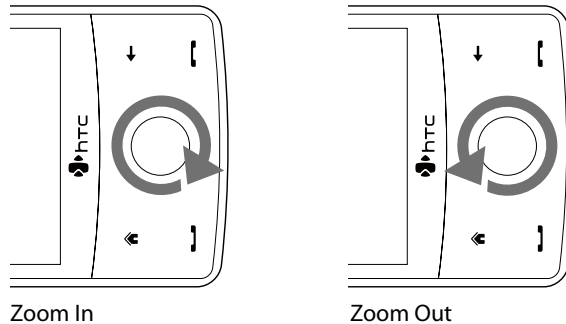





Slide your finger around the Navigation Control clockwise, press Navigation up (Landscape orientation), or tap .

To zoom out

Slide your finger around the Navigation Control counterclockwise, press Navigation down (Landscape orientation), or tap .



The camera zoom range for a photo or a video clip depends on the capture mode and resolution. Refer to the table for more information.



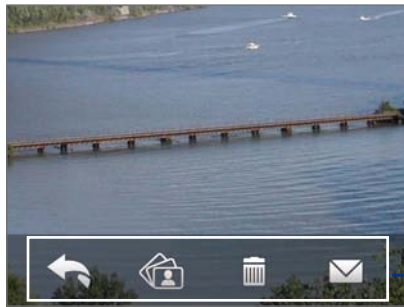

Capture mode	Resolution	Zoom range
Photo	 3M (2048 x 1536)	1.0x to 2.0x
	 2M (1600 x 1200)	1.0x to 2.0x
	 1M (1280 x 960)	1.0x to 2.0x
	 Large (640 x 480)	1.0x to 2.0x
	 Medium (320 x 240)	1.0x to 4.0x
Video	 CIF (352 x 288)	1x and 1.5x
	 Large (320 x 240)	1x and 1.5x
	 Medium (176 x 144)	1x and 1.5x
	 Small (128 x 96)	1x and 1.5x
Panorama	 Large (640 x 480)	1x and 2x
	 Medium (320 x 240)	1x, 2x and 4x
Contacts Picture	 Medium (240 x 320)	1.0x to 4.0x
Picture Theme	Determined by the current template	Depends on the size of the selected template

The Review screen

After capturing, the Review screen lets you view, send, or delete the photo or video clip by tapping an icon at the bottom of the screen.



Review screen icons

Icon	Function
	Back Return to the live Camera screen.
	View View the captured image or video in the Album program.
	Delete Delete the captured image or video.
	Send Send the captured image or video via e-mail.
	Assign to Contact After capturing in Contacts Picture mode, tap this icon to assign the photo to a selected contact.

Advanced Options

The Advanced Options let you adjust options for your selected capture mode and set Camera program preferences. Access the Advanced Options by tapping **Advanced** on the Menu Panel.

You can either tap on-screen or press Navigation up/down (Landscape orientation) to navigate through the Advanced Options screen.

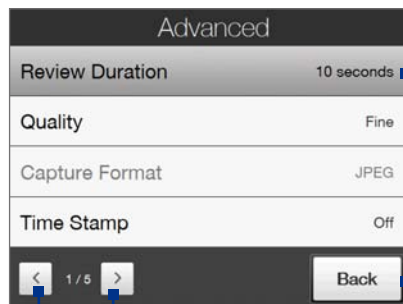

Tap an item to change the setting.

Tap to go back to the Camera screen.

Tap to go through the different Advanced Camera Settings screens.

- **Quality.** Select the JPEG image quality level for all captured still images. Choose from **Basic**, **Normal**, **Fine**, and **Super Fine**.
- **Capture Format.** Select the desired file format.
- **Time Stamp** (Photo mode). Choose whether or not to include the shooting date and time on captured photos.
- **Storage.** Select where you want to save your files. You can either save the files to the main memory or to the internal storage.
- **Keep Backlight.** Turn the backlight on or off. This overrides your device backlight settings while you are using the camera.

- **Shutter Sound.** Choose whether or not you want the camera to make a shutter sound when you press the ENTER button.
- **Shoot Option.** The camera comes with an auto-focus feature that is activated when the ENTER button is either touched or pressed.
 - **Touch and Press.** Requires you to touch the ENTER button to activate the auto-focus; when focus is set, press the ENTER button to take the shot.
 - **Touch.** Requires you to touch the ENTER button to activate autofocus; when focus is set, Camera automatically takes the shot.
 - **Full Press.** Requires you to press the ENTER button to activate auto-focus; when focus is set, Camera automatically takes the shot.
- **Review Duration.** Set a time length for displaying the captured image/video on the Review screen. Select **No Limit** if you do not want to impose a time limit. Select **No Review** to immediately return to the live Camera screen after capturing and saving.
- **Image Properties.** This option lets you adjust the capture properties, such as **Contrast**, **Saturation**, and **Sharpness**.

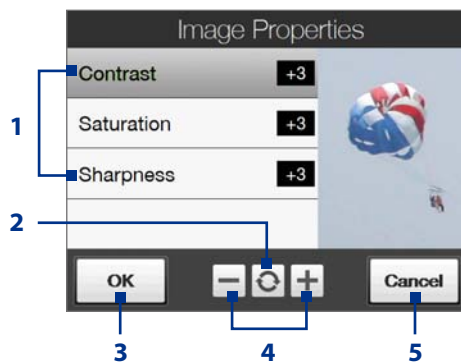

- 1 Tap a property to adjust.
- 2 Tap to reset all properties to their default values.
- 3 Tap to save the settings.
- 4 Tap **+** / **-** or press Navigation left/right (Landscape orientation) to increase/decrease the value.
- 5 Tap to close the submenu without applying and saving the changes.

- **Effect.** Choose a special effect such as Grayscale, Sepia, or others, to apply to your photos or video clips.
- **Metering Mode.** Select a metering mode to allow the camera to measure the amount of light and calculate the best-fit exposure value before capturing. Choose either **Center Area** to measure light using the center area of the subject, or **Average** to measure light using the area around the subject.
- **Prefix.** When **Default** is selected as the prefix, the file name of each new captured file is set to "IMAGE" or "VIDEO" followed by a sequential number, for example: IMAGE_001.jpg. You may also choose to name files using either the current **Date** or **Date & Time** as the prefix.
- **Counter.** To reset the file naming counter back to 1, tap **Reset**.
- **Flicker Adjustment.** When taking indoor shots, flicker on the camera screen may be caused by inconsistencies between the vertical scan rate of the camera display and the flicker frequency of fluorescent lighting. To reduce flicker, you can change the flicker adjustment setting to **Auto** or to the proper frequency (**50Hz** or **60Hz**) of the power in the country where your device is being used.
- **Grid** (Photo mode). Choose whether or not to show a grid on the Camera screen. Showing a grid helps you frame and center your subject easily and accurately.

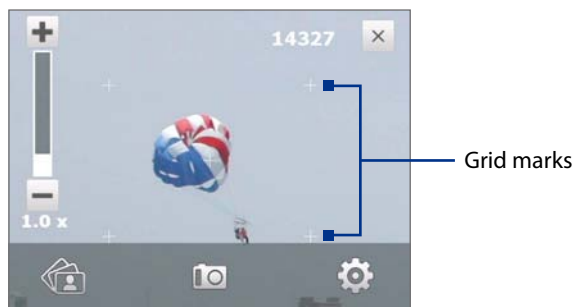

- **Record with Audio** (Video mode). Select **On** to record audio with the captured video clips, or select **Off** to capture video without audio.

- **Template** (Picture Theme mode). Select a template.
- **Recording Limit** (Video mode). Set the maximum duration or file size for recording video.
- **Template Folder** (Picture Theme mode). By default, templates are stored in the **My Documents\Templates** folder on the device's **Main Memory**. If you transferred some templates to the internal storage (via File Explorer), set this option to **Main + Card** to specify that templates are located in both the main memory and the internal storage.
- **Show Reminder** (Contacts Picture mode). Select **On** if you want the Camera to always display a message that confirms whether or not to assign the captured picture to a contact.
- **Help**. Tap to open the Camera program help file.
- **About**. Tap to display version and copyright information.

11.2 Viewing Photos and Videos Using Album

Use **Album** to view images and videos in your device. Album offers a host of features that let you rotate images, view your images as a slideshow, use images as contact pictures, and more.

Note Album can only display files in the BMP, GIF, PNG, JPG, Animated GIF, 3GP, MP4, and WMV formats.

To open Album

Do one of the following:

- On the Home screen, slide to the **Photos and Videos** tab and tap **Album**.
- In the Camera program, tap .
- Tap **Start > Programs > Album**.

Note When you open Album from the Camera program, the screen orientation of Album is switched to landscape mode.

Tap to open the Camera program.

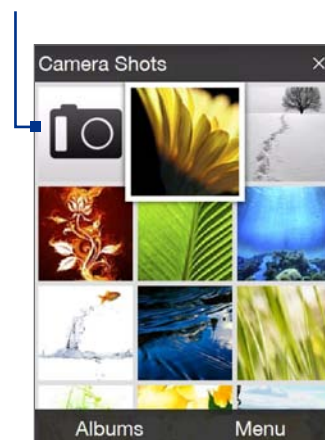

Select a photo or video to view

1. On the main Album screen, tap **Albums** and then select the album to view. The contents of the album are then displayed on the main Album screen.
2. Browse through the files by sliding your finger upward or downward.
3. Do one of the following:
 - Tap an image to view it in full screen mode. See "View an image" for details.
 - Tap a video file (files with the  icon) to play back the video file. See "Play back video" in this chapter for details.
 - Select a still image and then tap **Menu > Slideshow** to view the images in the album as a slideshow. Animated GIF and video files will not be played back in the slideshow. See "To view still images as a slideshow" in this chapter for details.

View an image

While viewing an image in full screen, tap the screen or press ENTER to open the on-screen menu.

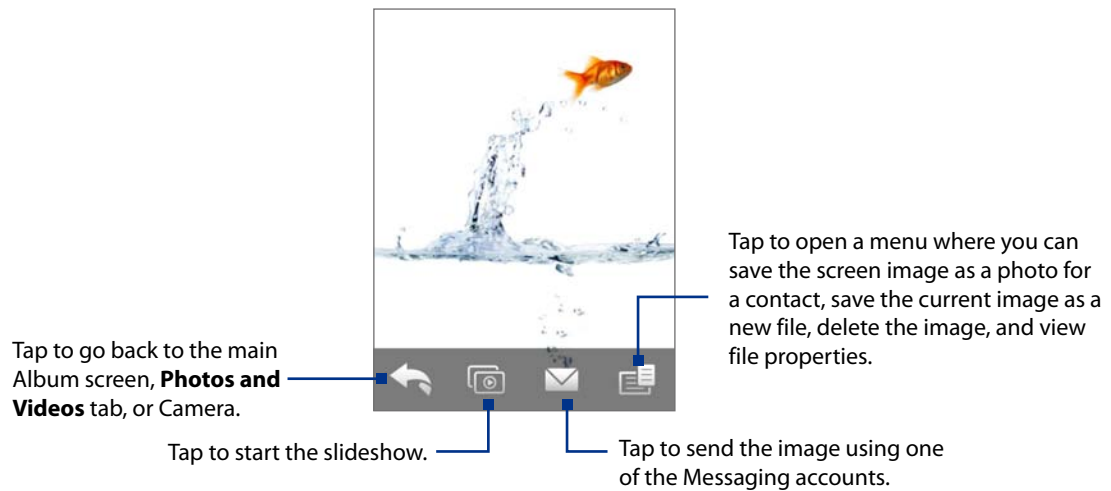

Tip You can delete multiple files at once by selecting **Menu > Delete Items** on the main Album screen and then selecting the files to delete.

To rotate the image

While viewing images, you can automatically rotate the image by simply turning your device sideways.



To view the next or previous image

When viewing images in Portrait or Landscape mode, go to the next image by swiping your finger across the screen from right to left. Go back to the previous image by swiping your finger from left to right.

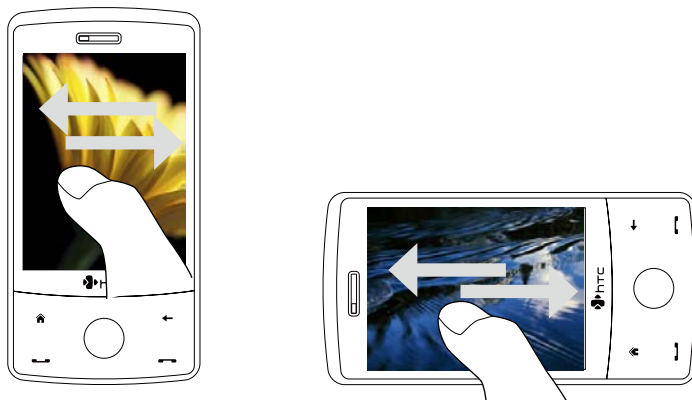

To zoom in or out of an image

While viewing an image, make a full circle motion on the screen with your finger.

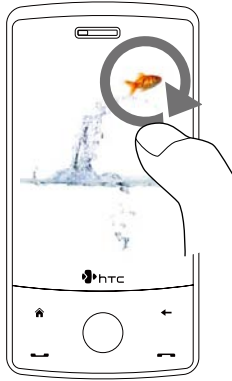

Slide your finger clockwise on an area to zoom in on that area.



Slide your finger counter-clockwise to zoom out.

- Tips**
- When you zoom in on an image, double tap the screen to automatically zoom out and fit the image to the screen.
 - When you zoom in on an image, tap and hold the screen so you can pan the image.
 - You can also zoom in and out of the image by sliding your finger around the Navigation Control clockwise/ counterclockwise.
 - When you zoom in on an image, tap the screen to open the on-screen menu. On the on-screen menu, tap  and then select **Save Screen Image** to save the image on-screen as a new file.

To view still images as a slideshow

While viewing the slideshow, tap the screen to show playback controls.

Tip The screen orientation automatically switches to landscape mode when viewing a slideshow.

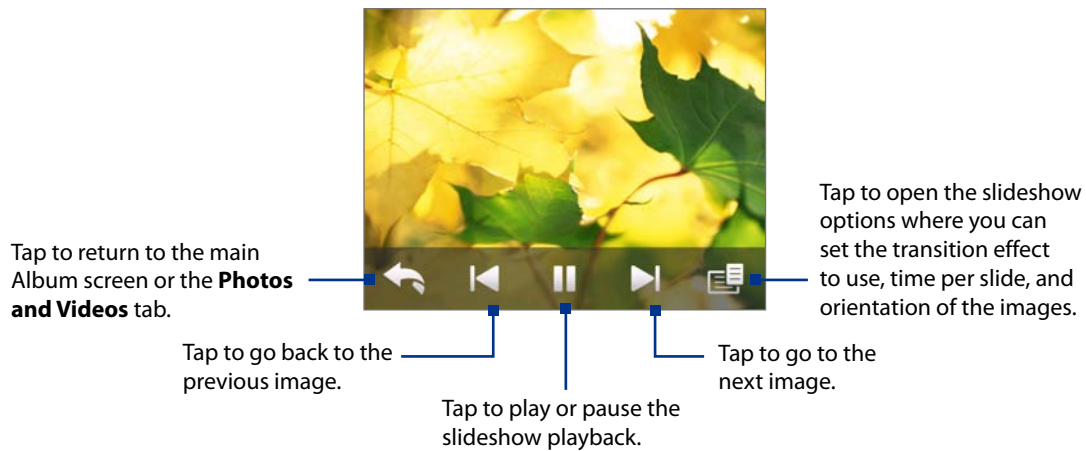

Tip If the images are in your favorite album, you can start the slideshow from the **Photos and Videos** tab on the Home screen. On the Photos and Video tab, tap **Slideshow**.



Play back video

While playing back video, tap the screen to show the playback controls.



Tip If the video is in your favorite album, you can start the video playback from the **Photos and Videos** tab on the Home screen. On the Photos and Video tab, tap **Play**.

Close Album

Close Album by tapping  on the main Album screen. When viewing files in full screen mode, tap the screen to show the on-screen menu or playback controls and then tap  to go back to the main Album screen.

11.3 Using Windows Media® Player Mobile

Windows Media® Player Mobile plays digital audio and video files that are stored on your device or on a network, such as on a Web site.

Video File Formats Supported	File Extensions
Windows Media Video	.wmv, .asf
MPEG4 Simple Profile	.mp4
H.263	.3gp, .3g2
H.264	.mp4, .3gp, .3g2, .m4v
Motion JPEG	.avi
Audio File Formats Supported	File Extensions
Windows Media Audio	.wma
WAVE	.wav
MP3	.mp3
MIDI and SP MIDI	.mid, .midi, .rmi
AMR Narrow Band	.amr, .3gp
AMR Wide Band	.awb, .3gp
AAC, AAC+, and eAAC+	.aac, .mp4, .m4a, .3gp
MPEG4 audio	.m4a
QCELP	.qcp, .3g2
EVRC	.qcp

To open Windows Media® Player Mobile

Tap **Start > Programs > Windows Media**.

About the controls

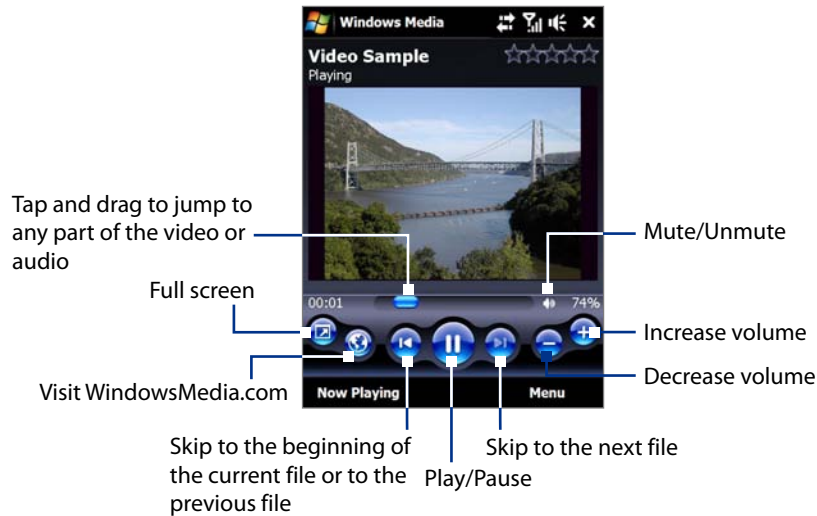

About the screens and menus

Windows Media® Player Mobile has three primary screens:

- **Playback screen.** The screen that displays the playback controls (such as Play, Pause, Next, Previous, and Volume) and the video window. You can change the appearance of this screen by choosing a different skin.
- **Now Playing screen.** The screen that displays the Now Playing playlist. This special playlist indicates the current file being played and any files that are “queued up” to play next.
- **Library screen.** The screen that lets you quickly find your audio files, video files, and playlists. It contains categories such as My Music, My Videos, My TV, and My Playlists.

At the bottom of each screen, you can open a **Menu**. The commands on this menu vary, depending on which screen you are viewing. For more information about the commands in these menus, see Help on your device.

Synchronize video and audio files

Use the latest version of Windows Media® Player on your computer to synchronize digital media files from your computer to your device. This ensures that protected files and album art (for skins) are copied to your device correctly.

To synchronize content to your device automatically

1. On your computer, open Windows Media® Player, then connect your device to your computer.
2. In the Device Setup Wizard, select **Yes, search my computer now**.
 - Note** If you have previously opened Windows Media® Player and searched for media on your computer, you will not be prompted to search your computer in Step 2.
3. On the Device Setup dialog box, enter a name for your device and click **Finish**. Windows Media starts synchronizing the music files in the PC with the device.
4. Click **Stop Sync** and then on the left panel of Windows Media® Player, right-click the name of your device and click **Set Up Sync**.
5. Select the playlist(s) that you want to sync between your computer and device, then click **Add**.
 - Note** On the Device Setup dialog box, make sure that the **Sync this device automatically** check box is selected.
6. Click **Finish**.

The files will begin synchronizing to your device. The next time you connect your device to your computer while Windows Media® Player is running, synchronization will start automatically.

To synchronize content manually to your device

1. If you have not set up media synchronization between your device and computer, follow steps 1 to 3 in “To synchronize content to your device automatically”.
2. Click the **Sync** tab on the Windows Media® Player of your computer. Select a Playlist or a Library on the left panel of the Windows Media® Player.
3. From the Content List, drag the media files that you want to sync to your device and drop them to the Sync List.

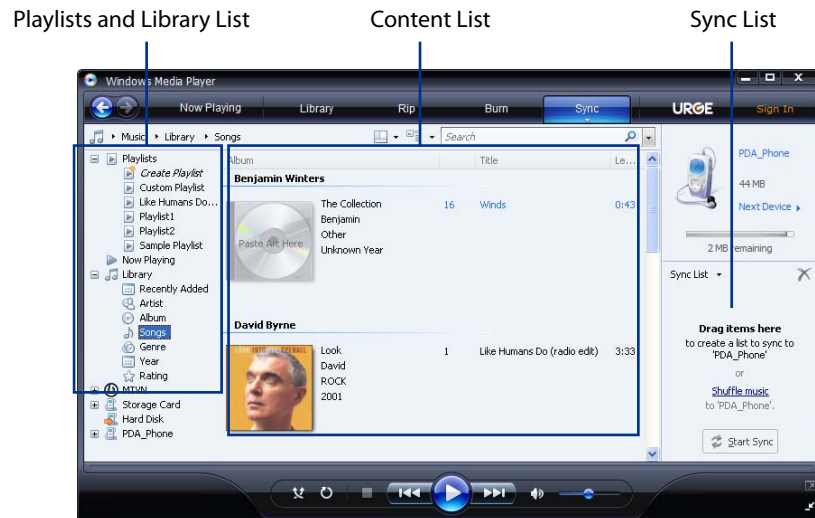

4. Click **Start Sync** to start synchronizing the selected files to your device.

- Notes**
- Use Windows Media® Player 11 or higher on your computer to synchronize media files to your device.
 - Audio files copy faster if Windows Media® Player is configured to automatically set the quality level for audio files copied to your device. For more information, see the Windows Media® Player Help.

Play media

Use the Library to find and play songs, videos, and playlists that are stored on your device or internal storage.

To update the Library

1. If you are not on the Library screen, tap **Menu > Library**.
2. On the Library screen, tap the Library arrow (near the top of the screen), then tap the media storage that you want use, for example, internal storage.
3. In most cases, Windows Media® Player Mobile automatically updates the library. However, you can manually update the library to ensure that it contains new files that you recently copied to your device or internal storage. Tap **Menu > Update Library** to manually update the library list.

To play video and audio files on your device

1. Select a category (for example, My Music or My Playlists).
2. Tap and hold the item that you want to play (such as a song, album, or artist name), then tap **Play**.

- Tips**
- To play a media file that is stored on your device but is not in a library, on the Library screen, tap **Menu > Open File**. Tap and hold the item that you want to play (such as a file or a folder), then tap **Play**.
 - To play a media file from the Internet or a network server, tap **Menu > Library** then tap **Menu > Open URL**.

Playlists

In Windows Media® Player Mobile, you can create a new playlist by saving the current Now Playing playlist and giving it a new name.

To save a new playlist

1. If you are not on the Library screen, tap **Menu > Library**.
2. Tap to select a category (for example, My Music or My Playlists).
3. Select a media file that you want, then tap **Menu > Queue Up**. This adds the file to the Now Playing list. Repeat this step until you have added all desired media files to the Now Playing list.

Note You cannot select multiple files simultaneously.

4. After adding the media files, tap **Menu > Now Playing**.
5. On the Now Playing screen, tap **Menu > Save Playlist**.
6. Enter the playlist name, then tap **Done**.
7. To play back the playlist you created, tap My Playlists in the Library, select your playlist, then tap **Play**.

Troubleshooting

If you encounter a problem while using the Windows Media® Player Mobile, a number of resources are available to help you troubleshoot the issue.

For more information, see the Troubleshooting Windows Media® Player Mobile page at the Microsoft Web site (<http://www.microsoft.com/windows/windowsmedia/player/windowsmobile/troubleshooting.aspx>).

11.4 Using Audio Booster

Audio Booster optimizes sound for a better listening experience. It provides preset moods, such as hip hop, jazz, rock, etc., and several enhancement presets that suit different types of music.

To access Audio Booster

Tap **Start > Programs > Audio Booster**.

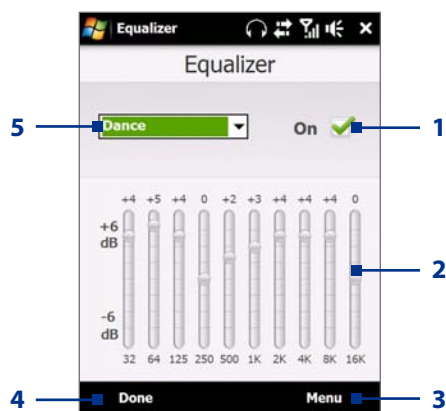

This control	Does this
1 On	Select the check box to enable or disable the equalizer.
2 Frequency band	Drag the sliders to adjust the frequency.
3 Menu	<ul style="list-style-type: none"> • Tap Menu > Cancel to exit Audio Booster without applying the modified settings. • Tap Menu > Save as Preset or Delete Preset to save or delete preset equalizer settings.
4 Done	Tap to apply the modified settings.
5 Equalizer presets	Tap to choose the Equalizer preset to use.

To use a Equalizer preset

Tap the list box then select a desired preset.

To create a custom equalizer preset

1. Adjust the frequency bands to your desired values by dragging the equalizer controls. The selected values are indicated on top of the sliders.
2. Save your equalizer settings as a preset by tapping **Menu > Save as Preset**.
3. Enter a preset name and then tap **Done**. The preset you created will be added to the list box.

To delete a custom equalizer preset

1. Tap the list box then select the Equalizer preset you want to delete.
2. Tap **Menu > Delete Preset**.

Note You can only delete custom equalizer presets. Equalizer presets that are pre-installed cannot be deleted.

11.5 Using MP3 Trimmer

Use **MP3 Trimmer** to trim MP3 files. You can choose to save it as a new file or set it as a ring tone.

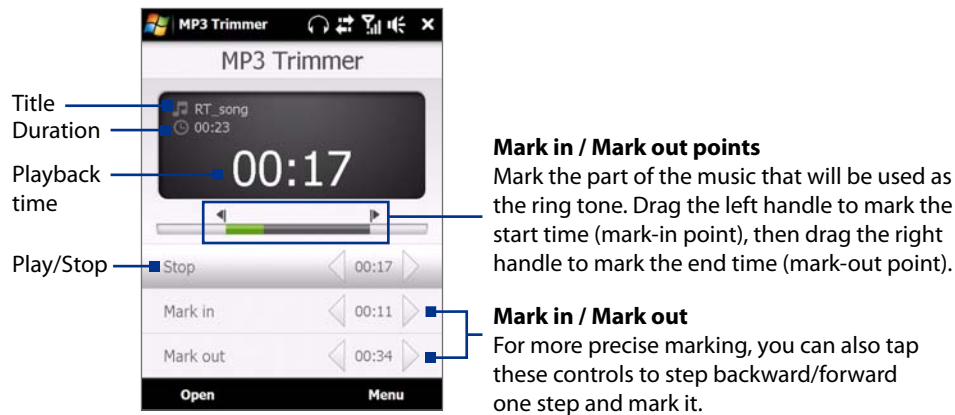

To trim the MP3 file

1. Tap **Start > Programs > MP3 Trimmer**.
2. Tap **Open** to find the MP3 file in the device.
3. On the MP3 Trimmer screen, use the stylus to adjust the **Mark in point** and **Mark out point**.
After you set the Mark in point, the song will play back starting from the Mark in point.
After you set the Mark out point, the song will play back starting from 5 seconds before the Mark out point.
4. Tap **Play** to play back the trimmed song.
5. Tap **Menu** and select to whether set the file as the default ring tone, save the file to the ring tone folder, or save it using another file name.

Tip If you only want to save the song to the ring tone folder for future use, tap **Save to Ring Tone Folder**. Later on, you can tap **Start > Settings > Personal tab > Phone** to set it as your ring tone.

Chapter 12

Programs on your Device

12.1 Programs on your Device

12.2 Adding and Removing Programs

12.3 Adobe® Reader® LE

12.4 Calendar

12.5 Contacts

12.6 Comm Manager

12.7 Microsoft® Office Mobile

12.8 Notes

12.9 Tasks











12.10 Voice Recorder

12.11 ZIP













12.1 Programs on your Device













The following are programs you can find on your device or install from the Applications disc.

Programs in the Start Menu

Icon	Description
	Office Mobile Use the complete suite of Microsoft® Office applications for your mobile device.
	Excel Mobile Create new workbooks or view and edit Excel workbooks.
	OneNote Mobile Create notes with text, photos, and voice recordings.
	PowerPoint Mobile View PowerPoint slides and presentations.
	Word Mobile Create, view, and edit Word documents.
	Calendar Keep track of your appointments and create meeting requests.
	Contacts Keep track of your friends and colleagues.
	Internet Explorer Mobile Browse Web and WAP sites as well as download new programs and files from the Internet.
	Messaging Send and receive e-mail and text messages.
	Phone Make and receive calls, switch between calls, and set up conference calling. See Chapter 2 for details.
	Help See Help topics for the current screen or program.

Programs screen

Icon	Description
	Games Play these pre-installed games: Bubble Breaker , Teeter and Solitaire .
	ActiveSync Synchronize information between your device and a PC or the Exchange Server. See Chapter 5 and 7 for details.
	Adobe Reader LE View PDF (Portable Document Format) files on your device.
	Album View photos and videos that you captured using the device camera. See Chapter 11 for details.
	Audio Booster Enhances your music experience by providing you with controls for adjusting equalizer, 3D sound, treble, and bass settings. See Chapter 11 for details.
	Bluetooth Explorer Search for other Bluetooth devices that have file sharing enabled and access their Bluetooth shared folder. See Chapter 9 for details.
	Calculator Perform basic arithmetic and calculations, such as addition, subtraction, multiplication, and division.
	Camera Take photos and shoot video clips with accompanying audio. See Chapter 11 for details.
	File Explorer Organize and manage files on your device.
	Getting Started View a list of “how to’s” that you can reference to learn basic features and settings of your device.
	Messenger This is the mobile version of Windows Live™ Messenger. See Chapter 8 for details.
	MP3 Trimmer Trim MP3 files, and choose to save the trimmed music as a new file or set it as a ring tone. See Chapter 11 for details.
	Notes Create handwritten or typed notes, drawings, and voice recordings.

Icon	Description
	Opera Mobile This is the mobile version of the Opera browser. See Chapter 8 for details.
	Pictures & Videos View, organize, and sort pictures, animated GIFs, and video files on your device.
	QuickGPS Download satellite data over the Internet via ActiveSync (if your device is connected to a computer), Wi-Fi or a data connection to speed up the time for determining your current GPS position. See Chapter 10 for details.
	RSS Hub Download and read the latest Web feeds from the Internet. See Chapter 8 for details.
	Search Search contacts, data, and other information on your device.
	Tasks Keep track of your tasks.
	TELUS mobile email Provide you with automatic updates to your e-mail, calendar, contacts, and task.
	Voice Recorder Record your voice and send it via e-mail or beaming. You can also set the recorded voice as your ring tone.
	Windows Live Use this mobile version of Windows Live™ to find information on the Web. It also lets you sign into your Windows Live account so that you can access your Live Mail messages and send/receive instant messages in Live Messenger. See Chapter 8 for details.
	Windows Media Player Mobile Play back audio and video files. See Chapter 11 for details.
	WModem Connect your notebook computer to the Internet using your device's data connection.
	YouTube™ Search for uploaded videos in YouTube and play them on your device. See Chapter 8 for details.
	ZIP Save memory and free up storage space on your device by compressing files in the conventional ZIP format.

12.2 Adding and Removing Programs

Additional programs, such as the programs in the Applications disc or other programs that you purchase, can be installed and uninstalled on your device. Your device does not allow you to uninstall most of the preinstalled programs.

Note Before you purchase additional programs for your device, make sure that they are compatible with your device.

To install a program

1. Download the program to your computer (or insert the CD or disk that contains the program into your computer).
You may see a single *.exe file, a *.zip file, a **Setup.exe** file, or several versions of files for different device types and processors. Be sure to select only the programs designed for your device.
2. Read any installation instructions or documentation that comes with the program. Many programs provide special installation instructions.
3. Connect your device to the computer.
4. Double-click the installation setup file.

To uninstall a program

1. Tap **Start > Settings > System tab > Remove Programs**.
2. In the **Programs in storage memory** list, select the program you want to remove, then tap **Remove**.

12.3 Adobe® Reader® LE

Adobe® Reader® LE is an application for viewing PDF (Portable Document Format) documents on your device. It supports a subset of the features found in the PC versions of Adobe Reader.

To open Adobe Reader LE

Tap **Start > Programs > Adobe Reader LE**.

To open a PDF file on your device







- Open a PDF file in Adobe Reader LE; or
- Open File Explorer, find the PDF file, then tap the file to open it.

To navigate through a PDF document

You can use the controls in the program and finger gestures to navigate a PDF document.

- Tap **Tools > View > Continuous** and then slide your finger up or down the screen to scroll through the pages in the document.

Tip You can also drag the scroll bars to scroll through the pages.

- Tap  to zoom in or  to zoom out. After zooming in, slide your finger on the screen to pan the current page.
- Press Navigation up/down/right/left to move to the desired direction of the page.
- Tap  to return to the previous page; tap  to move to the next page. Tap  to jump to the first page; tap  to jump to the last page.
- Tap **Tools > Go To > Page Number** to enter a page number that you want to view.

To search for text in the document

1. Tap **Tools > Find > Text** or tap  in the toolbar.
2. Type in the text to be searched, then tap **Find**. The matched text in the document will be highlighted.
3. To view the next occurrence of the text, tap **Tools > Find > Next**.

- Tips**
- Adobe Reader LE displays a bookmark pane for the PDF files that contain bookmarks. Tap the bookmarks to go to a specific section/page within the file.
 - Adobe Reader LE supports password-protected PDF files with up to 128-bit encryption. When you open a password-protected PDF file, you will be prompted to enter the password before opening it.

12.4 Calendar

Use **Calendar** to create appointments, including meetings and other events. You can also synchronize Calendar appointments between your device and computer.

To open the Calendar screen

- On the TouchFLO 3D Home screen, tap **Calendar** or a displayed appointment; or
- Tap **Start > Calendar**.

Create appointments

To schedule an appointment

1. Open the Calendar screen and then tap **Menu > New Appointment**.
2. Enter a name for the appointment.
3. Do one of the following:
 - If it is a special occasion such as a birthday or a whole-day event, set the **All Day** option to **Yes**.
 - If there is a time frame for the appointment, set the start and end dates and times.
4. Specify the type of category for your appointment, so that it can be grouped with other related appointments. Tap **Categories**, then select a preset category (Business, Holiday, Personal, or Seasonal), or tap **New** to create your own category.

5. When finished, tap **OK** to return to the calendar.

- Notes**
- All-day events do not occupy blocks of time in Calendar; instead, they appear in banners at the top of the calendar.
 - To remove an appointment, tap **Menu > Delete Appointment**.

Tip To have the time entered automatically in Day view, tap and drag to select a time slot for the new appointment, and tap **Menu > New Appointment**.

To set the reminder time for new appointments

By default, Calendar has been set to display a reminder alert when you have new upcoming appointments. You can change the reminder time.



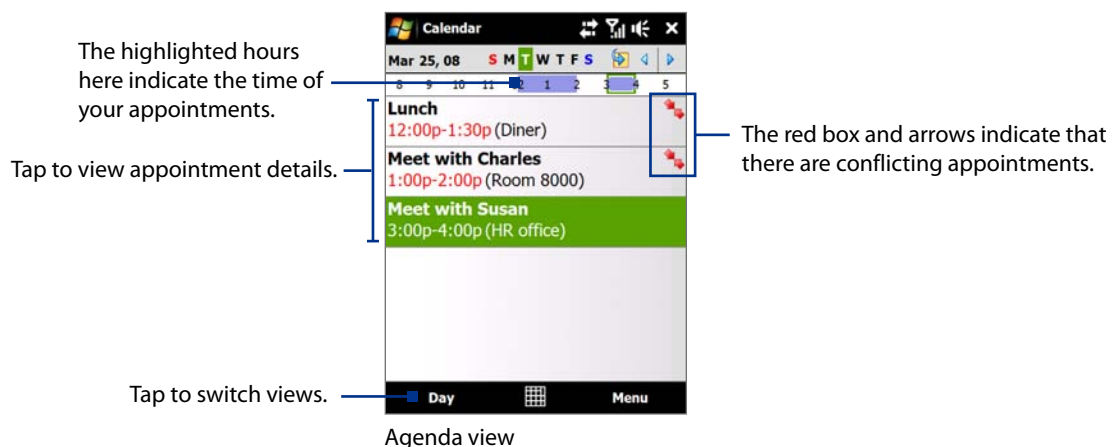

1. Open the Calendar screen.
2. Tap **Menu > Tools > Options > Appointments** tab.
3. Make sure the **Set reminders for new items** check box is selected.
4. Set the time when you want the reminder to alert you.
5. Tap **OK** to return to the Calendar screen.

View appointments

By default, Calendar displays appointments in **Agenda** view. You can also look at your appointments in **Day**, **Week**, **Month**, and **Year** views.



- To see detailed appointment information in any view, tap the appointment.
- To view appointments by category, tap **Menu > Filter**, then select the desired category.
- To change the default view that Calendar uses to display appointments, tap **Menu > Tools > Options > General** tab. Tap the **Start in** box, then choose the calendar view.
- When in Month view, you will see the following indicators:

	Morning appointment		Afternoon or evening appointment
	All-day event		Both morning and afternoon/evening appointments

Send appointments

To send a meeting request

Use Calendar to schedule meetings via e-mail with contacts who use Outlook or Outlook Mobile.

1. Open the Calendar screen.
2. Schedule a new appointment, or open an existing one and tap **Menu > Edit**.
3. Tap **Attendees**, then tap **Add Required Attendee** or **Add Optional Attendee** and add the contacts whom you want to invite.

Note You can specify if an attendee is required or optional only if your device is connected to a Microsoft Exchange 2007 server. Otherwise, all attendees are designated as required. For more information, see "Managing Meeting Requests" in Chapter 7.

4. When you have finished adding attendees, tap **Done**.
5. Tap **OK** to send.

Tip To choose the e-mail account to use for sending meeting requests, tap **Menu > Tools > Options > Appointments** tab. Tap the **Send meeting requests via** box and choose to send via your Outlook E-mail, POP3/IMAP4 or Windows Live™ account.

- Notes**
- If you're sending the meeting request using your Outlook E-mail account, it will be sent to the attendees the next time you synchronize your device with your computer or Exchange Server.
 - When attendees accept your meeting request, the meeting is automatically added to their schedules. When their response is sent back to you, your calendar is updated as well.

12.5 Contacts

Contacts is your address book and information storage for people and businesses you communicate with. You can add the following types of contacts to your device:

- **Outlook contacts.** Contacts that are stored on your device, which can be created on your device or synchronized with your PC or the Exchange Server.
- **Windows Live™ contacts.** Contacts that you communicate with using Windows Live™ Messenger or MSN.

Note You can only add Windows Live™ contacts after you have set up Windows Live™ on your device. See "Add Windows Live contacts" in Chapter 8 for details.

To open the Contacts screen

- On the TouchFLO 3D Home screen, slide to the **People** tab and then tap **All People**; or
- Tap **Start > Contacts**.

Add new contacts

To add a contact on your device

1. Open the Contacts screen.
2. Tap **New**, select **Outlook Contact**, and enter the contact information.
3. In the **File as** field, choose how you want the contact name to appear in the contact list.
4. To add a photo of the contact, tap **Select a picture**, and then select the picture file or tap **Camera** to take a photo of the contact.
5. To assign a ring tone to the contact, tap the **Ring tone** field, scroll through the list of tones, then select a desired tone.
6. When finished, tap **OK**.

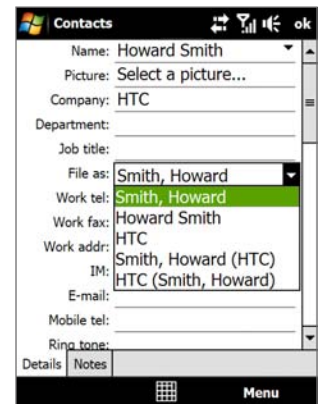

- Tips**
- If a person who is not in your list of contacts called you and you want to save that person's phone number, tap and hold the phone number in the Call History and then tap **Save to Contacts** from the shortcut menu.
 - To save a phone number that is contained in a message, open the message, tap the underlined phone number, and then tap **Menu > Save to Contacts**.
 - To edit contact information, tap the contact name and then tap **Menu > Edit**.

Organize and search contacts

To group similar contacts

For easier management, you can group similar contacts by assigning them to categories.

1. Create a new Outlook contact or edit an existing Outlook contact.
2. Tap **Categories**.
3. Select a preset category such as Business or Personal, or tap **New** to create your own category.
4. When finished, tap **OK**.

To find a contact on your device

There are several ways to find a contact when your contact list is long:

- Begin entering a contact name in the provided text box until the contact you want is displayed.
- On the Quick Scroll bar on the right of the Contacts screen, scroll to or tap a letter to go directly to the part of the contacts list where contact names start with that letter.

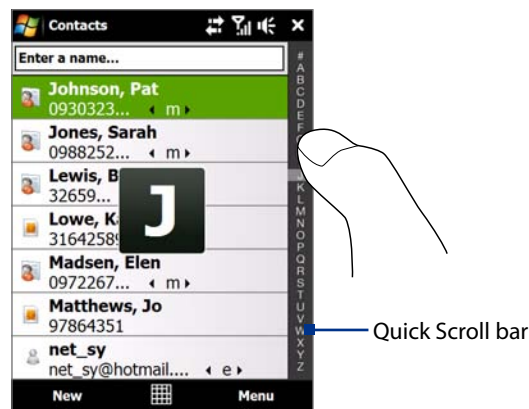

Note You can disable the Quick Scroll bar by tapping **Menu > Options** and selecting the **Show alphabetical index** check box. This will show the alphabetical index at the top of the Contacts list.

- Filter the list by categories. In the contact list, tap **Menu > Filter**, then tap a category you've assigned to a contact. To show all contacts again, select **Menu > Filter > All Contacts**.

Share contact information

To beam a contact's details

You can quickly send contact information to another mobile phone or device through Bluetooth beaming.

1. On the Contacts screen, select a contact.
2. Tap **Menu > Send Contact > Beam**, then select a device where to beam the contact to.

Note Before beaming, make sure Bluetooth is turned on and set to visible mode on your device and the target mobile device. You can also beam contact information to your computer. See Chapter 9 for details.

12.6 Comm Manager

Comm Manager is a central location where you can easily turn on and off the communication features of your device such as the phone, Wi-Fi, data connection, Bluetooth, and more.

To access the Comm Manager

Do one of the following:

- On the TouchFLO 3D Home screen, slide to the **Settings** tab and then touch **Communications**.
- Touch **Start > Settings > Connections** tab > **Comm Manager**.



- 1 Switch Airplane Mode on or off. Turning on Airplane Mode turns off the phone, Wi-Fi and Bluetooth functions. For more information, see "To enable or disable Airplane Mode" in Chapter 2.
- 2 Switch the phone on or off. Tap **Settings > Phone** to set the ring tone and other phone settings. See Chapter 13 for details.
- 3 Switch Bluetooth on or off. Tap **Settings > Bluetooth** to configure Bluetooth on your device. See Chapter 9 for details.
- 4 Switch Wi-Fi on or off. Tap **Settings > Wireless LAN** to configure wireless network connection settings. See Chapter 8 for details.
- 5 Switch between automatically receiving (as items arrive) or manually retrieving Outlook e-mails. See Chapter 7 for details.
- 6 Disconnect active data connections. You cannot reconnect a data connection in Comm Manager.

12.7 Microsoft® Office Mobile

Microsoft® Office Mobile consists of the following applications:

- **Microsoft® Office Excel® Mobile** lets you create and edit Excel workbooks and templates on your device.
- **Microsoft® Office OneNote® Mobile** lets you create notes with text, photos, and voice recordings for synchronization later with Microsoft® Office OneNote® 2007 on your computer.
- **Microsoft® Office PowerPoint® Mobile** allows you to view (not create) slide show presentations in *.ppt and *.pps formats.
- **Microsoft® Office Word Mobile** lets you create and edit documents and templates in Word Mobile and save them as *.doc, *.rtf, *.txt, and *.dot files.

To use Microsoft Office Mobile

1. Tap **Start > Office Mobile**.
2. Tap the Office Mobile application that you want to use.

When working with Word Mobile and Excel Mobile files, you can use the Navigation Control on your device for zooming:

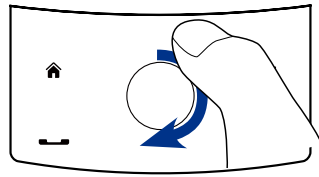

To zoom in, slide your finger clockwise around the Navigation Control.

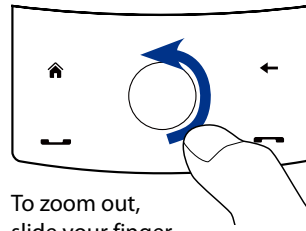

To zoom out, slide your finger counterclockwise around the Navigation Control.

Word Mobile and Excel Mobile do not fully support some features of Microsoft® Office Word and Microsoft® Office Excel®. To see a complete list of features that are not supported in Word Mobile and Excel Mobile, see Help on your device.

- Tips**
- By default, Word Mobile saves documents in **.docx** format, while Excel Mobile saves workbooks in **.xlsx** format. If you want to open these types of files on a computer that uses Microsoft Office 2000, Office XP, or Office 2003, you need to download and install the **File Format Converter** in your computer. You can find this converter at <http://www.microsoft.com/downloads/details.aspx?FamilyId=941B3470-3AE9-4AEE-8F43-C6BB74CD1466&displaylang=en>.
 - If you want Word Mobile to save documents in **.doc** format, tap **Menu > Tools > Options** (or **Menu > Options** when no document is opened), then change the **Default template** to **Word 97-2003 Document (.doc)**.
 - If you want Excel Mobile to save workbooks in a format that is compatible with Microsoft Office 2000, Office XP, or Office 2003, tap **Menu > Options** (with no workbook opened), then change the **Template for new workbook** to **Blank 97-2003 Workbook**.

12.8 Notes

Using **Notes**, you can create handwritten and typed notes, record voice notes, convert handwritten notes to text for easy readability, and more.

To create a note

1. Tap **Start > Programs > Notes**. In the note list, tap **New**.
2. Choose an input method and then enter your text.

Tip For more information about input methods and entering text, see Chapter 4.

3. When finished, tap **OK** to save and return to the note list.

- Notes**
- To select handwritten text, tap and hold next to the writing. As soon as dots appear, and before they form a complete circle, quickly drag across the writing.
 - If a letter crosses three ruled lines, it is treated as a drawing rather than text.

To draw in a note

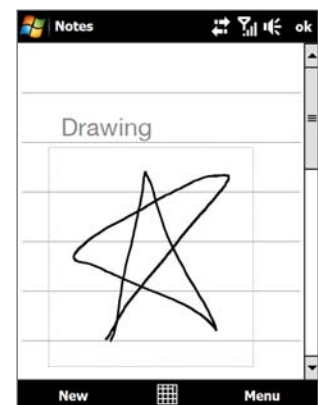

1. Create or open a note file.
2. Use the stylus to draw on the screen. A selection box then appears around your drawing.
3. Tap **OK** to save.

Note To select a drawing (for example, to copy or delete it), tap and hold the drawing briefly. When you lift the stylus, the drawing is selected.



To record a voice note

You can create a stand-alone recording (voice note) or you can add a recording to a note.

1. Tap **Start > Programs > Notes**.
2. If you do not see the Recording toolbar, tap **Menu > View Recording Toolbar**.
3. Do one of the following:
 - To add a recording to a note, create or open a note.
 - To create a stand-alone recording, record from the note list.
4. Tap the **Record** icon () to begin recording your voice. Tap the **Stop** icon () when you are finished recording.

Tip To select the voice recording format, return to the note list and then tap **Menu > Options > Global Input Options** link (at the bottom of the Options screen). On the Input screen, tap the **Options** tab and choose the desired format from the **Voice recording format** list.

12.9 Tasks

Use **Tasks** to keep track of things you need to do. A task can occur once or repeatedly (recurring).

Your tasks are displayed in a task list. Overdue tasks are displayed in red. A reminder will be displayed when you have new tasks to be completed.

To create a task

1. Tap **Start > Programs > Tasks**.
2. Tap **Menu > New Task**, enter a subject for the task, and fill in information such as start and due dates, priority, and so on.
3. Specify the type of category for your task, so that it can be grouped with other related tasks. Tap **Categories**, then select a preset category (Business, Holiday, Personal, or Seasonal), or tap **New** to create your own category.
4. When finished, tap **OK**.

To change the priority of a task

Before you can sort tasks by priority, you need to specify a priority level for each task.

1. Tap **Start > Programs > Tasks**.
2. Tap the task you want to change the priority for.
3. Tap **Edit**, and tap a priority level in the **Priority** box.
4. Tap **OK** to return to the task list.

Note All new tasks are assigned a Normal priority by default.

To show start and due dates in the task list



1. Tap **Start > Programs > Tasks**.
2. Tap **Menu > Options**.
3. Select the **Show start and due dates** check box, then tap **OK**.

12.10 Voice Recorder

Voice Recorder lets you record your voice and quickly send it as e-mail attachment, beam it via Bluetooth, or set the recorded voice as your ring tone.

Note Voice Recorder saves voice recordings in AMR-NB (Adaptive Multi-Rate Narrowband) format only. This is a common speech audio format used in mobile devices.

To record your voice

1. Tap **Start > Programs > Voice Recorder**.
2. Hold the device's microphone close to your mouth.
3. Touch **Record** or  to start recording. Tap **Stop** or  to end the recording.

To select or create a folder where to save voice recordings

By default, all recordings are saved in the **My Voices** folder of the internal storage. You can choose another folder or create a new folder to save your voice recordings.

1. Tap the arrow beside the folder name on the top-left of the screen.
2. In the menu that opens, choose an existing folder or touch **Add/Delete** to create a new folder.

To play back a voice recording

On the Voice Recorder screen, touch a voice recording, or navigate to a voice recording and then tap **Play** ().

Tip If you need to adjust the sound volume, touch any of the status icons on the title bar and then touch the **Volume** icon () to open the System Volume screen where you can adjust the volume.

To send a voice recording via e-mail

Select a voice recording, tap **Menu > Send**, and then select an e-mail account. This creates a new e-mail message with the voice recording inserted as a file attachment.

See "Using E-mail" in Chapter 6 to learn how to send e-mails.

To beam a voice recording via Bluetooth

1. Select the voice recording you want to beam, then tap **Menu > Beam File**.

Tip To select multiple recordings, tap and drag over the desired recordings or tap **Menu > Select All**.
2. Tap the device you want to send the voice recording to.
3. On the other device, accept the file transfer to receive the file.

To set a voice recording as ring tone

Select the voice recording, then tap **Menu > Set as Ringtone**.

To rename or move a recording

1. Select the voice recording, then tap **Menu > Rename/Move**.

Tip To select multiple recordings, tap and drag over the desired recordings or tap **Menu > Select All**. Note that you can move multiple files, but you cannot rename multiple files simultaneously.
2. In **Name**, enter the new voice recording name.
3. To move the voice recording, select the new destination **Folder** and **Location**.
4. Tap **OK**.

12.11 ZIP

The **ZIP** program increases the storage capacity of your device by allowing you to compress files in the conventional ZIP format. It also allows you to extract files from a zip file.

To start ZIP on your device

Tap **Start > Programs > Zip**.

Each time you start ZIP, it searches for files that have the .zip file extension, and displays these files on the Archive List screen.

To open a ZIP file and extract files

1. Touch a zip file to open it, or navigate to a zip file and then touch **File > Open Archive**.

Note You cannot select multiple ZIP files.
2. From the zip file, select files by doing one of the following:
 - Touch a file to select it.
 - To select several files, touch **Menu > Action** and make sure **Multi-Select Mode** is selected. Select files by touching each file. (Touch a selected file to deselect it).
 - To select all files, touch **Menu > Action > Select All**.
3. Touch **Menu > Action > Extract**.
4. Choose a folder where the files will be extracted to, then touch **Extract**.
5. Touch **Menu > File > Close Archive** to close the zip file.

To create a new zip archive

1. Touch **File > New Archive**.
2. On the Save As screen, enter the zip file name and choose a folder where you want to save it. You can also choose whether to save the zip file on the device's main memory or internal storage.
3. Touch **Save**.
4. Touch **Menu > Action > Add**.
5. Navigate to the folder that contains the files you want to archive.
6. Select files to add by doing one of the following:
 - Touch a file to select it.
 - To select several consecutive files, drag over the files.
 - To select several non-contiguous files, use the stylus to tap and hold on the screen and then select **Multi-Select Mode**. Select files by tapping each file. (Tap a selected file to deselect it).
 - To select all files, use the stylus to tap and hold on the screen and then tap **Select All**.
7. Touch **Add**.
8. Touch **Menu > File > Close Archive** to save and close the zip file.

Chapter 13

Managing Your Device

13.1 Copying and Managing Files

13.2 Settings on your Device

13.3 Changing Basic Settings

13.4 Using Task Manager

13.5 Protecting Your Device

13.6 Managing Memory

13.7 Resetting Your Device

13.8 Windows Update

13.9 Battery Saving Tips

13.1 Copying and Managing Files

You can copy files between your device and computer, or copy files to the internal storage of your device. You can also efficiently manage your files and folders using File Explorer.

To copy files using Windows Mobile Device Center or ActiveSync

1. Connect your device to the computer.
2. Click **File Management > Browse the contents of your device** in Windows Mobile Device Center on your computer, or click **Explore** in ActiveSync on your computer. This opens Windows Explorer on your computer and displays the contents of your device.
3. To copy a file from your device to your computer:
 - a. Browse the contents of your device, right-click the file you want to copy, then click **Copy**.
 - b. Right-click a folder on your computer, then click **Paste**.
4. To copy a file from your computer to your device:
 - a. Browse the folders on your computer, right-click the file you want to copy, then click **Copy**.
 - b. Right-click a folder on your device, then click **Paste**.

To manage files on your device using File Explorer

File Explorer lets you browse and manage the contents of your device. The root folder on the device is named **My Device**, and contains the following folders: My Documents, Program Files, Windows, and more.

1. Tap **Start > Programs > File Explorer**.
2. Tap a folder or file to open it.
3. To return to an upper level folder, tap **Up** and select the folder.
4. To quickly delete, rename, or copy a file, tap and hold the file, then choose the desired operation on the shortcut menu. To copy or delete multiple files, tap and drag over the desired files to select, tap and hold the selection, then choose the desired operation on the shortcut menu.

To copy files to the internal storage

1. Tap **Start > Programs > File Explorer** and navigate to the appropriate folder.
2. Tap and hold the file you want to copy, then tap **Copy**.
3. Tap the down arrow (▼), then tap **Internal Storage** in the list.
4. Tap and hold an empty area on the screen and then select **Paste** on the menu.

Tip You can configure programs such as Word Mobile and Excel Mobile to directly save edited files onto the internal storage. In the program's file list, tap **Menu > Options**, then select the **Internal Storage** in the **Save to** box.









To format the internal storage

To learn how to format the internal storage, see "Clear Storage" in this chapter.













13.2 Settings on Your Device









You can adjust the device settings to suit the way you work. To see all available settings, slide to the **Settings** tab on the Home screen and tap **All Settings**.

Personal tab









Icon	Description
	Buttons Assign a program or function to a hardware button.
	Input Set options for each of the input methods.
	Lock Set a password for your device.
	Menus Set which programs will appear in the Start menu.
	Owner Information Enter your personal information on your device.
	Phone Customize phone settings such as ring tone, and more.
	Sounds & Notifications Enable sounds for events, notifications, and more, and set the type of notification for different events.
	Today Customize the appearance and the information to be displayed on the Home screen.
	Voice Command Choose which functions you want to access by speaking out voice commands.

System tab

Icon	Description
	About This is where you can see basic information such as the Windows Mobile® version and type of processor used on your device. You can also specify a name for your device.
	Certificates See information about certificates that are installed on your device.
	Clear Storage Reset your device to factory default settings and/or format the internal storage.
	Clock & Alarms Set the device clock to the date and time of your locale or to a visiting time zone when you're traveling. Alarms can also be set at specified days and times of a week.
	Customer Feedback Send feedback to the Customer Experience Improvement Program of Microsoft.
	Device Information See information about the firmware version, hardware, identity, and the duration of calls made on your device.
	Error Reporting Enable or disable the device's error reporting function. When this function is enabled and a program error occurs, technical data about the state of the program and your computer will be logged in a text file and delivered to Microsoft's technical support if you choose to send it.
	External GPS Set the appropriate GPS communication ports, if required. You may need to do this when there are programs on your device that access GPS data or you have connected a GPS receiver to your device. See Help for details.
	Key Lock Lock the buttons on your device except for the POWER button when the device is in Sleep mode. This ensures you will not switch the device on by accident and consume unnecessary power.
	Long Press End Key Choose the desired function to be executed (for instance, lock the device) when pressing and holding the END key.
	Managed Programs Displays the programs that were installed on your device using System Center Mobile Device Manager.
	Memory Check the device memory allocation status and internal storage information. You can also stop currently running programs.
	Microphone AGC Adjust the volume of your voice automatically when you are recording.

Icon	Description
	Power Check the remaining battery power. You can also set the brightness of the backlight and timeout for turning off the display (switching device to Sleep mode) to conserve battery power.
	Regional Settings Set the regional configuration to use, including the format for displaying numbers, currency, date, and time on your device.
	Remove Programs Remove programs that you installed on your device.
	Screen Re-calibrate the screen, apply ClearType, and change the screen text size.
	Task Manager Stop running programs and set the () button to end programs immediately when you tap the button. For more information, see "Using Task Manager" in this chapter.
	TouchFLO You can enable or mute the finger scrolling and panning sound. You can also enable or disable the large Start menu, and choose to show or hide the System Status screen when title bar icons are tapped.
	Windows Update Link to Microsoft's Web site and update Windows Mobile® on your device with the latest security patches or fixes, if they are available.

Connections tab

Icon	Description
	Beam Set your device to receive incoming Bluetooth beams.
	Bluetooth Turn Bluetooth on, set your device to visible mode, and scan for other Bluetooth devices.
	Comm Manager Manage your device's connections (including data connection and Bluetooth), turn the phone on or off, and enable or disable the Direct Push function.
	Connections Set up one or more types of modem connections for your device, such as phone dial-up, and more, so that your device can connect to the Internet or a private local network.
	Domain Enroll Enroll your device in your company's domain to let System Center Mobile Device Manager to manage the device. Please ask your Server Administrator for more details.
	USB to PC Set the type of USB connection to your PC. Select the ActiveSync option for synchronising data, or use Disk Drive mode for transferring files.
	Wi-Fi Scan for available wireless networks.
	Wireless LAN See information about the active wireless network, and customize Wi-Fi settings.

13.3 Changing Basic Settings

Date and time

To set the date and time

1. On the Home screen **Home** tab, tap the time display and then tap the **Time** tab.

Tip Tap the **More** tab and select the **Display the clock on the title bar in all programs** option to show the clock on all screens.

2. Select the correct time zone and change the date or time.

Note During synchronization, the time on your device is updated with the time on your computer.

To set the date and time for a different location

If you visit or communicate with someone in a particular time zone often, you can select it as your visiting time zone.

1. On the Home screen **Home** tab, tap the time display and then tap the **Time** tab.
2. Tap **Visiting**.
3. Select the correct time zone and change the date or time.

Regional settings

The style in which numbers, currency, dates, and times are displayed is specified in regional settings.

1. On the Home screen, slide to the **Settings** tab and then tap **All Settings**.
2. On the **System** tab, tap **Regional Settings > Region** tab and then select your region from the list. The region you select determines which options will be available on the other tabs.

Note This does not change the language of your device's operating system.

3. To customize regional settings further, tap the appropriate tabs and set the desired options.

Display settings

To adjust the screen brightness

1. On the Home screen, slide to the **Settings** tab and then tap **All Settings**.
2. On the **System** tab, tap **Power > Backlight** tab.
3. Adjust the brightness by dragging the slider under **On battery power** and **On external power**.

To set the backlight to dim after a time delay

1. On the Home screen, slide to the **Settings** tab and then tap **All Settings**.
2. On the **System** tab, tap **Power > Advanced** tab.
3. In **On battery power** and **On external power**, select the **Turn off backlight if device is not used for** check box, then specify the time delay.

To increase or decrease the size of text on the screen

1. On the Home screen, slide to the **Settings** tab and then tap **All Settings**.
2. On the **System** tab, tap **Screen > Text Size** tab.
3. Move the slider to increase or decrease the text size.

Device name

The device name is used to identify your device in the following situations:

- Synchronizing with a computer
- Connecting to a network
- Restoring information from a backup

Note If you synchronize multiple devices with the same computer, each device must have a unique name.

To change the device name

1. On the Home screen, slide to the **Settings** tab and then tap **All Settings**.
2. On the **System** tab, tap **About > Device ID** tab.
3. Enter the device name.

Notes

- The device name must begin with a letter, consist of letters from **A** to **Z**, numbers from **0** to **9**, and cannot contain spaces. Use the underscore character to separate words.
- If you enroll your device to your company's domain, the device name will be changed to be the same as the one used to enroll the device.

Ringer settings

To change the ring type and ring tone

1. On the Home screen, slide to the **Settings** tab and then tap **Sound**.
2. Scroll down and then tap **Ring Type**. Select the Ring Type you want to use and then tap **Done**.
3. Tap **Ringtone** and then select the ringtone you want to use.
4. Tap **Done**.

- Tips**
- You can use *.wav, *.mid, *.mp3, *.wma, or other types of sound files that you downloaded from the Internet or copied from your computer as ring tones. For a complete list of supported audio file formats for ring tones, see "Specifications" in the Appendix.
 - To use your sound files as ring tones, copy them first to the **/My Documents/My Ringtones** folder on your device, then select the sound from the **Ring tone** list of your device. For more information about copying files, see "Copying and Managing Files" in this chapter.

Alarms and notifications

To set an alarm

1. On the Home screen **Home** tab, tap the time display and then tap the **Alarms** tab.
2. Tap **<Description>** and enter a name for the alarm.
3. Tap the day of the week for the alarm. Select multiple days by tapping each desired day. Tap again to deselect the day.
4. Tap the time to open a clock and set the time for the alarm.

Tip You can drag the hour and minute hands of the clock to set the time.
5. Tap the alarm icon () to specify the type of alarm you want. You can choose a flashing light, a single sound, a repeating sound, or vibration.
6. If you choose to play a sound, tap the list next to the **Play sound** check box and tap the sound you want.

To choose how to be notified about events or actions

1. On the Home screen, slide to the **Settings** tab and then tap **Sound > Advanced**.
2. On the **Sounds** tab, choose how you want to be notified by selecting the appropriate check boxes.
3. On the **Notifications** tab, in **Event**, tap an event name and choose how you want to be notified by selecting the appropriate check boxes. You can choose from several options, such as a special sound, a message, or a flashing light.

Tip Turning off sounds and flashing light notifications helps conserve battery power.

Phone services

Your device can directly link to the mobile phone network, and enable you to access and change the settings of various phone services for your device. Contact your wireless service provider to find out about the availability of phone services for your device.

To access and change settings of phone services

1. On the Home screen, slide to the **Settings** tab and then tap **All Settings**.
2. On the **Personal** tab, tap **Phone > Services** tab.
3. Select the service you want to use, then tap **Get Settings**.
4. Choose your desired options, then tap **OK**.

The following are some of the optional phone services that you may find on your device. For more information about customizing settings of phone services, see Help on your device.

Phone Services	Usage
Location Setting	Allow the mobile phone network to detect your current location via your device's built-in GPS chip. This is especially useful in times of emergency.
Network Service	Choose whether to restrict your device to phone calls from your home network only.
TTY Mode	Allow the use of a TTY (teletypewriter) device with the device for users who are visually or hearing impaired.
Time Synchronization	Choose whether or not to synchronize the time on your device with the mobile network.
Plus Code Dialing	This allows easy dialing when making international calls. For more information, see "To customize plus code dialing".

To customize plus code dialing

You can customize how phone numbers that begin with a plus “+” sign will be dialed.

1. Tap **Start > Settings > Personal tab > Phone > Services tab**.
2. Select **Plus Code Dialing**, then tap **Get Settings**. The following screen then appears:
3. To place local and international calls from the United States, select **Enable**.

When you place calls, the “+” sign at the beginning of phone numbers that you dial will be replaced as follows:

- When you enter a long distance phone number that starts with “+1”, the “+” will be removed and the rest of the number will be dialed. For example, if you entered +1 416 123 4567, the number to be dialed will be 14161234567.
 - When you enter an international phone number that starts with a “+” followed by a digit other than 1, the “+” will be replaced with the United States international dialing code, which is already set by default. For example, if you entered +58 212 123 4567, the number to be dialed will be 011582121234567.
4. To place calls to the United States from another country, select **Disable** and change the **International dialing code** to the one used by the country where you are in.
So when you dial a phone number that starts with “+” followed by any digit (0 - 9), the “+” will be replaced with the international dialing code of the country where you are in.

Tip If you modified the international dialing code, you can tap **Reset** to change it back to the default.

13.4 Using Task Manager

Task Manager lets you view and stop running programs, configure the  button, and enable the Quick Menu on the Home screen.

To open Task Manager

- Tap the **Quick Menu** button on the top right corner of the Home screen to open the Quick Menu, then tap .
- On the Home screen, slide to the **Settings** tab and then tap **All Settings**. On the **System** tab, tap **Task Manager**.

To switch back to a running program



- Tap the program name in the Quick Menu.
- On the Task Manager screen, tap and hold the program name on the **Running** tab, then tap **Activate**.

To configure the Exit () button

You can configure the **Exit** button to shut down running programs when the button is tapped, or to just temporarily close the program screen but keep the program running.

1. On the Task Manager screen, tap the **Button** tab.
2. Select the **Enable the “X” button to end running programs** check box.

Note When the **Enable the “X” button to end running programs** check box is not selected, tapping the **Exit** button will only close a program screen. The program is not ended and continues to run in the background.

3. Choose the action for shutting down programs (by tapping the  button, or by tapping and holding the  button).
4. Tap **OK**.

To close running programs from the Task Manager

1. On the Task Manager screen, tap the **Running** tab.
2. Do one of the following:
 - Select the check box of the programs that you want to close, then tap **Stop Selected**.
 - Tap **Stop All** to close all programs in the list.
 - Tap **Menu > Stop All but Selected** to close all programs except those which check boxes are selected.

Tip You can also close running programs from the Quick Menu on the Home screen. See “Quick Menu” in Chapter 1 for details.

To add a running program to the exclusive list

If you add a running program to the **Exclusive Programs List**, it will not be closed when you tap **Stop Selected** or **Stop All** and will not be listed in the Quick Menu on the Home Screen.

1. On the Task Manager screen, tap the **Running** tab.
2. Tap and hold the program name, then tap **Add Exclusive**.

Tip To remove a program from the exclusive list, tap the **Exclusive** tab, select the check box of the program, then tap **Remove**.

To set the sorting preference and program icon size in the Quick Menu

1. On the Task Manager screen, tap the **Others** tab.
2. In **Sort programs in Quick Menu by**, choose whether to sort according to **Program name** or **Memory usage**. The list will be sorted in ascending order.
3. In **Program icon size in Quick Menu**, choose whether to use **Small size** or **Large size**.

13.5 Protecting Your Device

Protect your device with a password

You can help keep your data more secure by requiring a password every time the device is turned on.

To set a device password

1. On the Home screen, slide to the **Settings** tab and then tap **All Settings**.
2. On the **Personal** tab, tap **Lock**.
3. Select the **Prompt if device unused for** check box, then specify the idle time before the device requires a password.
4. In the **Password type** box, select the type of password you would like to use.

Tip If your device is configured to connect to a network, use an alphanumeric password for increased security.

5. Enter the password in both the **Password** and **Confirm** boxes.
6. Tap **OK**. The next time the device is turned on, you will be prompted to enter your password.

Notes

- To ensure that you can always make emergency calls, do not begin your password with the digits of your local emergency number.
- If you entered a hint, the hint will be displayed after the wrong password is entered five times.
- Each time a wrong password is entered, the device response time gets longer until the device appears to be not responding.
- If you forget your password, you can hard reset or clear the device memory. Before you do this, make sure you back up your data and files so that you can restore them back to your device. For more information about hard resetting the device and clearing the memory, see “Resetting Your Device” in this chapter.

13.6 Managing Memory

To see how much memory is available for use

1. On the Home screen, slide to the **Settings** tab and then tap **All Settings**.
2. On the **System** tab, tap **Memory** > **Main** tab. The amount of memory allocated to data storage versus program storage is displayed, as well as the amount of memory in use versus the available memory.

To see the available space of the internal storage

1. On the Home screen, slide to the **Settings** tab and then tap **All Settings**.
2. On the **System** tab, tap **Memory** > **Storage Card** tab.

If your device is running low on memory, try the following to free memory on your device:

- Close programs which are not in use.
- Move files and e-mail attachments to the internal storage.
- Delete unnecessary files. Tap **Start** > **Programs** > **File Explorer**. Tap and hold the file, and tap **Delete**.
- Delete large files. To find large files on your device, tap **Start** > **Programs** > **Search**. In the **Type** list, tap **Larger than 64 KB**, and tap **Search**.
- In Opera Mobile or Internet Explorer Mobile, delete temporary Internet files and clear history information.
- Remove programs you no longer use.
- Reset your device.

13.7 Resetting Your Device

Soft reset

Occasionally, you may need to reset your device. A soft (or normal) reset of your device clears all active program memory and shuts down all active programs. This can be useful when your device is running slower than normal, or a program is not performing properly. A soft reset is also necessary after the installation of some programs. If a soft reset is performed when programs are running, unsaved work will be lost.

To perform a soft reset

1. Pull out the stylus.
2. Remove the back cover.
3. Use the stylus to press the RESET button located at the bottom of the back side of the device. Your device restarts and displays the Home screen.

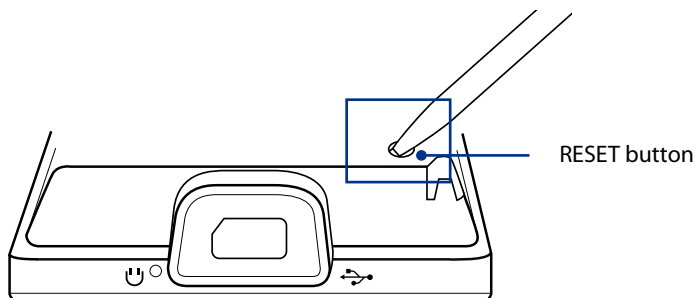

Hard reset

You can also perform a hard reset (also known as a full reset). A hard reset should only be performed if a normal reset does not solve a system problem. After a hard reset, the device is restored to its default settings—the way it was when you first purchased it and turned it on. Any programs you installed, data you entered, and settings you customized on your device will be lost. Only Windows Mobile® software and other pre-installed programs will remain.

Warning! Your device will be set back to factory default settings. Make sure that any additional installed programs and/or user data have been backed up before you perform a hard reset.

To perform a hard reset

1. Pull out the stylus.
2. Remove the back cover.
3. With the device turned on, press and hold the VOLUME DOWN and ENTER buttons, then press the RESET button with the stylus tip.
4. Release the RESET button, but continue pressing the VOLUME DOWN and ENTER buttons until you see this message on the screen:

```
This operation will delete
all your personal data,
and reset all settings
to manufacturer default.
Press VolUp to restore
manufacturer default, or
press other keys to cancel.
```

5. Release the VOLUME DOWN and ENTER buttons, then press the VOLUME UP button to perform the hard reset, or press any other button to cancel the reset.

Clear Storage

You can also use Clear Storage to reset your device back to factory default settings and/or format the internal storage.

1. On the Home screen, slide to the **Settings** tab and then tap **All Settings**.
2. On the **System** tab, tap **Clear Storage**.
3. In the drop-down menu, select whether to **Clear Storage only**, **Format internal storage only**, or **Clear storage and format internal storage**.
4. Enter "1234" and then tap **Yes**.

13.8 Windows Update

You can update Windows Mobile® on your device with the latest updates, security patches or fixes, if these are available.

To set up Windows Update

The first time you run Windows Update, you need to set up how you want Windows Update to check for patches on the Microsoft Web site.

1. On the Home screen, slide to the **Settings** tab and then tap **All Settings**.
2. On the **System** tab, tap **Windows Update**.
3. On the Update Setup screen, tap **Next**.
4. Choose how you want to check for updates, **Manual** or **Automatic**, then tap **Next**.

Note If you select **Automatic**, you will be asked if you want to use your current data plan to check for updates. Select or clear the **Use my data plan to check for and download updates** check box and tap **Next**.

5. Tap **Finish**.

To check for updates

1. On the Home screen, slide to the **Settings** tab and then tap **All Settings**.
2. On the **System** tab, tap **Windows Update**.
3. Tap **Check Now**.

Note Windows Mobile® updates may not be available at all times. Check the Windows Mobile® Web site for update information.

To change Windows Update options

1. On the Home screen, slide to the **Settings** tab and then tap **All Settings**.
2. On the **System** tab, tap **Windows Update**.
3. Tap **Menu** and select the option you want to change.

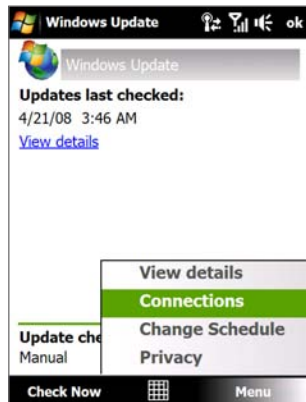

- Tap **Connections** to change how the device connects to the Internet when checking for updates.
- Tap **Change Schedule** to change how Windows Update checks for Windows Mobile® updates.

13.9 Battery Saving Tips

How long your battery power lasts depends on the battery type and how you use your device. Try the following to help conserve battery life:

- When the device is not in use, press POWER to switch off the display.
- On the Home screen, slide to the **Settings** tab and then tap **All Settings**. On the **System** tab, tap **Power > Advanced** tab of the Power settings screen. Here, you can specify the time before your device automatically turns off the display and backlight to conserve battery power. For optimum conservation, specify 3 minutes or less.
- On the Home screen, slide to the **Settings** tab and then tap **All Settings**. On the **System** tab, tap **Power > Backlight** tab to adjust the backlight brightness settings.
- Use the AC adapter to plug your device into an external power outlet whenever possible, especially when using a modem or other peripherals.
- Turn Bluetooth off when you are not using it. Make your device visible to other devices only when you are trying to establish a Bluetooth partnership. For more information about Bluetooth, see Chapter 9.
- Lower the volume.
- Close battery-intensive programs, such as the Camera, when you are done using them. Make sure the programs are ended and are not continuously running in the background. Refer to “Using Task Manager” in this chapter for information on closing programs.

Appendix

A.1 Specifications

A.2 Regulatory Notices

A.3 Additional Safety Information

A.1 Specifications

System Information	
Processor	Qualcomm® MSM7501A™ 528 MHz
Memory	<ul style="list-style-type: none"> – ROM : 256 MB – RAM : 288 MB DDR RAM – Internal storage: 4 GB <p>Note: Figures are the total ROM and RAM memory available for use and storage. Since the memory is shared by the operating system, applications, and data, the actual available memory is less than what is specified.</p>
Operating System	Windows Mobile® 6.1 Professional
Power	
Battery	Rechargeable Lithium-ion battery, 1340 mAh
Battery Life (estimates)	Standby time: Up to 350 hours Talk time: Up to 250 minutes (The above are subject to network and phone usage.)
AC Adapter	Voltage range/frequency: 100 - 240V AC, 50/60 Hz DC output: 5V and 1A
Communications	
Network	CDMA2000 1xEVDO/1xRTT and IS-95A/B voice or data Dual-band (800 and 1900 MHz)
Internal Antenna	Yes
Physical	
Dimensions	102.5 mm (L) X 52 mm (W) X 14.3 mm (T)
Weight	113 g (with battery)
Display	
LCD Type	2.8-inch TFT-LCD flat touch-sensitive screen
Resolution	480 x 640 VGA resolution
Camera Module	
Type	3.2 megapixel color camera with auto focus
Resolution	<ul style="list-style-type: none"> • Photo: 3M (2048 x 1536); 2M (1600 x 1200); 1M (1280 x 960); VGA (640 x 480); QVGA (320 x 240) • Video: CIF (352 x 288); QVGA (320 x 240); QCIF (176 x 144); Sub-QCIF (128 x 96)
Digital Zoom	Up to 4X
Connections	
I/O Port	HTC ExtUSB™ (11-pin mini-USB and audio jack in one; USB 2.0 high speed)
Wireless Connections	<ul style="list-style-type: none"> • Bluetooth® 2.0 with EDR • Wi-Fi® (IEEE 802.11 b/g)
Audio	
Microphone/Speaker	Built-in
Ring tone	<ul style="list-style-type: none"> • Supports MP3, AAC, AAC+, eAAC+, WMA, WAV, AMR-NB, AMR-WB, QCP, MIDI, MPEG-4 formats • 40 polyphonic and standard MIDI format 0 and 1 (SMF) / SP MIDI
Supported Playback Formats	<ul style="list-style-type: none"> • Windows Media® Player: MP3, MPEG-4, AAC, AAC+, eAAC+, WMA, WAV, AMR, AMR-NB, AMR-WB, AWB, SP-MIDI • TouchFLO™ 3D: MP3, MPEG-4, WMA, AAC, AAC+

Controls

- Device Control**
- TouchFLO™ 3D
 - Touch-sensitive navigation control with ENTER button
 - HOME button
 - BACK button
 - Phone buttons: TALK/SEND and END
 - POWER button
 - VOLUME CONTROL buttons
 - RESET button

Others

- Special Features** GPS and A-GPS ready (GPS navigation software not included)

A.2 Regulatory Notices

Regulatory Agency Identifications

For regulatory identification purposes, your product is assigned a model number of **DIAM500**.

To ensure continued reliable and safe operation of your device, use only the accessories listed below with your **DIAM500**.

The Battery Pack has been assigned a model number of **DIAM171**.

Note This product is intended for use with a certified Class 2 Limited Power Source, rated 5 Volts DC, maximum 1 Amp power supply unit.

Federal Communication Commission Interference Statement

This equipment has been tested and found to comply with the limits for a Class B digital device, pursuant to Part 15 of the FCC Rules. These limits are designed to provide reasonable protection against harmful interference in a residential installation. This equipment generates, uses and can radiate radio frequency energy and, if not installed and used in accordance with the instructions, may cause harmful interference to radio communications. However, there is no guarantee that interference will not occur in a particular installation. If this equipment does cause harmful interference to radio or television reception, which can be determined by turning the equipment off and on, the user is encouraged to try to correct the interference by one of the following measures:

- Reorient or relocate the receiving antenna.
- Increase the separation between the equipment and receiver.
- Connect the equipment into an outlet on a circuit different from that to which the receiver is connected.
- Consult the dealer or an experienced radio or television technician for help.

FCC Caution: Any changes or modifications not expressly approved by the party responsible for compliance could void the user's authority to operate this equipment.

This device complies with Part 15 of the FCC Rules. Operation is subject to the following two conditions: (1) This device may not cause harmful interference, and (2) this device must accept any interference received, including interference that may cause undesired operation.

IMPORTANT NOTE

Radiation Exposure Statement:

This equipment complies with FCC radiation exposure limits set forth for an uncontrolled environment. End users must follow the specific operating instructions for satisfying RF exposure compliance. To maintain compliance with FCC RF exposure compliance requirements, please follow operation instruction as documented in this manual.

This transmitter must not be co-located or operating in conjunction with any other antenna or transmitter, except the transmitters built-in with the device.

Industry Canada statement

This device complies with RSS-210 of the Industry Canada Rules. Operation is subject to the following two conditions: (1) This device may not cause harmful interference, and (2) this device must accept any interference received, including interference that may cause undesired operation.

IMPORTANT NOTE

Radiation Exposure Statement:

This equipment complies with IC radiation exposure limits set forth for an uncontrolled environment. End users must follow the specific operating instructions for satisfying RF exposure compliance. To maintain compliance with IC RF exposure compliance requirements, please follow operation instruction as documented in this manual.

FCC Hearing-Aid Compatibility (HAC) Regulations for Wireless Devices

On July 10, 2003, the U.S. Federal Communications Commission (FCC) Report and Order in WT Docket 01-309 modified the exception of wireless phones under the Hearing Aid Compatibility Act of 1988 (HAC Act) to require digital wireless phones be compatible with hearing-aids. The intent of the HAC Act is to ensure reasonable access to telecommunications services for persons with hearing disabilities.

While some wireless phones are used near some hearing devices (hearing aids and cochlear implants), users may detect a buzzing, humming, or whining noise. Some hearing devices are more immune than others to this interference noise, and phones also vary in the amount of interference they generate.

The wireless telephone industry has developed a rating system for wireless phones, to assist hearing device users find phones that may be compatible with their hearing devices. Not all phones have been rated. Phones that are rated have the rating on their box or a label located on the box.

The ratings are not guarantees. Results will vary depending on the user's hearing device and hearing loss. If your hearing device happens to be vulnerable to interference, you may not be able to use a rated phone successfully. Trying out the phone with your hearing device is the best way to evaluate it for your personal needs.

M-Ratings: Phones rated M3 or M4 meet FCC requirements and are likely to generate less interference to hearing devices than phones that are not labeled. M4 is the better/higher of the two ratings. DIAM500 is rated M4.

Please power off the Bluetooth function while using hearing aid devices with your DIAM500.

Hearing devices may also be rated. Your hearing device manufacturer or hearing health professional may help you find this rating. Higher ratings mean that the hearing device is relatively immune to interference noise. The hearing aid and wireless phone rating values are then added together. A sum of 5 is considered acceptable for normal use. A sum of 6 is considered for better use. A sum of 8 is considered for best use.

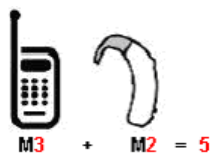

In the above example, if a hearing aid meets the M2 level rating and the wireless phone meets the M3 level rating, the sum of the two values equal M5. This should provide the hearing aid user with "normal usage" while using their hearing aid with the particular wireless phone. "Normal usage" in this context is defined as a signal quality that is acceptable for normal operation.

The M mark is intended to be synonymous with the U mark. The T mark is intended to be synonymous with the UT mark. The M and T marks are recommended by the Alliance for Telecommunications Industries Solutions (ATIS). The U and UT marks are referenced in Section 20.19 of the FCC Rules. The HAC rating and measurement procedure are described in the American National Standards Institute (ANSI) C63.19 standard.

For information about hearing aids and digital wireless phones

FCC Hearing Aid Compatibility and Volume Control:

<http://www.fcc.gov/cgb/dro/hearing.html>

Gallaudet University, RERC:

<http://tap.gallaudet.edu/DigWireless.KS/DigWireless.htm>

SAR Information

0.857 W/KG @1g (HEAD)

0.647 W/KG @1g (BODY)

THIS MODEL DEVICE MEETS THE GOVERNMENT'S REQUIREMENTS FOR EXPOSURE TO RADIO WAVES.

For body worn operation, this phone has been tested and meets the FCC RF exposure guidelines when used with the HTC Corporation. accessories supplied or designated for this product. Use of other accessories may not ensure compliance with the FCC RF exposure guidelines.

Your wireless mobile CDMA phone is a radio transmitter and receiver. It is designed and manufactured not to exceed the emission limits for exposure to radio frequency (RF) energy set by the Federal Communications Commission of the U.S. Government. These limits are part of comprehensive guidelines and establish permitted levels of RF energy for the general population. The guidelines are based on the safety standards previously set by both U.S. and international standards bodies:

- American National Standards Institute (ANSI) IEEE. C95.1-1992.
- National Council on Radiation Protection and Measurement (NCRP). Report 86. 1986.
- International Commission on Non-Ionizing Radiation Protection (ICNIRP) 1996.
- Ministry of Health (Canada), Safety Code 6. The standards include a substantial safety margin designed to assure the safety of all persons, regardless of age and health.

The exposure standard for wireless mobile CDMA phone employs a unit of measurement known as the Specific Absorption Rate, or SAR. The SAR limit set by the FCC is 1.6 W/kg*.

The FCC has granted an Equipment Authorization for this model device with all reported SAR levels evaluated as in compliance with the FCC RF exposure guidelines. SAR information on this model device is on file with the FCC and can be found under the Display Grant section of <https://gulfoss2.fcc.gov/prod/oet/cf/eas/reports/GenericSearch.cfm> after searching on FCC ID: NM8DIAM500. Additional information on Specific Absorption Rates (SAR) can be found on the Cellular Telecommunications & Internet Association (CTIA) Web-site as <http://www.phonefacts.net>.

Additional information on Specific Absorption Rates (SAR) can be found on the Cellular Telecommunications & Internet Association (CTIA) Web-site as <http://www.phonefacts.net>.

* In the U.S. and Canada, the SAR limit for mobile CDMA phone used by the public is 1.6 Watts/kg (W/kg) averaged over one gram of tissue. The standard incorporates a substantial margin of safety to give additional protection for the public and to account for any variations in usage.

Normal condition only to ensure the radiative performance and safety of the interference. As with other mobile radio transmitting equipment, users are advised that for satisfactory operation of the equipment and for the safety of personnel, it is recommended that no part of the human body be allowed to come too close to the antenna during operation of the equipment.

IC Statement

Operation is subject to the following two conditions:

1. This device may not cause interference; and
2. This device must accept any interference, including interference that may cause undesired operation of the device.

Important Note

IC Radiation Statement:

This equipment complies with IC radiation exposure limits set forth for an uncontrolled environment. End users must follow the specific operating instructions for satisfying RF exposure compliance.

This Class B digital apparatus complies with Canadian ICES-003.

Telecommunications & Internet Association (TIA) Safety Information

Pacemakers

The Health Industry Manufacturers Association recommends that a minimum separation of six inches be maintained between a handheld wireless phone and a pacemaker to avoid potential interference with the pacemaker. These recommendations are consistent with the independent research by and recommendations of Wireless Technology Research. Persons with pacemakers:

- Should ALWAYS keep the phone more than six inches from their pacemaker when the phone is turned ON.
- Should not carry the phone in a breast pocket.
- Should use the ear opposite the pacemaker to minimize the potential for interference. If you have any reason to suspect that interference is taking place, turn the phone OFF immediately.

Hearing Aids

Some digital wireless phones may interfere with some hearing aids. In the event of such interference, you may want to consult your service provider, or call the customer service line to discuss alternatives.

Other Medical Devices

If you use any other personal medical device, consult the manufacturer of your device to determine if they are adequately shielded from external RF energy. Your physician may be able to assist you in obtaining this information.

Turn the phone OFF in health care facilities when any regulations posted in these areas instruct you to do so. Hospitals or health care facilities may be using equipment that could be sensitive to external RF energy.

WEEE Notice

The Directive on Waste Electrical and Electronic Equipment (WEEE), which entered into force as European law on 13th February 2003, resulted in a major change in the treatment of electrical equipment at end-of-life.

The purpose of this Directive is, as a first priority, the prevention of WEEE, and in addition, to promote the reuse, recycling and other forms of recovery of such wastes so as to reduce disposal.



The WEEE logo (shown at the left) on the product or on its box indicates that this product must not be disposed of or dumped with your other household waste. You are liable to dispose of all your electronic or electrical waste equipment by relocating over to the specified collection point for recycling of such hazardous waste. Isolated collection and proper recovery of your electronic and electrical waste equipment at the time of disposal will allow us to help conserving natural resources. Moreover, proper recycling of the electronic and electrical waste equipment will ensure safety of human health and environment. For more information about electronic and electrical waste equipment disposal, recovery, and collection points, please contact your local city center, household waste disposal service, shop from where you purchased the equipment, or manufacturer of the equipment.

RoHS Compliance

This product is in compliance with Directive 2002/95/EC of the European Parliament and of the Council of 27 January 2003, on the restriction of the use of certain hazardous substances in electrical and electronic equipment (RoHS) and its amendments.

A.3 Additional Safety Information

This section provides more safety information in addition to the information at the beginning of the user manual.

When Driving

Do Not Use The PC Functions Of Your Pocket PC While Driving Or Walking

Never use the personal computer functions of your device while driving an automobile or any other moving vehicle. Always pull out of traffic and come to a stop in a legally permissible and safe location before using your device. Failure to do so could result in serious bodily injury in a traffic accident.

When driving:

- Always secure your device in its leather pouch.
- Never place your device on the passenger seat or anyplace else in the car where it can become a projectile during a collision or stop.
- An air bag inflates with great force. DO NOT place objects, including either installed or portable wireless equipment, in the area over the air bag or in the air bag deployment area. If in-vehicle wireless equipment is improperly installed and the air bag inflates, serious injury could result.

Never store or transport flammable liquids, gases or explosive materials in the same compartment of your automobile as the device or any of its accessories, as possible sparking in the device could cause ignition or explosion.

Never use your device while walking. Usage while walking could result in bodily injury caused by inattention to automobile traffic or other pedestrian hazards.

Using The Phone Function Of Your Pocket PC While Driving Is Extremely Dangerous

Talking on or using your device while driving is extremely dangerous and is illegal in some states. Remember, safety comes first. Check the laws and regulations on the use of phones in the areas where you drive. Always obey them.

If you must use the phone function while driving, please:

- Give full attention to driving. Driving safely is your first responsibility.
- Use hands-free operation and/or one-touch, speed dialing, and auto answer modes.
- Pull off the road and park before making or answering a call.

WARNING! Failure to follow these instructions could lead to serious personal injury and possible property damage.

When Using Your Device Near Other Electronic Devices

Your wireless handheld portable device is a low power radio transmitter and receiver. When it is ON, it receives and also sends out radio frequency (RF) signals.

Most modern electronic equipment is shielded from RF energy. However, certain electronic equipment may not be shielded against the RF signals from your wireless device; therefore, use of your device must be restricted in certain situations.

In addition, the computer portion of your device produces low levels of RF energy due to the generation of digital timing pulses by its clock oscillator circuits. Your device has been equipped with internal shielding to minimize stray emissions of RF energy. However, use of the computer functions of your device must be restricted in certain situations.

PACEMAKERS

The Health Industry Manufacturers Association recommends that a minimum separation of six (6") inches be maintained between a handheld wireless phone and a pacemaker to avoid potential interference with the pacemaker. These recommendations are consistent with the independent research by and recommendations of Wireless Technology Research.

Never come closer than six (6) inches to a person with a heart pacemaker implant when using your device. Doing so could result in interference with the function of the pacemaker.

Persons with pacemakers:

- Should ALWAYS keep the phone more than six inches from their pacemaker when the phone is turned ON.
- Should not carry the phone in a breast pocket.
- Should use the ear opposite the pacemaker to minimize the potential for interference.
 - Note** This is not necessary if the device is not held to the ear.
- If you have any reason to suspect that interference is taking place, turn the phone OFF immediately.

HEARING AIDS

Some digital wireless phones may interfere with some hearing aids. In the event of such interference, you may want to consult your service provider, or call the customer service line to discuss alternatives.

For more regulatory information about hearing devices, see "FCC Hearing-Aid Compatibility (HAC) Regulations for Wireless Devices".

OTHER MEDICAL DEVICES

If you use any other personal medical device, consult the manufacturer of your device to determine if it is adequately shielded from external RF energy. Your physician may be able to assist you in obtaining this information.

HOSPITALS AND HEALTH CARE FACILITIES

Turn your device OFF in health care facilities when any regulations posted in these areas instruct you to do so. Hospitals or health care facilities may be using equipment that could be sensitive to external RF energy.

ELECTRONIC DEVICES IN VEHICLES

RF signals may affect improperly installed or inadequately shielded electronic systems in motor vehicles. Check with the manufacturer or its representative regarding your vehicle. You should also consult the manufacturer of any equipment that has been added to your vehicle.

POSTED FACILITIES

Turn your device OFF where posted notices so require.

Turn Off Your Device Before Flying

AIRCRAFT

FCC regulations prohibit using the transmitting and phone functions of your device while in the air. In addition, most airline regulations prohibit the on-board use of portable PCs (and all other portable electronic devices that could potentially emit stray RF energy), particularly during take-offs and landings, to prevent any possible interference with the reception of signals by airborne electronic navigational devices.

Turn your device OFF before boarding an aircraft. Always request and obtain prior consent and approval of an authorized airline representative before using your device aboard an aircraft. Always follow the instructions of the airline representative whenever using your device aboard an aircraft, to prevent any possible interference with airborne electronic equipment.

Turn Off Your Device in Dangerous Areas

BLASTING AREAS

To avoid interfering with blasting operations, turn your device OFF when in a “blasting area” or in areas posted “Turn off two-way radio”. Obey all signs and instructions.

POTENTIALLY EXPLOSIVE ATMOSPHERES

Turn your device OFF when in any area with a potentially explosive atmosphere and obey all signs and instructions. Sparks in such areas could cause an explosion or fire resulting in bodily injury or even death.

Areas with a potentially explosive atmosphere are often, but not always, clearly marked. They include fueling areas such as gas stations; below deck on boats; fuel or chemical transfer or storage facilities; vehicles using liquefied petroleum gas (such as propane or butane); areas where the air contains chemicals or articles, such as grain, dust, or metal powders; and any other area where you would normally be advised to turn off your vehicle’s engine.

General Safety

Your pocket PC is a high quality piece of equipment. Before operating, read all instructions and cautionary markings on the product, battery and adapter/charger.

Failure to follow the directions below could result in serious bodily injury and/or property damage due to battery liquid leakage, fire or rupture.

DO NOT use or store this equipment in a place where it will be exposed to high temperatures, such as near an open flame or heat-emitting equipment.

DO NOT drop your device or subject it to severe shock. When not using, lay down the unit to avoid possible damage due to instability.

DO NOT expose this equipment to rain or spilled beverages.

DO NOT use unauthorized accessories.

DO NOT disassemble the device or its accessories. If service or repair is required, return unit to an authorized TELUS cellular service center. If the unit is disassembled, the risk of electric shock or fire may result.

Never allow metallic objects, such as staples and paper clips, to get into the inside of your device.

Never touch the liquid that might leak from a broken liquid crystal display. Contact with this liquid could cause a skin rash. If the crystal display liquid should come into contact with the skin or clothing, wash it immediately with clean water.

In the event that the device emits an unusual odor or sound or generates smoke, immediately disconnect the AC adapter from the power outlet, then detach the battery.

Antenna Safety

Use only the supplied or an approved replacement antenna. Unauthorized antennas, modifications, or attachments could impair call quality, damage your device, or result in violation of FCC regulations. Please contact your local dealer for replacement antenna.

Do not use the device with a damaged antenna. If a damaged antenna comes into contact with the skin, a minor burn may result. Please contact your local dealer for replacement antenna.

Battery Safety

Your device uses a removable and rechargeable lithium ion battery. Please contact customer service for assistance should you need a replacement battery.

DOs

- Only use the battery and charger approved by the manufacturer.
- Only use the battery for its original purpose.
- Try to keep batteries in a temperature between 41°F (5°C) and 95°F (35°C).
- If the battery is stored in temperatures above or below the recommended range, give it time to warm up or cool down before using.

- Completely drain the battery before recharging. It may take one to four days to completely drain.
- Store the discharged battery in a cool, dark, and dry place.
- Purchase a new battery when its operating time gradually decreases after fully charging.
- Properly dispose of the battery according to local regulations.

DON'Ts

- Don't attempt to disassemble the battery – it is a sealed unit with no serviceable parts.
- Don't expose the battery terminals to any other metal object (e.g., by carrying it in your pocket or purse with other metallic objects such as coins, clips and pens). This can short circuit and critically damage the battery.
- Don't leave the battery in hot or cold temps. Otherwise, it could significantly reduce the capacity and lifetime of the battery.
- Don't dispose of the battery into a fire.

Lithium ion batteries are recyclable. When you replace the removable battery, please request the repair center to recycle the battery in accordance with RBRC standards. When disposing of the battery by yourself, please call RBRC at (800) 822-8837 for proper disposal tips.

Never touch any fluid that might leak from the built-in battery. Such liquid when in contact with the eyes or skin, could cause injury to the skin or eyes. Should the liquid come into contact with the eyes, irrigate the eyes thoroughly with clean water and immediately seek medical attention. In the event the liquid comes into contact with the skin or clothing, wash it away immediately with clean water.

Adapter/Charger

Use the Correct External Power Source

A product should be operated only from the type of power source indicated on the electrical ratings label. If you are not sure of the type of power source required, consult your authorized service provider or local power company. For a product that operates from battery power or other sources, refer to the operating instructions that are included with the product.

The AC Adapter/Charger designed by TELUS for this unit requires the use of a standard 120 V AC power source for device operation.

Never attempt to disassemble or repair an AC adapter/charger. Never use an AC adapter/charger if it has a damaged or worn power cord or plug. Always contact a TELUS authorized service center, if repair or replacement is required.

Never alter the AC cord or plug on an AC adapter/charger. If the plug will not fit into the available outlet, have a proper outlet installed by a qualified electrician.

Never allow any liquids or water to spill on an AC adapter/charger when it is connected to an AC power source.

Always use the authorized TELUS AC adapter/charger to avoid any risk of bodily injury or damage to your cellular phone or battery.

Never attempt to connect or disconnect the AC adapter/charger with wet hands. Always unplug the AC adapter/charger from the power source before attempting any cleaning. Always use a soft cloth dampened with water to clean the equipment, after it has been unplugged.

Handling the cord on this product or cords associated with accessories sold with this product, will expose you to lead, a chemical known to the State of California to cause birth defects or other reproductive harm. Wash hands after handling.

Always disconnect the travel charger or desktop charger from the power source when it is not in use.

Index

A

- A2DP 97
- ActiveSync
 - about 122
 - set up 55
 - synchronize with computer 56
 - synchronize with Exchange Server 70
- Add and remove programs 123
- Adobe Reader LE 122, 124
- Airplane Mode 31, 128
- Alarm 138
- Album
 - about 112, 122
 - close Album 115
 - play back video 115
 - select a photo or video to view 112
 - view an image 113
- Attachment
 - add to e-mail 65
 - download 65
 - set IMAP4 to automatically receive attachments 67
 - set Outlook to automatically receive attachments 66
- Audio Booster 118, 122

B

- Back cover
 - remove 18
- Backlight
 - adjust brightness 137
 - set backlight timeout 137
- Basic settings 136
- Battery
 - charge battery 19
 - install 18
 - remove 18
 - save battery power 77, 144
- Beam via Bluetooth 97
- Block Recognizer 50
- Bluetooth
 - about 96
 - Bluetooth Explorer 98, 122
 - Bluetooth file sharing 98
 - Bluetooth shared folder 98
 - hands-free headset 97
 - modes 96
 - partnership (pairing) 96
 - stereo headset 97
 - synchronize 57
 - turn on and off 128
 - visible 96
- Bluetooth Explorer 122

C

- Calculator 122
 - Calendar
 - about 122
 - create appointment 124
 - send appointment 125
 - view appointment 125
 - Call History 30
 - Calling
 - from Contacts 28
 - from Home screen 28
 - from Phone screen 28
 - Camera
 - about 106, 122
 - Advanced Options 110
 - capture modes 106
 - controls 107
 - file formats 107
 - icons 107
 - Menu Panel 108
 - specifications 146
 - zooming 109
 - Clear Storage 142
 - Clock & Alarms 135, 136, 138
 - Comm Manager 128, 136
 - Compact QWERTY 47
 - Company Directory 74
 - Connect device to Internet
 - Dial-up 78
 - start a connection 78
 - ways of connecting 76
 - Contacts 122, 126
 - Contacts Picture capture mode 106
 - Copy
 - copy and manage files 134
 - media files from PC to device 116
- ## D
- Device name 137
 - Dial-up 78
 - Dimensions and weight 146
 - Direct Push 71, 128
 - Disconnect data connection 128
 - Download
 - download complete e-mail 65
 - e-mail download settings 63, 66
 - file attachments 65
 - satellite data 103
 - synchronize e-mails 66
 - Web feeds 91
 - Draw 129

E

- E-mail
 - Internet e-mail account (POP3/IMAP4) 62
 - mail server settings 63
 - Mail tab (Home screen) 37
 - send 64
 - settings (POP3/IMAP4) 63
 - setup wizard 62
 - synchronize 54, 66, 70
 - types of e-mail accounts 62
- Emergency call 28
- Emoticon
 - Windows Live Messenger 85
- Equalizer 118
- Excel Mobile 122, 128
- Exchange Server 70

F

- Favorite contacts 36
- File Explorer 122, 134
- Find contact
 - Company Directory 74
 - on device 127
- Finger gestures 43
- Finger panning 43
- Finger scrolling 43
- Forward e-mail 66
- Full QWERTY 46

G

- Games 122
- Getting Started 122
- GPS 102, 103, 123

H

- Hard reset 142
- Help 122
- Home screen 22, 34
- Home tab (Home screen) 35

I

- IMAP4 62
- Input methods
 - Block Recognizer 50
 - Compact QWERTY 47
 - Full QWERTY 46
 - Letter Recognizer 50
 - Phone Keypad 48
 - Transcriber 50
- Input Panel 46
- Input Selector arrow 46
- International call 29
- Internet 76
- Internet e-mail 62
- Internet Explorer Mobile 122
- Internet tab (Home screen) 41

L

- Letter Recognizer 50
- Library
 - Music tab (Home screen) 40
 - Windows Media Player Mobile 116
- Live Messenger 85

M

- Mail tab (Home screen) 37
- Meeting request 73, 125
- Memory 24, 141, 146
- Messages tab (Home screen) 37
- Messaging
 - about 60, 122
 - e-mail 62, 64
 - text (SMS) 60
- Messenger 85, 122
- Microsoft Office Mobile 122, 128
- MP3 Trimmer 119, 122
- Multitap 48

N

- News channels (Web feeds) 91
- Notes 122, 129
- Now Playing
 - Music tab (Home screen) 40
 - Windows Media Player Mobile 116
- Numeric and Symbol Mode 49

O

- Office Mobile 122, 128
- OneNote Mobile 122, 128
- Open PDF file 124
- Opera Mobile 79, 123

P

- Panorama capture mode 106
- Password 140
- People tab (Home screen) 36
- Phone 28, 122
- Phone Keypad 48
- Phone services 138
- Photo capture mode 106
- Photos and Videos tab (Home screen) 38
- Pictures & Videos 123
- Picture Theme capture mode 106
- Playlists
 - Music tab (Home screen) 40
 - Windows Media Player Mobile 118
- Play media 117
- Play music
 - Music tab (Home screen) 39
 - Windows Media Player Mobile 117
- Podcasts 93
- POP3 62
- PowerPoint Mobile 122, 128
- Programs 122

Programs tab (Home screen) 42

Put call on hold 29

Q

QuickGPS 103, 123

Quick menu 24, 139

R

Record

- voice note 130
- voice recording 131

Regional Settings 136, 137

Regulatory notices 147

Reply

- e-mail 66
- text (SMS) 37, 61

Reset

- clear storage 142
- hard reset 141
- soft reset 141

Review screen (Camera) 110

Ring tone 42, 137

Ring type 137

RSS Hub

- about 91, 123
- headline list 92
- news channels 91
- podcasts 93
- summary view 92

S

Safety information 3

Screen text size 137

Search 123

Send

- e-mail 64
- text message (SMS) 60

Settings (Connections tab)

- Beam 136
- Bluetooth 136
- Connections 78, 136
- Domain Enroll 136
- USB to PC 56, 136
- Wi-Fi 77, 136
- Wireless LAN 77, 136

Settings (Personal tab)

- Buttons 135
- Input 135
- Lock 135, 140
- Menus 135
- Owner Information 135
- Phone 135, 137, 138
- Sounds & Notifications 135, 138
- Today 135

Settings (System tab)

- About 135, 137
- Certificates 135

- Clear Storage 135, 142
- Clock & Alarms 135, 136, 138
- Device Information 135
- Error Reporting 135
- External GPS 135
- Key Lock 135
- Long Press End Key 135
- Managed Programs 135
- Memory 135
- Microphone AGC 135
- Power 136
- Regional Settings 136, 137
- Remove Programs 123, 136
- Screen 136, 137
- Task Manager 136, 139
- TouchFLO 24, 43, 136
- Windows Update 136, 143

Settings tab (Home screen) 42

Sleep mode 20

Smart Dial 31

SMS 37, 60, 64

Soft reset 141

Sounds & Notifications 135, 138

Speakerphone 30

Specifications 146

Speed Dial 30

Start menu 24

Status icons 22

Swap/switch calls 29

Synchronize

- ActiveSync 56
- change information types 56
- music and videos 57
- via Bluetooth 57
- Windows Media Player 116
- Windows Mobile Device Center 54
- with computer 42, 56
- with Exchange Server 42, 70

T

T9 48

Task Manager 136, 139

Tasks 123, 130

Text messages

- create new message 60
- Messages tab (Home screen) 37
- send 61

Text size (screen) 137

Transcriber 50

Troubleshoot

- sync connection 56
- Windows Media Player Mobile 118

Turn device on and off 20

Turn phone function on and off 128

Turn the phone function on and off 31

U

USB to PC 56, 136

V

Vibrate 23, 25, 30, 138

Video capture mode 106

Voice call

- about 28
- answer call 29
- end call 30
- make call 28

Voicemail 29

Voice Recorder 123, 131

W

Weather tab (Home screen) 41

Wi-Fi 76, 128

Windows Live 84, 123

Windows Live Messenger 85, 122

Windows Media Player Mobile

- about 123
- file formats 115
- menus 116
- playlists 118
- troubleshoot 118

Windows Mobile Device Center 54

Windows Update 136, 143

Word Mobile 122, 128

Y

YouTube 81, 123

Z

ZIP

- about 123, 132
- create archive 132
- open zip file and extract files 132

Zooming

- Camera 109
- finger gestures 43

Free Manuals Download Website

<http://myh66.com>

<http://usermanuals.us>

<http://www.somanuals.com>

<http://www.4manuals.cc>

<http://www.manual-lib.com>

<http://www.404manual.com>

<http://www.luxmanual.com>

<http://aubethermostatmanual.com>

Golf course search by state

<http://golfingnear.com>

Email search by domain

<http://emailbydomain.com>

Auto manuals search

<http://auto.somanuals.com>

TV manuals search

<http://tv.somanuals.com>